

# TRANSAIR: MODULAR PIPE SYSTEMS

Catalog 3515 | September 2024





OTSEGO, MICHIGAN



TIJUANA, MEXICO



ALBION, INDIANA



LAKEVIEW, MICHIGAN



MESA, ARIZONA

### **⚠ WARNING – USER RESPONSIBILITY**

FAILURE OR IMPROPER SELECTION OR IMPROPER USE OF THE PRODUCTS DESCRIBED HEREIN OR RELATED ITEMS CAN CAUSE DEATH, PERSONAL INJURY AND PROPERTY DAMAGE.

This document and other information from Parker-Hannifin Corporation, its subsidiaries and authorized distributors provide product or system options for further investigation by users having technical expertise.

The user, through its own analysis and testing, is solely responsible for making the final selection of the system and components and assuring that all performance, endurance, maintenance, safety and warning requirements of the application are met. The user must analyze all aspects of the application, follow applicable industry standards, and follow the information concerning the product in the current product catalog and in any other materials provided from Parker or its subsidiaries or authorized distributors.

To the extent that Parker or its subsidiaries or authorized distributors provide component or system options based upon data or specifications provided by the user, the user is responsible for determining that such data and specifications are suitable and sufficient for all applications and reasonably foreseeable uses of the components or systems.

### **Offer of Sale**

The items described in this document are hereby offered for sale by Parker Hannifin Corporation, its subsidiaries or its authorized distributors. This offer and its acceptance are governed by the provisions stated on the separate page of this document entitled "Offer of Sale".

### **Safe Drinking Water Act**

In accordance with 42 USC § 300g-6, parts in this catalog are to be used exclusively for nonpotable services such as manufacturing, industrial processing, irrigation, outdoor watering, or any other uses where the water is not anticipated to be used for human consumption. The only exceptions are parts described explicitly as "low lead" or suitable for potable water.

# TABLE OF CONTENTS

<b>Transair Aluminum Range.....</b>	<b>A1</b>
Technical Specifications .....	A2
Rigid Aluminum Pipe .....	A13
Stickers.....	A15
Flexible Hose .....	A16
Pipe-to-Pipe Connectors and Adapters.....	A18
Drop Brackets.....	A34
Quick Assembly Brackets .....	A37
Pressurized System Outlets .....	A41
Wall Brackets.....	A42
Valves .....	A47
Tools.....	A52
Transair® Pipe Hangers .....	A57
Hose Reels .....	A59
Composite Automatic Safety Couplers.....	A60
Transair 316L Stainless Steel Drops .....	A65
<b>Compressed Air Treatment &amp; Safety .....</b>	<b>B1</b>
Pneumatic Lockout Valves .....	B2
Modular Particulate Filters .....	B4
Modular Coalescing Filters .....	B7
Modular Regulators.....	B10
Modular Filters/Regulators .....	B13
Modular Lubricators .....	B16
Modular Combinations .....	B19
Modular Accessories / Kits .....	B22
<b>Transair Stainless Steel Range .....</b>	<b>C1</b>
Technical Specifications .....	C2
Stainless Steel Pipe.....	C11
Pipe-to-Pipe Connectors for Stainless Steel.....	C12
Drop Brackets for Stainless Steel .....	C18
Wall Brackets for Stainless Steel.....	C19
Valves for Stainless Steel.....	C20
Tools for Stainless Steel .....	C22
Pipe Hangers for Stainless Steel.....	C25
<b>Aluminum Installation Guide .....</b>	<b>D1</b>
<b>Stainless Steel Installation Guide .....</b>	<b>E1</b>
<b>Parker Safety Guide .....</b>	<b>F1</b>
<b>Offer of Sale .....</b>	<b>F4</b>



If you have questions about the products contained in this catalog, or their applications, please contact:

**Parker Fluid System Connectors Division - Transair**

phone: (480) 830 7764

[www.parker.com/transair](http://www.parker.com/transair)

Extra care is taken in the preparation of this literature, but Parker is not responsible for any inadvertent typographical errors or omissions. Information in this catalog is only accurate as of the date of publication. For a more current information base, please consult the division web site at [parker.com/transair](http://parker.com/transair).

# TRANSAIR®

Transair® - the fast, flexible and easy to modify pipe system for compressed air, vacuum, inert gas, process water and chemical transfer applications. Transair® components are reusable and interchangeable, which enables immediate and easy layout modifications. Unlike the performance of black iron or copper, which degrades over time due to corrosion, Transair® provides clean air quality with optimum flow rate performance.



## Reduces Plant Energy Cost

As a direct result of increasing efficiency, reducing pressure drops and eliminating leaks.

## Commitment to Sustainability

Transair® pipe and fittings are 100% recyclable resulting in a decreased carbon footprint.



## Resistance To Corrosion

Transair® aluminum pipe is specifically powder-coated to enhance its mechanical, physical and chemical properties, making it ideal for aggressive industrial applications.

# Parker Transair

with over 20 years of industry experience, Parker Transair offers a complete line of products for your process piping systems.



## Aluminum Range

Ranging from 1/2" to 8", Parker Transair offers a complete line of aluminum pipe and fittings for compressed air, vacuum, and inert gas applications.



## 316L Drops

Available in 3/4", our 316L stainless steel drops can tie into existing Transair aluminum or stainless steel pipe systems. Ideal for washdown areas that use harsh cleaning chemicals.



## Stainless Steel Range

Ranging from 3/4" to 4", Parker Transair offers a complete line of stainless steel pipe and fittings for compressed air, vacuum, inert gas, process water, and chemical transfer applications.



## Filters, Regulators, Lubricators, & Lockout Valves

Transair offers point of use Filters, Regulators, and lubricators in single and combination units. We also offer OSHA approved lock out valves for added safety.

Visit [www.parker.com/transair](http://www.parker.com/transair) or scan the QR Code with your phone's camera to learn more about our products!



# REGULATIONS & CERTIFICATIONS

## Product Quality

### ISO Certification

Parker Hannifin's Fluid System Connectors manufacturing facilities are certified ISO 9001 version 2015 and operate a Quality Management System in order to ensure the level of quality and service that is expected by our customers.

### IATF Certification

Parker Hannifin is IATF 16949 version 2016 certified.

### Qualicoat Certification

All Transair aluminum pipes are coated with a lacquered powder coated finish with a Qualicoat certified coating for additional environmental protection.

## Pressure Vessel Requirements

### ASME B31.1 / B31.3 Conformity

Transair meets the requirements of ASME B31.1 & B31.3 which stipulates "the minimum requirements for the design, materials, fabrication, erection, test and inspection of power and auxiliary piping systems for industrial institutional plants" as non-boiler external piping".

### TSSA & CRN Approval\*

Transair products are approved by the Technical Standards & Safety Authority (TSSA) and registered under the Canadian Registration Number (CRN).

### CE Directive

Transair Products conform to the European Pressure Equipment Directive 2014/68/EU. This directive outlines the safety requirements for storage tanks, compressors, and piping.

### TÜV Certification\*

TÜV Rheinland certifies that Transair products meet the German AD-2000 Merkblatt rules and European Pressure Equipment Directive 2014/68/EU (EPED) requirements for piping.

## Safety Standards

### Euroclasses EN 13501-1 & UL 94 HB Certificate\*

Transair products are non-flammable, with no propagation of flame.

### Euroclasses EN 13501-2 Certificate\*

When installed with a fire protect for ducts, the Transair system is fire resistant and prevents the spread of fire.

### ATEX Directive 2014/34/EU\*

The ATEX directive is mandatory for electrical and non-electrical components used in explosive, gaseous, or dusty environments. Transair products can be used in these environments, according to the ATEX zoning defined by the user.





## Environmental Protection

### ISO 14001

Parker Hannifin is ISO 14001 certified for our Environmental Management System, which requires a plan to reduce the environmental impact on manufacturing and selling products.

### REACH - RoHS\*

All Transair products comply with the REACH and RoHS directives which limit the use of hazardous substances.

### Eco Design

Parker Hannifin follows Eco-design best practices and conducts a life-cycle analysis when developing new products. These steps help to reduce the long-term impact on the environment

### 100% Recyclable

All Transair products are 100% recyclable.

## Media Quality

### ISO 8573 Certification

ISO 8573 is the international standard for compressed air quality. Transair products have been tested to meet the highest air quality standard found within ISO 8573. The air quality is dependent on the treatment performed in the compressor room. Transair will not introduce additional solid particles, water, moisture, or oil into the media being conveyed.

### Oil Free Certificate

Transair products will not contaminate the conveyed media with grease or oil particles.

### Silicone Free Certificate

Transair products are guaranteed to be silicone-free, a mandatory factor for premium air quality.

### Labs Free Compliance

Transair products can meet the demanding cleanliness requirements, determined by the user, for paint and clean room applications.

## Long Term Commitment

### 10 Year Warranty

Parker Hannifin Corporation warrants its Transair products to be free of defects in material and workmanship for 10 years from the date of installation. Transair Condition Monitoring technology is warranted for 1 year.

\*

8" Aluminum pipe and fittings have not been certified with this certification. Please contact customer service if you require this certification for our 8" products.

# OVER 750,000 GLOBAL INSTALLATIONS

Trusted for its performance, Transair® is installed in the compressor room and to the point of use in most industries such as:



## For All Types of Projects

Transair® is the best choice for new systems or expansion

Transair offers an innovative solution for connecting the compressor room, to the main distribution piping, and supplies the points of use.

- "Full Bore" design for high flow, high efficiency.
- Superior air quality (ISO 8573-1 class 1.1.1) from the compressor room to the point of use.
- Secure connection regardless of the installation environment.
- Lightweight and compact products improve working conditions and install faster and easier.
- Easier and faster installation for easier maintenance and reduced downtime.
- Modular and reusable components for savings on capital expenditures.



Transair® is the best choice for system retrofits

Transair is an economical, reliable, and efficient alternative to traditional steel or copper systems. Replacing old systems with Transair will reduce operating costs while improving productivity.

- with a larger inner diameter and full bore design, Transair provides a maximum flow 20% higher than traditional steel, resulting in compressor energy savings.
- Corrosion resistant: reducing the replacement cost and frequency of filter elements.
- Superior air quality, reducing the maintenance costs of point of use machinery.

# APPLICATIONS

## Air Quality

Transair piping conforms to the ISO 8573 Class 1.1.1 standard for air quality. ISO 8573 establishes the different quality levels for compressed air for the 3 components present in any system: dust, water, and oil.

Transair has been tested to achieve the highest expectations of ISO 8573 (Class 1.1.1). Note: This is only achievable with proper air generation and filtration in the compressor room, Transair will not introduce additional particles as the compressed air flows from the compressor room to the point of use.

ISO 8573-1 Class:	Solid Particulates			Mass Concentration (mg / m <sup>3</sup> )	Water		Oil Total Oil* (mg/m <sup>3</sup> )
	Maximum number of particles per m <sup>3</sup>				Vapor Pressure Dewpoint	Liquid (g/ m <sup>3</sup> )	
	0.1 to 0.5 micron	0.5 to 1 micron	1 to 5 micron				
0	As specified by the end user or supplier and more stringent than Class 1.						
1	Yes**	Yes**	Yes**	-	Yes***	-	Yes
2	Yes	Yes	Yes	-	Yes	-	Yes
3	-	Yes	Yes	-	Yes	-	Yes
4	-	-	Yes	-	Yes	-	Yes
5	-	-	Yes	-	Yes	-	-
6	-	-	-	Yes	Yes	-	-
7	-	-	-	Yes	-	Yes	-
8	-	-	-	-	-	Yes	-
9	-	-	-	-	-	Yes	-
X	-	-	-	Yes	-	Yes	Yes

\*Total Oil is comprised of aerosol liquid and vapor \*\* Transair meets the standard after 1 system purge \*\*\* Transair meets the standard depending on atmospheric conditions

## Industrial / Inert Gas Compatibility

Transair piping is suitable for the distribution of non-flammable (inert) gases such as: Argon, Nitrogen, Carbon Dioxide, and welding gas mixes containing these three. Transair piping and connectors have been laboratory tested for purity. Our components are compatible with 99.99% Nitrogen purity applications.

## Vacuum

Transair piping can be used for vacuum applications down to 0.03" Hg (1mbar) absolute pressure.

Gas	Compatible with Transair (Yes / No)
Nitrogen (N <sub>2</sub> )	Yes
Argon (Ar <sub>2</sub> )	Yes
Carbon Dioxide (CO <sub>2</sub> )	Yes
Helium (He <sub>2</sub> )	Yes
Argon (AR <sub>2</sub> ) + Carbon Dioxide (CO <sub>2</sub> ) Mix	Yes – All Ratios
Oxygen (O <sub>2</sub> )	Yes – Up To 22%
Hydrogen (H <sub>2</sub> )	Yes – Up To 4%

# SERVICES AND TOOLS

Parker Transair offers a robust offering of services and tools to support every step of the project from design, estimation, delivery, and installation.

## Building Information Modeling (BIM)

BIM, Building Information Modeling, is a collaborative e-platform for construction projects. This platform allows all parties (contractors, engineers, etc.) review and design the project in real time to prevent system and infrastructure clash.

To be BIM compatible, Parker Transair offers their families and templates in AutoDesk REVIT format. These files are offered in LOD (Level of Detail) 200 and 400.

All NPT as well and BSPP Transair products are available in a dedicated template!



Visit [www.parker.com/transair](http://www.parker.com/transair) or scan the QR Code to download your BIM compatible files.

## Design Support

Transair offers a suite of tools to help in the design of an aluminum system.

We offer two different calculators to help select the right diameter for the project.

- **Flow Calculator:** This calculator will size the aluminum pipe for a compressed air system
- **Vacuum Calculator:** This calculator will size the aluminum pipe for a vacuum system

## Design Software

We offer a downloadable software to help design simple systems. for more complex systems, use either our REVIT or CAD files.

## CAD Files

Transair core products are available in STEP format on [www.parker.com/transair](http://www.parker.com/transair). Please contact us for additional formats.

## Specification Document

We provide a document dedicated to the technical characteristics of our products. This document is vital when evaluating our products or submitting a project bid.



Visit [www.parker.com/transair](http://www.parker.com/transair) or scan the QR Code to view our library of design tools.

## Estimating Support

Transair offers personal support and online tools for accurately estimating the cost of your project.

We offer two different calculators to help determine the pay-back for installing a Transair System

- **Energy Savings Calculator:** This calculator evaluates the energy cost of your current system and the return on investment for switching to Transair.
- **Value Calculator:** This calculator illustrates the typical savings from installing Transair over a copper or steel pipe system.

## Quotation Support

Our team of Transair representatives is available to help you with your next quote. Our team can help suggest products, provide a bill of material, provide system drawings, and answer any technical questions you may have!

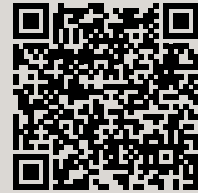

Visit [www.parker.com/transair](http://www.parker.com/transair) or scan the QR Code to find your local representative or contact us.

## Installation Support

### Installation Manual

Our detailed manual can answer most of your questions regarding product installation and best practices for commissioning the system. A copy of the manual can be found later in this catalog.

### How-to Videos

We offer a series of videos covering how to properly install aluminum pipe and Transair Condition Monitoring products.

### Training

Our representatives will travel to the job site to conduct hands-on installation training. Upon successful completion, you will receive a certificate of completion wallet card.

## Customer Service

Our team of customer service representatives are here to help you! Our reps can help you with the following:

- Product Availability
- Delivery time and modifications
- Order Processing
- Technical Information / specification sheets

**Use one of the below methods to contact us:**

**Phone**  
(480) 830-7764

**Email**  
[transaircustomerservice@parker.com](mailto:transaircustomerservice@parker.com)





# TRANSAIR ALUMINUM RANGE

# CONNECTION TECHNOLOGY

Transair's innovative technology enables rapid and easy assembly with quick connection of components to the aluminum pipe. This technology takes into account the specific requirements of each diameter and provides the user with an optimum safety coefficient and easy connection.

1/2" (16.5mm) • 1" (25mm)  
1-1/2" (40mm)

In sizes 1/2" (16,5mm), 1" (25mm), and 1-1/2" (40mm), Transair aluminum pipe uses push to connect technology. Simply push the pipe into the connector until it meets the depth mark on the pipe. The gripping ring will then engage and prevent the pipe from sliding out of the connector.

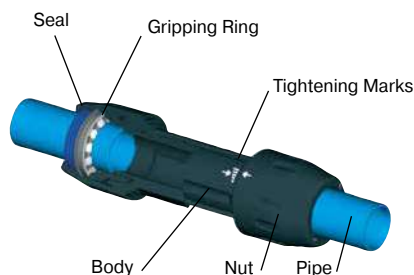

Installation  
Video

2" (50mm) • 2-1/2" (63mm)

In sizes 2" (50mm) and 2-1/2" (63mm), Transair aluminum pipe uses snap ring technology. Place the snap ring in the two holes at the end of the pipe and slide the nut in place. Next, hand tighten the nut into the connector body. Lastly, use a pair of spanner wrenches to fully tighten the connector.

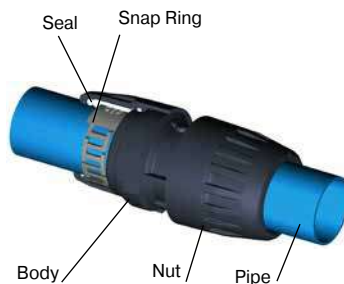

Installation  
Video

3" (76mm) • 4" (101mm) • 6" (168mm)

In sizes 3" (76mm), 4" (101mm), and 6" (168mm), Transair aluminum pipe uses clamshell technology. Place the cartridge on the pipe so it meets the lug. Then position the connector so the cartridge is in the middle. Lastly, close the connector and tighten with the provided bolts.

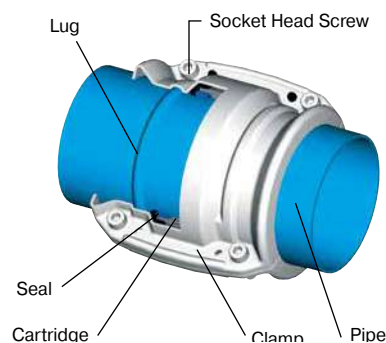

Installation  
Video

8" (203mm)

8" pipe to pipe connectors can be quickly connected to Transair pipe. Position the seal on one half of the pipe, then slide the 2nd pipe into position. Lastly, attach the connector over the seal and tighten.

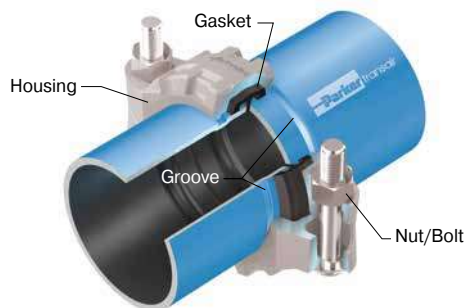

# TECHNICAL

## Suitable fluids

- compressed air (dry, wet, lubricated)
- vacuum
- inert gases
- Please consult us for other fluids

## Resistant to

- corrosion
- mineral compressor oils
- thermal variations
- synthetic compressor oils
- ultraviolet (UV)
- mechanical shocks
- compressor oil carry over

## Vacuum level

- 99.9% (0.03" Hg / 1mbar)

## Working Pressure and Temperature

The maximum working pressure of the Transair® system versus the operating temperature can be seen in the diagram below.

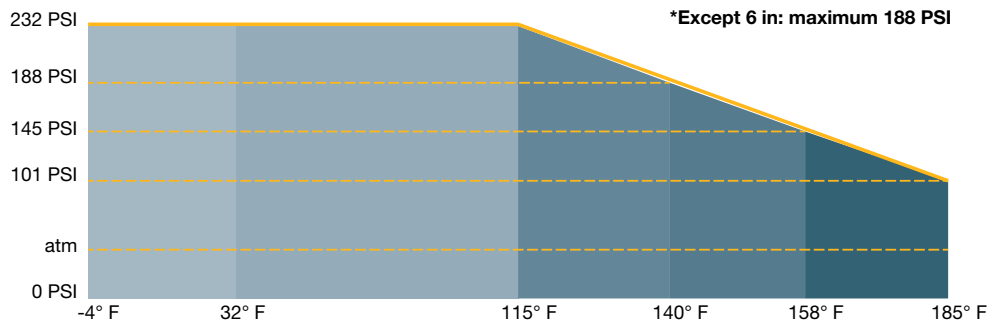

## Maximum Flow

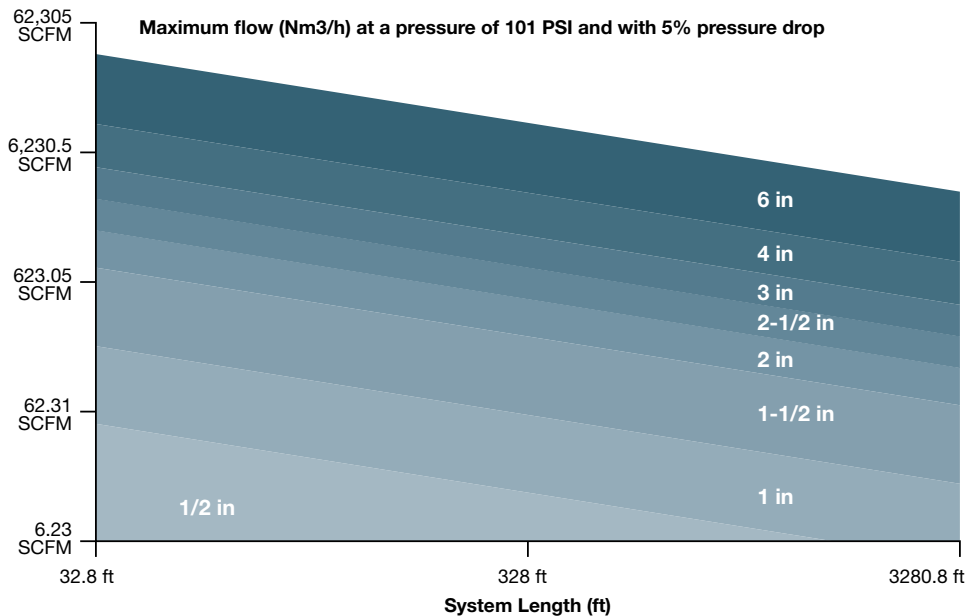

## Sizing Chart

Select the Transair® diameter for your application based on required flow against pressure drop. Estimated values:  
 Closed loop system at 100 PSI with 5% pressure drop.

**Example**

- Main system length (ring main): 1000 ft
- Compressor power: 40 hp
- Required flow rate: 150 SCFM
- Working pressure: 100 PSI

Result: The most suitable Transair® diameter is: 1-1/2".

Flow Rate SCFM	Main Ring Length (ft)						Compressor hp
	500	1000	2000	3000	4000	5000	
10	1/2"	1/2"	1/2"	1"	1"	1"	<15
25	1"	1"	1"	1"	1"	1"	
50	1"	1"	1 1/2"	1 1/2"	1 1/2"	1 1/2"	
75	1"	1 1/2"	1 1/2"	1 1/2"	1 1/2"	1 1/2"	15 to 40
100	1 1/2"	1 1/2"	1 1/2"	1 1/2"	1 1/2"	1 1/2"	
150	1 1/2"	1 1/2"	1 1/2"	2"	2"	2"	
250	1 1/2"	1 1/2"	2"	2"	2 1/2"	2 1/2"	41 to 125
350	2"	2"	2 1/2"	2 1/2"	2 1/2"	2 1/2"	
500	2 1/2"	2 1/2"	2 1/2"	3"	3"	3"	
750	2 1/2"	2 1/2"	3"	3"	4"	4"	126 to 250
1000	3"	3"	3"	4"	4"	4"	
1250	3"	3"	4"	4"	4"	4"	
1500	4"	4"	4"	4"	4"	4"	125 to 500
1750	4"	4"	4"	4"	4"	4"	
2000	4"	4"	4"	4"	4"	6"	
2250	4"	4"	4"	6"	6"	6"	
2500	6"	6"	6"	6"	6"	6"	501 to 1000
2750	6"	6"	6"	6"	6"	6"	
3000	6"	6"	6"	6"	6"	6"	
3250	6"	6"	6"	6"	6"	6"	
3500	6"	6"	6"	6"	6"	6"	
4000	6"	6"	6"	6"	6"	6"	
4500	6"	6"	6"	6"	6"	6"	
5000	6"	6"	6"	6"	6"	6"	1001 to 1400
5500	6"	6"	6"	6"	6"	6"	

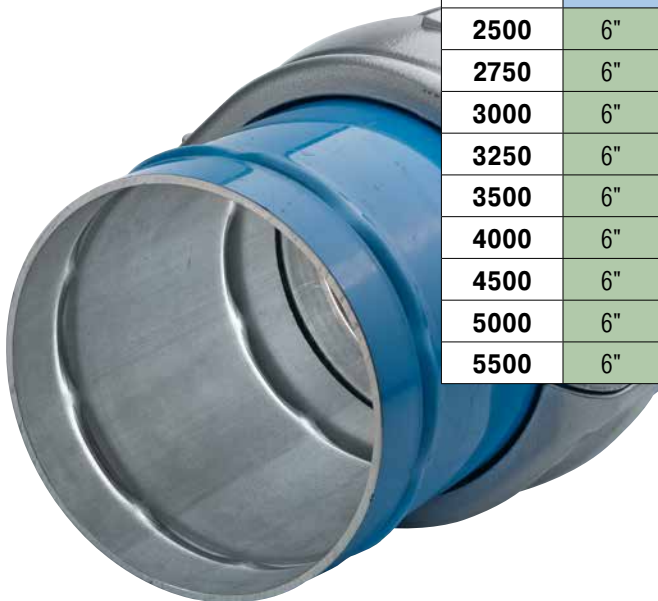

## Transair Materials Chart for Aluminum

Part No.	OD 1/2 to 1-1/2 (16,5mm to 40mm)	OD 2 to 2-1/2 (50mm to 63mm)	OD 3 to 6 (76mm to 168mm)	OD 8 (220mm)	Catalog Section
1012A17	Powder Coated Aluminum	–	–	–	Rigid Aluminum Pipe
1014A17	Powder Coated Aluminum	–	–	–	Rigid Aluminum Pipe
1012A25	Powder Coated Aluminum	–	–	–	Rigid Aluminum Pipe
1016A25	Powder Coated Aluminum	–	–	–	Rigid Aluminum Pipe
1012A40	Powder Coated Aluminum	–	–	–	Rigid Aluminum Pipe
1016A40	Powder Coated Aluminum	–	–	–	Rigid Aluminum Pipe
1013A50	–	Powder Coated Aluminum	–	–	Rigid Aluminum Pipe
1016A50	–	Powder Coated Aluminum	–	–	Rigid Aluminum Pipe
1013A63	–	Powder Coated Aluminum	–	–	Rigid Aluminum Pipe
1016A63	–	Powder Coated Aluminum	–	–	Rigid Aluminum Pipe
TA16	–	–	Powder Coated Aluminum	Powder Coated Aluminum	Rigid Aluminum Pipe
1001E25	Hose & Coating: Black SBR/NBR Reinforcement: Spiral Steel Wire	–	–	–	Flexible Hose
1001E40	Hose & Coating: Black SBR/NBR Reinforcement: Spiral Steel Wire	–	–	–	Flexible Hose
1001E50	–	Hose & Coating: Black SBR/NBR Reinforcement: Spiral Steel Wire	–	–	Flexible Hose
1001E63	–	Hose & Coating: Black SBR/NBR Reinforcement: Spiral Steel Wire	–	–	Flexible Hose
FP01	–	–	Hose & Coating: Black SBR/NBR Reinforcement: Spiral Steel Wire	–	Flexible Hose
FX01	–	–	SS Liner w/ 304/321 SS Braid	–	Flexible Hose

Part No.	OD 1/2 to 1-1/2 (16,5mm to 40mm)	OD 2 to 2-1/2 (50mm to 63mm)	OD 3 to 6 (76mm to 168mm)	OD 8 (220mm)	Catalog Section
6606	Body: Polyamide with Fiberglass Seal: NBR Gripping Ring: Stainless Steel	Body: Treated Aluminum Seal: NBR Snap Ring: Polyamide	–	–	Pipe-to-Pipe Connectors and Adapters
6650	–	Polyamide	–	–	Pipe-to-Pipe Connectors and Adapters
RR01	–	–	Clamp: Treated Steel Cartridge (3" & 4"): Polyamide with Fiberglass Cartridge (6"): Treated Aluminum with Polyamide	Clamp: Cast Aluminum Seal: Nitrile	Pipe-to-Pipe Connectors and Adapters
RP00	–	–	3" & 4": Polyamide with Fiberglass 6": Treated Aluminum with Polyamide	–	Pipe-to-Pipe Connectors and Adapters
EW04	–	–	Treated Steel	–	Pipe-to-Pipe Connectors and Adapters
6602	Body: Polyamide with Fiberglass Seal: NBR Gripping Ring: Stainless Steel	Body: Treated Aluminum Seal: NBR Snap Ring: Polyamide	–	–	Pipe-to-Pipe Connectors and Adapters
RX02	–	–	Stainless Steel 304	–	Pipe-to-Pipe Connectors and Adapters
RA02	–	–	Cast Aluminum	Cast Aluminum	Pipe-to-Pipe Connectors and Adapters
6609	Body: Polyamide with Fiberglass Seal: NBR Gripping Ring: Stainless Steel Thread: Treated Aluminum	Body: Treated Aluminum Seal: NBR Snap Ring: Polyamide Thread: Treated Aluminum	–	–	Pipe-to-Pipe Connectors and Adapters
6612	Body: Polyamide with Fiberglass Seal: NBR Gripping Ring: Stainless Steel	Body: Treated Aluminum Seal: NBR Snap Ring: Polyamide	–	–	Pipe-to-Pipe Connectors and Adapters

Part No.	OD 1/2 to 1-1/2 (16,5mm to 40mm)	OD 2 to 2-1/2 (50mm to 63mm)	OD 3 to 6 (76mm to 168mm)	OD 8 (220mm)	Catalog Section
RX12	–	–	Stainless Steel 304	–	Pipe-to-Pipe Connectors and Adapters
RA12	–	–	Cast Aluminum	Cast Aluminum	Pipe-to-Pipe Connectors and Adapters
6619	Body: Polyamide with Fiberglass Seal: NBR Gripping Ring: Stainless Steel Thread: Treated Brass	Body: Treated Aluminum Seal: NBR Snap Ring: Polyamide Thread: Treated Aluminum	–	–	Pipe-to-Pipe Connectors and Adapters
6604	Body: Polyamide with Fiberglass Seal: NBR Gripping Ring: Stainless Steel	Body: Treated Aluminum Seal: NBR Snap Ring: Polyamide	–	–	Pipe-to-Pipe Connectors and Adapters
RX04	–	–	Stainless Steel 304	–	Pipe-to-Pipe Connectors and Adapters
RX24	–	–	Stainless Steel 304	–	Pipe-to-Pipe Connectors and Adapters
RA04	–	–	Cast Aluminum	Cast Aluminum	Pipe-to-Pipe Connectors and Adapters
RA07	–	–	Cast Aluminum	–	Pipe-to-Pipe Connectors and Adapters
RA26	–	–	Cast Aluminum	–	Pipe-to-Pipe Connectors and Adapters
RX20	–	–	Stainless Steel 304	–	Pipe-to-Pipe Connectors and Adapters
6666	Body: Treated Aluminum Nut: Polyamide with Fiberglass Gripping Ring: Stainless Steel Seal: NBR"	Body: Treated Aluminum Nut: Treated Aluminum Gripping Ring: Stainless Steel Seal: NBR	–	–	Pipe-to-Pipe Connectors and Adapters
RX64	–	–	Stainless Steel 304	–	Pipe-to-Pipe Connectors and Adapters

Part No.	OD 1/2 to 1-1/2 (16,5mm to 40mm)	OD 2 to 2-1/2 (50mm to 63mm)	OD 3 to 6 (76mm to 168mm)	OD 8 (220mm)	Catalog Section
RX66	–	–	Stainless Steel 304	–	Pipe-to-Pipe Connectors and Adapters
RA66	–	–	Cast Aluminum	–	Pipe-to-Pipe Connectors and Adapters
6625	Body: Polyamide with Fiberglass Gripping Ring: Stainless Steel Seal: NBR	Body: Treated Aluminum Seal: NBR Snap Ring: Polyamide	–	–	Pipe-to-Pipe Connectors and Adapters
RX25	–	–	Stainless Steel 304	–	Pipe-to-Pipe Connectors and Adapters
RA25	–	–	Cast Aluminum	Cast Aluminum	Pipe-to-Pipe Connectors and Adapters
6605	Body: Polyamide with Fiberglass Seal: NBR Gripping Ring: Stainless Steel Thread: Treated Aluminum	Body: Treated Aluminum Seal: NBR Snap Ring: Polyamide Thread: Treated Aluminum	–	–	Pipe-to-Pipe Connectors and Adapters
6615	Body: Polyamide with Fiberglass Seal: NBR Gripping Ring: Stainless Steel Thread: Treated Aluminum	Body: Treated Aluminum Seal: NBR Snap Ring: Polyamide Thread: Treated Aluminum	–	–	Pipe-to-Pipe Connectors and Adapters
6611	Treated Aluminum	Treated Aluminum	–	–	Pipe-to-Pipe Connectors and Adapters
6621	Treated Brass	–	–	–	Pipe-to-Pipe Connectors and Adapters
RR21	–	–	Stainless Steel 304	–	Pipe-to-Pipe Connectors and Adapters
6651	Body: Treated Aluminum Nut: Polyamide with Fiberglass	–	–	–	Pipe-to-Pipe Connectors and Adapters
6653	Body: Treated Aluminum Nut: Polyamide with Fiberglass	–	–	–	Pipe-to-Pipe Connectors and Adapters

Part No.	OD 1/2 to 1-1/2 (16,5mm to 40mm)	OD 2 to 2-1/2 (50mm to 63mm)	OD 3 to 6 (76mm to 168mm)	OD 8 (220mm)	Catalog Section
RA31	–	Cast Aluminum	Cast Aluminum	Cast Aluminum	Pipe-to-Pipe Connectors and Adapters
RA30	–	Cast Aluminum	Cast Aluminum	–	Pipe-to-Pipe Connectors and Adapters
RA33	–	–	Cast Aluminum	–	Pipe-to-Pipe Connectors and Adapters
EW05	–	NBR	NBR	–	Pipe-to-Pipe Connectors and Adapters
EW06	–	Treated Steel	Treated Steel	–	Pipe-to-Pipe Connectors and Adapters
RA69	Body: Polyamide with Fiberglass Seal: NBR Gripping Ring: Stainless Steel	Body: Polyamide with Fiberglass Seal: NBR Gripping Ring: Stainless Steel	–	–	Drop Brackets
RA68	Body: Polyamide with Fiberglass Seal: NBR Gripping Ring: Stainless Steel Thread: Treated Brass	Body: Polyamide with Fiberglass Seal: NBR Gripping Ring: Stainless Steel Thread: Treated Brass	–	–	Drop Brackets
RR63	–	–	Body: Zinc Plated Ductile Iron Seal: NBR	Body: Galvanized Steel Seal: Nitrile	Drop Brackets
6662	Body: Polyamide with Fiberglass Seal: NBR Gripping Ring: Stainless Steel	Body: Polyamide with Fiberglass Seal: NBR Gripping Ring: Stainless Steel	–	–	Drop Brackets
6663	Body: Polyamide with Fiberglass Seal: NBR Gripping Ring: Stainless Steel Thread: Treated Brass	Body: Polyamide with Fiberglass Seal: NBR Gripping Ring: Stainless Steel Thread: Treated Brass	–	–	Drop Brackets

Part No.	OD 1/2 to 1-1/2 (16,5mm to 40mm)	OD 2 to 2-1/2 (50mm to 63mm)	OD 3 to 6 (76mm to 168mm)	OD 8 (220mm)	Catalog Section
6668	Body: Polyamide with Fiberglass Seal: NBR Gripping Ring: Stainless Steel Thread: Treated Brass Valve: Plated Brass	Body: Polyamide with Fiberglass Seal: NBR Gripping Ring: Stainless Steel Thread: Treated Brass Valve: Plated Brass	–	–	Drop Brackets
EA98	Body: Polyamide with Fiberglass Thread: Treated Brass Valve: Plated Brass	Body: Polyamide with Fiberglass Thread: Treated Brass Valve: Plated Brass	–	–	Pressurized System Outlet
6640	Body: Treated Brass Nut: Polyamide with Fiberglass Seal: NBR Gripping Ring: Stainless Steel	–	–	–	Wall Brackets
6642	Treated Brass	–	–	–	Wall Brackets
6689	Treated Brass	–	–	–	Wall Brackets
6691	Treated Brass	–	–	–	Wall Brackets
6684	Body: Treated Brass Nut: Polyamide with Fiberglass Seal: NBR Gripping Ring: Stainless Steel	–	–	–	Wall Brackets
6688	Treated Brass	–	–	–	Wall Brackets
6696	Body: Treated Brass Nut: Polyamide with Fiberglass Seal: NBR Gripping Ring: Stainless Steel	–	–	–	Wall Brackets
6636	Treated Brass	–	–	–	Wall Brackets
6679	Body: Treated Brass Nut: Polyamide with Fiberglass Seal: NBR Gripping Ring: Stainless Steel	–	–	–	Wall Brackets
6694	Body: Treated Brass Nut: Polyamide with Fiberglass Seal: NBR Gripping Ring: Stainless Steel	–	–	–	Wall Brackets

Part No.	OD 1/2 to 1-1/2 (16,5mm to 40mm)	OD 2 to 2-1/2 (50mm to 63mm)	OD 3 to 6 (76mm to 168mm)	OD 8 (220mm)	Catalog Section
6638	Body: Treated Brass Nut: Polyamide with Fiberglass Seal: NBR Gripping Ring: Stainless Steel	-	-	-	Wall Brackets
4092	Body: Treated Brass Nut: Polyamide with Fiberglass Seal: NBR Gripping Ring: Stainless Steel Ball: Nickel Plated Brass	Body: Treated Aluminum Nut: Treated Aluminum Seal: NBR Snap Ring: Polyamide Ball: Nickel Plated Brass	-	-	Valves
VR01	-	-	Body: Iron Disc & Shaft: Stainless Steel	-	Valves
VR02	-	Body: Ductile Iron Seal: Nitrile Retaining Ring: Stainless Steel Stem: Stainless Spring: Steel	Body: Ductile Iron Seal: Nitrile Retaining Ring: Stainless Steel Stem: Stainless Spring: Steel	Ductile Iron	Valves
EW08	-	Steel	Steel	-	Valves
EW10	-	-	Low Carbon Steel with Clear Zinc Finish (CR3)	-	Valves
4230	Body: Treated Brass Nut: Polyamide with Fiberglass Seal: NBR Gripping Ring: Stainless Steel	-	-	-	Valves
4299	Plastic	-	-	-	Valves
6697	Polyamide with Fiberglass	Polyamide with Fiberglass	-	-	Pipe Hangers
ER01	-	-	Zinc Steel with Rubber	-	Pipe Hangers
EX01				Steel	
0169	Steel	Steel	-	-	Pipe Hangers
CP05	Body: Polymer HR/Zamac Sleeve: Polymer HR Spring & Bearing: Stainless Steel Seal: Nitrile Probe: Treated Steel	-	-	-	Coupler

Part No.	OD 1/2 to 1-1/2 (16,5mm to 40mm)	OD 2 to 2-1/2 (50mm to 63mm)	OD 3 to 6 (76mm to 168mm)	OD 8 (220mm)	Catalog Section
CP15	Body: Polymer HR/Zamac Sleeve: Polymer HR Spring & Bearing: Stainless Steel Seal: Nitrile Probe: Treated Steel	–	–	–	Coupler
CP21	Body: Polymer HR/Zamac Sleeve: Polymer HR Spring & Bearing: Stainless Steel Seal: Nitrile Probe: Treated Steel	–	–	–	Coupler
9084	Brass	–	–	–	Coupler
9083	Brass	–	–	–	Coupler
9085	Brass	–	–	–	Coupler

# RIGID ALUMINUM PIPE

## Product Features:

- Clean air
- Optimum flow rate performance
- Lightweight
- QUALICOAT certified surface finish
- Three colors: blue (RAL 5012/BS1710), gray (RAL 7001), and green (RAL 6029) (other colors: please consult us)
- Suitable fluids: compressed air, vacuum, nitrogen, argon (other fluids: please consult us)
- Extruded pipe (conforms to EN 755.2, EN 755.8 and EN 573.3 standards)

## Specifications:

**Max. Working Pressure\*:** 188\*\* PSI from -4° to +140°F  
(12.9 bar from -20° to +60° C)

232 PSI from -4° to +113°F  
(15.9 bar from -20° to +46.1° C)

**Vacuum:** 99.9% (0.03" Hg / 1mbar)

**Working Temperature:** -4° to +140° F (-20° to +60° C)

\* Please consult page A5 for higher temperature requirements

\*\* 188 psi is the max for 6 inch (168mm) and 8 inch (220mm) diameter pipe.  
232 psi is the max for 1/2 inch - 4 inch.



## Blue Pipe

Part No.	OD (in)	OD (mm)	Nominal Length (ft)	WT (lb)
1012A17 04 00	1/2	16.5	9	1.37
1014A17 04	1/2	16.5	15	2.11
1012A25 04 00	1	25	9	2.04
1016A25 04 00	1	25	20	4.24
1012A40 04 00	1 1/2	40	9	2.98
1016A40 04 00	1 1/2	40	20	6.22
1016A50 04	2	50	20	9.68
1016A63 04	2 1/2	63	20	13.84
TA16 L1 04	3	76	20	16.98
TA16 L3 04	4	101	20	25.69
TA16 L8 04	6	168	20	64.84
TA16 L12 04	8	220	20	93.32

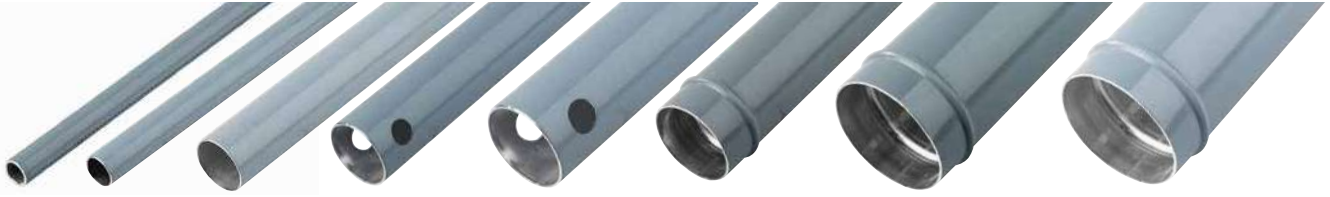

## Gray Pipe

Part No.	OD (in)	OD (mm)	Nominal Length (ft)	WT (lb)
1012A17 06 00	1/2	16.5	9	1.37
1016A25 06 00	1	25	20	4.24
1016A40 06 00	1 1/2	40	20	6.22
1016A50 06	2	50	20	9.68
1016A63 06	2 1/2	63	20	13.84
TA16 L1 06	3	76	20	16.98
TA16 L3 06	4	101	20	25.69
TA16 L8 06	6	168	20	64.84
TA16 L12 06	8	220	20	93.32

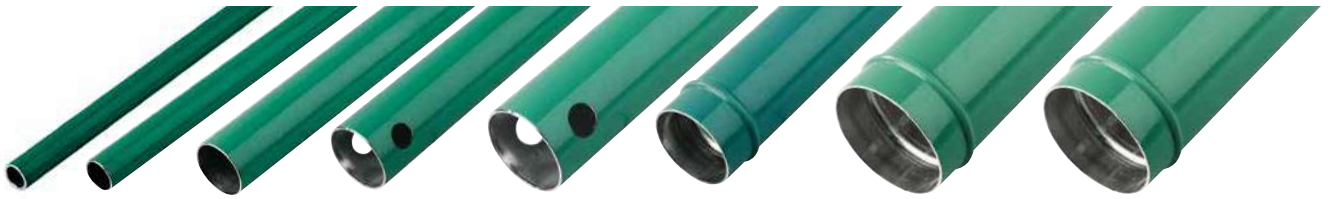

## Green Pipe

Part No.	OD (in)	OD (mm)	Nominal Length (ft)	WT (lb)
1014A17 02	1/2	16.5	15	2.11
1016A25 02 00	1	25	20	4.24
1016A40 02 00	1 1/2	40	20	6.22
1016A50 02	2	50	20	9.68
1016A63 02	2 1/2	63	20	13.84
TA16 L1 02	3	76	20	16.98
TA16 L3 02	4	101	20	25.69
TA16 L8 02	6	168	20	64.84
TA16 L12 02*	8	220	20	93.32

\* Contact Factory

# STICKERS

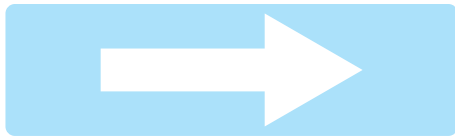

## Flow Directional Arrow Stickers

Part No.	Color	Quantity	For Use with Transair® Pipe Diameter
FL-ARROW-BLK-XL	Black	16	8
FL-ARROW-BLK-L*	Black	16	6
FL-ARROW-BLK-M*	Black	16	3, 4
FL-ARROW-BLK-S*	Black	16	2
FL-ARROW-WHT-XL	White	16	8
FL-ARROW-WHT-L**	White	16	6
FL-ARROW-WHT-M**	White	16	3, 4
FL-ARROW-WHT-S**	White	16	2

Compressed Air

## Compressed Air Stickers

Part No.	Color	Quantity	For Use with Transair® Pipe Diameter
CA-WHT-XL	White	16	8
CA-WHT-L**	White	16	6
CA-WHT-M**	White	16	3, 4
CA-WHT-S**	White	16	2

Vacuum

## Vacuum Stickers

Part No.	Color	Quantity	For Use with Transair® Pipe Diameter
VAC-BLK-XL	Black	16	8
VAC-BLK-L*	Black	16	6
VAC-BLK-M*	Black	16	3, 4
VAC-BLK-S*	Black	16	2

# FLEXIBLE HOSE

## Product Features:

- Compressor outlets (absorption of vibration)
- To bypass obstacles and join different levels
- Expansion loops
- Resistant to mineral and synthetic compressor oils
- Fire resistant (conforms to ISO 8030 standard for compressed air flexible hose)
- Suitable fluids: compressed air

## Specifications:

<b>Max. Working Pressure*:</b>	188 PSI from -4°F to +140°F (12.9 bar from -20° to +60° C)
	232 PSI from -4°F to +113°F (15.9 bar from -20° to +46.1° C)
<b>Working Temperature:</b>	-4° to +140° F (-20° to +60° C)

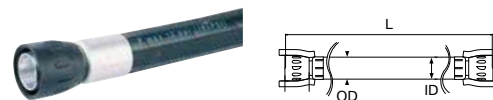

## Flexible Hose for Compressed Air Systems

Part No.	OD (in)	OD (mm)	ID (in)	ID (mm)	L (ft)	Min. bend radius (in)	For use with Transair® pipe diameter
1001E25 00 01	1 1/2	38	1	25	1' 10"	4	1
1001E25 00 03	1 1/2	38	1	25	4' 11"	4	1
1001E40 00 02	2 1/8	54	1 1/2	40	3' 9"	16	1 1/2
1001E40 00 04	2 1/8	54	1 1/2	40	6' 6"	16	1 1/2

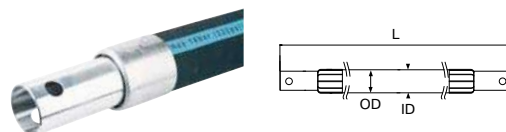

## Flexible Hose for Compressed Air Systems

Part No.	OD (in)	OD (mm)	ID (in)	ID (mm)	L (ft)	Min. bend radius (in)	For use with Transair® pipe diameter
1001E50 00 09	2 5/8	66	2	50	4' 3"	11	2
1001E63 00 08	3 1/8	79	2 1/2	63	4' 7"	12	2 1/2

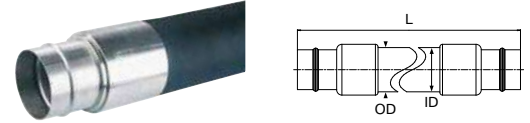

## Flexible Hose for Compressed Air Systems

Part No.	OD (in)	OD (mm)	ID (in)	ID (mm)	L (ft)	Min. bend radius (in)	For use with Transair® pipe diameter
FP01 L1 01	3 4/7	91	3	76	4' 11"	14	3
FP01 L3 02	4 1/2	116	4	101	6' 6"	18	4

Use two connectors RR01 to connect flexible hoses FP01 & FX01 to Transair® pipe.



## Anti Whip-Lash Strap

Part No.	Used For Transair Hose (in)
6698 99 03	1" to 4" Ø

Prevents whip-lash should Transair® flexible hose be disconnected while under pressure.

# PIPE-TO-PIPE CONNECTORS AND ADAPTERS

## Product Features:

- The range of Transair® pipe-to-pipe and stud connectors provides versatility of design and helps to overcome constraints often encountered with the structure of industrial buildings.
- Quick connection
- Full bore design, consistent inner diameter for both pipe and connectors.
- Reconfigurable and reusable
- Non-flammable materials (UL94-HB standard)



## Union Connector – Standard

Part No.	OD (in)	OD (mm)	L (in)	Z (in)
6606 17 00	1/2	16.5	4.80	1.38
6606 25 00US	1	25	6.08	1.89
6606 40 00US	1 1/2	40	8.07	2.26
6606 50 00	2	50	6.73	.98
6606 63 00	2 1/2	63	6.89	1.00



## Union Clamp (Includes Cartridge)

Part No.	OD (in)	OD (mm)	L (in)	Z (in)
RR01 L1 00	3	76	5.75	<0.016
RR01 L3 00	4	101	5.75	<0.016
RR01 L8 00	6	168	5.47	<0.016
RR01 V1200-SF	8	220	2.5	
RR01 V1203-SF*	8	220	2.5	

\*For Vacuum Applications



### WARNING

This product can expose you to chemicals including Lead and Lead Compounds which is known to the State of California to cause cancer and birth defects or other reproductive harm. For more information go to [www.P65Warnings.ca.gov](http://www.P65Warnings.ca.gov)



6609 50 44/50

## Male Threaded NPT 90° Elbow

Part No.	OD (in)	OD (mm)	Thd size (in)	Hex (mm)	L (in)	Z1 (in)	Z2 (in)	Z2 (mm)
6609 17 14	1/2	16.5	1/4	17	2.32	1.30	1.61	33
6609 17 22	1/2	16.5	1/2	23	2.32	1.30	2.48	63
6609 25 22	1	25	1/2	27	2.74	1.59	2.09	53
6609 25 28	1	25	3/4	27	2.74	1.59	2.09	53
6609 25 35	1	25	1	36	2.74	1.59	2.17	55
6609 40 35	1 1/2	40	1	41	4.06	2.26	2.80	71
6609 40 43	1 1/2	40	1 1/4	50	4.06	2.28	2.99	76
6609 40 50	1 1/2	40	1 1/2	50	4.06	2.28	2.99	76
6609 40 44	1 1/2	40	2	60	4.06	2.28	3.27	83
6609 50 50	2	50	1 1/2	65	4.57	2.20	3.82	97
6609 50 44	2	50	2	65	4.57	2.20	3.90	99

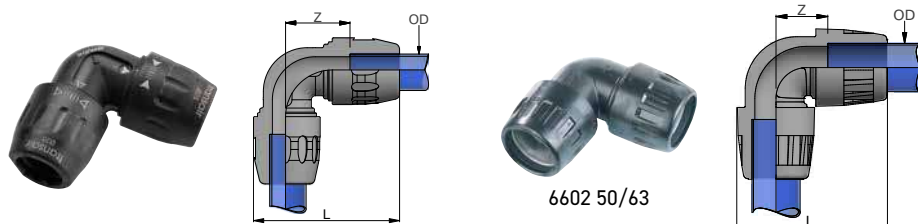

6602 50/63

## 90° Elbow

Part No.	OD (in)	OD (mm)	L (in)	Z (in)
6602 17 00	1/2	16.5	2.32	1.30
6602 25 00US	1	25	2.72	1.59
6602 40 00US	1 1/2	40	4.06	2.28
6602 50 00	2	50	6.14	2.20
6602 63 00	2 1/2	63	6.69	4.25



### WARNING

This product can expose you to chemicals including Lead and Lead Compounds which is known to the State of California to cause cancer and birth defects or other reproductive harm. For more information go to [www.P65Warnings.ca.gov](http://www.P65Warnings.ca.gov)

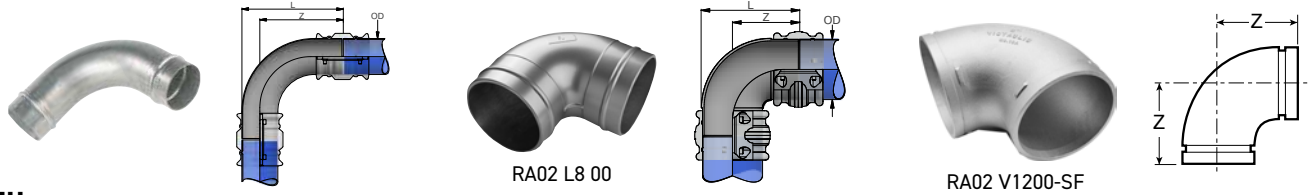

### 90° Elbow

Part No.	OD (in)	OD (mm)	L (in)	Z (in)
RX02 L1 00	3	76	8.94	7.44
RX02 L3 00	4	101	10.94	8.94
RA02 L8 00	6	168	10.59	7.28
RA02 V1200-SF	8	220		7.75

Use two connectors (RR01) to connect 90° elbow (RX02) to Transair® pipe. Use two connectors (RR01) to connect 90° elbow (RA02) to Transair® pipe.

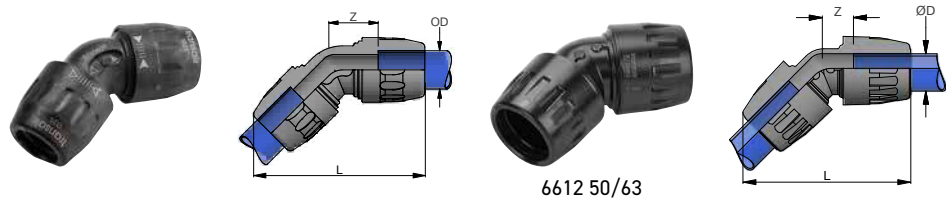

### 45° Elbow

Part No.	OD (in)	OD (mm)	L (in)	Z (in)
6612 25 00	1	25	4.12	1.16
6612 40 00	1 1/2	40	6.99	1.77
6612 50 00	2	50	7.44	1.50
6612 63 00	2 1/2	63	7.76	1.50



### 45° Elbow

Part No.	OD (in)	OD (mm)	L (in)	Z (in)
RX12 L1 00	3	76	9.27	4.81
RX12 L3 00	4	101	10.69	5.43
RA12 L8 00	6	168	11.57	5.39
RA12 V1200-SF	8	220		4.25

Use two connectors (RR01) to connect 45° elbow (RX12) to Transair® pipe. Use two connectors (RR01) to connect 45° elbow (RA12) to Transair® pipe.



**WARNING**

This product can expose you to chemicals including Lead and Lead Compounds which is known to the State of California to cause cancer and birth defects or other reproductive harm. For more information go to [www.P65Warnings.ca.gov](http://www.P65Warnings.ca.gov)



RA07 40 00

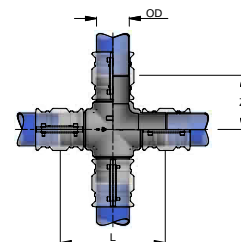

## Equal Cross

Part No.	OD (in)	OD (mm)	L (in)	Z (in)
RA07 40 00	1 1/2	40	9.92	4.96
RA07 50 00	2	50	14.02	7.01
RA07 63 00	2 1/2	63	14.33	7.17
RA07 L1 00	3	76	11.73	5.87
RA07 L3 00	4	101	12.68	6.34

Use four connectors (6606) to connect equal crosses (RA07 40 00, RA07 50 00, and RA07 63 00) to Transair®  $\varnothing$  1 1/2",  $\varnothing$  2", and  $\varnothing$  2 1/2" pipes.

Use four connectors (RR01) to connect equal crosses (RA07 L1 00 and RA07 L3 00) to Transair®  $\varnothing$  3",  $\varnothing$  4", and  $\varnothing$  6" pipes.

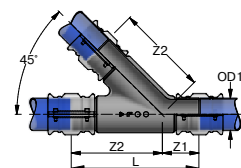

## Equal Y

Part No.	OD1 (in)	OD1 (mm)	L (in)	Z1 (in)	Z2 (in)
RA26 L1 00	3	76	13.50	4.17	9.33
RA26 L3 00	4	101	15.59	4.57	11.02
RA26 L8 00	6	168	18.74	4.96	13.78

Use three connectors (RR01) to connect equal Y (RA26 L1 00, RA26 L3, 00, and RA26 L8 00) to Transair® 3", 4", and 6" pipes.



### WARNING

This product can expose you to chemicals including Lead and Lead Compounds which is known to the State of California to cause cancer and birth defects or other reproductive harm. For more information go to [www.P65Warnings.ca.gov](http://www.P65Warnings.ca.gov)

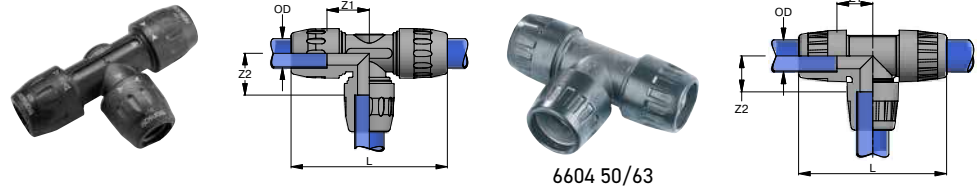

### Equal Tee

Part No.	OD (in)	OD (mm)	L (in)	Z1 (in)	Z2 (in)
6604 17 00	1/2	16.5	4.80	1.40	1.30
6604 25 00US	1	25	5.98	1.89	1.57
6604 40 00US	1 1/2	40	8.07	2.26	2.26
6604 50 00	2	50	9.09	2.20	2.20
6604 63 00	2 1/2	63	9.80	2.46	2.46

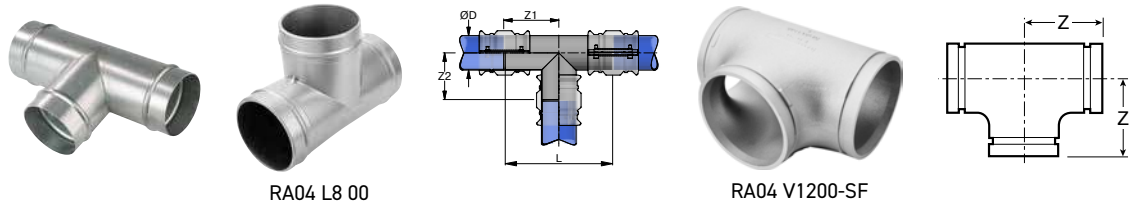

### Equal Tee

Part No.	OD (in)	OD (mm)	L (in)	Z1 (in)	Z2 (in)
RX04 L1 00	3	76	11.50	5.75	5.75
RX04 L3 00	4	101	12.28	6.14	5.35
RA04 L8 00	6	168	14.17	7.09	7.28
RA04 V1200-SF	8	220		7.75	

Use three connectors (RR01) to connect equal tees (RX04 and RA04) to Transair® pipe.



**WARNING**

This product can expose you to chemicals including Lead and Lead Compounds which is known to the State of California to cause cancer and birth defects or other reproductive harm. For more information go to [www.P65Warnings.ca.gov](http://www.P65Warnings.ca.gov)



## Reducing Tee

Part No.	OD1 (in)	OD1 (mm)	OD2 (in)	OD2 (mm)	L (in)	Z1 (in)	Z2 (in)
6604 50 25	2	50	1	25	9.09	2.20	4.37
6604 50 40	2	50	1 1/2	40	9.09	2.20	4.21
6604 63 40	2 1/2	63	1 1/2	40	9.84	2.46	4.76
6604 63 50	2 1/2	63	2	50	9.92	2.36	4.61

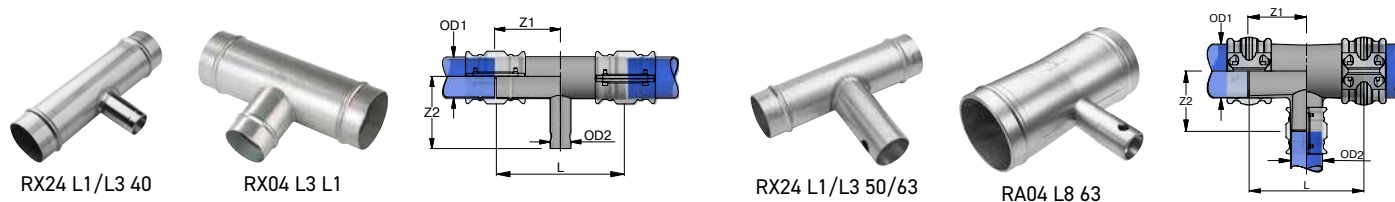

## Reducing Tee

Part No.	OD1 (in)	OD1 (mm)	OD2 (in)	OD2 (mm)	L (in)	Z1 (in)	Z2 (in)
RX24 L1 40	3	76	1 1/2	40	11.50	5.75	4.13
RX24 L1 50	3	76	2	50	11.50	5.75	6.30
RX24 L1 63	3	76	2 1/2	63	11.50	5.75	6.46
RX24 L3 40	4	101	1 1/2	40	12.28	6.14	4.63
RX24 L3 50	4	101	2	50	12.28	6.14	6.81
RX24 L3 63	4	101	2 1/2	63	12.28	6.14	6.97
RX04 L3 L1	4	101	3	76	12.28	6.14	5.35
RA04 L8 63	6	168	2 1/2	63	14.17	7.09	8.66
RA04 L8 L1	6	168	3	76	14.17	7.09	7.28
RA04 L8 L3	6	168	4	101	14.17	7.09	7.28

Use two connectors (RR01) to connect reducing tees (RX24) to Transair®  $\varnothing$  3" and  $\varnothing$  4" pipes and use one connector (6606) to connect Transair®  $\varnothing$  1 1/2" and  $\varnothing$  2 1/2" pipes.

Use two connectors (RR01) to connect reducing tees (RA24) to Transair®  $\varnothing$  6" pipes and use one connector (6606) to connect Transair®  $\varnothing$  2 1/2" pipes.



### WARNING

This product can expose you to chemicals including Lead and Lead Compounds which is known to the State of California to cause cancer and birth defects or other reproductive harm. For more information go to [www.P65Warnings.ca.gov](http://www.P65Warnings.ca.gov)

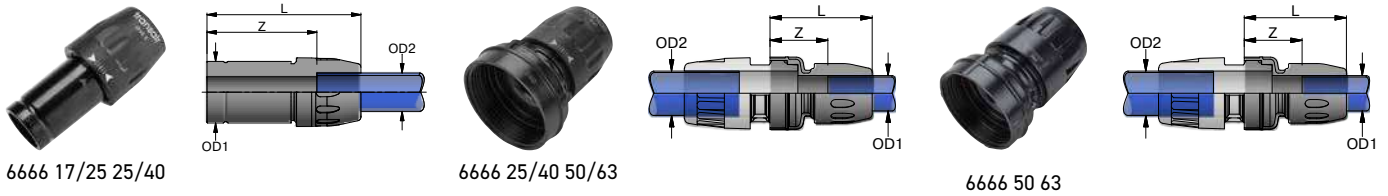

### Plug-In Reducer

Part No.	OD1 (in)	OD1 (mm)	OD2 (in)	OD2 (mm)	L (in)	Z (in)
6666 17 25	1	25	1/2	16.5	3.05	2.03
6666 25 40	1 1/2	40	1	25	3.96	2.81
6666 25 50	2	50	1	25	3.82	2.76
6666 40 63	2 1/2	63	1 1/2	40	4.67	2.89
6666 40 50	2	50	1 1/2	40	4.52	2.56
6666 50 63	2 1/2	63	2	50	4.92	2.56

Use one connector (6606) to connect plug-in reducer (6666) to Transair Ø1" or Ø1-1/2" pipe. Use one connector (6606) to connect plug-in reducer (6666) to Transair Ø2" or Ø2-1/2" pipe.

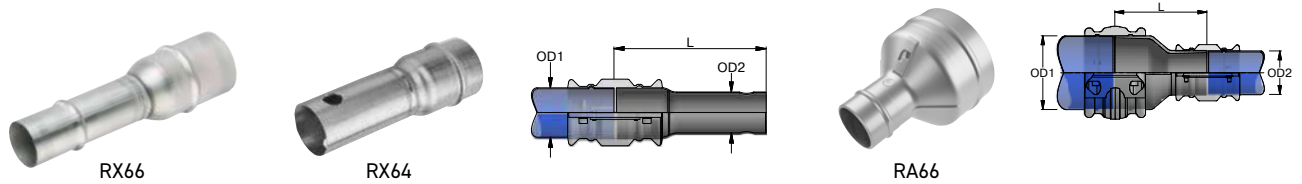

### Plug-In Reducer

Part No.	OD1 (in)	OD1 (mm)	OD2 (in)	OD2 (mm)	L(in)
RX64 L1 50	3	76	2	50	8.67
RX64 L1 63	3	76	2 1/2	63	9.06
RX64 L3 50	4	101	2	50	13.50
RX64 L3 63	4	101	2 1/2	63	9.84
RX66 L3 L1	4	101	3	76	7.58
RA66 L8 L1	6	168	3	76	8.27
RA66 L8 L3	6	168	4	101	8.27

Use one connector (RR01) to connect plug-in reducers (RX64 and RX66) to Transair® Ø 3" or Ø 4" pipes and one connector (6606) to connect to Transair® Ø 2 1/2" pipe.

Use two connectors (RR01) to connect plug-in reducers (RA66) to Transair® pipe.



**WARNING**

This product can expose you to chemicals including Lead and Lead Compounds which is known to the State of California to cause cancer and birth defects or other reproductive harm. For more information go to [www.P65Warnings.ca.gov](http://www.P65Warnings.ca.gov)

## Plug-In Reducer Selection Chart

		Reduction Diameter							
		1/2" (16,5mm)	1" (25mm)	1-1/2" (40mm)	2" (50mm)	2-1/2" (63mm)	3" (76mm)	4" (101mm)	6" (168mm)
Starting Diameter	1/2" (16,5mm)	-	-	-	-	-	-	-	-
	1" (25mm)	6666 17 25	-	-	-	-	-	-	-
	1-1/2" (40mm)	-	6666 25 40	-	-	-	-	-	-
	2" (50mm)	-	6666 50 25	6666 40 50	-	-	-	-	-
	2-1/2" (63mm)	-	-	6666 40 63	6666 50 63	-	-	-	-
	3" (76mm)	-	-	-	RX64 L1 50	RX64 L1 63	-	-	-
	4" (101mm)	-	-	-	RX64 L3 50	RX64 L3 63	RX66 L3 L1	-	-
	6" (168mm)	-	-	-	-	-	RA66 L8 L1	RA66 L8 L3	-



### WARNING

This product can expose you to chemicals including Lead and Lead Compounds which is known to the State of California to cause cancer and birth defects or other reproductive harm. For more information go to [www.P65Warnings.ca.gov](http://www.P65Warnings.ca.gov)

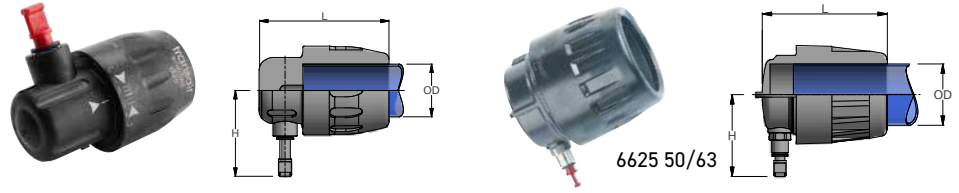

### Vented End Cap

Part No.	OD (in)	OD (mm)	L (in)	H (in)
6625 17 00	1/2	16.5	2.48	1.79
6625 25 00	1	25	2.93	1.85
6625 40 00	1 1/2	40	3.92	2.12
6625 50 00	2	50	4.21	2.64
6625 63 00	2 1/2	63	4.37	2.85

Ø1/2" end caps are supplied with a 6mm push-to-connect plug (p/n: 3126 06 00)  
 Ø 1" and Ø 1-1/2" end caps are supplied with 8mm push-to-connect plug  
 Ø 2" and Ø 2-1/2" end caps are supplied with 8mm push-to-connect plug (p/n: 3126 08 00)

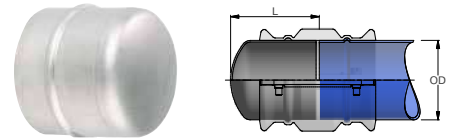

### End Cap

Part No.	OD (in)	OD (mm)	L (in)
RX25 L1 00	3	76	4.17
RX25 L3 00	4	101	4.23

Use one connector (RR01) to connect end caps (RX25) to Transair® pipe.

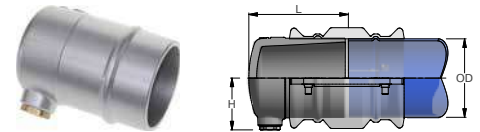

### End Cap with Plug

Part No.	OD (in)	OD (mm)	L (in)	Z (in)
RA25 L1 04	3	76	4.84	1.89
RA25 L3 04	4	101	4.84	2.40
RA25 L8 04	6	168	4.56	3.21

Supplied with a 1/2" BSP threaded plug  
 Use one connector (RR01) to connect end caps (RA25) to Transair pipe.



**WARNING**

This product can expose you to chemicals including Lead and Lead Compounds which is known to the State of California to cause cancer and birth defects or other reproductive harm. For more information go to [www.P65Warnings.ca.gov](http://www.P65Warnings.ca.gov)



## End Cap

Part No.	OD (in)	OD (mm)	T (in)
RA25 V1200-SF	8	220	1.25

Use one connector (RR01) to connect end cap (RA25) to Transair pipe.

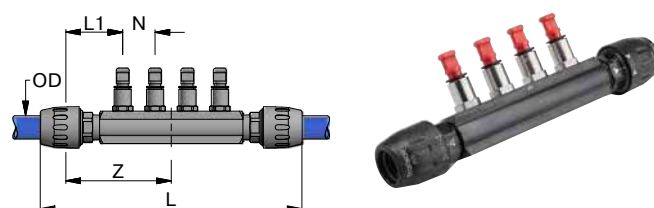

## 4 Port Manifolds

Part No.	OD (in)	OD (mm)	L (in)	Z (in)	L1 (in)	N (in)
6651 25 12 04	1	25	10.83	4.29	1.25	1.38
6651 40 12 04	1 1/2	40	15.87	6.02	1.89	1.97

Supplied with four 12mm plugs (p/n: 3126 12 00)  
 6651 25 12 04 supplied with 3/8" BSPP threaded ports  
 6651 40 12 04 supplied with 1/2" BSPP threaded ports

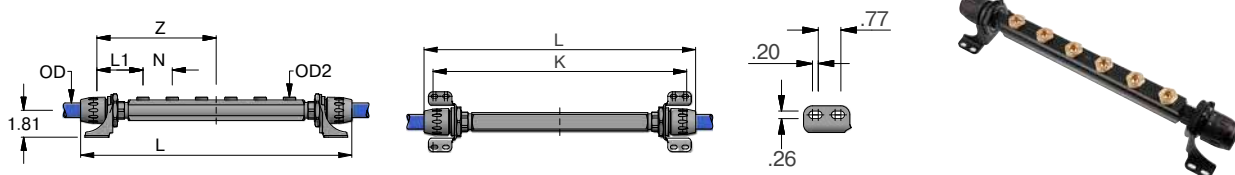

## 6 Port Manifolds

Part No.	OD (in)	OD (mm)	L (in)	Z (in)	L1 (in)	N (in)	K (in)
6653 25 22 06	1	25	18.23	8.03	2.13	1.97	16.81
6653 40 22 06	1 1/2	40	20.71	8.54	2.44	1.97	17.64

Supplied with 1/2" NPT threaded plugs (p/n: EF19 00 00 01)  
 Supplied with 1/2" NPT threaded ports



### WARNING

This product can expose you to chemicals including Lead and Lead Compounds which is known to the State of California to cause cancer and birth defects or other reproductive harm. For more information go to [www.P65Warnings.ca.gov](http://www.P65Warnings.ca.gov)

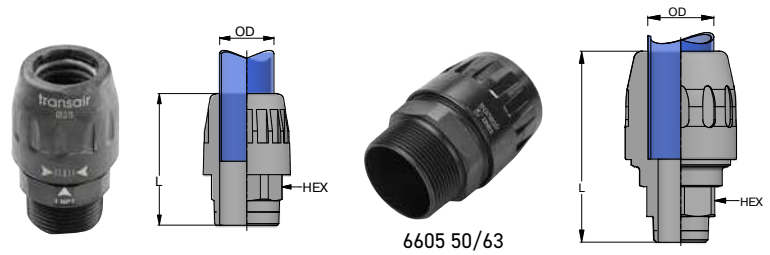

## Male Threaded NPT Connector

Part No.	OD (in)	OD (mm)	Thd Size (in)	Hex (mm)	L (in)
6605 17 14	1/2	16.5	1/4	20	2.52
6605 17 22	1/2	16.5	1/2	24	2.64
6605 25 22	1	25	1/2	30	2.87
6605 25 28	1	25	3/4	30	2.83
6605 25 35	1	25	1	38	2.99
6605 40 35	1 1/2	40	1	41	4.53
6605 40 43	1 1/2	40	1 1/4	41	4.53
6605 40 50	1 1/2	40	1 1/2	50	4.61
6605 40 44	1 1/2	40	2	70	4.72
6605 50 50	2	50	1 1/2	50	4.72
6605 50 44	2	50	2	60	4.76
6605 63 44	2 1/2	63	2	70	4.69
6605 63 41	2 1/2	63	2 1/2	80	5.16
6605 63 46	2 1/2	63	3	80	5.49



## Male Threaded NPT Stud Adapter

Part No.	OD (in)	OD (mm)	Thd Size (in)	Hex (mm)	L (in)	Z (in)
6615 25 22	1	25	1/2	27	3.60	1.81
6615 25 28	1	25	3/4	27	3.54	1.81
6615 25 35	1	25	1	34	3.78	1.81
6615 40 43	1 1/2	40	1 1/4	50	4.76	1.81
6615 40 50	1 1/2	40	1 1/2	50	4.76	1.81
6615 50 50	2	50	1 1/2	50	4.96	3.54
6615 50 44	2	50	2	60	4.98	3.54



### WARNING

This product can expose you to chemicals including Lead and Lead Compounds which is known to the State of California to cause cancer and birth defects or other reproductive harm. For more information go to [www.P65Warnings.ca.gov](http://www.P65Warnings.ca.gov)



## Male Threaded NPT Stud Nut

Part No.	OD (in)	OD (mm)	Thread (NPT)	Hex 1 (mm)	Hex 2 (mm)	L (in)
6611 17 22	1/2	16.5	1/2	32	23	1.65
6611 25 22	1	25	1/2	46	27	1.71
6611 25 28	1	25	3/4	46	27	1.72
6611 25 35	1	25	1	46	36	1.93
6611 40 35	1 1/2	40	1	65	41	2.11
6611 40 43	1 1/2	40	1 1/4	65	50	2.34
6611 40 50	1 1/2	40	1 1/2	65	50	2.36
6611 40 44	1 1/2	40	2	65	60	2.56
6611 50 44	2	50	2	-	60	3.15
6611 50 50	2	50	1 1/2	-	60	3.07
6611 63 44	2 1/2	63	2	-	70	3.11
6611 63 41	2 1/2	63	2 1/2	-	80	3.54

Replace by taking the cap from any Transair pipe-to-pipe connector

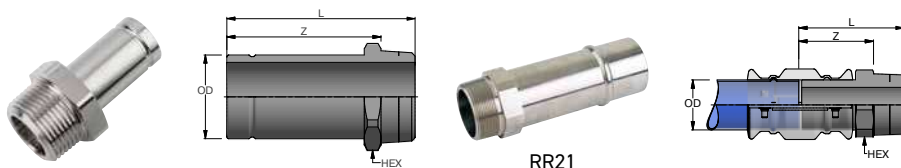

## Male Threaded NPT Adapter

Part No.	OD (in)	OD (mm)	Thread (NPT)	Hex (mm)	L (in)	Z (in)
6621 17 22	1/2	16.5	1/2	24	2.30	1.66
6621 25 22	1	25	1/2	28	2.57	1.93
6621 25 28	1	25	3/4	28	2.57	1.93
6621 25 35	1	25	1	36	2.86	2.05
6621 40 43	1 1/2	40	1 1/4	46	3.74	2.90
6621 40 50	1 1/2	40	1 1/2	50	3.83	2.98
RR21 L1N20	3	76	5.08	2 1/2	5.07	3.74
RR21 L1N24	3	76	5.31	3	5.32	3.93



### WARNING

This product can expose you to chemicals including Lead and Lead Compounds which is known to the State of California to cause cancer and birth defects or other reproductive harm. For more information go to [www.P65Warnings.ca.gov](http://www.P65Warnings.ca.gov)



RA30/31 63

RA31 L1

RA30/31 L3

RA31 L8

### Flange Adapter – DIN

Part No.	OD (in)	OD (mm)	DN	No. of Bolt Holes	L (in)	T (in)	D (in)
RA30 63 00	2-1/2	63	65	8	5.77	.91	5.71
RA30 L1 00	3	76	80	8	4.20	.97	6.30
RA30 L3 00	4	101	100	8	4.20	.97	7.09

### Flange Adapter – ANSI

Part No.	OD (in)	OD (mm)	DN	No. of Bolt Holes	L (in)	T (in)	D (in)
RA31 63 00	2-1/2	63	65	4	5.77	.91	5.47
RA31 L1 00	3	76	80	4	4.20	.97	6.00
RA31 L3 00	4	101	100	8	4.20	.97	7.50
RA31 L8 00	6	168	150	8	5.02	1.00	9.45

Use one connector (6606) to connect flanges (RA30 63 00 and RA31 63 00) to Transair  $\varnothing$  2 1/2" pipe.  
 Use one connector (RR01) to connect flanges (RA30 and RA31) to Transair  $\varnothing$  3",  $\varnothing$  4", and  $\varnothing$  6" pipes.



### Aluminum Male Threaded NPT Flange Adapter

Part No.	OD (in)	OD (mm)	DN	No. of Bolt Holes	L (in)	T (in)	D (in)	Thd Size (NPT)
RA33 L1N24	3	76	80	4	3.60	.97	6.00	3
RA33 L3N24	4	101	100	8	3.60	.97	7.50	3

RA33 are ANSI standard flanges

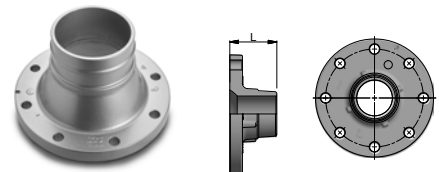

### Flange Reducer

Part No.	OD1 (in)	OD1 (mm)	OD2 (in)	OD2 (mm)	L (in)	Standard
RA31 L8 K2	8	220	6	168	7.85	ANSI

Use one connector (RR01) to connect flange reducer (RA31) to Transair pipe.



**WARNING**

This product can expose you to chemicals including Lead and Lead Compounds which is known to the State of California to cause cancer and birth defects or other reproductive harm. For more information go to [www.P65Warnings.ca.gov](http://www.P65Warnings.ca.gov)

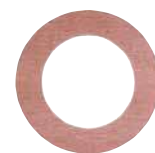

## Flange Gasket

Part No.	OD (in)	OD (mm)	DN	OD (in)	ID (in)	T (in)	Material
EW05 63 00	2-1/2	63	65	4.88	2.87	.12	NBR
EW05 L1 00 10	3	76	80	5.20	3.11	.12	NBR
EW05 L3 00	4	101	100	6.38	4.53	.12	NBR
EW05 L8 00	6	168	150	8.58	6.65	.12	NBR
EW05 K2 00	8	203.2	200	10.75	8.66	.12	NBR

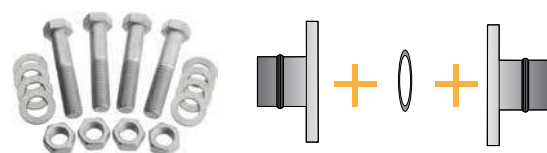

## Flange to Flange Bolt Kit

Part No.	OD (in)	OD (mm)	Thd Size (in)	L (in)	HEX (in)	Number of Bolts in Kit
EW06 00 10	2-1/2, 3, 4	63, 76, 101	5/8-11	3.5	15/16	4
EW06 00 12	6	168	3/4-10	3.75	1 3/4	4

Kits are supplied with 1 nut and 1 washer per bolt.

## Flange Accessories Chart

OD (in)	OD (mm)	Flange Part No.	Gasket Part No.	Bolt Kit Part No. (Flange to Flange)	Number of Bolt Kits	Max. Tightening Torque (ft-lbs)
2 1/2	63	RA30 63 00	EW05 63 00	EW06 00 10	1	59
2 1/2	63	RA31 63 00	EW05 63 00	EW06 00 10	1	59
3	76	RA30 L1 00	EW05 L1 00 10	EW06 00 10	2	59
3	76	RA31 L1 00	EW05 L1 00 10	EW06 00 10	1	59
3	76	RA33 L1N24	EW05 L1 00 10	EW06 00 10	1	59
4	101	RA30 L3 00	EW05 L3 00	EW06 00 10	2	59
4	101	RA31 L3 00	EW05 L3 00	EW06 00 10	2	59
4	101	RA33 L3N24	EW05 L3 00	EW06 00 10	2	59
6	168	RA31 L8 00	EW05 L8 00	EW06 00 12	2	147



### WARNING

This product can expose you to chemicals including Lead and Lead Compounds which is known to the State of California to cause cancer and birth defects or other reproductive harm. For more information go to [www.P65Warnings.ca.gov](http://www.P65Warnings.ca.gov)

## Replacement Parts

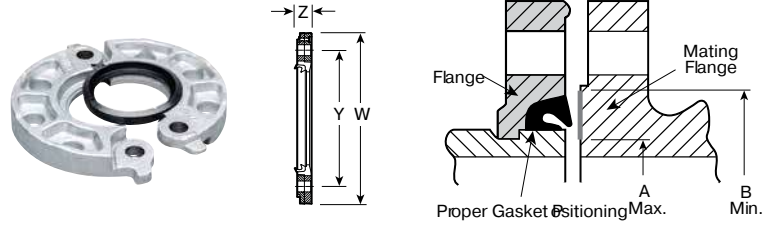

### Flange – ANSI ASME B16.5 Class 150

Part No.	OD (in)	OD (mm)	X (in)	Y (in)	Z (in)
RA31 V1200-SF	8	220	13.5	11.75	1.13



### Union Clamp Cartridge

Part No.	OD (in)	OD (mm)
RP00 L1 00	3	76
RP00 L3 00	4	101
RP00 L8 00	6	168



### Union Clamp Bolts

Part No.	OD (in)	OD (mm)	Thd Size (mm)	L (in)	HEX(mm)
EW04 00 01	3, 4	76, 101	M8 x 1.25	1.5	6
EW04 V1200	8	220	7/8 X 5		



**WARNING**

This product can expose you to chemicals including Lead and Lead Compounds which is known to the State of California to cause cancer and birth defects or other reproductive harm. For more information go to [www.P65Warnings.ca.gov](http://www.P65Warnings.ca.gov)



## Seal (Replacement Part)

Part No.	OD (in)	OD (mm)	Material	Application
RP00 V1202	8	220	FKM	Compressed Air, Industrial/Inert Gas
RP00 V1200	8	220	Nitrile	Compressed Air, Industrial/Inert Gas
RP00 V1203	8	220	Nitrile	Vacuum



## Snap Ring

Part No.	OD (in)	OD (mm)
6650 00 00 16	2	50
6650 00 00 04	2 1/2	63



## Plastic Plug

Part No.	OD (mm)
3126 06 00	6
3126 08 00	8
3126 12 00	12



### WARNING

This product can expose you to chemicals including Lead and Lead Compounds which is known to the State of California to cause cancer and birth defects or other reproductive harm. For more information go to [www.P65Warnings.ca.gov](http://www.P65Warnings.ca.gov)

# DROP BRACKETS

For rigid drops with horizontal take off or for all types of air supply with rigid pipe or flexible hose on an installation which incorporates an efficient air dryer.

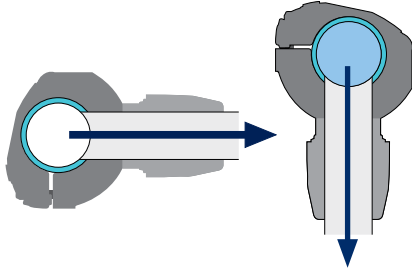

## Product Features:

- Optimum flow
- Compact
- Well adapted for most original equipment manufacturer (OEM) applications and for use with neutral gases
- Quick installation without any cutting of pipe



RA69 50/63

## Simple Reducing Bracket

Part No.	OD1 (in)	OD1 (mm)	OD2 (in)	OD2 (mm)	L (in)	Z (in)
RA69 25 17	1	25	1/2	16.5	1.46	1.38
RA69 40 25	1 1/2	40	1	25	1.46	1.85
RA69 50 25	2	50	1	25	1.46	2.30
RA69 63 25	2 1/2	63	1	25	1.46	2.60

To drill Transair® pipe, use drilling tools 6698 02 01 and 6698 02 02.



### WARNING

This product can expose you to chemicals including Lead and Lead Compounds which is known to the State of California to cause cancer and birth defects or other reproductive harm. For more information go to [www.P65Warnings.ca.gov](http://www.P65Warnings.ca.gov)

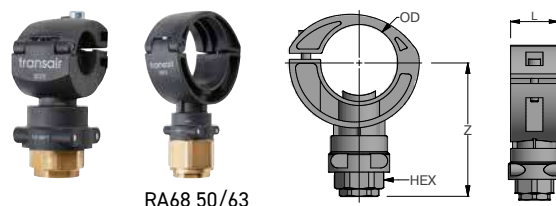

## Female Threaded NPT Simple Reducing Bracket

Part No.	OD (in)	OD (mm)	Thd Size (in)	L (in)	HEX (mm)	Z (in)
RA68 25N04	1	25	1/2	1.46	30	2.60
RA68 40N04	1 1/2	40	1/2	1.46	30	2.87
RA68 50N04	2	50	1/2	1.46	30	3.27
RA68 50N08	2	50	1	1.46	41	3.82
RA68 63N08	2 1/2	63	1	1.46	41	4.02
RA68 63N04	2 1/2	63	1/2	1.46	30	3.46

Supplied with brass plug. To drill Transair® pipe, use drilling tools 6698 02 01 and 6698 02 02.

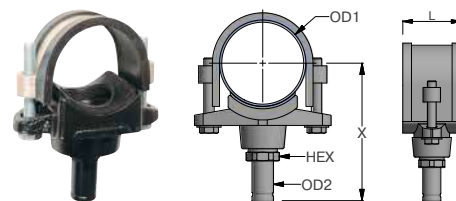

## Female Threaded NPT Saddle Reducing Bracket

Part No.	OD (in)	OD (mm)	OD2 (in)	OD2 (mm)	L (in)	X (in)	HEX (mm)
RR63 L1N08	3	76	1	25	3.15	5.71	36
RR63 L3N08	4	101	1	25	3.54	6.30	36

Nitrile Seals. Supplied with Ø 1" adaptor (6621 25 35). To drill Transair® pipe, use drilling tool EW09.



### WARNING

This product can expose you to chemicals including Lead and Lead Compounds which is known to the State of California to cause cancer and birth defects or other reproductive harm. For more information go to [www.P65Warnings.ca.gov](http://www.P65Warnings.ca.gov)

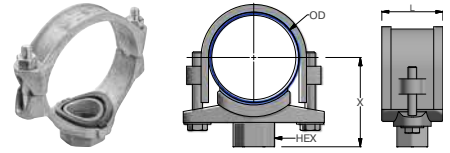

## Female Threaded NPT Saddle Reducing Bracket

Part No.	OD (in)	OD (mm)	Thd Size 1 (in)	Thd Size 2 (in)	L (in)
RR63 L8N12	6	168	1 1/2	16	9 1/4
RR63 L8N16	6	168	2	16	9 1/4

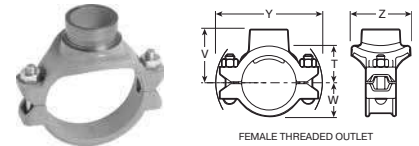

## Female Threaded NPT Saddle Reducing Bracket

Part No.	OD (in)	OD (mm)	Thd Size (in)	T (in)	V (in)	W (in)	Y (in)	Z (in)
RR63 V12N16-SF	8	220	2	5.44	6.19	4.81	12.42	4.5
RR63 V12N20-SF	8	220	2-1/2	5.07	6.19	4.81	12.42	4.5

Drill a 2 1/8" diameter hole for the RR63 V12N16 drop outlet.

Drill a 2 5/8" diameter hole for the RR63 V12N20 drop outlet.



### WARNING

This product can expose you to chemicals including Lead and Lead Compounds which is known to the State of California to cause cancer and birth defects or other reproductive harm. For more information go to [www.P65Warnings.ca.gov](http://www.P65Warnings.ca.gov)

# QUICK ASSEMBLY BRACKETS

New generation quick assembly brackets are recommended for vertical or horizontal take-offs, using either rigid pipe or flexible hose.

## Product Features:

- Integral water retention device
- Very high flow
- Quick installation without any cutting of pipe

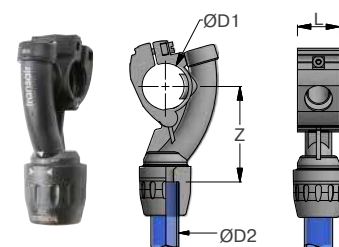
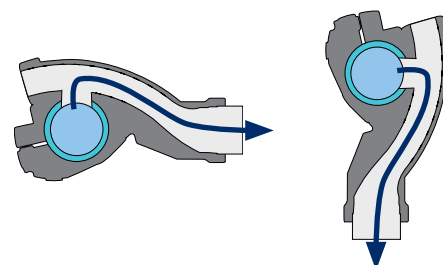

## Quick Assembly Bracket

Part No.	OD1 (in)	OD1 (mm)	OD2 (in)	OD2 (mm)	L (in)	Z (in)
6662 25 17	1	25	1/2	16.5	1 7/16	3 1/4
6662 25 00	1	25	1	25	1 7/16	3
6662 40 17	1 1/2	40	1/2	16.5	1 1/2	3 1/2
6662 40 25	1 1/2	40	1	25	1 1/2	3 1/4

To drill Transair® pipe, use drilling tools 6698 02 01 and 6698 02 02.



### WARNING

This product can expose you to chemicals including Lead and Lead Compounds which is known to the State of California to cause cancer and birth defects or other reproductive harm. For more information go to [www.P65Warnings.ca.gov](http://www.P65Warnings.ca.gov)

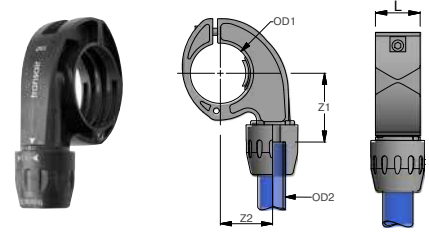

## Quick Assembly Bracket

Part No.	OD1 (in)	OD1 (mm)	OD2 (in)	OD2 (mm)	L (in)	Z1 (in)	Z2 (in)
6662 50 25	2	50	1	25	1.46	2.28	1.73
6662 63 25	2 1/2	63	1	25	1.46	2.56	1.73

To drill Transair® pipe, use drilling tool 6698 02 01.

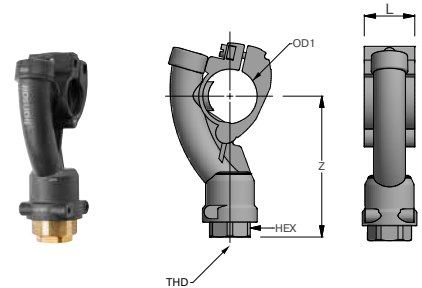

## Female Threaded NPT Quick Assembly Bracket

Part No.	OD1 (in)	OD1 (mm)	Thd Size (in)	HEX (mm)	L (in)	Z (in)
6663 25 22	1	25	1/2	24	1.42	3.80
6663 40 22	1 1/2	40	1/2	24	1.48	4.09

Supplied with brass plug. To drill Transair® pipe, use drilling tools 6698 02 01 and 6698 02 02.



### WARNING

This product can expose you to chemicals including Lead and Lead Compounds which is known to the State of California to cause cancer and birth defects or other reproductive harm. For more information go to [www.P65Warnings.ca.gov](http://www.P65Warnings.ca.gov)

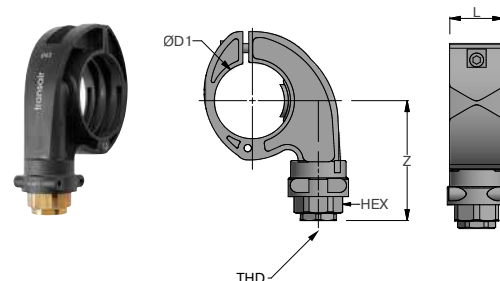

## Female Threaded NPT Quick Assembly Bracket

Part No.	OD1 (in)	OD1 (mm)	Thd Size (in)	HEX (mm)	L (in)	Z (in)
6663 50 22	2	50	1/2	30	1.46	2.95
6663 50 28	2	50	3/4	32	1.46	3.31
6663 63 22	2 1/2	63	1/2	30	1.46	3.23
6663 63 28	2 1/2	63	3/4	32	1.46	3.58

Supplied with brass plug. To drill Transair® pipe, use drilling tool 6698 02 01.

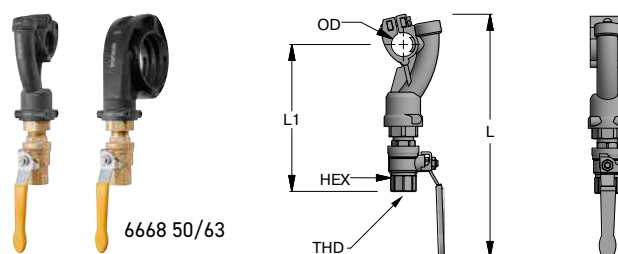

## Threaded NPT Quick Assembly Bracket with Ball Valve

Part No.	OD (in)	OD (mm)	Thd Size (in)	HEX (mm)	L (in)	Z (in)
6668 25 22	1	25	1/2	25	9.96	6.10
6668 40 22	1 1/2	40	1/2	25	10.55	6.38
6668 50 22	2	50	1/2	25	9.68	5.26
6668 63 22	2 1/2	63	1/2	25	10.28	5.53
6668 63 28	2 1/2	63	3/4	31	11.55	6.08

To drill Transair® pipe, use drilling tools 6698 02 01 and 6698 02 02.



### WARNING

This product can expose you to chemicals including Lead and Lead Compounds which is known to the State of California to cause cancer and birth defects or other reproductive harm. For more information go to [www.P65Warnings.ca.gov](http://www.P65Warnings.ca.gov)



## Replacement Part

Part No.	Thd Size
EF19 00 00 01	1/2 NPT

## Drill Bit Selection Chart for Drop Brackets

Part No.	OD (in)	OD (mm)	Tool Part No.
RA69 25 17	1	25	6698 02 02
RA69 40 25	1 1/2	40	6698 02 01
RA69 50 25	2	50	6698 02 01
RA69 63 25	2 1/2	63	6698 02 01
RA68 25N04	1	25	6698 02 02
RA68 40N04	1 1/2	40	6698 02 01
RA68 50N04	2	50	6698 02 01
RA68 50N08	2	50	6698 02 01
RA68 63N08	2 1/2	63	6698 02 01
RR63 L1N08	3	76	EW09 00 30
RR63 L3N08	4	101	EW09 00 30
RR63 L8N12	6	168	EW09 00 51
RR63 L8N16	6	168	EW09 00 64
6662 25 17	1	25	6698 02 02
6662 25 00	1	25	6698 02 02

Part No.	OD (in)	OD (mm)	Tool Part No.
6662 40 17	1 1/2	40	6698 02 01
6662 40 25	1 1/2	40	6698 02 01
6662 50 25	2	50	6698 02 01
6662 63 25	2 1/2	63	6698 02 01
6663 25 22	1	25	6698 02 02
6663 40 22	1 1/2	40	6698 02 01
6663 50 22	2	50	6698 02 01
6663 50 28	2	50	6698 02 01
6663 63 22	2 1/2	63	6698 02 01
6663 63 28	2 1/2	63	6698 02 01
6668 25 22	1	25	6698 02 02
6668 40 22	1 1/2	40	6698 02 01
6668 50 22	2	50	6698 02 01
6668 63 22	2 1/2	63	6698 02 01
6668 63 28	2 1/2	63	6698 02 01



### WARNING

This product can expose you to chemicals including Lead and Lead Compounds which is known to the State of California to cause cancer and birth defects or other reproductive harm. For more information go to [www.P65Warnings.ca.gov](http://www.P65Warnings.ca.gov)

# PRESSURIZED SYSTEM OUTLETS

Parker Hannifin suggests purging the system prior to installing any drop brackets, but if the system cannot be purged, we suggest the use of a pressurized system (hot tap) bracket. These brackets can only be used for active compressed air lines.

## Product Features:

- Ideal for fast assembly of new pressurized outlets, without venting the compressed air system.
- The drilling tool can be used with most standard drills.

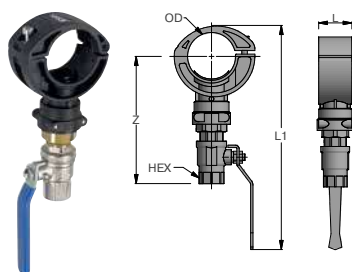

## Pressurized System Bracket

Part No.	OD (in)	OD (mm)	L (in)	L1 (in)	Z (in)
EA98 25 04	1	25	1.42	8.15	4.57
EA98 40 04	1 1/2	40	1.46	8.70	4.80
EA98 50 04	2	50	1.46	9.30	5.24
EA98 63 04	2 1/2	63	1.46	9.76	5.43

Bracket with ball valve (1/2" BSPP thread)  
Drilling tool EA98 06 00 is required for installation.

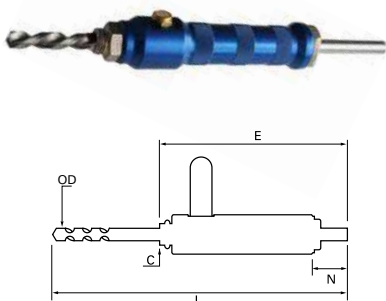

## Pressurized System Drilling Tool, BSPP

Part No.	OD (in)	OD (mm)	C (in)	L (in)
EA98 06 00	1/2	16.5	1/2	13



### WARNING

This product can expose you to chemicals including Lead and Lead Compounds which is known to the State of California to cause cancer and birth defects or other reproductive harm. For more information go to [www.P65Warnings.ca.gov](http://www.P65Warnings.ca.gov)

# WALL BRACKETS

## Product Features:

- 1, 2 or 3 ports
- For wall or machine mounting
- Supplied with brass plugs
- Drain outlet 1/4"
- Non-flammable (conforms to UL94-HB standard)

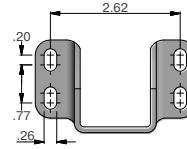

Dimensions for all brackets.

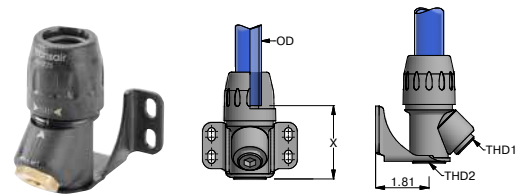

## 1 Port 45° Wall Bracket – Threaded NPT Port

Part No.	OD (in)	OD (mm)	Thd Size 1 (in)	Thd Size 2 (in)	X (in)	H1 (in)	H2 (in)	H3 (in)
6640 17 22	1/2	16.5	1/2	1/4	2.50	10	24	6
6640 25 22	1	25	1/2	1/4	2.50	10	24	6

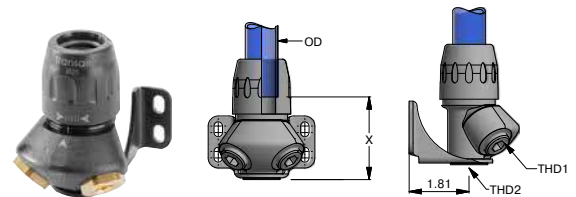

## 2 Port 45° Wall Bracket – Threaded NPT Port

Part No.	OD (in)	OD (mm)	Thd Size 1 (in)	Thd Size 2 (in)	X (in)	H1 (in)	H2 (in)	H3 (in)
6689 17 22	1/2	16.5	1/2	1/4	2.50	10	24	6
6689 25 22	1	25	1/2	1/4	2.52	10	24	6



### WARNING

This product can expose you to chemicals including Lead and Lead Compounds which is known to the State of California to cause cancer and birth defects or other reproductive harm. For more information go to [www.P65Warnings.ca.gov](http://www.P65Warnings.ca.gov)

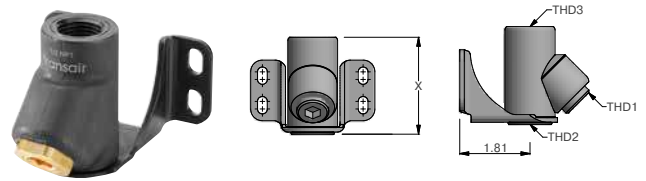

### Threaded NPT 1 Port 45° Wall Bracket

Part No.	Thd Size 1 (in)	Thd Size 2 (in)	Thd Size 3 (in)	X (in)	H1 (in)	H2 (in)	H3 (in)
6642 22 22	1/2	1/4	1/2	2.52	10	24	6

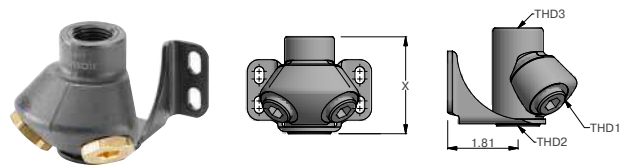

### Threaded NPT 2 Port 45° Wall Bracket

Part No.	Thd Size 1 (in)	Thd Size 2 (in)	Thd Size 3 (in)	X (in)	H1 (in)	H2 (in)	H3 (in)
6691 22 22	1/2	1/4	1/2	2.52	10	24	6

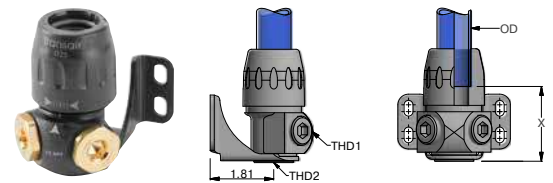

### 2 Port 90° Wall Bracket – Threaded NPT Port

Part No.	OD (in)	OD (mm)	Thd Size 1 (in)	Thd Size 2 (in)	X (in)	H1 (in)	H2 (in)	H3 (in)
6684 17 22	1/2	16.5	1/2	1/4	2.05	10	24	6
6684 25 22	1	25	1/2	1/4	2.22	10	24	6



**WARNING**

This product can expose you to chemicals including Lead and Lead Compounds which is known to the State of California to cause cancer and birth defects or other reproductive harm. For more information go to [www.P65Warnings.ca.gov](http://www.P65Warnings.ca.gov)

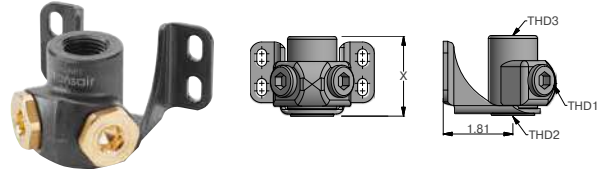

### Threaded NPT 2 Port 90° Wall Bracket

Part No.	Thd Size 1 (in)	Thd Size 2 (in)	Thd Size 3 (in)	X (in)	H1 (in)	H2 (in)	H3 (in)
6688 22 22	1/2	1/4	1/2	2.03	10	24	6

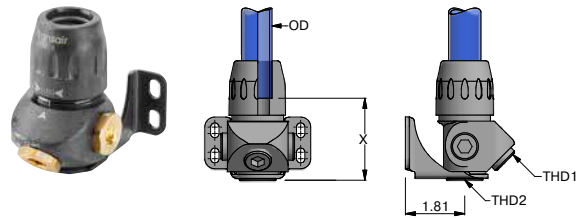

### 3 Port Wall Bracket – Threaded NPT Port

Part No.	OD (in)	OD (mm)	Thd Size 1 (in)	Thd Size 2 (in)	X (in)	H1 (in)	H2 (in)	H3 (in)
6696 25 22	1	25	1/2	1/4	2.52	10	24	6

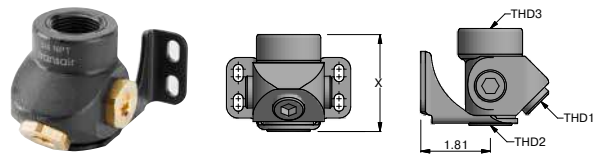

### Threaded NPT 3 Port Wall Bracket

Part No.	Thd Size 1 (in)	Thd Size 2 (in)	Thd Size 3 (in)	X (in)	H1 (in)	H2 (in)	H3 (in)
6636 28 22	1/2	1/4	3/4	2.52	10	24	6



**WARNING**

This product can expose you to chemicals including Lead and Lead Compounds which is known to the State of California to cause cancer and birth defects or other reproductive harm. For more information go to [www.P65Warnings.ca.gov](http://www.P65Warnings.ca.gov)

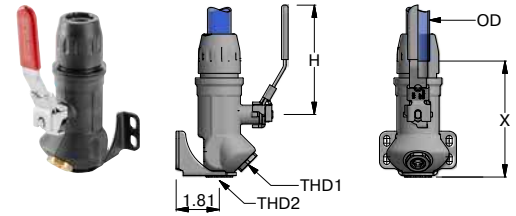

### 1 Port 45° Wall Bracket With Ball Valve – Threaded NPT Port

Part No.	OD (in)	OD (mm)	Thd Size 1 (in)	Thd Size 2 (in)	X (in)	H(in)	H1 (in)	H2 (in)	H3 (in)
6679 17 22	1/2	16.5	1/2	1/4	4.09	3.77	10	24	6
6679 25 22	1	25	1/2	1/4	4.86	4.59	10	24	6

Includes Locking Handle

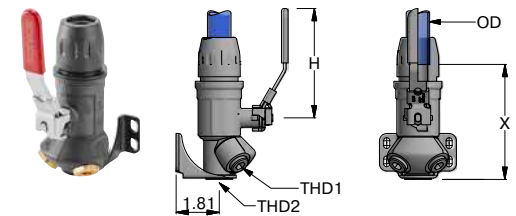

### 2 Port 45° Wall Bracket With Ball Valve – Threaded NPT Port

Part No.	OD (in)	OD (mm)	Thd Size 1 (in)	Thd Size 2 (in)	X (in)	H(in)	H1 (in)	H2 (in)	H3 (in)
6694 17 22	1/2	16.5	1/2	1/4	4.09	3.77	10	24	6
6694 25 22	1	25	1/2	1/4	4.86	4.59	10	24	6

Includes Locking Handle

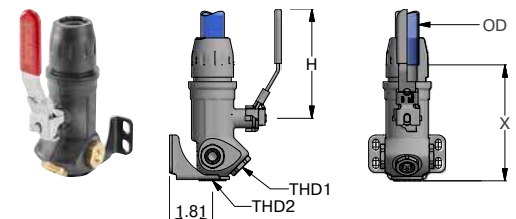

### 3 Port Wall Bracket With Ball Valve – Threaded NPT Port

Part No.	OD (in)	OD (mm)	Thd Size 1 (in)	Thd Size 2 (in)	X (in)	H (in)	H1 (in)	H2 (in)	H3 (in)
6638 25 22	1	25	1/2	1/4	4.86	4.59	10	24	6

Includes Locking Handle



#### WARNING

This product can expose you to chemicals including Lead and Lead Compounds which is known to the State of California to cause cancer and birth defects or other reproductive harm. For more information go to [www.P65Warnings.ca.gov](http://www.P65Warnings.ca.gov)

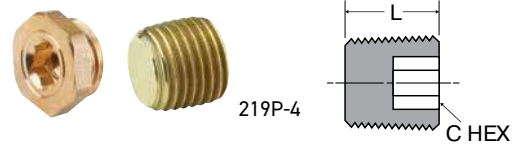

## Replacement Plugs

Part No.	Thd Size (in)	FOR USE WITH
219P-4	1/4 NPT	Wall Bracket Drain Ports
EF19 00 00 01	1/2 NPT	Wall Bracket Ports



**WARNING**

This product can expose you to chemicals including Lead and Lead Compounds which is known to the State of California to cause cancer and birth defects or other reproductive harm. For more information go to [www.P65Warnings.ca.gov](http://www.P65Warnings.ca.gov)

# VALVES

Transair® ball valves and butterfly valves placed regularly throughout the system at key locations, such as compressor outlets and upstream of pneumatic tools, allow ease of system isolation and pipe reconfiguration / maintenance.

## Product Features:

- Quick connection
- Lockable handles

## Specifications:

**Max. Working Pressure\*** 188 PSI from -4°F to +140°F  
(12.9 bar from -20° to +60° C)

232 PSI from -4°F to +113°F  
(15.9 bar from -20° to +46.1° C)

**Vacuum:** 98.7% (29.6" Hg)

**Working Temperature:** -4° to +140° F (-20° to +60° C)

\* Please consult us for higher temperature requirements

4092 50/63



## Safety Lockable Double Female Valve

Part No.	OD (in)	OD (mm)	L (in)	Z1 (in)	Z2 (in)	H (in)	P (in)
4092 17 00	1/2	16.5	4.86	1.14	1.69	3.78	2.05
4092 25 00	1	25	6.12	1.61	2.24	4.61	2.89
4092 40 00	1 1/2	40	8.07	2.24	2.28	5.55	2.99
4092 50 00	2	50	8.82	2.36	1.69	6.14	3.54
4092 63 00	2 1/2	63	10.58	2.59	3.05	7.89	4.31



### WARNING

This product can expose you to chemicals including Lead and Lead Compounds which is known to the State of California to cause cancer and birth defects or other reproductive harm. For more information go to [www.P65Warnings.ca.gov](http://www.P65Warnings.ca.gov)

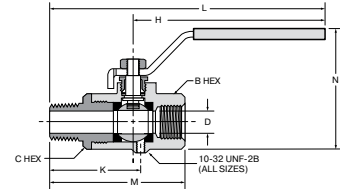

## Safety Lockable, Vented, Threaded Male – Female Valve

Part No.	Female Pipe Thd [PTF]	Male Pipe Thd [NPTF]	B Hex	C Hex	K	H	L	M	N	D Flow Ø
VVP501P-4	1/4	1/4	15/16	15/16	1.67	3.96	5.46	2.59	1.93	.344
VVP501P-8	1/2*	1/2	1-1/16	1-1/16	1.98	3.96	5.75	2.95	1.97	.500
VVP501P-12	3/4**	3/4*	1-1/4	1-5/16	2.03	3.96	5.83	3.00	2.09	.685
VVP501P-16	1**	1*	1-1/2	1-9/16	2.43	3.96	6.19	3.60	2.21	.875

\*PTF Special Short

\*\*PTF SPL Extra Short

See pages A12, A13, A17, A20, A21, A22, A24, and A25 for our threaded connectors, drop brackets, and wall brackets that can be used with our threaded ball valves.

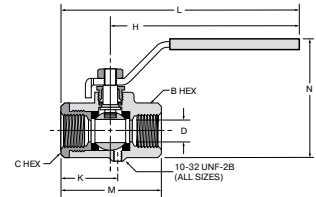

## Safety Lockable, Vented, Threaded Double Female Valve

Part No.	Pipe Thd [PTF]	B Hex	C Hex	K	H	L	M	N	D Flow Ø
VVP502P-8	1/2*	1-1/16	1-1/16	1.23	3.96	5.00	2.20	1.97	.500
VVP502P-12	3/4**	1-1/4	1-5/16	1.45	3.96	5.15	2.42	2.09	.685
VVP502P-16	1**	1-1/2	1-9/16	1.58	3.91	5.29	2.75	2.21	.875



### WARNING

This product can expose you to chemicals including Lead and Lead Compounds which is known to the State of California to cause cancer and birth defects or other reproductive harm. For more information go to [www.P65Warnings.ca.gov](http://www.P65Warnings.ca.gov)

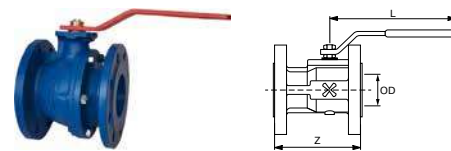

## Ball Valve

Part No.	OD (in)	OD (mm)	DN	L (in)	Z (in)	D (in)	Number of Bolt Holes
VR01 L1 00 46	3	76	80	11.02	7.09	6.50	4
VR01 L3 00 46	4	101	100	14.17	7.48	7.09	8
VR01 L8 00	6	168	150	20.47	8.27	9.57	8

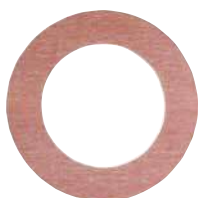

## Flange Gasket

Part No.	OD (in)	OD (mm)	DN	OD (in)	ID (in)	T (in)	Material
EW05 L1 00 10	3	76	80	5.20	3.11	.12	NBR
EW05 L3 00	4	101	100	6.38	4.53	.12	NBR
EW05 L8 00	6	168	150	8.58	6.65	.12	NBR



EW06 00 14US

## Flange to Ball Valve Bolt Kits

Part No.	OD (in)	OD (mm)	Thd Size (in)	L (in)	Hex (in)	Number of Bolts in Kit
EW06 00 14US	3	76	5/8-11	3	15/16	4
EW10 00 15US	4	101	5/8-11	3	15/16	8
EW10 00 16US	6	168	3/4-10	3	1-1/4	8

Kits are supplied with 1 nut and 1 washer per bolt.

## Ball Valve Accessories Chart

OD (in)	OD (mm)	Ball Valve Part No.	Flange Part No.	Gasket Part No.	Bolt Kit Part No. (Flange to Ball Valve)	Number of Bolt Kits	Max. Tightening Torque (Ft-Lbs)
3	76	VR01 L1 00 46	RA31 L1 00	EW05 L1 00 10	EW06 00 14US	1	59
4	101	VR01 L3 00 46	RA31 L3 00	EW05 L3 00	EW10 00 15US	1	59
6	168	VR01 L8 00	RA31 L8 00	EW05 L8 00	EW10 00 16US	1	147



### WARNING

This product can expose you to chemicals including Lead and Lead Compounds which is known to the State of California to cause cancer and birth defects or other reproductive harm. For more information go to [www.P65Warnings.ca.gov](http://www.P65Warnings.ca.gov)

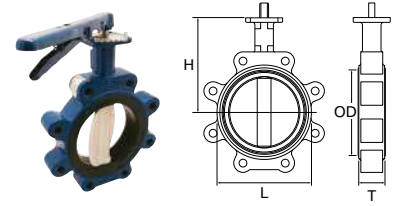

### Butterfly Valve

Part No.	OD (in)	OD (mm)	Flange STD	DN	D (in)	Thd Size (UNC-2B)	Number of Bolt Holes	L (in)	H (in)	T (in)
VR02 63 00*	2-1/2	63	DIN	65	5.50	-	4	4.01	7.32	1.81
VR02 L1 00US	3	76	ANSI	80	6.00	5/8-11	4	4.72	6.30	1.75
VR02 L3 00US	4	101	ANSI	100	7.50	5/8-11	8	5.91	7.09	2.00
VR02 L8 00US	6	168	ANSI	150	9.50	3/4-10	8	8.07	8.07	2.12

Valve is not supplied with handle and bolt kit.

Max. Pressure 175 PSI (12 bar)

\*Handle included

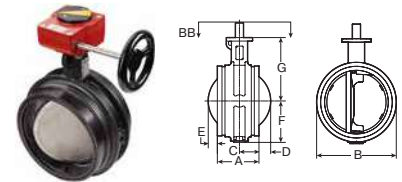

### Butterfly Valve

Part No.	OD (in)	OD (mm)	Flange STD	A (in)	B (in)	C (in)	D (in)	E (in)	F(in)	G (in)	H (in)
VR02 V1200US-SF	8	220	ANSI	5.66	10	2.33	1.47	0.8	5	8	2.17



### Lockable Valve Handle

Part No.	Valve Diameter (in)
EW08 L1 00	3
EW08 L3 00	4
EW08 L8 00	6



**WARNING**

This product can expose you to chemicals including Lead and Lead Compounds which is known to the State of California to cause cancer and birth defects or other reproductive harm. For more information go to [www.P65Warnings.ca.gov](http://www.P65Warnings.ca.gov)



EW06 00 10

## Flange to Butterfly Valve Bolt Kits

Part No.	OD (in)	OD (mm)	Thd Size (in)	L (in)	Hex (in)	Number of Bolts in Kit
EW06 00 10	2 1/2	63	5/8-11	5.25	15/16	4
EW10 00 US	3, 4	76, 101	5/8-11	1.75	15/16	8
EW10 00 02	6	168	3/4-10	2.00	1 1/8	16

Kits are supplied with 1 nut and 1 washer per bolt.

## Butterfly Valve Accessories Chart

OD (in)	OD (mm)	Butterfly Valve Part No.	Flange Part No.	Bolt Kit Part No. (Flange to Butterfly Valve)	Number of Bolt Kits	Max. Tightening Torque (Ft-Lbs)
2 1/2	63	VR02 63 00	RA31 63 00	EW06 00 10	1	59
3	76	VR02 L1 00US	RA31 L1 00	EW10 00 US	1	59
4	101	VR02 L3 00US	RA31 L3 00	EW10 00 US	1	59
6	168	VR02 L8 00US	RA31 L8 00	EW10 00 02	1	147



### WARNING

This product can expose you to chemicals including Lead and Lead Compounds which is known to the State of California to cause cancer and birth defects or other reproductive harm. For more information go to [www.P65Warnings.ca.gov](http://www.P65Warnings.ca.gov)

# TOOLS



## Tool Case

Part No.	H (in)	L (in)
6698 00 05	12 7/8	11 3/8

This tool case simplifies the use and transportation of tools. It contains all the tools necessary for completing system installations from 1/2" to 2-1/2":

- Chamfer tool 6698 04 01
- Cutter for rigid pipe 6698 03 01
- Deburring tool 6698 04 02
- Drilling jig 6698 01 03
- Drill bits 6698 02 01 and 6698 02 02
- Marking tool 6698 04 03
- Spanner wrenches 6698 05 03

## Product Features:

- Practical tools for the installation and extension of Transair® pipe systems.
- Presented in a carrying case or available as separate parts.

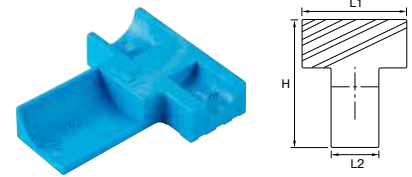

## Marking Tool

Part No.
6698 04 03

The marking tool is used as a guide for marking cut lengths on Transair® pipe. These marks indicate the insertion limits of the pipe into each fitting in order to ensure a good airtight connection and secure grip.

## Chamfer Tool

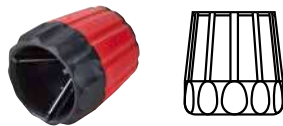

Part No.
6698 04 01

For 1/2", 1" and 1 1/2".

## Spanner Wrenches



Part No.
6698 05 03

Includes two tightening spanners. Used to tighten 50mm and 63mm connectors.

## Deburring Tool



Part No.
6698 04 02



### WARNING

This product can expose you to chemicals including Lead and Lead Compounds which is known to the State of California to cause cancer and birth defects or other reproductive harm. For more information go to [www.P65Warnings.ca.gov](http://www.P65Warnings.ca.gov)

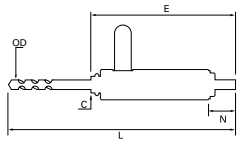

## Pressurized System Drill Bit, BSPP

Part No.	OD (in)	OD (mm)	C (in)	L (in)
EA98 06 00	1/2	16.5	1/2	13

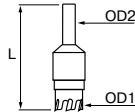

## Drill Bits

Part No.	OD1 (in)	OD1 (mm)	OD2 (in)	OD2 (mm)	L (in)	Used for Transair® pipe (in)
6698 02 02	5/8	16	1/2	11	2 7/8	Ø 1

Drill bit 6698 02 02 is required to install Ø 1" Transair® brackets. Recommended to be used with any cordless drill with a 1/2" chuck. Use with Transair drilling jig, 6698 01 03.

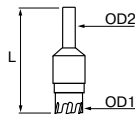

Part No.	OD1 (in)	OD1 (mm)	OD2 (in)	OD2 (mm)	L (in)	Used for Transair® pipe (in)
6698 02 01	1	22	1/2	13	2 3/4	Ø 1 1/2 - 2 1/2

Drill bit 6698 02 01 is required to install Ø 1 1/2", Ø 2" and Ø 2 1/2" Transair® brackets. It is also used to create the two holes needed for double-clamp ring connectors when cutting to length Ø 2 1/2" Transair® pipe. Recommended to be used with any cordless drill with a 1/2" chuck.

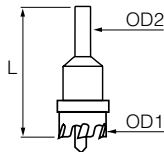

Part No.	OD1 (in)	OD1 (mm)	OD2 (in)	OD2 (mm)	L (in)	Used for Transair® Pipe (in)
EW09 00 22	1	22	1/2	13	2 3/4	Ø 1 1/2 - 2 1/2
EW09 00 30	1 3/16	30	1/2	13	2 3/4	Ø 3 - 4
EW09 00 51	2	50	1/2	13	2 3/4	Ø 6
EW09 00 64	2 1/2	63	1/2	13	2 3/4	Ø 6

Drill bit EW09 is required to install Transair® direct feed brackets. After drilling, it is important to deburr and clean the pipe. Recommended to be used with any cordless drill with a 1/2" chuck.



### WARNING

This product can expose you to chemicals including Lead and Lead Compounds which is known to the State of California to cause cancer and birth defects or other reproductive harm. For more information go to [www.P65Warnings.ca.gov](http://www.P65Warnings.ca.gov)

## Drill Bit Selection Chart

Part No.	OD (in)	OD (mm)	Tool Part No.
6650 00 00 04	2	50	6698 02 01
6650 00 00 16	2-1/2	63	6698 02 01
RA69 25 17	1	25	6698 02 02
RA69 40 25	1-1/2	40	6698 02 01
RA69 50 25	2	50	6698 02 01
RA69 63 25	2-1/2	63	6698 02 01
RA68 25N04	1	25	6698 02 02
RA68 40N04	1-1/2	40	6698 02 01
RA68 50N04	2	50	6698 02 01
RA68 50N08	2	50	6698 02 01
RA68 63N08	2-1/2	63	6698 02 01
RR63 L1N08	3	76	EW09 00 30
RR63 L3N08	4	101	EW09 00 30
RR63 L8N12	6	168	EW09 00 51
RR63 L8N16	6	168	EW09 00 64
6662 25 17	1	25	6698 02 02

Part No.	OD (in)	OD (mm)	Tool Part No.
6662 25 00	1	25	6698 02 02
6662 40 17	1-1/2	40	6698 02 01
6662 40 25	1-1/2	40	6698 02 01
6662 50 25	2	50	6698 02 01
6662 63 25	2-1/2	63	6698 02 01
6663 25 22	1	25	6698 02 02
6663 40 22	1-1/2	40	6698 02 01
6663 50 22	2	50	6698 02 01
6663 50 28	2	50	6698 02 01
6663 63 22	2-1/2	63	6698 02 01
6663 63 28	2-1/2	63	6698 02 01
6668 25 22	1	25	6698 02 02
6668 40 22	1-1/2	40	6698 02 01
6668 50 22	2	50	6698 02 01
6668 63 22	2-1/2	63	6698 02 01
6668 63 28	2-1/2	63	6698 02 01



### WARNING

This product can expose you to chemicals including Lead and Lead Compounds which is known to the State of California to cause cancer and birth defects or other reproductive harm. For more information go to [www.P65Warnings.ca.gov](http://www.P65Warnings.ca.gov)

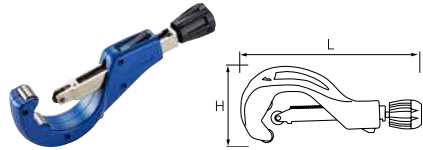

### Pipe Cutter

Part No.	Used for Transair® Pipe (in)
6698 03 01	Ø 1/2 - 3
EW08 00 03	Ø 4 - 6

Includes deburring tool.



### Drilling Jig

Part No.	Used for Transair® Pipe (in)
6698 01 01	Ø 1 to 1-1/2
6698 01 03	Ø 1 to 2-1/2



### Replacement Cutter Wheels

Part No.	Used for Transair® Pipe Cutter
EW08 00 99	6698 03 01
EW08 00 04	EW08 00 03



### Electric Pipe Cutter

Part No.	Used for Transair® Pipe (in)
EW08 00 V3	Ø 1-1/2 to 6



### Replacement Cutter Blade

Part No.	Used for Transair® Pipe Cutter
EW08 00 ALUS	EW08 00 V3



**WARNING**

This product can expose you to chemicals including Lead and Lead Compounds which is known to the State of California to cause cancer and birth defects or other reproductive harm. For more information go to [www.P65Warnings.ca.gov](http://www.P65Warnings.ca.gov)



### Dies for Roll Groover

Part No.	Used for Transair Pipe (in)	Used for Transair Pipe (mm)
EW02 V1200	8	220

Compatible with VE270FSD/271FSD roll grooving tools. Grooving tool available through Sunbelt Rental



### Portable Lugging Tool Kit

Part No.	Voltage
EW01 00 02	14

This case contains: one portable tool, one 14V battery and battery charger. Jaws sold separately.

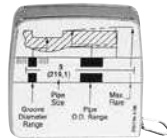

### Groove Depth Measuring Tape

Part No.	Used for Transair Pipe (in)	Used for Transair Pipe (mm)
6698 V1203	8	220



### 14V Battery for Portable Lugging Tool

Part No.	Voltage
EW03 00 01	14

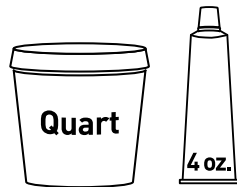

### Lubricant

Part No.	Container Size	Quantity	Used for Transair Pipe(in)
6698 V1201	Quart	1	8
6698 V1202	4 oz Tube	12	8

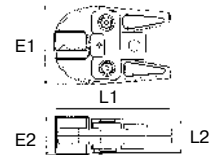

### Jaws for Portable Lugging Tool

Part No.	Used for Transair Pipe (in)	Used for Transair Pipe (mm)
EW02 L1 00	3	76
EW02 L3 00	4	101
EW02 L8 00	6	168



**WARNING**

This product can expose you to chemicals including Lead and Lead Compounds which is known to the State of California to cause cancer and birth defects or other reproductive harm. For more information go to [www.P65Warnings.ca.gov](http://www.P65Warnings.ca.gov)

# TRANSAIR® PIPE HANGERS

## Product Features:

- Easy adaptation for all pipe work configurations
- For suspension of pipes, from walls, partitions, beams, cable trays, Canalis electrical installations, etc, vertically or horizontally
- Perfectly suited for use with Transair® systems
- Non-flammable (conforms to UL94V-2 standard)
- Transair® pipe hangers are designed to bear a maximum WT of 44lbs. However, to ensure good stability of the system, we recommend the use of at least two hangers per pipe i.e.:
  - Maximum 5 ft space between hangers for 9 ft lengths of pipe
  - Maximum 10 ft space between hangers for 20 ft lengths of pipe
- Only use Transair® pipe hangers for hanging Transair aluminum pipe. Use of non-Transair hangers will void the warranty. All hangers should be fixed to a rigid support to allow for expansion and contraction.

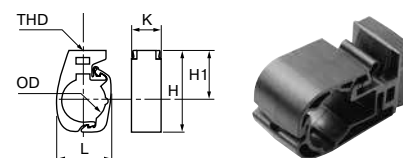

## Pipe Hangers

Part No.	OD (in)	OD (mm)	Thd Size (in)	L (in)	H (in)	H1 (in)	K (in)
6697 17 01*	1/2	16.5	1/4-20 UNC	1 3/16	2.44	1.81	1.18
6697 25 01*	1	25	1/4-20 UNC	1 1/2	2.62	1.81	1.18
6697 40 01*	1 1/2	40	1/4-20 UNC	2	2.95	1.81	1.18
6697 50 01	2	50	3/8-16 UNC	2 7/8	4.84	3.54	1.18
6697 63 01	2 1/2	63	3/8-16 UNC	2 7/8	5.02	3.54	1.18

\* Use 0169 00 05 00 to convert the 1/4" thread to 3/8" to suspend Transair pipe with 3/8" threaded rod

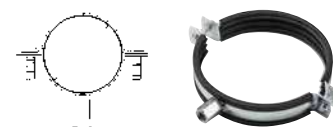

## Rubber Insulated Pipe Hangers

Part No.	OD (in)	OD (mm)	Thd Size (in)
ER01 L1 00	3	76	3/8-16 UNC
ER01 L3 00	4	101	3/8-16 UNC
ER01 L8 00	6	168	3/8-16 UNC



### WARNING

This product can expose you to chemicals including Lead and Lead Compounds which is known to the State of California to cause cancer and birth defects or other reproductive harm. For more information go to [www.P65Warnings.ca.gov](http://www.P65Warnings.ca.gov)

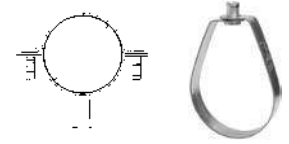

## Pipe Hanger

Part No.	OD (in)	OD (mm)	Thd Size (in)	B (in)
EX01 V1200	8	220	1/2"-13	8-9/16

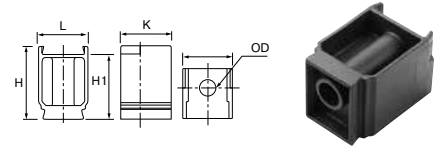

## Spacer

Part No.	OD (in)	OD (mm)	L (in)	Used For Transair® Pipe (in)
6697 00 03	7/16	11	1 3/16	Ø1/2 to 1-1/2

This spacer, in association with a Transair® pipe clip, allows consistent alignment of pipes when different diameters of pipe are run concurrently in the same line.

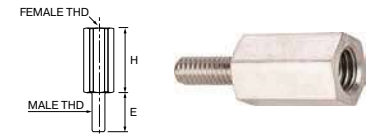

## Threaded Rod Adapter

Part No.	Male Thd Size (in)	Female Thd Size (in)	E (in)	H (in)	Used For Transair® Pipe (in)
0169 00 05 00	1/4-20	3/8-16	5/8	1 3/16	Ø1/2 to 1-1/2

The use of this adapter facilitates the suspension of Transair® with 3/8" threaded rod.



### WARNING

This product can expose you to chemicals including Lead and Lead Compounds which is known to the State of California to cause cancer and birth defects or other reproductive harm. For more information go to [www.P65Warnings.ca.gov](http://www.P65Warnings.ca.gov)

# HOSE REELS

## Product Features:

- Optimize productivity and the safety of your work area
- Prevent hose damage occurring on the workshop floor

## Specifications:

**Max. Working Pressure\*:** 6698 11 11: 250 PSI (17.2 bar)  
6698 11 12: 250 PSI (17.2 bar)

**Working Temperature:** -4° to +140° F (-20° to +60° C)

\* Dependant on the model

Progressive flow depending on the trigger position

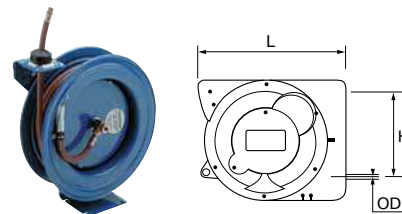
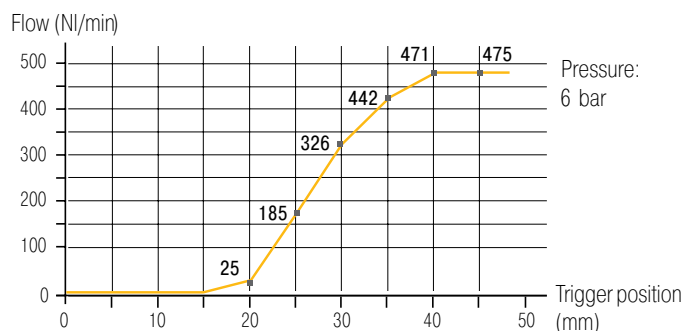

## Hose Reel

Part No.	Hose ID (in)	Max. Pressure (psi)	Hose Length (ft)	H (in)	L (in)
6698 11 11	3/8	250	25		11 13/16
6698 11 12	3/8	250	50	18.63	17.13

Hose clutch with free return. Outlet connection 1/4 male - 3/8" inlet

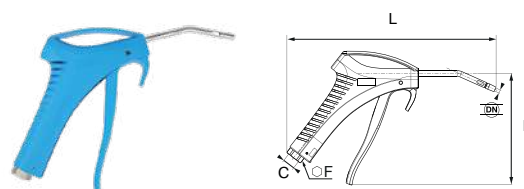

nylon, treated aluminum, NBR

## 0659 Standard Blowgun Lower Connection with Short Angled Nozzle - NPT

Part No.	C NPT	C1 metric	F mm	H in	L in	W kg
0659 00 14	1/4	M12 x 1.25	20	4.71	8.78	2.50



### WARNING

This product can expose you to chemicals including Lead and Lead Compounds which is known to the State of California to cause cancer and birth defects or other reproductive harm. For more information go to [www.P65Warnings.ca.gov](http://www.P65Warnings.ca.gov)

# COMPOSITE AUTOMATIC SAFETY COUPLERS

Parker Transair's quick-acting safety couplers have been designed for the safety of the operator, while maintaining superior performance. With two standard profiles, Transair safety couplers are ideal for any installation.

## Product Features:

- Prevents risk of whiplash
- Quick-acting vent for safe and fast disconnection
- Constructed from impact-resistant material
- High flow rates with minimum pressure drop
- ISO 4414 and EN 983 safety standard compliant
- Suitable media: Compressed air, argon, nitrogen (please contact us for other medias)

## Specifications:

**Max. Working Pressure:** 232 PSI (15.9 bar)

**Working Temperature:** -4° to +140° F (-20° to +60° C)

ISO Profile:

Glass-reinforced Nylon  
6.6 or Aluminum Body

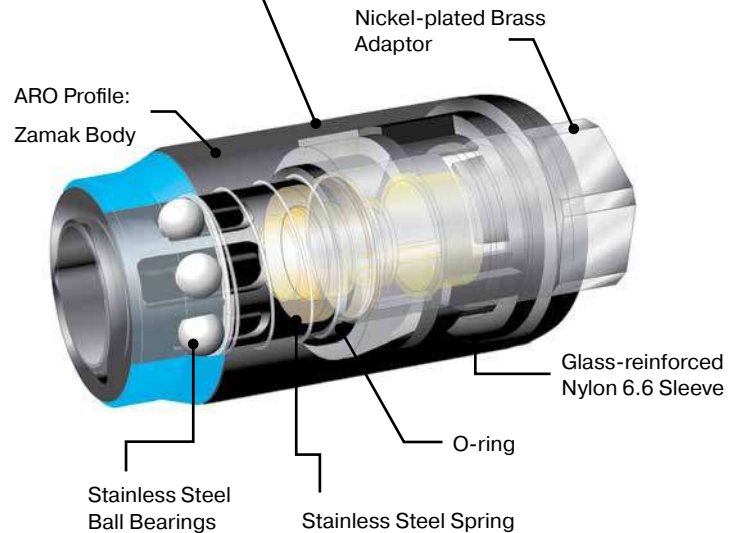

## Safety

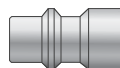
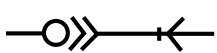

ISO B 1/4"  
ISO 6150 B  
AFNOR NF 49-053  
US.MIL.C4109  
CEJN 310  
RECTUS 23-24

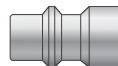

ISO B 3/8"  
ISO 6150 B  
AFNOR NF 49-053  
US.MIL.C4109  
CEJN 430  
RECTUS 30

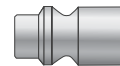

ARO 1/4"  
ARO 210  
CEJN 300  
ORION 44510  
PARKER 50  
RECTUS 14-22



### WARNING

This product can expose you to chemicals including Lead and Lead Compounds which is known to the State of California to cause cancer and birth defects or other reproductive harm. For more information go to [www.P65Warnings.ca.gov](http://www.P65Warnings.ca.gov)

## 1/4" ISO B Body Profile (47 SCFM)

**Male NPT**

Part No.	Thd Size (in)
CP05 U1N02	1/4
CP05 U1N03	3/8
CP05 U1N04	1/2

**Male Plug NPT**

Part No.	Thd Size (in)
9084 23 14	1/4
9084 23 18	3/8

**Female NPT**

Part No.	Thd Size (in)
CP15 U1N02	1/4
CP15 U1N03	3/8
CP15 U1N04	1/2

**Female Plug NPT**

Part No.	Thd Size (in)
9083 23 14	1/4
9083 23 18	3/8

**Coupler with Hosetail**

Part No.	OD (mm)
CP21 U1 06	6
CP21 U1 08	8
CP21 U1 10	10

**Plug with Hosetail**

Part No.	ID (in)
9085 23 56	1/4
9085 23 08	5/16
9085 23 60	3/8

**WARNING**

This product can expose you to chemicals including Lead and Lead Compounds which is known to the State of California to cause cancer and birth defects or other reproductive harm. For more information go to [www.P65Warnings.ca.gov](http://www.P65Warnings.ca.gov)

## 3/8 ISO B Body Profile (97 SCFM)

**Male NPT**

Part No.	Thd Size (in)
CP05 U2N03	3/8
CP05 U2N04	1/2

**Male Plug NPT**

Part No.	Thd Size (in)
9084 30 14	1/4
9084 30 18	3/8

**Female NPT**

Part No.	Thd Size (in)
CP15 U2N04	1/2

**Female Plug NPT**

Part No.	Thd Size (in)
9083 30 14	1/4
9083 30 18	3/8

**Coupler with Hosetail**

Part No.	OD (mm)
CP21 U2 08	8
CP21 U2 10	10
CP21 U2 13	13

**Plug with Hosetail**

PART No.	ID (in)
9085 30 08	5/16
9085 30 60	3/8
9085 30 62	1/2

**WARNING**

This product can expose you to chemicals including Lead and Lead Compounds which is known to the State of California to cause cancer and birth defects or other reproductive harm. For more information go to [www.P65Warnings.ca.gov](http://www.P65Warnings.ca.gov)

## 1/4" ARO Body Profile (44 SCFM)



### Male NPT

Part No.	Thd Size (in)
CP05 A1N04	1/2



### Male Plug NPT

Part No.	Thd Size (in)
9084 22 14	1/4
9084 22 18	3/8



### Coupler with Hosetail

Part No.	OD (mm)
CP21 A1 06	6
CP21 A1 08	8
CP21 A1 10	10



### Female Plug NPT

Part No.	Thd Size (in)
9083 22 14	1/4
9083 22 18	3/8



#### WARNING

This product can expose you to chemicals including Lead and Lead Compounds which is known to the State of California to cause cancer and birth defects or other reproductive harm. For more information go to [www.P65Warnings.ca.gov](http://www.P65Warnings.ca.gov)

## Operation



### Connecting the probe

The sleeve does not need to be rotated to connect the probe.

### Disconnecting the probe

Rotation, arrow 1: circuit vented on probe side.

Rotation, arrow 2: probe disconnected from the body.

## Venting Time

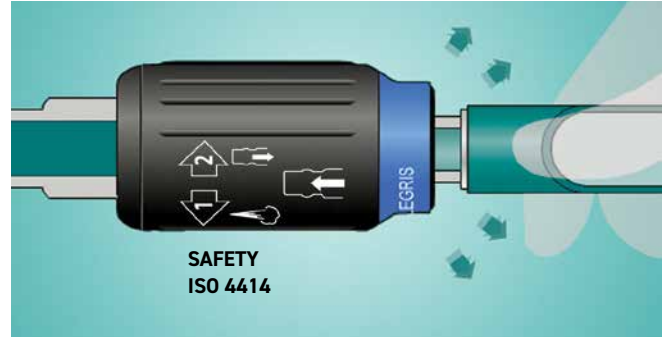

ISO B6 profile, recoil tubing  
(I.D. 6 mm, length 20 feet)

Venting time = 350 ms (transition from 87 psi to 3psi)

ISO B8 profile, PVC tubing  
(I.D. 10 mm, length 82 feet)

Venting time = 860 ms (transition from 87 psi to 3psi)

Even with longer lengths of tubing, the vent time of the C9000 coupler can be less than 1 second.



### WARNING

This product can expose you to chemicals including Lead and Lead Compounds which is known to the State of California to cause cancer and birth defects or other reproductive harm. For more information go to [www.P65Warnings.ca.gov](http://www.P65Warnings.ca.gov)

# TRANSAIR 316L STAINLESS STEEL DROPS

Transair 316L drops are the ideal solutions for compressed air and vacuum applications in demanding environments. We offer an array of 3/4" push to connect components to customize the drop to the point of use needs. Transair 316L drops can integrate into existing Transair aluminum or stainless steel systems.

These modular components are easy to clean and offer a high chemical resistance. Since these components comply with FDA-CFR21 requirements, Transair 316L drops can be used in areas where components are constantly in contact with food or beverages.

## Technical Specifications

<b>Outside Diameter</b>	3/4" (22mm)
<b>Inside Diameter</b>	0.77" (19.6mm)
<b>Pressure Range</b>	0 to 145psi (0 to 10 bar)
<b>Temperature Range</b>	-4F to +248F (-20C to +120C)
<b>Vacuum Rating</b>	99.9% (0.03" Hg / 1mbar)
<b>Seal Material</b>	FKM
<b>Body Material</b>	316L Stainless Steel

## Product Features

- Push to connect connections
- Full bore design
- Modular and reusable
- Optimizes cleaning and maintenance operations
- Large chemical compatibility (see chemical compatibility chart)
- Connectors individually packaged in sealed plastic bags.

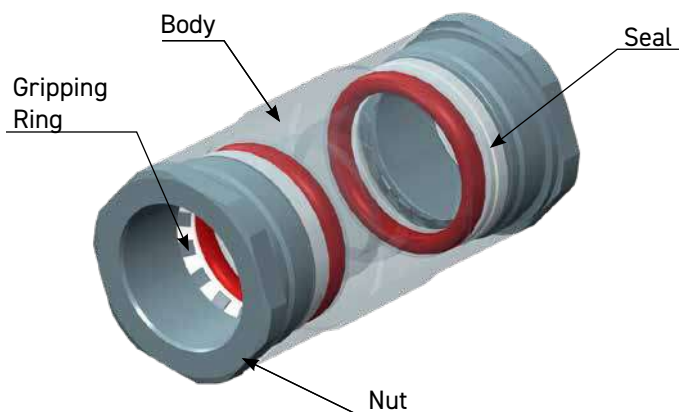

### WARNING

This product can expose you to chemicals including Lead and Lead Compounds which is known to the State of California to cause cancer and birth defects or other reproductive harm. For more information go to [www.P65Warnings.ca.gov](http://www.P65Warnings.ca.gov)

## Instructions for Assembly and Disassembly of a Stainless Steel Drop

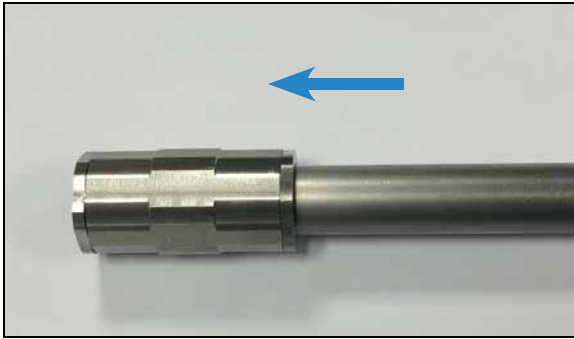

**Assembly:** simply push the pipe into the fitting.



**Disassembly:** 1. Manually unscrew the nut and slide the nut along the pipe.



**Disassembly :** 2. Put the red dismounting ring on the pipe and re-screw the nut on the fitting.

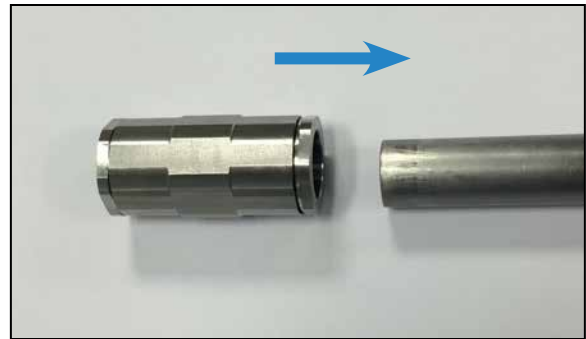

**Disassembly :** 3. Pull the pipe from the fitting.

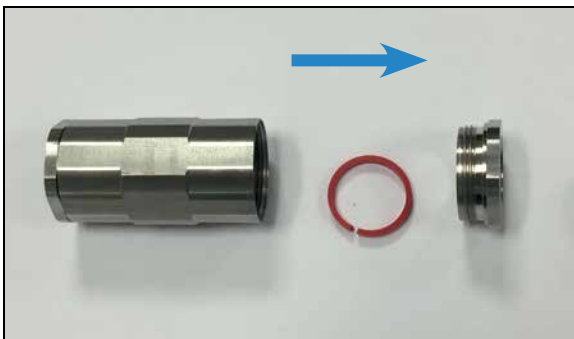

**Disassembly :** 4. Manually unscrew the nut and remove the red dismounting ring.

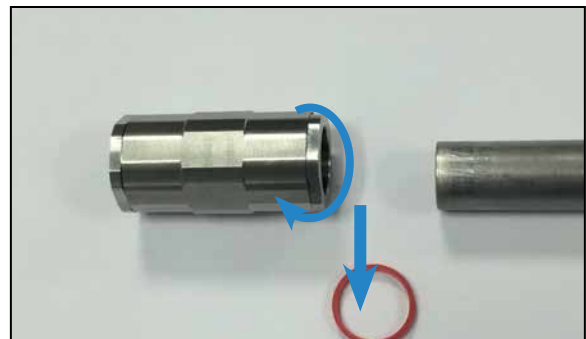

**Disassembly :** 5. Re-screw the nut on the fitting without the red ring; it is ready for assembly.



### WARNING

This product can expose you to chemicals including Lead and Lead Compounds which is known to the State of California to cause cancer and birth defects or other reproductive harm. For more information go to [www.P65Warnings.ca.gov](http://www.P65Warnings.ca.gov)

These components can quickly and easily connect to existing Transair aluminum or stainless steel systems with threaded drop brackets.

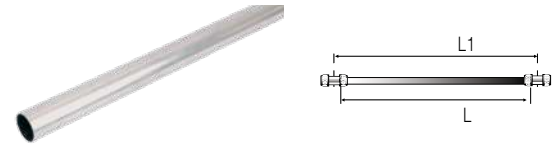

### 316L Stainless Steel Pipe

Part No.	OD (in)	OD (mm)	Nominal Length (ft)	Material	WT (lb)
TF16 N7 00	3/4	22	20	316L	8.2

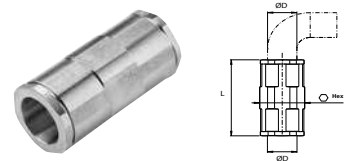

### 316L Union Connector

Part No.	OD (in)	OD (mm)	Hex Size (in)	L (in)	WT (lb)
RF06 N7 02	3/4	22	1.26	2.66	0.5



### 316L Bent Pipe 90° Elbow

Part No.	OD (in)	OD (mm)	L (in)	L1 (in)	L2 (in)	WT (lb)
RF02 N7 00	3/4	22	7.48	7.05	4.86	0.6

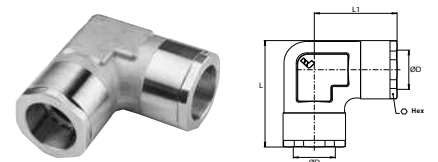

### 316L 90° Elbow

Part No.	OD (in)	OD (mm)	Hex Size (in)	L (in)	L1 (in)	WT (lb)
RF02 N7 02	3/4	22	1.22	2.36	1.73	0.66



#### WARNING

This product can expose you to chemicals including Lead and Lead Compounds which is known to the State of California to cause cancer and birth defects or other reproductive harm. For more information go to [www.P65Warnings.ca.gov](http://www.P65Warnings.ca.gov)

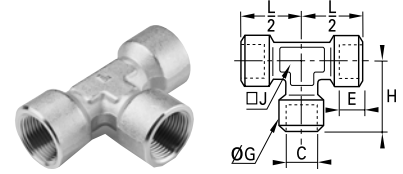

### 316L Female NPT Threaded Equal Tee

Part No.	Thd Size (in)	E (in)	G (in)	H (in)	J (in)	L (in)	WT (LB)
RF04 06N00	3/4	0.65	1.3	1.71	0.87	1.71	0.67

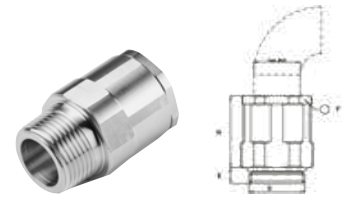

### 316L Male NPT Threaded Adapter

Part No.	OD (in)	OD (mm)	Thd Size (in)	E (in)	F (in)	H (in)	WT (LB)
RF05 N7N06	3/4	22	3/4	0.3	1.22	1.34	0.26

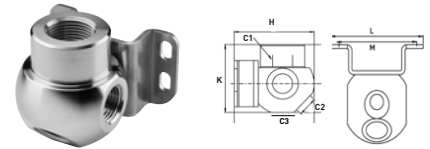

### 316L Female NPT Threaded 3 Port Wall Bracket

Part No.	Thd Size (in)	C2 (in)	C3 (in)	H (in)	K (in)	L (in)	M (in)	WT (LB)
RF36 06N04	3/4	1/2	1/4	2.99	2.6	3.23	2.6	1.64



This product can expose you to chemicals including Lead and Lead Compounds which is known to the State of California to cause cancer and birth defects or other reproductive harm. For more information go to [www.P65Warnings.ca.gov](http://www.P65Warnings.ca.gov)

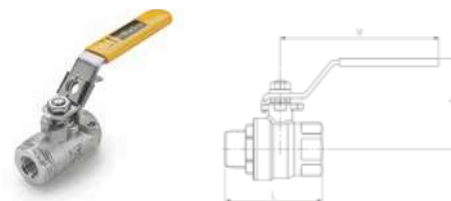

### 316L Female NPT Threaded Ball Valve

Part No.	Thd Size (in)	L (in)	Seal	WT (LB)
VP502SS-12	3/4	6.67	PTFE	1.57



### 316L Male NPT Plug

Part No.	Thd Size (in)	Application
EF27 00N04	1/2	Threaded ports on RF36 06N04
0205 14 00	1/4	Drain port on RF36 06N04



### 316L Pipe Hanger

Part No.	OD (in)	OD (mm)	Thd Size (in)
EX01 N7 01	3/4	22	3/8-16



### Dismounting Ring

Part No.	OD (in)	OD (mm)
EW11 N7 00	3/4	22



#### WARNING

This product can expose you to chemicals including Lead and Lead Compounds which is known to the State of California to cause cancer and birth defects or other reproductive harm. For more information go to [www.P65Warnings.ca.gov](http://www.P65Warnings.ca.gov)





# COMPRESSED AIR TREATMENT & SAFETY

# PNEUMATIC LOCKOUT VALVES

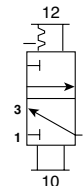

## Features:

- Used for compliance with OSHA 29 CFR part 1910
- 1/2" to 2" NPT pipe sizes
- Yellow cast aluminum body with red handle
- Inline or surface mountable
- Built in port for pressure verification to meet ANSI B11 and PMMI B155 requirements

## Material Specifications:

Description	FLV
Body	Cast Aluminum Alloy
Handle	Plastic
Spool	Aluminum
Seals	Carboxylated Nitrile
Detent Spring	Stainless Steel
Grease	Magnalube G*

\* Trademark Magnalube

## Operating Information:

Inlet Operating Pressure	FLV
Standard	15 to 300 PSI
High Flow	15 to 300 PSI
Operating Temperature	+40°F to +175°F
Operating Media	clean, dry, compressed air (5 micron)

## Flow Capacity:

Standard FLV Series	Port In/Out (in)	scfm In/Out	Port Exh (in)	scfm Exh
FLV4N6B	1/2	161.4	3/4	90.9
FLV6N6B	3/4	187.7	3/4	93.2
FLV6NAB	3/4	297.7	1 1/4	204
FLV8NAB	1	375	1 1/4	216

High Flow FLV Series	Port In/Out (in)	scfm In/Out	Port Exh (in)	scfm Exh
FLVBNCB	1 1/2	761.4	2	1156
FLVCNCB	2	918.2	2	1186



### WARNING

This product can expose you to chemicals including Lead and Lead Compounds which is known to the State of California to cause cancer and birth defects or other reproductive harm. For more information go to [www.P65Warnings.ca.gov](http://www.P65Warnings.ca.gov)

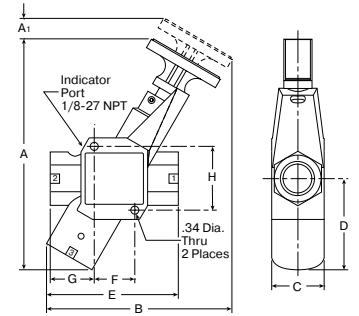

### FLV Standard Pneumatic Lockout Valves

Part No.	Port In/Out (in)	Port Exh (in)	A (in)	A1 (in)	B (in)	C (in)	D (in)	E (in)	F (in)	G (in)	H (in)
FLV4N6B	1/2	3/4	8.32	.64	6.60	2.00	3.06	4.24	1.32	1.56	2.21
FLV6N6B	3/4	3/4	8.32	.64	6.60	2.00	3.06	4.24	1.32	1.56	2.21
FLV6NAB	3/4	1 1/4	9.91	.85	7.95	2.25	3.91	5.65	1.74	1.89	2.74
FLV8NAB	1	1 1/4	9.91	.85	7.95	2.25	3.91	5.65	1.74	1.89	2.74

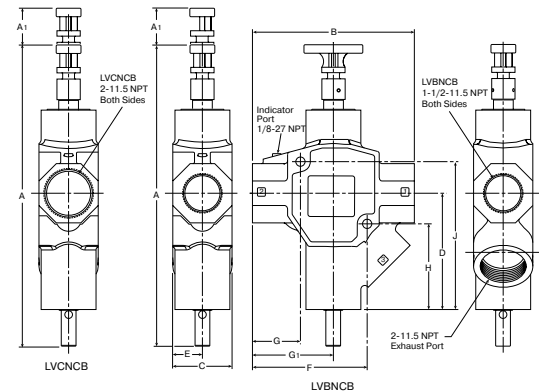

### FLV High Flow Pneumatic Lockout Valves

Part No.	Port In/Out (in)	Port Exh (in)	A (in)	A1 (in)	B (in)	C (in)	D (in)	E (in)	F (in)	G (in)	G1 (in)	H (in)	J (in)
FLVBNCB	1 1/2	2	14.82	1.87	8.20	3.00	5.89	1.50	5.81	2.43	4.10	4.34	7.49
FLVCNCB	2	2	14.82	1.87	8.20	3.00	5.89	1.50	5.81	2.43	4.10	4.34	7.49

### ES Silencers High Flow



Part No.	Pipe Size	Flow (scfm)	Hex (in)	Length (in)
FES75MC	3/4	893	1.62	4.56
FES125MC	1 1/4	1486	-	5.69
FES200MC	2	1580	2.99	7.68



### Pressure Indicators Pop-Up

Part No.	Material
F988A30	Brass



**WARNING**

This product can expose you to chemicals including Lead and Lead Compounds which is known to the State of California to cause cancer and birth defects or other reproductive harm. For more information go to [www.P65Warnings.ca.gov](http://www.P65Warnings.ca.gov)

# MODULAR PARTICULATE FILTERS

- Integral 1/2", 3/4" or 1 NPT ports
- High efficiency 5 micron element as standard
- Excellent water removal efficiency
- Robust but lightweight aluminum construction
- Positive bayonet latch to ensure correct & safe fitting

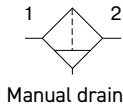

Manual drain

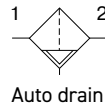

Auto drain



## Material Specifications:

Body, Metal Bowl	Aluminum
Body Cap	ABS
Element Retainer/Baffle	Acetal
Filter Element	Sintered Polyethylene
Seals	Nitrile
Sight Gauge	Nylon (FP32 and FP33) Polypropylene (FP3Y)
Drains: Manual Automatic	Acetal (FP3Y) PA / Ø 10mm brass connection (FP3Y)

## Operating Information:

Supply pressure (max) Metal Bowl	<b>FP32 (Compact)</b> 250 PSIG (17 bar)	<b>FP33 (Standard)</b> 250 PSIG (17 bar)	<b>FP3Y (High-Flow)</b> 254 PSIG (17.5 bar)
Operating Temperature Metal Bowl	-13°F to +150°F (-25°C to +65.5°C)	-13°F to +150°F (-25°C to +65.5°C)	+14°F to +140°F (-10°C to +60°C)
Standard Filtration	5 micron	5 micron	5 micron
Flow Capacity* 1/2 3/4 1	80 SCFM (18 dm <sup>3</sup> /S) - -	85 SCFM (40 dm <sup>3</sup> /S) 102 SCFM (48 dm <sup>3</sup> /S) -	252 SCFM (119 dm <sup>3</sup> /S) 252 SCFM (119 dm <sup>3</sup> /S) 252 SCFM (119 dm <sup>3</sup> /S)

\*Inlet pressure 91.3 PSIG (6.3 bar), pressure drop 4.9 PSIG (0.34 bar).



### WARNING

This product can expose you to chemicals including Lead and Lead Compounds which is known to the State of California to cause cancer and birth defects or other reproductive harm. For more information go to [www.P65Warnings.ca.gov](http://www.P65Warnings.ca.gov)

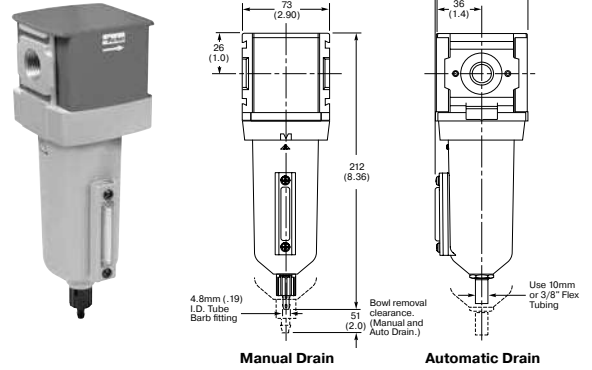
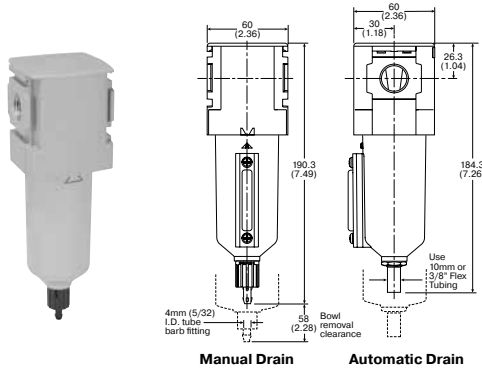

### FP32 Compact Particulate Filter

Part No.	Port Size (in)	Metal Bowl/ Drain Type
FP32FB94ESMN	1/2	Manual
FP32FB94ESAN	1/2	Auto

### FP33 Standard Particulate Filter

Part No.	Port Size (in)	Metal Bowl/ Drain Type
FP33FA94ESMN	1/2	Manual
FP33FA94ESAN	1/2	Auto
FP33FA96ESMN	3/4	Manual
FP33FA96ESAN	3/4	Auto

P32FB 1/2" Filter

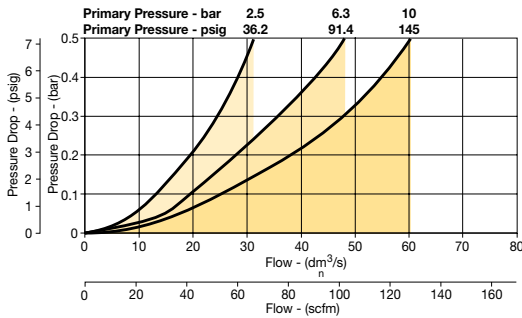

P33FA 1/2" Filter

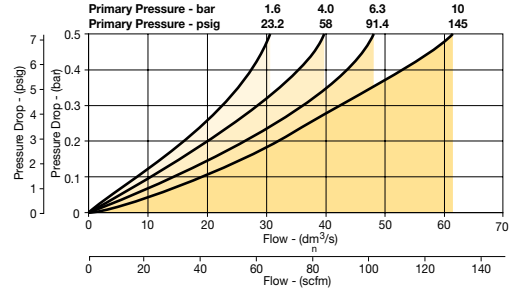

P33FA 3/4" Filter

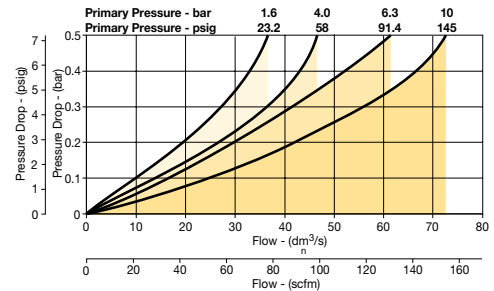

**WARNING**

This product can expose you to chemicals including Lead and Lead Compounds which is known to the State of California to cause cancer and birth defects or other reproductive harm. For more information go to [www.P65Warnings.ca.gov](http://www.P65Warnings.ca.gov)

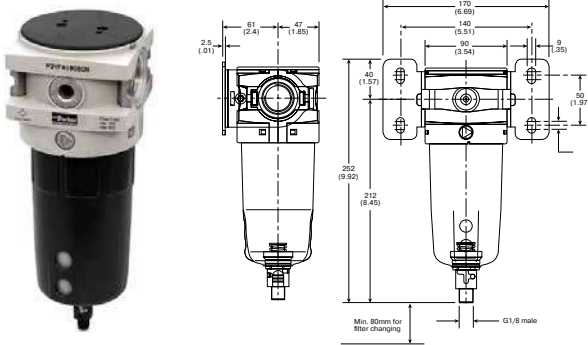

## FP3Y High-Flow Particulate Filter

Part No.	Port Size (in)	Metal Bowl/ Drain Type
FP3YFA96ESCN	3/4	Manual
FP3YFA96ESAN	3/4	Auto
FP3YFA98ESAN	1	Manual
FP3YFA98ESAN	1	Auto

### (3/4") Filter

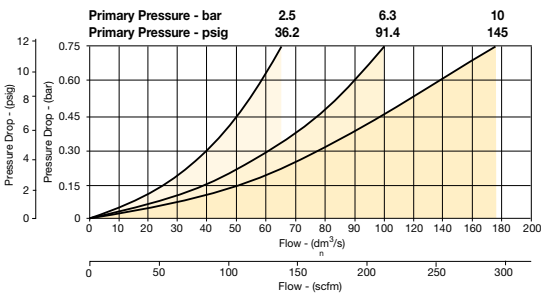

### (1") Filter

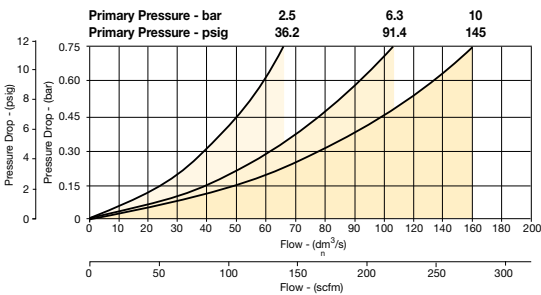

### WARNING

This product can expose you to chemicals including Lead and Lead Compounds which is known to the State of California to cause cancer and birth defects or other reproductive harm. For more information go to [www.P65Warnings.ca.gov](http://www.P65Warnings.ca.gov)

# MODULAR COALESCING FILTERS

- Integral 1/2", 3/4" or 1 NPT ports
- Removes liquid aerosols and sub micron particles
- Oil free air for critical applications, such as air gauging, pneumatic instrumentation and control
- Positive bayonet latch to ensure correct & safe fitting



**Note:** To optimize the life of coalescing element, it is advisable to install a pre-filter with a 5 micron element upstream of the coalescing filter. To optimize the life of an Adsorber, if used, it is advisable to install a Coalescing Filter upstream of the Adsorber. Adsorber element should be replaced approximately every 1000 hours of service.



## Material Specifications:

Body, Metal Bowl	Aluminum
Body Cap	ABS (FP33)
Filter Cover	ABS (FPY3)
Element Retainer/Baffle	Acetal
Filter Element	Sintered Polyethylene

Seals	Nitrile
Sight Gauge	Nylon (FP32 and FP33) Polypropylene (FP3Y)
Drains: Manual Automatic	Acetal (FP3Y) PA / Ø 10mm brass connection (FP3Y)

## Operating Information:

Supply pressure (max) Metal Bowl	<b>FP32 (Compact)</b> 150 PSIG (10 bar)	<b>FP33 (Standard)</b> 150 PSIG (10 bar)	<b>FP3Y (High-Flow)</b> 254 PSIG (17.5 bar)
Operating Temperature Metal Bowl	-13°F to +150°F (-25°C to +65.5°C)	-13°F to +150°F (-25°C to +65.5°C)	+14°F to +140°F (-10°C to +60°C)
Standard Filtration	0.01 micron	0.01 micron	0.01 micron
Energy Efficient Flow*	23 SCFM (11 dm <sup>3</sup> /s)	42 SCFM (20 dm <sup>3</sup> /s)	104 SCFM (49 dm <sup>3</sup> /s)
Maximum Flow**	38 SCFM (28 dm <sup>3</sup> /s)	72 SCFM (34 dm <sup>3</sup> /s)	120 SCFM (59 dm <sup>3</sup> /s)

\*Inlet pressure 91.3 PSIG (6.3 bar), pressure drop 3 PSIG (0.2 bar) saturated element.

\*\*Inlet pressure 91.3 PSIG (6.3 bar), pressure drop 6 PSIG (0.4 bar) saturated element.



### WARNING

This product can expose you to chemicals including Lead and Lead Compounds which is known to the State of California to cause cancer and birth defects or other reproductive harm. For more information go to [www.P65Warnings.ca.gov](http://www.P65Warnings.ca.gov)

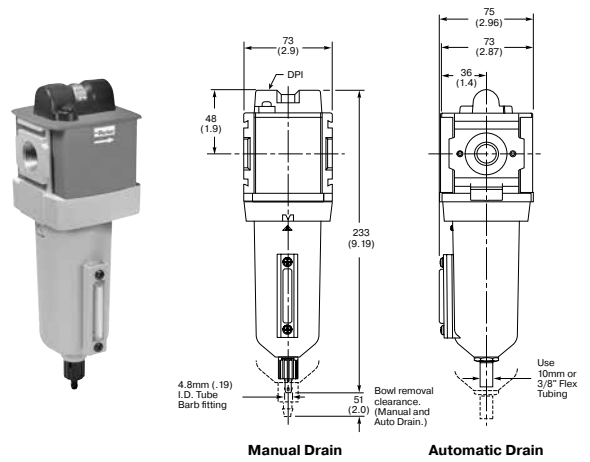
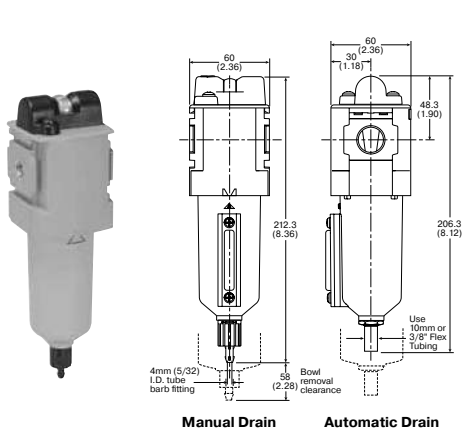

### FP32 Compact Coalescing and Adsorber Filter

Part No.	Port Size (in)	Metal Bowl/ Drain Type
FP32FB94DSMN	1/2	Manual
FP32FB94DSAN	1/2	Auto

### FP33 Standard Coalescing and Adsorber Filter

Part No.	Port Size (in)	Metal Bowl/ Drain Type
FP33FA94DSMN	1/2	Manual
FP33FA94DSAN	1/2	Auto
FP33FA96DSMN	3/4	Manual
FP33FA96DSAN	3/4	Auto

P32FB - 0.01 micron flow

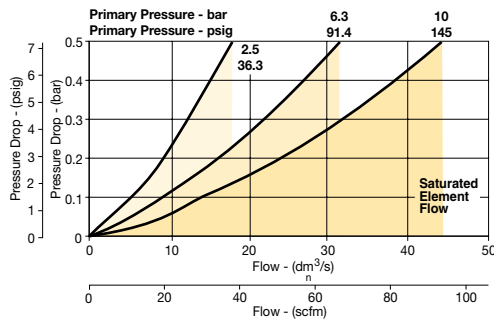

P33FA - 0.01 micron flow

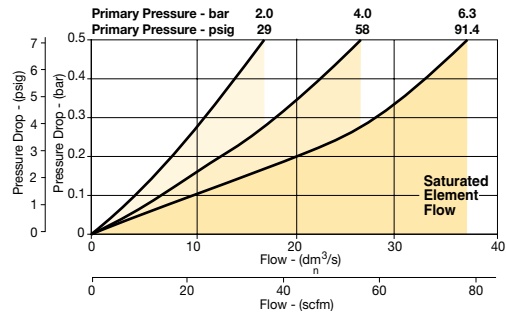

**WARNING**

This product can expose you to chemicals including Lead and Lead Compounds which is known to the State of California to cause cancer and birth defects or other reproductive harm. For more information go to [www.P65Warnings.ca.gov](http://www.P65Warnings.ca.gov)

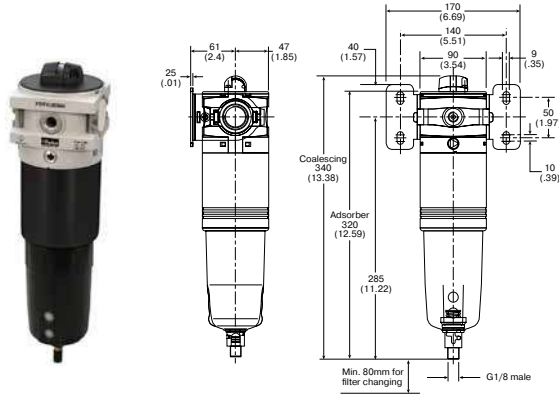

## FP3Y High-Flow Coalescing Filter

Part No.	Port Size (in)	Metal Bowl/ Drain Type
FP3YFA96DSCN	3/4	Manual
FP3YFA96DSAN	3/4	Auto
FP3YFA98DSCN	1	Manual
FP3YFA98DSAN	1	Auto

### (3/4") 0.01 Micron Coalescing Filter Saturated

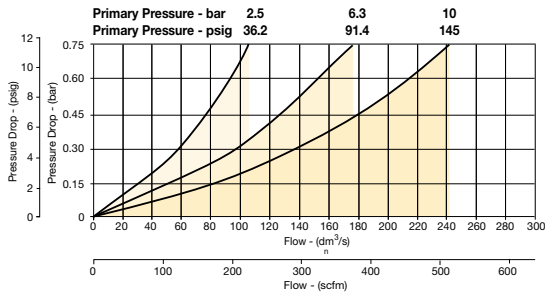

### (1") 0.01 Micron Coalescing Filter Saturated

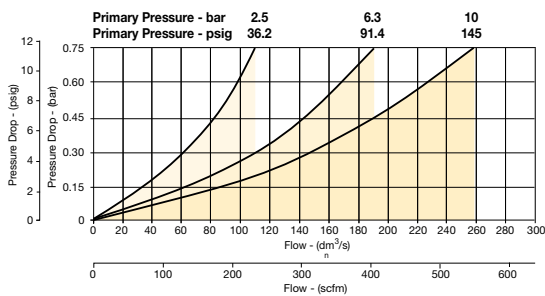

### WARNING

This product can expose you to chemicals including Lead and Lead Compounds which is known to the State of California to cause cancer and birth defects or other reproductive harm. For more information go to [www.P65Warnings.ca.gov](http://www.P65Warnings.ca.gov)

# MODULAR REGULATORS

- Integral 1/2", 3/4" or 1 NPT ports
- Robust but lightweight aluminum construction
- Secondary pressure ranges 0-30 PSIG (0-2 bar), 0-60 PSIG (0-4 bar), 0-125 PSIG (0-8 bar), 0-250 PSIG (0-17 bar)
- Secondary aspiration plus balanced poppet provides quick response and accurate pressure regulation
- Relieving
- Non-rising knob

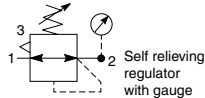

## Material Specifications:

Body	Aluminum
Adjustment Knob	Acetal (FP32 and FP33) Glass-filled Polyamide (FP3Y)
Body Cap	ABS
Bonnet	33% Glass-filled Nylon (FP32 and FP33) Glass-filled Polyamide (FP3Y)
Diaphragm Assembly	Nitrile / Zinc (FP32 and FP33)

## Operating Information:

Supply pressure (max)	FP32 (Compact) 300 PSIG (20 bar)	FP33 (Standard) 300 PSIG (20 bar)	FP3Y (High-Flow) 254 PSIG (17.5 bar)
Operating Temperature	-13°F to +150°F (-25°C to +65.5°C)	-13°F to +150°F (-25°C to +65.5°C)	-40°F to +140°F (-40°C to +60°C)**
Flow Capacity*	1/2 165 SCFM (78 dm <sup>3</sup> /S)	233 SCFM (110 dm <sup>3</sup> /S)	-
	3/4 -	233 SCFM (110 dm <sup>3</sup> /S)	-
	1 -	-	680 SCFM (321 dm <sup>3</sup> /S)

\*Inlet pressure 145 PSIG (10 bar), pressure drop 91.3 PSIG (6.3 bar) saturated element.

\*\*Air supply must be dry enough to avoid ice formation at temperatures below 35.6°F (2°C).



### ⚠ WARNING

Product rupture can cause serious injury.  
Do not connect regulator to bottled gas.  
Do not exceed maximum primary pressure rating.

## CAUTION:

### REGULATOR PRESSURE ADJUSTMENT -

The working range of knob adjustment is designed to permit outlet pressures within their full range. Pressure adjustment beyond this range is also possible because the knob is not a limiting device. This is a common characteristic of most industrial regulators, and limiting devices may be obtained only by special design.

For best performance, regulated pressure should always be set by increasing the pressure up to the desired setting.

Bottom Plug	33% Glass-filled Nylon (FP32)
Valve Assembly	Brass / Nitrile (FP32) Brass / Nitrile / Acetal (FP33) Brass / NBR (FP3Y)
Springs	Steel S.S. (FP32 and FP33)
Seals	Nitrile / Zinc (FP32 and FP33) Nitrile / NBR (FP3Y)
Screws	Nitrile / NBR (FP3Y)
Panel Nut	Acetal (FP32 and FP33)



### WARNING

This product can expose you to chemicals including Lead and Lead Compounds which is known to the State of California to cause cancer and birth defects or other reproductive harm. For more information go to [www.P65Warnings.ca.gov](http://www.P65Warnings.ca.gov)

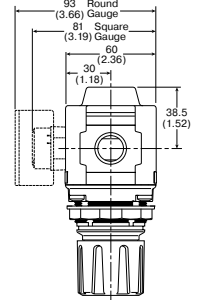
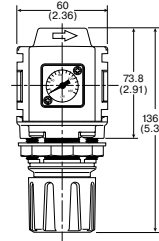

## FP32 Compact Regulator

Part No.	Port Size (in)	Reliving Pressure (PSI)	Reliving Pressure (BAR)	Gauge
FP32RB94BNGP	1/2	125	8	Round

NOTE: 48 mm (1.90 in.) hole required for panel nut mounting.

### P32RB 1/2" Regulator

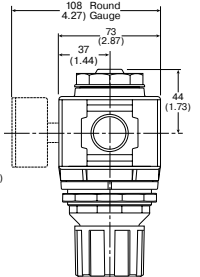
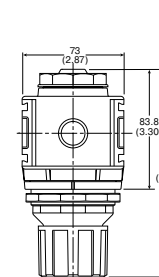
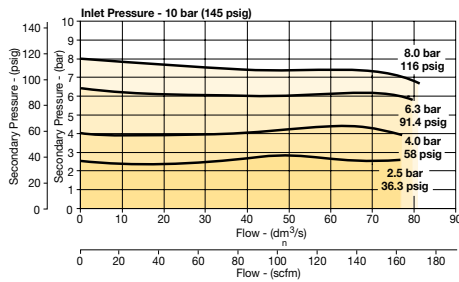

## FP33 Standard Regulator

Part No.	Port Size (in)	Reliving Pressure (PSI)	Reliving Pressure (BAR)	Gauge
FP33RA94BNGP	1/2	125	8	Round
FP33RA96BNGP	3/4	125	8	Round

NOTE: 61 mm (2.40 in.) hole required for panel nut mounting.

### P33RA 1/2" Regulator

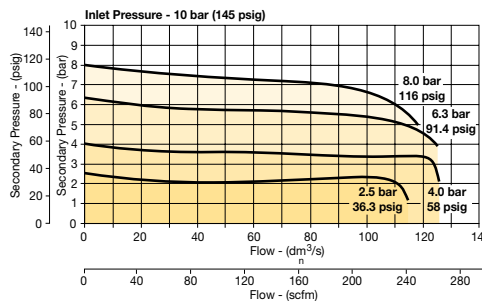

### P33RA 3/4" Regulator

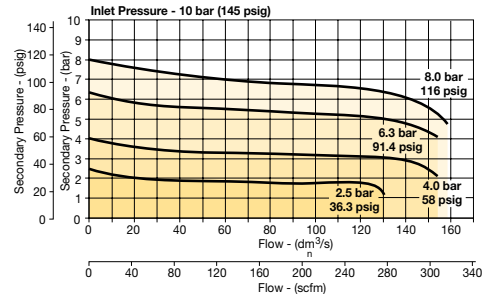

**WARNING**

This product can expose you to chemicals including Lead and Lead Compounds which is known to the State of California to cause cancer and birth defects or other reproductive harm. For more information go to [www.P65Warnings.ca.gov](http://www.P65Warnings.ca.gov)

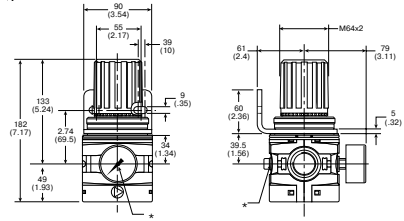

## FP3Y High-Flow Regulator

Part No.	Port Size (in)	Relieving Pressure (PSI)	Relieving Pressure (BAR)	Gauge
FP3YRA96BNFN	3/4	145	10	Round
FP3YRA98BNFN	1	145	10	Round

**(3/4") Regulator**

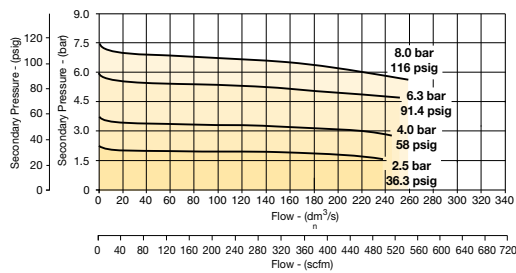

**(1") Regulator**

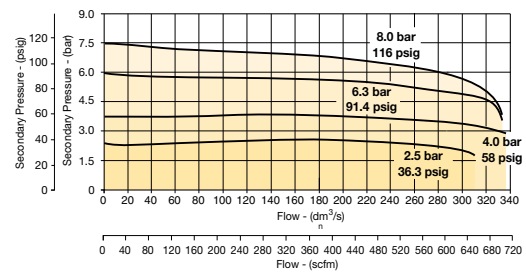

**WARNING**

This product can expose you to chemicals including Lead and Lead Compounds which is known to the State of California to cause cancer and birth defects or other reproductive harm. For more information go to [www.P65Warnings.ca.gov](http://www.P65Warnings.ca.gov)

# MODULAR FILTERS/ REGULATORS

- Integral 1/2", 3/4" or 1 NPT ports
- High efficiency 5 micron element as standard
- Excellent water removal efficiency
- Robust but lightweight aluminum construction
- Positive bayonet latch to ensure correct & safe fitting
- Secondary pressure ranges 0-30 PSIG (0-2 bar), 0-60 PSIG (0-4 bar), 0-125 PSIG (0-8 bar), 0-250 PSIG (0-17 bar)
- Secondary aspiration plus balanced poppet provides quick response and accurate pressure regulation

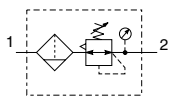

## Material Specifications:

Seals	Nitrile
Springs	Steel
Valve Assembly	Brass / Nitrile (FP32 and FP33) Brass / NBR (FP3Y)

**⚠ WARNING**

**Product rupture can cause serious injury.  
Do not connect regulator to bottled gas.  
Do not exceed maximum primary pressure rating.**

## CAUTION:

### REGULATOR PRESSURE ADJUSTMENT -

The working range of knob adjustment is designed to permit outlet pressures within their full range. Pressure adjustment beyond this range is also possible because the knob is not a limiting device. This is a common characteristic of most industrial regulators, and limiting devices may be obtained only by special design.

For best performance, regulated pressure should always be set by increasing the pressure up to the desired setting.

Diaphragm Assembly	Nitrile / Zinc (FP32 and FP33)
Panel Nut	Acetal
Sight Gauge	Nylon (FP32 and FP33), Polypropylene (FP3Y)

## Operating Information:

Supply pressure (max) Metal Bowl	<b>FP32 (Compact)</b> 250 PSIG (17 bar)	<b>FP33 (Standard)</b> 250 PSIG (17 bar)	<b>FP3Y (High-Flow)</b> 254 PSIG (17.5 bar)
Operating Temperature Metal Bowl	-13°F to +150°F (-25°C to +65.5°C)	-14°F to +150°F (-25°C to +65.5°C)	-40°F to +140°F (-40°C to +60°C)**
Standard Filtration	5 micron	5 micron	5 micron
Flow Capacity* 1/2 3/4 1	136 SCFM (64 dm <sup>3</sup> /S) - -	210 SCFM (99 dm <sup>3</sup> /S) 230 SCFM (108 dm <sup>3</sup> /S) -	- - 502 SCFM (237 dm <sup>3</sup> /S)

\*Inlet pressure 145 PSIG (10 bar). Secondary pressure drop 91.3 PSIG (6.3 bar).

\*\*Air supply must be dry enough to avoid ice formation at temperatures below 35.6°F (2°C).



### WARNING

This product can expose you to chemicals including Lead and Lead Compounds which is known to the State of California to cause cancer and birth defects or other reproductive harm. For more information go to [www.P65Warnings.ca.gov](http://www.P65Warnings.ca.gov)

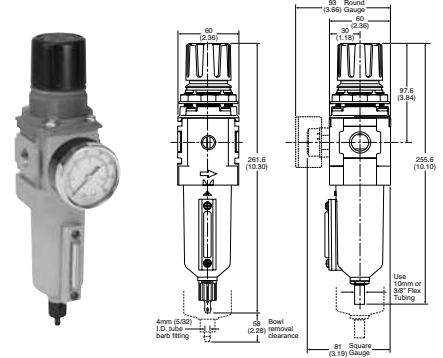

## FP32 Compact Filter / Regulator

Part No.	Port Size (in)	Relieving Pressure		Filter Type	Filtration Rating	Metal Bowl/ Drain Type
		PSI	BAR			
FP32EB94ESMBNGP	1/2	125	8	Particulate	5 micron	Manual
FP32EB94ESABNGP	1/2	125	8	Particulate	5 micron	Auto

### P32EB 1/2" Filter/Regulator

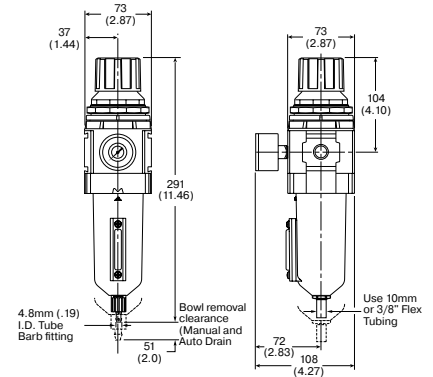
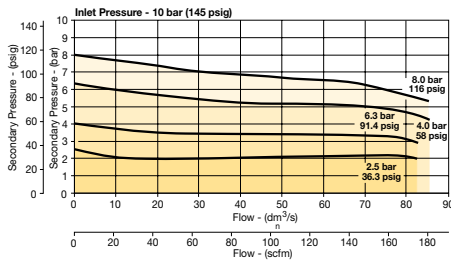

## FP33 Standard Filter / Regulator

Part No.	Port Size (in)	Relieving Pressure		Filter Type	Filtration Rating	Metal Bowl/ Drain Type
		PSI	BAR			
FP33EA94ESMBNGP	1/2	125	8	Particulate	5 micron	Manual
FP33EA94ESABNGP	1/2	125	8	Particulate	5 micron	Auto
FP33EA96ESMBNGP	3/4	125	8	Particulate	5 micron	Manual
FP33EA96ESABNGP	3/4	125	8	Particulate	5 micron	Auto

### P33EA 1/2" Filter / Regulator

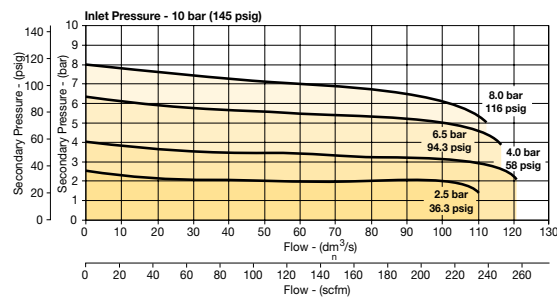

### P33EA 3/4" Filter/Regulator

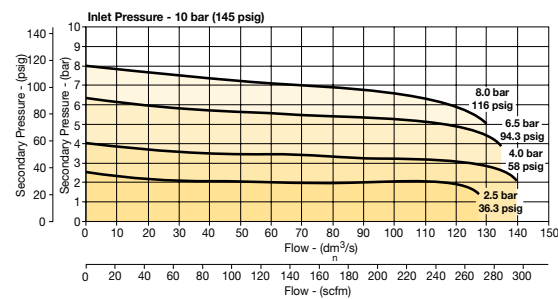

**WARNING**

This product can expose you to chemicals including Lead and Lead Compounds which is known to the State of California to cause cancer and birth defects or other reproductive harm. For more information go to [www.P65Warnings.ca.gov](http://www.P65Warnings.ca.gov)

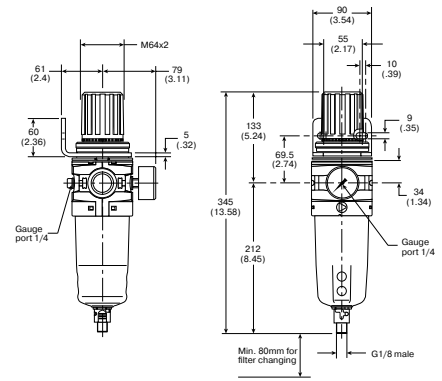

## FP3Y High-Flow Filter / Regulator

Part No.	Port Size (in)	Relieving Pressure		Filter Type	Filtration Rating	Metal Bowl/ Drain Type
		PSI	BAR			
FP3YEA96ESCBNFN	3/4	125	8	Particulate	5 micron	Manual/Semi Auto
FP3YEA96ESABNFN	3/4	125	8	Particulate	5 micron	Auto
FP3YEA98ESCBNFN	1	125	8	Particulate	5 micron	Manual/Semi Auto
FP3YEA98ESABNFN	1	125	8	Particulate	5 micron	Auto

**(3/4") 5 Micron Filter / Regulator**

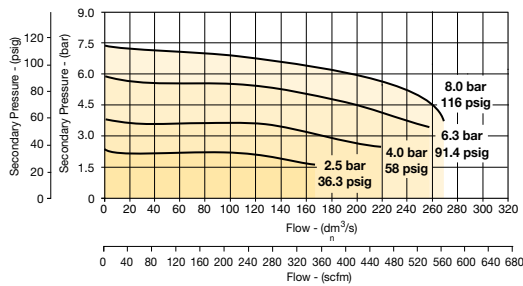

**(1") 5 Micron Filter / Regulator**

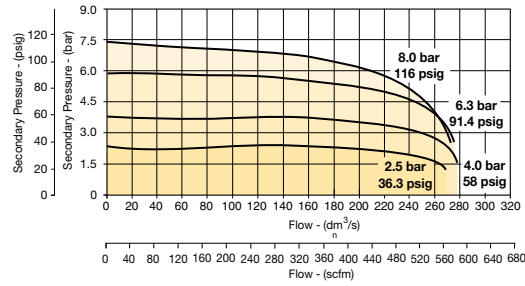

**WARNING**

This product can expose you to chemicals including Lead and Lead Compounds which is known to the State of California to cause cancer and birth defects or other reproductive harm. For more information go to [www.P65Warnings.ca.gov](http://www.P65Warnings.ca.gov)

# MODULAR LUBRICATORS



- Integral 1/2", 3/4" or 1 NPT ports
- Robust but lightweight aluminum construction
- Proportional oil delivery over a wide range of air flows
- Finger tip ratchet control for precise oil drip rate adjustment

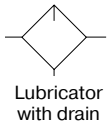

## Material Specifications:

Body, Metal Bowl	Aluminum
Body Cap	ABS
Seals	Nitrile
Sight Dome	Nylon (FP32 and FP33) Polyamide (FP3Y)
Sight Gauge	Polycarbonate (FP32 and FP33) Polypropylene (FP3Y)

Suggested Lubricant	ISO/ASTM VG 32 (FP32 and FP33)
Pick-up Filter	Sintered Bronze (FP32 and FP33)
Top & Bottom End Cap	Glass-filled Nylon (FP3Y)
Bayonet Support	Nylon (FP3Y)

## Operating Information:

Supply pressure (max) Metal Bowl	<b>FP32 (Compact)</b> 250 PSIG (17 bar)	<b>FP33 (Standard)</b> 250 PSIG (17 bar)	<b>FP3Y (High-Flow)</b> 254 PSIG (17.5 bar)
Operating Temperature Metal Bowl	+14°F to +150°F (-10°C to +65.5°C)	+14°F to +150°F (-10°C to +65.5°C)	+14°F to +140°F (-10°C to +60°C)**
Flow Capacity* 1/2 3/4 1	90 SCFM (42 dm3/S) – –	110 SCFM (52 dm3/S) 150 SCFM (71 dm3/S) –	– 343 SCFM (162 dm3/S) 390 SCFM (184 dm3/S)

\*Inlet pressure 91.3 PSIG (6.3 bar), pressure drop 4.9 PSIG (0.34 bar).

\*\*Air supply must be dry enough to avoid ice formation at temperatures below 35.6°F (2°C).

Low flow start point (lubrication pick-up): at 91.4 PSIG (6.3 bar) inlet pressure 1.1 SCFM (0.5 dm3/s).

Typical flow with 91.4 PSIG (6.3 bar) inlet pressure and 10.2 PSIG (0.7 bar) pressure drop: 390 SCFM (184 dm3/s).



This product can expose you to chemicals including Lead and Lead Compounds which is known to the State of California to cause cancer and birth defects or other reproductive harm. For more information go to [www.P65Warnings.ca.gov](http://www.P65Warnings.ca.gov)

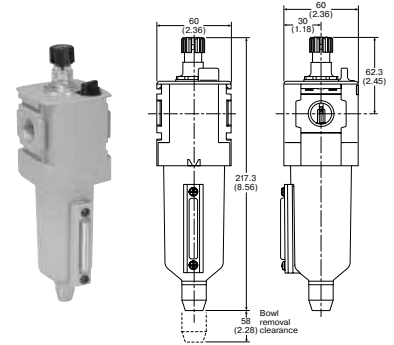

## FP32 Compact Lubricator

Part No.	Port Size (in)	Bowl Type	Type
FP32LB94LSNN	1/2	Metal/No Drain	Mist/Sight Gauge

### P32LB 1/2" Lubricator

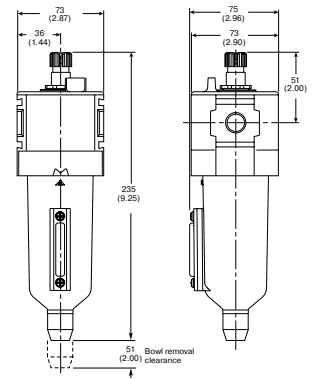
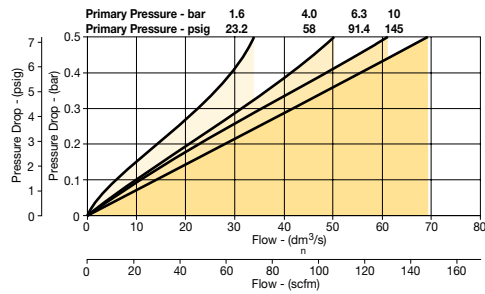

## FP33 Standard Lubricator

Part No.	Port Size (in)	Bowl Type	Type
FP33LA94LSNN	1/2	Metal/No Drain	Mist/Sight Gauge
FP33LA96LSNN	3/4	Metal/No Drain	Mist/Sight Gauge

### P33LA 1/2" Lubricator

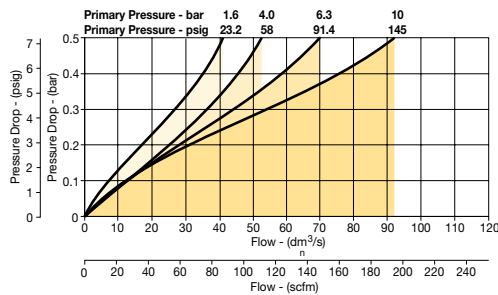

### P33LA 3/4" Lubricator

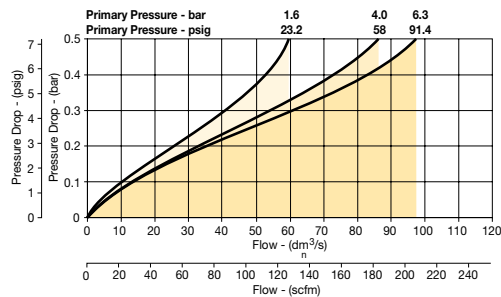

### WARNING

This product can expose you to chemicals including Lead and Lead Compounds which is known to the State of California to cause cancer and birth defects or other reproductive harm. For more information go to [www.P65Warnings.ca.gov](http://www.P65Warnings.ca.gov)

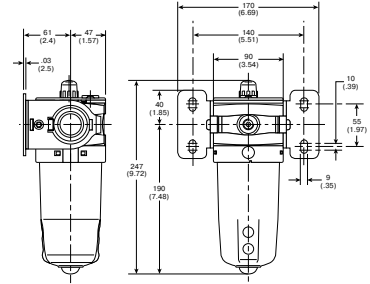

## FP3Y High-Flow Lubricator

Part No.	Port Size (in)	Bowl Type	Type
FP3YLA96LSNN	3/4	Metal/No Drain	Mist
FP3YLA98LSNN	1	Metal/No Drain	Mist

### (3/4") Lubricator

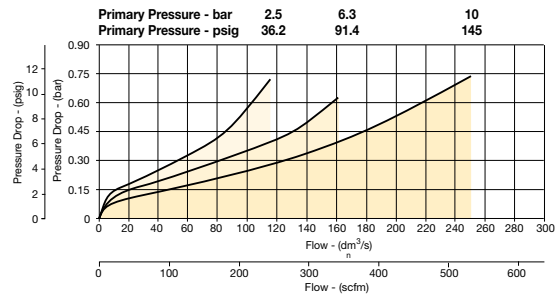

### (1") Lubricator

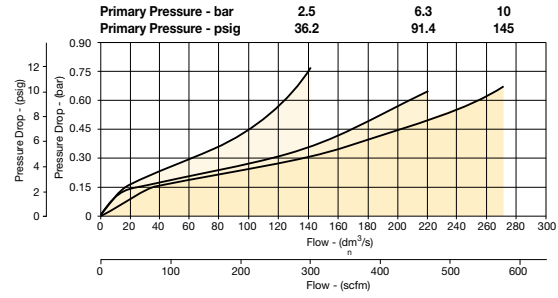

**WARNING**

This product can expose you to chemicals including Lead and Lead Compounds which is known to the State of California to cause cancer and birth defects or other reproductive harm. For more information go to [www.P65Warnings.ca.gov](http://www.P65Warnings.ca.gov)



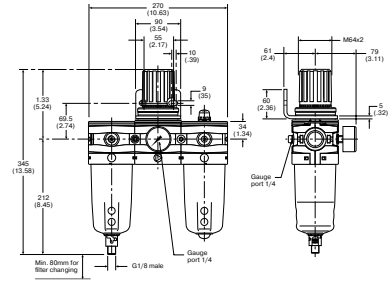

### FP3Y High-Flow Filter + Regulator + Lubricator

Part No.	Port Size (in)	Filter Type	Filtration Rating	Drain Type	Flow	
					SCFM	DM3/S
FP3YCB96SECNFLNF	3/4	Particulate	5 micron	Manual/Semi-auto	193	91
FP3YCB96SEANFLNF	3/4	Particulate	5 micron	Auto	193	91
FP3YCB98SECNFLNF	1	Particulate	5 micron	Manual/Semi-auto	369	174
FP3YCB98SEANFLNF	1	Particulate	5 micron	Auto	369	174

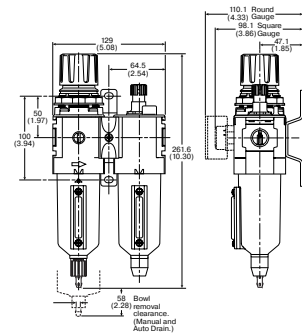

### FP32 Compact Filter / Regulator + Lubricator

Part No.	Port Size (in)	Filter Type	Filtration Rating	Drain Type	Flow	
					SCFM	DM3/S
FP32CA94SEMGNLW	1/2	Particulate	5 micron	Manual	90	43
FP32CA94SEANGLW	1/2	Particulate	5 micron	Auto	90	43



**WARNING**

This product can expose you to chemicals including Lead and Lead Compounds which is known to the State of California to cause cancer and birth defects or other reproductive harm. For more information go to [www.P65Warnings.ca.gov](http://www.P65Warnings.ca.gov)

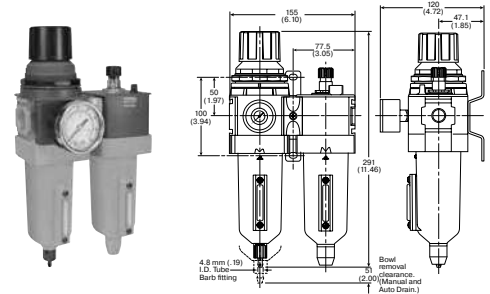

### FP33 Standard Filter / Regulator + Lubricator

Part No.	Port Size (in)	Filter Type	Filtration Rating	Drain Type	Flow	
					SCFM	DM3/S
FP33CA94SEMGLNW	1/2	Particulate	5 micron	Manual	110	52
FP33CA94SEANGLNW	1/2	Particulate	5 micron	Auto	110	52
FP33CA96SEMGLNW	3/4	Particulate	5 micron	Manual	150	71
FP33CA96SEANGLNW	3/4	Particulate	5 micron	Auto	150	71

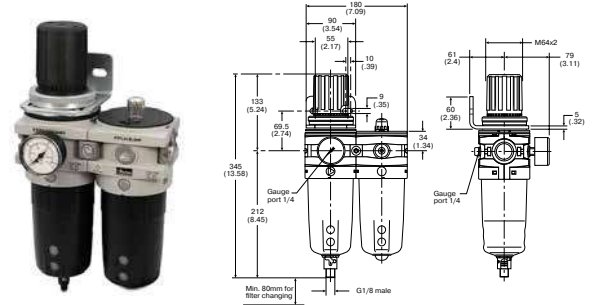

### FP3Y High-Flow Filter / Regulator + Lubricator

Part No.	Port Size (in)	Filter Type	Filtration Rating	Drain Type	Flow	
					SCFM	DM3/S
FP3YCA96SECNFLNF	3/4	Particulate	5 micron	Manual/Semi-auto	214	101
FP3YCA96SEANFLNF	3/4	Particulate	5 micron	Auto	214	101
FP3YCA98SECNFLNF	1	Particulate	5 micron	Manual/Semi-auto	356	168
FP3YCA98SEANFLNF	1	Particulate	5 micron	Auto	356	168



**WARNING**

This product can expose you to chemicals including Lead and Lead Compounds which is known to the State of California to cause cancer and birth defects or other reproductive harm. For more information go to [www.P65Warnings.ca.gov](http://www.P65Warnings.ca.gov)

# MODULAR ACCESSORIES / KITS



## Modular Ball Valve

Part No.	In / Out Port Size (in)	Model Type	Exhaust Port (in)	Thread Type	Flow	
					SCFM	dm3/s
FP32VB94LBNN	1/2	FP32	1/4	NPT	258.5	122
FP33VB94LBNN	1/2	FP33	1/2	NPT	561.5	265
FP33VB96LBNN	3/4	FP33	1/2	NPT	678	320
FP3YVA96LBN	3/4	FP3Y	1/4	NPT	705.6	333
FP3YVA98LBN	1	FP3Y	1/4	NPT	705.6	333



## Manifold Block

Part No.	In / Out Port Size (in)	Model Type	Auxiliary Port Size Top (in)	Auxiliary Port Size Bottom (in)	Thread Type	Front and Back
FP32MA94024N	1/2	FP32	1/4	1/2	NPT	-
FP33MA96024N	3/4	FP33	1/4	1/2	NPT	-
FP3YMA9V0N	1	FP3Y	1/8	1	NPT	1/4

## Panel Mount Plastic

Part No.	Series
FP32KA00MP	FP32
FP33KA00MP	FP33

## Panel Mount Nut Aluminum

Part No.	Series
FP32KA00MM	FP32
FP33KA00MM	FP33
FP3YKA00MM	FP3Y



### WARNING

This product can expose you to chemicals including Lead and Lead Compounds which is known to the State of California to cause cancer and birth defects or other reproductive harm. For more information go to [www.P65Warnings.ca.gov](http://www.P65Warnings.ca.gov)



### Neck Mounting Bracket Kit

Part No.	Series
FP3YKA00MS	FP3Y



### Wall Mounting Brackets (P)

Part No.	Series
FP3YKA00CW	FP3Y



### Angle Bracket / L-Bracket

Part No.	Model Type	Description
FP32KB00MR	FP32	Angle Bracket (Fits to Regulator and Filter / Regulator Body)
FP32KA00ML	FP32	L-bracket (Fits to Filter and Lubricator Body)
FP33KA00MR	FP33	Angle Bracket (Fits to Regulator and Filter / Regulator Body)
FP33KA00ML	FP33	L-bracket (Fits to Filter and Lubricator Body)



### Body Connecting Kit

Part No.	Series	Description
FP32KA00MT	FP32/FP33	T-bracket with Body Connector
FP32KA00CB	FP32	Body Connector
FP3YKA00CB	FP3Y	Body Connector



#### WARNING

This product can expose you to chemicals including Lead and Lead Compounds which is known to the State of California to cause cancer and birth defects or other reproductive harm. For more information go to [www.P65Warnings.ca.gov](http://www.P65Warnings.ca.gov)



### Port Block Kit

Part No.	Model type	Port Size (in)	Thread type
P32KA94CP	FP32/FP33	1/2	NPT
P32KA96CP	FP32/FP33	3/4	NPT
P32KA14CP	FP32/FP33	1/2	BSPP
P32KA16CP	FP32/FP33	3/4	BSPP
P3YKA9BCP	FP3Y	1 1/2	NPT



### Lubricator Oil (P)

Part No.	size
FF442001	1 qt
FF442002	1 gal



### Element Kit

Part No.	Series	Microns
FP32KA00ESE	FP32	5
FP33KA00ESE	FP33	5
FP3YKA00ESE	FP3Y	5
FP32KA00ESC	FP32	0.01
FP33KA00ESC	FP33	0.01
FP3YKA00ESC	FP3Y	0.01



### Regulator & Filter / Regulator Tamperproof Kit

Part No.
FP32KB00AL



### Tamperproof Knob Kit

Part No.
FP32KB00AT



**WARNING**

This product can expose you to chemicals including Lead and Lead Compounds which is known to the State of California to cause cancer and birth defects or other reproductive harm. For more information go to [www.P65Warnings.ca.gov](http://www.P65Warnings.ca.gov)

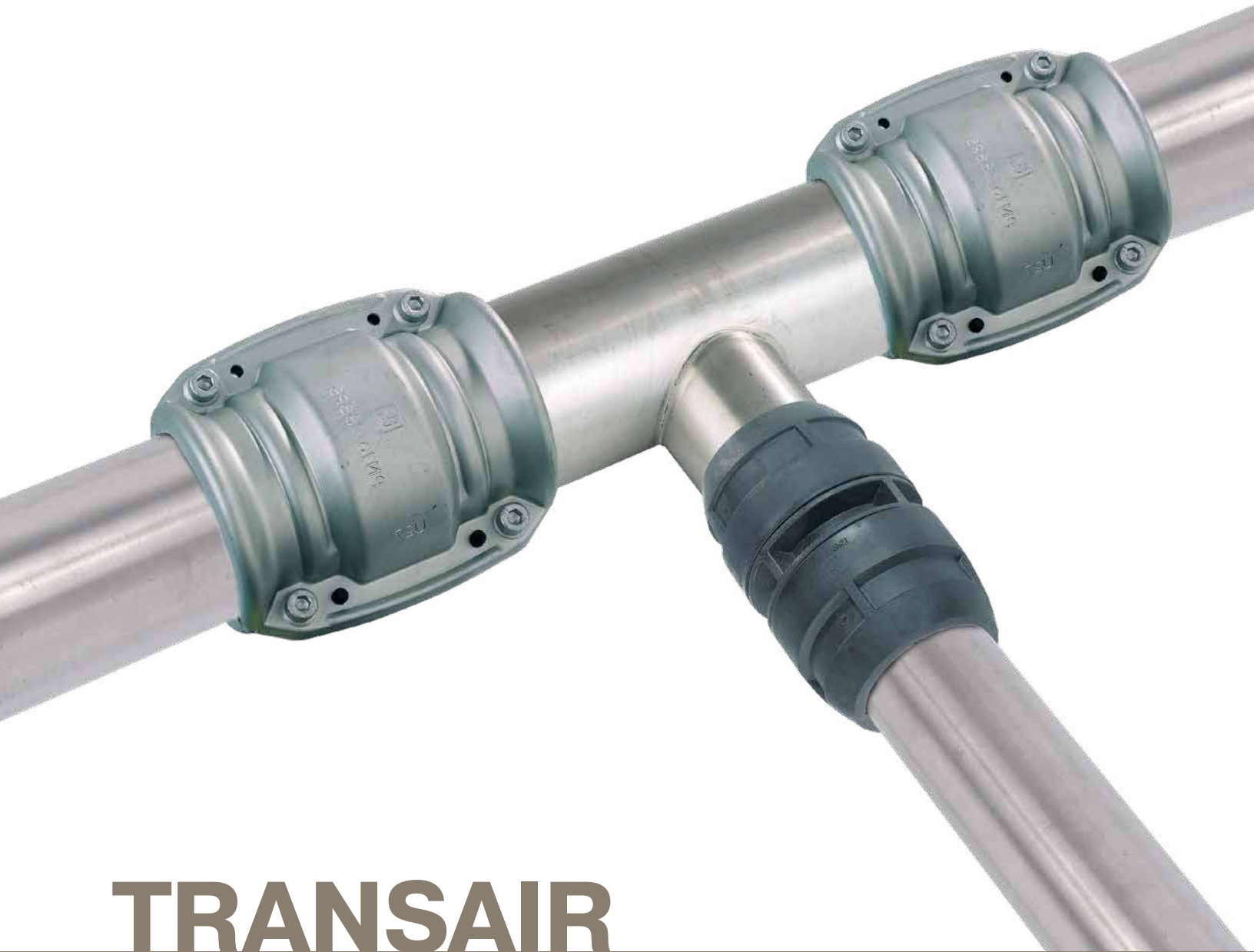

# TRANSAIR STAINLESS STEEL RANGE

# TECHNICAL SPECIFICATIONS

## Compatible Media

- Process water
- Media additives (i.e. Glycol or inhibitors) to prevent freezing or the formation of algae and fungus (contact us for full list)
- Lubricating oils
- Compressed air (dry, wet, lubricated)
- Vacuum
- Industrial/Inert Gases (argon, nitrogen)
- For an expanded list of compatible media, read our chemical compatibility chart on page E

## Maximum Working Pressure According to the Temperature

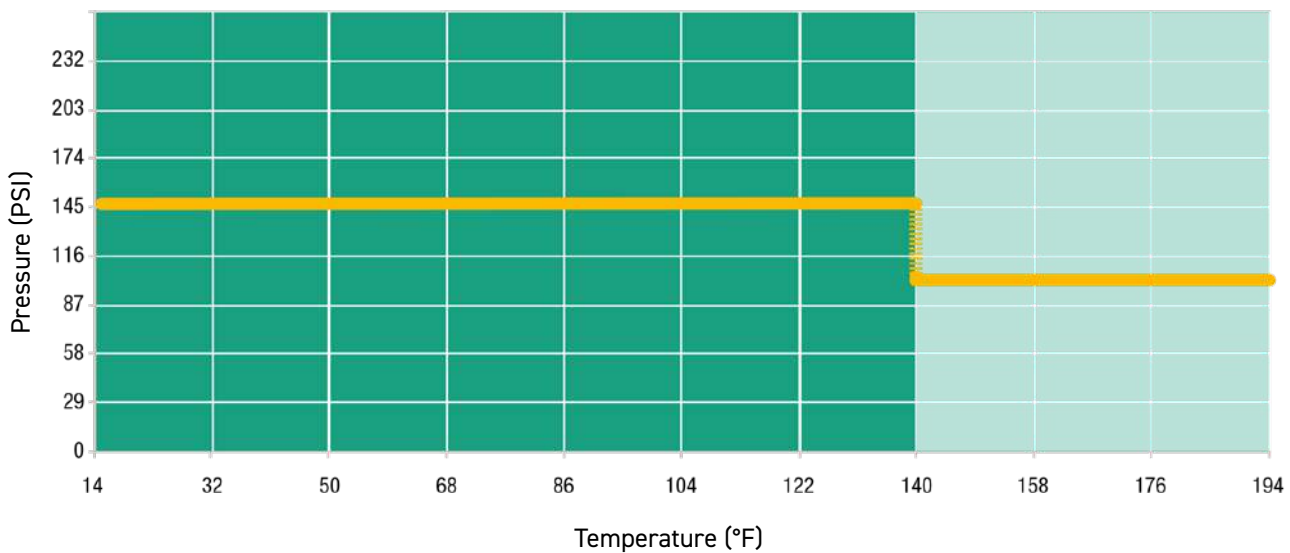

## Working Pressure

- 145 psi from 14°F to 140°F
- 100 psi from 14°F to 194°F

## Expansion Coefficient

- Expansion coefficient of Transair® stainless steel pipe: 0.016 mm per metre per degree celsius



### WARNING

This product can expose you to chemicals including Lead and Lead Compounds which is known to the State of California to cause cancer and birth defects or other reproductive harm. For more information go to [www.P65Warnings.ca.gov](http://www.P65Warnings.ca.gov)

## Resistance



- to corrosion
- to aggressive environments
- to mechanical shocks
- to thermal variations
- to U.V.

All Transair materials are 100% recyclable!

## Water Hammer

Ø3/4, Ø1: comply with standard BS, 7291 part 1  
 Ø3, Ø4: comply with standard NF T54-091

## EPDM or FKM Seals? - How to Choose.

	EPDM	FKM
		
Max. Working Temperature	+140F (+60C)	+194F (+90C) @100psi
Compatible Media	Process water + additives	Oils Compressed Air Industrial/Inert Gas Process water + additives Select acids
Part Nomenclature	Parts ending in 01 have EPDM seal	Parts ending in 02 have FKM seal



### WARNING

This product can expose you to chemicals including Lead and Lead Compounds which is known to the State of California to cause cancer and birth defects or other reproductive harm. For more information go to [www.P65Warnings.ca.gov](http://www.P65Warnings.ca.gov)

# CHEMICAL COMPATIBILITY

**1** Compatible **2** Compatible (except for 3/4" & 1" bronze connectors)

**3** Do not use

Chemical Product	Symbol	Seal Selection	
		EPDM	FKM
Acetaldehyde, Aldehyd acid	C2H4O	2	3
Acetic acid (10%, 20°C)	CH3COOH	2	3
Acetic acid (50%, 20°C)	CH3COOH	3	3
Acetone, Propan-2-one, Dimethyl cetone	C3H6O	1	3
Air (dry)		1	1
Air (lubricated)		3	1
Ammonia liquid	NH3 + H2O	2	3
Ammonium hydroxide	NH4OH	3	3
Ammonium nitrate		2	2
Ammonium phosphate		3	2
Argon (gas)	AR	1	1
Boric acid (23°C)	H3BO3	1	1
Brine	NaCl + H2O	2	2
Calcium hydroxide, Slaked lime	CA(OH)2	1	1
Carbolic acid		3	3
Carbon monoxide (60°C)	CO	1	1
Carbon dioxide (dry)	CO2	1	1
Carbon dioxide (wet or 60°C)	CO2	3	2
Carbon sulfite		3	2
Chlorine (sea chlorinated fluid)		3	3
Citric acid (50%)	C6H8O7	2	2
Diacetone alcohol	C6H12O2	1	3
Ethane-diol, monoethylene glycol, MEG	C2H6O2	2	2
Ethylene glycol	C2H4 (OH)2	1	1
Formic acid, methanoic acid	CH2O2	3	3
Gallic acid (5%)	C7H6O5	1	1
Glycol		1	1

Chemical Product	Symbol	Seal Selection	
		EPDM	FKM
Glycolic acid (50%)		3	3
Helium (gas)	HE	1	1
Hydraulic fluid - mineral oil	-	3	1
Hydraulic fluid - petroleum based	-	3	1
Hydraulic fluid - silicone based	-	1	1
Hydrofluoridric acid	HF	3	3
Hydrogen bromide (20%)	HBR	3	3
Hydrogen peroxide (30%)	H2O2	3	1
Hydrogen sulfide	H2S	3	3
Hydrochloric acid (3%), Hydrogen chloride	HCl	3	3
Methanol, methyl alcohol (MKB, MEK, MIBK)		1	3
Methyl Alcohol	CH4O	1	3
Mineral oil		3	1
Motor oil		3	1
MPG, mono propylen glycol	C3H8O2	2	2
Naphta		3	1
Nitric acid	HNO3	3	3
Nitrogen (gas)	N	1	1
Oil ASTM n°1		3	1
Oil ASTM n°2		3	1
Oil ASTM n°3		3	1
Oxalique acid (10%, 23°C)	HOOC-COOH	2	2
Oxygen (>20%)	O	3	3
Ozone	O	2	2
Perchloric acid (70%)		3	3
Phosphate ester hydraulic fluid, Skydrol		1	3



## WARNING

This product can expose you to chemicals including Lead and Lead Compounds which is known to the State of California to cause cancer and birth defects or other reproductive harm. For more information go to [www.P65Warnings.ca.gov](http://www.P65Warnings.ca.gov)

Chemical Product	Symbol	Seal Selection	
		EPDM	FKM
Phosphoric acid, Orthophosphoric acid	H3PO4	2	2
Potassium hydroxide (50%, 85°C)	KOH	2	3
Sea water	H2O,NaCl	2	2
Silicon emulsions		1	1
Sodium bicarbonate, baking soda (23°C)		1	1
Sodium carbonate		1	1
Sodium hydroxide, caustic soda (50%)	NAOH	2	3
Sodium nitrite		2	2
Sodium peroxide	Na2O2	3	3
Sodium phosphate	NA3PO4	2	2
Sodium sulphate	Na2SO4	1	1
Aqueous solution of detergent		2	2
Sulfuric acid (10%, 20°C)	H2SO4	3	3
Tartric acid (50%, 23°C)		3	2
Trichlorethylene, Trichloride ethylene	C2hci3	3	3
Triethanolamine, TEA	c6h15o3n	2	3
Water demineralised	h2O	2	2
Water drinkable	h2O	3	3
Water industrial	h2O	1	1
Water with chlorine (5%, 23°C)	h2O, ci, NaOCl	3	3

This information is given for information only.

For further information and specific conditions of use, please contact our technical department.



### WARNING

This product can expose you to chemicals including Lead and Lead Compounds which is known to the State of California to cause cancer and birth defects or other reproductive harm. For more information go to [www.P65Warnings.ca.gov](http://www.P65Warnings.ca.gov)

# SIZING AND SELECTION

- Select the Transair® diameter for your application, based on required flow against pressure drop.
- Estimated values for a closed loop network, a pressure of 58 psi with less than 10% pressure drop.
- Velocity: 13 ft/s.

Estimated Flow Rate				Equivalent Length									
				32.8 ft	65.6 ft	98.4 ft	131.2 ft	164 ft	246 ft	328 ft	492 ft	656 ft	984 ft
m3/h	l/s	l/min	cfm	10 m	20 m	30 m	40 m	50 m	75 m	100 m	150 m	200 m	300 m
0,5	0,14	8	0,3	22	22	22	22	22	22	22	22	22	
1	0,28	17	0,6	22*	22*	22*	22*	22*					
2,5	0,69	42	1,5	22*									
3,5	0,97	58	2,1										
5	1,39	83	3										
10	2,77	167	6									76	76
15	4,17	250	9							76	76	76	76
20	5,56	333	12						76*	76*	76*	100	100
30	8,33	500	18			76*	76*	76*	76*	100*	100*	100*	100*
40	11,11	667	24	76*	76*	76*	76*	76*	100*	100*	100*	100*	
50	13,89	833	29	76*	76*	76*	100*	100*	100*	100*			
75	20,83	1250	44	100*	100*	100*	100*	100*					
80	22,22	1333	47	100*	100*	100*	100*	100*					
100	27,78	1667	59	100*	100*	100*	100*						

\* When designing a process water system, take these results in conjunction with system design best practice. An anti water hammer device is necessary for the protection of highly sensitive equipment.



## WARNING

This product can expose you to chemicals including Lead and Lead Compounds which is known to the State of California to cause cancer and birth defects or other reproductive harm. For more information go to [www.P65Warnings.ca.gov](http://www.P65Warnings.ca.gov)

# TRANSAIR® STANDARDS AND CERTIFICATIONS

The certifications for Parker Transair's Stainless Steel range fall within the list identified on pages 2 and 3 of this catalog.

## Standards Related to Transair® Stainless Steel Pipe

The Transair stainless steel range conforms to the manufacturing and chemical compatibility standards listed below.

		Ø 3/4	Ø 3 - Ø 4
	Manufacturing Standards	EN 10217-7	EN 10217-7
	Grade	EN 10088-2, 4404, AISI 316L	1.4301 / AISI 304
	Welding Standard	DIN 17 457, EN 10217-7	DIN 17 457, EN 10217-7
	tolerances	DVGW - W541	EN 1127D4/T3

The quality of the raw materials used in Transair stainless steel pipes allows for them to be bent according to best practices.

## Applications

### FDA Certificate – CFR 21



21 CFR Part 11

The Transair 316L stainless steel drop components conform to the requirements found in FDA - CFR 21.

## Safety

### UL94 HB Grade Certificate



The Transair 316L stainless steel drop components conform to the requirements found in FDA - CFR 21.

All Transair® components are non-flammable with no propagation of flame.

Pipe-to-pipe connectors, ball valves and butterfly valves conform to UL 94 HB Grade standards.

The above mentioned certificates are available upon request.



#### WARNING

This product can expose you to chemicals including Lead and Lead Compounds which is known to the State of California to cause cancer and birth defects or other reproductive harm. For more information go to [www.P65Warnings.ca.gov](http://www.P65Warnings.ca.gov)

# TRANSAIR® CONNECTION TECHNOLOGIES

Transair's innovative technology enables rapid and easy assembly with quick connection of components to the stainless steel pipe. This technology takes into account the specific requirements of each diameter and provides the user with an optimum safety coefficient and easy connection.

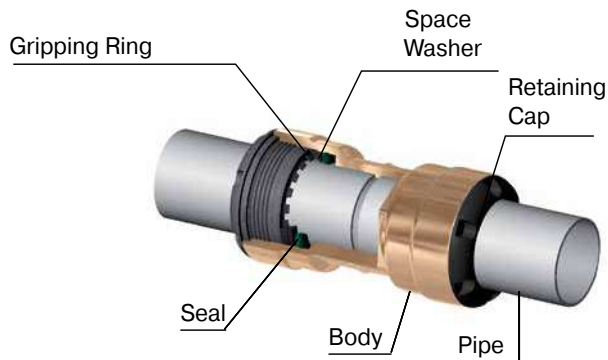

3/4" (22mm)

In size 3/4" (22mm), Transair stainless steel pipe uses push to connect technology. Simply push the pipe into the connector until it meets the depth mark on the pipe. The gripping ring will then engage and prevent the pipe from sliding out of the connector.

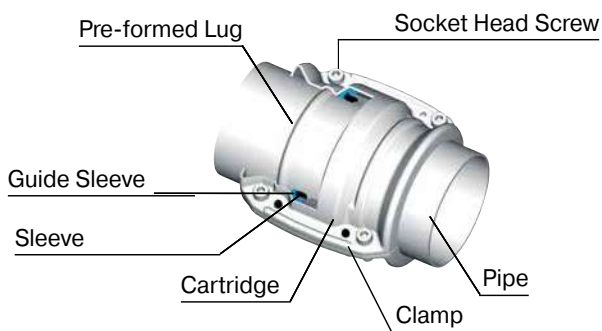

3" (76mm) • 4" (101mm)

In sizes 3" (76mm), and 4" (101mm), Transair stainless steel pipe uses clamshell technology. Place the cartridge on the pipe so it meets the lug. Then position the connector so the cartridge is in the middle. Lastly, close the connector and tighten with the provided bolts.



## WARNING

This product can expose you to chemicals including Lead and Lead Compounds which is known to the State of California to cause cancer and birth defects or other reproductive harm. For more information go to [www.P65Warnings.ca.gov](http://www.P65Warnings.ca.gov)

# TRANSAIR MATERIALS CHART FOR STAINLESS STEEL

Part No.	OD 3/4 (22mm)	OD 3 TO 4 (76mm to 101mm)	Catalog Section
TF16	Stainless Steel 316L	–	Stainless Steel Pipe
TX16	Stainless Steel 304	–	Stainless Steel Pipe
RR06	Body: Bronze Gripping Ring: Stainless Steel Seal: EPDM or FKM	–	Pipe-To-Pipe Connectors for Stainless Steel
RR01	–	Clamp: Treated Steel Cartridge (3" & 4"): Polyamide with Fiberglass	Pipe-To-Pipe Connectors for Stainless Steel
RR02	Body: Bronze Gripping Ring: Stainless Steel Seal: EPDM or FKM	–	Pipe-To-Pipe Connectors for Stainless Steel
RX02	–	Stainless Steel 304	Pipe-To-Pipe Connectors for Stainless Steel
RX12	–	Stainless Steel 304	Pipe-To-Pipe Connectors for Stainless Steel
RR04	Body: Bronze Gripping Ring: Stainless Steel Seal: EPDM or FKM	–	Pipe-To-Pipe Connectors for Stainless Steel
RX04	–	Stainless Steel 304	Pipe-To-Pipe Connectors for Stainless Steel
RR04	Body: Bronze Gripping Ring: Stainless Steel Seal: EPDM or FKM	–	Pipe-To-Pipe Connectors for Stainless Steel
RX04	–	Stainless Steel 304	Pipe-To-Pipe Connectors for Stainless Steel
RX20	–	Stainless Steel 304	Pipe-To-Pipe Connectors for Stainless Steel
RR65	–	–	Pipe-To-Pipe Connectors for Stainless Steel
RX66	–	Stainless Steel 304	Pipe-To-Pipe Connectors for Stainless Steel
RR25	–	–	Pipe-To-Pipe Connectors for Stainless Steel



## WARNING

This product can expose you to chemicals including Lead and Lead Compounds which is known to the State of California to cause cancer and birth defects or other reproductive harm. For more information go to [www.P65Warnings.ca.gov](http://www.P65Warnings.ca.gov)

Part No.	OD 3/4 (22mm)	OD 3 TO 4 (76mm to 101mm)	Catalog Section
RX25	–	Stainless Steel 304	Pipe-To-Pipe Connectors for Stainless Steel
RR21	–	Stainless Steel 304	Pipe-To-Pipe Connectors for Stainless Steel
RX30	–	Stainless Steel 304	Pipe-To-Pipe Connectors for Stainless Steel
RX31	–	Stainless Steel 304	Pipe-To-Pipe Connectors for Stainless Steel
EW06	–	Stainless Steel 304	Pipe-To-Pipe Connectors for Stainless Steel
RR89	–	Body: Treated Iron Seal: EPDM or FKM	Drop Brackets for Stainless Steel
209P	–	Brass	Drop Brackets for Stainless Steel
6642	Treated Brass	–	Wall Brackets for Stainless Steel
6691	Treated Brass	–	Wall Brackets for Stainless Steel
6688	Treated Brass	–	Wall Brackets for Stainless Steel
6636	Treated Brass	–	Wall Brackets for Stainless Steel
VR02	–	Body: Ductile Iron Seal: Nitrile Retaining Ring: Stainless Steel Stem: Stainless Spring: Steel	Valves for Stainless Steel
EW10	–	Low Carbon Steel w/ Clear Zinc Finish (CR3)	Valves for Stainless Steel
VP502SS	Body: Stainless Steel Seal: PTFE	–	Valves for Stainless Steel
VP500P	Body: Brass Seal: PTFE	–	Valves for Stainless Steel
EX01	Stainless Steel 304	Stainless Steel 304	Pipe Hangers for Stainless Steel
RF06	Body: Stainless Steel 316L Seal: FKM	–	316L Stainless Steel Drops
RF02	Body: Stainless Steel 316L Seal: FKM	–	316L Stainless Steel Drops
RF04	Body: Stainless Steel 316L	–	316L Stainless Steel Drops
RF05	Body: Stainless Steel 316L	–	316L Stainless Steel Drops
RF36	Body: Stainless Steel 316L	–	316L Stainless Steel Drops
EF27	Stainless Steel 316L	–	316L Stainless Steel Drops
0205	Stainless Steel 316L	–	316L Stainless Steel Drops

**WARNING**

This product can expose you to chemicals including Lead and Lead Compounds which is known to the State of California to cause cancer and birth defects or other reproductive harm. For more information go to [www.P65Warnings.ca.gov](http://www.P65Warnings.ca.gov)

# STAINLESS STEEL PIPE



## Stainless Steel Pipe

Part No.	OD (in)	OD (mm)	Nominal Length (ft)	Material	WT (lb)
TF16 N7 00	3/4	22	20	316L	8.2
TX16 L1 00	3	76	20	304	39.5
TX16 L3 00	4	101	20	304	65.98

## Volume and Mass

Outside Diameter		Inside Diameter		Volume		Pipe Mass		System Mass (Full of Water)	
(in)	(mm)	(in)	(mm)	Gallon	Liter	(lb)	(kg)	(lb)	(kg)
3/4	22	0.77	19.6	0.07	0.3	1.38	0.63	2.04	0.93
1	28	1	25.6	0.13	0.51	1.78	0.81	2.91	1.32
3	76	2.87	72.9	1.10	4.17	6.52	2.96	15.72	7.13
4	101	3.84	97.6	1.97	7.48	10.89	4.94	27.39	12.43

Values are for 3' (1m) of pipe



### WARNING

This product can expose you to chemicals including Lead and Lead Compounds which is known to the State of California to cause cancer and birth defects or other reproductive harm. For more information go to [www.P65Warnings.ca.gov](http://www.P65Warnings.ca.gov)

# PIPE-TO-PIPE CONNECTORS FOR STAINLESS STEEL

The range of Transair® pipe-to-pipe and stud connectors provides versatility of design.

- Quick connection
- Dismountable and reusable
- Full bore design (consistent inner diameter for both pipe and connectors)

RR06 N7 01



RR06 N7 02

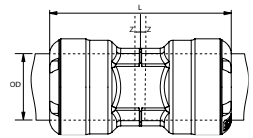

## Union Connector

Part No.	Seal	OD (in)	OD (mm)	L (in)	Z (in)	WT (lb)
RR06 N7 01	EPDM	3/4	22	2.49	.05	.28
RR06 N7 02	FKM	3/4	22	2.49	.05	.28

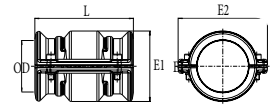

## Union Clamp

Part No.	Seal	OD (in)	OD (mm)	E1	E2	L (in)	WT (lb)
RR01 L1 01	EPDM	3	76	4.02	5.20	5.75	2.5
RR01 L1 02	FKM	3	76	4.06	5.20	5.75	2.5
RR01 L3 01	EPDM	4	101	5.04	6.18	5.75	3.27
RR01 L3 02	FKM	4	101	5.04	6.18	5.75	3.27



### WARNING

This product can expose you to chemicals including Lead and Lead Compounds which is known to the State of California to cause cancer and birth defects or other reproductive harm. For more information go to [www.P65Warnings.ca.gov](http://www.P65Warnings.ca.gov)



## Replacement Cartridge

Part No.	Seal	OD (in)	OD (mm)
RX00 L1 01	EPDM	3	76
RX00 L3 01	EPDM	4	101
RX00 L1 02	FKM	3	76
RX00 L3 02	FKM	4	101



## Replacement Bolt

Part No.	OD (in)	OD (mm)	Thd Size (mm)	L (in)	Hex (mm)
EW04 00 01	3, 4	76, 101	M8 X 1.25	1.5	6



## 90° Elbow

Part No.	Seal	OD (in)	OD (mm)	L (in)	Z (in)	WT (lb)
RR02 N7 01	EPDM	3/4	22	1.72	.52	.36
RR02 N7 02	FKM	3/4	22	1.72	.52	.36

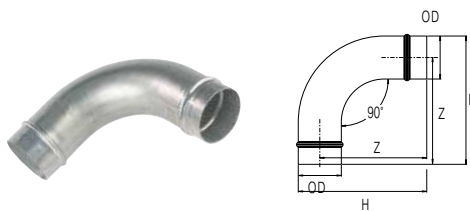

## 90° Elbow

Part No.	OD (in)	OD (mm)	Z (in)	WT (lb)
RX02 L1 00	3	76	7.44	2.28
RX02 L3 00	4	101	8.94	3.13

Use two connectors (RR01) to connect 90 elbow to Transair pipe.

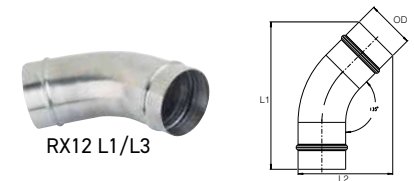

## 45° Elbow

Part No.	ØD (in)	ØD (mm)	L1 (in)	L2 (in)	WT (lb)
RX12 L1 00	3	76	9.27	5.96	1.56
RX12 L3 00	4	101	10.69	7.26	2.89

Use two connectors (RP06) to connect 45 elbow (RX12 M4/M6) to Transair Ø1-1/2" and Ø2" pipe.

Use two connectors (RR01) to connect 45 elbow (RX12 L1/L3) to Transair Ø3" and Ø4" pipes.



### WARNING

This product can expose you to chemicals including Lead and Lead Compounds which is known to the State of California to cause cancer and birth defects or other reproductive harm. For more information go to [www.P65Warnings.ca.gov](http://www.P65Warnings.ca.gov)

RR04 N7 01



RR04 N7 02

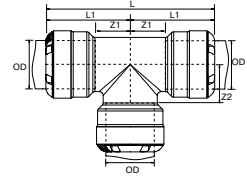

## Equal Tee

Part No.	Seal	OD (in)	OD (mm)	L1 (in)	L2 (in)	Z1 (in)	Z2 (in)	WT (lb)
RR04 N7 01	EPDM	3/4	22	1.66	1.72	.46	.43	.47
RR04 N7 02	FKM	3/4	22	2.20	1.72	.46	.43	.47

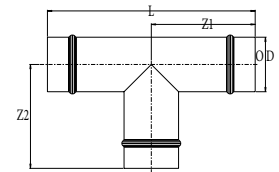

## Equal Tee

Part No.	OD (in)	OD (mm)	L (in)	Z1 (in)	Z2 (in)	WT (lb)
RX04 L1 00	3	76	11.50	5.75	5.75	2.35
RX04 L3 00	4	101	12.28	6.14	5.35	3.94

Use three connectors (RR01) to connect equal tee (RX04) to Transair pipe.

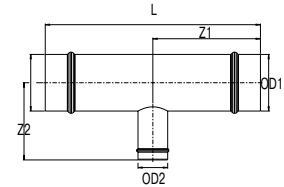

## Reducing Tee

Part No.	OD1 (in)	OD1 (mm)	OD2 (in)	OD2 (mm)	L (in)	Z1 (in)	Z2 (in)	WT (lb)
RX04 L1 M4	3	76	1 1/2	42	11.50	5.75	7.17	1.03
RX04 L1 M6	3	76	2	60	11.42	5.71	7.20	1.10
RX04 L3 L1	4	101	3	76	12.28	6.14	5.35	1.64
RX04 L3 M4	4	101	1 1/2	42	12.28	6.14	7.72	1.68
RX04 L3 M6	4	101	2	60	12.28	6.14	7.72	1.74

Use two connectors (RR01) to connect reducing tees (RX24) to Transair®  $\varnothing$  3" and  $\varnothing$  4" pipes and use one connector (RP06) to connect Transair®  $\varnothing$  1 1/2" and  $\varnothing$  2" pipes.



### WARNING

This product can expose you to chemicals including Lead and Lead Compounds which is known to the State of California to cause cancer and birth defects or other reproductive harm. For more information go to [www.P65Warnings.ca.gov](http://www.P65Warnings.ca.gov)

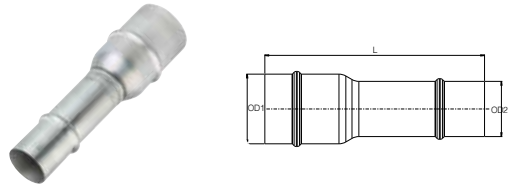

## Plug-In Reducer

Part No.	OD1 (in)	OD1 (mm)	OD2 (in)	OD2 (mm)	L (in)	WT (lb)
RX66 L1 M6	3	76	2	60	9.45	1.22
RX66 L3 L1	4	101	3	76	7.58	1.55

Use one connector (RR01) to connect plug-in reducer (RX66) to Transair 3" and 4" pipes.

Use one connector (RP06) to connect plug-in reducer (RX66) to Transair 1-1/2" and 2" pipes.



### WARNING

This product can expose you to chemicals including Lead and Lead Compounds which is known to the State of California to cause cancer and birth defects or other reproductive harm. For more information go to [www.P65Warnings.ca.gov](http://www.P65Warnings.ca.gov)

RR25 N7 01



RR25 N7 02

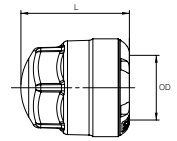

### End Cap

Part No.	Seal	OD (in)	OD (mm)	L (in)	WT (lb)
RR25 N7 01	EPDM	3/4	22	1.62	.18
RR25 N7 02	FKM	3/4	22	1.62	.18

RR05 N7 01



RR05 N76 02

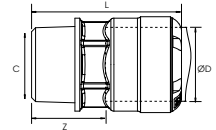

### Male NPT Stud Connector

Part No.	Seal	OD (in)	OD (mm)	Thd Size (in)	L (in)	Z (in)	WT (lb)
RR05 N7N06 01	EPDM	3/4	22	3/4	2.26	1.07	.33
RR05 N7N06 02	FKM	3/4	22	3/4	2.26	1.07	.33

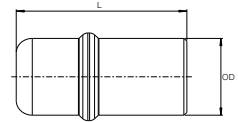

### End Cap

Part No.	OD (in)	OD (mm)	L (in)	WT (lb)
RX25 L1 00	3	76	4.17	.77
RX25 L3 00	4	101	4.23	1.19

Use one connector (RP06) to connect end cap (RR25) to Transair Ø1-1/2" and Ø2" pipe. Use one connector (RR01) to connect end cap (RX25) to Transair Ø3" and Ø4" pipe.

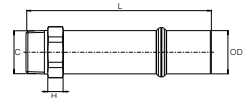

### Male Threaded NPT Adapter

Part No.	OD (in)	OD (mm)	Thd Size (in)	L (in)	H (in)	WT (lb)
RR21 L1N20	3	76	2 1/2	5.08	.79	4.34
RR21 L1N24	3	76	3	5.31	.98	6.84

Use one connector (RP06) to connect threaded adapter to Transair Ø1-1/2" and Ø2" pipe. Use one connector (RR01) to connect threaded adapter (RR21) to Transair Ø3" pipe.



**WARNING**

This product can expose you to chemicals including Lead and Lead Compounds which is known to the State of California to cause cancer and birth defects or other reproductive harm. For more information go to [www.P65Warnings.ca.gov](http://www.P65Warnings.ca.gov)

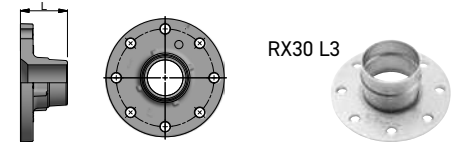

## Flange Adapter – DIN

Part No.	OD (in)	OD (mm)	Standard	No. of Bolt Holes	D1 (in)	D2 (in)	D3 (in)	L (in)	WT (lb)
RX30 L1 00	3	76	DIN	8	7.28	5.71	.71	3.39	4.28
RX30 L3 00	4	101	DIN	8	8.66	7.09	.71	3.35	5.91



## Flange Adapter – ANSI

Part No.	OD (in)	OD (mm)	Standard	No. of Bolt Holes	D1 (in)	D2 (in)	D3 (in)	L (in)	WT (lb)
RX31 L1 00	3	76	ANSI	4	7.87	6.29	.74	3.45	7.05
RX31 L3 00	4	101	ANSI	8	8.99	7.50	.74	3.45	9.76



## Bolt Kits for Stainless Steel Flange

Part No.	Thd Size (in)	L (in)	No. of Bolt Holes
EW06 00 10	5/8-11	3.5	4

## EPDM Gasket For Stainless Steel Flange

Part No.	OD (in)	OD (mm)	For Use with Flange
EW05 L1 00 10	3	76	RX30 L1 00 RX31 L1 00
EW05 L3 01	4	101	RX30 L3 00 RX31 L3 00

OD (in)	OD (mm)	Bolt Kit Part No. (Flange to Flange)	Flange Part No.	Gasket Part No.	No. of Bolt Kits	Max. Tightening torque (Ft-Lbs)
3	76	EW06 00 10	RX30 L1 00	EW05 L1 01	1	147.51
3	76	EW06 00 10	RX31 L1 00	EW05 L1 01	2	147.51
4	101	EW06 00 10	RX30 L3 00	EW05 L3 01	2	147.51
4	101	EW06 00 10	RX31 L3 00	EW05 L3 01	2	147.51



### WARNING

This product can expose you to chemicals including Lead and Lead Compounds which is known to the State of California to cause cancer and birth defects or other reproductive harm. For more information go to [www.P65Warnings.ca.gov](http://www.P65Warnings.ca.gov)

# DROP BRACKETS FOR STAINLESS STEEL



## Female Threaded NPT Saddle Reducing Bracket

Part No.	Seal	OD (in)	OD (mm)	L (in)	WT (LBS)
RR89 L1N08 01	EPDM	3	76	5.39	4.3
RR89 L3N08 01	EPDM	4	101	6.22	4.33
RR89 L1N08 02	FKM	3	76	5.39	4.3
RR89 L3N08 02	FKM	4	101	6.22	4.33

To add a 3/4" drop, use part 209P-16-12.

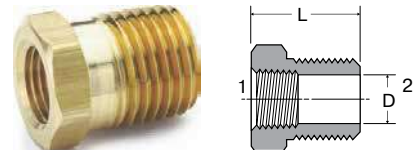

## Bushing 209P

Part No.	1 Pipe Thread	2 Pipe Thread	C Hex	L
209P-16-12	3/4	1	1-3/8	1.31



### WARNING

This product can expose you to chemicals including Lead and Lead Compounds which is known to the State of California to cause cancer and birth defects or other reproductive harm. For more information go to [www.P65Warnings.ca.gov](http://www.P65Warnings.ca.gov)

# WALL BRACKETS FOR STAINLESS STEEL

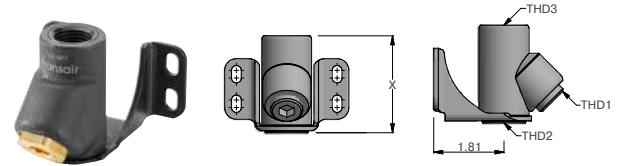

## Threaded NPT 1 Port 45° Wall Bracket

Part No.	Thd Size 1 (in)	Thd Size 2 (in)	Thd Size 3 (in)	X (in)
6642 22 22	1/2	1/4	1/2	2.52

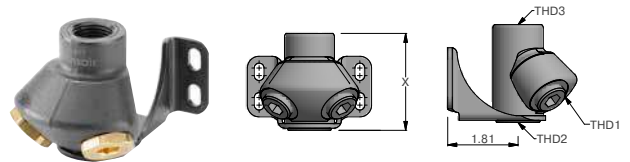

## Threaded NPT 2 Port 45° Wall Bracket

Part No.	Thd Size 1 (in)	Thd Size 2 (in)	Thd Size 3 (in)	X (in)
6691 22 22	1/2	1/4	1/2	2.52

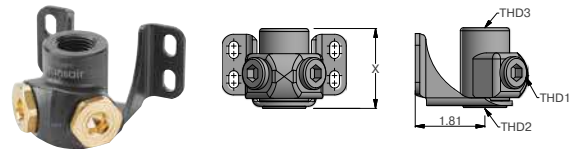

## Threaded NPT 2 Port 90° Wall Bracket

Part No.	Thd Size 1 (in)	Thd Size 2 (in)	Thd Size 3 (in)	X (in)
6688 22 22	1/2	1/4	1/2	2.03

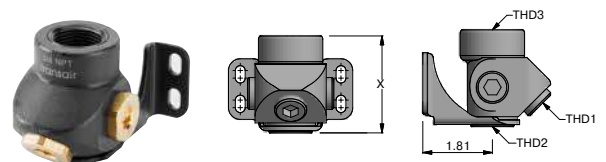

## Threaded NPT 3 Port Wall Bracket

Part No.	Thd Size 1 (in)	Thd Size 2 (in)	Thd Size 3 (in)	X (in)
6636 28 22	1/2	1/4	3/4	2.52



### WARNING

This product can expose you to chemicals including Lead and Lead Compounds which is known to the State of California to cause cancer and birth defects or other reproductive harm. For more information go to [www.P65Warnings.ca.gov](http://www.P65Warnings.ca.gov)

# VALVES FOR STAINLESS STEEL

Transair® ball valves and butterfly valves placed regularly throughout the network and at key locations allow ease of system isolation, adaptation and maintenance. These valves are silicone-free.

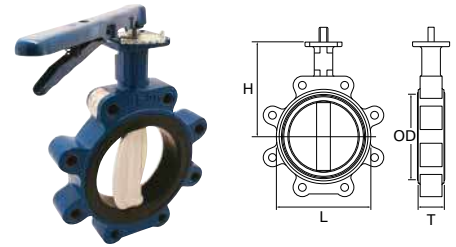

## Butterfly Valve

Part No.	Seal	Flange Std	OD (in)	OD (mm)	No. of Lugs	WT (lb)	Bolt Part No.	Flange
VR02 L1 01US	EPDM	ANSI	3	76	4	7.05	EW10 00 01	RX31 L1 00
VR02 L1 02US	FKM	ANSI	3	76	4	7.05	EW10 00 01	RX31 L1 00
VR02 L3 01US	EPDM	ANSI	4	101	8	9.48	EW10 00 01	RX31 L3 00
VR02 L3 02US	FKM	ANSI	4	101	8	9.48	EW10 00 01	RX31 L3 00

Models with CE marking. EW06 bolt kits are not supplied for valve/flanges assembly. The butterfly valves do not require additional ring when connected to circular flanges. Suitable for flanges according to EN 1092-1 - PN 16.



## Bolt Kit

Part No.	Thd Size (in)	L (in)	No. of Bolts
EW10 00 01	5/8"-11	1.23	X 8

## Butterfly Valve Accessories Chart

OD (in)	OD (mm)	Bolt Kit Part No. (Flange to Butterfly Valve)	Flange Part No.	Butterfly Valve Part No.	No. of Bolt Kits	Max. Tightening torque (ft-lbs)
3	76	EW10 00 01	RX31 L1 00	VR02 L1 01US	2	36.88
3	76	EW10 00 01	RX31 L1 00	VR02 L1 02US	2	36.88
4	101	EW10 00 01	RX31 L3 00	VR02 L3 01US	2	36.88
4	101	EW10 00 01	RX31 L3 00	VR02 L3 02US	2	36.88



### WARNING

This product can expose you to chemicals including Lead and Lead Compounds which is known to the State of California to cause cancer and birth defects or other reproductive harm. For more information go to [www.P65Warnings.ca.gov](http://www.P65Warnings.ca.gov)

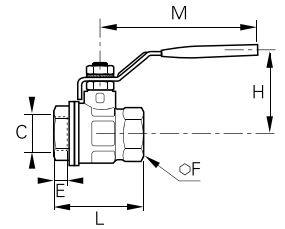

## Ball Valve – Stainless Steel

Part No.	Seal	Thd Size (in)	L (in)	WT (lb)	M	H
VP502SS-12	PTFE	3/4	3.35	1.57	5.00	2.67
VP502SS-16	PTFE	1	3.54	2.09	5.00	2.80

\*Model with CE marking.

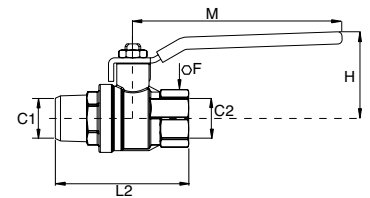

## Ball Valve – Brass

Part No.	Seal	Thd Size (in)	L (in)	WT (lb)	M	H
VP500P-12	PTFE	3/4	2.42	.86	4.17	2.14
VP500P-16	PTFE	1	2.75	3.47	3.96	2.21

\*Model with CE marking.



### WARNING

This product can expose you to chemicals including Lead and Lead Compounds which is known to the State of California to cause cancer and birth defects or other reproductive harm. For more information go to [www.P65Warnings.ca.gov](http://www.P65Warnings.ca.gov)

# TOOLS FOR STAINLESS STEEL

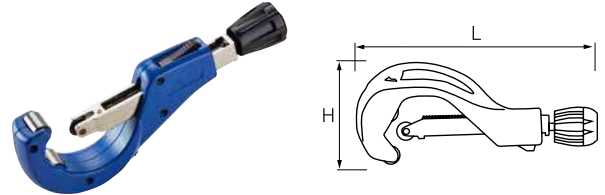

## Pipe Cutter

Part No.	Used for Transair® Pipe (in)
6698 03 01	Ø 3/4 to 3
EW08 00 03	Ø 4

Includes deburring tool.



## Deburring Tool

Part No.	6698 04 02
----------	------------



## Portable Lugging Tool Kit

Part No.	Voltage
EW01 00 02	14

This case contains: one portable tool, one 14V battery and battery charger. Jaws sold separately.



### WARNING

This product can expose you to chemicals including Lead and Lead Compounds which is known to the State of California to cause cancer and birth defects or other reproductive harm. For more information go to [www.P65Warnings.ca.gov](http://www.P65Warnings.ca.gov)

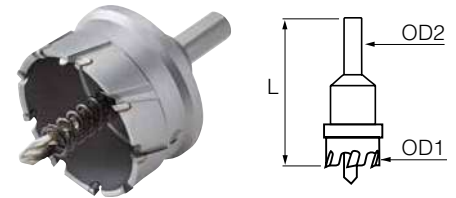

## Drilling Tool

Part No.	OD1 (in)	OD1 (mm)	OD2 (in)	OD2 (mm)	L (in)	Used for Transair® Pipe (in)
EW09 00 30	1 3/16	30	1/2	13	2 3/4	Ø 3 - 4

Drilling tool EW09 is required to install Transair® direct feed brackets.  
After drilling, it is important to deburr and clean the pipe.  
Recommended to be used with any cordless drill with a 1/2" chuck.

## Drilling Tool Selection Chart

Part No.	OD (in)	OD (mm)	tool Part No.
RR89 L1N08 01	3	76	EW09 00 30
RR89 L3N08 01	4	101	EW09 00 30
RR89 L1N08 02	3	76	EW09 00 30
RR89 L3N08 02	4	101	EW09 00 30

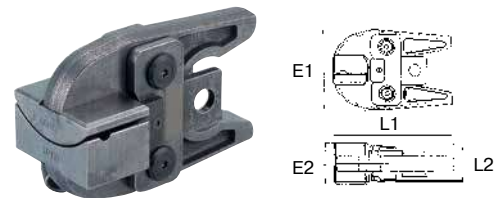

## Jaws for Portable Lugging Tool

Part No.	Used for Transair® Pipe (in)	Used for Transair® Pipe (mm)
EW02 L1 00	3	76
EW02 L3 00	4	101



## 14V Battery for Portable Lugging Tool

Part No.	Voltage
EW03 00 01	14



### WARNING

This product can expose you to chemicals including Lead and Lead Compounds which is known to the State of California to cause cancer and birth defects or other reproductive harm. For more information go to [www.P65Warnings.ca.gov](http://www.P65Warnings.ca.gov)



### Electric Pipe Cutter

Part No.	Used for Transair® Pipe (in)
EW08 00 V3	Ø 4 to 6



### Replacement Cutter Blade

Part No.	Used For Transair® Pipe Cutter
EW08 00 SSUS	EW08 00 V3



### Dismounting Tool

Part No.	EW11 00 01
----------	------------

Contains 1 key, 5 rings for dismounting Ø22 and 5 rings for dismounting Ø28

EW10 N7 02



EW10 N7 01



### Maintenance Set

Part No.	Seal	OD (in)	OD (mm)
EW10 N7 01	EPDM	3/4	22
EW10 N7 02	FKM	3/4	22



**WARNING**

This product can expose you to chemicals including Lead and Lead Compounds which is known to the State of California to cause cancer and birth defects or other reproductive harm. For more information go to [www.P65Warnings.ca.gov](http://www.P65Warnings.ca.gov)

# PIPE HANGERS FOR STAINLESS STEEL



## Rubber Insulated Pipe Hangers

Part No.	OD (in)	OD (mm)	Thd Size
ER01 N7 00	3/4	22	M8
ER01 N9 00	1	28	M8
ER01 L1 00	3	76	3/8-16 UNC
ER01 L3 00	4	101	3/8-16 UNC



## Clamp Style Pipe Hangers

Part No.	OD (in)	OD (mm)	Thd Size (in)
EX01 N7 00	3/4	22	M8 & 3/8-16 UNC
EX01 L1 00	3	76	3/8-16 UNC
EX01 L3 00	4	101	3/8-16 UNC



### WARNING

This product can expose you to chemicals including Lead and Lead Compounds which is known to the State of California to cause cancer and birth defects or other reproductive harm. For more information go to [www.P65Warnings.ca.gov](http://www.P65Warnings.ca.gov)





# ALUMINUM INSTALLATION GUIDE

# TRANSAIR ALUMINUM INSTALLATION GUIDELINES

## Specifications:

**Max Working Pressure** 188 psi from -4° to +140° F  
(12.9 bar from -20° to +60° C)

232 psi from -4° to +113° F  
(15.9 bar from -20° to +46.1° C)

**Vacuum:** 99.9% (0.03" Hg / 1mbar)

**Working Temperature** -4° to +140° F (-20° to +60° C)

\* Please consult us for higher temperature requirements

Prior to the Installation of a Transair® system, the installer should ensure the installation area complies with all safety and hazard regulations. Transair® can be installed in the compressor room, as well as downstream for the distribution piping system. Transair® flexible hoses can be installed to dampen sources of vibration.

When modifying or repairing a Transair® system, ensure the section of pipe where work will take place has been properly vented prior to beginning modifications.

Only genuine Transair® parts should be used for installation. The use of non-Transair® parts with Transair® parts will result in the 10 year warranty being voided. Refer to the technical data in Transair® Catalog 3515 for proper sizing and selection of components.

## Pressurizing the system

Once the Transair® system installation has been completed, and prior to pressurizing the system, the installer should complete all tests, inspections, and compliance checks according to customer requirements, engineering best practices, and building code regulations.

## Transair® pipe and hoses

Transair® piping needs to be protected from mechanical impact. All Transair® piping systems should be installed out of reach of fork-lifts and above overhead material handling cranes.

Only use genuine Transair® connectors to connect sections of pipe. Transair® pipe should never be welded, soldered, or glued. Transair® Flexible hoses can be installed to route around obstacles following proper installation guidelines.

Note: In certain situations, Transair® piping can be bent - contact the factory for further information.

## Expansion / contraction

Prior to installation, ensure the expansion and contraction of the piping system has been properly calculated. The elongation and retraction of each Transair® line should be calculated according to the information found in this installation guide.

## Component assembly

For proper installation of a Transair® System, follow the steps outlined in this document.

When installing Transair® piping, avoid the following

- Installing within a solid mass (concrete, foam, etc)
- Hanging external equipment from Transair® pipe
- Using Transair® for grounding, or conduit for electrical wires.
- Exposing Transair® components to incompatible chemicals. (Contact the factory for further information)

## Compressed Air System Design Best Practices

- When installing a Transair system, ensure you follow all local building code regulations
- To reduce the occurrence of pressure drop, eliminate excessive use of elbows and keep the use bypasses and in-line pipe reductions to a minimum.
- Maintain consistent, high quality compressed air through the use of filtration elements in the compressor room and point of use.
- Size the diameter of the pipe according to the required flow rate and the acceptable pressure drop at the point of use.
- Install air drops as close as possible to the point of use.



1/2" (16.5mm)  
1" (25mm)  
1 1/2" (40mm)

Deburred and  
chamfered pipe



2" (50 mm)  
2 1/2" (63 mm)

Pipe pre-drilled at each  
end with two 1" (25  
mm) diameter holes,  
deburred and chamfered



3" (76mm)  
4" (101mm)  
6" (168mm)

Pipe lugged at each end,  
deburred and chamfered

## General Information

Transair aluminum pipe is supplied from the factory ready to use. When installing factory lengths of pipe, no cutting, deburring, chamfering is required.

The rigidity of Transair aluminum pipe greatly reduces the occurrence of temperature related expansion and contraction. Due to the rigidity, Transair pipe will not deform overtime and introduce a new area of pressure drop in the system.

Transair components are manufactured within a high tolerance, to ensure a tight fit between the pipe and the connector. As the connection is made, the seal engages to minimize the chance of corrosion on the internal surfaces.

The exterior of all Transair aluminum pipes are coated with a Qualicoat certified protective powder coating. This coating helps to protect the pipe from external corrosion. Transair comes standard in Blue (Compressed Air), Gray (Vacuum) and Green (Industrial / Inert Gases) for system identification and aesthetic appearance.

Standard colors available:

- Blue (RAL 5012/bs1710)
- Gray (RAL 7001)
- Green (RAL 6029)

(Please contact us for other colors)

Transair® aluminum pipe is available in seven diameters from 1/2" to 6".

## Applications

Transair® 1/2" to 6" aluminum pipe has been specially designed for compressed air, vacuum and inert gases (argon, nitrogen) – please contact us for other fluids.

# MARKING

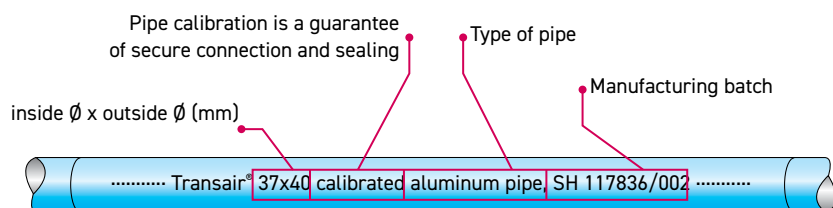

The transported fluid can be instantly identified by the color of the pipe

ex: Blue pipe → compressed air system

ex: Gray pipe → vacuum system

ex: Green pipe → inert gas system

## Connection indicator

Only on 1/2" to 1 1/2" aluminum pipe

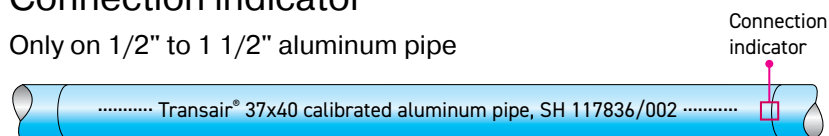

## Drilling locator: mark lines for correct drilling

Only on 1/2" to 2 1/2" aluminum pipe

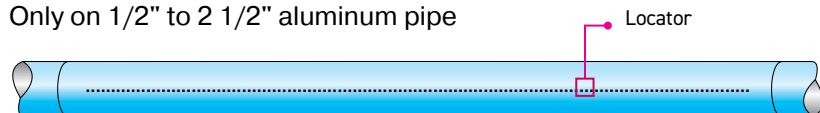

Drilling locators are used to correctly position Transair® brackets onto the pipe. There are two locators on each pipe. The second locator is used to position a second bracket perpendicular to a first bracket.

# MARKING 1/2" TO 1 1/2"

## Tools



Pipe cutter for aluminum pipe  
ref. 6698 03 01



Chamfer tool for aluminum pipe  
ref. 6698 04 01



Deburring tool for aluminum pipe  
ref. 6698 04 02



Marking tool for aluminum pipe  
ref. 6698 04 03

## Pipe Preparation Process

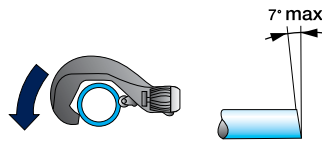

1. Cutting the pipe: Position the blade of the cutter on the pipe, then rotate the pipe cutter around the pipe, gently tightening the blade wheel after each pass.

Note: The cutter cannot be more than 7 degrees off of square while cutting.

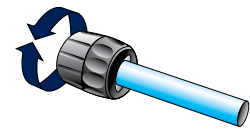

2. Carefully chamfer the outer edges



3. Deburr the inner edge of the pipe

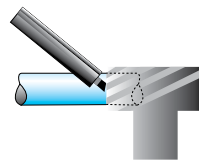

4. Place the marking tool on the end of the pipe, and mark the insertion depth

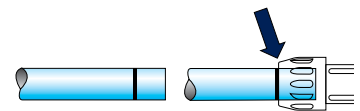

5. Insert the pipe into the connector until the marking meets the edge of the connector

Insertion Depths	1/2		1		1-1/2	
	Insertion Depth (in)	Insertion Depth (mm)	Insertion Depth (in)	Insertion Depth (mm)	Insertion Depth (in)	Insertion Depth (mm)
Connectors	0.98	25	1.06	27	1.77	45
End Caps	1.54	39	1.65	42	2.52	64

# MARKING 2" TO 2½"

## Tools



Pipe cutter for aluminum pipe  
ref. 6698 03 01



File



Deburring tool for aluminum pipe  
ref. 6698 04 02



Drilling jig for aluminum pipe  
ref. 6698 01 02



Drilling tool for aluminum pipe r  
ef. 6698 02 01

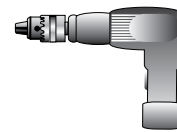

Drill

## Pipe Preparation Process

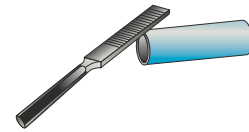
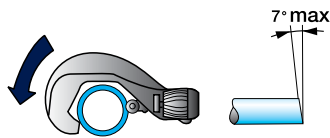

1. Cutting the pipe: Position the blade of the cutter on the pipe, the rotate the pipe cutter around the pipe, gently tightening the blade wheel after each pass.

Note: The cutter cannot be more than 7 degrees off of square while cutting

2. Carefully deburr the outer edges



3. Deburr the inner edge of the pipe

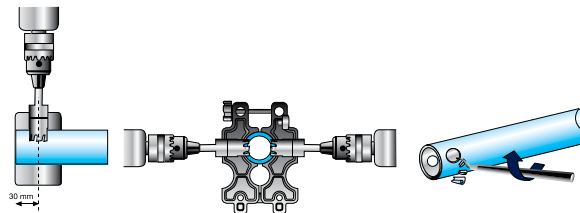

4. Drill the two clamp holes using the drilling jig (6698 01 03) and the 1" drilling tool (6698 02 01). Loosen the jig, release the pipe, then deburr both holes. Ensure that all outer and inner surfaces are smooth and clear of burrs and sharp edges.

# MARKING 3" TO 6"

## Tools



Pipe cutter for aluminum pipe  
ref. 6698 03 01 (3") or  
EW08 00 03 (4" - 6")



File



Deburring tool  
ref. 6698 04 02



Portable tool kit  
ref. EW01 00 02



Pipe forming jaw set  
ref. EW02 L1 00 (3") or  
EW02 L3 00 (4")  
or EW02 L8 00 (6")

## Pipe Preparation Process

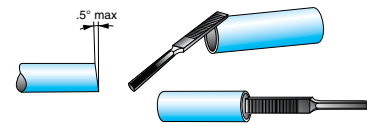
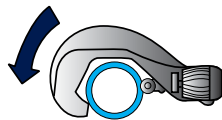

1. Cutting the pipe: Position the blade of the cutter on the pipe, then rotate the pipe cutter around the pipe, gently tightening the blade wheel after each pass.
2. Carefully deburr the outer and inner edges of the pipe  
Note: The cutter cannot be more than 0.5 degrees off of square while cutting

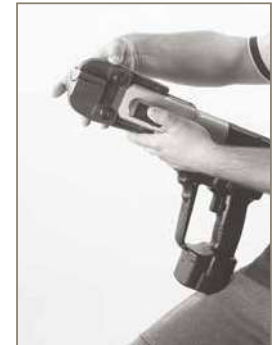

3. Creating the lugs for 3", 4" or 6" cut pipe
  - a. Open the retaining pin at the front of the machine by pressing the jaw release button
  - b. Place the jaw in the housing
  - c. Lock into position by closing the retaining pin

## Procedure

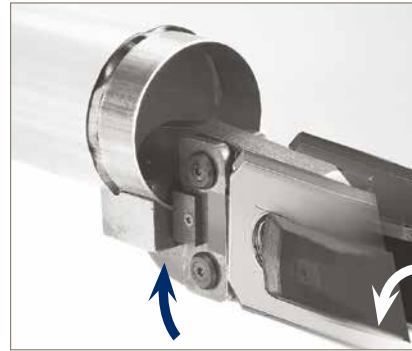
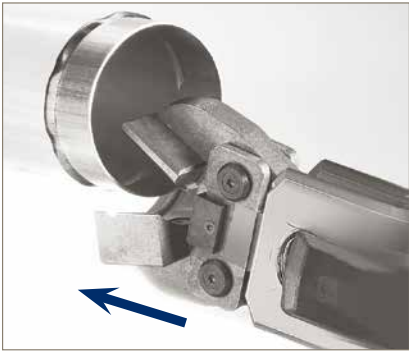

1. Manually open the jaw and insert the aluminum pipe until the pipe meets the stop in the jaw.
2. Release the jaw then press the trigger and lug the pipe until a "snap" is heard.

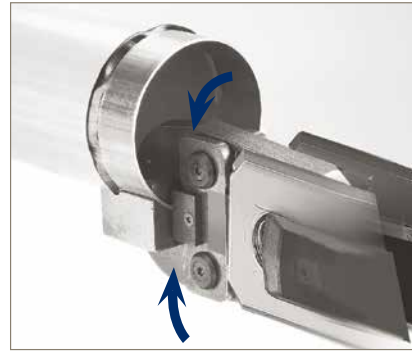

3. Re-open the jaw to remove the pipe. Position the end of the jaw next to the lug mark: this will help to prevent overlapping the lugs.
4. Repeat the operation until the required minimum of lugs for each diameter have been achieved.

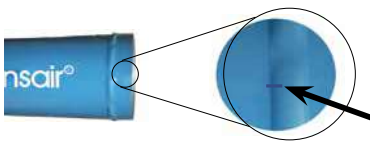

	Ø 3"	Ø 4"	Ø 6"
<b>Minimum. No. of Lugs</b> Important: Do not overlap the lugs!	 <b>5</b>	 <b>6</b>	 <b>10</b>

# PIPE TO PIPE CONNECTORS

## 1/2" to 1½" Instant connection by means of a gripping ring

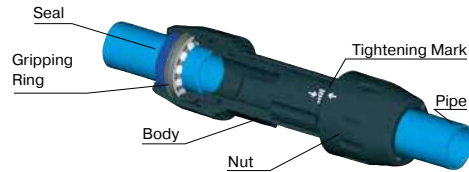

In sizes 1/2" (16,5mm), 1" (25mm), and 1-1/2" (40mm), Transair aluminum pipe uses push to connect technology. Simply push the pipe into the connector until it meets the depth mark on the pipe. The gripping ring will then engage and prevent the pipe from sliding out of the connector.

## 2" to 2½" Snap ring quick-fit connection



In sizes 2" (50mm) and 2-1/2" (63mm), Transair aluminum pipe uses snap ring technology. Place the snap ring in the two holes at the end of the pipe and slide the nut in-place. Next, hand tighten the nut into the connector body. Lastly, use a pair of spanner wrenches to fully tighten the connector.

## 3" to 6" Clamp quick-fit connection

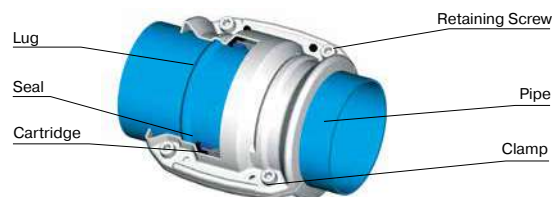

In sizes 3" (76mm), 4" (101mm), and 6" (168mm), Transair aluminum pipe uses clamshell technology. Place the cartridge on the pipe so it meets the lug. Then position the connector so the cartridge is in the middle. Lastly, close the connector and tighten with the provided bolts.

## Pre-assembled tightening indicators for 1/2", 1" and 1 1/2" connectors

There are important visual markings on the bodies and nuts of Transair® 1/2", 1" and 1 1/2" connectors. These are represented by solid and empty arrows and indicate the optimum torque. When assembling Transair® connectors, the nuts are tightened to a pre-defined torque on the body of the connector. This torque guarantees the seal and safety of each connection.

Before using 1/2", 1" or 1 1/2" connectors, ensure that the arrow marks are correctly aligned with each other.

There is no need to loosen the nut on 1/2", 1", and 1-1/2" connectors prior to connecting to Transair aluminum pipe.

Do not switch the nuts. The arrows on the body and nut should be of the same style. (i.e. filled with filled and outline with outline)

Do not interchange connector nuts with other connectors. All connectors come from the factory pre-torqued for instant installation.

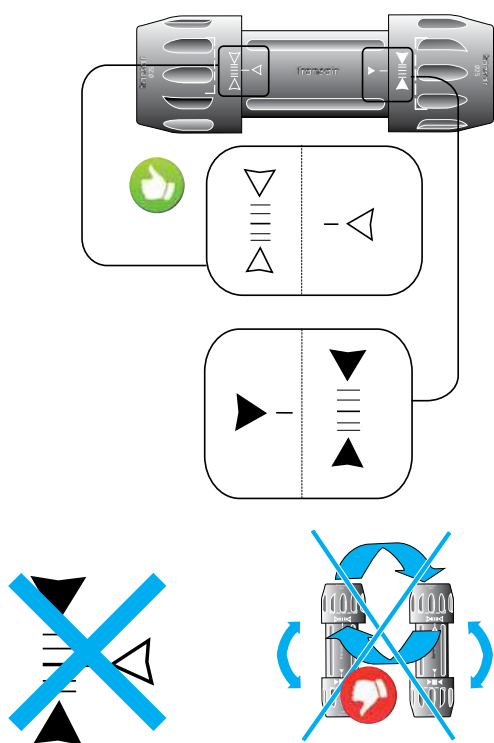

# CONNECTION/DISCONNECTION

## 1/2" TO 1 1/2"

### Connection

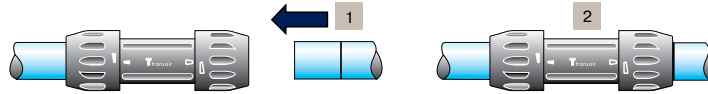

1. Place the marking tool on the end of the pipe, and mark the insertion depth
2. Insert the pipe into the connector until the marking meets the edge of the connector

### Disconnection



1. Unscrew the nut one-half (1/2) turn
2. Pull the pipe out from the nut

Lateral dismantling: see page A19 of this catalog.

Insertion Depths	1/2		1		1-1/2	
	Insertion Depth (in)	Insertion Depth (mm)	Insertion Depth (in)	Insertion Depth (mm)	Insertion Depth (in)	Insertion Depth (mm)
Connectors	0.98	25	1.06	27	1.77	45
End Caps	1.54	39	1.65	42	2.52	64

# CONNECTION/DISCONNECTION

## 2" TO 2½"

### Connection

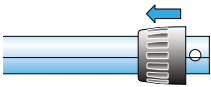

1. Unscrew one of the connector nuts and slide over the pipe

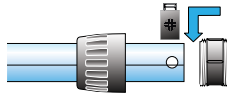

2. Position the snap ring in the appropriate housing (two holes at the end of the pipe)

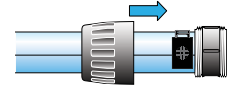

3. Slide the nut that is on the pipe towards the end until it stops against the snap ring.

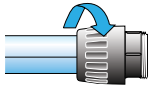

4. Hand tighten the nut

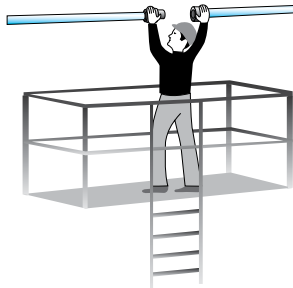

5. Connect the second nut to the connector body

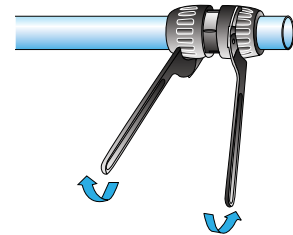

6. Complete the assembly by tightening the connector one-half (1/2) turn with the Transair spanner wrenches

### Disconnection

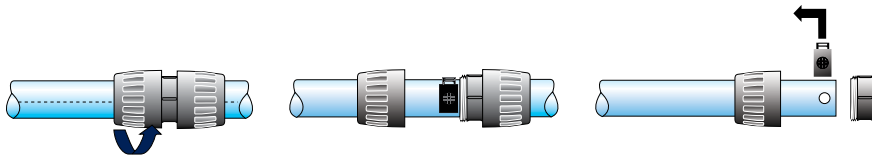

To disconnect the connector, perform the same steps, but in reverse order

Lateral dismantling: see page A19 of this catalog.

# CONNECTION/DISCONNECTION 3" TO 6"

## Connection

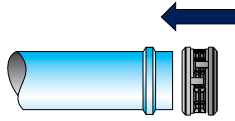

1. Slide the cartridge over the end of the first pipe until it meets the lug

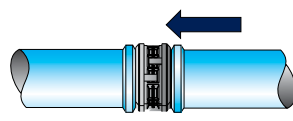

2. Bring the second pipe to the cartridge and slide the pipe until the cartridge meets the lug

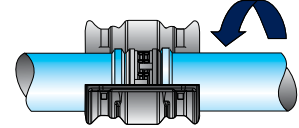

3. Position the clamshell connector over the cartridge / pipe assembly. The cartridge should fall in the middle of the connector

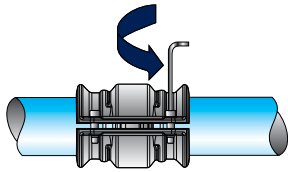

4. Hand-tighten the bolts in a cross pattern with an allen wrench. See chart on the following page for sizes)

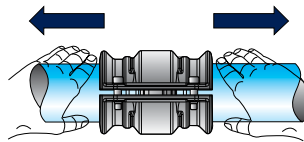

5. Pull the pipes back towards the outside of the clamshell

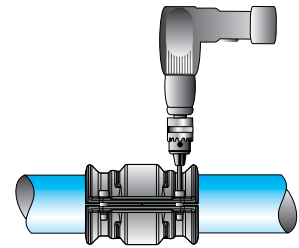

6. Using a drill, fully tighten the clamshell bolts in a cross pattern  
Torque Specs: 7.38 lb-ft to 29.5 lb-ft

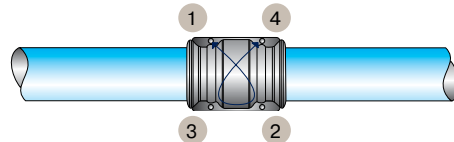

For effective sealing, follow the above diagram for securing the bolts in a cross pattern.

## Disconnection

To disconnect the connector, perform the same steps, but in reverse order.



For 6" clamshells only.

Ensure you leave an equal gap (approx: 1/4") on both sides of the clamshell. Over-tightening the bolts can result in an unequal gap which will impact performance.

## Allen Wrench Sizes

Transair Diameter	Allen Wrench Size
3" (76mm)	6mm
4" (101mm)	6mm
6" (168mm)	8mm

# PRACTICAL EXAMPLES

## Various 3", 4", and 6" Configurations

### Installing a 90° elbow

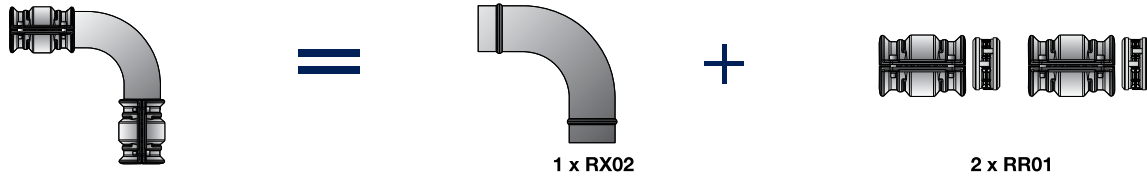

### Installing a tee

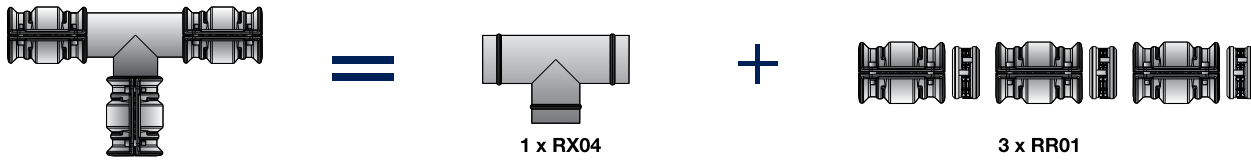

### Installing an end cap

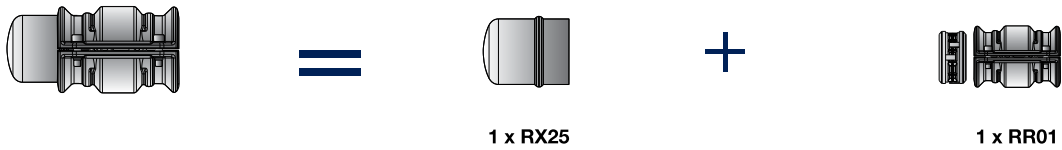

### Installing a flange and connector

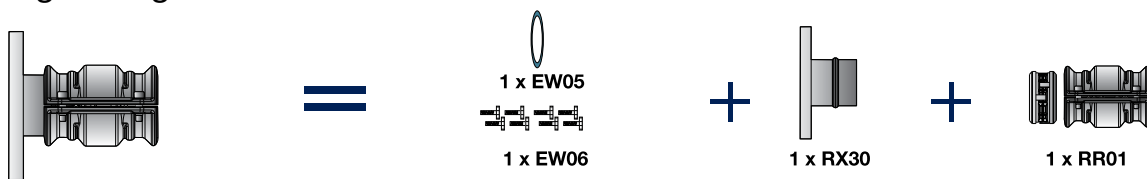

### Reducing from 4" to 3"



### Installing a butterfly valve

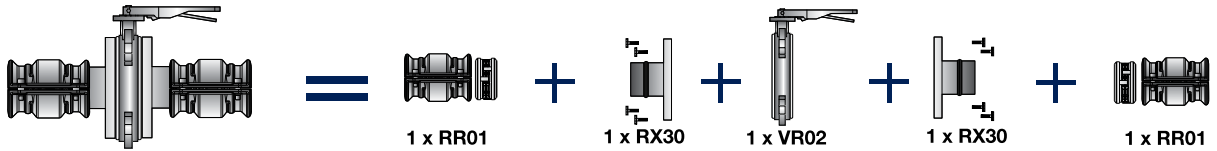

### Installing a flange and flexible hose

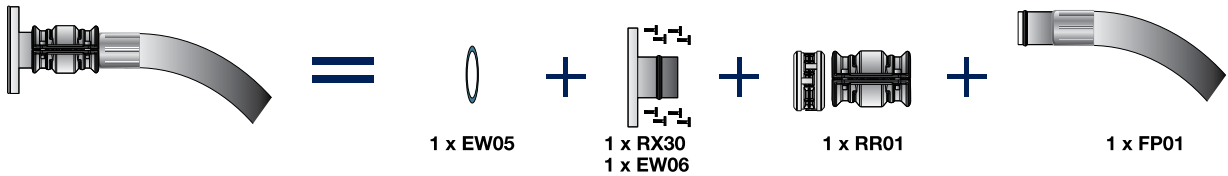

### How to close off the 1-1/2" end of a reducing tee



# PRACTICAL EXAMPLES

Connecting a Transair 3", 4", or 6" system to a 2-1/2", 2", 1-1/2", 1", or 1/2" system

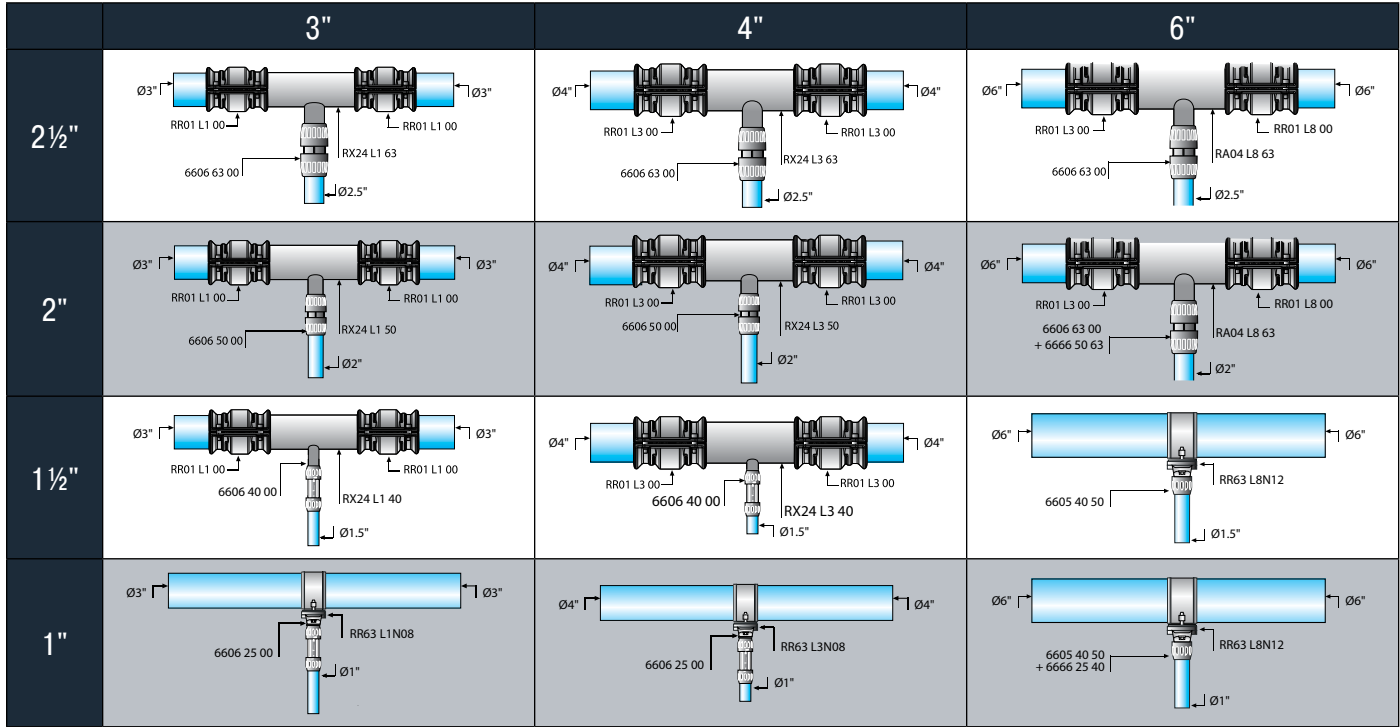

Minimum center to center mounting distances for 3", 4", and 6" tees

ØD1 (in)	ØD2 (in)	A (in)	B minimum (in)
4	4	3.54	18.5
4	3	3.15	18.5
4	2-1/2	3.54	12.87
4	1-1/2	1.81	8.86
4	1	1.81	8.46
4	1/2	1.81	7.87
3	3	3.15	16.54
3	2-1/2	3.54	12.36
3	1-1/2	1.81	8.35
3	1	1.81	7.95
3	1/2	1.81	7.36

Minimum center to center mounting distances for 3", 4", and 6" drop brackets

ØD1 (in)	ØD2 (in)	A (in)	B minimum (in)
6	2	3.54	20.08
6	1-1/2	1.81	16.14
4	1	1.81	9.84
3	1	1.81	9.45

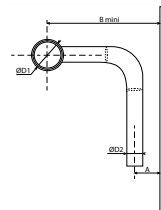

# SYSTEM MODIFICATION FOR DIAMETERS ½" – 1" – 1½" ONLY

## Replacing a Union Connector with a Tee Connector

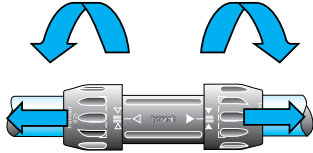

1. Loosen the 2 nuts.



2. Slide them along the pipe on either side of the connector.

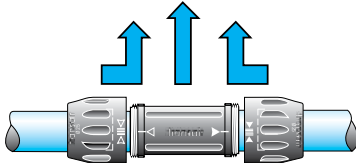

3. Remove the body and nuts of the connector. Re-tighten the nuts onto the body for future use.

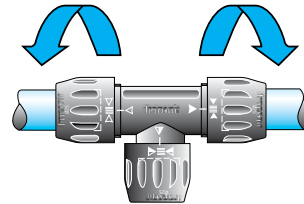

4. Slide the nuts of the tee and position the body of the tee between the 2 pipes such that the solid and empty arrows are facing each other.

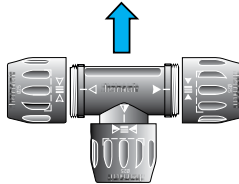

5. Re-tighten the nuts until the empty and solid arrows are aligned with each other.

# SYSTEM MODIFICATION FOR DIAMETERS ½" – 1" – 1½" ONLY

## Replacing a Union Connector with a Ball Valve

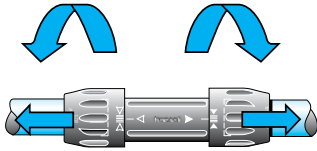

1. Loosen the 2 nuts.



2. Slide them along the pipe on either side of the connector.

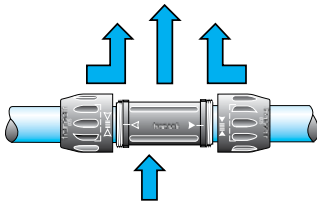

3. Remove the body and nuts of the connector. Re-tighten the nuts onto the body for future use.

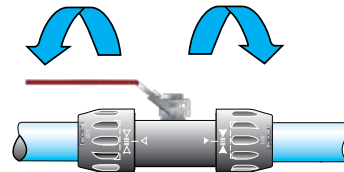

4. Slide the nuts of the valve and position the body of the valve between the 2 pipes so that the empty and solid arrows are facing each other

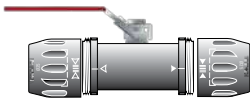

5. Re-tighten the nuts until the empty and solid arrows are aligned with each other.

# LATERAL DISMANTLING

## ½" TO 1½"

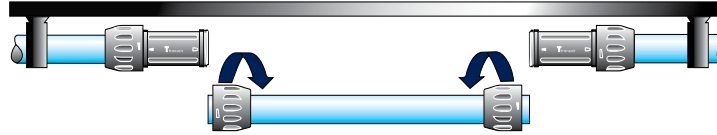

Loosen the nuts on the side of the pipe and slide them away from the connector. Then remove the pipe.

Important: When re-installing the pipe, do not swap the nuts.

## 2" TO 2½"

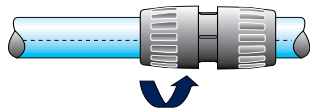

1. Loosen the nuts on the end of the pipe to be removed

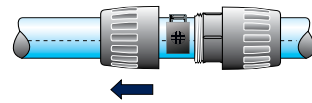

2. Slide the nuts away from the connectors

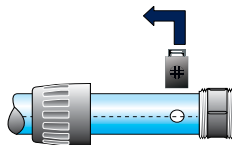

3. Remove the snap rings from their housings

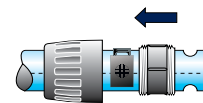

4. Loosen and slide the connector body away from the remaining attached nut

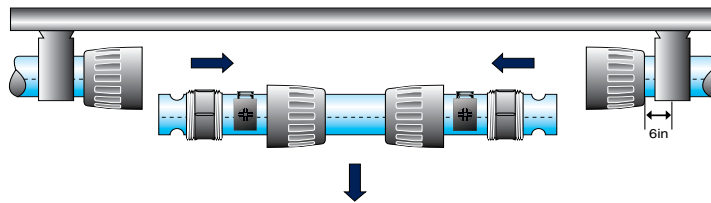

5. Repeat the process at the other end of the pipe and remove the pipe, along with the assembly components.

# TRANSAIR® 1½" REMOTE SHUT-OFF VALVE

## Application

The Transair 1-1/2" remote shut-off valve allows a branch of the system to be opened or closed at ground level or remotely.

The Transair® remote shut-off valve guarantees:

- Personal safety, by eliminating all hazards related to working at heights
- Servicing speed, by removing the need for special access equipment (ladder, platform etc)

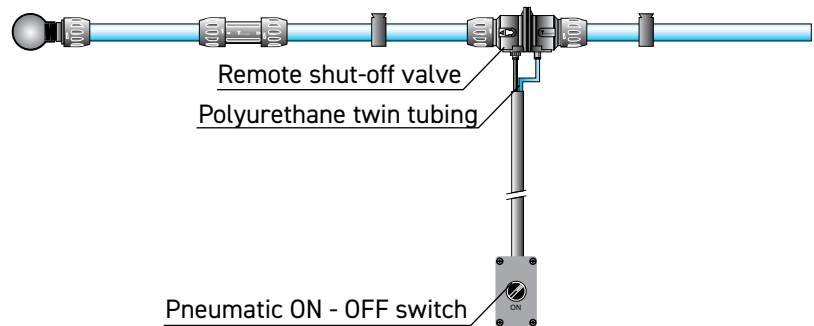

## Operating principle

Single acting valve - normally closed.

### For compressed air systems:

The valve control pressure can be taken upstream of the isolating valve, with no external power supply. Control is performed through the control unit connected to the valve by means of a push-in connector.

### For vacuum systems:

A compressed air supply external to the control unit is required, and the corresponding valve port must be closed in order to prevent loss.

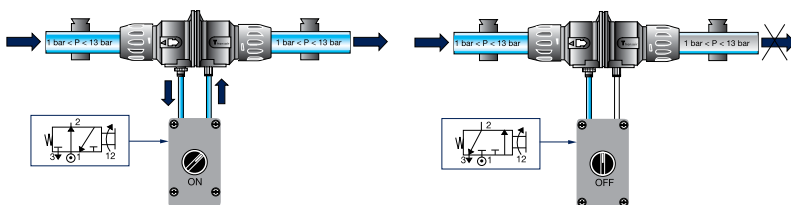

## DO'S

### ✓ Connection

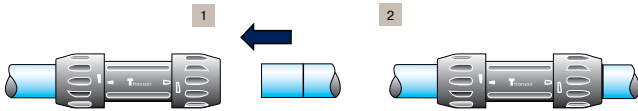

### ✓ Use a pipe cutter

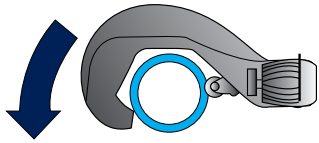

### ✓ Carefully chamfer and deburr the pipe after cutting or drilling

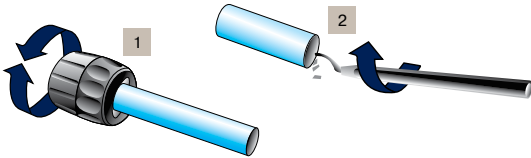

### ✓ Check that the pipe is correctly positioned in the connector

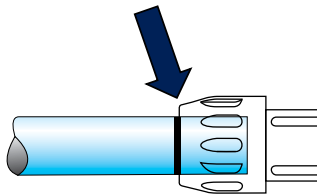

## DONT'S

### ✗ Loosen the nuts during assembly

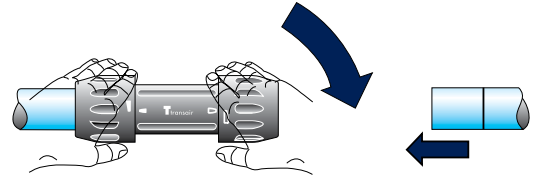

### ✗ Cut the pipe with a saw

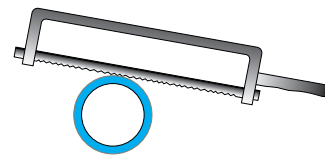

### ✗ Use non-deburred pipe

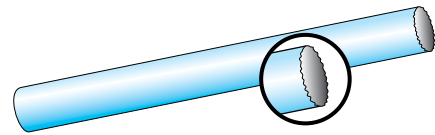

### ✗ Fail to make the pipe secure

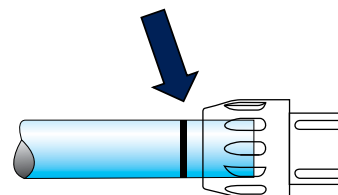

### ✗ Connect 1-1/2" end cap to reducing tee

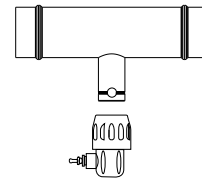

# QUICK ASSEMBLY BRACKETS

## General

The ability to easily add a new drop line on an existing system is an important consideration when selecting a compressed air piping system. Transair® quick assembly brackets are designed for quick and easy installation. These brackets have a "swan neck" design that prevents condensate water from dripping down the drop line. The small footprint of the quick assembly bracket allows for a drop line to be installed in the tightest places. These brackets can be used for vertical drops or horizontal branch lines.

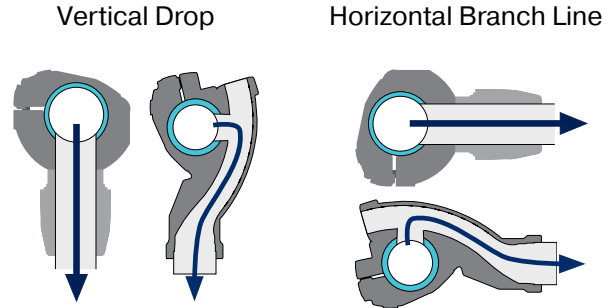

## Spacing Guidelines for Quick Assembly Brackets

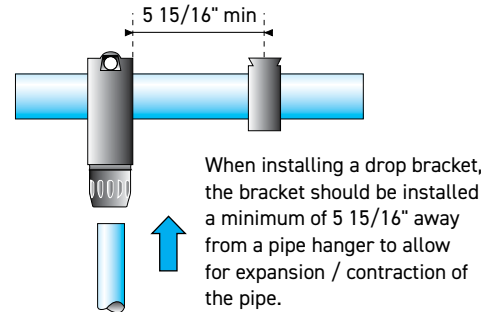
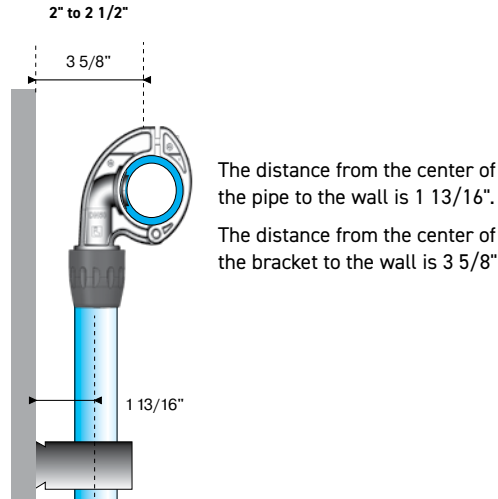
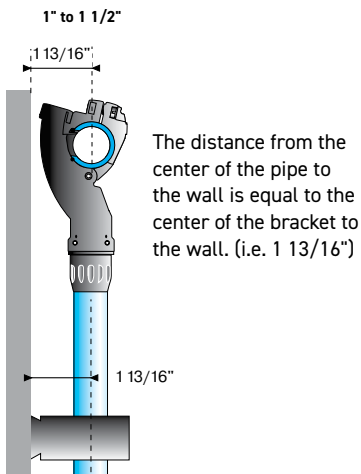

# INSTALLING A QUICK ASSEMBLY BRACKET

## 1", 1½", 2", AND 2½"

### Tools

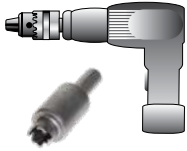

Drilling tool for aluminum pipe  
ref. 6698 02 02 or 6698 02 01



Drilling jig for aluminum  
pipe ref. 6698 01 01



Deburring tool for aluminum  
pipe ref. 6698 04 02



Permanent  
marker pen



5mm Allen  
Wrench

### Installation Process

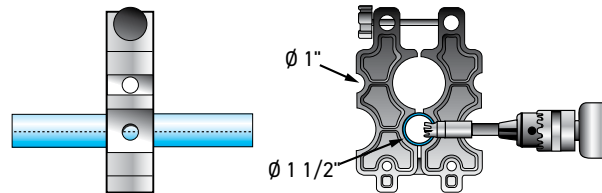

1. Mark the pipe at the desired location, using the dotted line locator marks. These marks will ensure all drop lines off a single piece of pipe will be uniformly aligned. Loosen the retaining bolt on the drilling jig and place it around the pipe. Align your locator mark in-line with the guide hole on the drilling jig. Once the jig is aligned close and tighten the jig. Lastly, place the appropriate drilling tool in your drill and drill the hole.

■ Do not lubricate the drill,

■ Suggested rotation speed: 650 rpm



2. Release the pipe from the jig. Next, remove any chips from the hole. Lastly, deburr the hole to ensure there are no rough edges to cut the seal.

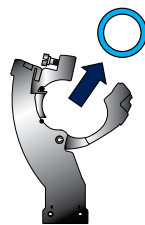

3. Position the quick assembly bracket over the hole. The bracket has a raised plug to fit into the drilled hole.

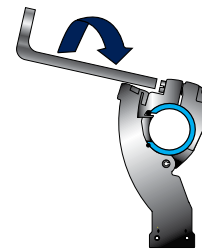

4. Tighten the screw using a 5mm allen wrench
5. Warning: Do not exceed 3.7 to 7.3 ft/lbs of torque when tightening the screw. Exceeding this limit can cause failure to the bolt and/or bracket.

# INSTALLING A BRACKET

## 3", 4" OR 6" PIPE

### Tools



Drilling tool for aluminum pipe  
ref. EW09 00 30 (3" - 4" ) or  
EW09 00 51 / EW09 00 64 (6")



Deburring tool for aluminum pipe  
ref. 6698 04 02

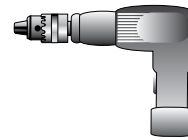

Drill

### Drop Bracket Installation Process

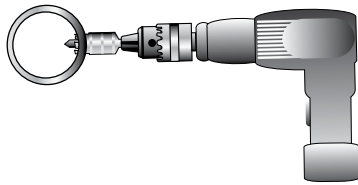

1. Mark the location for the drop bracket. Then using the appropriate drilling tool, drill the hole for the drop bracket.

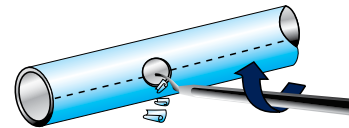

2. Remove any chips and carefully deburr the hole ensuring no rough edges are left behind.

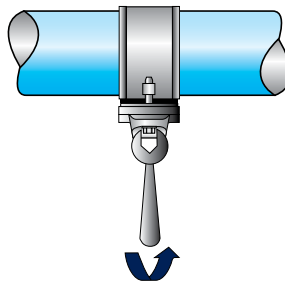

3. Position the plug of the bracket in the hole and tighten the bolts using a crescent wrench

Note: Use adapter ref. 6621 25 35 in combination with bracket ref. RR63 to create a 1" take-off point from 3" or 4" pipe.

## PRACTICAL EXAMPLES

### Installing Vertical and Horizontal drop brackets

Using the same locator mark

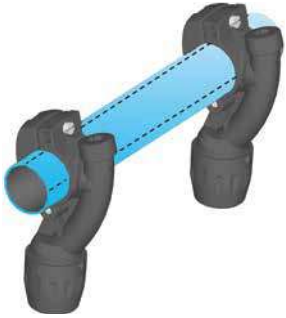

### Adding an off-set bracket

Using two locator marks



### Common drop bracket Assemblies

1. Transair pipe connected to push to connect drop bracket
2. Air hose connected to Transair drop bracket with a threaded plug
3. Transair safety coupler w/ quick plug threaded to a drop bracket.

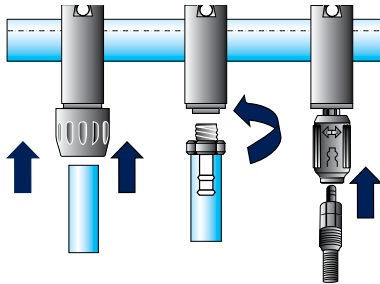

# PRESSURIZED SYSTEM BRACKET (HOT TAP)

This drilling tool is used to install a drop bracket to an existing, under-pressure system. This tool easily attaches to a standard drill.

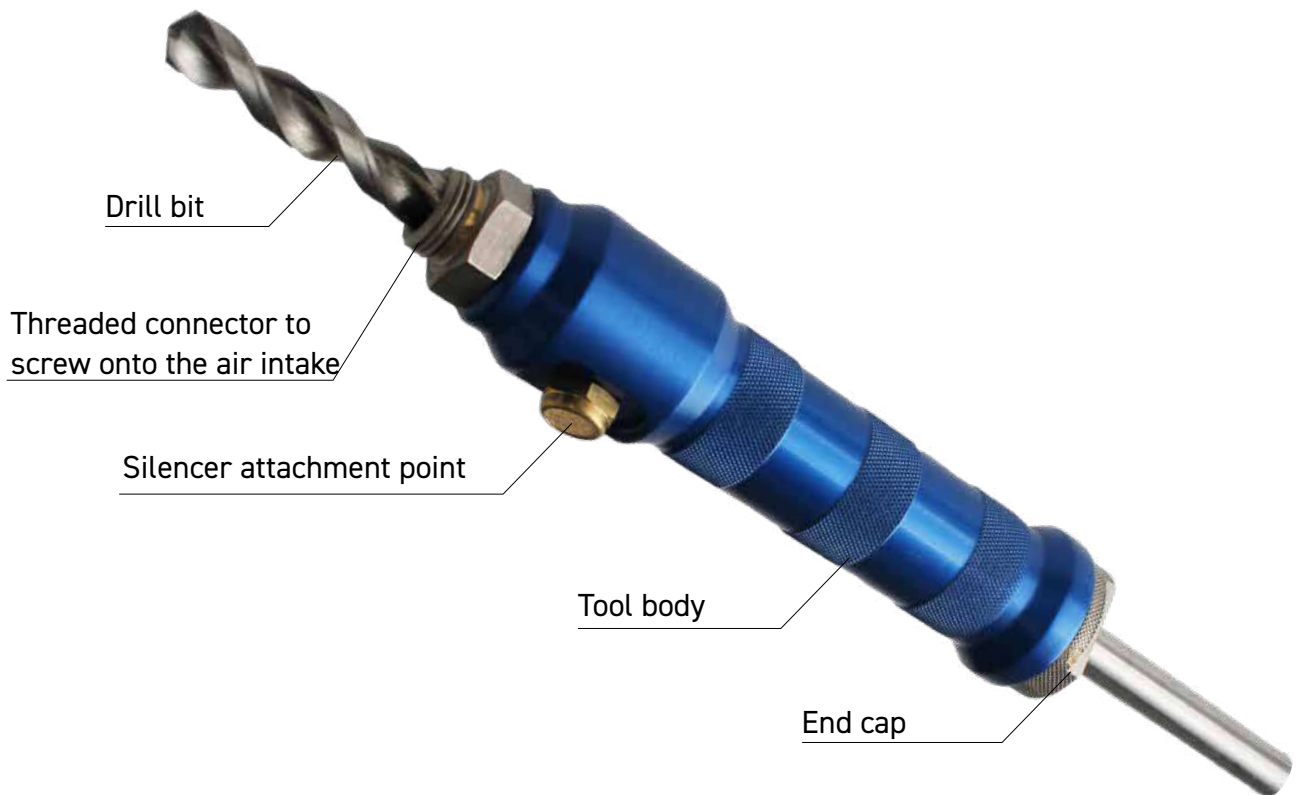

## Torque Ratings for Bracket Screws

Part No.	OD (in)	OD (mm)	Torque Rating (ft-lbs)
EA98 25 04	1	25	5.90 to 8.85
EA98 40 04	1-1/2	40	5.90 to 8.85
EA98 50 04	2	50	3.69 to 7.38
EA98 63 04	2-1/2	63	3.69 to 7.38

## Procedure



1. Position the hot tap bracket on the pipe and tighten with the recommended torque rating (see chart below)



2. Thread the drilling tool onto the ball valve. Ensure the valve is open then fully drill the hole.



3. Remove the drill and immediately close the ball valve



4. Dismantle the tool and remove chips between drillings.

# FLEXIBLE HOSE

## General

Transair flexible hoses can easily connect to Transair components and be installed without prior preparation or cutting.

Thanks to the tight bend radius, these hoses require minimum space and does not create mechanical stress on the system. These hoses are resistant to compressor oils as well as fire.

### Level change

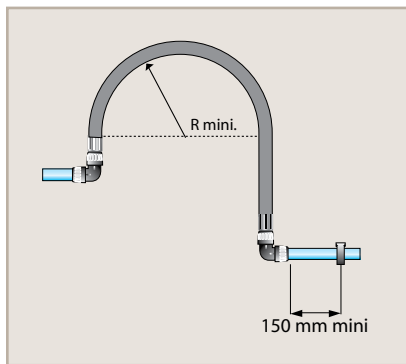

### Expansion loop

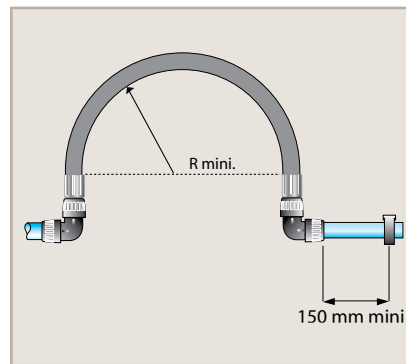

### Obstacle bypass

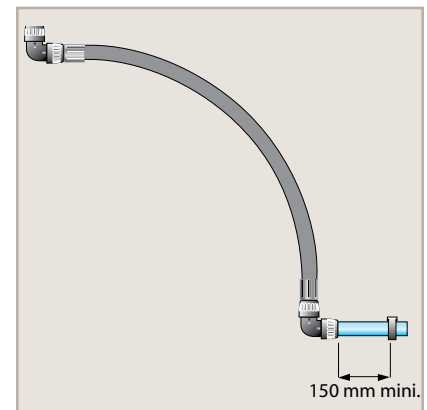

## Applications

Part No.	OD (in)	OD (mm)	L (ft)	Min. Bend Radius (in)
1001E25 00 01	1	25	1' 10"	4
1001E25 00 03	1	25	4' 11"	4
1001E40 00 02	1-1/2	40	3' 9"	16
1001E40 00 04	1-1/2	40	6' 6"	16
1001E50 00 09	2	50	6' 6"	11
1001E63 00 08	2-1/2	63	9' 10"	25
FP01 L1 01	3	76	4' 11"	14
FP01 L3 02	4	101	6' 6"	20



## Safety

### Anti-whiplash straps

In order to avoid whiplash accidents, Parker Transair suggests the use of an anti-whiplash strap installed on either side of the connection. (2 straps per hose).

If the hose breaks free of the connection, the strap will prevent the hose from failing around causing personal injury or damage to property. (The straps conform to the ISO 4414 safety standard)

Part No.	For Use With Transair Pipe Diameter
6698 99 03	1 to 4

# FLEXIBLE HOSE INSTALLATION PROCESS

## 1" TO 1½"

### Using a male threaded connector

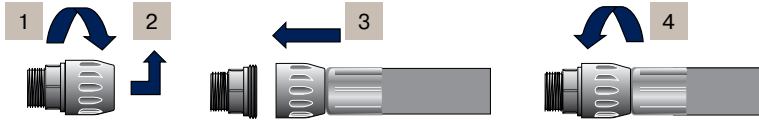

1. Loosen the nut on the threaded male connector
2. Remove the nut
3. Place the end of the hose onto the exposed threads of the male connector
4. Tighten the nut of the hose onto the threads

### Using a Union Connector

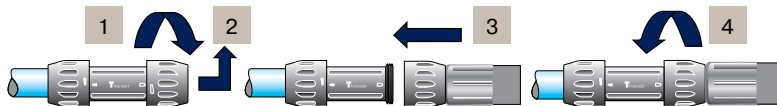

5. Loosen the nut of the union
6. Remove the nut
7. Place the end of the hose onto the exposed threads of the union
8. Tighten the nut of the hose onto the threads

### Using a 90° elbow

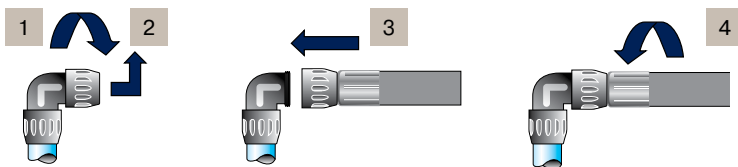

9. Loosen the nut of the elbow
10. Remove the nut
11. Place the end of the hose onto the exposed threads of the elbow
12. Tighten the nut of the hose onto the threads

# FLEXIBLE HOSE INSTALLATION PROCESS

## 2" TO 2½"

### Using a male threaded connector

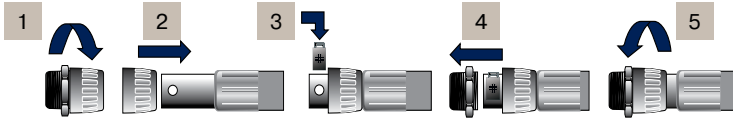

1. Remove the nut on the threaded male connector
2. Place the nut over the end of the flexible hose
3. Place the snap ring in the holes on the end of the hose
4. Thread the nut onto the threads of the connector
5. Tighten the nut one-half (1/2) turn using Transair spaner wrenches

### Using a Union Connector

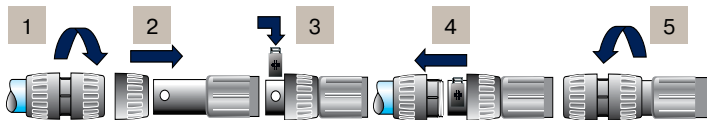

6. Remove the nut on the union connector
7. Place the nut over the end of the flexible hose
8. Place the snap ring in the holes on the end of the hose
9. Thread the nut onto the threads of the connector body
10. Tighten the nut one-half (1/2) turn using Transair spaner wrenches

### Using a 90° elbow

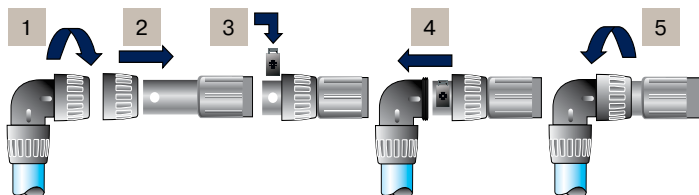

11. Remove the nut on the elbow
12. Place the nut over the end of the flexible hose
13. Place the snap ring in the holes on the end of the hose
14. Thread the nut onto the threads of the elbow body
15. Tighten the nut one-half (1/2) turn using Transair spaner wrenches

# FLEXIBLE HOSE INSTALLATION PROCESS 3" TO 6"

## Using a Union Connector

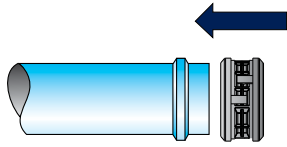

1. Slide the cartridge over the end of the pipe until it meets the lug

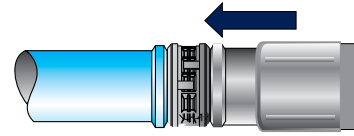

2. Bring the end of the hose to the cartridge and slide the end until the cartridge meets the lug of the hose.

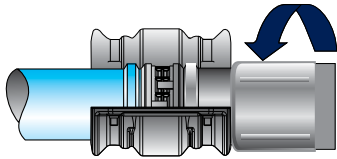

3. Position the clamshell connector over the cartridge/ pipe assembly. The cartridge should fall in the middle of the connector

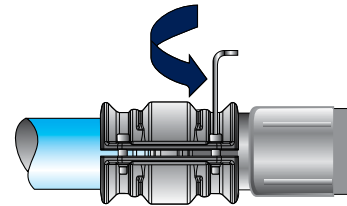

4. Hand-tighten the bolts in a cross pattern with an allen wrench. (see chart below for sizes)

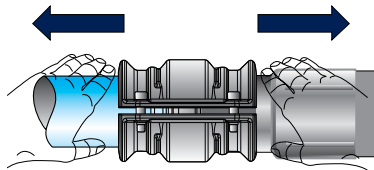

5. Pull the pipe and hose back towards the outside of the clamshell

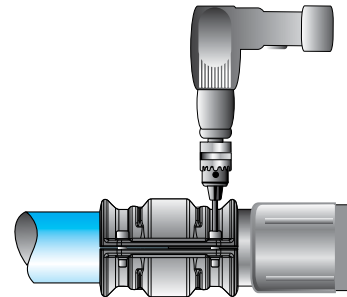

6. Using a drill, fully tighten the clamshell bolts in a cross pattern

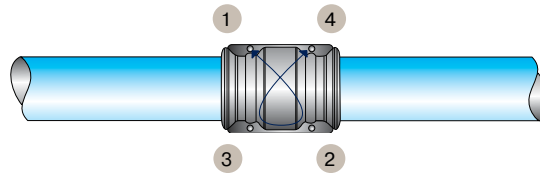

For effective sealing, follow the above diagram for securing the bolts in a cross pattern.

## Allen wrench sizes

Transair Diameter	Allen Wrench Size
3" (76mm)	6mm
4" (101mm)	6mm
6" (168mm)	8mm

## DO'S

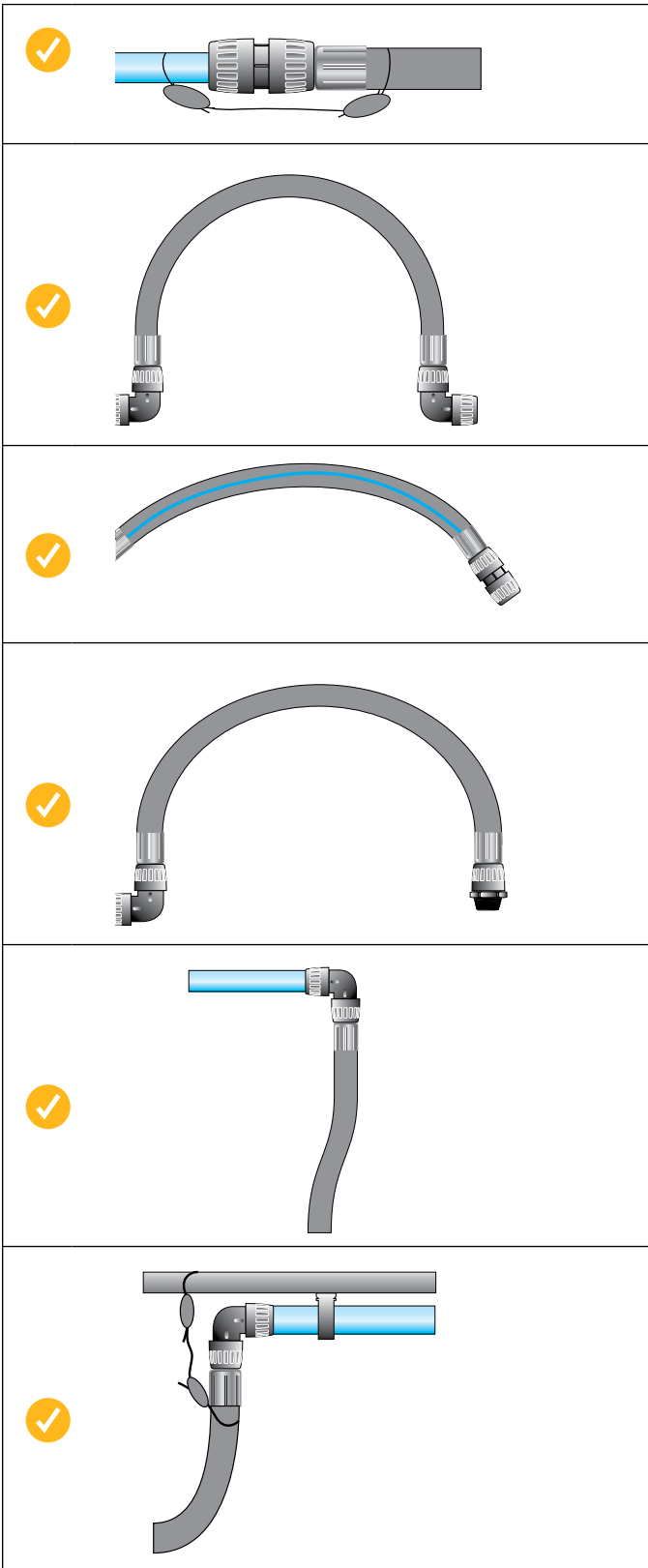

## DONT'S

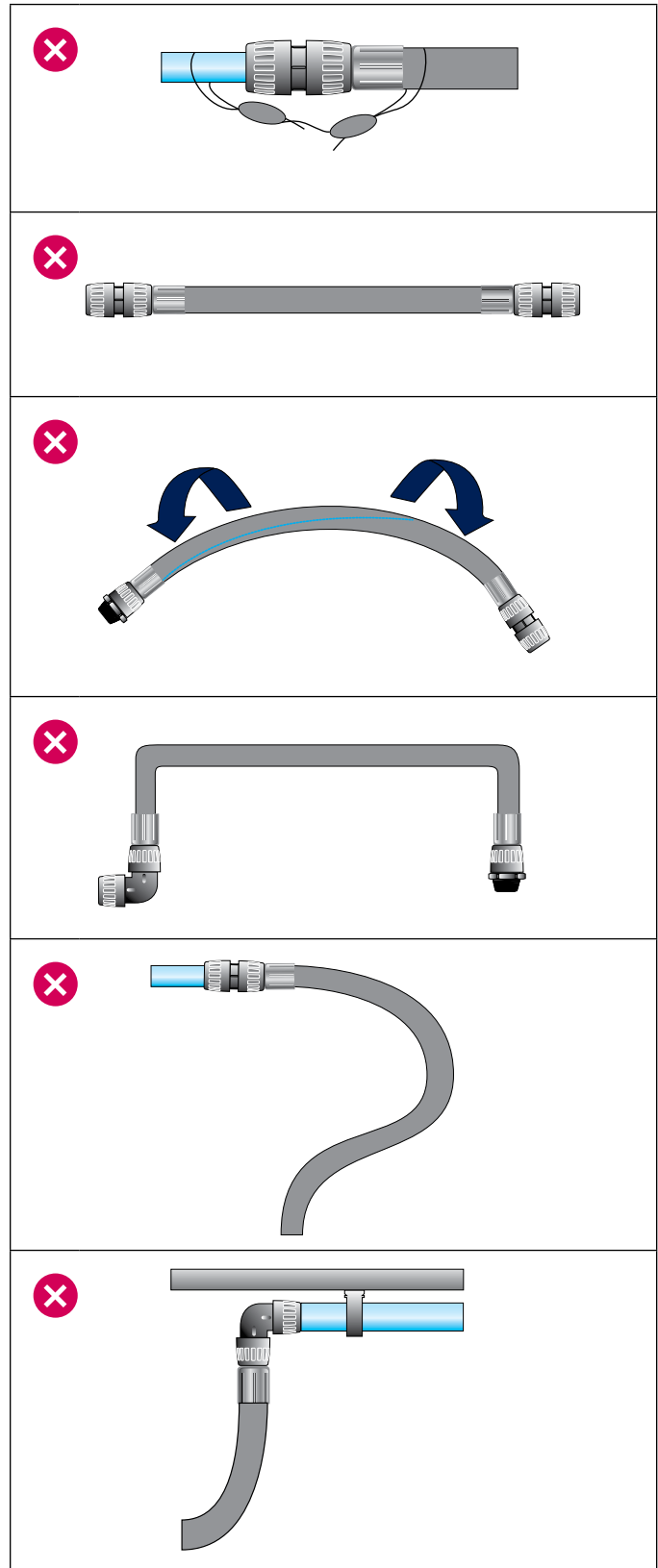

# PIPE HANGERS

## 1/2" TO 2 1/2" TRANSAIR ALUMINUM PIPE

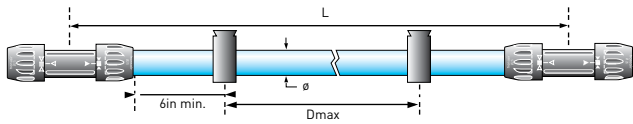

The Transair pipe hanger allows for the expansion and contraction of the pipe to freely occur. To ensure a stable piping system, Parker Transair suggests the use of at least 2 hangers per pipe. Transair aluminum pipe should only be mounted using genuine Transair pipe hangers.

Ø (in)	Ø (mm)	Pipe Length (ft)	Dmax (ft)
1/2	16.5	9	8
1/2	16.5	15	10
1	25	9	8
1	25	20	10
1-1/2	40	9	8
1-1/2	40	20	13
2	50	10	8
2	50	20	13
2-1/2	63	10	8
2-1/2	63	20	13

## 3" TO 6" TRANSAIR ALUMINUM PIPE

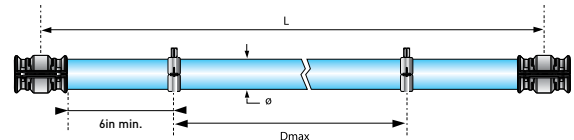

To ensure a stable piping system, Parker Transair suggests the use of at least 2 hangers per pipe. Transair aluminum pipe should only be mounted using genuine Transair pipe hangers.

Ø (in)	Ø (mm)	Pipe Length (ft)	Dmax (ft)
3	76	20	16
4	101	20	16
6	168	20	16

### Pipe Hanger Quick Facts

- Transair pipe hangers are installed / suspended using 3/8" threaded rod.
- 1/2" to 1-1/2" pipe hangers have a 1/4" female thread
- 2" & 2-1/2" pipe hangers have a 3/8" female thread
- For 1/2" to 1-1/2" hangers, Transair provides an adapter to convert the 1/4" threads to 3/8".

### Spacer

The Transair 6697 00 03 spacer is used for fitting a run of Transair using different diameters without introducing a bend.

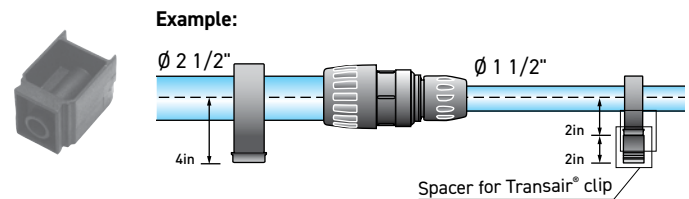

## INSTALLATION PROCESS 1/2" TO 2 1/2"

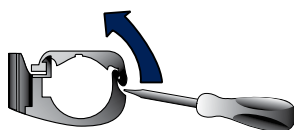

1. Install the pipe hanger where required and open using a screwdriver

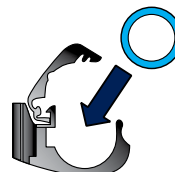

2. Insert the pipe into the pipe hanger



3. Close the pipe hanger

# SUPPORTING A TRANSAIR® SYSTEM

Directly onto a wall

Offset from a wall

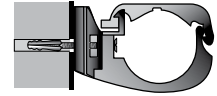
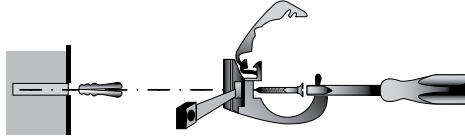

1. Remove the nut at the base of the pipe hanger. Using a screwdriver, insert the screw through the hanger and into the wall. If the hanger does not fall on a stud, use a wall anchor to secure the hanger.

2. Tighten the screw

## U-channel type mounting bracket

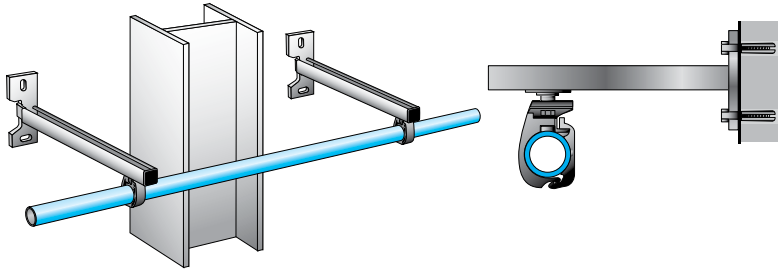

U-channel assemblies are used to offset systems and to bypass obstacles.

1/2" to 1 1/2"

2" - 2 1/2"

3" to 6"

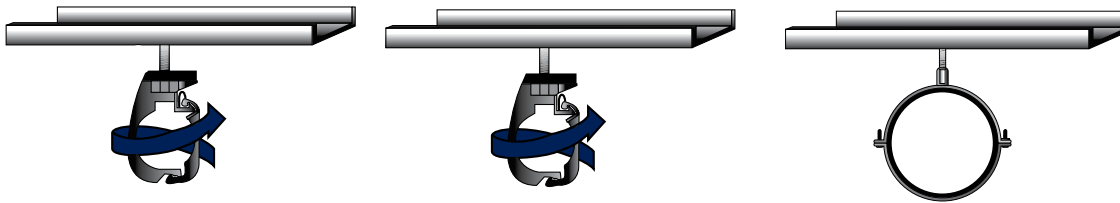

## Threaded rod adapter

The Transair® threaded rod adaptor allows 1/2", 1" and 1 1/2" Transair® pipe clips to be easily suspended under 3/8" threaded rod.

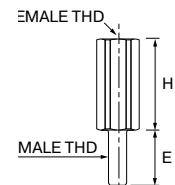

# BENDING TRANSAIR® ALUMINIUM PIPE

## All Diameters

Thanks to the material and manufacturing process, all Transair aluminum pipes can be bent to the following specifications:

Transair®	R Min. (in)	L Min. (in)
Ø 1/2	4	7.3
Ø 1	6	7.3
Ø 1-1/2	9.8	7.3
Ø 2	11.8	7.3
Ø 2-1/2	15.5	7.3
Ø 3	12.5	7.3
Ø 4	16.7	7.3
Ø 6	27.6	7.3

The above values have been validated in accordance to standard industrial bending techniques. (For more information on pipe bending, please contact us)

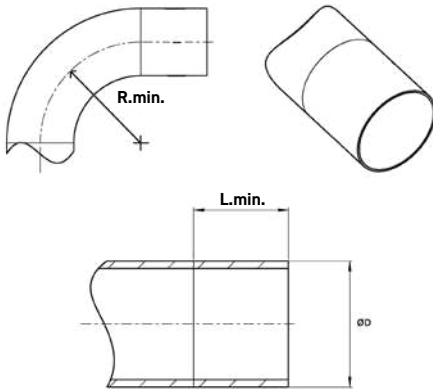

# COMMISSIONING A TRANSAIR ALUMINUM SYSTEM

Step 1: Equipment that is not subjected to the pressure test should be either disconnected from the Transair® piping system or isolated. Valves could be used for isolation provided that the valve closure is suitable for the proposed test pressure.

Step 2: Start the compressor(s) and pressurize at 45psi to check the integrity of the Transair® install and that compressor(s) are running correctly.

Step 3: Leave the system at 45 psi for 12 hours.

Step 4: After 12 hours, check the Transair® system for any pressure drop. If more than 10% pressure drop, compared to discharge pressure, has been lost, inspect the system for weeping or leaks at all joints and connections. Restart the test.

Step 5: Increase the compressor(s) discharge pressure to the system designed working pressure and leave the system at that pressure for a period of 4 hours. If more than 10% pressure drop, compared to discharge pressure, has been lost, inspect the system for weeping or leaks at all joints and connects. Restart the test.

Step 6: Increase the compressor(s) discharge pressure to 1.4X the system designed working pressure. Inspect the Transair® piping system for weeping or leakage.

Step 7: Purge the system and pressurize to designed max operating pressure.

## Considerations:

1. If a certification of the Transair® system is required, follow guidelines outlined by ASME B31.1
2. Certificates for manufacturing process quality (i.e. ISO 9001) and product conformity (i.e. CE, Qualicoat, etc.) are available upon request.
3. The Transair® team can also provide BIM (Building Information Modeling) support, system calculations, design consultations, etc.

Pressure tests are not to exceed max working pressure of Transair (188psi for 6" and 232psi for ½ to 4")

**For support or copies of our certifications, please contact Transair customer service!**

Email: [transaircustomerservice@parker.com](mailto:transaircustomerservice@parker.com)

Phone: (480) 830-7764

# CALCULATING EXPANSION/CONTRACTION

**For Transair® 1/2" - 4" aluminum pipe systems:**

$$\frac{\Delta L = (a \times L)}{1} + \frac{(0.024 \times L \times \Delta T)}{2}$$

L: length of Transair® straight line to be installed (in m)

ΔT : difference between temperature when installing and maximum operating temperature (in °C)

ΔL: line length variation (in mm)

- Expansion related to pipe retraction in the connector
- Expansion related to temperature variations

	Ø 1/2"	Ø 1"	Ø 1 1/2"	Ø 2"	Ø 2 1/2"	Ø 3"	Ø 4"	Ø 6"
9 ft pipe	a=0.06	a=0.20	a=0.56	-	-	-	-	-
10 ft pipe	-	-	-	a=0.56	a=0.73	-	-	-
20 ft pipe	-	a=0.10	a=0.20	a=0.29	a=0.38	a=0.50	a=0.50	a=0.67

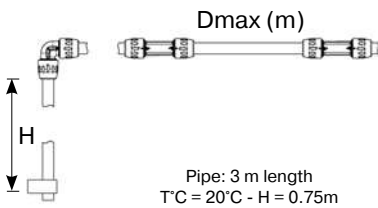

### Case no. 1:

Maximum distance, without expansion loop, from a fixed point dependant on Transair® diameter (2 elbows)

Ø Transair®	1/2	1	1 1/2	2	2 1/2	3	4
Dmax. (m)	50	40	30	24	24	15	15

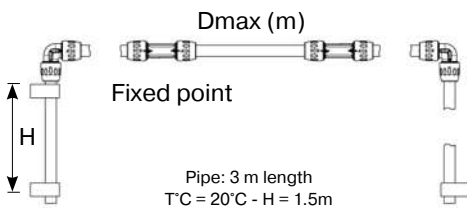

### Case no. 2:

Maximum distance, without expansion loop, dependant on Transair® diameter

Ø Transair®	1/2	1	1 1/2	2	2 1/2	3	4
Dmax. (m)	50	40	30	24	24	15	15

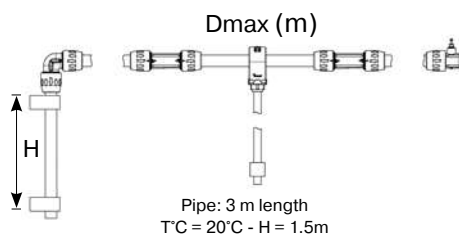

### Case no. 3:

Maximum distance for installing a bracket, without expansion loop, dependant on Transair® diameter (1 elbow - 1 bracket)

Ø Transair®	1/2	1	1 1/2	2	2 1/2	3	4
Dmax. (m)	48	38	30	25	25	7.5	7.5

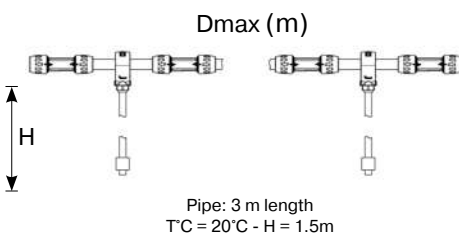

### Case no. 4:

Maximum distance for installing a bracket, without expansion loop, dependant on Transair® diameter (2 brackets)

Ø Transair®	1/2	1	1 1/2	2	2 1/2	3	4
Dmax. (m)	80	70	55	40	40	15	15

# PRACTICAL INFORMATION

## Direction change

In addition to expansion loops, changes of direction are another method of compensating for expansion and contraction.

- For Transair® 1/2" to 2 1/2" aluminum pipe systems
  - H= 29.5"     $\Delta L1 = 0.6"$
  - H= 59.1"     $\Delta L1 = 1.2"$

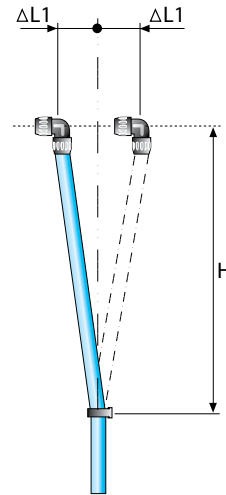

## Using an elbow

- For Transair® 3" to 6" aluminum pipe systems
  - H= 29.5"     $\Delta L1 = 3/8"$
  - H= 59.1"     $\Delta L1 = 6/8"$

## Using a quick assembly bracket

- For Transair® 1/2" to 2 1/2" aluminum pipe systems

Ø1 (in)	Ø2 (in)	H (ft)	ΔL2 (in)	ΔL3 (in)
1	1/2	5	1/2	1
1	1	5	1/2	1
1 1/2	1/2	5	1/2	1
1 1/2	1	5	1/2	1
2	1/2	5	1/2	1
2	1	5	1/2	1
2 1/2	1	5	1/2	1

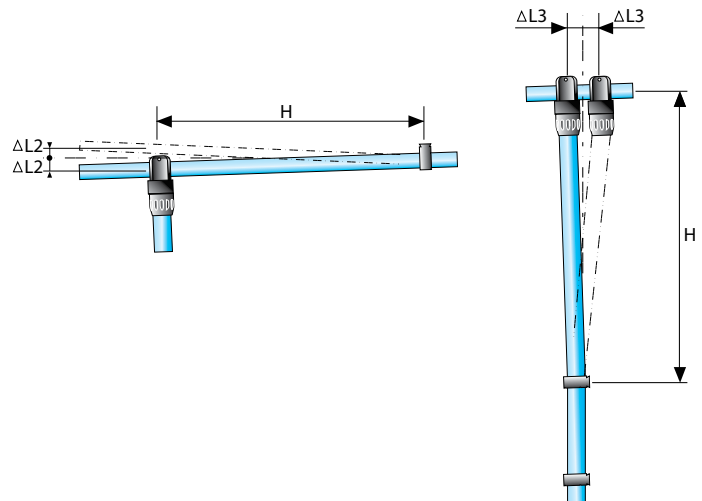

The length variation  $\Delta L$ , calculated for the Transair® line, must always be equal to or less than  $\Delta L2$  and  $\Delta L3$ . If this is not the case, then an expansion loop, using Transair® flexible hose, must be added.

# PRACTICAL INFORMATION

## Expansion / Contraction

### Changing direction with a tee

For Transair® 3" - 6" aluminum pipe systems

Ø (in)	Ø (mm)	H (ft)	ΔL2 maxi (in)	ΔL3 maxi (in)
3	76	2 1/2	3/8	3/8
4	101	2 1/2	3/8	3/8
6	168	2 1/2	3/8	3/8

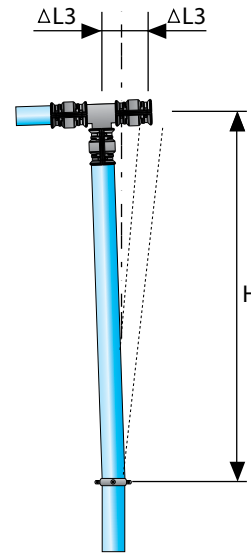
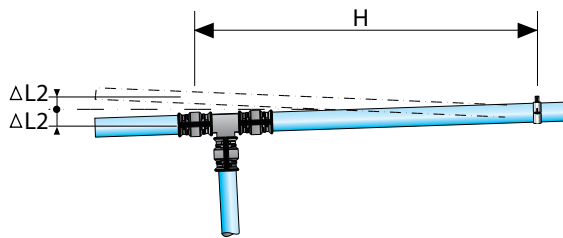

## Expansion Loop

$$\Delta L \text{ (in mm)} = H \text{ (in m)} \times 40$$

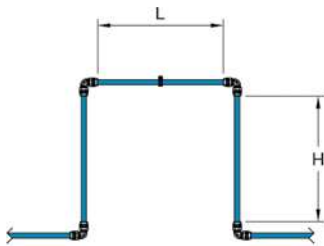

Maximum compensation:  
 Ø1/2" mm to Ø2-1/2" mm:

$$\Delta L \text{ (in mm)} = H \text{ (in m)} \times 27$$

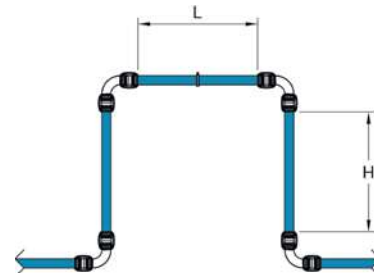

Maximum compensation:  
 Ø3" mm to Ø6" mm

## Z DIMENSIONS

	Z	Z1	Z2
4002 40 00	-	4 13/16	2 1/4
4002 63 00	-	3 5/16	3 7/8
4089 17 00	-	1 1/8	1 11/16
4099 17 00	-	1 1/8	1 11/16
4099 25 00	-	1 9/16	2 3/16
4230 00 40	3 3/8	-	-
6612 25 00	1 1/8	-	-
6612 40 00	1 3/4	-	-
6612 63 00	2 3/8	-	-
6602 17 00	1 1/4	-	-
6602 25 00US	1 9/16	-	-
6602 40 00US	2 7/16	-	-
6602 50 00	2 1/4	-	-
6602 63 00	2 3/8	-	-
6604 17 00	-	1 5/16	1 1/4
6604 25 00US	-	1 7/8	1 9/16
6604 40 00US	-	2 1/4	2 1/4
6604 50 00	-	2 3/16	2 3/16
6604 63 00	-	2 7/16	2 7/16
6604 63 40	-	2 7/16	4 9/16
6606 17 00	1 5/16	-	-
6606 25 00US	1 7/8	-	-
6606 40 00US	2 1/4	-	-
6606 50 00	1	-	-
6606 63 00	1	-	-
6651 25 12 04	4 1/4	-	-
6651 40 12 04	5 15/16	-	-
6662 25 00	1 7/8	-	-
6662 25 17	3 1/4	-	-
6662 40 17	3 1/2	-	-

	Z	Z1	Z2
6662 40 25	3 1/4	-	-
6662 50 25	2 5/16	-	-
6662 63 25	3	-	-
6666 17 25	2	-	-
6666 25 40	2 13/16	-	-
RA02 L8 00	7 1/4	-	-
RA04 L8 00	-	7 1/16	7 5/16
RA04 L8 L3	-	6 1/2	7 5/16
RA04 L8 L1	-	6 1/2	7 5/16
RA04 L8 63	-	6 1/2	8 11/16
RA66 L8 L1	210	-	-
RA66 L8 L3	210	-	-
RA69 25 17	1 7/8	-	-
RA69 40 25	2 1/4	-	-
RA69 50 25	2 5/8	-	-
RX02 L1 00	7 7/16	-	-
RX02 L3 00	8 11/16	-	-
RX04 L1 00	-	5 11/16	5 11/16
RX04 L3 00	-	6 1/8	5 5/16
RX04 L3 L1	-	6 1/8	5 5/16
RX24 L1 40	-	5 11/16	4 1/8
RX24 L1 63	-	5 11/16	6 7/16
RX24 L3 40	-	6 1/8	4 5/8
RX24 L3 63	-	6 1/8	6 15/16
RX64 L1 63	13 7/8	-	-
RX64 L3 63	14 5/8	-	-
RX66 L3 L1	7 5/8	-	-
VR02 L1 00	4 9/16	-	-
VR02 L3 00	4 7/8	-	-
VR02 L8 00	5 1/16	-	-

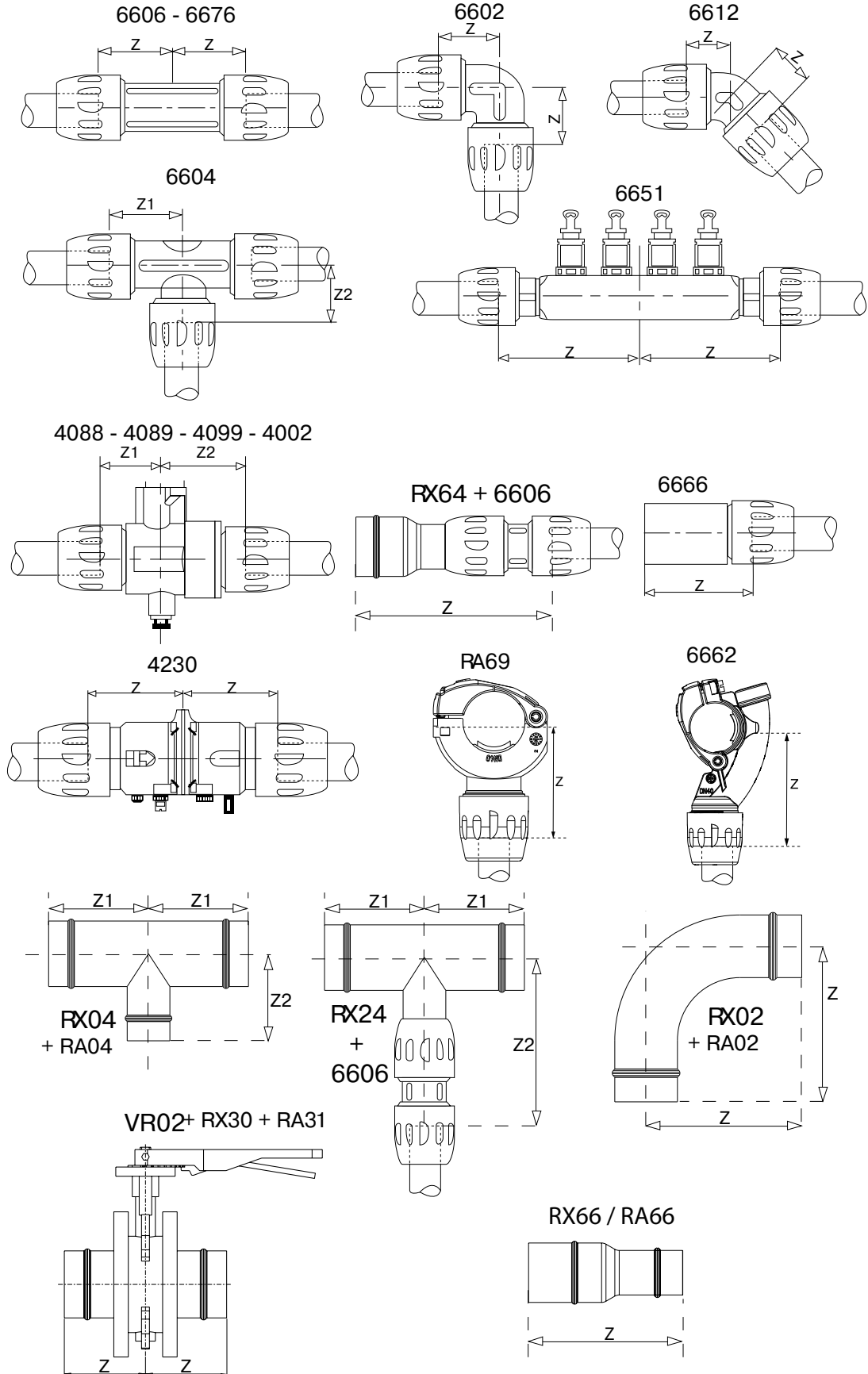

# TRANSAIR 316L DROPS INSTALLATION PROCESS

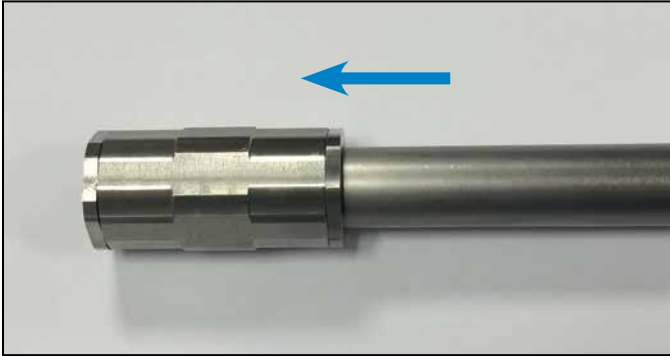

## Assembly:

Simply push the pipe into the fitting.



## Disassembly:

1. Manually unscrew the nut and slide the nut along the pipe.



## Disassembly:

2. Put the red dismounting ring on the pipe and re-screw the nut on the fitting.

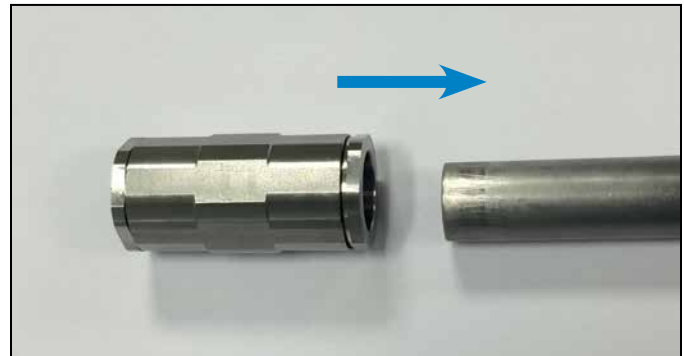

## Disassembly:

3. Pull the pipe from the fitting.

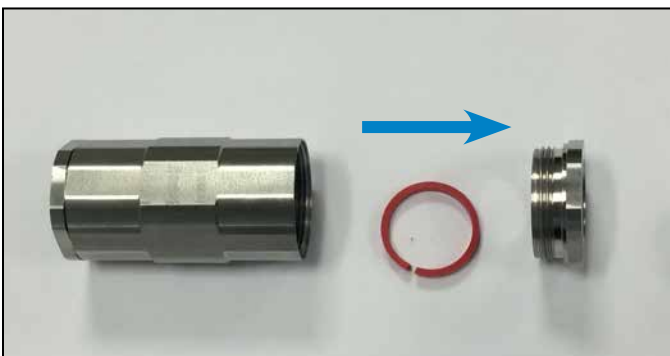

## Disassembly:

4. Manually unscrew the nut and remove the red dismounting ring.

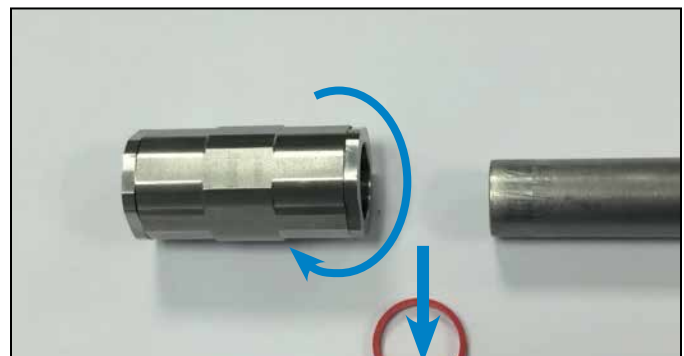

## Disassembly:

5. Re-screw the nut on the fitting without the red ring; it is ready for assembly.

These components can quickly and easily connect to existing Transair aluminum or stainless steel systems with threaded drop brackets.



# STAINLESS STEEL INSTALLATION GUIDE

# TRANSAIR STAINLESS STEEL INSTALLATION GUIDELINES

## Specifications:

<b>Max Working Pressure</b>	145psi from -4° to +140° F (10 bar from -20° to +60° C)
<b>Vacuum:</b>	99.9% (0.03" Hg / 1mbar)
<b>Working Temperature</b>	-4° to +140° F (-20° to +60° C)

\* Please consult us for higher temperature requirements

## General

Prior to the Installation of a Transair® system, the installer should ensure the installation area complies with all safety and hazard regulations. Transair® can be installed in the compressor room, as well as downstream for the distribution piping system. Transair® flexible hoses can be installed to dampen sources of vibration.

When modifying or repairing a Transair® system, ensure the section of pipe where work will take place has been properly vented prior to beginning modifications.

Only genuine Transair® parts should be used for installation. The use of non-Transair® parts with Transair® parts will result in the 10 year warranty being voided. Refer to the technical data in Transair® Catalog 3515 for proper sizing and selection of components.

## Pressurizing the system

Once the Transair® system installation has been completed, and prior to pressurizing the system, the installer should complete all tests, inspections, and compliance checks according to customer requirements, engineering best practices, and building code regulations.

## Transair® pipe and hoses

Transair® piping needs to be protected from mechanical impact. All Transair® piping systems should be installed out of reach of fork-lifts and above overhead material handling cranes.

Only use genuine Transair® connectors to connect sections of pipe. Transair® pipe should never be welded, soldered, or glued. Transair® Flexible hoses can be installed to route around obstacles following proper installation guidelines.

Note: In certain situations, Transair® piping can be bent - contact the factory for further information.

## Expansion / contraction

Prior to installation, ensure the expansion and contraction of the piping system has been properly calculated. The elongation and retraction of each Transair® line should be calculated according to the information found in this installation guide.

## Component assembly

For proper installation of a Transair® System, follow the steps outlined in this document.

When installing Transair® piping, avoid the following

- Installing within a solid mass (concrete, foam, etc)
- Hanging external equipment from Transair® pipe
- Using Transair® for grounding, or conduit for electrical wires.
- Exposing Transair® components to incompatible chemicals. (Contact the factory for further information)

## Compressed Air System Design Best Practices

- When installing a Transair system, ensure you follow all local building code regulations
- To reduce the occurrence of pressure drop, eliminate excessive use of elbows and keep the use bypasses and in-line pipe reductions to a minimum.
- Maintain consistent, high quality compressed air through the use of filtration elements in the compressor room and point of use.
- Size the diameter of the pipe according to the required flow rate and the acceptable pressure drop at the point of use.
- Install air drops as close as possible to the point of use.



### WARNING

This product can expose you to chemicals including Lead and Lead Compounds which is known to the State of California to cause cancer and birth defects or other reproductive harm. For more information go to [www.P65Warnings.ca.gov](http://www.P65Warnings.ca.gov)



3/4" (22mm)

Deburred and chamfered pipe



3" (76mm)  
4" (101mm)

Pipe lugged at each end,  
deburred and chamfered

## General Information

Transair® stainless steel pipe is supplied "ready for use". No particular preparation (cutting, deburring, chamfering, etc.) is required. Thanks to the rigidity of Transair® stainless steel pipe, temperature-related expansion / contraction phenomena are reduced to a minimum. The Transair® network retains its straightness, and hence its performance, over time (reduction of pressure drop caused by surface friction). Transair® stainless steel pipe is calibrated and fits perfectly onto all Transair® components. Each connection is automatically secured and sealing is, thus, optimized. The use of Transair® stainless steel pipe minimises corrosion.

Standards	3/4" (22mm)	3" to 4" (76mm to 101mm)
Manufacturing Standards	EN 10217-7	EN 10217-7
Grade	EN 10088-2, 1.4404 / AISI 316 L	1.4301 / AISI 304
Welding Standards	Din 17 457, EN 10217-7	Din 17 457, EN 10217-7
Tolerances	DVGW - W541	EN 1127 D4 / T3

## Volume and Mass

Outside Diameter		Inside Diameter		Volume		Pipe Mass		System Mass (Full Of Water)	
(in)	(mm)	(in)	(mm)	Gallon	Liter	(lb)	(kg)	(lb)	(kg)
3/4	22	0.77	19.6	0.07	0.3	1.38	0.63	2.04	0.93
1	28	1	25.6	0.13	0.51	1.78	0.81	2.91	1.32
3	76	2.87	72.9	1.10	4.17	6.52	2.96	15.72	7.13
4	101	3.84	97.6	1.97	7.48	10.89	4.94	27.39	12.43

Values are for 3' (1m) of pipe



### WARNING

This product can expose you to chemicals including Lead and Lead Compounds which is known to the State of California to cause cancer and birth defects or other reproductive harm. For more information go to [www.P65Warnings.ca.gov](http://www.P65Warnings.ca.gov)

# PIPE CUTTING 3/4" STAINLESS STEEL PIPE

## Tools



Pipe-Cutter  
6698 03 01



Chamfering Tool  
6698 04 01



Deburring Tool  
6698 04 02



Marker Pen

## Pipe Cutting Process

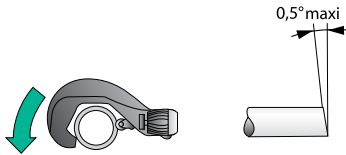

### 1. Cutting the pipe:

- Position the blade of the cutter on the pipe, then rotate the pipe cutter around the pipe, gently tightening the blade wheel after each pass.

The cutter cannot be more than 0.5 degrees off of square while cutting.

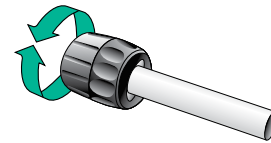

### 2. Carefully chamfer the outer edges



### 3. Deburr the interior edge of the pipe

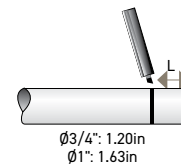

### 4. Using a tape measure, mark the insertion depth of the connector.



## WARNING

This product can expose you to chemicals including Lead and Lead Compounds which is known to the State of California to cause cancer and birth defects or other reproductive harm. For more information go to [www.P65Warnings.ca.gov](http://www.P65Warnings.ca.gov)

# PIPE CUTTING 3" TO 4" STAINLESS STEEL PIPE

## Tools



Pipe-Cutter  
6698 03 01



File



Deburring Tool  
6698 04 02



Portable Tool Kit  
Ref. EW01 00 02



Pipe Forming Jaw Set  
Ref. EW02 L1 00 (Ø 76)  
EW02 L3 00 (Ø 101)

## Pipe Cutting Process

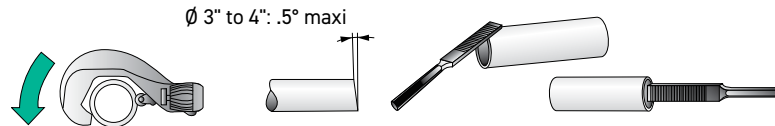

### 1. Cutting the pipe:

- Position the blade of the cutter on the pipe, then rotate the pipe cutter around the pipe, gently tightening the blade wheel after each pass.

The cutter cannot be more than 0.5 or 1 degrees off of square while cutting. (depending on diameter)

### 2. Carefully chamfer and deburr the edge of the pipe with a file.



### WARNING

This product can expose you to chemicals including Lead and Lead Compounds which is known to the State of California to cause cancer and birth defects or other reproductive harm. For more information go to [www.P65Warnings.ca.gov](http://www.P65Warnings.ca.gov)

## Preparing the portable lugging tool



1. Open the retaining pin at the front of the machine by pressing the jaw to release button\*.



2. Place the jaw in the housing.



3. Lock into position by closing the retaining pin.

## Creating the Lugs



1. Manually open the jaw and insert the stainless steel pipe until the pipe meets the stop in the jaw.



2. Release the jaw then press the trigger and lug the pipe until a "snap" is heard.



3. Re-open the jaw to remove the pipe. Position the end of the jaw next to the lug mark: this will help to prevent overlapping the lugs.



4. Repeat the operation until the required minimum of lugs for each diameter have been achieved.



### WARNING

This product can expose you to chemicals including Lead and Lead Compounds which is known to the State of California to cause cancer and birth defects or other reproductive harm. For more information go to [www.P65Warnings.ca.gov](http://www.P65Warnings.ca.gov)

# PIPE-TO-PIPE CONNECTORS FOR STAINLESS STEEL

## 3/4"

### Instant Connection by Means of a Gripping Ring

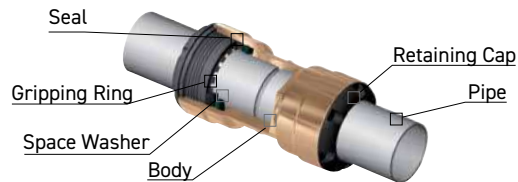

In size 3/4" (22mm), Transair stainless steel pipe uses push to connect technology. Simply push the pipe into the connector until it meets the depth mark on the pipe. The gripping ring will then engage and prevent the pipe from sliding out of the connector.

## 3" TO 4"

### Clamp Quick-Fit Connection

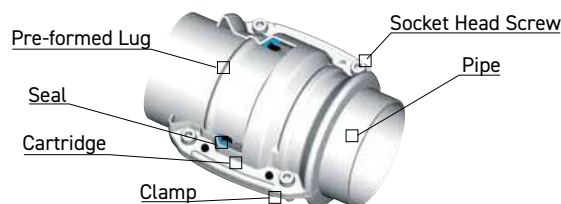

Pipe-to-pipe and stud connectors in  $\varnothing 76$  and  $\varnothing 101$  can be quickly connected to Transair® stainless steel pipe. Position the pipes to be connected within the Transair® cartridge and close/tighten the Transair® clamp.



#### WARNING

This product can expose you to chemicals including Lead and Lead Compounds which is known to the State of California to cause cancer and birth defects or other reproductive harm. For more information go to [www.P65Warnings.ca.gov](http://www.P65Warnings.ca.gov)

# CONNECTOR CONNECTION AND DISMANTLING PROCESS

## 3/4"

### Tools



Dismounting Tool EW11 00 01

### Connection

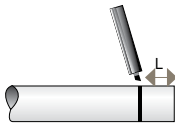

Ø3/4": 1.20in  
Ø1": 1.63in

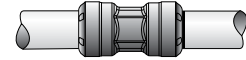
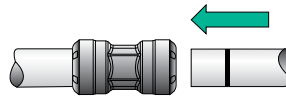

- Using a tape measure, mark the insertion depth on the pipe.

- Insert the pipe into the connector until the line meets the edge of the connector

### Disconnection

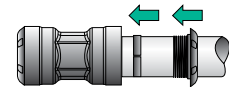
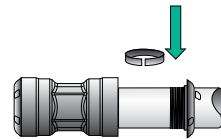
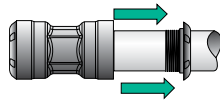
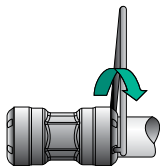

- Place the prongs of dismounting tool in pegs on opposite ends of the pipe. Turn the tool counter-clockwise to release the end cap.

- Un-thread the end cap and pull away from the body

- Place the appropriate dismounting ring (depending on diameter size of the connector) around the pipe in-between the body and cap.

- Insert the dismounting ring into the connector body and return the end cap.

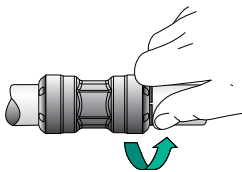

- Hand tighten the end cap

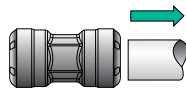

- Remove the connector from the pipe

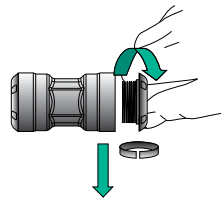

- Un-thread the end cap and remove the dismounting ring

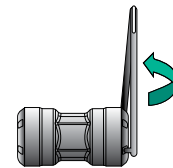

- Return the end cap and use the dismounting tool to thread the cap back onto the body.

### WARNING

This product can expose you to chemicals including Lead and Lead Compounds which is known to the State of California to cause cancer and birth defects or other reproductive harm. For more information go to [www.P65Warnings.ca.gov](http://www.P65Warnings.ca.gov)

## 3" TO 4"

### Connection/Disconnection

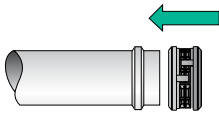

1. Slide the cartridge over the end of the first pipe until it meets the lug

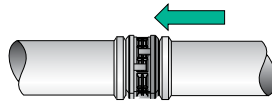

2. Bring the second pipe to the cartridge and slide the pipe until the cartridge meets the lug

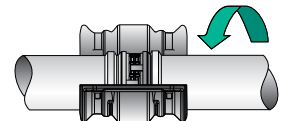

3. Position the clamshell connector over the cartridge / pipe assembly. The cartridge should fall in the middle of the connector

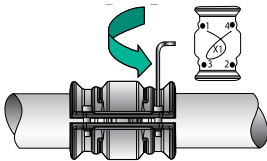

4. Hand-tighten the bolts in a cross pattern with an allen wrench. see chart below for sizes)

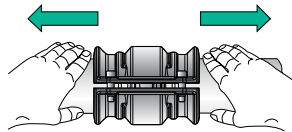

5. Pull the pipes back towards the outside of the clamshell

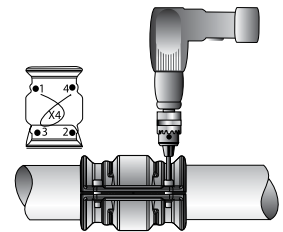

6. Using a drill, fully tighten the clamshell bolts in a cross pattern  
Torque Specs: 7.38 lb-ft to 29.5 lb-ft

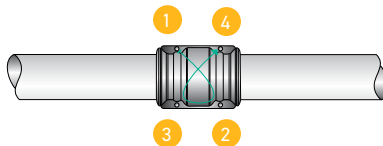

For effective sealing, follow the above diagram for securing the bolts in a cross pattern.

### Disconnection

To disconnect the connector, perform the same steps, but in reverse order.

### Allen Wrench Sizes

Transair Diameter	Allen Wrench Size
3" (76mm)	6mm
4" (101mm)	6mm



#### WARNING

This product can expose you to chemicals including Lead and Lead Compounds which is known to the State of California to cause cancer and birth defects or other reproductive harm. For more information go to [www.P65Warnings.ca.gov](http://www.P65Warnings.ca.gov)

# PRACTICAL EXAMPLES

Various Ø3" and Ø4" configurations

Installing a 90° elbow

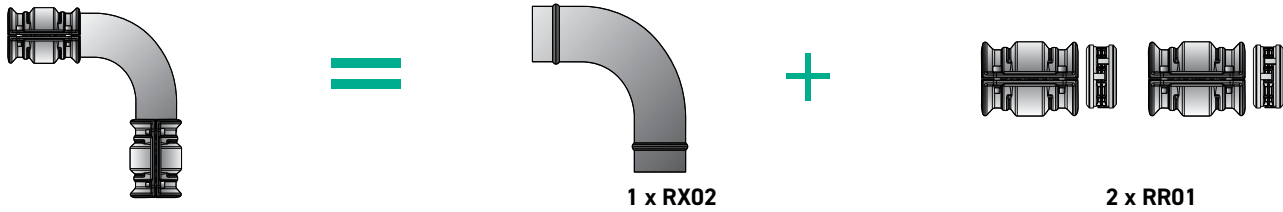

Installing a tee

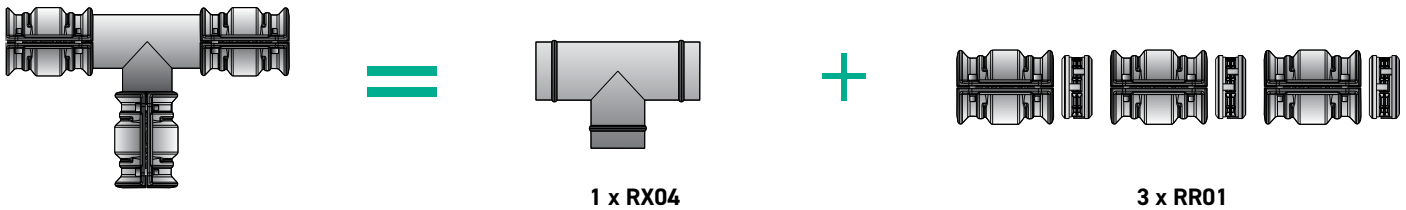

Installing an end cap

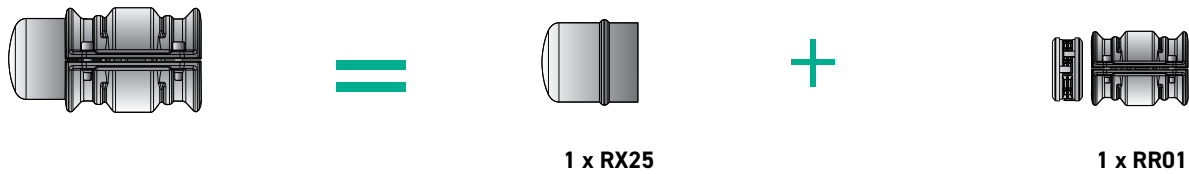

## WARNING

This product can expose you to chemicals including Lead and Lead Compounds which is known to the State of California to cause cancer and birth defects or other reproductive harm. For more information go to [www.P65Warnings.ca.gov](http://www.P65Warnings.ca.gov)

## Installing a flange and connector

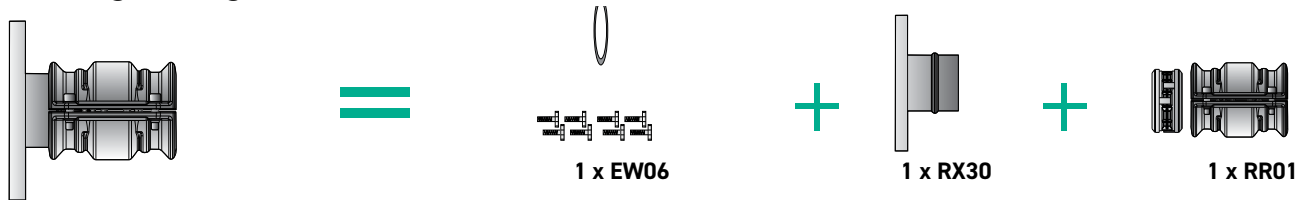

## Reducing from 4" to 3"



## Installing a butterfly valve

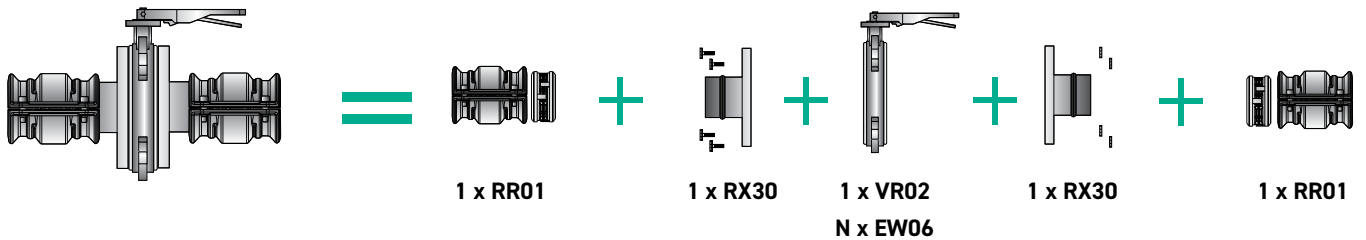

### WARNING

This product can expose you to chemicals including Lead and Lead Compounds which is known to the State of California to cause cancer and birth defects or other reproductive harm. For more information go to [www.P65Warnings.ca.gov](http://www.P65Warnings.ca.gov)

# DROP BRACKETS

## 3" TO 4" PIPE

### Tools



Drilling Tool For Transair® Stainless Steel Pipe  
EW09 00 30



Deburring Tool For Transair® Stainless Steel  
Pipe  
6698 04 02

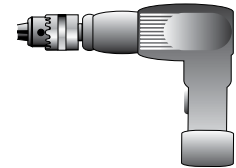

Drill

### Installation Process

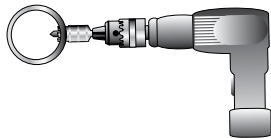

1. Mark the location for the drop bracket. Then using the appropriate drilling tool, drill the hole for the drop bracket.

■  $\varnothing 76$  -  $\varnothing 101$ : drilling tool EW09 00 30



2. Remove any chips and carefully deburr the hole ensuring no rough edges are left behind.

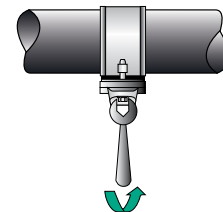

3. Position the plug of the bracket in the hole and tighten the bolts using a crescent wrench.



#### WARNING

This product can expose you to chemicals including Lead and Lead Compounds which is known to the State of California to cause cancer and birth defects or other reproductive harm. For more information go to [www.P65Warnings.ca.gov](http://www.P65Warnings.ca.gov)

# PIPE HANGERS

## 3/4" TO 4"

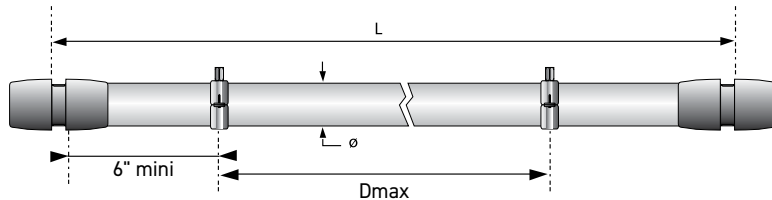

To ensure a stable piping system, Parker Transair suggests the use of at least 2 hangers per pipe. Transair stainless steel pipe should only be mounted using genuine Transair pipe hangers. Additional hangers may be necessary depending on the weight of the media being conveyed. Consult with engineering to determine if additional hangers are necessary.

**L = 20ft**

Ø	Dmax (ft)
22	9.8
28	9.8
76	16.40
101	16.40

It is recommended that all hanging / support calculations be done prior to installing and determining fixture installation configuration. Check With Engineering

# BENDING TRANSAIR® STAINLESS STEEL PIPE

## All Diameters

Due to the quality alloys used, all Transair stainless steel pipes can be bent according to the following specifications.

OD (in)	R min. (in)	L min. (in)
3/4	1.73	4.92
1	2.20	4.92
3	4.48	4.92
4	5.98	4.92

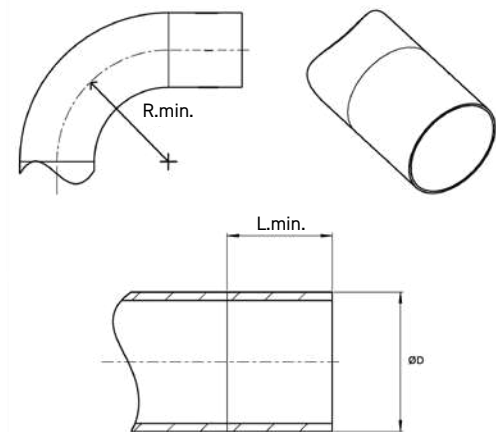

### WARNING

This product can expose you to chemicals including Lead and Lead Compounds which is known to the State of California to cause cancer and birth defects or other reproductive harm. For more information go to [www.P65Warnings.ca.gov](http://www.P65Warnings.ca.gov)

# Z DIMENSIONS

RR02 N7 - RR02 N9

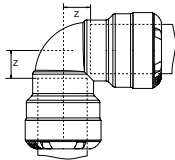

RP02/RR02	Z (in)	Z (mm)
Ø 3/4	.51	13
Ø 1	.59	15

RR04 N9 N7

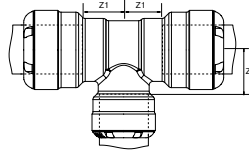

RR04 N7 - RR04 N9

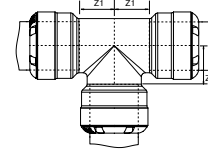

RR04	Z1 (in)	Z1 (mm)	Z1 (in)	Z2 (mm)
Ø 22	46	11.7	.43	11
Ø 28	.59	15	.59	15
Ø 28 - > Ø 22	.63	12	.63	16

RR06 N7 - RR06 N9

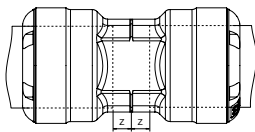

RR06	Z (in)	Z (mm)
Ø 3/4	.05	1.2
Ø 1	.05	1.2
Ø 3/4 - > Ø 1	.06	1.6

RX04 L1 00 - RX04 L3 00

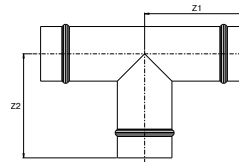

RX04	Z1 (in)	Z1 (mm)	Z1 (in)	Z2 (mm)
Ø 3	5.75	146	5.75	146
Ø 3 - > Ø 1-1/2	5.75	146	7.17	182
Ø 3 - > Ø 2	5.75	146	7.20	183
Ø 4	6.14	156	5.35	136
Ø 4 - > Ø 1-1/2	6.14	156	7.72	196
Ø 4 - > Ø 2	6.14	156	7.72	196
Ø 4 - > Ø 3	6.14	156	5.35	136

RX02 L1 00 - RX02 L3 00

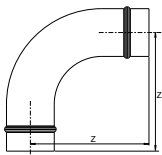

RX02	Z (in)	Z (mm)
Ø 3	7.44	189
Ø 4	8.94	227

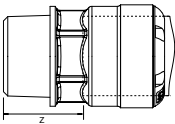
RR05 N7 04 - RR05 N7 06  
RR05 N9 08

RR05	Z (in)	Z (mm)
RR05 N7 04	.83	21
RR05 N7 06	.87	22
RR05 N9 08	.94	24

RR23 N7 06

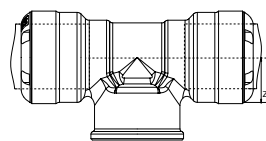

RX23 L1 04 - RX23 L3 04

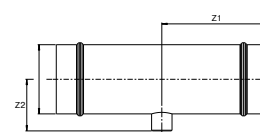

RR23/RX23	z1 (mm)	z1 (mm)	z1 (mm)	Z2 (mm)
Ø 3/4	.47	12	.55	14
Ø 3	5.75	146	2.48	63
Ø 4	6.14	156	2.99	76



## WARNING

This product can expose you to chemicals including Lead and Lead Compounds which is known to the State of California to cause cancer and birth defects or other reproductive harm. For more information go to [www.P65Warnings.ca.gov](http://www.P65Warnings.ca.gov)

## Parker Safety Guide for Selecting and Using Hose, Tubing, Fittings, Connectors, Conductors, Valves and Related Accessories

Parker Publication No. 4400-B.1

**WARNING: Failure or improper selection or improper use of hose, tubing, fittings, assemblies, valves, connectors, conductors or related accessories (“Products”) can cause death, personal injury and property damage. Possible consequences of failure or improper selection or improper use of these Products include but are not limited to:**

- Fittings thrown off at high speed.
- High velocity fluid discharge.
- Explosion or burning of the conveyed fluid.
- Electrocutation from high voltage electric powerlines.
- Contact with suddenly moving or falling objects that are controlled by the conveyed fluid.
- Injections by high-pressure fluid discharge.
- Dangerously whipping Hose.
- Tube or pipe burst.
- Weld joint fracture.
- Contact with conveyed fluids that may be hot, cold, toxic or otherwise injurious.
- Sparking or explosion caused by static electricity buildup or other sources of electricity.
- Sparking or explosion while spraying paint or flammable liquids.
- Injuries resulting from inhalation, ingestion or exposure to fluids.

Before selecting or using any of these Products, it is important that you read and follow the instructions below. No product from any division in Fluid Connector Group is approved for in-flight aerospace applications. For hoses and fittings used in in-flight aerospace applications, please contact Parker Aerospace Group

### GENERAL INSTRUCTIONS

**1.0 Scope:** This safety guide provides instructions for selecting and using (including assembling, installing, and maintaining) these Products. For convenience, all rubber and/or thermoplastic products commonly called “hose” or “tubing” are called “Hose” in this safety guide. Metallic tube or pipe are called “tube”. All assemblies made with Hose are called “Hose Assemblies”. All assemblies made with Tube are called “Tube Assemblies”. All products commonly called “fittings”, “couplings” or “adapters” are called “Fittings”. Valves are fluid system components that control the passage of fluid. Related accessories are ancillary devices that enhance or monitor performance including crimping, flaring, flanging, presetting, bending, cutting, deburring, swaging machines, sensors, tags, lockout handles, spring guards and associated tooling. This safety guide is a supplement to and is to be used with the specific Parker publications for the specific Hose, Fittings and Related Accessories that are being considered for use. Parker publications are available at [www.parker.com](http://www.parker.com). SAE J1273 ([www.sae.org](http://www.sae.org)) and ISO 17165-2 ([www.ansi.org](http://www.ansi.org)) also provide recommended practices for hydraulic Hose Assemblies, and should be followed.

- 1.1 Fail-Safe:** Hose, Hose Assemblies, Tube, Tube Assemblies and Fittings can and do fail without warning for many reasons. Design all systems and equipment in a fail-safe mode, so that failure of the Hose, Hose Assembly, Tube, Tube Assembly or Fitting will not endanger persons or property.
- 1.2 Distribution:** Provide a copy of this safety guide to each person responsible for selecting or using Hose, Tube and Fitting products. Do not select or use Parker Hose, Tube or Fittings without thoroughly reading and understanding this safety guide as well as the specific Parker publications for the Products.
- 1.3 User Responsibility:** Due to the wide variety of operating conditions and applications for Hose, Tube and Fittings. Parker does not represent or warrant that any particular Hose, Tube or Fitting is suitable for any specific end use system. This safety guide does not analyze all technical parameters that must be considered in selecting a product. The user, through its own analysis and testing, is solely responsible for:
- Making the final selection of the Products.
  - Assuring that the user’s requirements are met and that the application presents no health or safety hazards.
  - Following the safety guide for Related Accessories and being trained to operate Related Accessories.
  - Providing all appropriate health and safety warnings on the equipment on which the Products are used.
  - Assuring compliance with all applicable government and industry standards.
- 1.4 Additional Questions:** Call the appropriate Parker technical service department if you have any questions or require any additional information. See the Parker publication for the Products being considered or used, or call 1-800-CPARKER, or go to [www.parker.com](http://www.parker.com), for telephone numbers of the appropriate technical service department.

### 2.0 HOSE, TUBE AND FITTINGS SELECTION INSTRUCTIONS

**2.1 Electrical Conductivity:** Certain applications require that the Hose be nonconductive to prevent electrical current flow. Other applications require the Hose and the Fittings and the Hose/Fitting interface to be sufficiently conductive to drain off static electricity. Extreme care must be exercised when selecting Hose, Tube and Fittings for these or any other applications in which electrical conductivity or nonconductivity is a factor.

The electrical conductivity or nonconductivity of Hose, Tube and Fittings is dependent upon many factors and may be susceptible to change. These factors include but are not limited to the various materials used to make the Hose and the Fittings, Fitting finish (some Fitting finishes are electrically conductive while others are nonconductive), manufacturing methods (including moisture control), how the Fittings contact the Hose, age and amount of deterioration or damage or other changes, moisture content of the Hose at any particular time, and other factors.

The following are considerations for electrically nonconductive and conductive Hose. For other applications consult the individual catalog pages and the appropriate industry or regulatory standards for proper selection.

**2.1.1 Electrically Nonconductive Hose:** Certain applications require that the

Hose be nonconductive to prevent electrical current flow or to maintain electrical isolation. For applications that require Hose to be electrically nonconductive, including but not limited to applications near high voltage electric lines, only special nonconductive Hose can be used. The manufacturer of the equipment in which the nonconductive Hose is to be used must be consulted to be certain that the Hose, Tube and Fittings that are selected are proper for the application. Do not use any Parker Hose or Fittings for any such application requiring nonconductive Hose, including but not limited to applications near high voltage electric lines or dense magnetic fields, unless (i) the application is expressly approved in the Parker technical publication for the product, (ii) the Hose is marked “nonconductive”, and (iii) the manufacturer of the equipment on which the Hose is to be used specifically approves the particular Parker Hose, Tube and Fittings for such use.

**2.1.2 Electrically Conductive Hose:** Parker manufactures special Hose for certain applications that require electrically conductive Hose. Parker manufactures special Hose for conveying paint in airless paint spraying applications. This Hose is labeled “Electrically Conductive Airless Paint Spray Hose” on its layline and packaging. This Hose must be properly connected to the appropriate Parker Fittings and properly grounded in order to dissipate dangerous static charge buildup, which occurs in all airless paint spraying applications. Do not use any other Hose for airless paint spraying, even if electrically conductive. Use of any other Hose or failure to properly connect the Hose can cause a fire or an explosion resulting in death, personal injury, and property damage. All hoses that convey fuels must be grounded. Parker manufactures a special Hose for certain compressed natural gas (“CNG”) applications where static electricity buildup may occur. Parker CNG Hose assemblies comply with the requirements of ANSI/IAS NGV 4.2; CSA 12.52, “Hoses for Natural Gas Vehicles and Dispensing Systems” ([www.ansi.org](http://www.ansi.org)). This Hose is labeled “Electrically Conductive for CNG Use” on its layline and packaging. This Hose must be properly connected to the appropriate Parker Fittings and properly grounded in order to dissipate dangerous static charge buildup, which occurs in, for example, high velocity CNG dispensing or transfer. Do not use any other Hose for CNG applications where static charge buildup may occur, even if electrically conductive. Use of other Hoses in CNG applications or failure to properly connect or ground this Hose can cause a fire or an explosion resulting in death, personal injury, and property damage. Care must also be taken to protect against CNG permeation through the Hose wall. See section 2.6, Permeation, for more information. Parker CNG Hose is intended for dispenser and vehicle use within the specified temperature range. Parker CNG Hose should not be used in confined spaces or unventilated areas or areas exceeding the specified temperature range. Final assemblies must be tested for leaks. CNG Hose Assemblies should be tested on a monthly basis for conductivity per ANSI/IAS NGV 4.2; CSA 12.52. Parker manufactures special Hose for aerospace in-flight applications. Aerospace in-flight applications employing Hose to transmit fuel, lubricating fluids and hydraulic fluids require a special Hose with a conductive inner tube. This Hose for in-flight applications is available only from Parker’s Stratoflex Products Division. Do not use any other Parker Hose for in-flight applications, even if electrically conductive. Use of other Hoses for in-flight applications or failure to properly connect or ground this Hose can cause a fire or an explosion resulting in death, personal injury and property damage. These Hose assemblies for in-flight applications must meet all applicable aerospace industry, aircraft engine and aircraft requirements.

**2.2 Pressure:** Hose, Tube and Fitting selection must be made so that the published maximum working pressure of the Hose, Tube and Fittings are equal to or greater than the maximum system pressure. The maximum working pressure of a Hose, or Tube Assembly is the lower of the respective published maximum working pressures of the Hose, Tube and the Fittings used. Surge pressures or peak transient pressures in the system must be below the published maximum working pressure for the Hose, Tube and Fitting. Surge pressures and peak pressures can usually only be determined by sensitive electrical instrumentation that measures and indicates pressures at millisecond intervals. Mechanical pressure gauges indicate only average pressures and cannot be used to determine surge pressures or peak transient pressures. Published burst pressure ratings for Hose is for manufacturing test purposes only and is no indication that the Product can

- be used in applications at the burst pressure or otherwise above the published maximum recommended working pressure.
- 2.3 **Suction:** Hoses used for suction applications must be selected to insure that the Hose will withstand the vacuum and pressure of the system. Improperly selected Hose may collapse in suction application.
  - 2.4 **Temperature:** Be certain that fluid and ambient temperatures, both steady and transient, do not exceed the limitations of the Hose, Tube, Fitting and Seals. Temperatures below and above the recommended limit can degrade Hose, Tube, Fittings and Seals to a point where a failure may occur and release fluid. Tube and Fittings performances are normally degraded at elevated temperature. Material compatibility can also change at temperatures outside of the rated range. Properly insulate and protect the Hose Assembly when routing near hot objects (e.g. manifolds). Do not use any Hose in any application where failure of the Hose could result in the conveyed fluids (or vapors or mist from the conveyed fluids) contacting any open flame, molten metal, or other potential fire ignition source that could cause burning or explosion of the conveyed fluids or vapors.
  - 2.5 **Fluid Compatibility:** Hose, and Tube Assembly selection must assure compatibility of the Hose tube, cover, reinforcement, Tube, Plating and Seals with the fluid media used. See the fluid compatibility chart in the Parker publication for the product being considered or used. This information is offered only as a guide. Actual service life can only be determined by the end user by testing under all extreme conditions and other analysis. Hose, and Tube that is chemically compatible with a particular fluid must be assembled using Fittings and adapters containing likewise compatible seals. Flange or flare processes can change Tube material properties that may not be compatible with certain requirements such as NACE Permeation: Permeation (that is, seepage through the Hose or Seal) will occur from inside the Hose or Fitting to outside when Hose or Fitting is used with gases, liquid and gas fuels, and refrigerants (including but not limited to such materials as helium, diesel fuel, gasoline, natural gas, or LPG). This permeation may result in high concentrations of vapors which are potentially flammable, explosive, or toxic, and in loss of fluid. Dangerous explosions, fires, and other hazards can result when using the wrong Hose for such applications. The system designer must take into account the fact that this permeation will take place and must not use Hose or Fitting if this permeation could be hazardous. The system designer must take into account all legal, government, insurance, or any other special regulations which govern the use of fuels and refrigerants. Never use a Hose or Fitting even though the fluid compatibility is acceptable without considering the potential hazardous effects that can result from permeation through the Hose or Tube Assembly. Permeation of moisture from outside the Hose or Fitting to inside the Hose or Fitting will also occur in Hose or Tube assemblies, regardless of internal pressure. If this moisture permeation would have detrimental effects (particularly, but not limited to refrigeration and air conditioning systems), incorporation of sufficient drying capacity in the system or other appropriate system safeguards should be selected and used. The sudden pressure release of highly pressurized gas could also result in Explosive Decompression failure of permeated Seals and Hoses.
  - 2.6 **Size:** Transmission of power by means of pressurized fluid varies with pressure and rate of flow. The size of the components must be adequate to keep pressure losses to a minimum and avoid damage due to heat generation or excessive fluid velocity.
  - 2.7 **Routing:** Attention must be given to optimum routing to minimize inherent problems (kinking or flow restriction due to Hose collapse, twisting of the Hose, proximity to hot objects or heat sources). For additional routing recommendations see SAE J1273 and ISO 17165-2. Hose Assemblies have a finite life and should be installed in a manner that allows for ease of inspection and future replacement. Hose because of its relative short life, should not be used in residential and commercial buildings inside of inaccessible walls or floors, unless specifically allowed in the product literature. Always review all product literature for proper installation and routing instructions.
  - 2.8 **Environment:** Care must be taken to insure that the Hose, Tube and Fittings are either compatible with or protected from the environment (that is, surrounding conditions) to which they are exposed. Environmental conditions including but not limited to ultraviolet radiation, sunlight, heat, ozone, moisture, water, salt water, chemicals and air pollutants can cause degradation and premature failure.
  - 2.9 **Mechanical Loads:** External forces can significantly reduce Hose, Tube and Fitting life or cause failure. Mechanical loads which must be considered include excessive flexing, twist, kinking, tensile or side loads, bend radius, and vibration. Use of swivel type Fittings or adapters may be required to insure no twist is put into the Hose. Use of proper Hose or Tube clamps may also be required to reduce external mechanical loads. Unusual applications may require special testing prior to Hose selection.
  - 2.10 **Physical Damage:** Care must be taken to protect Hose from wear, snagging, kinking, bending smaller than minimum bend radius and cutting, any of which can cause premature Hose failure. Any Hose that has been kinked or bent to a radius smaller than the minimum bend radius, and any Hose that has been cut or is cracked or is otherwise damaged should be removed and discarded. Fittings with damages such as scratches on sealing surfaces and deformation should be replaced.
  - 2.11 **Proper End Fitting:** See instructions 3.2 through 3.5. These recommendations may be substantiated by testing to industry standards such as SAE J517 for hydraulic applications, or MIL-A-5070, AS1339, or AS3517 for Hoses from Parker's Stratoflex Products Division for aerospace applications.
  - 2.12 **Length:** When determining the proper Hose or Tube length of an assembly, be aware of Hose length change due to pressure, Tube length change due to thermal expansion or contraction, and Hose or Tube and machine tolerances and movement must be considered. When routing short hose assemblies, it is recommended that the minimum free hose length is always used. Consult the hose manufacturer for their minimum free hose length recommendations. Hose assemblies should be installed in such a way that any motion or flexing occurs within the same plane.
  - 2.13 **Specifications and Standards:** When selecting Hose, Tube and Fittings, government, industry, and Parker specifications and recommendations must be reviewed and followed as applicable.
  - 2.14 **Hose Cleanliness:** Hose and Tube components may vary in cleanliness levels. Care must be taken to insure that the Hose and Tube Assembly selected has an adequate level of cleanliness for the application.
  - 2.15 **Fire Resistant Fluids:** Some fire resistant fluids that are to be conveyed by Hose or Tube require use of the same type of Hose or Tube as used with petroleum base fluids. Some such fluids require a special Hose, Tube, Fitting and Seal, while a few fluids will not work with any Hose at all. See instructions 2.5 and 1.5. The wrong Hose, Tube, Fitting or Seal may fail after a very short service. In addition, all liquids but pure water may burn fiercely under certain conditions, and even pure water leakage may be hazardous.
  - 2.16 **Radiant Heat:** Hose and Seals can be heated to destruction without contact by such nearby items as hot manifolds or molten metal. The same heat source may then initiate a fire. This can occur despite the presence of cool air around the Hose or Seal. Performance of Tube and Fitting subjected to the heat could be degraded.
  - 2.17 **Welding or Brazing:** When using a torch or arc welder in close proximity to hydraulic lines, the hydraulic lines should be removed or shielded with appropriate fire resistant materials. Flame or weld spatter could burn through the Hose or Seal and possibly ignite escaping fluid resulting in a catastrophic failure. Heating of plated parts, including Hose Fittings and adapters, above 450°F (232°C) such as during welding, brazing or soldering may emit deadly gases. Any elastomer seal on fittings shall be removed prior to welding or brazing, any metallic surfaces shall be protected after brazing or welding when necessary. Welding and brazing filler material shall be compatible with the Tube and Fitting that are joined.
  - 2.18 **Atomic Radiation:** Atomic radiation affects all materials used in Hose and Tube assemblies. Since the long-term effects may be unknown, do not expose Hose or Tube assemblies to atomic radiation. Nuclear applications may require special Tube and Fittings.
  - 2.19 **Aerospace Applications:** The only Hose, Tube and Fittings that may be used for in-flight aerospace applications are those available from Parker's Stratoflex Products Division. Do not use any other Hose or Fittings for in-flight applications. Do not use any Hose or Fittings from Parker's Stratoflex Products Division with any other Hose or Fittings, unless expressly approved in writing by the engineering manager or chief engineer of Stratoflex Products Division and verified by the user's own testing and inspection to aerospace industry standards.
  - 2.20 **Unlocking Couplings:** Ball locking couplings or other Fittings with quick disconnect ability can unintentionally disconnect if they are dragged over obstructions, or if the sleeve or other disconnect member, is bumped or moved enough to cause disconnect. Threaded Fittings should be considered where there is a potential for accidental uncoupling.

### 3.0 HOSE AND FITTINGS ASSEMBLY AND INSTALLATION INSTRUCTIONS

- 3.1 **Component Inspection:** Prior to assembly, a careful examination of the Hose and Fittings must be performed. All components must be checked for correct style, size, catalog number, and length. The Hose must be examined for cleanliness, obstructions, blisters, cover looseness, kinks, cracks, cuts or any other visible defects. Inspect the Fitting and sealing surfaces for burrs, nicks, corrosion or other imperfections. Do NOT use any component that displays any signs of nonconformance.
- 3.2 **Hose and Fitting Assembly:** Do not assemble a Parker Fitting on a Parker Hose that is not specifically listed by Parker for that Fitting, unless authorized in writing by the engineering manager or chief engineer of the appropriate Parker division. Do not assemble a Parker Fitting on another manufacturer's Hose or a Parker Hose on another manufacturer's Fitting unless (i) the engineering manager or chief engineer of the appropriate Parker division approves the Assembly in writing or that combination is expressly approved in the appropriate Parker literature for the specific Parker product, and (ii) the user verifies the Assembly and the application through analysis and testing. For Parker Hose that does not specify a Parker Fitting, the user is solely responsible for the selection of the proper Fitting and Hose Assembly procedures. See instruction 1.4. To prevent the possibility of problems such as leakage at the Fitting or system contamination, it is important to completely remove all debris from the cutting operation before installation of the Fittings. The Parker published instructions must be followed for assembling the Fittings on the Hose. These instructions are provided in the Parker Fitting catalog for the specific Parker Fitting being used, or by calling 1-800-CPARKER, or at [www.parker.com](http://www.parker.com).
- 3.3 **Related Accessories:** Do not crimp or swage any Parker Hose or Fitting with anything but the listed swage or crimp machine and dies in accordance with Parker published instructions. Do not crimp or swage another manufacturer's Fitting with a Parker crimp or swage die unless authorized in writing by the engineering manager or chief engineer of the appropriate Parker division.
- 3.4 **Parts:** Do not use any Parker Fitting part (including but not limited to socket, shell, nipple, or insert) except with the correct Parker mating parts, in accordance with Parker published instructions, unless authorized in writing by the engineering manager or chief engineer of the appropriate Parker division.
- 3.5 **Field Attachable/Permanent:** Do not reuse any field attachable Hose Fitting that has blown or pulled off a Hose. Do not reuse a Parker permanent Hose Fitting (crimped or swaged) or any part thereof. Complete Hose Assemblies may only be reused after proper inspection under section 4.0. Do not assemble Fittings to any previously used hydraulic Hose that was in service, for use in a fluid power application.
- 3.6 **Pre-Installation Inspection:** Prior to installation, a careful examination of the Hose Assembly must be performed. Inspect the Hose Assembly for any damage or defects. DO NOT use any Hose Assembly that displays any signs of nonconformance.
- 3.7 **Minimum Bend Radius:** Installation of a Hose at less than the minimum listed bend radius may significantly reduce the Hose life. Particular attention must be given to preclude sharp bending at the Hose to Fitting juncture. Any bending during installation at less than the minimum bend radius must be avoided. If any Hose is kinked during installation, the Hose must be discarded.
- 3.8 **Twist Angle and Orientation:** Hose Assembly installation must be such that relative motion of machine components does not produce twisting.
- 3.9 **Securement:** In many applications, it may be necessary to restrain, protect,

- or guide the Hose to protect it from damage by unnecessary flexing, pressure surges, and contact with other mechanical components. Care must be taken to insure such restraints do not introduce additional stress or wear points.
- 3.10 **Proper Connection of Ports:** Proper physical installation of the Hose Assembly requires a correctly installed port connection insuring that no twist or torque is transferred to the Hose when the Fittings are being tightened or otherwise during use.
- 3.11 **External Damage:** Proper installation is not complete without insuring that tensile loads, side loads, kinking, flattening, potential abrasion, thread damage or damage to sealing surfaces are corrected or eliminated. See instruction 2.10.
- 3.12 **System Checkout:** All air entrapment must be eliminated and the system pressurized to the maximum system pressure (at or below the Hose maximum working pressure) and checked for proper function and freedom from leaks. Personnel must stay out of potential hazardous areas while testing and using.
- 3.13 **Routing:** The Hose Assembly should be routed in such a manner so if a failure does occur, the escaping media will not cause personal injury or property damage. In addition, if fluid media comes in contact with hot surfaces, open flame or sparks, a fire or explosion may occur. See section 2.4.
- 3.14 **Ground Fault Equipment Protection Devices (GFEEDs):** **WARNING!** Fire and Shock Hazard. To minimize the danger of fire if the heating cable of a Multitube bundle is damaged or improperly installed, use a Ground Fault Equipment Protection Device. Electrical fault currents may be insufficient to trip a conventional circuit breaker. For ground fault protection, the IEEE 515: ([www.anst.org](http://www.anst.org)) standard for heating cables recommends the use of GFEEDs with a nominal 30 milliamperere trip level for "piping systems in classified areas, those areas requiring a high degree of maintenance, or which may be exposed to physical abuse or corrosive atmospheres".

#### 4.0 TUBE AND FITTINGS ASSEMBLY AND INSTALLATION INSTRUCTIONS

- 4.1 **Component Inspection:** Prior to assembly, a careful examination of the Tube and Fittings must be performed. All components must be checked for correct style, size, material, seal, and length. Inspect the Fitting and sealing surfaces for burrs, nicks, corrosion, missing seal or other imperfections. Do NOT use any component that displays any signs of nonconformance.
- 4.2 **Tube and Fitting Assembly:** Do not assemble a Parker Fitting with a Tube that is not specifically listed by Parker for that Fitting, unless authorized in writing by the engineering manager or chief engineer of the appropriate Parker division. The Tube must meet the requirements specified to the Fitting. The Parker published instructions must be followed for assembling the Fittings to a Tube. These instructions are provided in the Parker Fitting catalog for the specific Parker Fitting being used, or by calling 1-800-CPARKER, or at [www.parker.com](http://www.parker.com).
- 4.3 **Related Accessories:** Do not preset or flange Parker Fitting components using another manufacturer's equipment or procedures unless authorized in writing by the engineering manager or chief engineer of the appropriate Parker division. Tube, Fitting component and tooling must be checked for correct style, size and material. Operation and maintenance of Related Accessories must be in accordance with the operation manual for the designated Accessory.
- 4.4 **Securement:** In many applications, it may be necessary to restrain, protect, or guide the Tube to protect it from damage by unnecessary flexing, pressure surges, vibration, and contact with other mechanical components. Care must be taken to insure such restraints do not introduce additional stress or wear points.
- 4.5 **Proper Connection of Ports:** Proper physical installation of the Tube Assembly requires a correctly installed port connection insuring that no torque is transferred to the Tube when the Fittings are being tightened or otherwise during use.
- 4.6 **External Damage:** Proper installation is not complete without insuring that tensile loads, side loads, flattening, potential abrasion, thread damage or damage to sealing surfaces are corrected or eliminated. See instruction 2.10.
- 4.7 **System Checkout:** All air entrapment must be eliminated and the system pressurized to the maximum system pressure (at or below the Tube Assembly maximum working pressure) and checked for proper function and freedom from leaks. Personnel must stay out of potential hazardous areas while testing and using.
- 4.8 **Routing:** The Tube Assembly should be routed in such a manner so if a failure does occur, the escaping media will not cause personal injury or property damage. In addition, if fluid media comes in contact with hot surfaces, open flame or sparks, a fire or explosion may occur. See section 2.4.

#### 5.0 HOSE AND FITTING MAINTENANCE AND REPLACEMENT INSTRUCTIONS

- 5.1 Even with proper selection and installation, Hose life may be significantly reduced without a continuing maintenance program. The severity of the application, risk potential from a possible Hose failure, and experience with any Hose failures in the application or in similar applications should determine the frequency of the inspection and the replacement for the Products so that Products are replaced before any failure occurs. Certain products require maintenance and inspection per industry requirements. Failure to adhere to these requirements may lead to premature failure. A maintenance program must be established and followed by the user and, at minimum, must include instructions 5.2 through 5.7
- 5.2 **Visual Inspection Hose/Fitting:** Any of the following conditions require immediate shut down and replacement of the Hose Assembly:
- Fitting slippage on Hose;
  - Damaged, cracked, cut or abraded cover (any reinforcement exposed);
  - Hard, stiff, heat cracked, or charred Hose;
  - Cracked, damaged, or badly corroded Fittings;
  - Leaks at Fitting or in Hose;
  - Kinked, crushed, flattened or twisted Hose; and
  - Blistered, soft, degraded, or loose cover.
- 5.3 **Visual Inspection All Other:** The following items must be tightened, repaired, corrected or replaced as required:
- Leaking port conditions;
  - Excess dirt buildup;
  - Worn clamps, guards or shields; and
  - System fluid level, fluid type, and any air entrapment.
- 5.4 **Functional Test:** Operate the system at maximum operating pressure and check

- for possible malfunctions and leaks. Personnel must avoid potential hazardous areas while testing and using the system. See section 2.2.
- 5.5 **Replacement Intervals:** Hose assemblies and elastomeric seals used on Hose Fittings and adapters will eventually age, harden, wear and deteriorate under thermal cycling and compression set. Hose Assemblies and elastomeric seals should be inspected and replaced at specific replacement intervals, based on previous service life, government or industry recommendations, or when failures could result in unacceptable downtime, damage, or injury risk. See section 1.2. Hose and Fittings may be subjected to internal mechanical and/or chemical wear from the conveying fluid and may fail without warning. The user must determine the product life under such circumstances by testing. Also see section 2.5.
- 5.6 **Hose Inspection and Failure:** Hydraulic power is accomplished by utilizing high pressure fluids to transfer energy and do work. Hoses, Fittings and Hose Assemblies all contribute to this by transmitting fluids at high pressures. Fluids under pressure can be dangerous and potentially lethal and, therefore, extreme caution must be exercised when working with fluids under pressure and handling the Hoses transporting the fluids. From time to time, Hose Assemblies will fail if they are not replaced at proper time intervals. Usually these failures are the result of some form of misapplication, abuse, wear or failure to perform proper maintenance. When Hoses fail, generally the high pressure fluids inside escape in a stream which may or may not be visible to the user. Under no circumstances should the user attempt to locate the leak by "feeling" with their hands or any other part of their body. High pressure fluids can and will penetrate the skin and cause severe tissue damage and possibly loss of limb. Even seemingly minor hydraulic fluid injection injuries must be treated immediately by a physician with knowledge of the tissue damaging properties of hydraulic fluid. If a Hose failure occurs, immediately shut down the equipment and leave the area until pressure has been completely released from the Hose Assembly. Simply shutting down the hydraulic pump may or may not eliminate the pressure in the Hose Assembly. Many times check valves, etc., are employed in a system and can cause pressure to remain in a Hose Assembly even when pumps or equipment are not operating. Tiny holes in the Hose, commonly known as pinholes, can eject small, dangerously powerful but hard to see streams of hydraulic fluid. It may take several minutes or even hours for the pressure to be relieved so that the Hose Assembly may be examined safely. Once the pressure has been reduced to zero, the Hose Assembly may be taken off the equipment and examined. It must always be replaced if a failure has occurred. Never attempt to patch or repair a Hose Assembly that has failed. Consult the nearest Parker distributor or the appropriate Parker division for Hose Assembly replacement information. Never touch or examine a failed Hose Assembly unless it is obvious that the Hose no longer contains fluid under pressure. The high pressure fluid is extremely dangerous and can cause serious and potentially fatal injury.
- 5.7 **Elastomeric seals:** Elastomeric seals will eventually age, harden, wear and deteriorate under thermal cycling and compression set. Elastomeric seals should be inspected and replaced.
- 5.8 **Refrigerant gases:** Special care should be taken when working with refrigeration systems. Sudden escape of refrigerant gases can cause blindness if the escaping gases contact the eye and can cause freezing or other severe injuries if it contacts any other portion of the body.
- 5.9 **Compressed natural gas (CNG):** Parker CNG Hose Assemblies should be tested after installation and before use, and at least on a monthly basis per instructions provided on the Hose Assembly tag. The recommended procedure is to pressurize the Hose and check for leaks and to visually inspect the Hose for damage and to perform an electrical resistance test. Caution: Matches, candles, open flame or other sources of ignition shall not be used for Hose inspection. Leak check solutions should be rinsed off after use.

#### 6.0 HOSE STORAGE

- 6.1 **Age Control:** Hose and Hose Assemblies must be stored in a manner that facilitates age control and first-in and first-out usage based on manufacturing date of the Hose and Hose Assemblies. Unless otherwise specified by the manufacturer or defined by local laws and regulations:
- 6.1.1 The shelf life of rubber hose in bulk form or hose made from two or more materials is 28 quarters (7 years) from the date of manufacture, with an extension of 12 quarters (3 years), if stored in accordance with ISO 2230;
- 6.1.2 The shelf life of thermoplastic and polytetrafluoroethylene hose is considered to be unlimited;
- 6.1.3 Hose assemblies that pass visual inspection and proof test shall not be stored for longer than 2 years.
- 6.1.4 **Storage:** Stored Hose and Hose Assemblies must not be subjected to damage that could reduce their expected service life and must be placed in a cool, dark and dry area with the ends capped. Stored Hose and Hose Assemblies must not be exposed to temperature extremes, ozone, oils, corrosive liquids or fumes, solvents, high humidity, rodents, insects, ultraviolet light, electromagnetic fields or radioactive materials.

## PARKER-HANNIFIN CORPORATION OFFER OF SALE

1. **Definitions.** As used herein, the following terms have the meanings indicated.

“Buyer” means any customer receiving a Quote for Products.

“Buyer’s Property” means any tools, patterns, plans, drawings, designs, specifications materials, equipment, or information furnished by Buyer, or which are or become Buyer’s property.

“Confidential Information” means any technical, commercial, or other proprietary information of Seller, including, without limitation, pricing, technical drawings or prints and/or part lists, which has been or will be disclosed, delivered, or made available, whether directly or indirectly, to Buyer.

“Goods” means any tangible part, system or component to be supplied by Seller.

“Intellectual Property Rights” means any patents, trademarks, copyrights, trade dress, trade secrets or similar rights.

“Products” means the Goods, Services and/or Software as described in a Quote.

“Quote” means the offer or proposal made by Seller to Buyer for the supply of Products.

“Seller” means Parker-Hannifin Corporation, including all divisions, subsidiaries and businesses selling Products under these Terms.

“Seller’s IP” means patents, trademarks, copyrights, or other intellectual property rights relating to the Products, including without limitation, names, designs, images, drawings, models, software, templates, information, any improvements or creations or other intellectual property developed prior to or during the relationship contemplated herein.

“Services” means any services to be provided by Seller.

“Software” means any software related to the Goods, whether embedded or separately downloaded.

“Special Tooling” means equipment acquired by Seller or otherwise owned by Seller necessary to manufacture Goods, including but not limited to tools, jigs, and fixtures.

“Terms” means the terms and conditions of this Offer of Sale.

2. **Terms.** All sales of Products by Seller will be governed by, and are expressly conditioned upon Buyer’s assent to, these Terms. These Terms are incorporated into any Quote provided by Seller to Buyer. Buyer’s order for any Products whether communicated to Seller verbally, in writing, by electronic data interface or other electronic commerce, shall constitute acceptance of these Terms. Seller objects to any contrary or additional terms or conditions of Buyer. Reference in Seller’s order acknowledgement to Buyer’s purchase order or purchase order number shall in no way constitute an acceptance of any of Buyer’s terms or conditions of purchase. Any Quote made by Seller to Buyer shall be considered a firm and definite offer and shall not be deemed to be otherwise despite any language on the face of the Quote. Seller reserves all rights to accept or reject any purported acceptance by Buyer to Seller’s Quote if such purported acceptance attempts to vary the terms of the Quote. If Seller ships Products after Buyer issues an acceptance to the Quote, any additional or different terms proposed by Buyer will not become part of the parties’ business relationship unless agreed to in a writing that is signed by an authorized representative of Seller, excluding email correspondence. If the transaction proceeds without such agreement on the part of Seller, the business relationship will be governed solely by these Terms and the specific terms in Seller’s Quote.

3. **Price; Payment.** The Products set forth in the Quote are offered for sale at the prices indicated in the Quote. Unless otherwise specifically stated in the Quote, prices are valid for thirty (30) days and do not include any sales, use, or other taxes or duties. Seller reserves the right to modify prices for any reason and at any time by giving ten (10) days prior written notice. Unless otherwise specified by Seller, all prices are F.C.A. Seller’s facility (INCOTERMS 2020). All sales are contingent upon

credit approval and full payment for all purchases is due thirty (30) days from the date of invoice (or such date as may be specified in the Quote). Under any circumstances, Buyer may not withhold or suspend payment of any amounts due and payable as a deduction, set-off or recoupment of any amount, claim or dispute with Seller. Unpaid invoices beyond the specified payment date incur interest at the rate of 1.5% per month or the maximum allowable rate under applicable law. Seller reserves the right to require advance payment or provision of securities for first and subsequent deliveries if there is any doubt, in Seller’s sole determination, regarding the Buyer’s creditworthiness or for other business reasons. If the requested advance payment or securities are not provided to Seller’s satisfaction, Seller reserves the right to suspend performance or reject the purchase order, in whole or in part, without prejudice to Seller’s other rights or remedies, including the right to full compensation. Seller may revoke or shorten any payment periods previously granted in Seller’s sole determination. The rights and remedies herein reserved to Seller are cumulative and in addition to any other or further rights and remedies available at law or in equity. No waiver by Seller of any breach by Buyer of any provision of these terms will constitute a waiver by Seller of any other breach of such provision.

4. **Shipment; Delivery; Title and Risk of Loss.** All delivery dates are approximate, and Seller is not responsible for damages or additional costs resulting from any delay. All deliveries are subject to our ability to procure materials from our suppliers. Regardless of the manner of shipment, delivery occurs and title and risk of loss or damage pass to Buyer, upon placement of the Products with the carrier at Seller’s facility. Unless otherwise agreed prior to shipment and for domestic delivery locations only, Seller will select and arrange, at Buyer’s sole expense, the carrier and means of delivery. When Seller selects and arranges the carrier and means of delivery, freight and insurance costs for shipment to the designated delivery location will be prepaid by Seller and added as a separate line item to the invoice. Buyer shall be responsible for any additional shipping charges incurred by Seller due to Buyer’s acts or omissions. Buyer shall not return or repackage any Products without the prior written authorization from Seller, and any return shall be at the sole cost and expense of Buyer.

5. **Warranty.** The warranty for the Products is as follows: (i) Goods are warranted against defects in material or workmanship for a period of twelve (12) months from the date of delivery or 2,000 hours of use, whichever occurs first; (ii) Services shall be performed in accordance with generally accepted practices and using the degree of care and skill that is ordinarily exercised and customary in the field to which the Services pertain and are warranted for a period of six (6) months from the date of completion of the Services; and (iii) Software is only warranted to perform in accordance with applicable specifications provided by Seller to Buyer for ninety (90) days from the date of delivery or, when downloaded by a Buyer or end-user, from the date of the initial download. All prices are based upon the exclusive limited warranty stated above, and upon the following disclaimer: **EXEMPTION CLAUSE; DISCLAIMER OF WARRANTY, CONDITIONS, REPRESENTATIONS: THIS WARRANTY IS THE SOLE AND ENTIRE WARRANTY, CONDITION, AND REPRESENTATION, PERTAINING TO PRODUCTS. SELLER DISCLAIMS ALL OTHER WARRANTIES, CONDITIONS, AND REPRESENTATIONS, WHETHER STATUTORY, EXPRESS OR IMPLIED, INCLUDING BUT NOT LIMITED TO THOSE RELATING TO DESIGN, NONINFRINGEMENT, MERCHANTABILITY, AND FITNESS FOR A PARTICULAR PURPOSE. SELLER DOES NOT WARRANT THAT THE SOFTWARE IS ERROR-FREE OR FAULT-TOLERANT, OR THAT BUYER’S USE THEREOF WILL BE SECURE OR UNINTERRUPTED, UNLESS OTHERWISE**

**AUTHORIZED IN WRITING BY SELLER, THE SOFTWARE SHALL NOT BE USED IN CONNECTION WITH HAZARDOUS OR HIGH-RISK ACTIVITIES OR ENVIRONMENTS. EXCEPT AS EXPRESSLY STATED HEREIN, ALL PRODUCTS ARE PROVIDED “AS IS”.**

6. **Claims; Commencement of Actions.** Buyer shall promptly inspect all Products upon receipt. No claims for shortages will be allowed unless reported to Seller within ten (10) days of delivery. Buyer shall notify Seller of any alleged breach of warranty within thirty (30) days after the date the non-conformance is or should have been discovered by Buyer. Any claim or action against Seller based upon breach of contract or any other theory, including tort, negligence, or otherwise must be commenced within twelve (12) months from the date of the alleged breach or other alleged event, without regard to the date of discovery.

7. **LIMITATION OF LIABILITY. IN THE EVENT OF A BREACH OF WARRANTY, SELLER WILL, AT ITS OPTION, REPAIR OR REPLACE THE NON-CONFORMING PRODUCTS, RE-PERFORM THE SERVICES, OR REFUND THE PURCHASE PRICE PAID WITHIN A REASONABLE PERIOD OF TIME. IN NO EVENT IS SELLER LIABLE FOR ANY SPECIAL, INDIRECT, INCIDENTAL OR CONSEQUENTIAL DAMAGES INCLUDING ANY LOSS OF REVENUE OR PROFITS, WHETHER BASED IN CONTRACT, TORT OR OTHER LEGAL THEORY. IN NO EVENT SHALL SELLER’S LIABILITY UNDER ANY CLAIM MADE BY BUYER EXCEED THE PURCHASE PRICE PAID FOR THE PRODUCTS.**

8. **Confidential Information.** Buyer acknowledges and agrees that Confidential Information has been and will be received in confidence and will remain the property of Seller. Buyer further agrees that it will not use Seller’s Confidential Information for any purpose other than for the benefit of Seller and shall return all such Confidential Information to Seller within thirty (30) days upon request.

9. **Loss to Buyer’s Property.** Buyer’s Property will be considered obsolete and may be destroyed by Seller after two (2) consecutive years have elapsed without Buyer ordering the Products manufactured using Buyer’s Property.

Also, Seller shall not be responsible for any loss or damage to Buyer’s Property while it is in Seller’s possession or control.

10. **Special Tooling.** Seller may impose a tooling charge for any Special Tooling. Special Tooling shall be and remain Seller’s property. In no event will Buyer acquire any interest in the Special Tooling, even if such Special Tooling has been specially converted or adapted for manufacture of Goods for Buyer and notwithstanding any charges paid by Buyer. Unless otherwise agreed, Seller has the right to alter, discard or otherwise dispose of any Special Tooling or other property owned by Seller in its sole determination at any time.

11. **Security Interest.** To secure payment of all sums due from Buyer, Seller retains a security interest in all Products delivered to Buyer and, Buyer’s acceptance of these Terms is deemed to be a Security Agreement under the Uniform Commercial Code. Buyer authorizes Seller as its attorney to execute and file on Buyer’s behalf all documents Seller deems necessary to perfect Seller’s security interest.

12. **User Responsibility.** Buyer, through its own analysis and testing, is solely responsible for making the final selection of the Products and assuring that all performance, endurance, maintenance, safety and warning requirements of the application of the Products are met. Buyer must analyze all aspects of the application and follow applicable industry standards, specifications, and any technical information provided with the Quote or the Products, such as Seller’s instructions, guides and specifications. If Seller provides options of or for Products based upon data or specifications provided by Buyer, Buyer is responsible for

determining that such data and specifications are suitable and sufficient for all applications and reasonably foreseeable uses of the Products. In the event Buyer is not the end-user of the Products, Buyer will ensure such end-user complies with this paragraph.

13. **Use of Products, Indemnity by Buyer.** Buyer shall comply with all instructions, guides and specifications provided by Seller with the Quote or the Products. If Buyer uses or resells the Products in any way prohibited by Seller’s instructions, guides or specifications, or Buyer otherwise fails to comply with Seller’s instructions, guides and specifications, Buyer acknowledges that any such use, resale, or non-compliance is at Buyer’s sole risk. Further, Buyer shall indemnify, defend, and hold Seller harmless from any losses, claims, liabilities, damages, lawsuits, judgments and costs (including attorney fees and defense costs), whether for personal injury, property damage, intellectual property infringement or any other claim, arising out of or in connection with: (a) improper selection, design, specification, application, or any misuse of Products; (b) any act or omission, negligent or otherwise, of Buyer; (c) Seller’s use of Buyer’s Property; (d) damage to the Products from an external cause, repair or attempted repair by anyone other than Seller, failure to follow instructions, guides and specifications provided by Seller, use with goods not provided by Seller, or opening, modifying, deconstructing, tampering with or repackaging the Products; or (e) Buyer’s failure to comply with these Terms, including any legal or administrative proceedings, collection efforts, or other actions arising from or relating to such failure to comply. Seller shall not indemnify Buyer under any circumstance except as otherwise provided in these Terms.

14. **Cancellations and Changes.** Buyer may not cancel or modify, including but not limited to movement of delivery dates for the Products, any order for any reason except with Seller’s written consent and upon terms that will indemnify, defend and hold Seller harmless against all direct, incidental and consequential loss or damage and any additional expense. Seller, at any time, may change features, specifications, designs and availability of Products.

15. **Assignment.** Buyer may not assign its rights or obligations without the prior written consent of Seller.

16. **Force Majeure.** Seller is not liable for delay or failure to perform any of its obligations by reason of any events or circumstances beyond its reasonable control. Such circumstances include without limitation: accidents, labor disputes or stoppages, government acts or orders, acts of nature, pandemics, epidemics, other widespread illness, or public health emergency, cyber related disruptions, cyber-attacks, ransomware sabotage, delays or failures in delivery from carriers or suppliers, shortages of materials, sudden increases in the price of raw material or components, shutdowns or slowdowns affecting the supply of raw materials or components, or the transportation thereof, oil shortages or oil price increases, energy crisis, energy or fuel interruption, war (whether declared or not) or the serious threat of same, riots, rebellions, acts of terrorism, embargoes, fire or any reason whether similar to the foregoing or otherwise. Seller will resume performance as soon as practicable after the event of force majeure has been removed. All delivery dates affected by an event of force majeure shall be tolled for the duration of such event of force majeure and rescheduled for mutually agreed dates as soon as practicable after the event of force majeure ceases to exist. The right to allocate capacity is in the Seller’s sole discretion. An event of force majeure shall not include financial distress, insolvency, bankruptcy, or other similar conditions affecting one of the parties, affiliates and/or subcontractors. An event of force majeure in the meaning of these Terms means any circumstances beyond Seller’s control that permanently or temporarily hinders performance, even where that circumstance was already foreseen. Buyer shall not be entitled to cancel any orders following its claim of an event of force majeure.

17. **Waiver and Severability.** Failure to enforce any provision of these Terms will not invalidate that provision; nor will any such failure prejudice either party's right to enforce that provision in the future. Invalidation of any provision of these Terms shall not invalidate any other provision herein and, the remaining provisions will remain in full force and effect.

18. **Duration.** Unless otherwise stated in the Quote, any agreement governed by or arising from these Terms shall: (a) be for an initial duration of one (1) year; and (b) shall automatically renew for successive one-year terms unless terminated by Buyer with at least 180-days written notice to Seller or if Seller terminates the agreement pursuant to Section 19 of these Terms.

19. **Termination.** Seller may, without liability to Buyer, terminate any agreement governed by or arising from these Terms for any reason and at any time by giving Buyer thirty (30) days prior written notice. Seller may immediately terminate, in writing, if Buyer: (a) breaches any provision of these Terms, (b) becomes or is deemed insolvent, (c) appoints or has appointed a trustee, receiver or custodian for all or any part of Buyer's property, (d) files a petition for relief in bankruptcy on its own behalf, or one is filed against Buyer by a third party, (e) makes an assignment for the benefit of creditors; or (f) dissolves its business or liquidates all or a majority of its assets.

20. **Ownership of Rights.** Buyer agrees that (a) Seller (and/or its affiliates) owns or is the valid licensee of Seller's IP and (b) the furnishing of information, related documents or other materials by Seller to Buyer does not grant or transfer any ownership interest or license in or to Seller's IP to Buyer, unless expressly agreed in writing. Without limiting the foregoing, Seller retains ownership of all Software supplied to Buyer. In no event shall Buyer obtain any greater right in and to the Software than a right in a license limited to the use thereof and subject to compliance with any other terms provided with the Software. Buyer further agrees that it will not, directly or through intermediaries, reverse engineer, decompile, or disassemble any Software (including firmware) comprising or contained within a Product, except and only to the extent that such activity may be expressly permitted, either by applicable law or, in the case of open source software, the applicable open source license.

21. **Indemnity for Infringement of Intellectual Property Rights.** Seller is not liable for infringement of any Intellectual Property Rights except as provided in this Section. Seller will defend at its expense and will pay the cost of any settlement or damages awarded in an action brought against Buyer based on a third-party claim that one or more of the Products infringes the Intellectual Property Rights of a third party in the country of delivery of the Products by Seller to Buyer. Seller's obligation to defend and indemnify Buyer is contingent on Buyer notifying Seller within ten (10) days after Buyer becomes aware of any such claim, and Seller having sole control over the defense of the claim including all negotiations for settlement or compromise. If one or more Products is subject to such a claim, Seller may, at its sole expense and option, procure for Buyer the right to continue using the Products, replace or modify the Products to render them non-infringing, or offer to accept return of the Products and refund the purchase price less a reasonable allowance for depreciation. Seller has no obligation or liability for any claim of infringement: (i) arising from information provided by Buyer (including Seller's use of Buyer's Property); or (ii) directed to any Products for which the designs are specified in whole or part by Buyer; or (iii) resulting from the modification, combination or use in a system of any Products. The foregoing provisions of this Section constitute Seller's sole and exclusive liability and Buyer's sole and exclusive remedy for claims of infringement of Intellectual Property Rights.

22. **Governing Law.** These Terms, the terms of any Quote, and the sale and delivery of all Products are deemed to have taken place in, and shall be governed and construed in accordance with, the laws of the State of Ohio, as applicable to contracts executed and wholly performed therein and

without regard to conflicts of laws principles. Buyer irrevocably agrees and consents to the exclusive jurisdiction and venue of the courts of Cuyahoga County, Ohio with respect to any dispute, controversy or claim arising out of or relating to the sale and delivery of the Products.

23. **Entire Agreement.** These Terms, along with the terms set forth in the Quote, forms the entire agreement between the Buyer and Seller and constitutes the final, complete and exclusive expression of the terms of sale and purchase. In the event of a conflict between any term set forth in the Quote and these Terms, the terms set forth in the Quote shall prevail. All prior or contemporaneous written or oral agreements or negotiations with respect to the subject matter shall have no effect. No modification to these Terms will be binding on Seller unless agreed to in a writing that is signed by an authorized representative of Seller, excluding email correspondence, 'clickwrap' or other purported electronic assent to different or additional terms. Sections 2-25 of these Terms shall survive termination or cancellation of any agreement governed by or arising from these Terms.

24. **No 'Wrap' Agreements/No Authority to Bind.** Seller's clicking any buttons or any similar action, such as clicking "I Agree" or "Confirm," to utilize Buyer's software or webpage for the placement of orders, is NOT an agreement to Buyer's Terms and Conditions. **NO EMPLOYEE, AGENT OR REPRESENTATIVE OF SELLER HAS THE AUTHORITY TO BIND SELLER BY THE ACT OF CLICKING ANY BUTTON OR SIMILAR ACTION ON BUYER'S WEBSITE OR PORTAL.**

25. **Compliance with Laws.** Buyer agrees to comply with all applicable laws, regulations, and industry and professional standards, including those of the United States of America, and the country or countries in which Buyer may operate, including without limitation the U.S. Foreign Corrupt Practices Act ("FCPA"), the U.S. Anti-Kickback Act ("Anti-Kickback Act"), U.S. and E.U. export control and sanctions laws ("Export Laws"), the U.S. Food Drug and Cosmetic Act ("FDCA"), and the rules and regulations promulgated by the U.S. Food and Drug Administration ("FDA"), each as currently amended. Buyer agrees to indemnify, defend, and hold harmless Seller from the consequences of any violation of such laws, regulations and standards by Buyer, its employees or agents. Buyer represents that it is familiar with all applicable provisions of the FCPA, the Anti-Kickback Act, Export Laws, the FDCA and the FDA and certifies that Buyer will adhere to the requirements thereof and not take any action that would make Seller violate such requirements. Buyer represents and agrees that Buyer will not make any payment or give anything of value, directly or indirectly, to any governmental official, foreign political party or official thereof, candidate for foreign political office, or commercial entity or person, for any improper purpose, including the purpose of influencing such person to purchase Products or otherwise benefit the business of Seller. Buyer further represents and agrees that it will not receive, use, service, transfer or ship any Products from Seller in a manner or for a purpose that violates Export Laws or would cause Seller to be in violation of Export Laws. Buyer agrees to promptly and reliably provide Seller all requested information or documents, including end-user statements and other written assurances, concerning Buyer's ongoing compliance with Export Law.

# Parker's Motion & Control Product Groups

*At Parker, we're guided by a relentless drive to help our customers become more productive and achieve higher levels of profitability by engineering the best systems for their requirements. It means looking at customer applications from many angles to find new ways to create value. Whatever the motion and control technology need, Parker has the experience, breadth of product and global reach to consistently deliver. No company knows more about motion and control technology than Parker.*

**For further info call  
1 800 C-Parker  
(1 800 272 7537).**



## **Aerospace**

### **Key Markets**

Aftermarket services  
Commercial transports  
Engines  
General & business aviation  
Helicopters  
Launch vehicles  
Military aircraft  
Missiles  
Power generation  
Regional transports  
Unmanned aerial vehicles

### **Key Products**

Control systems & actuation products  
Engine systems & components  
Fluid conveyance systems & components  
Fluid metering, delivery & atomization devices  
Fuel systems & components  
Fuel tank inerting systems  
Hydraulic systems & components  
Thermal management  
Wheels & brakes



## **Automation**

### **Key Markets**

Alternative energy  
Conveyor & material handling  
Factory automation  
Food & beverage  
Life sciences & medical  
Machine tools  
Packaging machinery  
Paper machinery  
Plastics machinery  
Primary metals  
Safety & security  
Semiconductor & electronics  
Transportation & automotive

### **Key Products**

AC/DC drives & systems  
Air preparation  
Electric actuators, gantry robots & slides  
Human machine interfaces  
Inverters  
Manifolds  
Miniature fluidics  
Pneumatic actuators & grippers  
Pneumatic valves & controls  
Rotary actuators  
Stepper motors, servo motors, drives & controls  
Structural extrusions  
Vacuum generators, cups & sensors



## **Climate & Industrial Controls**

### **Key Markets**

Agriculture  
Air conditioning  
Construction Machinery  
Food & beverage  
Industrial machinery  
Life sciences  
Oil & gas  
Precision cooling  
Process  
Refrigeration  
Transportation

### **Key Products**

Accumulators  
Advanced actuators  
CO2 controls  
Electronic controllers  
Filter driers  
Hand shut-off valves  
Heat exchangers  
Hose & fittings  
Pressure regulating valves  
Refrigerant distributors  
Safety relief valves  
Smart pumps  
Solenoid valves  
Thermostatic expansion valves



## **Filtration**

### **Key Markets**

Aerospace  
Food & beverage  
Industrial plant & equipment  
Life sciences  
Marine  
Mobile equipment  
Oil & gas  
Power generation & renewable energy  
Process  
Transportation  
Water Purification

### **Key Products**

Analytical gas generators  
Compressed air filters & driers  
Engine air, coolant, fuel & oil filtration systems  
Fluid condition monitoring systems  
Hydraulic & lubrication filters  
Hydrogen, nitrogen & zero air generators  
Instrumentation filters  
Membrane & fiber filters  
Microfiltration  
Sterile air filtration  
Water desalination & purification filters & systems



## **Fluid Connectors**

### **Key Markets**

Aerial lift  
Agriculture  
Bulk chemical handling  
Construction machinery  
Food & beverage  
Fuel & gas delivery  
Industrial machinery  
Life sciences  
Marine  
Mining  
Mobile  
Oil & gas  
Renewable energy  
Transportation

### **Key Products**

Check valves  
Connectors for low pressure fluid conveyance  
Deep sea umbilicals  
Diagnostic equipment  
Hose couplings  
Industrial hose  
Mooring systems & power cables  
PTFE hose & tubing  
Quick couplings  
Rubber & thermoplastic hose  
Tube fittings & adapters  
Tubing & plastic fittings



## **Hydraulics**

### **Key Markets**

Aerial lift  
Agriculture  
Alternative energy  
Construction machinery  
Forestry  
Industrial machinery  
Machine tools  
Marine  
Material handling  
Mining  
Oil & gas  
Power generation  
Refuse vehicles  
Renewable energy  
Truck hydraulics  
Turf equipment

### **Key Products**

Accumulators  
Cartridge valves  
Electrohydraulic actuators  
Human machine interfaces  
Hybrid drives  
Hydraulic cylinders  
Hydraulic motors & pumps  
Hydraulic systems  
Hydraulic valves & controls  
Hydrostatic steering  
Integrated hydraulic circuits  
Power take-offs  
Power units  
Rotary actuators  
Sensors



## **Instrumentation**

### **Key Markets**

Alternative fuels  
Biopharmaceuticals  
Chemical & refining  
Food & beverage  
Marine & shipbuilding  
Medical & dental  
Microelectronics  
Nuclear Power  
Offshore oil exploration  
Oil & gas  
Pharmaceuticals  
Power generation  
Pulp & paper  
Steel  
Water/wastewater

### **Key Products**

Analytical Instruments  
Analytical sample conditioning products & systems  
Chemical injection fittings & valves  
Fluoropolymer chemical delivery fittings, valves & pumps  
High purity gas delivery fittings, valves, regulators & digital flow controllers  
Industrial mass flow meters/controllers  
Permanent no-weld tube fittings  
Precision industrial regulators & flow controllers  
Process control double block & bleeds  
Process control fittings, valves, regulators & manifold valves



## **Seal**

### **Key Markets**

Aerospace  
Chemical processing  
Consumer  
Fluid power  
General industrial  
Information technology  
Life sciences  
Microelectronics  
Military  
Oil & gas  
Power generation  
Renewable energy  
Telecommunications  
Transportation

### **Key Products**

Dynamic seals  
Elastomeric o-rings  
Electro-medical instrument design & assembly  
EMI shielding  
Extruded & precision-cut, fabricated elastomeric seals  
High temperature metal seals  
Homogeneous & inserted elastomeric shapes  
Medical device fabrication & assembly  
Metal & plastic retained composite seals  
Shielded optical windows  
Silicone tubing & extrusions  
Thermal management  
Vibration dampening



**ENGINEERING YOUR SUCCESS.**



Parker Hannifin Corporation  
**Fluid System Connectors Division – Transair**  
300 Parker Drive  
Otsego, MI 49078  
Phone: (480) 830 7764  
Fax: (480) 325 3571  
[transaircustomerservice@parker.com](mailto:transaircustomerservice@parker.com)  
[www.parker.com/transair](http://www.parker.com/transair)

Cat. 3515

09/24

Your Local Authorized Parker Distributor

© 2024 Parker Hannifin Corporation

