

Celebrating over

75 YEARS

GOODYEAR

RUBBER PRODUCTS, INC.

Parker

Continental
CONTITECH

New Location

**GOODYEAR
CORPORATE
HEADQUARTERS
&**

Customer Service Showroom

11301 47th Street North
Clearwater, FL 33762



WE SHIP WORLDWIDE!

Six Locations To Serve You!

CLEARWATER

11301 47th Street North
Clearwater, FL 33762
(727) 822-4672 • (800) 367-4673
Fax (727) 821-8721
Clearwater@goodyearrubberproducts.com

FORT MYERS

12701 Metro Parkway
Ft. Myers, FL 33966
(239) 561-HOSE(4673)
Fax (239) 561-0018
FtMyers@goodyearrubberproducts.com

BRADENTON

6216 - 28th Street East
Bradenton, FL 34203
(941) 739-9777
Fax (941) 739-9778
Bradenton@goodyearrubberproducts.com

TAMPA

5910 Adamo Drive (Hwy 60)
Tampa, FL 33619
(813) 627-8956
Fax (813) 627-8957
Tampa@goodyearrubberproducts.com

ST. PETERSBURG

1901 1st Avenue S.
St. Petersburg, FL 33712
(727) 456-6380
Fax (727) 456-6381
StPete@goodyearrubberproducts.com

NAPLES

5530 Shirley St.
Naples, FL 34109
(239) 596-0072
Fax (239) 596-0073
Naples@goodyearrubberproducts.com

See Locator Maps Next Page

ENGLISH

www.goodyearrubberproducts.us

sales@goodyearrubberproducts.com

SPANISH

www.goodyearrubberproducts.lat

ventas@goodyearrubberproducts.com

Technical Data Is Available On Both English & Spanish Websites (se habla español)

RUBBER & PLASTIC PRODUCTS

For Home & Industry 1-800-FOR-HOSE (367-4673)

RUBBER & PLASTIC PRODUCTS

For Home & Industry

1-800-FOR-HOSE

INDUSTRIAL HOSE & FITTINGS
HYDRAULIC HOSE & FITTINGS
INDUSTRIAL TUBE FITTINGS
PLASTIC TUBING & FITTINGS

AIR & WATER HOSE
MARINE HOSE
BRASS FITTING & VALVES
MATS & RUBBER MATTING

RUBBER BOOTS
GLOVES & RAINWEAR
RUBBER SHEETING & GASKETS
BELT & BELTING



BRADENTON

6216 - 28th Street E.
Bradenton, FL 34203
(941) 739-9777
Fax (941) 739-9778
Bradenton@goodyearrubberproducts.com



On-Site Hose Replacement Service

On-Site Mobile Hose Repair



CLEARWATER (CORPORATE HEADQUARTERS) CUSTOMER SERVICE SHOWROOM

11301 47th Street North
Clearwater, FL 33762
(727) 822-4672 • (800) 367-4673
Fax (727) 821-8721
Clearwater@goodyearrubberproducts.com

On-Site Mobile Hose Repair

On-Site Hose Replacement Service

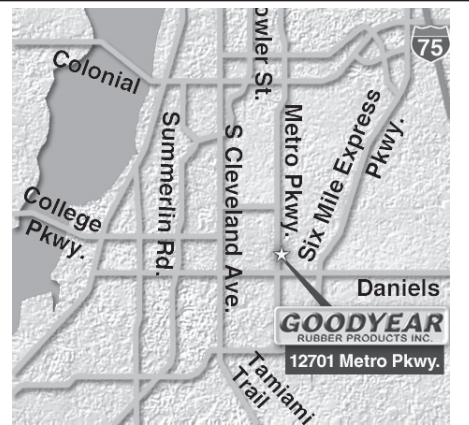

FT. MYERS

12701 Metro Parkway
Ft. Myers, FL 33966
(239) 561-HOSE(4673)
Fax (239) 561-0018
FtMyers@goodyearrubberproducts.com



On-Site Hose Replacement Service

On-Site Mobile Hose Repair



24 Emergency Service for all locations is 727-822-2893 (se habla español)

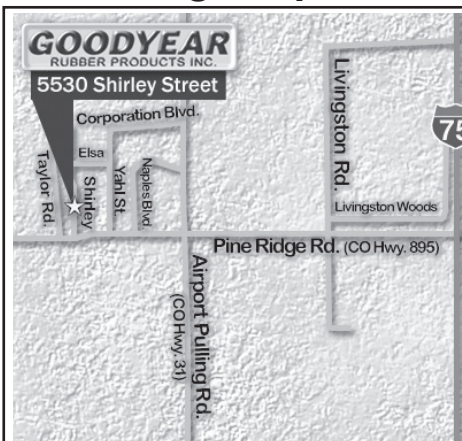

NAPLES

5530 Shirley St.
Naples, FL 34109
(239) 596-0072
Fax (239) 596-0073
Naples@goodyearrubberproducts.com



On-Site Hose Replacement Service

On-Site Mobile Hose Repair



ST. PETERSBURG

1901 1st Avenue S.
St. Petersburg, FL 33712-1366
(727) 456-6380
Fax (727) 456-6381
StPete@goodyearrubberproducts.com



On-Site Hose Replacement Service

On-Site Mobile Hose Repair

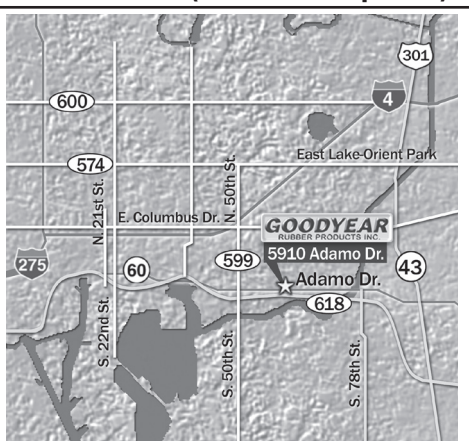

TAMPA

5910 Adamo Drive (Hwy. 60)
Tampa, FL 33619
(813) 627-8956
Fax (813) 627-8957
Tampa@goodyearrubberproducts.com



On-Site Hose Replacement Service

On-Site Mobile Hose Repair



Absorbents			
SpillTech Absorbent Products	45	
Beltting			
Belt Fabrication - Cleats, Guide, Lacing	40	
Clipper Lacing & Tools	41	
Conveyor Beltting HD Rubber	40	
Conveyor Beltting LD - PVC & Urethane	40	
Flexco Lacing-Rivet, Plate & Hinged	41	
Minet SuperScrew Splices	41	
Brass Fittings & Valves			
45 degree Flare Fittings	22	
Hose Barb Fittings	22	
Pipe Fittings	22	
Clamps			
Band Clamps	27, 34	
Boss Interlocking Clamps	27	
Double Bolt Clamps	27, 34	
Single Bolt Clamps	27	
Clamp Tools	34, 37, 38	
Crimped Hose Couplings			
Crimped Camlocks & Male Ends	5	
Crimped Flanged Ends	5	
Electrical Continuity Testing	5	
Hydrostatic Pressure Testing	5	
Large Diameter Hose Crimping	5	
Dock Fenders			
Marine & Loading Dock Fenders	53	
Tow Knees	53	
Dock Hoses			
Composite Dock Hose	17	
Hose Suspension Products	17	
RFID InfoChip System	17	
Rubber Dock Hose	17	
Ducting & Vacuum Hoses			
Flexaust Hose	Back Cover	
Expansion Joints & Connectors			
Flue Duct Expansion Joints	24	
Metal Expansion Joints	24	
Pump Connectors	24	
Rubber Pipe Expansion Joints	24	
Teflon Expansion Joints	24	
Flanges			
Flanges - threaded, slip-on, lap joint	33	
Floor Matting			
Anti-Fatigue Matting	52	
Corrugated Matting	52	
Custom Log Mats	52	
Interlocking Mats	52	
Switchboard Matting	52	
Fluid Sealing Products			
Chevron Hydraulic Cylinder Packing	49	
Mechanical Seals	49	
O-rings and O-Ring kits	39	
Pump and Valve Stem Packing	49	
FRL- Filters, Regulators & Lubricators			
FRL Equipment	33	
Fuel Tanker Products			
API Valves	30	
FloTech Overfill Detection	30	
Fuel Drop Elbows	30	
Gravity Drop Adapters	30	
TTMA Flanges & Adapters	30	
Vapor Recovery	30	
Fuel Transfer Pumps			
Fill-Rite Tuthill	12	
Gaskets			
Cam and Groove Gaskets	29	
Custom Die Cut Gaskets	49	
O-Rings	39	
Pipe Flange Gaskets, FF & Ring	49	
Suction Coupling Gaskets	31	
Water Jet Cut Gaskets	49	
Gasket Material			
Carbon Graphitic Sheet	51	
Compressed Fiber (Non-Asbestos)	51	
Cork / Rubber	51	
Expanded PTFE (Teflon)	51	
Vegetable Fiber	51	
Gauges			
Vacuum, Pressure & Combo	33	
Hardware			
Firesleeve	44	
Hose Protection-Spring Guard & Armor Guard	44	
Paint Brushes	44	
Pump Diaphragms - Mudhog Style	44	
Rubber Tarp Straps	44	
Tapes - Teflon, Electrical, Ducting	44	
Tie Downs	44	
High Temperature Textiles			
Fire Sleeve	48	
Silica Cloth, Tape, Rope and Tubing	48	
Tetraglas Cloth, Tape, Rope and Tubing	48	
Trawl Blankets	48	
Hose Reels			
Spring Rewind, Electric	39	
Hydraulic Hose			
Parker GlobalCore Hose	18	
Parker Tough Cover Hose	19	
Hydraulic Crimp Systems			
Parker Hydraulic Crimpers	19	
Hydraulic Hose Couplings			
Parker Hydraulic Hose Couplings	20	
Hydraulic Quick Connects	34, 39	
Industrial Hose			
Abrasion Resistant Suction Hose	9, 10, 13	
Air & General Purpose Hose	6, 15	
Chemical Hose	9, 15	
Clear Braided Vinyl	11	
Composite Hose	17	
Dock Hose	17	
Dry Material Discharge	9, 14	
Food Hose	4, 10	
Fuel Hose	13	
Garden Hose - Rubber	15	
Hot Air Blower	11	
Hot Tar & Asphalt Hose	15	
Industrial Vacuum Hose	14	
Jackhammer - Air	11	
Marine Exhaust Hose	13	
Material Handling Hose	9, 10, 13, 14	
Mill Hose	33	
Non-Conductive Hose	13	
Petroleum Hose	8, 15, 16	
Push-On Hose	13	
PVC Discharge Hose	16	
PVC Suction Hose	7	
Sandblast Hose	14	
Self Storing Air Hose	39	
Steam Hose	8, 16	
Water Discharge Hose	6, 7	
Water Suction Hose	7, 8, 14	
Industrial Hose Couplings			
Brass Barbed Inserts	26	
Brass Ferrules	26	
Cam and Groove Couplings	27, 28	
Cam and Groove Reducing Parts	28	
Combination Nipples	26	
Crimp/Swage Nipples	26	
Dual Lock Couplings	27, 28	
Ground Joint Couplings	27, 28	
Long Shank Couplings	27	
Quick Connect Couplings	34	
Sandblast Couplings	28	
Sanitary (FDA/3A) Couplings	4, 39	
Short Shank Couplings	27	
Steel Nipples	26	
Strainers and Skimmers	31	
Universal Air Couplings	27, 28	
Water Suction Couplings	27	
Lubrication Equipment			
Grease Guns	36	
Grease Pumps	36	
Lock N Flate Air Chuck	35	
Lock N Lube Grease Coupler	35	
Lubrication Fittings	36	
Marine Industry Hoses			
Fuel Hose	54	
Marina Gas & Diesel Fuel Hoses	54	
Marina Sanitary Pump out Assemblies	54	
Marine Exhaust Hose	54	
Power Trim Hoses	54	
Silicone Connectors	54	
Metal Hose & Expansion Joints			
Corrugated Metal Hose	25	
Metal Expansion Joints	25	
Strip Wound Metal Hose	25	
Nozzles			
Air Nozzles	39	
Fire Nozzles	32	
Garden Hose Nozzles	32	
Washdown Nozzles	32	
Power Transmission Products			
Classic V-Belts (A,B,C,D)	42	
Cogged V-Belts (A,B,C,D)	42	
Falcon Pd Belts	42	
FHP Belts	42	
Metric Belts	42	
Silent Sync Belts (formerly called Eagle Pd)	42	
Synchrochain Belts 4	2	
Torque Team Banded Belts	42	
Safety & Protective Gear			
Bibs, Rainwear, Coats, Suits	46	
Boots- Rubber & PVC - Steel Toe & Plain	47	
Chemical Protective Gear	46	
Gloves	47	
Hard Hats	46	
Safety Glasses & Goggles	47	
Sanitary Hose & Couplings			
Dry Bulk Food Hose	4	
I-line Fittings	4	
Sanitary Gaskets	4	
Tri-Clover Style Fittings	4	
Wine & Brewery Hose	4	
Sheet Rubber			
Butyl	50	
Closed Cell Sponge	50	
EPDM	50	
Fabric Reinforced Rubber	50	
FKM (Viton Fluoroelastomer)	50	
Gum Rubber	50	
Neoprene	50	
Nitrile (Buna-N)	50	
SBR - Red Rubber	50	
Silicone (Solid and Sponge)	50	
White FDA Rubber	50	
Thermoplastic Tubing			
Clear Vinyl	21	
Nylon	21	
Polyethylene, Polypropylene, Polyurethane	21	
Thermoplastic Tube Fittings			
Fast & Tite	21	
Mini-Barb	21	
Par-Barb	21	
Truseal	21	
Valves			
Boiler Drain Valves	21	
Brass Ball Valves	23	
Check Valves	23	
Foot Valves	31	
Gas Appliance Valves	23	
Gate Valves	23	
Glove Valves	23	
Hose Bib Valves	23	
Plug Valves	23	
Polypropylene Ball Valves	23	
Stainless Steel Ball Valves	23	

SANITARY HOSE ASSEMBLIES & ACCESSORIES

Goodyear Rubber Products stocks and fabricates a complete line of Sanitary application hoses and fittings.

Both internal expansion and external crimp styles available with “clamp style ends” (commonly referred to as Tri-Clover style), I-line, Wine and Brewery, John Perry Style along with European and DIN fittings, valves, tube and pipe fittings manufactured by the Sanitary Division of Dixon Valve and Coupling.



*If we don't stock it...
We can make it!*

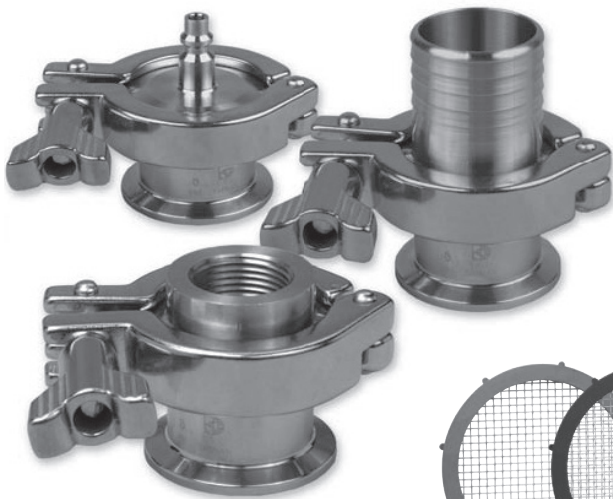

**Sanitary
Hose, Fittings,
Valves
and Clamps
available from
stock.**



CRIMPING & MORE

Goodyear Rubber Products offers
hose crimping in-house!

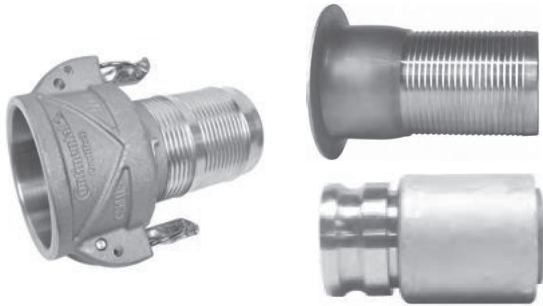

Goodyear's new crimper is
**ONE OF THE LARGEST IN THE
SOUTHEASTERN USA**
with a 13-3/4" jaw opening is capable of crimping
most 8" ID hose on the market today.

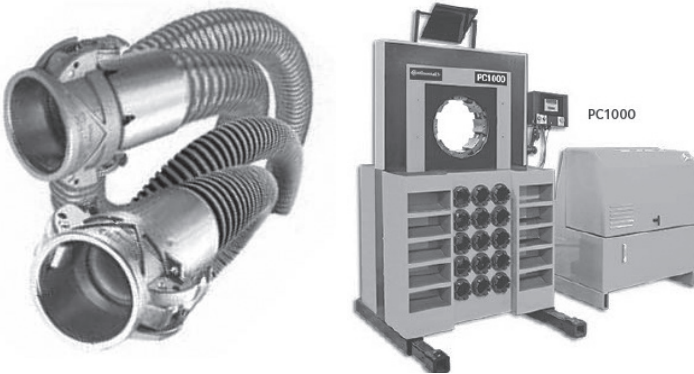

Hydrostatic pressure testing along with electric continuity testing available.













Goodyear Rubber Products provides Certification
to U.S. Coast Guard and NAHAD/RMA
Specifications upon request

Se habla español



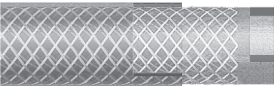

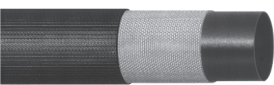
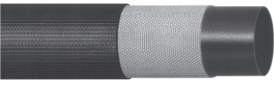

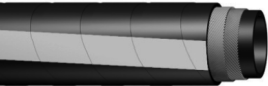

Technical Data Is Available On Both English & Spanish Websites

INDUSTRIAL HOSE

PRODUCT	DESCRIPTION	APPLICATION	PRESSURE	SIZES	TEMPERATURE
Air Hoses - Also Available: <i>Hi-Temp Steelflex Air, Oroflex Air, Oroflex 20, Duraflex 20 & Hot Air Blower</i>					
	Yellow cut and abrasion resistant cover with blue stripe. Tube is oil resistant synthetic rubber.	A superior quality mining, construction and industrial hose.	400 PSI	1/2" - 4"	-35°C to +80°C -30°F to +180°F
Super Service Air					
	Yellow cut and abrasion resistant rubber cover with oil mist resistant synthetic rubber tube.	For mining, construction, and industrial use.	250 - 300 PSI	1/2" - 4"	-35°C to +80°C -30°F to +180°F
Contractors Air					
	Yellow cut and abrasion resistant cover with red stripe. Tube is oil resistant synthetic rubber.	High pressure steel reinforced air service for mining, construction and industrial use. More resistant to external abuse than textile air hose. Mandrel built.	400 - 1000 PSI	1/2" - 4"	-35°C to +80°C -30°F to +180°F
Steelflex Air					
	Smooth Yellow cut and abrasion resistant rubber cover with oil mist resistant synthetic rubber tube.	An economical air hose for jackhammer and other uses on construction sites. Also for general industrial use.	300 PSI	3/4"	-35°C to +80°C -30°F to +180°F
Jackhammer					
General Purpose - Also Available: <i>General Purpose, Urethane General Purpose & Self Storing Air</i>					
	Red, oil, grease, weather and abrasion resistant nitrile/pvc cover with nitrile tube.	A premium quality long length hose for petroleum based fluids, lubricating oils, air, hot water and some chemical solutions.	250 - 300 PSI	1/4" - 1 1/2"	-32°C to +85°C -25°F to +185°F
Premium General Purpose - Non Conductive					
	Smooth red abrasion and weather resistant EPDM synthetic rubber tube and cover.	Air, water, agricultural spray solutions, and other dilute chemicals. Excellent resistance to heat and weathering. Also resists animal fats, vegetable oils and Methyl Ethyl Ketone.	150 - 250 PSI	1/4" - 2"	-30°C to +93°C -20°F to +200°F
EPDM General Purpose					
	Clear smooth PVC.	An economical FDA quality hose for handling air, water, oil, mild chemicals, and alkalis. Clear wall allows visual inspection of product. 3A/USDA/NSF-51 Compliant.	65 - 250 PSI	3/16" - 2"	-5°C to +65°C +25°F to +150°F
Clear Reinforced PVC					
	Black, Grey, Red, Blue, or Yellow oil, weather and abrasion resistant nitrile/pvc cover with nitrile tube.	Transmission of most petroleum-based hydraulic fluids, mineral oil, diesel fuel, engine coolant solutions, agricultural sprays and a wide range of chemical solutions.	250 - 300 PSI	1/4" - 3/4"	-32°C to +80°C -25°F to +180°F
Push On					
	Blue weather and oil resistant synthetic rubber specially compounded for arctic service featuring a static wire.	A premium general purpose hose for conveying air, water, petroleum products and some chemicals under arctic conditions.	300 PSI	1/2" - 2"	-54°C to +65°C -65°F to +150°F
Arctic General Purpose					
Water Discharge - Also Available: <i>H.D Water Discharge, Garden Hose, High Pressure Water Discharge, Papermill, Packers Washdown, White Sanitary & Single Jacket Industrial Mill</i>					
	Black abrasion, weather and oil resistant nitrile rubber cover with oil resistant nitrile rubber tube.	A lightweight high pressure, extremely strong hose for general water and oil discharge, and for some chemicals.	150 - 200 PSI	1 1/2" - 8"	-20°C to +80°C 0°F to +180°F
Oroflex 10 Layflat					
	Black abrasion, weather and oil resistant nitrile rubber.	This is a lightweight high pressure, extremely strong hose for general water discharge service. Ideal for rental service where long life and competitive pricing is paramount. Its compact characteristics make this an ideal hose for use with portable pumps. Especially suited for pumping oily contaminated water.	150 - 200 PSI	2" - 6"	-20°C to +80°C 0°F to +180°F
Duraflex - Rubber Layflat					
	Smooth cover blue and black (also wrapped version) oil resistant synthetic rubber cover. One high tensile steel braid with oil resistant synthetic rubber tube.	Extremely flexible, compact hose for use on pressure washers with working pressures up to 3000 psi. Available in 4500 psi, 250°F.	3000 PSI	3/8"	-29°C to +100°C -20°F to +212°F
Pressure Washer					

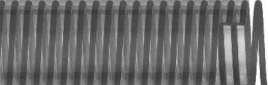
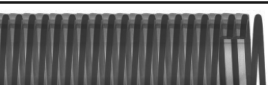
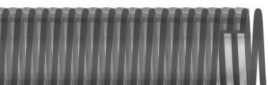
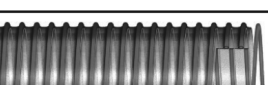
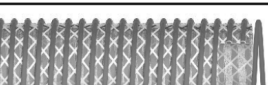





INDUSTRIAL HOSE

PRODUCT	DESCRIPTION	APPLICATION	PRESSURE	SIZES	TEMPERATURE
Water Discharge - Also Available: H.D Water Discharge, Garden Hose, High Pressure Water Discharge, Papermill, Packers Washdown & White Sanitary					
	Blue, Brown or Green PVC impregnation.	Light (Blue) to Heavy (Brown and Green) duty layflat hose for portable pump and irrigation use.	30 - 150 PSI	3/4" - 12"	-10°C to +60°C +15°F to +140°F
PVC Layflat					
	Black abrasion and weather resistant synthetic rubber cover with synthetic rubber tube.	A lightweight water discharge hose which is ideal for use with portable pumps, and general water discharge service.	75 - 100 PSI	1 1/4" - 12"	-35°C to +80°C -30°F to +180°F
Contractors and Contractors Plus Water Discharge					
	Black abrasion and weather resistant synthetic rubber cover with synthetic rubber tube.	For use on construction sites and general water service.	150 - 300PSI	1/2" - 1"	-35°C to +80°C -30°F to +180°F
Contractors Water Discharge - Industrial Garden Hose					
Water Suction - Also Available: EPDM Aggie Water S & D					
	A hose constructed with extra soft PVC, a feature that ensures greater flexibility and ease of handling at very low temperatures. Also available with static wire.	Can be used for light oil, grease and animal fat suction. It can also be used in more general applications where great flexibility is required at very low temperatures.	35 - 70 PSI 29" HG	2" - 6"	-40°C to +60°C -40°F to +140°F
Superflex					
	Black smooth abrasion and weather resistant synthetic rubber.	A heavy duty wire reinforced rubber suction hose for construction, quarries and general use.	50 - 200 PSI 29" HG	3/4" - 12"	-30°C to +80°C -22°F to +180°F
Rubber Water S & D					
	Clear abrasion and weather resistant extra soft low temperature PVC with blue helix	An economical, flexible hose for construction pumps, septic tank & marine pump-out service. Resistant to some chemicals, mild acids & alkalis. Consult us for recommendations. Soft low temperature compounds allow for increased flexibility.	25 - 45 PSI 29" HG	3/4" - 6"	-40°C to +65°C -40°F to +150°F
Water S&D					
	Clear abrasion and weather resistant PVC.	An economical, flexible hose for construction pumps, septic tank & marine pump-out service. Resistant to some chemicals, mild acids & alkalis. Consult us for recommendations.	25 - 90 PSI 28 - 29" HG	3/4" - 8"	-20°C to +65°C -5°F to +150°F
Green PVC Water S&D					
	Clear abrasion and weather resistant extra soft PVC.	An economical, flexible hose for construction pumps, septic tank & marine pump-out service. Resistant to some chemicals, mild acids & alkalis. Consult us for recommendations. Specially formulated compounds allow for increased flexibility at low temperatures.	35 - 90 PSI 29" HG	3/4" - 6"	-40°C to +65°C -40°F to +150°F
Low Temperature PVC Water S&D					
	Clear abrasion and weather resistant PVC.	An economical, flexible hose for construction pumps, septic tank & irrigation lines. Resistant to some chemicals, mild acids & alkalis. Consult us for recommendations.	15 - 45 PSI 26 - 29" HG	1" - 12"	-40°C to +65°C -40°F to +150°F
Grey PVC Water S&D					
	Clear abrasion and weather resistant PVC with high tensile synthetic yarn reinforcement.	Good for both suction and discharge applications, this heavy duty hose can be used for rental/construction pumping as well as fish suction hose.	40 - 110 PSI 28 - 29" HG	2" - 10"	-23°C to +65°C -10°F to +150°F
Textile Reinforced S & D					
	Clear abrasion and weather resistant PVC with white helix.	An economical, flexible hose for construction pumps, septic tank & marine pump-out service. Can also be used in air seeder applications.	35 - 90 PSI	3/4" - 8"	-20°C to +65°C -4°F to +150°F
White PVC Water Suction and Discharge Hose					

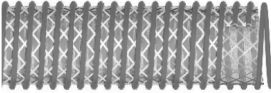
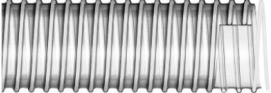
INDUSTRIAL HOSE

PRODUCT	DESCRIPTION	APPLICATION	PRESSURE	SIZES	TEMPERATURE
Water Suction - Also Available: EPDM Aggie Water S & D					
	Green polypropylene and Black EPDM.	Agricultural suction, general industrial use where high working pressures are not required.	22 - 50 PSI 29" HG	1 1/2" - 6"	-40°C to +60°C -40°F to +140°F
EPDM Water Suction					
Steam - Also Available: Textile Steam					
	Red, heat, weather and abrasion resistant EPDM synthetic rubber tube and cover.	An extremely flexible steel reinforced hose for use with saturated steam at pressures to 250 PSI.	250 PSI	1/2" - 3"	-40°C to +210°C -40°F to +406°F
Steam 250					
	Red abrasion resistant EPDM cover with Chlorobutyl synthetic rubber tube.	An extremely flexible steel reinforced hose for use with saturated steam at pressures to 250 PSI. Chlorobutyl tube has a low permeation factor resulting in resistance to popcorning of tube.	250 PSI	1/2" - 2"	-40°C to +210°C -40°F to +406°F
CB Steam 250					
Petroleum - Also Available: Agricultural Farm Tank, Tank Truck Drop, SAE100R4, W187 Vapour Recovery & Hot Tar & Asphalt					
	Black, abrasion, gasoline and oil resistant synthetic rubber with blue stripe.	An all purpose petroleum suction and discharge hose for use with gasoline, kerosene, diesel, oil suspensions and emulsions. May also be used as hydraulic return line and suction.	150 PSI 29" HG	3/4" - 6"	-35°C to +93°C -30°F to +200°F
Tank Truck					
	Black, abrasion, gasoline and oil resistant synthetic rubber with blue stripe and pressure.	An all purpose petroleum suction and discharge hose for use with gasoline, kerosene, diesel, oil suspensions and emulsions up to 250 PSI. May also be used as hydraulic return line and suction.	250 PSI	2" - 6"	-35°C to +93°C -30°F to +200°F
Super Black 250					
	Blue weather and oil resistant synthetic rubber specially compounded for arctic service. Corrugated with white stripe.	Specially designed to remain flexible while handling a wide range of petroleum products, including gasoline and diesel under arctic conditions.	150 PSI	1 1/2" - 6"	-54°C to +90°C -65°F to +195°F
LW Arctic Superflex 150 Petroleum					
	Black, abrasion and oil resistant synthetic rubber with red stripe.	Specially designed for conveying hot oil and/or Glycol at temperatures up to 120°C (250°F).	150 PSI	2" - 4"	up to +120°C 250°F
H.O.T Oil Tank Truck					
	Black, abrasion, gasoline and oil resistant synthetic rubber with green stripe.	An all purpose lightweight and flexible petroleum suction and discharge hose for use with gasoline, kerosene, diesel, oil suspensions and emulsions. May also be used as hydraulic return line and suction.	150 PSI	2" - 6"	-40°C to +93°C -40°F to +200°F
LW Petroleum Tank 150					
	Red, heat, oil and weather resistant Neoprene cover with nitrile tube.	For handling a wide range of petroleum products, including gasoline, as well as a number of chemical solutions.	150 - 200 PSI	3/4" - 4"	-35°C to +88°C -30°F to +190°F
Petroleum Discharge					
	Black, heat, oil and weather resistant Neoprene.	For handling a wide range of petroleum products, including gasoline, as well as a number of chemical solutions.	250 PSI	2" - 6"	-35°C to +88°C -30°F to +190°F
Petroleum Discharge 250					
	Orange PVC helix with high tensile synthetic yarn reinforcement and built in static wire.	For use as a tank truck gravity drop hose. Also for use with oil, fuel and grease transfer, oil slurry, hydrocarbons and animal fat handling. Features an external helix that protects the hose cover as well as enabling the hose to slide over rough surface.	65 - 70 PSI 28" HG	2" - 4"	-29°C to +65°C -20°F to +150°F
Petroleum Drop Hose					

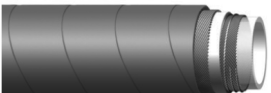
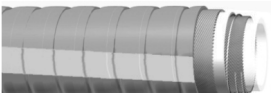





INDUSTRIAL HOSE

PRODUCT	DESCRIPTION	APPLICATION	PRESSURE	SIZES	TEMPERATURE
Petroleum - Also Available: <i>Agricultural Farm Tank, Tank Truck Drop, SAE100R4, W187 Vapour Recovery & Hot Tar & Asphalt</i>					
	Green PVC Helix with polyurethane cover. BDROP is clear wall for flow visibility and BDROPB is black with added UV resistance.	For use as a tank truck gravity drop hose with biofuel, gasoline, diesel and ethanol. Lightweight and flexible with exposed pvc helix making it very user friendly.	65 PSI	3" - 4"	-40°C to +65°C -40°F to +150°F
Urethane Bio-Drop Fuel Hose					
	Convuluted yellow helix.	Vapour recovery from petroleum transfer operations. Embedded static wire serves to dissipate static electricity. NOT SUITABLE FOR CONVEYING LIQUIDS	9 - 17 PSI	2" - 4"	-40°C to +65°C -40°F to +150°F
Vapour Thane Dust & Vapour Recovery Hose					
Material Handling - Also Available: <i>Tan Bulkmaster, Furnace Door Cooling, Concrete Boom, Concrete Placement & Bulkmaster Hardwall</i>					
	Thick black corrugated abrasion and weather resistant synthetic blend cover. Red 3/8" thick super abrasion resistant natural rubber tube.	Primarily designed for handling abrasive slurries in mines and quarries. Can also be used for dry material handling of sand, gravel, grain, slag, and other such materials. External re-usable bolt on flanges allow for ease of installation, and uninterrupted free flow.	150 PSI 30" HG	3" - 12"	-40°C to +80°C -40°F to +180°F
Aztec					
	Black abrasion and weather resistant synthetic rubber cover with black abrasion resistant natural rubber tube. Green stripe on 1/4" thick tube.	Dry bulk discharge including limestone, ground silica, chalk, dry cement, fertilizer etc. May also be used for wet abrasive applications.	75 PSI	3" - 6"	-30°C to +80°C -25°F to +180°F
Dry Material Softwall					
	Black static conductive synthetic rubber cover with thick black static conductive abrasion resistant natural rubber tube.	For conducting sand, steel shot, and other abrasives for blast cleaning.	150 PSI	1/2" - 3"	-35°C to +80°C -30°F to +180°F
Sandblast					
	Black weather and abrasion resistant cover with black abrasion resistant pure gum rubber tube.	For handling abrasive dust from wood, metal, rock, marble and concrete grinding machines under vacuum.	40 PSI 10 - 24" HG	1" - 6"	-30°C to +80°C -25°F to +180°F
Industrial Vacuum					
Chemical - Also Available: <i>Hypalon Acid S & D, Viton Lined S & D, EPDM Acid S & D</i>					
	Green smooth chemical resistant EPDM rubber cover with cross-linked polyethylene tube.	The cross-linked polyethylene tube makes this one of the most versatile types of hose available to the chemical industry today. It will handle 90% of known chemical and petroleum products in both suction and discharge applications.	200 PSI 29" HG	1/2" - 4"	-29°C to +120°C -20°F to +248°F
XLPE Chemical					
	Green corrugated chemical resistant EPDM rubber with FDA UHMW polyethylene tube.	Similar to Chemical hose above but may be used at lower temperatures. More versatile than our Chemical hose, Flexchem handles 98 per cent of known chemicals and can be steam cleaned. Corrugated cover results in a more flexible hose.	200 PSI 29" HG	3/4" - 4"	-40°C to +65°C -40°F to +150°F
UHMW Chemical					
Material Handling Polyurethane and PVC - Also Available: <i>Grey PVC Vacuum</i>					
	Corrugated clear PVC rigid helix. FDA, 3A and USDA compliant.	Conveying of dry powders, grains and plastic pellets where viewing the product is important. B Flex Static has built-in static wire.	25 - 45 PSI 29" HG	1 1/2" - 3" and 39mm	-23°C to +65°C -10°F to +150°F
B Flex/B Flex Static					
	Corrugated clear PVC with clear rigid PVC helix. FDA, 3A and USDA compliant.	Suction and discharge of liquids, grains, plastic pellets and powders where moderate abrasion is a factor. Static Dissipating FDA Suction Hose has built-in static wire.	20 - 55 PSI 29" HG	1" - 8"	-23°C to +65°C -10°F to +150°F
Suction/Static Suction					

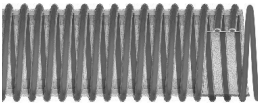
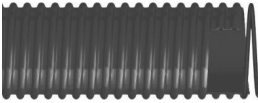
Other Hoses Available: *Auto Heater Hose, Marine Hardwall/Softwall/Fuel Fill Hose, Silicone Coolant and Heater Hose, Garage Exhaust Hose, Welding Hose, Pressure Washer Hose, Paint Spray Hose, Auto Fuel Line Hose.*

Technical Data Is Available On Both English & Spanish Websites

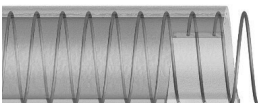
INDUSTRIAL HOSE

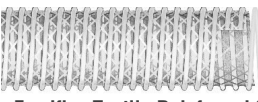
PRODUCT	DESCRIPTION	APPLICATION	PRESSURE	SIZES	TEMPERATURE
Material Handling Polyurethane and PVC - Also Available: Grey PVC Vacuum					
	Corrugated clear abrasion and weather resistant Polyurethane with grey PVC helix. FDA, 3A and USDA compliant.	Ideal for applications where conventional rubber or PVC hose will wear rapidly, i.e. grain transfer, abrasive powder recovery, leaf collection. PU Vac Static has built-in static wire.	3 - 50 PSI 29" HG	1 1/2" - 6"	-40°C to +65°C -40°F to +150°F
PU Vac/PU Vac Lite/PU Vac Static					
	Blue HMW PVC up to 5" I.D. Black cover in 6" and 8" I.D.	Used in a variety of material handling application where a good resistance to abrasion is required, such as transfer of sands, plastic pellets, gravel, wood chips, slurries and fly ash. Also for use on vacuum excavation trucks. Cover is a specially formulated static dissipative compound with low temperature flexibility.	30 - 45 PSI 28 - 29" HG	2" - 8"	-40°C to +65°C -40°F to +150°F
ARI HD					
	This hose has a polyurethane tube with an HMC cover. Cover is a specially formulated technical alloy that makes this hose antistatic.	Used in a variety of material handling application where a good resistance to abrasion is required, such as transfer of sands, plastic pellets, gravel, wood chips, slurries and fly ash.	30 - 45 PSI 29" HG	2" - 8"	-40°C to +65°C -40°F to +150°F
ARI					
Food - Also Available: Pure Gum Tubing, Polyethylene Tubing & Clear Vinyl Tubing					
	Smooth clear, food grade PVC non-marking with red rigid PVC helix. FDA, 3A and USDA compliant.	Alcoholic beverages up to 25% alcohol content. Fruit juices, soft drinks and other liquid foodstuffs. Also suitable for dry bulk foodstuffs.	35 - 85 PSI 29" HG	3/4" - 5" and 38 - 50mm	-23°C to +65°C -10°F to +150°F
Bacco					
	Red abrasion resistant natural rubber tube and cover.	Will handle a wide range of non fatty-oily food products up to 80°C where taste and aroma must not be affected.	140 PSI	3/4" - 3"	-35°C to +80°C -30°F to +180°F
Brewers and Beverage Discharge					
	Smooth clear PVC with wire helix. Super Wirevac has additional layer of fabric reinforcement. FDA, 3A, USDA and NSF-51 compliant.	An extremely flexible transparent hose for use where full vacuum performance is required while monitoring the contents of the hose. Ideal for use with most foodstuffs, cosmetics, beverages, and a wide range of chemical solutions. Also suitable for lubricating oils and animal fats.	45 - 250 PSI 28" HG	3/8" - 3"	-10°C to +65°C +15°F to +150°F
Wirevac					
	Clear PVC non-marking. FDA, 3A and USDA compliant.	For dry bulk foodstuffs, pharmaceuticals, cosmetics, milk, fruit and vegetable juices, soft drinks, alcoholic beverages, flour, sugar etc. Clear wall allows visual inspection of the product.	50 - 85 PSI 29" HG	3/4" - 4"	-23°C to +65°C -10°F to +150°F
Foodflex PVC S & D					
	Clear PVC non-marking with high tensile yarn reinforcement. FDA, 3A and USDA compliant.	For liquid or dry bulk foodstuffs, pharmaceuticals, cosmetics, milk, fruit and vegetable juices, soft drinks, alcoholic beverages, flour, sugar, poultry or meat packing etc. Clear wall allows visual inspection of the product.	60 - 110 PSI 28 - 29" HG	2" - 8"	-23°C to +65°C -10°F to +150°F
Foodflex Textile Reinforced S & D (Food Grade)					

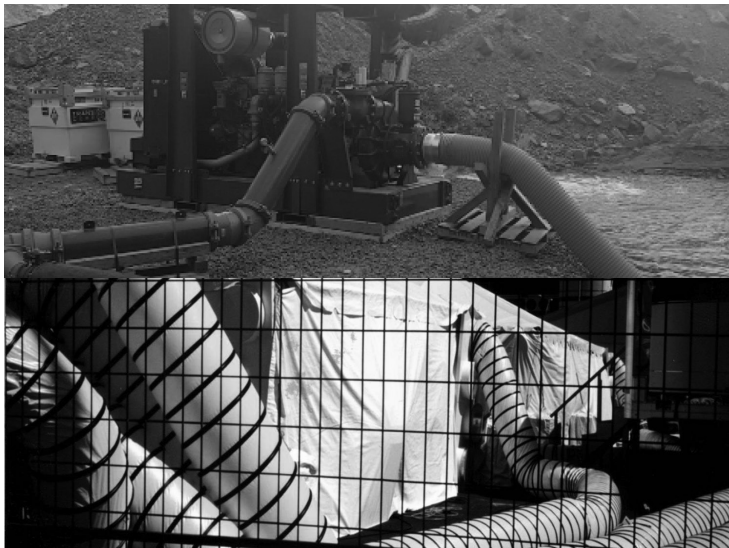

INDUSTRIAL HOSE

CLEAR REINFORCED PVC (FOOD QUALITY)



APPLICATION: An economical hose for handling air, water, oil, mild chemicals, and alkalis. Clear wall allows visual inspection of product. **COVER:** Clear smooth PVC **REINFORCEMENT:** Multiple layers of synthetic yarns **TUBE:** Clear smooth PVC

TEMPERATURE: -5C to +65C (+25F to +150F)

NOM. ID"	NOM. OD"	PSI	STD PACK	WEIGHT#
3/16	0.38	250	300	0.05
1/4	0.43	250	300	0.07
1/4	0.43	250	100	0.07
5/16	0.53	300	300	0.08
5/16	0.53	300	100	0.08
3/8	0.59	250	300	0.09
3/8	0.59	250	100	0.09
1/2	0.71	250	300	0.15
1/2	0.71	250	100	0.15
5/8	0.87	200	300	0.17
5/8	0.87	200	100	0.17
3/4	1.02	180	300	0.23
3/4	1.02	180	100	0.23
1	1.30	150	300	0.32
1	1.30	150	100	0.32
1-1/4	1.61	100	100	0.58
1-1/2	1.89	85	100	0.69
2	2.44	65	100	1.00

HOT AIR BLOWER HOSE



APPLICATION: FOR CONVEYING HOT AIR FROM BLOWER TO TANK ON DRY BULK TRUCKS.

COVER: Black heat and weather resistant EPDM rubber.

REINFORCEMENT: High tensile wire helix embedded between layers of heat resistant synthetic fabric.

TUBE: Black specially compounded heat resistant EPDM rubber.

TEMPERATURE: -40C to +163C (-40F to +350F)

NOM. ID"	NOM. OD"	PSI	BEND RADIUS	STD PACK	WEIGHT#
3	3.62	150	12.00	100	1.75
4	4.65	150	15.00	100	2.40

JACKHAMMER - AIR



APPLICATION: An economical air hose for jackhammer and other uses on construction sites. Also for general industrial use

COVER: Red smooth cut and abrasion resistant
REINFORCEMENT: Multiple layers of synthetic yarn
TUBE: Synthetic oil mist resistant

TEMPERATURE: -35C to +80C (-30F to +180F)

NOM. ID"	NOM. OD"	PSI	STD PACK	WEIGHT#	COLOR
3/4	1.14	300	50	0.40	Yellow
3/4	1.14	300	50	0.40	Red
3/4	1.14	300	50	0.40	Green
3/4	1.14	300	50	0.40	Blue
3/4"	1.14	300	50	0.40	Yellow
3/4"	1.14	300	50	.40	Red

EPDM GENERAL PURPOSE 300



APPLICATION: Air, water, agricultural spray solutions, and other dilute chemicals Excellent resistance to heat and weathering

Also resists animal fats, vegetable oils.

COVER: Smooth red abrasion and weather resistant EPDM synthetic rubber

REINFORCEMENT: Multiple layers of synthetic yarn
TUBE: Synthetic oil mist resistant EPDM synthetic rubber

TEMPERATURE: -30C to +93C (-20F to +200F)

NOM. ID"	NOM. OD"	PSI	STD PACK	WEIGHT#
1/4	0.55	300	300	0.14
3/8	0.70	300	300	0.20
1/2	0.87	300	300	0.27
5/8	0.98	300	300	0.31
3/4	1.16	300	300	0.44
1	1.42	300	300	0.59

**WE EXTERNALLY CRIMP & INTERNALLY EXPAND
COUPLINGS ON INDUSTRIAL HOSES!**

FUEL TRANSFER PUMPS

FILL-RITE®

12V Mobile DC Transfer Pumps

For Gasoline / Diesel / B20 / E-15 / Kerosene / Mineral Spirits



For in-bed truck tanks

For mobile tanks used in farming or construction

Great emergency response pump

FILL-RITE DEF™

NEW! DEF Pump Systems

For Diesel Exhaust Fluid (DEF) / AdBlue® / Water



DEF/ADBLUE® SYSTEMS

FROM THE LEADER

IN FUEL TRANSFER

PORTABLE SERIES

RD

THE MOST VERSATILE DC PUMP AVAILABLE

- Configurable Flanges • Aluminum Construction
- Multiple Mounting Options
- Quick Connect Power Cord

Tuthill
PUMP YOUR HEART INTO IT

Available Models

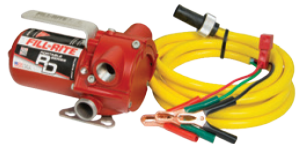

RD812NN - 8GPM (30LPM)
RD1212NN - 12GPM (45LPM)
Pump Only

Includes

- 10' Quick connect power cord with alligator clips



RD812NH - 8GPM (30LPM)
RD1212NH - 12GPM (45LPM)
Pump with Hose and Nozzle
Includes

- Manual nozzle • 8' Discharge hose
- 6' Suction hose
- 10' Quick connect power cord with alligator clips



RD812NP - 8GPM (30LPM)
RD1212NP - 12GPM (45LPM)
Bung Mount Option
Pump with Hose and Nozzle
Includes

- Manual nozzle • 8' Discharge hose
- 23"-41" Telescoping suction tube • Nozzle boot
- Bung tank mount adapter
- 10' Quick connect power cord with alligator clips

Features

- Gasoline, diesel, biodiesel (up to B20), kerosene and E15
- Aluminum construction
- 3/4" inlet/outlet
- Low profile
- Thermally protected
- Self-priming
- 30-Minute duty cycle
- Smooth in-line switch

INDUSTRIAL HOSE

PREMIUM GENERAL PURPOSE NON CONDUCTIVE WITH REEL



APPLICATION: Air, water, agricultural spray solutions, and other dilute chemicals Excellent resistance to heat and weathering

Also resists animal fats, vegetable oils.

COVER: Red, Oil, Grease, Weather & Abrasion resistant nitrile

REINFORCEMENT: Multiple layers of synthetic yarn

TUBE: Synthetic oil mist resistant EPDM synthetic rubber

TEMPERATURE: -30C to +93C(-20F to +200F)

NOM. ID"	NOM. OD"	PSI	STD PACK	WEIGHT#
3/8	0.67	300	300	0.17
1/2	0.79	300	300	0.21
3/4	1.14	300	300	0.39
1	1.42	300	300	0.51
1-1/4	1.77	300	200	0.70

PUSH-ON BLACK



APPLICATION: Transmission of most petroleum-based hydraulic fluids, mineral oil, diesel fuel, engine coolant solutions, agricultural sprays and a wide range of chemical solutions. Also suitable for air and water service

COVER: Black, oil, weather and abrasion resistant Neoprene.

REINFORCEMENT: Multiple layers of polyester yarns.

TUBE: Black oil resistant nitrile rubber.

TEMPERATURE: -32C to +80C(-25F to +180F)

NOM. ID"	NOM. OD"	PSI	STD PACK	WEIGHT#
1/4	0.50	250	700'	0.10
3/8	0.63	250	700'	0.14
1/2	0.75	250	700'	0.17
5/8	0.91	250	700'	0.19
3/4	1.03	250	700'	0.19

ABRASION RESISTANT SUCTION



NOM. ID"	NOM. OD"	VACUUM	PSI	BEND RADIUS"	STD PACK	WEIGHT#
3	3.65	29	40	4.00	100'	1.18
4	4.76	29	35	6.00	100'	1.95
6	6.80	28	30	12.00	100'	3.51

MARINE EXHAUST HARDWALL



APPLICATION: Marine exhaust applications, and other general applications where non-standard sizes are specified. Meets SAEJ 2006 R1

COVER: Black heat and weather resistant synthetic rubber with blue identification stripe.

REINFORCEMENT: High tensile wire helix embedded between layers of textile cords.

TUBE: Black heat resistant rubber specially compounded for wet marine exhaust service.

TEMPERATURE: -40C to +100C(-40F to +212F)

NOM. ID"	NOM. OD"	STD PACK	WEIGHT#
2-3/8	2.68	100'	1.98
2-1/2	2.81	100'	1.82
3	3.54	100'	2.12
3-1/2	4.09	100'	2.77
4	4.57	100'	3.22
5	5.55	100'	3.59

FUEL LINE



APPLICATION: Fuel and vapour emission lines, meets SAE 30R7 specification and is USCG Type B and BIA approved.

COVER: Black heat and fuel resistant Hypalon.

REINFORCEMENT: Two layers of synthetic yarns.

TUBE: Black fuel resistant nitrile rubber.

TEMPERATURE: -40C to +120C(-40F to +250F)

NOM. ID"	NOM. OD"	PSI	STD PACK	WEIGHT#
1/4	0.49	50	300'	0.10
5/16	0.58	50	300'	0.13
3/8	0.63	50	300'	0.13

APPLICATION: Used in a variety of material handling application where a good resistance to abrasion is required, such as transfer of sands, plastic pellets, gravel, wood chips, slurries and fly ash. Cover is a specially formulated static dissipative compound with low temperature flexibility.

COVER: Black HMW PVC

REINFORCEMENT: Anti shock rigid pvc helix

TUBE: Polyurethane

TEMPERATURE: -40C to +65C(-40F to +150F)

INDUSTRIAL HOSE

DRY MATERIAL DISCHARGE



APPLICATION: Dry bulk discharge including limestone, ground silica, chalk, dry cement, fertilizer etc. May also be used for wet abrasive applications.

COVER: Black abrasion and weather resistant synthetic rubber.

REINFORCEMENT: Multiple layers of high tensile synthetic cords.

TUBE: Black abrasion resistant ant-static natural rubber in 1/8", 3/16" and 1/4"

TEMPERATURE: -30C to +80C(-25F to +180F)

NOM. ID"	NOM. OD"	PSI	STD PACK	WEIGHT#
4	4.64	75	100'	2.33
4	4.72	75	100'	2.65
4-1/2	5.00	75	100'	2.09
5	5.63	75	100'	2.75
5	5.79	75	100'	3.50
6	6.81	75	100'	4.29

INDUSTRIAL VACUUM HEAVY DUTY LENGTHS



APPLICATION: For handling abrasive dust from wood, metal, rock, marble and concrete grinding machines under vacuum.

COVER: Black abrasion resistant rubber, corrugated for flexibility.

REINFORCEMENT: A high tensile steel helix embedded between layers of textile cords.

TUBE: 1/4" or 1/8" red Pure Gum abrasion resistant rubber standard.

TEMPERATURE: -30C to +80C(-25F to +180F)

ASSEMBLY DESCRIPTION	NOM. OD"	VACUUM	PSI	BEND RADIUS"	WEIGHT#
8"x25' H.D.IND VAC. 1/4" Red w/cuffs	9.01	28	50	30.00	190.00
8"x32' H.D.IND VAC. 1/4" Red w/cuffs	9.01	28	50	30.00	243.80
8"x70' H.D.IND VAC. 1/4" Red Tube	9.01	28	50	30.00	716.10

SANDBLAST



APPLICATION: For conducting sand, steel shot, and other abrasives for blast cleaning.

COVER: Black static conductive synthetic rubber.

REINFORCEMENT: Two (SBB) or Four (SBB4) layers of synthetic textile cords.

TUBE: Thick black static conductive abrasion resistant natural rubber.

TEMPERATURE: -35C to +80C(-30F to +180F)

NOM. ID"	NOM. OD"	PSI	STD PACK	WEIGHT#
3/4	1.50	150	100'	0.68
3/4	1.50	150	50'	0.68
1-1/4	2.16	150	100'	1.22
1-1/4	2.16	150	50'	1.22
1-1/2	2.36	150	50'	1.36
3	3.98	150	100'	2.57

EPDM WATER SUCTION



APPLICATION: For use in liquid waste suction application. Also for use with liquid or dry chemical suction applications or general industrial use where high working pressures are not required.

COVER: Green Polyethylene helix and specially formulated rubber.

REINFORCEMENT: Rigid green Polyethylene helix.

TUBE: Smooth specially formulated rubber

TEMPERATURE: -40C to +60C(-40F to +140F)

NOM. ID"	NOM. OD"	VACUUM	PSI	BEND RADIUS"	STD PACK	WEIGHT#
1-1/2	1.85	29	50	3.50	100'	0.40
2	2.44	29	50	5.50	100'	0.67
3	3.52	29	42	7.50	100'	1.10
4	4.61	29	38	12.00	100'	1.84

**24 Emergency Service for all locations is
727-822-2893 (se habla español)**

**STANDARD LENGTHS & COLORS VARY BY MANUFACTURER
CONTACT CUSTOMER SERVICE FOR EXACT SIZES AVAILABLE.**

**Concrete Pump and Boom Hose • Textile and Wire Braid
CUT & COUPLED TO YOUR SPECIFICATIONS**

**WE EXTERNALLY CRIMP & INTERNALLY EXPAND
COUPLINGS ON INDUSTRIAL HOSES!**

INDUSTRIAL HOSE

UHMW CHEMICAL S&D



APPLICATION: The (UHMW) Ultra High Molecular Weight polyethylene tube makes this one of the most versatile types of hose available to the chemical industry today. It will handle 94% of common chemical and petroleum products in both suction and discharge applications. This hose is very flexible due to its corrugated cover and low temperature characteristics.

This hose can also be used in dry food applications due to its FDA Compliant tube.

COVER: Green corrugated chemical resistant EPDM rubber

REINFORCEMENT: High tensile wire helix embedded between layers of textile cords.

TUBE: Smooth chemical resistant (UHMW) Ultra High Molecular Weight polyethylene FDA Compliant tube

TEMPERATURE: -40C to +100C (-40F to +212F) Can be open end steam cleaned to 120C or 248F for 30 minutes

RUBBER WATER HOSE



COVER: Ozone & Weather Resistant Synthetic EPDM Rubber & Other synthetic rubbers

REINFORCEMENT: Polyester Yarn

TUBE: Natural Rubber

TEMPERATURE: "33°F to 180°F, 0°C to 80°C"

DESCRIPTION	COVER COLOR	BEND RADIUS (UOM) (IN)	W.P. (PSI)	B.P. (PSI)	WAR-RANTY (YEARS)	CASE QTY	WEIGHT (EACH)
5/8" x 50' x150psi Black Water hose with GHT fittings	Red/Black	1.6	150	500	2	4	13.08
5/8" x 50' x150psi Red Water hose with GHT fittings	Red/Black	1.6	150	500	2	4	13.38
3/4" x 50' x150psi Black Water hose with GHT fittings	Red/Black	1.8	150	500	2	3	15.57
3/4" x 50' x150psi Red Water hose with GHT fittings	Red/Black	1.8	150	500	2	3	16.60

"Ask us about our new private label line of Goodyear Rubber GOOD FLEX® hose and belting, superior quality products at a competitive price point"

GOOD FLEX™

CORRUGATED PETROLEUM TANK 150



APPLICATION: An all purpose lightweight and flexible petroleum suction and discharge hose for use with gasoline, kerosene, diesel, oil suspensions and emulsions. May also be used as hydraulic suction and return line.

COVER: Black corrugated, abrasion, gasoline and oil resistant synthetic rubber with green stripe.

REINFORCEMENT: High tensile wire helix embedded between layers of textile cords.

TUBE: Black nitrile rubber for maximum oil resistance.

TEMPERATURE: -40C to +93C (-40F to +200F)

NOM. ID"	NOM. OD"	VACUUM	PSI	BEND RADIUS"	STD PACK	WEIGHT#
2	2.53	29	150	4.00	100'	1.44
3	3.62	29	150	6.00	100'	2.48
4	4.72	29	150	9.00	100'	3.63

GENERAL PURPOSE AIR HOSE

COVER: Mix of Natural & Synthetic Rubbers

REINFORCEMENT: Polyester Yarn

TUBE: Natural Rubber

TEMPERATURE: "-40°F to 190°F, -40°C to 90°C"



DESCRIPTION	COVER COLOR	BEND RADIUS (UOM) (IN)	W.P. (PSI)	B.P. (PSI)	WAR-RANTY (YEARS)	CASE QTY	WEIGHT (EACH)
1/4" Hose x 1/4" mnpt 50' Red	Red	0.5	300	1200	2	6	5.44
3/8" Hose x 1/4" mnpt 50' Red	Red	0.6	300	1200	2	4	7.81
1/2" Hose x 3/8" mnpt 50' Red	Red	0.8	300	1200	2	4	11.14

HOT TAR AND ASPHALT



APPLICATION: Specially designed for conveying hot tar and asphalt at temperatures up to 160 C (350 F).

COVER: Black Neoprene synthetic rubber.

REINFORCEMENT: High tensile wire helix embedded between multiple layers of heat resistant synthetic yarns

TUBE: Specially compounded heat resistant synthetic rubber compound.

TEMPERATURE: up to +177C (350F)

NOM. ID"	NOM. OD"	PSI	STD PACK	WEIGHT#
3	3.77	150	100'	2.94
4	4.85	150	100'	4.20

INDUSTRIAL HOSE

TANK TRUCK 150

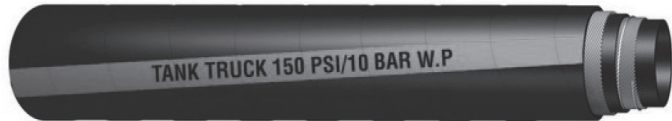

APPLICATION: An all purpose petroleum suction and discharge hose for use with gasoline, kerosene, diesel, oil suspensions and emulsions. May also be used as hydraulic suction and return line.

COVER: Black, abrasion, gasoline and oil resistant synthetic rubber with blue stripe and pressure

REINFORCEMENT: High tensile wire helix embedded between layers of textile cords.

TUBE: Black nitrile rubber for maximum oil resistance.

TEMPERATURE: -35C to +93C (-30F to +200F)

NOM. ID"	NOM. OD"	VACUUM	PSI	BEND RADIUS"	STD PACK	WEIGHT#
3/4	1.14	29	150	3.00	100'	0.43
1	1.42	29	150	3.00	100'	0.57
1-1/4	1.65	29	150	3.50	100'	0.62
1-1/2	1.93	29	150	4.00	100'	0.81
2	2.52	29	150	4.50	100'	1.38
2-1/2	2.99	29	150	4.75	100'	1.72
4	4	29	150	10.00	100'	3.56
6	6	29	150	21.00	100'	6.65

STEAM 250 BLACK



APPLICATION: An extremely flexible hose for use with saturated steam at pressures to 250 PSI .

COVER: Black abrasion and heat resistant EPDM rubber, with embossed brand and pressure.

REINFORCEMENT: Multiple layers of high tensile steel cords.

TUBE: Black heat resistant EPDM synthetic rubber.

TEMPERATURE: -40C to +210C (-40F to +406F)

NOM. ID"	NOM. OD"	PSI	STD PACK	WEIGHT#
3/4	1.26	250	50'	0.48
1	1.50	250	50'	0.60
1-1/2	2.13	250	50'	1.10
2	2.64	250	50'	1.48

TANK TRUCK 300



APPLICATION: An all purpose petroleum suction and discharge hose for use with gasoline, kerosene, diesel, oil suspensions and emulsions up to 300 PSI. May also be used as hydraulic suction and return line.

COVER: Black, abrasion, gasoline and oil resistant synthetic rubber with red stripe and pressure

REINFORCEMENT: High tensile wire helix embedded between layers of textile cords.

TUBE: Black nitrile rubber for maximum oil resistance.

TEMPERATURE: -35C to +93C (-30F to +200F)

NOM. ID"	NOM. OD"	VACUUM	PSI	BEND RADIUS"	STD PACK	WEIGHT#
2	2.62	29	300	5.00	100'	1.43
3	3.67	29	300	7.00	100'	2.20
4	4.71	29	300	10.00	100'	3.63
6	6.91	29	300	21.00	100'	6.90

PETROLEUM DISCHARGE



APPLICATION: For handling a wide range of petroleum products, including gasoline, as well as a number of chemical solutions.

COVER: Red, heat, oil and weather resistant Neoprene.

REINFORCEMENT: Multiple layers of synthetic textile cords, with static wire.

TUBE: Black, heat and oil resistant synthetic rubber.

TEMPERATURE: -35C to +88C (-30F to +190F)

NOM. ID"	NOM. OD"	PSI	STD PACK	WEIGHT#
1-1/4	1.69	150	100'	0.58
1-1/2	1.97	150	100'	0.78
3	3.50	150	100'	1.64
4	4.57	150	100'	2.46
6	6.72	150	100'	3.89

BLUE LAYFLAT ASSEMBLY

ASSEMBLY DESCRIPTION	WEIGHT#
1-1/2" X 50' BLUE LAYFLAT +C/E CAMLOCK	7.00
2"X50'BLUE LAYFLAT+C/E CAMLOCK	12.20
3"X50'BLUE LAYFLAT+C/E CAMLOCK	20.63
4"X50'BLUE LAYFLAT+C/E CAMLOCK	29.49
6"X50'BLUE LAYFLAT+C/E CAMLOCK	51.08



Petroleum, Chemical and Dry Bulk Dock Loading & Unloading Hose Assemblies

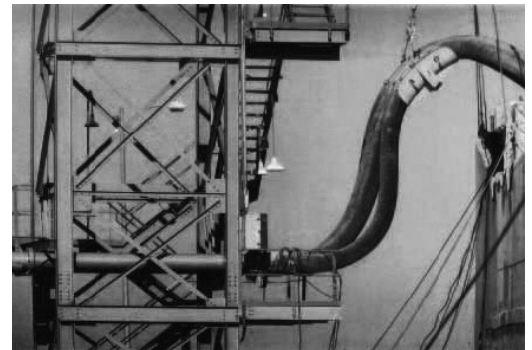
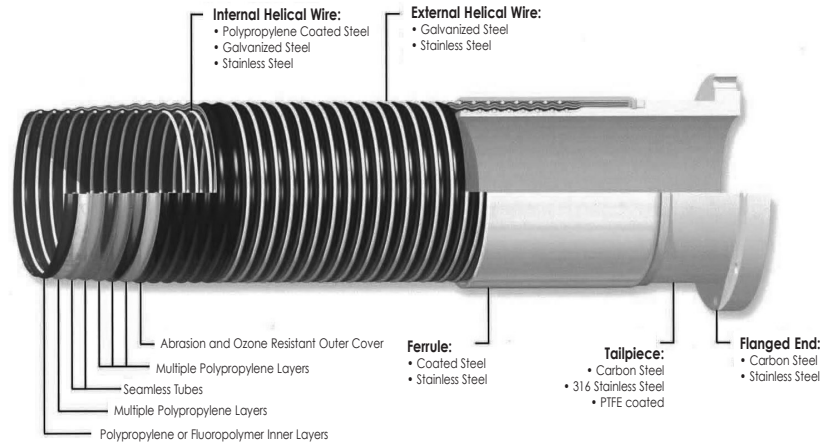

Dock Hose available in reinforced rubber construction, composite styles and all metal hose styles. Special constructions for lightering service available along with the new RFID “InfoChip” System for storing all pertinent data regarding hose history including date of manufacture, certification and all subsequent testing. Data is easily obtained via a hand held scanner

(sold separately) allowing simple transfer to a computer maintained database.

*RFID “InfoChip”
System*

Se habla español

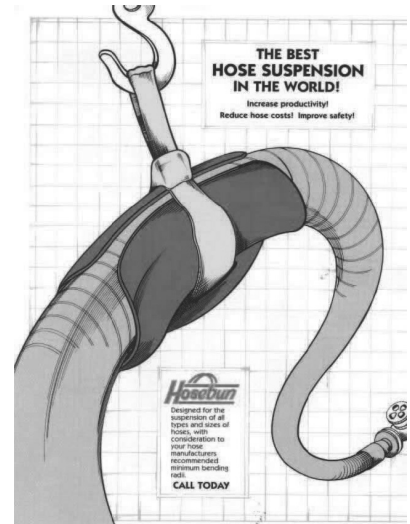
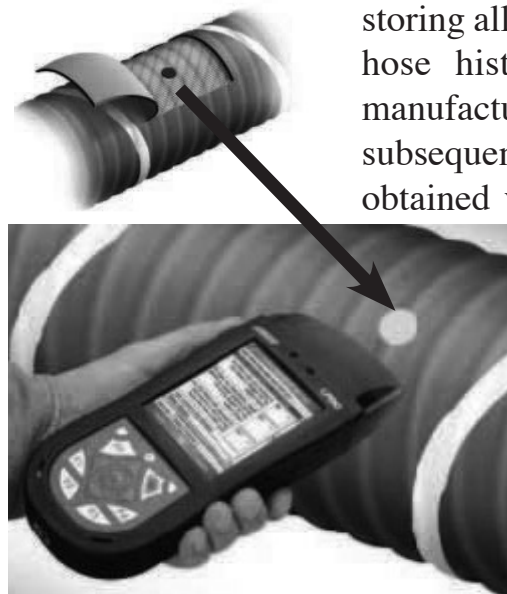

*Also available through
Goodyear Rubber Products
is the “Hosebun”
Hose Suspension System.*

SPECIALTY HOSES “GLOBALCORE”

GLOBALCORE™

The world's first high-performance, cohesive hose and fitting system.

ANY PRESSURE.
ANY PROJECT.
ONE SOLUTION.



ENGINEERING YOUR SUCCESS.



HIGH PERFORMANCE: With GlobalCore hoses tested to twice their ISO 18752 standard, high performance in rugged environments and high impulse applications is ensured.

COHESIVE: GlobalCore is a unified system that delivers hoses designed, engineered, and manufactured to the global specification, ISO 18752, which is based on performance and pressure requirements.

GLOBAL: GlobalCore hoses are manufactured in major regions of the world, supporting the equipment they serve, regardless of where it was originally manufactured, or where it is today.

SIMPLE: Select the GlobalCore hose based on the working pressure required for your application and one of two fitting series in a wide array of configurations.

COVER OPTIONS: STANDARD • TOUGH • SUPERTOUGH

187 HOSE

MEETING THE DEMANDS OF COMPLEX HYDRAULIC SYSTEMS AND HIGH PRESSURE RETURN LINES

Designed and engineered to ensure durability in continuously evolving higher pressure hydraulic systems, including rigorous mining applications, 187 Hose is unmatched in today's marketplace.

387 HOSE

DELIVERING VALUE AND PERFORMANCE FOR HIGH-PRESSURE APPLICATIONS

Lightweight and flexible, 387 Hose consistently delivers maximum performance and hose life across all sizes and markets using an efficient force-to-flex design.

487 HOSE

HIGHLY FLEXIBLE ACROSS ALL SIZES

Constructed for high performance and easy handling with low force-to-flex for ease of installation, 487 Hose excels in multiple applications around the world.

722 HOSE

RESILIENT 4-WIRE SPIRAL CONSTRUCTION

Engineered to ensure longer life in high-impulse, heavy-duty cycle applications, 722 Hose delivers maximum performance and efficiency.

787 HOSE

LIGHTER WEIGHT, HIGHER FLEXIBILITY, TIGHTER BEND RADIUS

With a compact spiral design offering greater advantages in routing and installation, 787 Hose delivers superior performance in a lightweight, low force-to-flex product.

797 HOSE

COMPACT DESIGN FOR TIGHTER ROUTING AND SPACE SAVINGS

Tested up to 2,000,000 cycles, 797 Hose provides enhanced chemical compatibility and service life with an easy-to-install compact spiral construction for high pressure, high impulse applications.

Visit parkerglobalcore.com

= HYDRAULIC “TOUGH COVER” RUBBER HOSE

FEATURES

- Synthetic rubber tube compatible with most petroleum-base hydraulic fluids; high-tensile steel wire reinforced; an oil-; weather-; and abrasion-resistant polymeric cover.
- No-Skive design eliminates the need to remove the cover before crimping.
- Available in Tough Cover & Super-Tough Cover meeting or exceeding 100Ri, 100R2, 100R12, 100R13 & 100R15 constructions.
- When you order any of Parker’s Tough Cover hoses, you get the finest hose plus the full support of Parker’s network of service centers, training programs, Proto typing, field representatives, and more.
- In short, you get the best value.



TOUGH COVER
SUPER TOUGH

CRIMPERS

The teeth in Parker’s all-steel crimping couplings bite down to the wire, for a metal to metal grip, just like factory-made assemblies.



The World Standard



PUT A BITE ON THE BRAID.

- No need to remove the hose cover.
- No skiving tools needed.
- Teeth grip the wire for maximum integrity.
- No gauge to set.
- No special training necessary

Unitized die-train keeps die segments together. No loose parts to mis-match. Dies are size-coded by color to eliminate confusion and save time during set-up. Parker’s exclusive Parkalign™ positions the fitting in the dies perfectly every time. The system handles bent-tube fittings with ease.

Eight-segment crimp dies provide a smooth, even, 360-degree crimp.

Our linked crimp dies keep die segments together. No loose parts to mismatch or misplace.

Dies are color coded by size for easy identification and reduced set-up time.

Bottom-loading operation makes it easy to handle long hose assemblies.

Parker’s exclusive Parkalign™ feature positions the fitting in the dies perfectly every time.

Technical Data Is Available On Both English & Spanish Websites

HYDRAULIC COUPLINGS

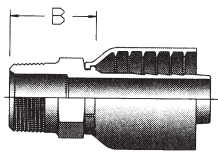

10143

Male NPTF Pipe

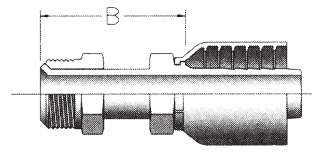

12843

SAE Male Inverted
45° Swivel Straight

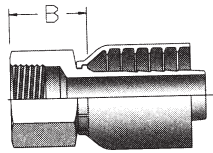

10243

Female NPTF Pipe

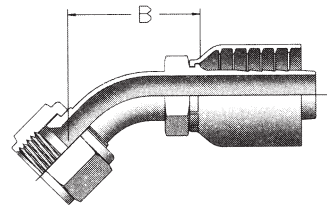

13743

Female JIC 37°
Swivel 45° Elbow

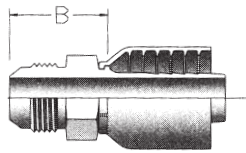

10343

Male JIC 37°

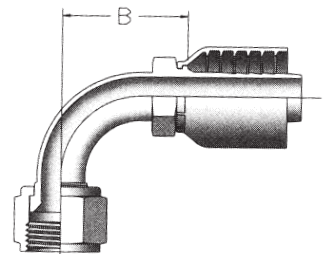

13943

Female JIC 37° Swivel
90° Elbow

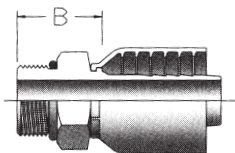

10543

Male O-Ring Straight
Thread

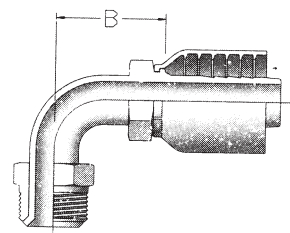

16943

SAE Male Inverted Flare
Swivel 90° Elbow

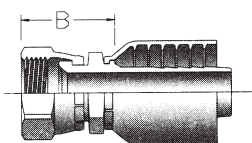

10643

Female JIC 37° Swivel

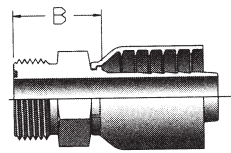

1JO43

Male Seal-Lok® straight
O-Ring Face Seal w/O-Ring

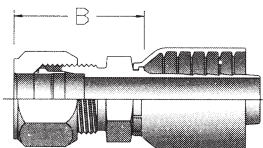

11143

Ferrul-Fix

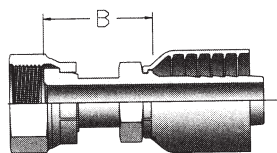

1JS43

Female Seal-Lok®
Swivel Straight (Long)
O-Ring Face Seal

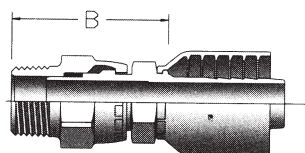

11343

Male NPTF Pipe
Swivel

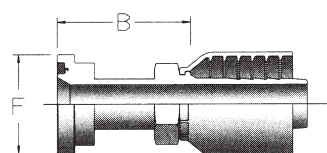

11543

SAE Code 61
Flange Straight

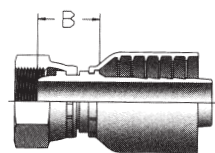

1C343

Female Metric Swivel - DIN
20078 Straight "Light" Series

Also Available in Split Flange, O-Ring Face Seal, Permanent and Reusable, Brass, Stainless Steel and Carbon Steel.

Metric Hose, Fittings, & Adapters Available

Also Available Complete Line of CRIMPERS, DIES, PUMPS, FOOT PEDALS, SAWS, BLADES, BRUSHES and SKIVERS.

THERMOPLASTIC TUBING



POLYETHYLENE

Flame-resistant tubing manufactured to meet the UL94V-2 flame classification. Preferred product for pneumatic control applications in the HVAC and energy conservation industry. **Products:** Series FRPE, Flame Resistant. **Sizes:** 5/32" to 1/2" O.D. **Working Pressures:** Up to 225 psi. **Color:** Black.



POLYPROPYLENE

Flexible tubing for higher temperatures and pressures. White PP Series meets FDA and NSF-51 requirements for food contact and potable water applications. Excellent resistance to hot water, corrosive acids, & stress cracking. **Products:** series PP, Laboratory Grade, Series PPB: Ultraviolet Light Resistant. **Sizes:** 1/8" to 5/8" O.D. **Working Pressure:** Up to 350 psi. **Colors:** Black, White.



NYLON

Flexible, abrasion-resistant tubing with heat and light stability for outdoor service. Highly resistant to chemicals and stress cracking. **Products:** Series N, Flexible. **Sizes:** 1/8" to 1/2", 4mm to 20mm O.D. **Working Pressures:** Up to 500 psi (26 bar). **Colors:** Black, blue, green, natural, red, yellow.

Ask Us About...

- Surgical Gum
- Silicone
- Beverage
- Teflon

TUBING



CLEAR VINYL

PVC tubing with exceptional purity, clarity and flexibility. Meets all FDA specifications for materials in contact with food and drugs for human consumption. **Products:** Clear Vinyl Tubing Formula V-1, Instrument and Laboratory Grade. **Sizes:** 1/8" to 1 3/4" O.D. **Working Pressure:** Up to 75 psi. **Color:** Clear.

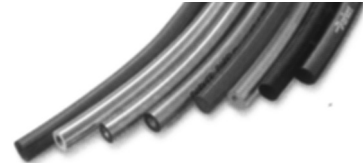

POLYURETHANE

Tough, flexible and kink-resistant tubing for use over a broad temperature range in a variety of critical applications. Low, medium and high durometer compounds available. **Products:** Series LU, U, HU, Polyether Base. **Sizes:** 1/8" to 3/4" O.D., 4mm to 12mm O.D. **Working Pressures:** Up to 125 psi (26 bar). **Colors:** Black, blue, clear, gray, green, orange, red, silver, and yellow.

THERMOPLASTIC TUBE FITTINGS



POLYPROPYLENE BALL VALVES

The corrosion-resistant, all-plastic design is ideal for water filtration units, coffee and beverage machines, and a wide variety of other fluid applications. FDA and NSF 51 approved for food contact and potable water. **Sizes:** 1/4" to 3/8". **Working Pressures:** 150 psi. **Materials:** White polypropylene. **O-Ring Materials:** Nitrile.



TRUESEAL™ FITTINGS

Push-to-connect installation on all types of plastic and soft metal tubing in a wide range of water purification and general industrial applications. Plastic or metal gripper collets available. **Sizes:** 1/4" to 1/2". **Working Pressures:** Up to 300 psi. **Materials:** Acetal, polypropylene, Kynar®. **O-Ring Materials:** Nitrile, EPDM, Viton.



FAST & TITE® FITTINGS

The most complete line of fittings for plastic, glass or metal tubing in low-pressure and vacuum systems. Hand-tight installation with positive tube retention and leak-proof seal. **Sizes:** 1/4" to 5/8". **Working Pressures:** Up to 300 psi. **Materials:** White or black polypropylene, white nylon. **O-Ring Materials:** Nitrile, EPDM, Viton.



PAR-BARB FITTINGS

Four-barb design for high gripping and sealing power. For softer tubing and hose in a wide range of applications. **Sizes:** 1/8" to 3/4". **Working Pressures:** up to 125 psi. **Materials:** Black polypropylene, white nylon.



MINI-BARB FITTINGS

Barb design allows easy, leak-free installation with soft tubing in fluid systems requiring miniature components. **Sizes:** 1/16" to 5/32" I.D. **Working Pressures:** Up to 125 psi. **Materials:** Polypropylene (natural), nylon (choice of colors). **Colors:** Black, blue, green, natural, red, white.

BRASS FITTINGS & VALVES

45° Flare Fittings

SPECIFICATIONS		NOMENCLATURE		PRESSURE RANGE		
BODIES & NUTS:	BRASS	EXAMPLE: 149F-6-4	ATTRIBUTE:	PSI	TUBE O.D. (IN.)	TUBE WALL (IN.)
O-RINGS:	FLUOROCARBON	1 (2)	FORGING (1) EXTRUSION (2)	2800	1/8	.030
TEMPERATURE RANGE:	FROM -65° TO +250° F	49	FLARE TO EXTERNAL PIPE, 90° ELBOW	1900	3/16	.030
OPERATING FLUID:	WATER, AIR, INERT AND NON-COMBUSTIBLE GASES, FLAMMABLE LIQUID, FREON,	F	FLARE FITTING	1400	1/4	.030
NOTE:	FOR OTHER TYPES OF FLUID OR GASES, PLEASE CONSULT FACTORY	6	3/8 TUBE O.D..	1200	5/16	.032
		4	1/4 PIPE THREAD	1000	3/8	.032
		APPLICABLE TUBE		750	1/2	.032
		TUBE MATERIAL:	COPPER, BRASS, ALUMINUM, WELDED STEEL HYDRAULIC TUBING THAT CAN BE FLARED.	650	5/8	.035
		TUBE O.D.:	1/8, 3/16, 1/4, 5/16, 3/8, 1/2, 5/8, 3/4, 7/8	550	3/4	.035



Hose Barb Fittings

SPECIFICATIONS		NOMENCLATURE	
FITTINGS:	BRASS	EXAMPLE: 125HBL-6-4	ATTRIBUTE:
O-RING:	FLUOROCARBON	125	HOSE BARB TO MALE PIPE
PRESSURE RANGE:	UP TO 150 PSI	HBL	HOSE BARB
TEMPERATURE RANGES:	-40° TO +160° F	6	3/8 HOSE I.D.
		4	1/4 NPTF/PTF
NOTE:	THESE FITTINGS ARE INTENDED FOR USE WITH 97HC HOSE CLAMPS, SIMILAR TYPE CLAMP OR A CRIMPED FERRULE.	APPLICABLE TUBE	
		TUBE MATERIAL:	RUBBER HOSE, GPH HOSE
		HOSE I.D.:	1/4, 5/16, 3/8, 1/2, 5/8, 3/4, 1



Pipe Fittings

SPECIFICATIONS		NOMENCLATURE	
PRESSURE RANGE:	UP TO 1,000 PSI	EXAMPLE: 2214P-2-2	ATTRIBUTE:
TEMPERATURE RANGES:	-65° TO +250° F	2	EXTRUSION
		1 (NOT SHOWN)	FORGING
		214	45° STREET ELBOW
		P	PIPE
		2	1/8" PIPE THREAD
		2	1/8" PIPE THREAD
		APPLICABLE TUBE	
		TUBE MATERIAL:	COPPER, BRASS, IRON PIPE
		THREAD SIZE:	1/8, 1/4, 3/8, 1/2, 3/4, 1



Thousand
more
variations
available

Access
Valves

Garden
Hose
Fittings

Metric
Adapters

Compress-
Align®
Fittings

If
You
Don't
See It...



Please
Ask,
We
probably
have
it,
OR
We
Can
Get It!

FORGED BRASS BALL VALVE



Full Port - IPS

- 600 WOG
- Teflon Seats and Seals
- Quality Forged Brass
- Eliminates Porosity
- Vinyl Grips
- Max. Temp 400°F @ 100PSI

STAINLESS STEEL BALL VALVES



Full Port IPS

- 3 Piece Investment Cast Body
- 316 S.S.
- 800 PSI WOG Non-Shock
- Teflon Seats/Seals
- S.S. Ball, Stem, Handle
- Vinyl Grips
- Max. Temperature 400°F @ 100 PSI
- 4 Bolt
- In Line Replacement



ONE & TWO WAY BRASS BALL VALVES

Standard valves adapted for specialized needs. Maximum operating temperature 180°. Maximum operating pressure 250° P.S.I. Buna-N seal. Teflon seat. Plated metal handle. Plated brass ball.

U.I. APPROVED ONE-WAY BRASS BALL VALVES

	MODEL	INLET	OUTLET
	025-4F4F-BT	1/4" FNPT	1/4" FNPT
	036-6F6F-BT	3/8" FNPT	3/8" FNPT
	025-4F2M-BT	1/4" FNPT	1/8" MNPT
	025-4F4M-BT	1/4" FNPT	1/4" MNPT
	025-4F4M-BT (Aluminum)	1/4" FNPT	1/4" MNPT
	036-6F4M-BT	3/8" FNPT	1/4" MNPT
	036-6F6M-BT	3/8" FNPT	3/8" MNPT
	025-6FL4M-BT	3/8" FLARE	1/4" MNPT

VALUELINE GATE VALVES



IPS & CxC 125 WSP/200 WOG

- Non-Rising Stem
- Cast Brass
- Heavy Duty Cast Iron Handle
- Individually Bagged

GATE VALVES W/DRAIN



Cast Brass 125 WSP - 200WOG

- IPS & CxC
- Non Rising Stem
- Heavy Duty Cast Iron Handles

QUICK OPENING GATE VALVES



150 WSP/300WOG Heavy Pattern Bronze (85-5-5-5) (B62 Alloy)

- Full Opening
- Spare Parts Available

GLOBE VALVES



Brass 125 WSP/200WOG IPS

- Hard Seat, Heavy Pattern, Large Opening

CHECK VALVES

"Y" Pattern Swing Check Valves Brass 125 WSP/200 WOG IPS



- Tight Sealing Soft Seat

SWING-CHECK VALVES



Brass 150 WSP/300 WOG IPS

- Meets Requirement of WW-V54-D (85-5-5-5) (B-62 Alloy)
- Tight Sealing Bronze Disc

GAS APPLIANCE VALVES

- Forged Brass Construction w/Locknut
- Internal Check
- Approved Lithium Grease
- Fully Tested



STOP VALVES



Brass IPS

- Quality Valves at Economy Prices
- Heavy Cast Iron Handles

BOILER DRAINS - HI FLOW MIP x Hose w/Stuffing Box



- Heavy Pattern Valve
- Cast Iron Handles
- 1/2" Fits CxC or IPS
- 65° Angle Spout

PLUG VALVES



HOSE BIBB

Rough Brass

- Standard Pattern, Tee Handle
- 1/2" fits CXC or MIP



"Ask us about our new private label line of Goodyear Rubber GOOD FLEX® hose and belting, superior quality products at a competitive price point"

GOOD FLEX™

SIX LOCATIONS TO SERVE YOU BETTER!

Technical Data Is Available On Both English & Spanish Websites

EXPANSION JOINTS & CONNECTORS

RUBBER, METAL, TEFLON &
FABRIC STYLES FOR PIPING, PUMPS, FANS,
BLOWERS AND DUCTING

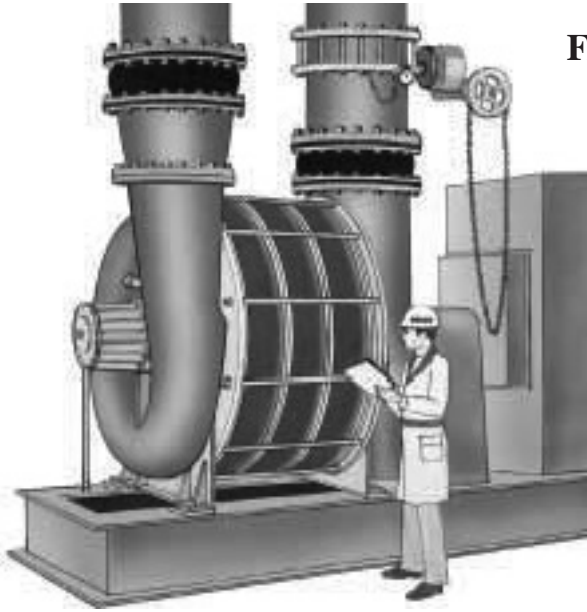

RUBBER SPOOL TYPE EXPANSION JOINTS,
SINGLE AND MULTIPLE ARCH.

Spool type **RUBBER** expansion joints, single and multiple arch style, filled and open arch for vacuum, pressure and high temperature. **METAL** expansion joints from stock and custom fabricated. **TEFLON** expansion joints for chemical service and vibration eliminators for pumps.

Metal expansion joints standard pipe flanged styles available from inventory, custom fabrications available -- built to your specifications!

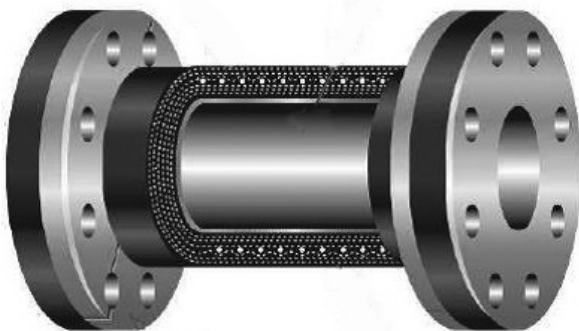

Rubber Pump Connectors
to reduce noise and
vibration in pipe lines.

Multiple
arch PTFE
joints

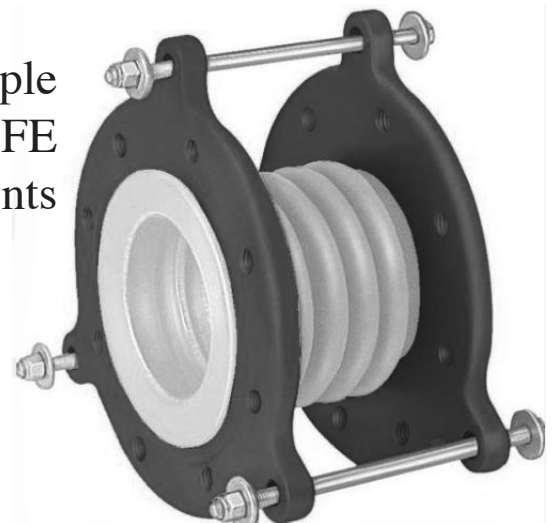

Se habla
español

All catalogs (well over 200) are available for free download in PDF format from our websites. Many are available in Spanish versions on the .lat site.

== METAL HOSE & EXPANSION JOINTS

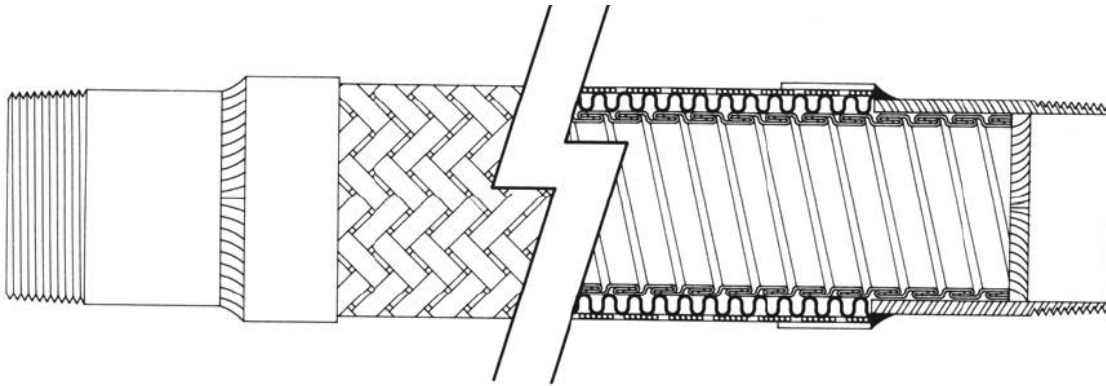

Goodyear Rubber Products is your **BEST** source for metal hose.

As a HoseMaster Metal hose Preferred Partner, Goodyear has the technical expertise and factory training to provide application engineering and troubleshooting for your toughest, most critical applications. HoseMaster's unique "Hydro-forming" process assures you of the most flexible hose on the market today. Whether your requirements for metal hose are for extreme pressure, steam traced assemblies for slow moving, high viscosity media or bulk commodities such as grain or pellets, Goodyear has the metal hose or expansion joint that will handle the application.



Goodyear has the technical expertise and factory training to provide application engineering and troubleshooting for your toughest, most critical applications.

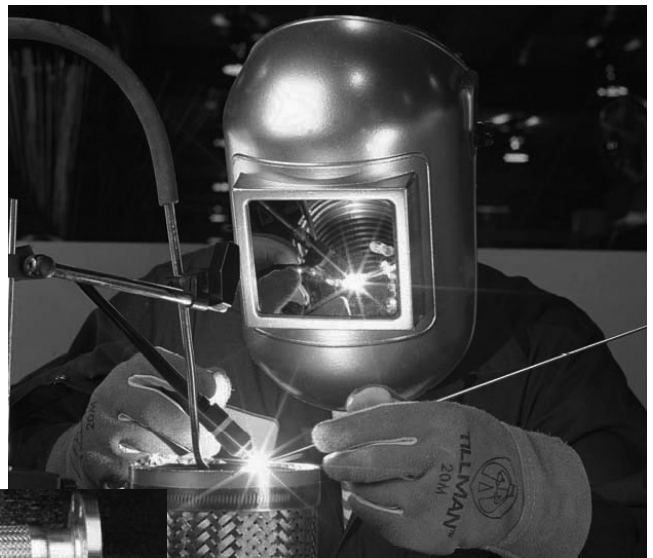

For our resale customers, we now offer **confidential blind shipping**, directly to your customer!! Packing slip shows products shipping from your company!! !!

We also supply High Temperature Fabric Flue Duct Expansion Joints, along with metal styles noted above.

INDUSTRIAL COUPLINGS



STANDARD SERRATED NIPPLE

SERVICE: Medium to high pressure air, water and liquid service.

SIZE RANGE: 1/4"x1".

DESCRIPTION: Machined steel and plated. NPT male threads. Thread or washer seal.

ATTACHMENT: Clamps or bands

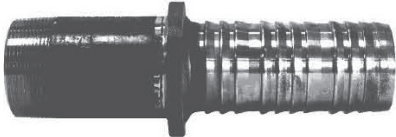

SWAGED OR CRIMPED

SERVICE: For use on all types of hose where high pressures are used such as LPG, aircraft fueling, air, etc.

SIZE RANGE: 1 1/4"x4".

DESCRIPTION: Couplings consist of swaged fittings having serrated steel shanks with ferrules of cadmium plated steel.

ATTACHMENT: Swaged equipment.

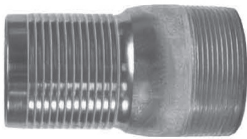

COMBINATION NIPPLE

SERVICE: Low to medium pressure suction and discharge of water, fluids and material handling.

SIZE RANGE: 1/2"x12".

DESCRIPTION: Tubular steel, stainless, malleable iron, aluminum or brass with serrated shank. NPT male threads, grooved or beveled for welding.

ATTACHMENT: Clamps or bands.



STEEL NIPPLE

SERVICE: Medium to high pressure. Wide variety of applications including air.

SIZE RANGE: 1/4"x1".

DESCRIPTION: Machined from cold drawn bar steel, heat-treated for toughness.

ATTACHMENT: Interlocking clamps.



SINGLE BOLT CLAMP

SERVICE: Low or medium pressure service on shank couplings, combination nipples and pipe nipples.

SIZE RANGE: 7/8" to 5 1/4" hose O.D.

DESCRIPTION: Cast malleable iron, cadmium plated.

ATTACHMENT: Bolted down tightly on hose.



DOUBLE BOLT CLAMP

SERVICE: Heavy duty applications with large sizes of combination nipples or couplings.

SIZE RANGE: 3 1/2" to 17 1/2" hose O.D.

DESCRIPTION: Cast malleable iron, cadmium plated and brass.

ATTACHMENT: Applied over hose and bolted into position.



BAND CLAMP

SERVICE: Low or medium pressure service air, water and suction service.

SIZE RANGE: 3/4" to 6" hose O.D.

DESCRIPTION: Pre-formed flat stainless steel, high carbon steel.

ATTACHMENT: Special locking band tool.

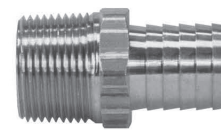

BRASS BARBED INSERTS

SERVICE: Low or medium pressure air, water and fluids.

SIZE RANGE: 3/16"x1".

DESCRIPTION: Machined brass with serrated shank. NPT or NPTF male and solid female, and NSPM swivel female. Thread seal to NPT or NPTF female, and ball end or washer seal to NSPM female.

ATTACHMENT: Bands or clamps.



BRASS FERRULE

SERVICE: Low or medium pressure air or water using general purpose hose and brass inserts.

SIZE RANGE: 29/64" to 1 1/2" hose O.D.

DESCRIPTION: Made from various gauge brass tubing. Stamped with Standard Industrial Part Number.

ATTACHMENT: Crimped on using either ribbed or plain die.

**IF YOU CAN'T
FIND IT...
We Can Get
It For You!**

INDUSTRIAL COUPLINGS



SHORT SHANK

SERVICE: Low pressure air and water service.
SIZE RANGE: 3/16" x 1".
DESCRIPTION: Machined brass with serrated shank. GHT, NPSM or NPT male and NPSH female. Washer seal.
ATTACHMENT: Clamps or bands.



LONG SHANK

SERVICE: Medium pressure air, sanitary and liquids in suction or discharge service.
SIZE RANGE: 1/4" x 3".
DESCRIPTION: Malleable iron, stainless steel, steel or machined brass construction. NPT male and NPSM female or GHT threads. Washer seal.
ATTACHMENT: Two bands or clamps.



GROUND JOINT OR WASHER SEAL

SERVICE: High pressure air and water service, steam, high pressure spray, LPG and anhydrous ammonia service.
SIZE RANGE: 1/4" to 6".
DESCRIPTION: Cadmium plated malleable iron. Insert and spud may be either steel or malleable iron. NPT male and female with ground joint or washer seal.
ATTACHMENT: Four bolts or two bolts interlocking clamps.

"Ask us about our new private label line of Goodyear Rubber GOOD FLEX® hose and belting, superior quality products at a competitive price point"



Visit our website at
www.goodflex.us
 for more information on our GOOD FLEX® Products!

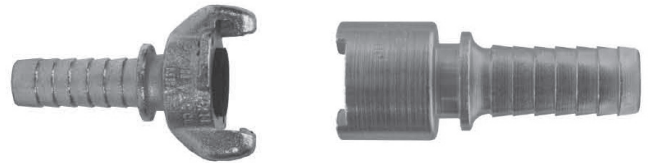

QUICK ACTING

SERVICE: Low or medium pressure. Air, water or oil service where frequent and fast connections must be made.
SIZE RANGE: 1/4" x 2".
DESCRIPTION: Malleable iron cadmium plated, stainless steel or bronze.
ATTACHMENT: Interlocking clamps or bands.



WATER SUCTION

SERVICE: Heavy duty water discharge and suction service.
SIZE RANGE: 1" to 8".
DESCRIPTION: Malleable iron, aluminum or brass.
ATTACHMENT: Clamps or bands.



INTERLOCKING CLAMPS

SERVICE: Heavy duty high pressure applications such as air, steam, water, spray, LPG and anhydrous ammonia hose.
SIZE RANGE: 9/16" to 7 3/16".
DESCRIPTION: Malleable iron, cadmium plated.
ATTACHMENT: Clamps bolted into position.



CAM AND GROOVE

SERVICE: Low and medium pressure water, petroleum and chemical transfer where fast connections are needed. Also used for suction service.
SIZE RANGE: 1/2" to 8".
DESCRIPTION: Aluminum, bronze, stainless steel, Monel, malleable iron. Washer seal with no threads.
ATTACHMENT: Clamps or bands.

COUPLINGS & FITTINGS

GROUND JOINTS

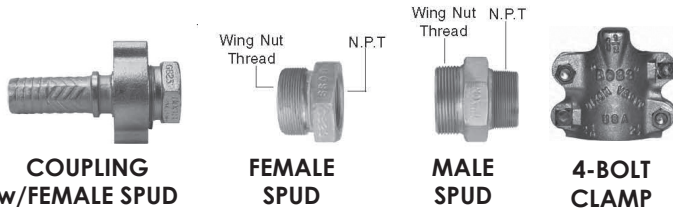

AVAILABLE: 1/4" to 6" and in Malleable Iron, Stainless Steel and Brass.

UNIVERSAL COUPLINGS

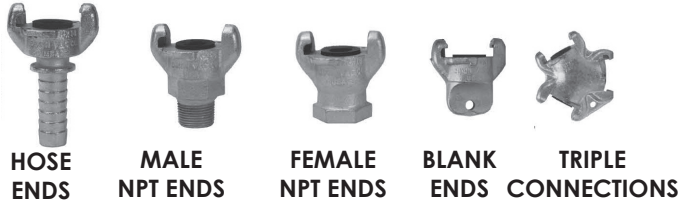

AVAILABLE: 1/4" to 1" and in Malleable Iron, Stainless Steel and Brass.

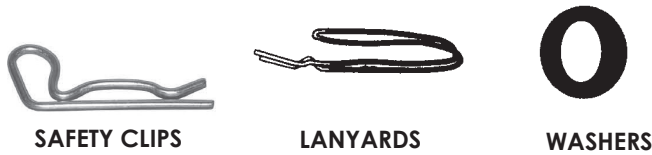

CLAMPS

AVAILABLE: 3/8" to 1" in Plated Malleable Iron.



SAND BLAST COUPLINGS



AVAILABLE: 3/4" to 1 1/2" in Brass or Aluminum.

DUAL LOCK QUICK-ACTING COUPLINGS



AVAILABLE: 3/8" to 1" in Black Oxide Finish - Steel Construction.

CAM & GROOVE COUPLINGS

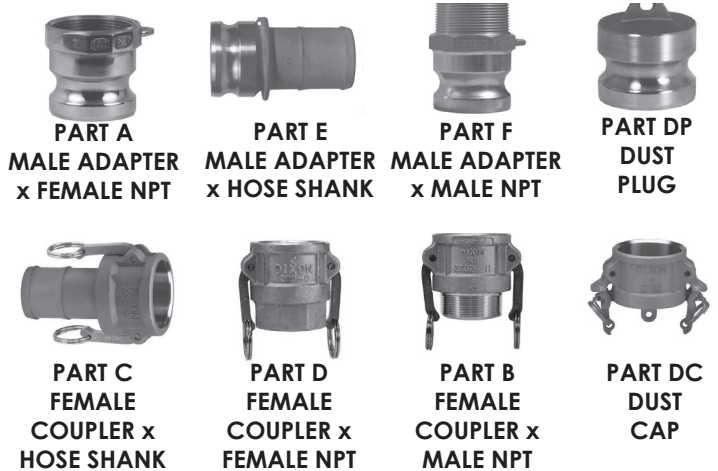

AVAILABLE: 1 1/2" to 8" in Aluminum, Brass, Plated Malleable Iron, Stainless Steel and Polypropylene.

ELBOWS - CAM & GROOVE STYLE

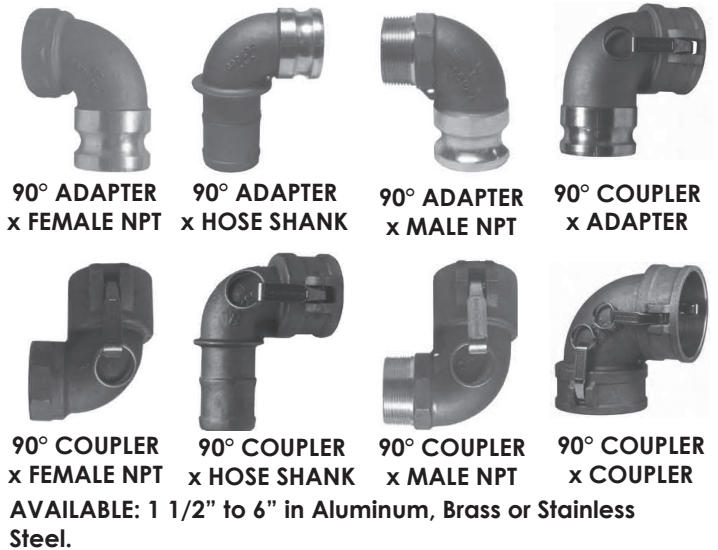

AVAILABLE: 1 1/2" to 6" in Aluminum, Brass or Stainless Steel.

NEW PRODUCT LINE
Petroleum and Dry Bulk
Fittings & Accessories

CAM & GROOVE REDUCING PARTS ON NEXT PAGE!

COUPLINGS & FITTINGS

CAM AND GROOVE REDUCING PARTS

→ COUPLER



SIZE IN INCHES	
1 x 1 1/2	3 x 2
1 1/2 x 1	3 x 4
1 1/2 x 2	4 x 2
2 x 1 1/2	4 x 2 1/2
2 x 3	4 x 3
2 x 4	4 x 5
3 x 1 1/2	6 x 4

→ ADAPTER
REDUCING
COUPLER x ADAPTER

AVAILABLE: Aluminum, Brass, Malleable Iron and Stainless Steel.

SPOOL ADAPTER



AVAILABLE: Aluminum, Brass, Malleable Iron and Stainless Steel.

SIZE IN INCHES	
1	3
1 1/4	3 x 4
1 1/2	4
1 1/2 x 2	4 x 6
2	6
2 x 3	-

ADAPTER x 150# ASA FLANGE DRILLING



AVAILABLE: Aluminum, Malleable Iron and Stainless Steel.

SIZE IN INCHES	
1	3
1 1/2	4
2	6

REDUCING
ADAPTER x FEMALE NPT



AVAILABLE: Aluminum, Brass, and Stainless Steel.

SIZE IN INCHES	
2 x 3	4 x 3
3 x 2	4 x 6
3 x 4	6 x 4

REDUCING
COUPLER x FEMALE NPT



AVAILABLE: Aluminum, Brass, and Stainless Steel.

SIZE IN INCHES	
1 1/2 x 1	3 x 2
2 x 1 1/2	4 x 3

REDUCING
ADAPTER x HOSE SHANK



AVAILABLE: Aluminum and Stainless Steel.

SIZE IN INCHES
4 x 3

REDUCING
COUPLER x HOSE SHANK



AVAILABLE: Aluminum and Stainless Steel.

SIZE IN INCHES
3 x 2
3 x 4
4 x 3

COUPLER x 150# ASA
FLANGE DRILLING



AVAILABLE: Aluminum and Stainless Steel.

SIZE IN INCHES	
1	3
1 1/2	4
2	6

ADAPTER x ROUND TANK
TRUCK FLANGE



AVAILABLE: Aluminum.

SIZE IN INCHES	
3	4
3 x 4	6

COUPLER x ROUND TANK
TRUCK FLANGE



AVAILABLE: Aluminum.

SIZE IN INCHES	
3	4
3 x 4	6

STANDARD
HANDLE ASSEMBLIES



AVAILABLE: Brass and Stainless Steel.

SIZE IN INCHES	
1/2	3 thru 5
3/4	6
1	8
1 1/4 thru 2 1/2	-

REDUCING
ADAPTER x MALE NPT



AVAILABLE: Aluminum and Stainless Steel.

SIZE IN INCHES	
3 x 1 1/2	3 x 4
3 x 2	4 x 3

REDUCING
COUPLER x MALE NPT



AVAILABLE: Aluminum and Stainless Steel.

SIZE IN INCHES
1 1/2 x 1
2 x 1 1/2
3 x 2
3 x 4
4 x 3

CAM AND GROOVE GASKETS



AVAILABLE: 1/2" to 8" in Buna-A, Viton-A, Extra Thick Buna-A, Teflon Buna Filler, Teflon Viton Filler, Teflon Accordion*, Teflon Encapsulated Silicone, Teflon Encapsulated Viton, Ethylene Propylene, Neoprene, White Food Grade Neoprene and Silicone.
• Recommended for viscous fluids only

FUEL TANKER PRODUCTS

Petroleum Tanker Products

Bayco™ and FloTech™ brand products are engineered for dependable, long service life and designed for easy, low cost maintenance. Where possible, modular systems are incorporated with common parts to minimize inventory of repair items.



Gravity Drop Adapters



Description	Fuel Compatibility
4" API to 3" drop adapter with Buna-N flat gasket	Gasoline and diesel, up to E100 and B100 biofuels
4" API to 4" drop adapter with Buna-N flat gasket	
17" heavy duty chain	

Safety Vapor Vents

Tank Vapor Vents

Tube Doors



Vapor Hose Couplers

Grounding Studs

Elbow Extension Kits

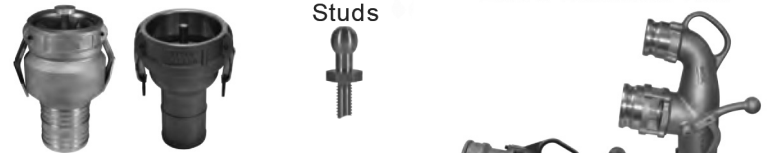

Single Point Vapor Recovery/
Fuel Drop Co-Axial Elbow

(vapor outlet)

(fuel inlet)



Dust Caps & Plugs with
Handles for Hose Tubes



Vapor
Adapter



Vapor Elbows



Vapor Caps



API Valve Caps



Aluminum TTMA Flanges, Flange Gaskets,
Flange Adapters



FloTech™ Overfill Detection

Sensors

Monitors

Drop Hose Fittings



Ground Bolt



Locking Fill Caps



Drop Elbows



API Valves



Sight Glass



Sockets

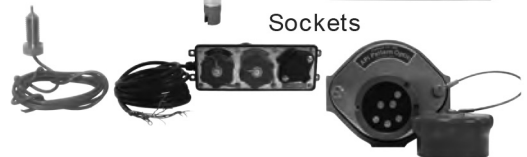

Drop Adapters



Load Only



Dust Caps



Top Seal Adapters



Air Interlocks



COUPLINGS & FITTINGS

SHANK TYPE FITTINGS



STEEL HOSE MENDER
AVAILABLE: 1/4" to 12"
in Zinc Plated Steel and
Stainless Steel.



BRASS HOSE MENDER
AVAILABLE: 3/16" to 1".



**PLATED STEEL
JUMP SIZES
HOSE SHANK x MALE NPT**
AVAILABLE: 3/4" to 4" Hose
Shank, 1" to 3" Male NPT.

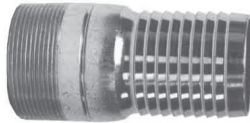

**PLATED STEEL
for PLASTIC PIPE
MALE NPT**
AVAILABLE: 1/2" to 6".

COMBINATION NIPPLES
AVAILABLE: 1/2" to 12" in
Unplated Steel, Plated Steel,
Stainless Steel, Brass and Alumi-
num NPT Ends.

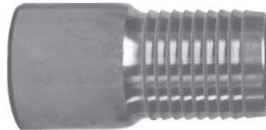

SUCTION COUPLINGS (NPSM THREAD)



**COMPLETE
COUPLING**



FEMALE



MALE
All 3" to 6" males
have pin lugs.

AVAILABLE: 1" to 8" in Aluminum,, Brass and Malleable Iron.

SPANNER WRENCHES



AVAILABLE: 1 1/2", 2", 2
1/2", 3" and 1 1/2", 2"x2
1/2" and 3" Double End
Combination.

WASHERS FOR SUCTION



RUBBER
AVAILABLE:
1/2" x 8"



NEOPRENE
AVAILABLE:
3/4" x 8"



LEATHER
AVAILABLE:
3/4" x 4"

FOOT VALVES



**STRAINER
ONLY
-PAINTED-**



**FLAPPER
VALVE
ASSEMBLY**



**COMPLETE
ASSEMBLY
- PAINTED-**



**VALVE
LEATHER**



**SEAT
PLATE**

AVAILABLE: 1 1/2" to 12".

Se habla español

STRAINERS AND SKIMMERS



**STANDARD
THREADED
ROUND HOLE
TYPE**



**304 STAINLESS
STEEL
ROUND HOLE
TYPE**



**STANDARD
THREADED
SQUARE HOLE
TYPE**



**LONG THIN
ROUND HOLE
TYPE**



**SKIMMER BOTTOM
ROUND HOLE
TYPE**



**SKIMMER TOP
ROUND HOLE
TYPE**

AVAILABLE: 1 1/2" to 12".

ZINC PLATED STEEL NIPPLES



MALE NPT x HOSE SHANK



FEMALE NPT x HOSE SHANK

HOSE SIZE	NPT SIZE	HOSE SIZE	NPT SIZE
1/4	1/8	1/2	1/2
1/4	1/4	1/2	3/4
3/8	3/8	3/4	1/2
3/8	1/4	3/4	3/4
3/8	3/8	3/4	1
1/2	1/2	1	3/4
1/2	1/4	1	1
	3/8		

HOSE SIZE	NPT SIZE	HOSE SIZE	NPT SIZE
1/4	1/4	1/2	3/8
3/8	1/4	1/2	1/2
3/8	3/8	3/4	3/4

WE EXTERNALLY CRIMP & INTERNALLY EXPAND COUPLINGS ON INDUSTRIAL HOSES!

COUPLINGS & FITTINGS

LONG SHANK COUPLINGS



FEMALE COUPLING
(NPSM THREAD)



MALE
(NPT THREAD)

AVAILABLE: 1 1/4" to 4" in Brass, Malleable Iron and Stainless Steel

BRASS FERRULE CRIMPING TOOL

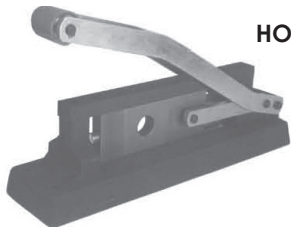

HOSE CRIMPER



855A Hose Crimper provides "Big Tool" crimping advantages at a fraction of the cost. Rugged, portable and easy to use. Standard dies for 855A tools.



HOT WATER WASHDOWN SPRAY GUN

AVAILABLE: Brass or Aluminum.

SWIVEL CONNECTORS FOR HOT WATER WASHDOWN SPRAY GUN



HOSE SHANK



GHT THREAD

AVAILABLE: Brass Swivel Body with Stainless Steel Hose Shank and Brass Connecting Nut.

NPT	HOSE I.D.
1/2	1/2"
1/2	3/4"
1/2	3/4" FGHT

GARDEN HOSE FITTINGS AND ACCESSORIES



INSULATED WATER NOZZLES



THERMO-PLASTIC
FIRE HOSE NOZZLE
WITH BUMPER



SOLID BRASS HOSE NOZZLES

BRASS SHORT SHANK FITTINGS (NPSM THREAD)



COMPLETE



FEMALE



MALE

AVAILABLE: 3/8" to 1".

BRASS GHT ADAPTERS



FEMALE SWIVEL
(GHTxGHT)



MALE GHT x FEMALE
NPT



THREADED
MALE
(GHTxGHT)

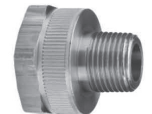

FEMALE GHT x MALE
NPT



FEMALE SWIVEL
(GHTxNPT)



RIGID FEMALE
(GHTxNPT)



THREADED
MALE
(GHTxNPT)



GARDEN HOSE CAPS
(FEMALE GHT)

BRASS PUSH-ON FITTINGS



NPTF - MALE
HOSE BARB



NPTF - FEMALE
SWIVEL HOSE
BARB (BALL SEAT)

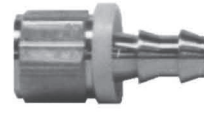

NPTF - FEMALE
HOSE BARB



HOSE MENDER

AVAILABLE: 1/4" to 3/4".

BRASS ADAPTERS



HEX NIPPLE



REDUCER
HEX NIPPLE



HEX
BUSHING



COUPLING



REDUCER
COUPLING



REDUCER
ADAPTER

6 LOCATIONS TO SERVE YOU

COUPLINGS & FITTINGS

ALL POLYESTER FIRE HOSE



AVAILABLE 1-1/2" to 2-1/2", 50' & 100' coupled with NST (NH) or NPSH Brass or Alum fittings. Available in Rocker Lug and Pin Lug style couplings. 300 and 500# Single Jacket and 800# Double Jacket. White or color impregnated available.

BRASS HYDRANT ADAPTERS

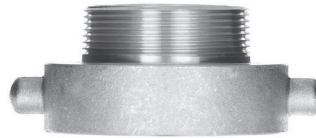

UNIVERSAL SPANNER WRENCH FOR PIN LUG AND ROCKER LUG COUPLINGS



MILL HOSE

AVAILABLE 1-1/2" to 2-1/2", 50' & 100. Available in Single Jacket and Double Jacket. Used in open end water discharge, not intended for firefighting service.



ACCESSORIES AVAILABLE:
VALVES, REELS, HYDRANT ADAPTERS, NIPPLES, WRENCHES, ADAPTERS AND NOZZLES.

RING AND FULL FACED GASKETS

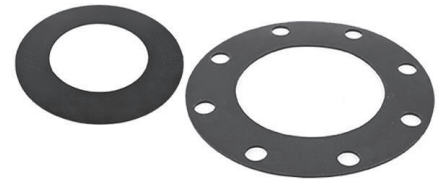

FORGED AND STAINLESS STEEL FLANGES



SLIP-ON

AVAILABLE:
1 1/2" to 12".



NPT THREADED

AVAILABLE:
1 1/2" to 12".



LAP JOINT

AVAILABLE:
1 1/2" to 12".

Standard pipe flange gaskets available from stock in red rubber and compressed fiber, ring and full face styles, in 1/16 and 1/8 thickness, other materials available custom cut.

TIRE INFLATOR CHUCK



BALL FOOT CHUCK. For direct connection to live air only. Features a built-in shutoff valve (will not work on inflator gauges). Solid Brass. 1/4" NPT female thread. Maximum pressure is 300 PSI.

IF YOU DON'T SEE WHAT YOU WANT...

Call Customer Service For Help!

75+ YEARS SERVING THE INDUSTRY!

NEW PRODUCT LINE



FILTERS, REGULATORS AND LUBRICATORS

AVAILABLE IN VARIOUS SIZES, MATERIALS AND CONFIGURATIONS.

"Ask us about our new private label line of Goodyear Rubber GOOD FLEX® hose and belting, superior quality products at a competitive price point"



Visit our website at

www.goodflex.us

for more information on our GOOD FLEX® Products!

GAUGES

AVAILABLE IN STEEL, BRASS ABS AND STAINLESS STEEL. DRY OR LIQUID FILLED CENTER BACK OR LOWER MOUNT.



Vacuum, Pressure & Combination styles available in-stock!

COUPLINGS & FITTINGS

BRASS BARB HOSE FITTINGS



**MALE
INSERTS**



**SOLID FEMALE
INSERTS**

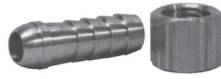

**FEMALE BALL
END SWIVEL**

AVAILABLE: 1/8" to 1".

BRASS FERRULES



AVAILABLE
FOR
ALL HOSE
SIZES

HOSE CUTTERS



STAINLESS STEEL T-BOLT CLAMPS



Designed to assure proper coupling retention for large ID marine exhaust hose. T-Bolt Band Clamps offer a 360° clamping surface, and are ideal for any below-waterline application. All clamps are 316 stainless steel with 1/4" hardware. 3/4" band spreads the clamping force evenly around hose. Nylon insert nut for security. Extra long bolt fits wide range of sizes.

**We stock
1-1/4" ID to
12.9" ID sizes**

STAINLESS STEEL GEAR CLAMPS



AVAILABLE: 7/16" to 20".

CENTER PUNCH AND UNIVERSAL CENTER PUNCH BANDING CLAMPS



AVAILABLE: 3/8" to 5/8"
widths and from 3/16" to 8"
I.D. in Galvanized Steel or
Stainless Steel.

CLAMPING BANDS AND BUCKLES



BUCKLES

AVAILABLE: 3/8" to 3/4".

BANDING TOOLS AND ACCESSORIES



**HAND HELD TOOL
FOR SEVERING OF
BANDING CLAMPS**



**HAND HELD
LOCKING TOOL**



CLAMP CUTTER



HAND TOOL

DOUBLE BOLT CLAMP

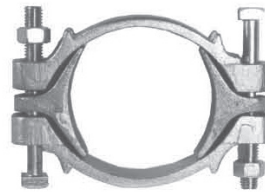

AVAILABLE: From Hose
O.D. 1 1/8" to 17 1/2"
in Malleable Iron.

INDUSTRIAL QUICK-CONNECT FITTINGS AND ACCESSORIES

PLUGS



MALE NPT



FEMALE NPT



HOSE SHANK



PUSH-ON HOSE BARB

COUPLERS

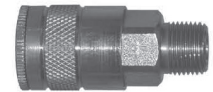

MALE NPT

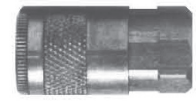

FEMALE NPT



HOSE SHANK



PUSH-ON HOSE BARB

AVAILABLE: 1/4", 3/8" and 1/2" in Steel or Brass. Also available in Industrial, Automotive, ARO and Lincoln.

HYDRAULIC & PNEUMATIC QUICK COUPLINGS

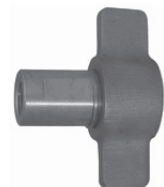

END GREASING FRUSTRATION

- Won't leak or pop off under pressure. **GUARANTEED.**
- The world's only rebuildable grease coupler
- Works on all Zerk fittings, SAE and metric

Additional Features

- Two sizes available
- Rated up to 10,000 PSI
- Easily disconnects, even under pressure. No more broken Zerks.
- 1/8" NPT compatible with all grease guns, battery, pneumatic, manual
- Works on all Zerk fittings, SAE, & metric
- **FREE Coupler Rebuild Kit included with every coupler**

LOCK N LUBE GREASE COUPLER



Locks on, stays on. No hands are needed to hold or align the coupler. You have both hands free to use your grease gun and know that grease is going in, not on, the machine.

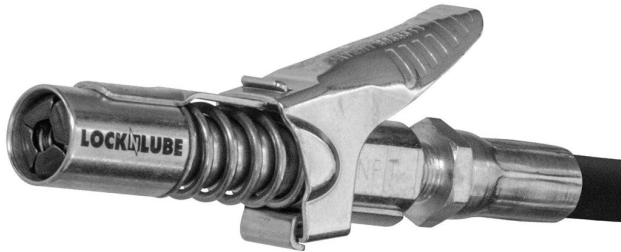

Stuck-on couplers are a thing of the past. Just push down the thumb lever on your LockNLube Grease Coupler, and it comes right off, even recessed fittings.

The LockNLube Grease Coupler comes in two sizes, Regular and XL. Both have a barrel that is just 1mm wider than standard four-jaw couplers. The XL version is two inches longer, giving you extra reach for deeply recessed fittings.

We offer full line of lubrication pumps, grease fittings, adaptors, hoses, lube guns, and more.

LOCK N FLATE AIR CHUCK

AIR CHUCK

*Depress the thumb lever and push on the tire valve.
Release the lever to secure the air chuck and
create a leak-free connection.*

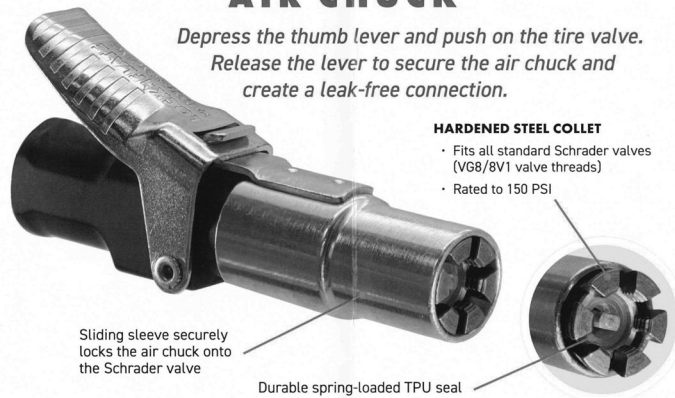

Locks On Stays On Won't Leak! "Finally a locking chuck that works"

Like no other air chuck on the market the LockNFlate's six steel jaws lock on any Schrader valve to create a secure, hands-free connection. The heavy-duty construction is built to last and stand up to everyday use in even the busiest tire shops, service bays and garages.

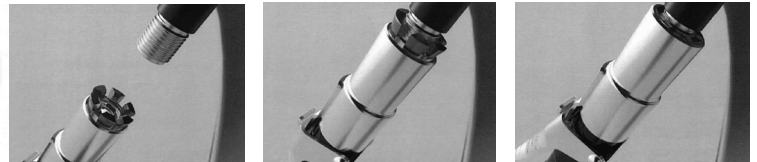

AVAILABLE IN 2 STYLES:

Closed Flow: For use directly from a compressor or airline. Must engage valve to open the seal. Works with all systems except for computerized commercial grade systems.

Open Flow: Allows air to flow through freely without engaging the valve system. For use with systems that have hand/foot controlled valves such as in-line gauges with a trigger or automatic tire inflators.



LUBRICATION EQUIPMENT

SAMSON
AUTHORIZED DISTRIBUTOR



We offer full line of lubrication pumps, grease fittings, adaptors, hoses, lube guns, and more.



We Carry
Accessories

About Our Clamps (3 Piece Design)

ONE-PIECE HOUSING

One piece mechanically interlocked housings are made from a single stamping with no tabs or stakes that can fail under higher tightening torques



MULTIPLE BAND WIDTHS

Our three piece clamps are produced in a multitude of band widths in a large variety of sizes, traditionally sized in increments of 1/16"

RECTANGULAR SHAPED NOTCHES

The rectangular notch design utilizes a radius at each corner which minimizes stress cracking under higher band loads and enhances the overall strength of the band

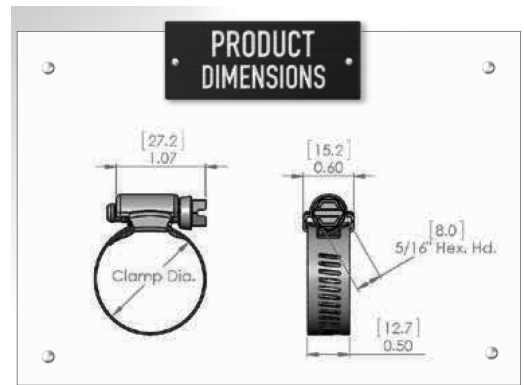

SmartSeal Ideal-Tridon 37215

5/16" Hex Head	Housing	1/2" Band	1/2" Spring Liner
300 Stainless	300 Stainless	300 Stainless	300 Stainless

WaveSeal³⁶⁰ Ideal-Tridon 36003

5/16" Hex Head	Housing	9/16" Band	9/16" Spring Liner
410 Stainless	300 Stainless	300 Stainless	300 Stainless

SmartSeal HD Ideal-Tridon 38215

5/16" Hex Head	2-Piece Housing	5/8" Band	5/8" Spring Liner
410 Stainless	300 Stainless	300 Stainless	300 Stainless

Snaplock Ideal-Tridon 56-0

5/16" Hex Head	Bridge	9/16" Band Width
Plated Carbon Steel	Plated Carbon Steel	200 Stainless

Snaplock Ideal-Tridon 500 • Tridon 500/LS

5/16" Hex Head	Bridge	1/2" Band Width
Plated Carbon Steel	410 Stainless	200 Stainless

WIDE CROSS SADDLE

Wide cross saddle provides a more even support structure upon installation and longer term band tension.



MEETS OR EXCEEDS
DIN 3017 STANDARD

SMOOTH INSIDE BAND

Smooth inside band protects soft hoses against shearing and fray, extending service life.

MATERIAL SPECIFICATIONS AND CLAMPING RANGES

Material specifications and clamping ranges are stamped on clamp band for easy identification and proper application fitment. (See chart on right)

THE SMARTSEAL CHANNEL DESIGN

High Pressure

- Spring compensation over 360 degrees
- Improved clamp roundness eliminates leak paths at housing juncture
- Trough-shaped design creates higher pressure loading compared to conventional worm gear, increasing resistance against potential leaks
- Trough shape helps clamp "grip" by penetrating deeper into the hose wall over a narrower cross-section (footprint)

THE WAVESEAL O-RING EFFECT

High Pressure Low Pressure High Pressure

- Spring compensation over 360 degrees
- Improved clamp roundness eliminates leak paths at housing juncture
- O-ring effect allows hose to act as an additional spring component
- Outside, chamfered liner edge protects hose component from cutting

SmartSeal and WaveSeal360 hybrid smart clamps secure hose connections and prevent unwanted flow of fluid and air. Through patented hybrid technology, these next generation clamps seal in a steady 360 degree pattern in response to pressure and temperature changes. With their compact design and lower profile, you get an optimal heavy-duty constant tension clamp without all the bulk.

Snaplock Quick Release worm drive clamps are good for closed system applications where the clamp must be disengaged to be applied. The swivel-action locking of screw to band makes installation and removal much faster. All Snaplock housings are 200 stainless steel.

Non-Perforated (Embossed) clamps are based on our popular general purpose worm gear clamps, but are engineered to prevent hose damage during installation. The non-perforated band keeps soft silicone hoses from shearing or extruding during installation and final torquing, maintaining the integrity of the connection, and providing a more stable seal. Plus, IDEAL-TRIDON Non-Perforated clamps are available in several material configurations making them perfect for automotive, marine and many industrial applications. Better yet, they act and perform just like traditional worm gear clamps, fitting into restricted spaces and holding tightly over time.

CENTER PUNCH™ TOOLS

These ratchet action tensioning tools are for applying Center Punch and Center Punch Open-End clamps with a center punch lock. Type 201 stainless steel or galvanized carbon steel clamps are tensioned, then locked by striking tool punch with mallet or hammer.

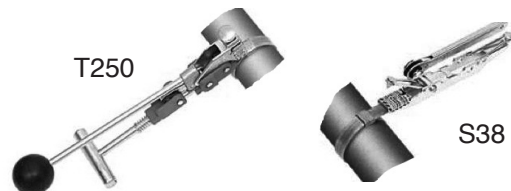

CLAMPS

CENTER PUNCH™ CLAMPS

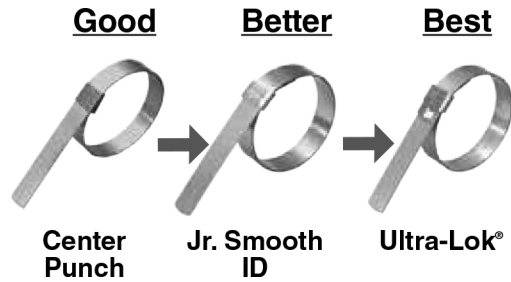

COMMONLY USED HOSE APPLICATIONS:

- Air/Multi-Purpose
- Food Handling
- Lay Flat
- Petroleum Drop, Vapor, Discharge and Suction
- Water - General Purpose, Suction, Discharge

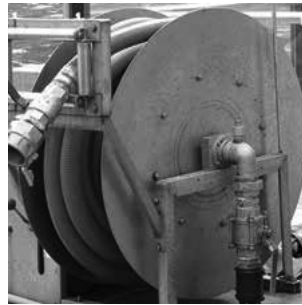

Good Center Punch	Better Junior Smooth ID	Best Ultra-Lok®
Preformed Clamps		
2 Material choices	3 Material choices	201 1/4 hard stainless steel
Locks using conical punch	Vibration resistant lip wrap lock	Superior vibration resistance, locks under full tension
Manufactured with stainless steel buckles to provide greater locking strength	Smooth ID design reduces leak path	Smooth ID design reduces leak path
Sizes from 13/16" to 8" available	Sizes from 13/16" to 8" available	Patented lock design, sizes from 1 1/2" to 9" available, longer length open end clamps also available
Applied with choice of 2 hand tools, or one air production tool	Applied with a choice of 1 hand tool, or 2 air production tools	Applied with portable battery powered tool

ULTRA-LOK® CLAMPING SYSTEM



PREFORMED CLAMPING SYSTEMS

Designed for quick installation, highest clamping force and gap-free inside diameter. The best choice for demanding applications!

We Externally Crimp & Internally Expand Couplings On Industrial Hoses!

- Strongest band clamping system available
- Double wrapped 201SS for superior strength
- Unique lock formed under full tension maximizes tightness
- Thicker buckle is 2-3 times stronger than other preformed clamps
- Smooth inside diameter designed to eliminate leak paths
- Buckle hood protects lock from snags
- Install Ultra-Lok® clamping systems quickly using portable power tools

THE BAND-IT TOOL

A drop forged electroplated tool with tensioning capability of over 2,400 pounds and built-in cutter.

Used to apply Band-It Bands and Buckles, strapping and Free-End clamps.



EDP No.	Cat. No.	Item	Weight Lbs
13001	C001	The Band-It Tool	.444

BAND-IT BAND

Band-It Band comes in a choice of metals and in a range of widths and thicknesses, all stainless steel with a full round edge. For extra strength, use a double wrap, threading the band through the buckle each time around. Order band and buckles of the same material & width.



Package Quantity - 100 Ft Roll

EDP No.	Cat. No.	Band Width Inches	Thickness Inches	Weight Lbs
Type 201 Stainless Steel				
13202	C202	1/4	.020	1.7
13203	C203	3/8	.025	3.2
13204	C204	1/2	.030	5.1
13205	C205	5/8	.030	6.4
13206	C206	3/4	.030	7.7

BAND-IT BUCKLES

Buckles, Ear-Lokt, are designed to accommodate both single or double wrap clamps in metals and widths to correspond with Band-It Bands.

Package Quantity - 100



EDP No.	Cat. No.	Band Width Inches	Weight Lbs
Type 201 Stainless Steel			
13252	C252	1/4	.3
13253	C253	3/8	.8
13254	C254	1/2	2.0
13255	C255	5/8	2.6
13256	C256	3/4	3.5

ULTRA-LOK® TOOL w/ACCESSORIES

Now powered with a Lithium-ion battery, the UL4000-D battery charge lasts longer with consistent peak performance through the life of the battery. In addition, the UL4000-D uses a mechanical clutch and predetermined torque settings to provide a consistent tightness that eliminates assembly guesswork.



COUPLINGS & HARDWARE

SAFETY BLOW GUNS



1/4" FEMALE NPT INLET

PISTOL GRIP BLOW GUN



RUBBER TIPPED BLOW GUN

1/4" FEMALE NPT INLET



SELF-STORING AIR HOSE

Male NPT Size Hose I.D. x Length

1/4"	1/4"x12'
1/4"	1/4"x25'
1/4"	1/4"x50'
3/8"	3/8"x25'
3/8"	3/8"x50'
1/2"	1/2"x25'
1/2"	1/2"x50'



BULK HOSE - NO FITTINGS

1/4"	1/4"x100'
3/8"	3/8"x100'
1/2"	1/2"x100'

Available: Nylon and Polyurethane.

* Repair Kits are available.

AIR TOOLS SWIVELS

Available: 1/4" to 1/2" in Aluminum

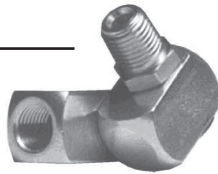

3-PORT MANIFOLDS



Inlet Thread (1)	Outlet Thread (3)
1/4" NPT	1/4" NPT
3/8" NPT	1/4" NPT
1/2" NPT	1/4" NPT

HOSE REELS

Available for Air or Water service... and numerous hose capacities and working pressures.



HYDRAULIC QUICK-CONNECTS

AVAILABLE: 1/4" to 1" in Steel and Brass for various working pressures.



FOOD GRADE FITTINGS



SANITARY END STEM



SANITARY CLAMPS



STEEL FERRULES

Available: 1 1/2" to 4" in Stainless Steel

O-RING KIT

Contains The Most Popular Sizes.



SIZES: 006, 007, 008, 009, 010, 011, 012, 110, 111, 112, 113, 114, 115, 116, 210, 211, 212, 213, 214, 215, 216, 217, 218, 219, 220, 221, 222, 325, 326, 327

This Catalog Only Represents a Portion of the Products Sold.

IF YOU DON'T SEE WHAT YOU WANT...

Please Call Customer Service and Ask 6 Locations To Serve You!

WE SLIT, FABRICATE, LACE & VULCANIZE BELTING IN-HOUSE & ON-SITE!

GOOD FLEX™

Heavy Duty Black Rubber Conveyor Belting by Goodyear Rubber Products

Features:

This Heavy Duty Conveyor belt series features a minimum 10:1 PIW (per inch of width) breaking strength to working tension rating.

We utilize a Polyester / Nylon Carcass for limited stretch lengthwise (Polyester Warp) while providing the ultimate forgiveness and impact resistance the Nylon Weft Cords provide.

Available in a wide variety of constructions utilizing 110# PIW, 150# PIW and 200# PIW fabrics ratings and cover compounds that include SAR (Super Abrasion Resistant), RMA Grade One and Two, MOR, SCORF, MSHA Underground, 400 and 700 Degree High Temperature compounds along with combination Heat & Oil Resistant Compounds.



We offer field installation and vulcanizing services in Florida.

**Many options on cover thicknesses mean...
we may have the perfect belt available FROM STOCK!!**

Fabric Plies

- › Warp Cords - Provide tensile strength, transverse tear, impact resistance
- › Weft Cords - Provide fastener holding, impact resistance, rip and tear resistance

Top Cover

- › Protects the carcass

**Installation
& vulcanization
available.**

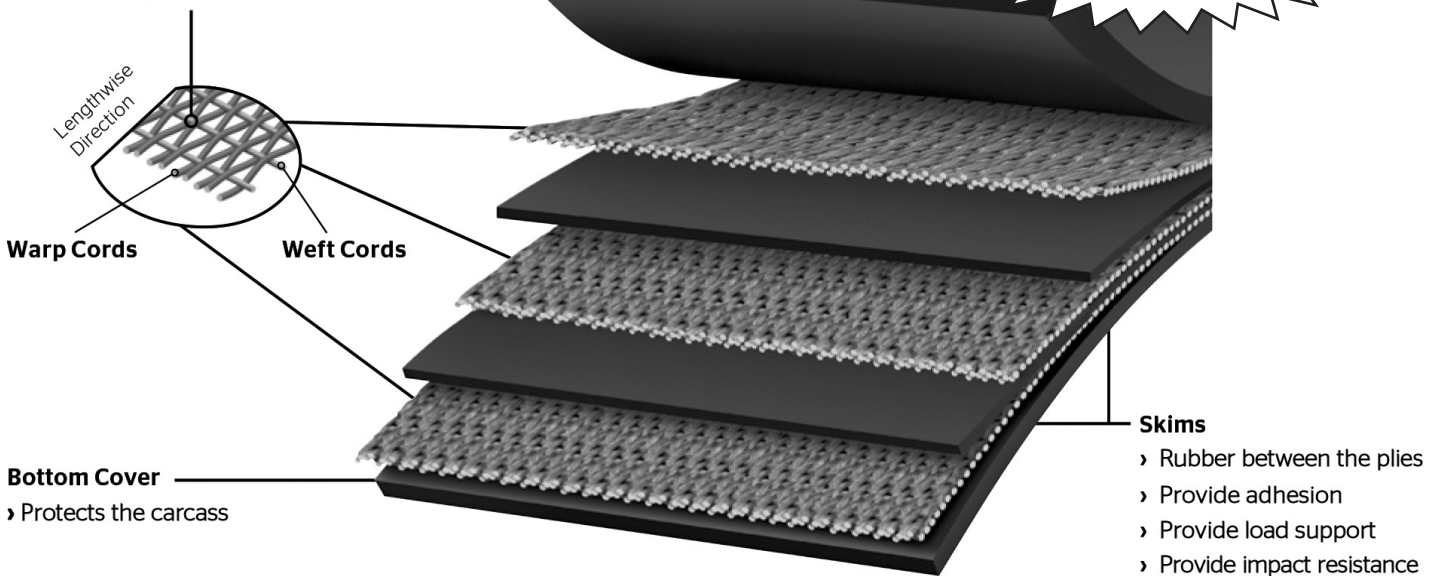

Skims

- › Rubber between the plies
- › Provide adhesion
- › Provide load support
- › Provide impact resistance

www.goodyearbelting.com | www.goodflex.us

MECHANICAL FASTENING SYSTEMS



Mechanical Belt Fasteners Combine Strength and Durability with Affordability and Easy Installation



IN-STOCK

PART#	BOX QTY	TYPE	MIN PULLEY	BELT PLYS	BELT THICK	PUNCH	WRENCH	BOLT BREAKER	TAPE
140E	25	STD	12"	2PLY	3/16"-7/16"	HP1	HW1	110	FL7C
140C	100	STD	12"	2PLY	3/16"-7/16"	HP1	HW1	110	FL7C
140VPB	100	RUBBER COATED	12"	2PLY	3/16"-7/16"	HP1	HW1	110	FL7C
190E	25	STD	16"	3PLY	5/16"-9/16"	HP1	HW1	110	FL11C
190C	100	STD	16"	3PLY	5/16"-9/16"	HP1	HW1	110	FL11C
190VPB	100	RUBBER COATED	16"	3PLY	5/16"-9/16"	HP1	HW1	110	FL11C
190CMAP	100	ABRASION RESISTANT	16"	3PLY	5/16"-9/16"	HP1	HW1	110	FL11C

No matter what you're moving, minimizing downtime and maximizing output are always top priorities—and they can be significantly affected by the way you splice your belts. Most belt conveyor operations rely on one or both common methods of splicing:

- Mechanical Belt Fastening - The process of joining belt ends by metal hinges or plates
- Vulcanization - The process of joining belt ends through heat or chemicals



**EASIER & FASTER TO INSTALL
THINNER & MORE RESISTANT
FULL INTEGRATED INTO YOUR BELT**

Splice your belt simply with screws

SUPER-SCREW® EVOLUTION is the latest addition to the SUPER SCREW® range. THE fast and innovative solution to splice your conveyor belts.

When on-site, you are exposed to field based issues:

- do you need to reduce the number of breakdowns?
- do you have difficult installation access?
- is your site prone to harshweather conditions?
- do you have limited number of staff and training?

"The new generation of flexible splice"



These comments from our customers drove the MLT teams to think about future improvements with these issues in mind. The result is we are able to offer highly innovative solutions, designed around our customer's feedback. Thus, MLT teams have developed the new generation of SUPER-SCREW®, unique and innovative solution to splice your conveyor belt : the SUPER-SCREW® EVOLUTION.

The simplicity of screws allows you to install the SUPERSCREW® EVOLUTION no matter:

- The configuration of the conveyor
- The conditions of access
- Weather conditions
- Temperature -30°C (-22°F) to 200°C (392°F) peak

Technical Data Is Available On Both English & Spanish Websites

POWER TRANSMISSION PRODUCTS



Goodyear Rubber Products offers a full range of Power Transmission Products including V-belts (both cogged and classical styles), timing belts, synchronous belts, banded belts, fractional horsepower and metric belts.



SilentSync®

Static conductive and engineered to deliver up to 98% energy efficiency.

In addition to the belts, GRP offers matching sprockets, sheaves and bushings along with tension testers, sheave gauges and laser alignment tools.

Falcon PD®

Demand more from your drive systems. With Falcon Pd® you can expect the same long-lasting, maintenance-free performance in your low-speed, high-torque drives that you get with the rest of your drive systems. Soar with the latest drive system innovation. For more than 100 years, our rubber compounding technology has produced the most versatile, durable and dependable power transmission belts possible.



CALL GOODYEAR RUBBER PRODUCTS FOR ALL YOUR BELTING NEEDS!

Torque Team Plus®

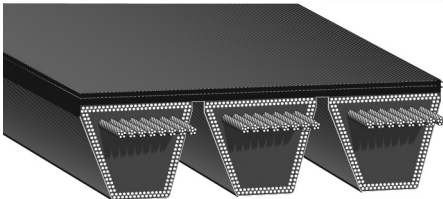

Neothane® Insta-Power® with Aramid



Neothane®

Metric Belts



FHP Belts

ELATECH® Polyurethane Belts

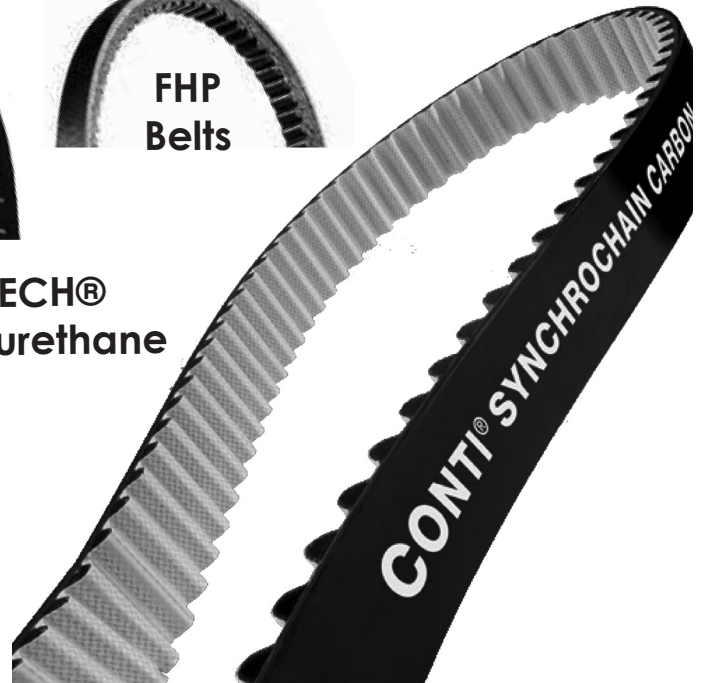

For our resale customers, we now offer **confidential blind shipping**, directly to your customer!!
"Packing slip shows products shipping from your company!! !!

POWER TRANSMISSION & CONVEYOR COMPONENTS

DID YOU KNOW? Added to Goodyear Rubber Product's Huge Selection....

A complete line of Power Transmission related accessories and Conveyor Components including, bearings, electric motors, gearboxes, roller chain, sheaves and sprockets, conveyor pulleys, idlers, belt scrapers and much more!

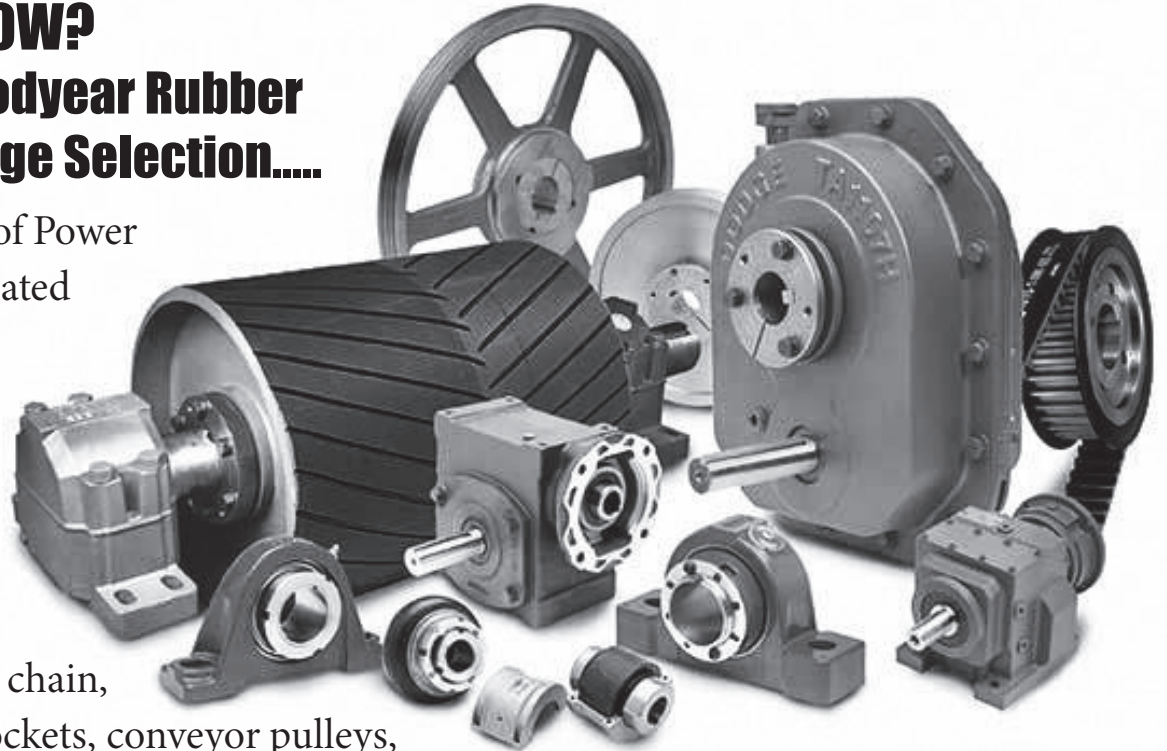

Se habla español

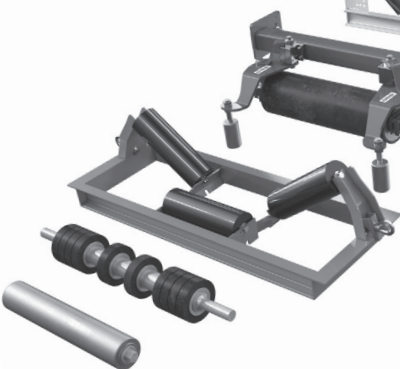
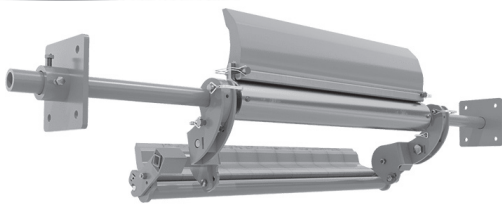

Let us help you select
the proper Power
Transmission solution for
your application.



HARDWARE

BIBBS

30216	1/2"	Rough, Brass, Hose End Bibb Tee Handle	144	12	63
30217	3/4"	Rough, Brass, Hose End Bibb Tee Handle	144	12	71



EARED CLAMPS



BOILER DRAINS

Heavy pattern and heavy-duty cast iron handle



1/2" Fits copper and iron pipe

BRASS NOZZLE

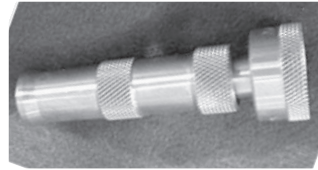

529C - Mid Size Solid Brass "No-Drip" Twist Nozzle



PUMP DIAPHRAGMS



TARP STRAPS

This molded end tarp strap will secure most anything and keep it tight! Tarps, pool covers, trunk lids, garbage lids, farm gates, tents, or whatever. Complete with S hook.

ELECTRICAL TAPE



TEFLON TAPE



DUCT TAPE

Silver Coated Cloth



PAINT BRUSHES



TIE-DOWNS - 7/16" Diameter, Heavy Duty

Great for holding: boat covers; trunk lids; garbage can covers; tents; tarps on trucks, trailers and motorcycles;

Display Kits:

716-KM.....	150' Coil
.....	with Metal Hooks only
716-D-2.....	600' Coil
.....	in Display carton
716-R.....	5700' Reel



SPRING GUARD and ARMOR GUARD

Two products that prolong the life of hose lines that are exposed to rugged operating conditions. They distribute bending radii to avoid kinking in hose lines and protect hose from abrasion and deep cuts. Guards are constructed of steel wire and plated to resist rust.



FIRE SLEEVES

Available in sleeves or tape in sizes 1/4" to 6"



YPZ100M-BX



YRZ150M



YRSZ150M

Alert workers to potential safety hazards and work in progress while keeping floors dry.

- High-visibility mat design features multilingual safety messages and symbols to alert workers about potential workplace hazards
- Abrasion-resistant top layer gives pads strength for everyday cleanup jobs
- Universal absorbency means one product for multiple liquids
- Quickly absorbs leaks, spills and overspray to keep floors dry

CAUTION Yellow Universal Mats

Item #	Description	Size	Units/Pkg	Absorbs/Pkg
YPZ200S-BX	LightWeight Pads	15" x 19"	200	31.1 gal.

Item #	Description	Size	Units/Pkg	Absorbs/Pkg
YRZ150M	MediumWeight Roll	30" x 150'	1	46.1 gal.
YRSZ150M	MediumWeight Split Rolls	15" x 150'	2	46.1 gal.



A-MAGRACK

Compact, grab-and-go roll size is great for mobile techs.

- Easier to use than floor sweep so it reduces cleanup time; just put it down, let it work and pick it back up.
- Free of damaging grit and dust, so it's perfect for use around delicate sensors, parts and tools
- Keeps dirt and grit out of customer vehicles and maintains a clean, professional environment in the shop
- Universal absorbs oils, coolants, solvents, water and more



GRSF1550S

COMMANDER™ Absorbent Roll

Item #	Description	Size	Units/Pkg	Absorbs/Pkg
GRSF1550S	Universal LightWeight Roll	15" x 50'	12	53.4 gal.



Magnetic Roll Holder

Attaches to toolboxes or any other metal surface

- Keep mat off the floor and close at hand

Item #	Description	Size
A-MAGRACK	Roll Holder Dispenser with Magnets	5.5" x 17" x 2"



WP-S

CONTRACTOR GRADE White Oil-Only Pad

The economical solution for the fast cleanup of oil spills.

- Absorbent meltblown polypropylene mat repels water and soaks up only oil and oil-based fluids
- Perfect for light-duty industrial and maintenance applications; use only what you need and save money
- Pads are great for general cleanup applications; perforated at 7.5" up the center
- Absorbs leaks, spills and overspray

Item #	Description	Size	Units/Pkg	Absorbs/Pkg
WP-S	LightWeight Pads	15" X 18"	200	35 gal.



SVP100H

SURVIVOR™ Universal Pad

The absorbency of a mat and the durability of a rug — hides grunge to stay on the job longer.

- Camo pattern makes leaks and drips disappear
- Five-star durability withstands foot traffic in production areas, near machines and in walkways
- Innovative 3-ply construction combines our toughest SpunBond top layer, highly absorbent core and a bottom layer designed to grip floors
- Perforations allow you to tear pads and rolls into different sizes based on your application

Item #	Description	Size	Units/Pkg	Absorbs/Pkg
SVP100H	HeavyWeight Pads	15" x 19"	100	17.9 gal.



GTOP

DrumTop Pads

Say goodbye to messy drum tops.

- Absorb drips from leaking pumps to help keep drum storage areas looking good
- Precut bung holes make for easy access to drum
- Pads can be removed and replaced with pumps and valves installed
- Grunge-hiding gray signifies universal sorbency for oils, coolants, solvents and water
- Made from top-quality COMMANDER Mat

Item #	Description	Size	Units/Pkg	Absorbs/Pkg
GTOP	HeavyWeight Pads	22" dia.	25	8.6 gal.

SAFETY & PROTECTIVE GEAR

INDUSTRIAL RAIN GEAR

Large selection from Coated Cotton Heavyweight Raingear to Plastic Parkas

See size chart below!



Call for your specific rain gear needs!

PONCHO

Utility Bib Overall - Our most popular bib overall used in construction and industry. A medium priced garment with all the features and reinforcements necessary for comfort and protection.

Sizes: *Small to Extra Extra Large.*

Coats or Jackets with Hoods

Official Nor'Easter style and construction. Six piece crown; stitched, cemented and strapped seams. Continuously stitched rubber covered buckram brim. Flannel lined ear flaps and chin tape.

Sizes *6 1/2 to 7 3/4.*

INDUSTRIAL RAINCOATS

- BIB OVERALLS •
- JACKETS • COATS
- PANTS • SUITS & ACCESSORIES



We Stock Many Different Styles!

WE CAN ADD YOUR COMPANY NAME OR LOGO

MEASURING CHART

All garments are cut generously oversize for freedom of movement and maximum comfort.

CHEST SIZE	36/38	40/42	44/46	48/50	52/54	56/58
WAIST SIZE	32/34	36/38	40/42	44/46	48/50	52/54
SIZE TO ORDER	SM	MED	LG	X-LG	XX-LG	XXX-LG

O.S.H.A. APPROVED SAFETY EQUIPMENT



Hardhats and Vests are available on special order, minimum quantities required

SAFETY & PROTECTIVE GEAR

GLOVES: NEOPRENE, ALL RUBBER AND NEOPRENE COATED FABRICS

Impermeable to practically all acids and caustics – resistant to oils



10.5" 11" 12" 14" 18"



LEATHER, WELDERS, COTTON, PVC



Let Us **HANDLE** Your Glove Needs!

BOOTS

Excellent for use in: Construction, Manufacturing, Agriculture & Aquaculture



Features & Benefits:

- 100% Waterproof, PVC Compound, Rubber
- Steel toe style complies with ASTM F2413-05
- Self-Cleaning lug outsole for traction in wet, muddy conditions
- V-bar molded shank for complete arch support
- Resistant to acids, alkalis, gasoline, oil, grease, solvents, salt water & ozone
- Kick-off for easy removal
- Available in all sizes, White or Black, with or without steel toe
- Heavy Duty Boots that are fully lined

SAFETY GLASSES & GOGGLES



Many Styles to Choose From

Se habla español

HIGH TEMPERATURE TEXTILES

Goodyear Rubber Products offers a complete line of High Temperature Textiles used in cloth form (roll goods), rope, tubing (sleeving) and tapes including tadpole, bolt hole (referred to as drop warp) with and without adhesive backings

Additionally, we can supply fabricated welding protection blankets and curtains, insulation pads and other custom, sewn textiles with or without grommets. Texturized, woven fiberglass products, coated fabrics and extreme temperature fibers such as silica and ceramic are readily available.



1-800-FOR-HOSE
and
High Temp Textiles!

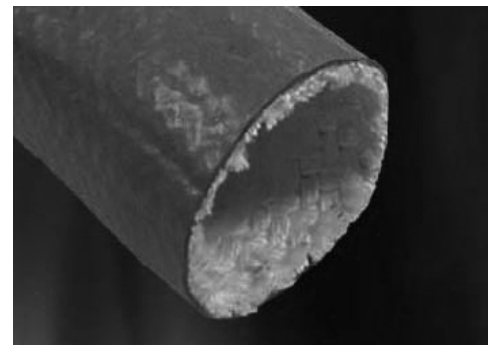
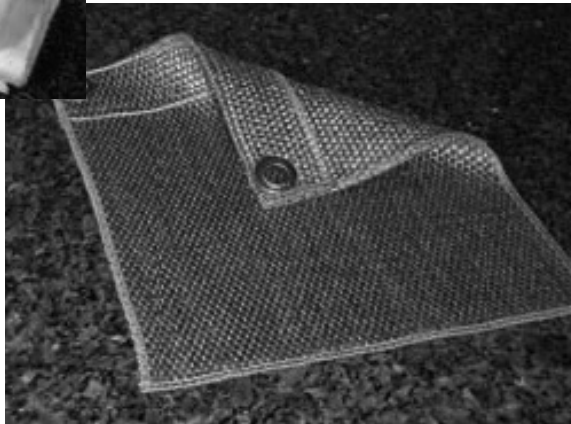

We carry
a Complete
Line of High
Temperature
Textiles Readily
Available...
Give Us A call!

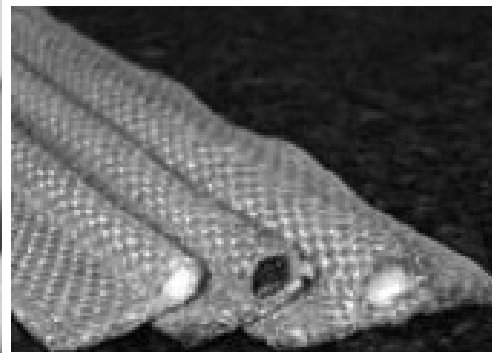
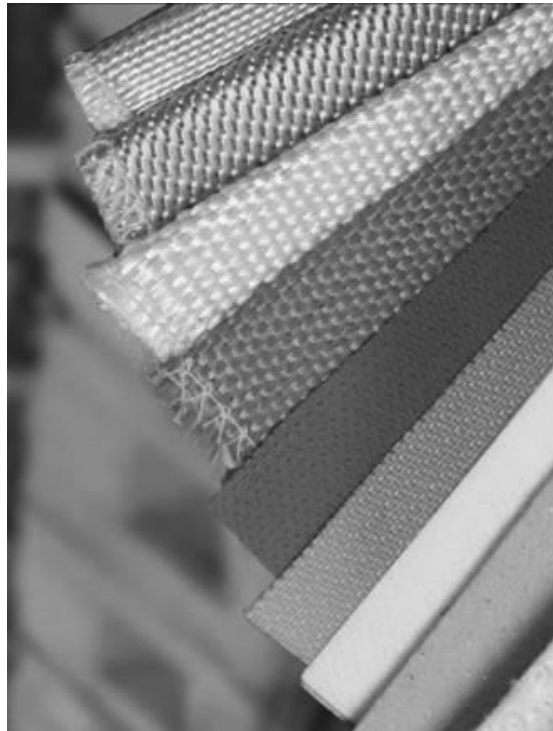
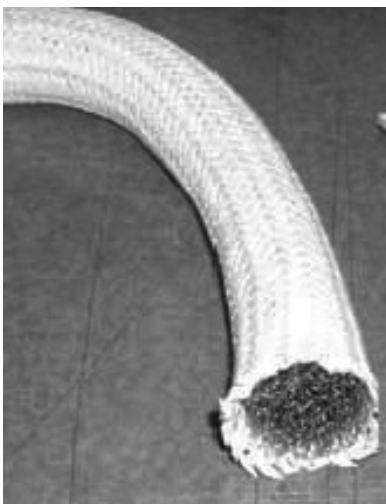

FLUID SEALING PRODUCTS

Goodyear Rubber Products offers a complete line of Fluid Sealing products including Compression Packings and Mechanical Seals for valves, pumps and other rotating shaft equipment. Dynamic sealing also includes Hydraulic Cylinder Vee Packings and U-Seals.

We supply both standard full face and ring style pipe flange gaskets along with custom "Die-cut" and "Water Jet" Cut gaskets and rubber parts along with custom rubber strip and extrusions.

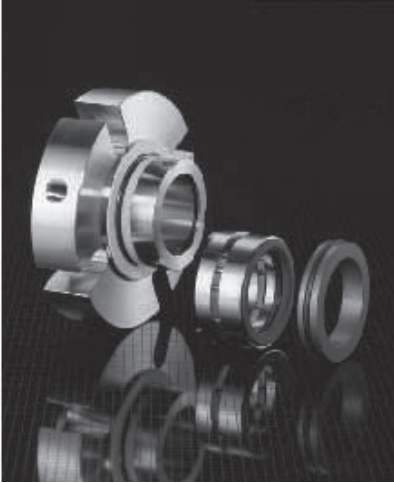

Sepco Mechanical Seals
available from stock

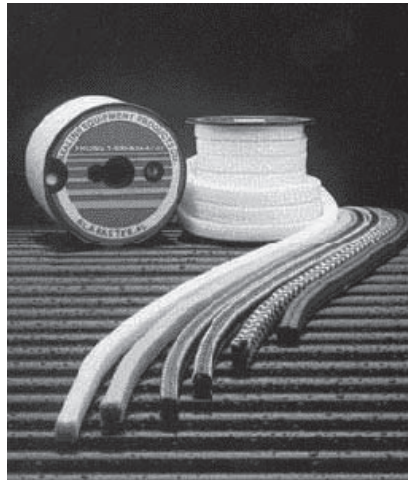

Braided compression packings
for pumps, valves and other
rotating equipment

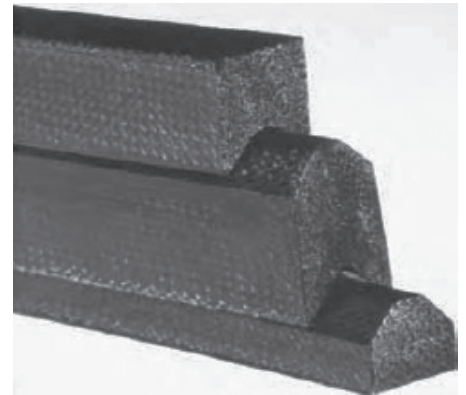

Chevron style top, bottom
and center Vee Packings for
Hydraulic Cylinders

CUSTOM GASKET CUTTING AVAILABLE For Your Every Need!

Gaskets cut from any compressed non-asbestos materials, red rubber, neoprene, cork, vegetable fiber, viton, expanded Teflon and many other materials

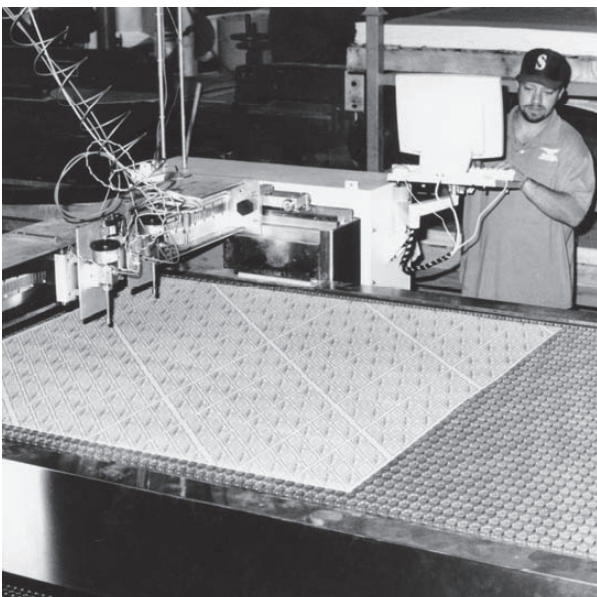

Computer Aided Water jet cutting of materials up to 2" thick from your CAD drawings or ours is available from GOODYEAR RUBBER PRODUCTS

SHEET RUBBER

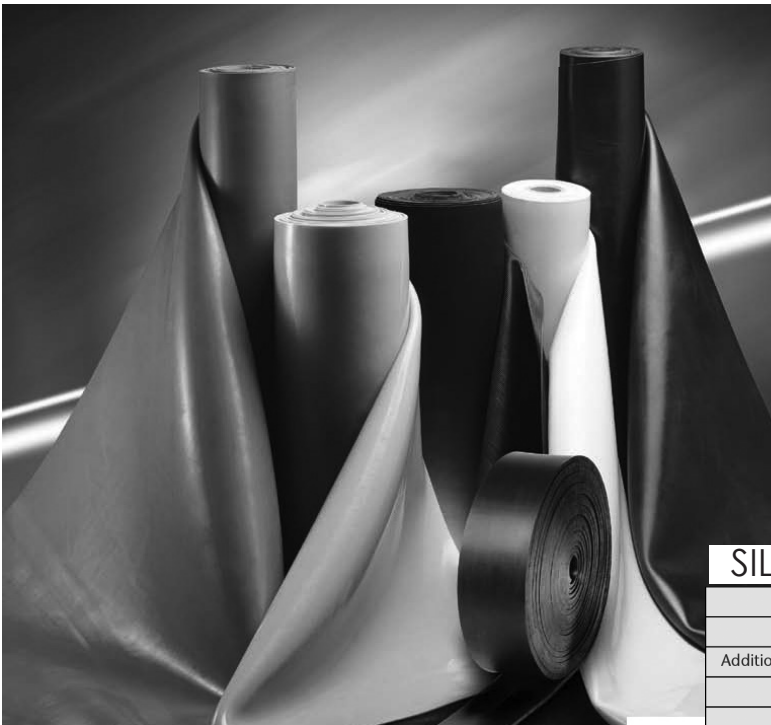

SILICONE RUBBER CONTINUOUS SHEETS

Hardness	Range from 20 durometer Shore A to 80
Normal Available Colors	Red/Orange
Additional colors available upon request	Grey; Tanslucent; White; Black; Blue; and Brown
Custom color matching	Available on special order
Width	36" untrimmed standard (other widths upon request)

NEOPRENE/POLYCHLOROPRENE (CR)

- Excellent adhesion properties
- Good inherent flame resistance
- Good resistance to weather, ozone, and natural aging
- Good resistance to abrasion and flex cracking
- Good resistance to alkalis and acids
- Moderate oil and gasoline resistance
- Available: White food grade (FDA compliant)



NATURAL RUBBER (NR)

- Excellent abrasion resistance
- High tensile strength
- High tear strength
- Good flexibility
- Available: Food grade (FDA compliant)

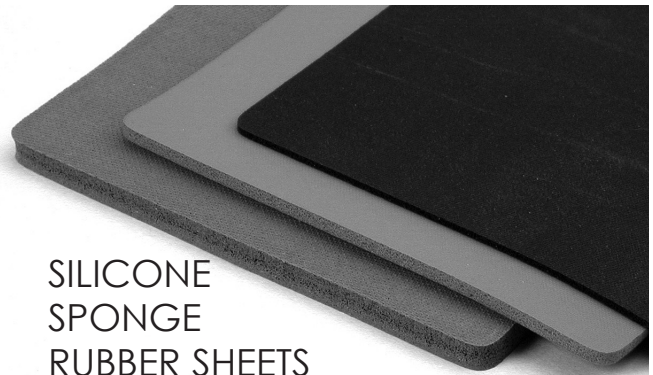

SILICONE SPONGE RUBBER SHEETS

Properties	3194	3195	3196
Compression Deflection (psi @ 75% original thickness)	12-20	6-14	12-20
Maximum Density (lbs./cu.in.)	.030	.020	.030
Compression set (% original deflection, max.)	60%	60%	60%
Low Temperature Brittle Point (°F)	-130	-130	-100



ETHYLENE PROPYLENE DIENE (EPDM)

- Excellent resistance to heat, ozone and sunlight
- Excellent color stability
- Excellent resistance to water and steam
- Very good flexibility at low temperatures
- Good resistance to alkalis, acids and oxygenated solvents
- Available: White food grade (FDA compliant)



NITRILE (NBR)

- Superior resistance to petroleum-based hydraulic fluids
- Very good resistance to oil and gasoline; alkalis and acids; and hydrocarbon solvents
- Wide range of service temperatures
- Available: White FDA & 3A Sanitary Standards compliant

Also available: Styrene-Butadiene (SBR), Butyl (IIR), Skirtboard, Fluoroelastomer (FKM), Silicone, Fabric Reinforced Sheets & Diaphragm.

GASKET MATERIAL

COMPRESSED FIBER GASKET MATERIALS

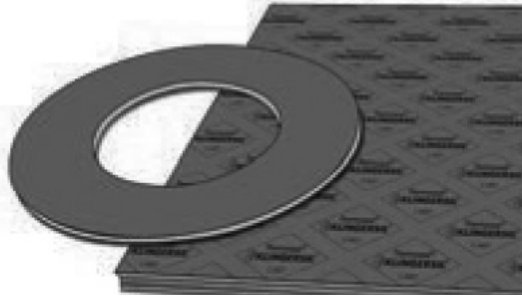

KLINGERSIL® C-4401

A universal, general purpose gasket material that has excellent sealability and chemical resistance. C-4401 is manufactured with aramid fiber reinforced with a nitrile binder.

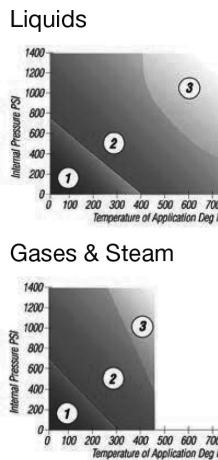

A common perception is that the suitability of a gasket for any given application depends on the maximum temperature and pressure conditions. This is not the case. Maximum temperature and pressure values alone cannot define a material's suitability for an application. The successful operation of a gasket depends upon a multiplicity of factors including flange surface and design, bolts, temperature, pressure, media being sealed and gasket material, design and assembly.

The ability of a gasket to make and maintain a seal depends not only on the style and quality of the gasket material, but also on medium being sealed, the flange design, the amount of pressure applied to the gasket by the bolts and how the gasket is assembled onto the flanges and tightened. These factors are beyond the manufacturer's control.

THE MANY, VARIED DEMANDS PLACED ON GASKETS Proper Flange Assembly

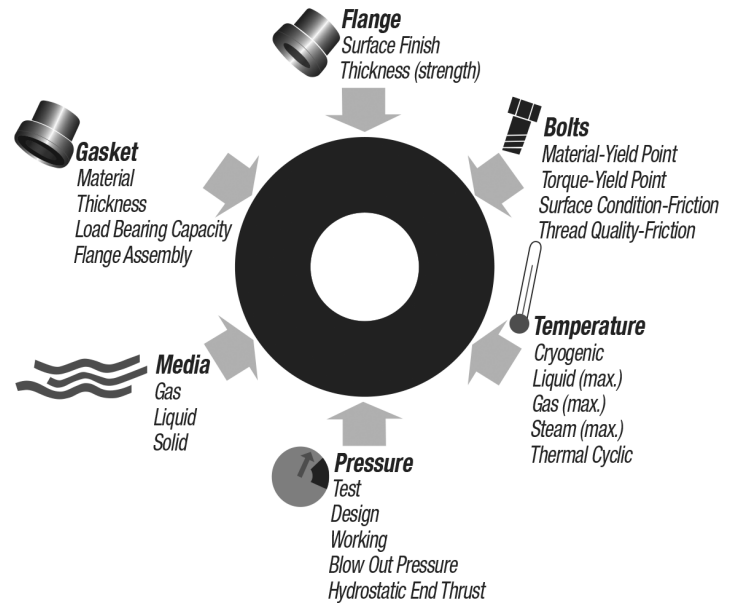

INERTEX SQ-S™ GASKET SHEET

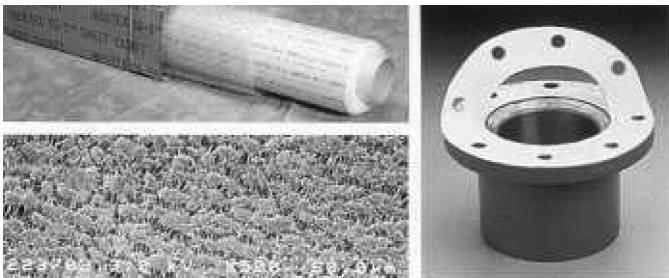

INERTEX SQ-S GASKET SHEET is the world's first 100% expanded PTFE in a true 60" x 60" format. This material is manufactured by our proprietary isotropic-expansion process which breaks all the rules traditional to gasket material manufacturing of the past. Isotropic-expansion provides a highly fibrillated microstructure with nearly equal tensile strength in every direction. This unique structure maximizes performance predictability and stability while minimizing creep and cold flow. INERTEX SQ-S definitely is an all-purpose gasket sheet that is setting the new standard in gasket technology.

- ONE COLOR... ONE CHOICE
- PURE... INTEGRAL
- SOFT... BUT STRONG
- THE TIGHTEST
- USER-FRIENDLY
- QUALITY ASSURANCE

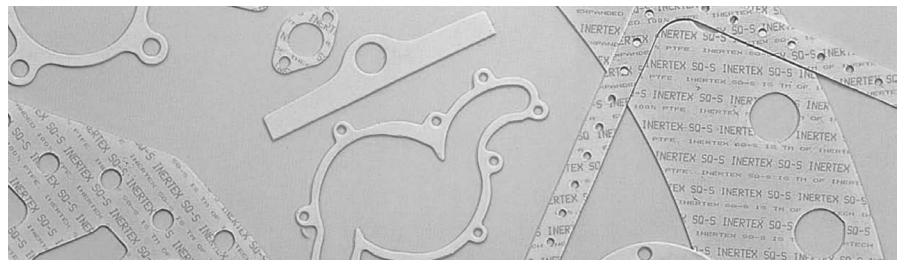

TESTED. PROVEN... Gaskets for the NEW MILLENIUM

Technical Data Is Available On Both English & Spanish Websites

FLOOR MATTING

MATS, TREAD MATS, RUNNERS & MATTING STAIR TREADS

Full rolls • Custom Cut Lengths • Stock Sizes

1/8" Corrugated Rubber

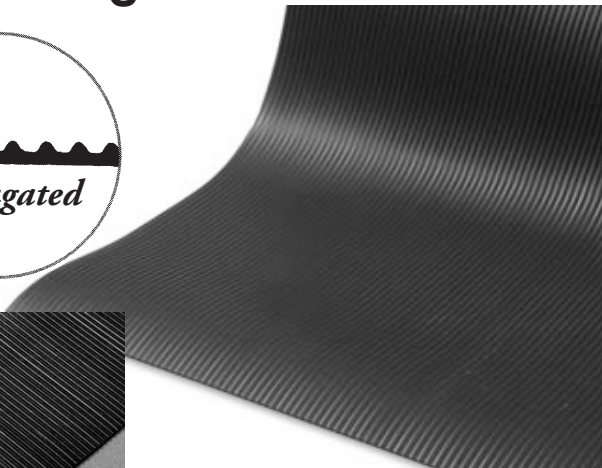
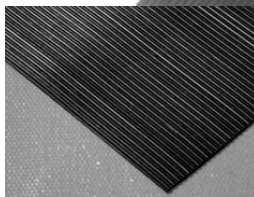

FEATURES: A uniquely engineered non-directional pattern combined with a special formulation resulting in an exceptionally slip-resistant vinyl runner.

FUNCTION: Primarily to be used where safety and floor protection are of major importance.

BENEFITS: Resists many oils, greases and fats. Exceptional wear and long life. Reduces maintenance costs. Offers slip resistant pattern for greater safety. Meets flammability test requirements of Motor Vehicle Safety Standard No. 302 (49 CFR 571.302)

APPLICATIONS: Ideal for ramps, airports, walkways, factories, restaurants, office building and department stores.

FEATURES: A uniquely engineered non-directional pattern combined with a special formulation resulting in an exceptionally slip-resistant vinyl runner.

COLORS: Black, Brown, White

SIZES: 1/8'x36", 1/8"x48, White in 36" only

ROLL LENGTH: Approx. 25 yards

WEIGHT: 7.9 lbs./sq. ft.

Anti Fatigue

THE ULTIMATE ANTI-FATIGUE RUNNER MATTING FOR WORKER COMFORT AND SAFETY

PRODUCT

APPLICATION:

Industrial and manufacturing facilities, stores, garages, florist shops and night clubs. Wherever employees stand to perform their jobs.



1/4"
3/8"
1/2"

FEATURES: A durable corrugated rubber runner engineered for maximum service and long wear. Has a smooth-back finish. Available in half rolls approximately 25 yards and full rolls approximately 50 yards.

FUNCTION: Most widely used where floor protection and safety are vitally important.

BENEFITS: An all-weather product. Will not curl, shrink, or separate. Cleans easily and quickly, promotes cleanliness. Good abrasion resistance. Sound Absorbing.

APPLICATIONS: Ideal for general use in industry, in the home, and office buildings.

COLORS: Jet Black, Russet Brown

SIZES: 1/8' x24", 36", 48", 72"

ROLL LENGTH: 24", 36", and 48", Approx. 25 yards

HALF LENGTHS: Approx. 25 yards

72" Approx. 25 yards

WEIGHT: Approx. 6 lbs./sq. ft.

Pyramid™

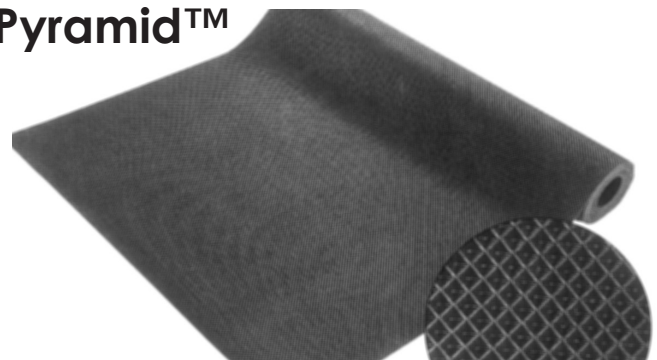

This matting is made of durable sponge vinyl and the 1/4" and 3/8" is long enough to provide comfort to the entire assembly line... that's a lot of happy people.

- Hard wearing, durable sponge vinyl construction
- Corrugated surface to trap dirt and reduce slips
- Beveled edges lay flat - won't curl.
- Easily cleaned with vacuum or broom
- Aids in noise control
- Cushions dropped tools



**Custom Made Mats
With Your Logo!**

DOCK FENDERS

Goodyear's Rubber Marine Fenders

Available in black, white and gray, the fenders are extruded from high quality EPDM compounds able to resist the harsh marine environments they will be subjected to.

D Shaped, Cylindrical, Wing-Style, Channel Lock and Trapezoidal are just a few of the common shapes.

Available in sizes ranging from 2" to 18" and lengths to 60 feet.

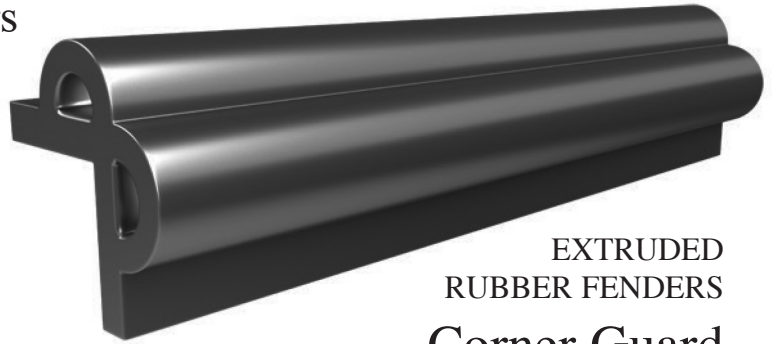

EXTRUDED
RUBBER FENDERS
Corner Guard

Cut To Length as Desired

Goodyear Rubber Products is an excellent source of RUBBER MARINE AND DOCK FENDERS.

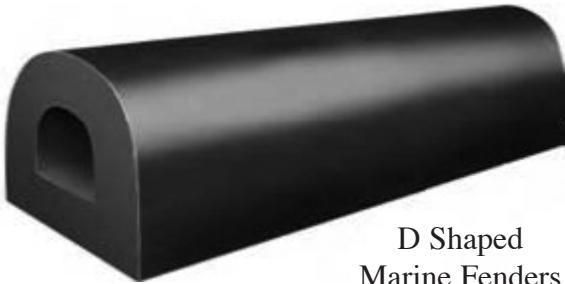

D Shaped
Marine Fenders



Wing Type O
Bore Fenders



Channel Lock
Fenders



Cylindrical Chain
Style Fenders

Cut to length and pre-drilling services are available along with retaining bars and required hardware. Application Engineering Services available upon request.

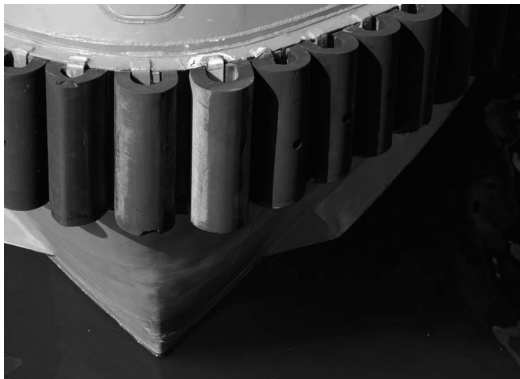

Most
Tow Knees
available
from
factory
stock



MARINE INDUSTRY HOSES

Goodyear Rubber Products carries a wide variety of Marine application hose styles including special silicone high temperature hump hoses and molded elbows.

**MARINE FUEL LINES • MARINE FUEL FILL HOSES
MARINE GASOLINE & DIESEL HOSES • MARINE SANITARY HOSES**



Custom Marine fuel hose assemblies and Marina pump out assemblies available.



**Power Trim
Assemblies**

Custom made... Power trim assemblies made while you wait along with Fuel line, Fuel Fill, and both Hardwall and Softwall Marine Exhaust hose.

MARINE HOSES

ARMADA™ FUEL, WET EXHAUST & MULTI-PURPOSE HOSE
WAVEMASTER™ BARRIER FUEL LINE & VENT HOSE THORO-
BRAID® CLEAR MARINE FDA/NSF WATER HOSE



**Marina Pump Out
Assemblies**

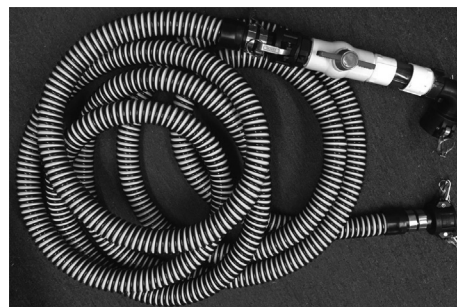

After 1,200 hours of Parker's own sea salt spray test the 26 Series all-brass fittings show no sign of rust.

SILICONE CONNECTORS

HUMP HOSE • REDUCERS • ELBOWS • MARINE EXHAUST HOSE
CUSTOM CONSTRUCTION ALSO AVAILABLE

Our team of professionals are ready to assist you with engineering support, fluid connector systems design and proper product selection.



Six Locations To Serve You!

NEW LOCATION! CLEARWATER

11301 47th Street North, Clearwater, FL 33762
(727) 822-4672 • (800) 367-4673 • Fax (727) 821-8721
Clearwater@goodyearrubberproducts.com

FORT MYERS

12701 Metro Parkway, Ft. Myers, FL 33966
(239) 561-HOSE(4673) • Fax (239) 561-0018
FtMyers@goodyearrubberproducts.com

NEW LOCATION! ST. PETERSBURG

1901 1st Avenue S., St. Petersburg, FL 33712
(727) 456-6380 • Fax (727) 456-6381
StPete@goodyearrubberproducts.com

NAPLES

5530 Shirley St., Naples, FL 34109
(239) 596-0072 • Fax (239) 596-0073
Naples@goodyearrubberproducts.com

BRADENTON

6216 - 28th Street East, Bradenton, FL 34203
(941) 739-9777 • Fax (941) 739-9778
Bradenton@goodyearrubberproducts.com

TAMPA

5910 Adamo Drive (Hwy 60), Tampa, FL 33619
(813) 627-8956 • Fax (813) 627-8957
Tampa@goodyearrubberproducts.com

VISIT OUR WEBSITE:

www.goodyearrubberproducts.us



EMAIL ADDRESS:
Sales@GoodyearRubberProducts.com



1-800-FOR-HOSE (367-4673)

24 Emergency Service for all locations is 727-822-2893 (se habla español)

AUTOMOTIVE

Air Conditioning Hose
D.O.T. Brake Hose
Clutch Lines
Fuel Lines

CLAMPS

General Purpose Hose
Heater Hose
Power Steering
Turbo Sleeve

BELTS & BELTING

Conveyor Belt
V-Belts • Timing Belts
Belt Fasteners
Fabrication
Pulleys & Idlers

HOSE COUPLINGS & ACCESSORIES

Industrial Tube Fittings
Plastic Fittings
Brass Pipe Fittings & Valves
Hose Nipples
Quick Disconnect Couplers

GARDEN HOSE

Rubber/Plastic
Nozzles/Accessories

HARDWARE

Adhesives
Tape:Duct/Elect./Teflon
Rubber Straps w/Hooks
Pump Diaphragms
Paint Brushes
Plumbing Accessories

HYDRAULIC HOSE

Rubber & Thermoplastic Hose
Crimp Fittings
Reusable Fittings
Stainless Steel
Industrial Tube Fittings
Adapters
Crimp Machines & Fab Equip.
Metrics

INDUSTRIAL HOSE

AG Spray
Air, Multi-Purpose

Water Hose
Welding

MARINE

Dock Guard & Bumpers
Exhaust Hose
Fuel Line, Vent, Fill Hose
General Purpose Hose
Sanitation & Gally Fill
Marine Steering Hose
Hydraulic Control Lines

MATTING

Anti-Fatigue
Door Mats
Mat Runners
Specialized
Personalized Mats

PROTECTIVE CLOTHING

Aprons
Boots
Gloves: PVC, Rubber, Leather
Rain Suits
Raincoats

SAFETY EQUIPMENT

Bump Caps
Safety Goggles, Glasses
Safety Hats
Safety Vests & Flags
Traffic Cones

TUBING

Nylon • Silicone
Polyethylene
Polypropylene
Reinforced Vinyl
Clear Vinyl • Gum

VALVES

Ball, Gate, Check
Actuated Valves
Needle Valves
Brass/Stainless/Plastic
Blow Guns
Filters
Regulators
Lubricators
Gauges

Representing: Accuflex Industrial Hose • Allpax • Amatec • American Biltrite • Apache Hose & Belting • Baycon • Bee Valve • Belt Service • Boston Hose • Bradford Fittings • Brake Quip • Brennan Industries • Campbell Fittings • Conveyor Accessories • Darco Southern • Dixon Powhatan • Dixon Valve & Coupling • Duramax • Eaton • Everitte Couplings • Flexaust • Flexco • Flexible Technologies • Flexitallc • Foam Fair Industries • Gateway Safety • Goodman Hewitt • Green Leaf • Hose Handlers, Int'l • HoseMaster • Hygenic Corporation • Ideal / Tridon • Jar-Bar Silicone • Jason Industrial • Kanaflex • Kuriyama • Midland Metal • Mol Belting • Mulhern Belting • National Equipment Company • Novaflex • Oetiker • Pacific Echo • Parker Hannifin • Proco Products • PT Coupling • R3 Safety • SEPCO • Snap-Tite • Stucchi • Sun Flow • Synaflex • TAPCO • Teadit • Thermoid • Thermoseal • Titan Industries • U.S. Hose/Wilcox/Tift • Unaflex • United Pacific Distributors • Urethane Solutions • Van Gorp • Warco Biltrite • Webstone Company • Zone Distribution Company

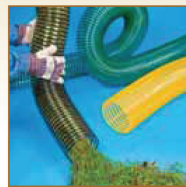

R-2



Size Range:
stock 1 1/4" to 18"
Standard Length: 25' 50'
Standard Colors:
blue, clear
Temp. Range:
20° to 160°

- Light weight PVC hose reinforced with a spring steel wire helix
- Great flexibility with tight bending characteristics
- Good chemical and moisture resistance
- Good compressibility
- Excellent choice for ventilation applications, dust and fume removal
- Blue is listed as UL 94V-0 flame retardant.
- Clear is manufactured with FDA acceptable materials
- Wall thickness = .020"
- Available in metric sizes

T-7



Size Range:
stock 2" to 24"
Standard Length: 25' 50'
Standard Colors:
black
Temp. Range:
-60° to 275°

- Medium weight thermoplastic rubber hose reinforced with a spring steel wire helix
- Good abrasion resistance
- Designed for applications with wide temperature ranges
- Great moisture and UV resistance
- Excellent chemical resistance
- Smooth interior assures minimal friction loss and efficient air flow
- Wall thickness = .030"
- Available in metric sizes
- Available with factory-installed 2" soft cuffs

Fix-Thane LD



Size Range:
stock 2" to 18"
Standard Length: 25' 50'
Standard Colors:
clear, black
Temp. Range:
-65° to 225°

- Light weight polyurethane hose reinforced with a bronze coated spring steel wire helix
- Great compressibility
- Great abrasion resistance
- Superior chemical resistance.
- Excellent flexibility
- Designed for applications with wide temperature ranges
- Clear is manufactured with FDA acceptable materials
- Wall thickness = .020"
- Available in metric sizes
- Available with factory-installed 2" soft cuffs

CWGP



Size Range: *stock 1" to 24" custom to 60"*
Standard Length: 25'
Standard Colors: *black*
Temp. Range: *-40° to 250°*

- Double-ply neoprene coated polyester fabric hose reinforced with a spring steel wire helix
- Good crush resistance and tensile strength
- Neoprene coating offers excellent abrasion and chemical resistance
- Good flexibility
- More durable than double-ply cotton hoses
- Listed as UL 94V-0 flame retardant
- Additional coatings available for better abrasion and/or chemical resistance
- Available in a static conductive version (Conduct-O-Flex)
- Available in metric sizes

GS



Size Range:
stock 1" to 12"
Standard Length: 12'
Standard Colors:
iron oxide red
Temp. Range: *-65° to 550° intermittent to 600°*

- Double-ply silicone coated fiberglass fabric hose reinforced with a spring steel wire helix and external filament fiberglass cord
- Suited for high temperature air handling applications
- The narrow pitch allows for tight bending radius while maintaining a smooth air flow
- Ideal for plastic processing applications
- Non-kinking
- Resistant to many oils and solvents, ozone, water, fungus and alkalis
- Not recommended for continuous flexing

Tiger Tail



Size Range:
stock 1 1/2", 2", 3", 4"
Standard Length: 25' 50'
Standard Colors:
yellow and black
Temp. Range: *-40° to 140°*

- Rugged polyethylene copolymer hose reinforced with an integral polyethylene helix
- Improved polymer formula & 25% thicker to extend life
- Double helix design allows for superior flexibility and durability
- Ideal for waste evacuation, septic pumping and sewer cleaning
- Superior abrasion, better crush resistance and resists kinking
- All sizes handle a full vacuum
- Made with factory-installed leak proof polyweld cuffs

Call 1-800-FOR HOSE

Six Locations To Serve You, see maps on page 2

CLEARWATER

11301 47th Street North
Clearwater, FL 33762
(727) 822-4672 • (800) 367-4673
Fax (727) 821-8721
Clearwater@goodyearrubberproducts.com

FORT MYERS

12701 Metro Parkway
Ft. Myers, FL 33966
(239) 561-HOSE(4673)
Fax (239) 561-0018
FtMyers@goodyearrubberproducts.com

BRADENTON

6216 - 28th Street East
Bradenton, FL 34203
(941) 739-9777
Fax (941) 739-9778
Bradenton@goodyearrubberproducts.com

TAMPA

5910 Adamo Drive (Hwy 60)
Tampa, FL 33619
(813) 627-8956
Fax (813) 627-8957
Tampa@goodyearrubberproducts.com

ST. PETERSBURG

1901 1st Avenue S.
St. Petersburg, FL 33712
(727) 456-6380
Fax (727) 456-6381
StPete@goodyearrubberproducts.com

NAPLES

5530 Shirley St.
Naples, FL 34109
(239) 596-0072
Fax (239) 596-0073
Naples@goodyearrubberproducts.com

24 Emergency Service for all locations is 727-822-2893 (se habla español)

VISIT OUR WEBSITE: www.goodyearrubberproducts.us • E-MAIL ADDRESS: SALES@GoodyearRubberProducts.com