

*WE KEEP IT MOVING*

ENGINEERING & DIMENSIONS

CONVEYOR PULLEYS - BULK MATERIALS

**GOODYEAR**  
RUBBER PRODUCTS, INC.

+1.727.342.5087

También puede enviarnos un correo electrónico a [ventas@goodyearrubberproducts.com](mailto:ventas@goodyearrubberproducts.com)



# ABLE OF CONTENTS

- 3 Drum Conveyor Pulleys
- 4 Wing Conveyor Pulleys
- 5 Single Disc Elevator Pulleys
- 6 Lagging
- 8 XT® Hubs & Bushings
- 10 QD® Hubs & Bushings
- 12 Keyless Locking Assemblies
- 13 PPI Static Shaft Pulley
- 13 Other Hubs
- 14 Shafting Details
- 15 Pulley & Shaft Engineering Information
- 21 Part Numbering
- 21 Crown Styles
- 22 Engineering Data



# DRUM CONVEYOR PULLEYS



## PRO DUTY®

All Pro Duty pulleys feature profiled end discs similar to that found in high tension Turbine pulleys. Profiled end discs are shaped from a solid piece of steel allowing the hub to be machined into it rather than welded in. Welded hubs are the most common failure point for drum pulleys, so reliability is increased dramatically with profiled end discs. In addition, bushing problems and shaft walking are reduced because loading stresses are distributed across a profiled end disc more efficiently.

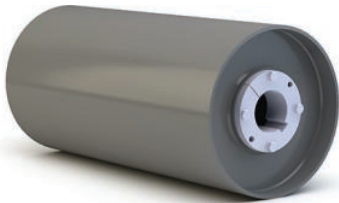

## HEAVY DUTY DRUM PULLEY

Steel rims, hubs and discs are fused into an integral component by a continuous submerged arc welded bond that maximizes pulley strength, balance and concentricity. The HDD is available with various hub and bushing systems.



## MINE DUTY DRUM PULLEY

PPI Mine Duty Drum pulleys incorporate heavier rims and end discs compared to HDD pulleys. Suited for more demanding applications, such as frequent starts and stops with a loaded belt or where increased reliability is desired.

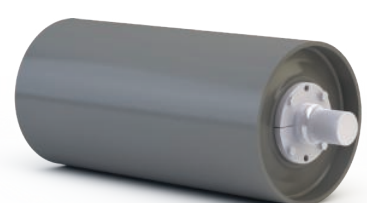

## ENGINEERED CLASS DRUM PULLEY

PPI Engineered Class pulleys are supplied with various hub and bushing systems including keyless locking devices which are common on high tension steel cable belt systems.

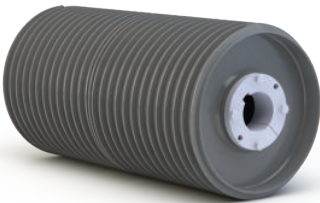

## SPIRAL DRUM PULLEY

The PPI Spiral Drum pulley is formed by a pair of vertical steel bars helically wound around a Heavy Duty Drum (HDD) pulley. This unique design is frequently used when additional cleaning action is desired without introducing additional belt vibration.

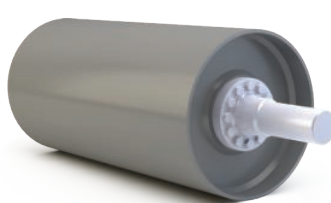

## EZ MOUNT PULLEY SYSTEM

EZ Mount is a unique pulley and shaft system that allows for fast and economical bearing and shaft replacement without removing the pulley from the conveyor reducing maintenance and replacement time by using rugged engineered stub shafts.

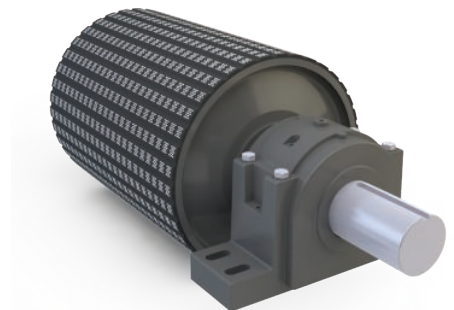

## TURBINE PULLEY

Today's efficient high tonnage mines demand dependable long life components. Using state of the art engineering and design techniques, such as Precision Finite Element Analysis, PPI meets these needs by controlling material stress points.

# WING CONVEYOR PULLEYS

## HERRINGBONE WING®

The PPI Herringbone Wing® was designed for those applications where conventional wings suffer from excessive material lodging and wing folding. The extreme wing angles of up to 45 degrees, use the rotation of the pulley to eject material out the sides of the pulley rather than recirculating it as a conventional wing often does. These extreme angles and optimized wing height, along with a center reinforcement disc, all combine to make an incredibly strong design that excels where others fail.

Also available in a CEMA version ideally suited for less demanding applications as well as with ContinuWing® technology for highly abrasive conditions.

## HEAVY DUTY WING PULLEY

The PPI Heavy Duty Wing is an all-steel construction including wings and gussets. It expels excessive build-up of material from the area of belt contact enhancing traction and reducing abrasion of both the belt and pulley. Where abrasion and excessive build-up conditions exist, the HDW pulley with self cleaning action provides an excellent alternative to conventional drum style pulleys. Available with various hub and bushing systems.

## MINE DUTY WING PULLEY

Demanding wing pulley applications call for PPI Mine Duty Wing pulleys. Mine Duty Wing pulleys provide effective self-cleaning action reducing material build-up. The extra heavy duty construction reduces the possibility of metal fatigue and enhances the dependability of the pulley. Ideally suited for harsh application and abrasive conditions.

## QUARRY MAX DUTY WING PULLEY

The Quarry Max Duty Wing pulley is made for severe applications where wing folding and abrasion issues are a concern. It has a massive contact bar and thick wings. The Quarry Max Duty Wing resists wing folding by utilizing an end disc when necessary to keep wing heights ideal, short enough to resist folding, long enough to provide adequate rigidity. Ideally suited for harsh applications and for very abrasive conditions.

Also available with ContinuWing® technology for abrasive conditions.

## SPIRAL AND SPIRAL PLUS WING PULLEY

The PPI Spiral Wing and Spiral Plus Wing pulleys are formed by winding flat bar spirally from the center of a wing pulley to the outside ends. This continuous belt contact design eliminates excessive noise and vibration, while still providing a cleaning effect and allowing a path for debris to escape rather than being trapped between the pulley and belt.

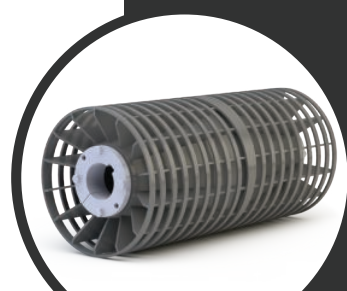
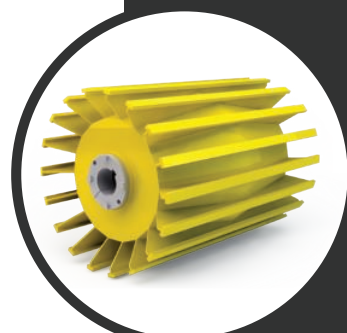
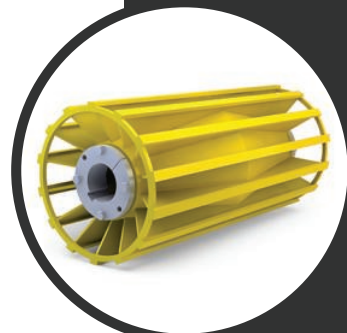
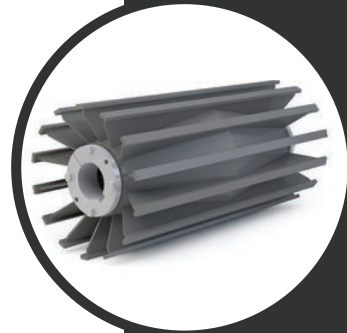

# SINGLE DISC AND GRAIN PULLEYS

## GRAIN HERRINGBONE WING CONVEYOR PULLEY

PPI's Grain Herringbone Wing combines improved wear, quieter operation and gentle grain handling compared to standard wing pulleys. It has more wings to support thin grain belting and it has rubber flappers to lift grain and throw it back on to the belt in enclosed conveyors.

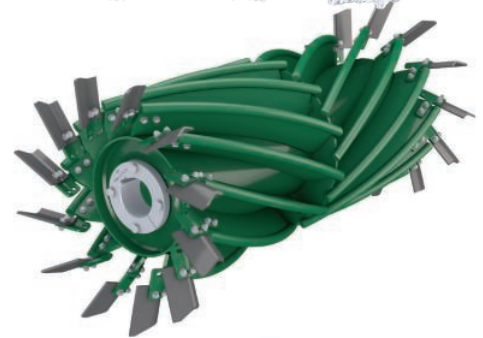

## BOOT HERRINGBONE WING CONVEYOR PULLEY

The patented PPI Boot Herringbone Wing pulley combines improved wear, quieter operation and gentle grain handling, along with a sensor ring for use with proximity or heat sensors.



## SINGLE DISC ELEVATOR PULLEY (SDE)

A continuous weld of the disc to the rim, coupled with heavy duty construction and a high compression hub and bushing, provides a one-piece, all-steel, single disc pulley capable of reducing stress and deflection.

Single Disc Elevator pulleys (SDE) are constructed with a standard crown face and XT hubs unless otherwise specified.

SDE pulleys are also available with other hub and bushing systems.

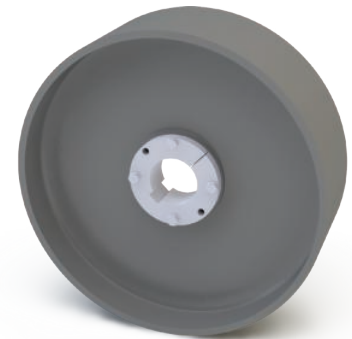

## BUSHING INSETS

HUB	FACE WIDTH					
	8	9	11	13	15	16
XT25	2 9/16	3 1/16	4 1/16	5 1/16	6 1/16	6 9/16
XT30	2 1/2	3	4	5	6	6 1/2
XT35	2 1/4	2 3/4	3 3/4	4 3/4	5 3/4	6 1/4
XT40	2 1/8	2 5/8	3 5/8	4 5/8	5 5/8	6 1/8
XT45	2	2 1/2	3 1/2	4 1/2	5 1/2	6
XT50	1 3/4	2 1/4	3 1/4	4 1/4	5 1/4	5 3/4
SF	2 1/2	3	4	5	6	6 1/2
E	2	2 1/2	3 1/2	4 1/2	5 1/2	6
F	1 3/4	2 1/4	3 1/4	4 1/4	5 1/4	5 3/4
JS	1 5/8	2 1/8	3 1/8	4 1/8	5 1/8	5 5/8
MS	1 3/8	1 7/8	2 7/8	3 7/8	4 7/8	5 3/8
MP	1 1/8	1 5/8	2 5/8	3 5/8	4 5/8	5 1/8



# LAGGING FOR DRUM CONVEYOR PULLEYS

PPI has complete in-house pulley lagging capabilities. Every step of the pulley manufacturing and lagging process is controlled internally, which assures quality, prompt delivery and competitive pricing of lagged pulleys. Available in a wide variety of styles and thicknesses, lagging is primarily used to improve traction capacity, resist abrasive conditions and extend pulley and belt life. The style of lagging required is usually influenced by operating conditions. While the standard is 60 durometer, it is available in various durometers, with 45 and 70 being common alternates. SBR is standard; Neoprene and MSHA are available as well as a wide variety of other compounds.

Other lagging is available for specific applications. An example of this is rougtop lagging. This is used for small diameter drive pulleys. It is created by lagging the pulley, but before the rubber is cured, a special mold is applied to cause the grooves to be formed in the lagging. It is then cured with this form in place. It gives excellent traction, without cutting grooves. By forming the groove in the lagging, PPI can offer rougtop on thin lagging, such as 1/4". Consult the factory for your specific requirements.



## HERRINGBONE GROOVE LAGGING (HBG)

The style of lagging required is usually influenced by operating conditions. This style grooving is where the points do not meet in the middle. This is normally used in drive pulleys, with the V pointing in the direction of rotation. (3/8" minimum thickness)

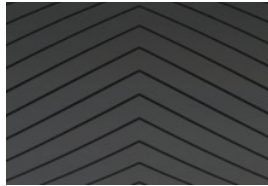

## CHEVRON GROOVE LAGGING (CHE)

Based on preference Chevron Groove lagging is available. Providing the same functionality as Herringbone groove lagging. (3/8" minimum thickness)



## DIAMOND GROOVE LAGGING (DIA)

Diamond, or double HBG, or double chevron is primarily used for reversing conveyor drive pulleys. It is also often used for spare pulleys when direction of rotation has not yet been identified. (3/8" minimum thickness)



## CIRCUMFERENTIAL GROOVE LAGGING (CIR)

Used on non drive pulleys in very wet applications or cold temperatures. It allows the lagging to deflect, keeping material from building up on the lagging. (3/8" minimum thickness)



## ALIGNER GROOVE LAGGING (LOR)

This is a Lorig style lagging. Lorig is used on flat face pulleys, the lagging is machined flat, then grooves are machined in at an angle. This results in a training action. As the rubber is compressed by the belt, the lagging will deflect towards the center, helping to track the belt. (3/4" normal thickness)

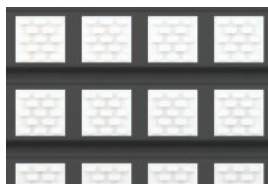

## CERAMIC LAGGING

Ceramic lagging is ceramic tiles molded into a rubber compound. Providing for excellent traction, reducing slippage and offering excellent abrasion resistance.

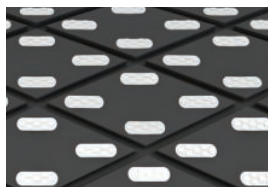

## VULCANIZED ENGINEERED CERAMIC LAGGING (VEC)

Our patented VEC lagging starts with SBR or Neoprene lagging that is hot vulcanized on a pulley. Our uniquely designed tiles are then embedded in the vulcanized lagging. This design eliminates seams, where failures often start. This process allows flexibility in tile coverage and grooving patterns.



## FIELD REPLACEABLE LAGGING

PPI offers three different options for lagging that can be replaced in the field ideal for areas where pulley removal is difficult. EZ Lag and Craft-lag is for drum pulleys and Fas Lag is for wing pulleys.

# LAGGING FOR DRUM CONVEYOR PULLEYS

LAGGING COMPOUND			CHEMICAL RESISTANCE PROPERTIES						REMARKS
Material	Shore A Duro ±5	Color	Oil & Gas	Animal/ Vegetable Oils	Alcohols	Alkalies	Acids	Oxygen Solvent	
SBR	45, 60, 70, 80, 90	BLACK	D	C	B	C	C+	B	Low Cost
NEOPRENE	45*, 60*, 75, 85	BLACK	C+	B	B+	A	B	D+	Grain & MSHA
URETHANE	45, 60, 90	RED	B+	B	C+	D	D+	D	Low Temp
ABRASION RESISTANT	60	BLACK	D	C	B	C	C+	B	Abrasion Resistant
NITRILE	45, 60	BLACK	B+	B+	C+	B+	B	D	Oil Resistant
EPDM	60-BLK, 70-WHT	BLK/WHT	D	B	C+	B+	B	B+	High Temperature
NATURAL	60, 70-BLK/60-WHT	BLK/WHT	D	C	B	C	C+	B	
NEOPRENE (FDA)	60	WHITE	C+	B	B+	A	B	D+	Food Service
NITRILE (FDA)	50, 90	WHITE	B+	B+	C+	B+	B	D	Food Service
HYPALON	60	BLACK	C	B	A	B+	B+	B	

LAGGING COMPOUND			ENVIRONMENTAL RESISTANCE PROPERTIES						
Material	Shore A Duro ±5	Color	Oxidation	Ozone	Weathering	Sunlight	Water	Flame	Heat
SBR	45, 60, 70, 80, 90	BLACK	C+	D	C	C	B+	D	C+
NEOPRENE	45*, 60*, 75, 85	BLACK	B+	B	B	B+	B	B*	C+
URETHANE	45, 60, 90	RED	B+	A	B+	B+	B	D+	C+
ABRASION RESISTANT	60	BLACK	C+	D	C	C	B+	D	C+
NITRILE	45, 60	BLACK	C+	D	C+	D+	B+	D	B
EPDM	60-BLK, 70-WHT	BLK/WHT	B+	A	A	A	A	D	B+
NATURAL	60, 70-BLK/60-WHT	BLK/WHT	C+	D	C	D+	A	D	C
NEOPRENE (FDA)	60	WHITE	B+	B	B	B+	B	B	C+
NITRILE (FDA)	50, 90	WHITE	C+	D	C+	D+	B+	D	B
HYPALON	60	BLACK	A	A	A	A	B	B+	B+

LAGGING COMPOUND			PHYSICAL PROPERTIES					REMARKS
Material	Shore A Duro ±5	Color	Min Tensile Str. (Psi)	Elongation	Max Temp	Min Temp	300% Mod (Psi)	
SBR	45	BLACK	1400	500%	225 F	-50 F	400	Cost Effective
	60		1825	450%			1100	
	70		2000	400%			1400	
	80		2400	400%			N/A	
	90		N/A	N/A			N/A	
NEOPRENE	45*	BLACK	1500	400%	212 F	-50 F	450	Grain & MSHA
	60*		1800	350%			1100	
	75		1850	290%			N/A	
	85		1600	200%			1175	
URETHANE	45	RED	1960	710%	225 F	-40 F	310	Cold Temperatures
	60		2770	570%			1330	
	90		4700	450%			2100	
ABRASION RESISTANT	60	BLACK	1325	450%	200 F	-40 F	600	--
NITRILE	45	BLACK	1210	840%	250 F	-40 F	190	Oil Resistant
	60		1870	690%			390	
EPDM	60	BLACK	1500	450%	300 F	-40 F	350	Heat Resistant
	70	WHITE	1080	520%			500	
NATURAL	60	BLACK	3000	450%	180 F	-45 F	1000	--
	70		1470	330%			1310	
NEOPRENE (FDA)	60	WHITE	1200	600%	212 F	-50 F	375	Food Grade
NITRILE (FDA)	50	WHITE	N/A	N/A	250 F	-40 F	N/A	Food Grade
	90		N/A	N/A			N/A	
HYPALON-CSM	60	BLACK	1700	570%	225 F	-40 F	650	--

\* Requires a stamp for MSHA approval.

Use a static conductive lagging in all applications with grain or material.

# XT® HUBS & BUSHINGS

XT® Hubs & Bushings were computer-designed and specifically developed for conveyor pulley applications. This design utilizes a tapered bore bushing that provides all the holding power needed for conveyor pulleys and allows easier installation and removal than other bushing types.

- Designed for conveyor pulley applications
- 2" per foot taper
- Self-seating – no need to hammer bushing in
- Less axial movement – reduces end disc stress and seats quicker
- High clamping force eliminates the need for keyway on non-drives
- Bolts equally spaced for even draw-up
- More material in the barrel
- Full-length hub engagement
- Flange deflection stores up capscrew torque for seating while running
- Easy removal
- Full-size keys in max bores for size 50 and larger

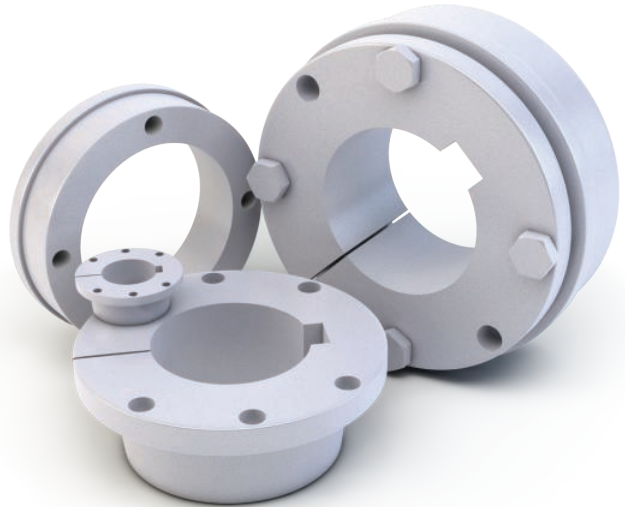

PPI offers the XT® with larger hub diameters and longer hubs for greater load capacity.

PPI has found that the XT® taper and heavy barrel are best suited to our design philosophy and recommends them for pulley hub usages. For metric key sizes, please see our website at [www.ppi-global.com](http://www.ppi-global.com).

HUB	MAX BORE	HUB DIMENSION					Bushings Inset (E)	BUSHING DIMENSION					
		Outside Diameter (A)	Minor Outside Diameter (B)	Flange Thickness (C)	Length (D)	Length (F)		Flange Thickness (G)	Flange Outside Diameter (H)	Bolt Circle (J)	# Bolts	Bolt diameter	Torque (in lbs)
XT15	1.5	3 1/4	2 7/8	1/4	3/4	7/16	1 1/8	3/8	2 7/8	2 7/16	4	1/4	95
XT20	2	4 1/8	3 3/4	1/4	7/8	9/16	1 1/2	15/32	3 3/4	3 3/16	4	5/16	200
XT25	2.5	4 3/4	4 1/2	5/16	1 1/4	3/8	1 7/8	5/8	4 7/16	3 3/4	4	3/8	350
XT30	3	6	5 3/4	3/8	1 1/2	7/16	2 1/16	11/16	5 5/16	4 9/16	4	7/16	550
XT35	3.5	6 3/4	6 1/2	3/8	1 3/4	9/16	2 1/2	25/32	6 5/16	5 7/16	4	1/2	840
XT40	4	7 3/4	7 1/2	1/2	1 7/8	13/16	2 13/16	7/8	7 1/8	6 1/8	4	9/16	1,200
XT45	4.5	8 1/4	8	1/2	2 1/8	15/16	3 5/16	15/16	8	6 7/8	4	5/8	1,680
XT50	5	10 1/4	9 7/8	5/8	2 3/8	7/8	3 3/4	1	10 1/8	8 5/16	4	3/4	3,000
XT60	6	11 7/8	11 1/2	13/16	2 7/8	13/16	4 1/8	1 1/8	11 15/16	9 7/8	4	7/8	4,800
XT70	7	13 7/8	13 1/2	15/16	3 1/8	1	4 11/16	1 5/16	13 15/16	11 9/16	4	1	7,200
XT80	8	15 1/4	14 3/4	1	3 5/8	1 1/16	5 1/8	1 3/8	15 5/8	12 7/8	4	1 1/8	9,000
XT100	10	18	17 1/2	1 1/8	4 1/8	1 1/8	6 3/16	1 9/16	17 15/16	15 9/16	6	1 1/8	9,000
XT120	12	21	20 1/2	1 5/16	4 7/8	7/8	7 1/16	1 3/4	20 5/8	18 3/16	8	1 1/8	9,000



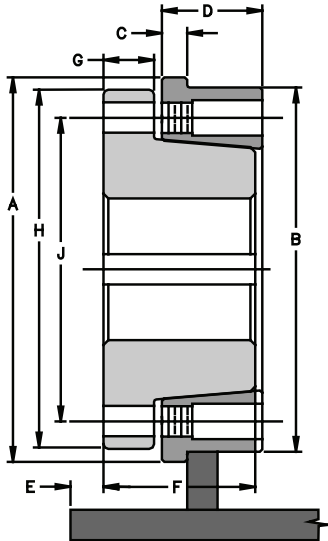

- Keys are provided for shaded cells only (non-standard key sizes)
- Subject to change without notice
- Unshaded key sizes are FULL depth keys
- For metric key sizes, please go to [www.ppi-global.com](http://www.ppi-global.com)

## X250207

XT Bushing type ——— Shaft size in sixteenths of an inch

XT Bushing size ——— Shaft size in inches

15, 20, 25, 30, 35, 40, 45, 50, 60, 70, 80,  
10 for 100, 12 for 120

HUB	BORE RANGE	KEYWAY		KEYSTOCK
		Shaft	Bushing	
XT15	1/2-9/16	1/8 x 1/16	1/8 x 1/16	1/8 x 1/8
	5/8-7/8	3/16 x 3/32	3/16 x 3/32	3/16 x 3/16
	15/16 - 1 1/4	1/4 x 1/8	1/4 x 1/8	1/4 x 1/4
	1 5/16 - 1 3/8	5/16 x 5/32	5/16 x 5/32	5/16 x 5/16
	1 7/16 - 1 1/2	3/8 x 3/16	3/8 x 1/8	3/8 x 5/16
XT20	3/4-7/8	3/16 x 3/32	3/16 x 3/32	3/16 x 3/16
	15/16 - 1 1/4	1/4 x 1/8	1/4 x 1/8	1/4 x 1/4
	1 5/16 - 1 3/8	5/16 x 5/32	5/16 x 5/32	5/16 x 5/16
	1 7/16 - 1 3/4	3/8 x 3/16	3/8 x 3/16	3/8 x 3/8
	1 13/16 - 2	1/2 x 1/4	1/2 x 3/16	1/2 x 7/16
XT25	1 - 1 1/4	1/4 x 1/8	1/4 x 1/8	1/4 x 1/4
	1 5/16 - 1 3/8	5/16 x 5/32	5/16 x 5/32	5/16 x 5/16
	1 7/16 - 1 3/4	3/8 x 3/16	3/8 x 3/16	3/8 x 3/8
	1 13/16 - 2 1/4	1/2 x 1/4	1/2 x 1/4	1/2 x 1/2
	2 5/16 - 2 1/2	5/8 x 5/16	5/8 x 1/8	5/8 x 7/16
XT30	1 7/16 - 1 3/4	3/8 x 3/16	3/8 x 3/16	3/8 x 3/8
	1 13/16 - 2 1/4	1/2 x 1/4	1/2 x 1/4	1/2 x 1/2
	2 5/16 - 2 3/4	5/8 x 5/16	5/8 x 5/16	5/8 x 5/8
	2 13/16 - 3	3/4 x 3/8	3/4 x 3/16	3/4 x 9/16
XT35	1 15/16 - 2 1/4	1/2 x 1/4	1/2 x 1/4	1/2 x 1/2
	2 5/16 - 2 3/4	5/8 x 5/16	5/8 x 5/16	5/8 x 5/8
	2 13/16 - 3 1/4	3/4 x 3/8	3/4 x 3/8	3/4 x 3/4
	3 5/16 - 3 3/8	7/8 x 7/16	7/8 x 7/16	7/8 x 7/8
	3 7/16 - 3 1/2	7/8 x 7/16	7/8 x 5/16	7/8 x 3/4
XT40	2 7/16 - 2 3/4	5/8 x 5/16	5/8 x 5/16	5/8 x 5/8
	2 13/16 - 3 1/4	3/4 x 3/8	3/4 x 3/8	3/4 x 3/4
	3 5/16 - 3 3/4	7/8 x 7/16	7/8 x 7/16	7/8 x 7/8
	3 13/16	1 x 1/2	1 x 1/2	1 x 1
	3 7/8 - 4	1 x 1/2	1 x 3/8	1 x 7/8

HUB	BORE RANGE	KEYWAY		KEYSTOCK
		Shaft	Bushing	
XT45	2 7/16 - 2 3/4	5/8 x 5/16	5/8 x 5/16	5/8 x 5/8
	2 13/16 - 3 1/4	3/4 x 3/8	3/4 x 3/8	3/4 x 3/4
	3 5/16 - 3 3/4	7/8 x 7/16	7/8 x 7/16	7/8 x 7/8
	3 13/16 - 4 5/16	1 x 1/2	1 x 1/2	1 x 1
	4 3/8 - 4 1/2	1 x 1/2	1 x 3/8	1 x 7/8
XT50	2 15/16 - 3 1/4	3/4 x 3/8	3/4 x 3/8	3/4 x 3/4
	3 5/16 - 3 3/4	7/8 x 7/16	7/8 x 7/16	7/8 x 7/8
	3 13/16 - 4 1/2	1 x 1/2	1 x 1/2	1 x 1
	4 9/16 - 5	1 1/4 x 5/8	1 1/4 x 5/8	1 1/4 x 1 1/4
XT60	3 7/16 - 3 3/4	7/8 x 7/16	7/8 x 7/16	7/8 x 7/8
	3 13/16 - 4 1/2	1 x 1/2	1 x 1/2	1 x 1
	4 9/16 - 5 1/2	1 1/4 x 5/8	1 1/4 x 5/8	1 1/4 x 1 1/4
	5 9/16 - 6	1 1/2 x 3/4	1 1/2 x 3/4	1 1/2 x 1 1/2
XT70	4 15/16 - 5 1/2	1 1/4 x 5/8	1 1/4 x 5/8	1 1/4 x 1 1/4
	5 9/16 - 6 1/2	1 1/2 x 3/4	1 1/2 x 3/4	1 1/2 x 1 1/2
	6 9/16 - 7	1 3/4 x 3/4	1 3/4 x 3/4	1 3/4 x 1 1/2
XT80	4 15/16 - 5 1/2	1 1/4 x 5/8	1 1/4 x 5/8	1 1/4 x 1 1/4
	5 9/16 - 6 1/2	1 1/2 x 3/4	1 1/2 x 3/4	1 1/2 x 1 1/2
	6 9/16 - 7 1/2	1 3/4 x 3/4	1 3/4 x 3/4	1 3/4 x 1 1/2
	7 9/16 - 8	2 x 3/4	2 x 3/4	2 x 1 1/2
XT100	6 9/16 - 7 1/2	1 3/4 x 3/4	1 3/4 x 3/4	1 3/4 x 1 1/2
	7 9/16 - 9	2 x 3/4	2 x 3/4	2 x 1 1/2
	9 1/16 - 10	2 1/2 x 7/8	2 1/2 x 7/8	2 1/2 x 1 3/4
XT120	8 7/16 - 9	2 x 3/4	2 x 3/4	2 x 1 1/2
	9 1/16 - 11	2 1/2 x 7/8	2 1/2 x 7/8	2 1/2 x 1 3/4
	11 1/16 - 12	3 x 1	3 x 1	3 x 2

# QD® HUBS & BUSHINGS

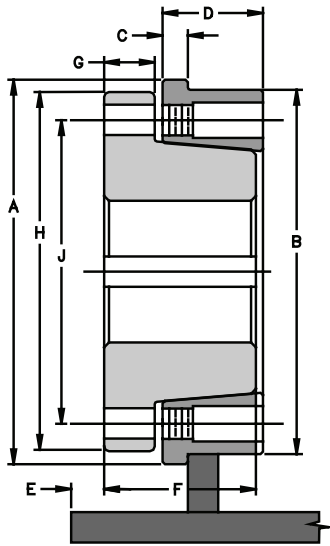

QD® has a primary benefit of bushing interchangeability with other shaft mounted components. Its shallow taper provides a high mechanical advantage to assure dependable clamping to the shaft.

- Designed for a wide variety of applications
- 3/4" per foot taper - self-seating
- High clamping force eliminates the need for keyway on non-drives
- Flange deflection stores up capscrew torque for seating while running

HUB	MAX BORE*	HUB DIMENSION				Bushing Inset (E)	BUSHING						
		Outside Diameter (A)	Minor Outside Diameter (B)	Flange Thickness (C)	Length (D)		Length (F)	Flange Thickness (G)	Flange Outside Diameter (H)	Bolt Circle (J)	# Bolts	Bolt Diameter	Torque (in lbs)
SH	1.44	3	2 7/8	1/4	7/8	9/16	1 5/16	7/16	2 5/8	2 1/4	3	1/4	108
SDS	2.00	3 1/2	3 1/4	1/4	3/4	9/16	1 5/16	7/16	3 1/8	2 11/16	3	1/4	108
SK	2.25	4 1/2	4 3/8	3/8	1 1/4	3/8	1 15/16	9/16	3 7/8	3 5/16	3	5/16	200
SF	2.50	4 3/4	4 1/2	5/16	1 1/4	1/2	2 1/16	5/8	4 5/8	3 7/8	3	3/8	360
E	3.00	6	5 3/4	3/8	1 1/2	7/16	2 3/4	7/8	6	5	3	1/2	720
F	3.50	6 3/4	6 1/2	3/8	1 3/4	3/4	3 3/4	1	6 5/8	5 5/8	3	9/16	900
JS	4.00	7 3/4	7 1/2	1/2	1 7/8	11/16	3 3/8	1	7 1/4	6 1/4	3	5/8	1,620
MS	4.50	9 1/2	9 1/4	1/2	2 1/8	3/4	4 13/16	1 3/16	9	7 7/8	4	3/4	2,700
NS	5.00	10 1/4	10	5/8	2 3/8	1	6	1 1/2	10	8 1/2	4	7/8	3,600
PS	6.00	12 1/4	12	7/8	3 1/8	13/16	6 1/2	1 1/2	11 3/4	10	4	1	5,400
WS	8.00	15 1/4	14 3/4	15/16	3 5/8	1 5/16	7 1/4	1 3/4	15	12 3/4	4	1 1/8	7,200

\*Max bore of QD hubs is the maximum recommended for 2 hub assemblies, such as conveyor pulleys

- Keys are provided for shaded cells only, (non-standard key sizes)
- Subject to change without notice
- Unshaded key sizes are FULL depth keys
- For metric key sizes, please go to [www.ppi-global.com](http://www.ppi-global.com)

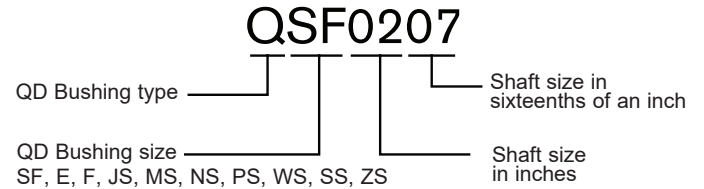

HUB	BORE RANGE	KEYWAY		KEYSTOCK
		Shaft	Bushing	
SH	1/2-9/16	1/8 x 1/16	1/8 x 1/16	1/8 x 1/8
	5/8-7/8	3/16 x 3/32	3/16 x 3/32	3/16 x 3/16
	15/16 - 1 1/4	1/4 x 1/8	1/4 x 1/8	1/4 x 1/4
	1 5/16 - 1 3/8	5/16 x 5/32	5/16 x 5/32	5/16 x 5/16
	1 7/16 - 1 5/8	3/8 x 3/16	3/8 x 1/16	3/8 x 1/4
	1 11/16	NONE	NONE	NONE
SDS	1/2-9/16	1/8 x 1/16	1/8 x 1/16	1/8 x 1/8
	5/8-7/8	3/16 x 3/32	3/16 x 3/32	3/16 x 3/16
	15/16 - 1 1/4	1/4 x 1/8	1/4 x 1/8	1/4 x 1/4
	1 5/16 - 1 3/8	5/16 x 5/32	5/16 x 5/32	5/16 x 5/16
	1 7/16 - 1 5/8	3/8 x 3/16	3/8 x 3/16	3/8 x 3/8
	1 11/16 - 1 3/4	3/8 x 3/16	3/8 x 1/8	3/8 x 5/16
SK	1 13/16 - 2	NONE	NONE	NONE
	1/2-9/16	1/8 x 1/16	1/8 x 1/16	1/8 x 1/8
	5/8-7/8	3/16 x 3/32	3/16 x 3/32	3/16 x 3/16
	15/16 - 1 1/4	1/4 x 1/8	1/4 x 1/8	1/4 x 1/4
	1 5/16 - 1 3/8	5/16 x 5/32	5/16 x 5/32	5/16 x 5/16
	1 7/16 - 1 3/4	3/8 x 3/16	3/8 x 3/16	3/8 x 3/8
	1 13/16 - 2 1/8	1/2 x 1/4	1/2 x 1/4	1/2 x 1/2
	2 3/16 - 2 1/4	1/2 x 1/4	1/2 x 1/8	1/2 x 3/8
	2 5/16 - 2 1/2	5/8 x 5/16	5/8 x 1/16	5/8 x 3/8
	2 9/16 - 2 5/8	NONE	NONE	NONE
SF	15/16 - 1 1/4	1/4 x 1/8	1/4 x 1/8	1/4 x 1/4
	1 5/16 - 1 3/8	5/16 x 5/32	5/16 x 5/32	5/16 x 5/16
	1 7/16 - 1 3/4	3/8 x 3/16	3/8 x 3/16	3/8 x 3/8
	1 13/16 - 2 1/4	1/2 x 1/4	1/2 x 1/4	1/2 x 1/2
	2 5/16	5/8 x 5/16	5/8 x 5/16	5/8 x 5/8
	2 3/8 - 2 1/2	5/8 x 5/16	5/8 x 3/16	5/8 x 1/2
	2 9/16 - 2 3/4	5/8 x 5/16	5/8 x 1/16	5/8 x 3/8
	2 13/16 - 2 15/16	NONE	NONE	NONE
	1 5/16 - 1 3/8	5/16 x 5/32	5/16 x 5/32	5/16 x 5/16
	1 7/16 - 1 3/4	3/8 x 3/16	3/8 x 3/16	3/8 x 3/8
E	1 13/16 - 2 1/4	1/2 x 1/4	1/2 x 1/4	1/2 x 1/2
	2 5/16 - 2 3/4	5/8 x 5/16	5/8 x 5/16	5/8 x 5/8
	2 13/16 - 2 7/8	3/4 x 3/8	3/4 x 3/8	3/4 x 3/4
	2 15/16 - 3 1/4	3/4 x 3/8	3/4 x 1/8	3/4 x 1/2
	3 5/16 - 3 1/2	NONE	NONE	NONE

HUB	BORE RANGE	KEYWAY		KEYSTOCK
		Shaft	Bushing	
F	1 13/16 - 2 1/4	1/2 x 1/4	1/2 x 1/4	1/2 x 1/2
	2 5/16 - 2 3/4	5/8 x 5/16	5/8 x 5/16	5/8 x 5/8
	2 13/16 - 3 1/4	3/4 x 3/8	3/4 x 3/8	3/4 x 3/4
	3 5/16 - 3 3/4	7/8 x 7/16	7/8 x 3/16	7/8 x 5/8
	3 13/16 - 4	NONE	NONE	NONE
JS	2 13/16 - 3 1/4	3/4 x 3/8	3/4 x 3/8	3/4 x 3/4
	3 5/16 - 3 3/4	7/8 x 7/16	7/8 x 7/16	7/8 x 7/8
	3 13/16	1 x 1/2	1 x 1/2	1 x 1
	3 7/8 - 4	1 x 1/2	1 x 1/4	1 x 3/4
MS	4 1/16 - 4 1/2	1 x 1/2	1 x 1/8	1 x 5/8
	2 13/16 - 3 1/4	3/4 x 3/8	3/4 x 3/8	3/4 x 3/4
	3 5/16 - 3 3/4	7/8 x 7/16	7/8 x 7/16	7/8 x 7/8
	3 13/16 - 4 1/2	1 x 1/2	1 x 1/2	1 x 1
	4 9/16 - 4 3/4	1 1/4 x 5/8	1 1/4 x 5/8	1 1/4 x 1 1/4
NS	4 13/16 - 5 1/4	1 1/4 x 5/8	1 1/4 x 3/8	1 1/4 x 1
	5 5/16 - 5 1/2	1 1/4 x 5/8	1 1/4 x 1/4	1 1/4 x 7/8
	3 5/16 - 3 3/4	7/8 x 7/16	7/8 x 7/16	7/8 x 7/8
	3 13/16 - 4 1/2	1 x 1/2	1 x 1/2	1 x 1
	4 9/16 - 5 1/4	1 1/4 x 5/8	1 1/4 x 5/8	1 1/4 x 1 1/4
PS	5 5/16 - 5 1/2	1 1/4 x 5/8	1 1/4 x 3/8	1 1/4 x 1
	5 9/16 - 6	1 1/2 x 3/4	1 1/2 x 1/4	1 1/2 x 1
	3 13/16 - 4 1/2	1 x 1/2	1 x 1/2	1 x 1
	4 9/16 - 5 1/2	1 1/4 x 5/8	1 1/4 x 5/8	1 1/4 x 1 1/4
WS	5 9/16 - 6 1/4	1 1/2 x 3/4	1 1/2 x 3/4	1 1/2 x 1 1/2
	6 5/16-6 1/2	1 1/2 x 3/4	1 1/2 x 1/2	1 1/2 x 1 1/4
	6 9/16-7	1 3/4 x 3/4	1 3/4 x 1/4	1 3/4 x 1
	5 9/16 - 6 1/2	1 1/2 x 3/4	1 1/2 x 3/4	1 1/2 x 1 1/2
	6 9/16 - 7 1/2	1 3/4 x 3/4	1 3/4 x 3/4	1 3/4 x 1 1/2
WS	7 9/16 - 8 1/8	2 x 3/4	2 x 3/4	2 x 1 1/2
	8 3/16 - 8 1/2	2 x 3/4	2 x 1/4	2 x 1



# KEYLESS LOCKING ASSEMBLIES

The standard in keyless locking assemblies is the RBL, it is self-centering, and no pilot bushing is needed. The single taper design is better able to handle the bending moment present in pulley applications. For high-tension applications, PPI recommends the RBM and the RBH. The graphic shows the relative difference in size and bending moment for each series.

The chart to the right gives a range of standard sizes and the relative torque ratings. This is a representation of the sizes that are commonly available. Nominal inch as well as metric sizes are also available for shaft sizes under 8 inch.

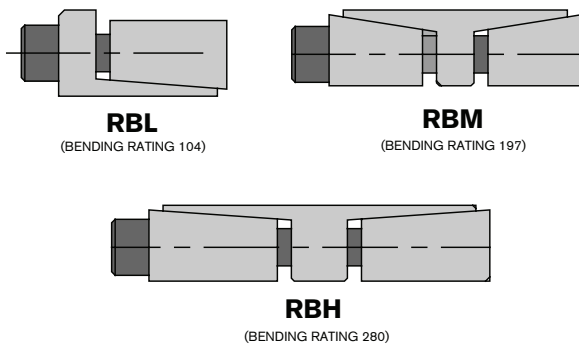

KEYLESS LOCKING ASSEMBLY TORQUE RATINGS

METRIC SIZE (mm)	ENGLISH SIZE (in)	RBL	RBM	RBH
25	1	308		
30	1 3/16	370		
35	1 3/8	576		
40	1 1/2	658		
45	1 3/4	1,196		
50	1 15/16	1,329		
55	2 3/16	1,671		
60	2 3/8	1,823		
65	2 9/16	2,222		
70	2 3/4	3,377		
75	2 15/16	3,618		
80	3	3,859		
85	3 3/8	4,613		
90	3 7/16	4,885		
95	3 3/4	5,729		
100	3 15/16	7,024	13,516	
110	4 7/16	7,726	14,868	
120	4 3/4	9,482	17,842	
130	4 15/16	14,095	24,600	
140	5 7/16	15,179	28,384	47,224
150	5 15/16	18,070	30,412	54,211
160		21,202	34,602	61,680
170	6 7/16	24,576	47,291	79,695
180	6 15/16	26,021	50,073	90,410
190	7 7/16	34,333	56,378	101,795
200	7 7/8	36,140	66,764	107,153
220	8.661	44,201	85,055	132,602
240	9.449	60,273	123,717	160,729
260	10.236	78,355	140,728	182,829
280	11.024	90,252	168,979	263,439
300	11.811	108,786	181,049	313,618
320	12.598	150,537	257,492	351,252
340	13.386	186,603	273,586	390,977
360	14.173	210,810	360,590	491,890
380	14.961	259,609	380,623	543,942
400	15.748	273,272	440,721	624,622
420	16.535		504,826	655,853
440	17.323		528,865	687,084
460	18.11		552,904	718,316
480	18.898		600,983	874,471
500	19.685		626,024	910,907
520	20.472		729,193	1,015,011
540	21.26		757,239	1,054,050
560	22.047		841,376	1,165,962
580	22.835		871,425	1,207,603
600	23.622		901,475	1,288,283

LOCKING ASSEMBLY	ALLOWABLE BENDING MOMENT
RBL	28%
RBM	32%
RBH	35%

- Allowable bending moment as a percentage of torque rating of the locking assembly
- Shaft diameters below 8 inch are usually available in nominal inch sizes
- This is a partial list of available series and sizes

PPI HUB	COMPATIBLE LOCKING ASSEMBLIES
RBL	B-LOC 106 • MAV 1061 • RFN 7006
RBM	B-LOC 115 • MAV 1008 • RFN 7009
RBH	B-LOC 112 • MAV 4061 • RFN 7005

# STATIC SHAFT PULLEY AND OTHER HUB STYLES

- Static shaft for increased reliability
- Standard spherical bearing
- Self-aligning bearing transfers load to the shaft
- Self-aligning bearing does not transfer bending load into the pulley
- Reduces bending stress on critical weld joints
- Bearing is protected by dual contact seals
- Stationary grease fittings
- Maintenance-friendly hub bolts with back-out holes
- Welded steel mounting blocks
- Standard mounting pattern for drop-in replacement
- Available in various pulley styles for non-drive, non-brake, non-backstop pulley locations
- For other sizes and styles contact your local PPI Representative

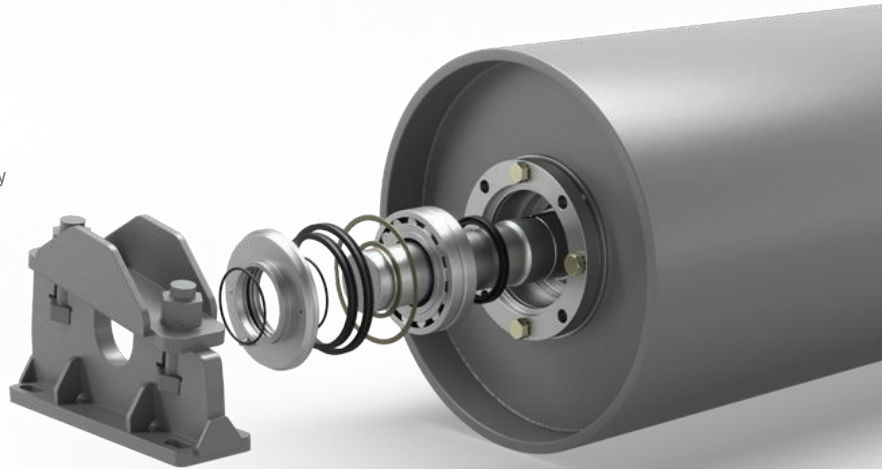

SIZE	BORE	SIZE	BORE
015	2.953	034	6.693
020	3.937	036	7.087
022	4.331	038	7.48
024	4.724	044	8.661
026	5.118	148	9.449
028	5.512	152	10.236
030	5.906	156	11.024
032	6.299	160	11.811

PPI offers several other styles to fit your particular needs. These include, but are not limited to, Press Fit (interference fit with keyway), Fixed Bore (solid bore, clearance fit with keyway and setscrews), and Weld-in (no hub, welded to the shaft). For more information on these and other means of attaching a pulley to a shaft, contact your local PPI representative.

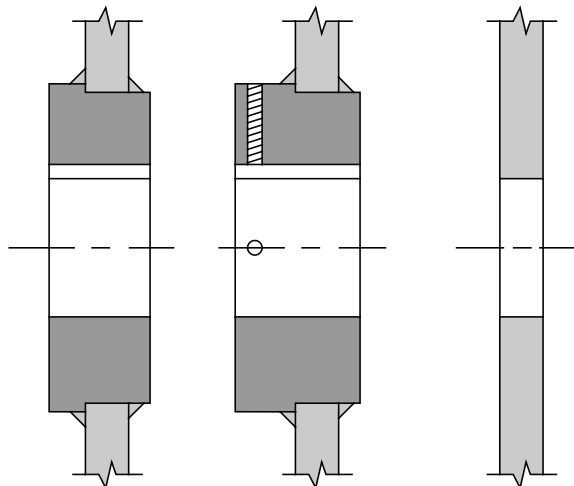

# SHAFTING & SHAFT ORDERING DETAIL

PPI conveyor pulley shafting is a vital part of the total pulley assembly. Standard PPI shafting is AISI 1045, which represents the higher carbon range in the open hearth carbon group. Excluding alloy steel, higher carbon content in a AISI 1045 results in one of the strongest steels in the carbon range and machines to a smooth finish. Normally, PPI uses T&P for shafting up through 5-15/16 inches. While hot rolled and/or forged shafting (depending upon size, availability, and specifications) is used above a 6" diameter.

Other materials, including 1018 (used for welding compatibility), 4140, and 4340 (normally used for high stressed areas, such as drive extensions) are available upon request.

Shafting can be keyed or journaled to meet any specification.

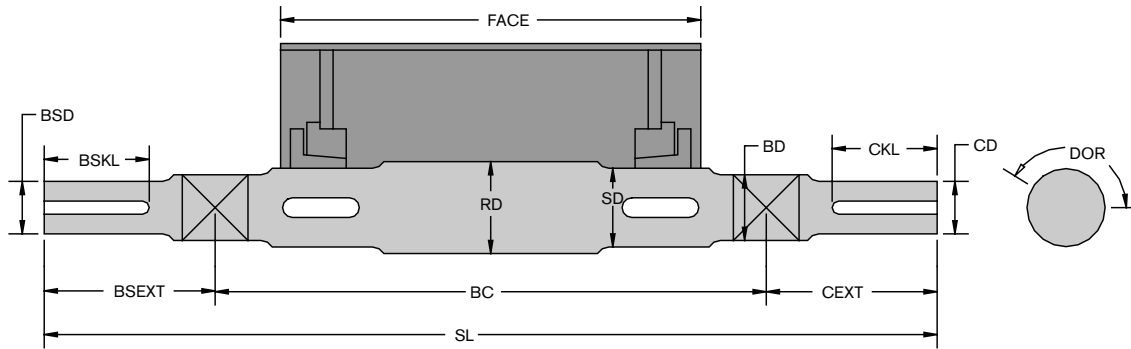
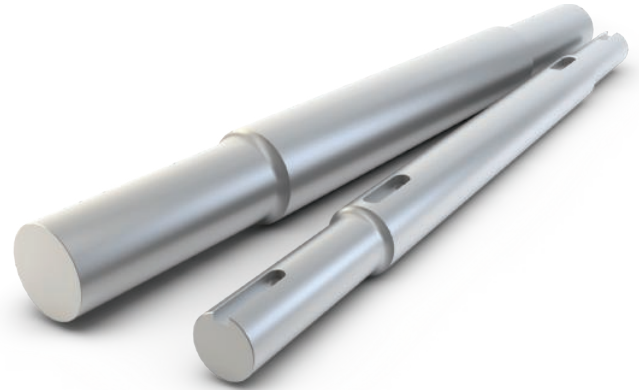

PULLEY ID	IDENTIFICATION				
QTY	Quantity				
OD	Outside Diameter without lagging				
Face	Face Width				
Style	CF / FF				
Lagging	Type				
Type	Wing/Drum				
SL	Shaft Length				
RD	Rough Diameter				
SD	Shaft Diameter				
BD	Bearing Diameter				
BC	Bearing Center				
Drive?	If not, skip rest				
CD	Coupling Diameter				
CEXT	Extension				
CKL	Key Length				
CKW	Key Size				
BSD	BackStop Diameter				
BSEXT	Extension				
BSKL	Key Length				
BSKW	Key Size				



# PULLEY AND SHAFT ENGINEERING INFORMATION

- Determine effective tension that is supplied by the motor.**  $T_e = HP * 33,000 / FPM$ .
- Determine slack side tension.** Using the K-factor from Table 1, multiply the effective tension ( $T_e$ ) by K to determine the slack side tension  $T_2 = T_e \times K$ .  
  
This is the minimum  $T_2$  tension. You may have to add an additional safety factor depending upon your application or how you tension your belt, i.e. wire rope/screw/etc.
- Determine  $T_1$  or tight side tension.**  
 $T_1 = T_2 + T_e$   
(for dual drives, add the primary  $T_e$  to the intermediate tension).
- Determine the angle of wrap for each pulley.**  
If unknown, use 180 for tail, take-up, and un-snubbed drives. Use 210 for snubbed drives, 30 for snubs and 90 + the incline angle for bend pulleys.
- To determine the resultant load on non-drive pulleys,** multiply the belt tension at that pulley by the resultant load factor in Table 2 for that pulley wrap. Then  $R = T_2 \times \text{Factor}$ .
- For Drive pulleys, divide the  $T_1$  by  $T_2$ .** Use this ratio and Table 4 to determine the drive pulley resultant load factor. Then  $R = T_2 \times \text{Factor}$ .
- Determine Face Width.** For belts up through 42 inches add 2 inches to the belt width. For belts 48-60 add a minimum of 3 inches to the belt width.

TABLE 2 - NON-DRIVE LOAD

ANGLE OF WRAP	FACTOR	ANGLE OF WRAP	FACTOR
15	0.261	130	1.813
20	0.347	135	1.848
25	0.433	140	1.879
30	0.518	145	1.907
35	0.601	150	1.932
40	0.684	155	1.953
45	0.765	160	1.97
50	0.845	165	1.983
55	0.923	170	1.992
60	1	175	1.998
65	1.075	180	2
70	1.147	185	1.998
75	1.218	190	1.992
80	1.286	195	1.983
85	1.351	200	1.97
90	1.414	205	1.953
95	1.475	210	1.932
100	1.532	215	1.907
105	1.587	220	1.879
110	1.638	225	1.848
115	1.687	230	1.813

- Determine the shaft size** by using Table 5 or Table 6. Subtract the face width from the bearing centers ( $BC - F$ ). Follow the proper pulley face width column and across from the bearing center minus face value (interpolate if correct amount is not listed) until the load rating is greater than the resultant load determine above. Follow this procedure for each pulley.
- For pulley diameters, check with your belt manufacturer.**  
The belt requirements are the single largest consideration when choosing a pulley diameter.
- Divide the tension at each pulley by the belt width to get the PIW for each pulley,** (for the drive use  $T_1$ ) and check this against Table 3, XPD & MDD. If the PIW exceeds the rating for a XPD consider the MDD or increase the diameter. If this results in a pulley that does not fit into your conveyor, please contact PPI Engineering.

TABLE 1 - "K" FACTOR

DRIVE WRAP	AUTOMATIC T-U			MANUAL/SCREW T-U		
	Bare	Lagged	Ceramic	Bare	Lagged	Ceramic
180	0.84	0.5	0.26	1.2	0.8	0.5
190	0.77	0.46	0.24	1.1	0.8	0.5
200	0.72	0.42	0.21	1.1	0.7	0.5
210	0.67	0.38	0.19	1	0.7	0.4
220	0.62	0.35	0.17	0.9	0.6	0.4
230	0.58	0.33	0.16	0.9	0.6	0.4
240	0.54	0.3	0.14	0.8	0.6	0.4

TABLE 3 - PIWRATING

OD	ANGLE OF WRAP (XPD)					ANGLE OF WRAP (MDD)
	0-55	60-65	70-100	105-210	215-240	0-240
8	43	57	64	85	64	85
10	53	70	79	105	79	105
12	63	83	94	125	94	125
14	80	107	120	160	120	160
16	98	130	146	195	146	195
18	115	153	173	230	173	230
20	138	183	206	275	206	275
24	173	230	259	345	259	345
30	230	307	345	460	345	460
36	288	383	431	575	431	575
42	345	460	518	690	518	690
48	403	537	604	805	604	805
54	460	613	690	920	690	920
60	518	690	776	1035	776	1035

# PULLEY AND SHAFT ENGINEERING INFORMATION

TABLE 4 - DRIVE RESULTANT LOAD FACTOR

T1/T2	Angle of Wrap												
	180	185	190	195	200	205	210	215	220	225	230	235	240
1.8	2.8	2.798	2.79	2.778	2.761	2.739	2.713	2.681	2.645	2.605	2.56	2.511	2.458
1.9	2.9	2.898	2.89	2.878	2.86	2.838	2.811	2.779	2.742	2.701	2.656	2.606	2.551
2	3	2.997	2.99	2.977	2.96	2.937	2.909	2.877	2.84	2.798	2.752	2.701	2.646
2.1	3.1	3.097	3.09	3.077	3.059	3.036	3.008	2.975	2.937	2.895	2.848	2.796	2.74
2.2	3.2	3.197	3.19	3.176	3.158	3.135	3.107	3.073	3.035	2.992	2.944	2.892	2.835
2.3	3.3	3.297	3.289	3.276	3.258	3.234	3.205	3.171	3.133	3.089	3.041	2.988	2.931
2.4	3.4	3.397	3.389	3.376	3.357	3.333	3.304	3.27	3.231	3.187	3.138	3.084	3.027
2.5	3.5	3.497	3.489	3.476	3.457	3.432	3.403	3.368	3.329	3.284	3.235	3.181	3.122
2.6	3.6	3.597	3.589	3.575	3.556	3.532	3.502	3.467	3.427	3.382	3.332	3.278	3.219
2.7	3.7	3.697	3.689	3.675	3.656	3.631	3.601	3.566	3.525	3.48	3.429	3.375	3.315
2.8	3.8	3.797	3.789	3.775	3.755	3.73	3.7	3.664	3.624	3.578	3.527	3.472	3.412
2.9	3.9	3.897	3.889	3.875	3.855	3.83	3.799	3.763	3.722	3.676	3.625	3.569	3.509
3	4	3.997	3.989	3.974	3.955	3.929	3.898	3.862	3.821	3.774	3.722	3.666	3.606
3.1	4.1	4.097	4.088	4.074	4.054	4.029	3.997	3.961	3.919	3.872	3.82	3.764	3.703
3.2	4.2	4.197	4.188	4.174	4.154	4.128	4.097	4.06	4.018	3.971	3.918	3.861	3.8
3.3	4.3	4.297	4.288	4.274	4.253	4.227	4.196	4.159	4.117	4.069	4.017	3.959	3.897
3.4	4.4	4.397	4.388	4.374	4.353	4.327	4.295	4.258	4.215	4.168	4.115	4.057	3.995
3.5	4.5	4.497	4.488	4.473	4.453	4.427	4.395	4.357	4.314	4.266	4.213	4.155	4.093
3.6	4.6	4.597	4.588	4.573	4.553	4.526	4.494	4.456	4.413	4.365	4.311	4.253	4.19
3.7	4.7	4.697	4.688	4.673	4.652	4.626	4.593	4.555	4.512	4.463	4.41	4.351	4.288
3.8	4.8	4.797	4.788	4.773	4.752	4.725	4.693	4.655	4.611	4.562	4.508	4.45	4.386
3.9	4.9	4.897	4.888	4.873	4.852	4.825	4.792	4.754	4.71	4.661	4.607	4.548	4.484
4	5	4.997	4.988	4.973	4.952	4.924	4.892	4.853	4.809	4.76	4.706	4.646	4.583
4.1	5.1	5.097	5.088	5.073	5.051	5.024	4.991	4.952	4.908	4.859	4.804	4.745	4.681
4.2	5.2	5.197	5.188	5.172	5.151	5.124	5.091	5.052	5.007	4.958	4.903	4.843	4.779
4.3	5.3	5.297	5.288	5.272	5.251	5.223	5.19	5.151	5.107	5.057	5.002	4.942	4.877
4.4	5.4	5.397	5.388	5.372	5.351	5.323	5.29	5.251	5.206	5.156	5.101	5.041	4.976

# PULLEY AND SHAFT ENGINEERING INFORMATION

TABLE 5 - RESULTANT LOADS FOR PULLEYS, BASED ON 8000 PSI SHAFT STRESS AND 0.0023 IN/IN SHAFT SLOPE

SHAFT DIAMETER	BC-F	FACE WIDTH											
		12	16	20	26	32	38	44	51	57	63	66	
1 3/16	2	1,000	780	590	440	350	290	240	210	180	170	160	
	6	570	440	340	250	200	160	140	120	100	90	90	
	10	400	310	230	170	140	110	100	80	70	70	60	
	14	300	240	180	130	110	90	70	60	60	50	50	
1 7/16	3	1,500	1,400	1,100	790	620	510	440	370	330	300	290	
	6	1,000	950	720	530	420	350	300	250	220	200	190	
	10	700	660	500	370	290	240	210	180	160	140	130	
	14	540	510	390	290	230	190	160	140	120	110	100	
1 11/16	3	2,400		2,000	1,500	1,200	980	830	710	630	570	540	
	6	1,600		1,400	1,000	800	660	560	480	430	380	370	
	10	1,100		960	700	560	460	390	340	300	270	260	
	16	780		660	490	380	320	270	230	210	180	180	
1 15/16	3	3,700		3,500	2,600	2,100	1,700	1,400	1,200	1,100	990	940	
	6	2,500		2,400	1,800	1,400	1,100	980	840	740	670	640	
	10	1,700		1,700	1,200	970	800	680	580	520	470	440	
	16	1,200		1,100	840	670	550	470	400	360	320	310	
2 3/16	3	5,300			4,200	3,300	2,800	2,400	2,000	1,800	1,600	1,500	
	8	2,900			2,300	1,900	1,500	1,300	1,100	1,000	900	800	
	12	2,200			1,700	1,400	1,100	1,000	800	700	700	600	
	18	1,500			1,200	1,000	800	700	600	500	500	400	
2 7/16	4	6,300			5,600	4,400	3,700	3,100	2,700	2,400	2,100	2,000	
	8	4,000			3,600	2,900	2,400	2,000	1,700	1,500	1,400	1,300	
	12	3,000			2,700	2,100	1,700	1,500	1,300	1,100	1,000	1,000	
	18	2,100			1,900	1,500	1,300	1,100	900	800	700	700	
2 11/16	4	8,100				6,400	5,300	4,500	3,800	3,400	3,100	2,900	
	8	5,300				4,200	3,400	2,900	2,500	2,200	2,000	1,900	
	12	3,900				3,100	2,600	2,200	1,900	1,600	1,500	1,400	
	18	2,800				2,200	1,800	1,600	1,300	1,200	1,100	1,000	
2 15/16	4	10,600				9,100	7,500	6,400	5,500	4,900	4,400	4,200	
	8	6,900				6,000	4,900	4,200	3,600	3,200	2,900	2,700	
	14	4,600				3,900	3,200	2,800	2,300	2,100	1,900	1,800	
	20	3,400				2,900	2,400	2,000	1,700	1,600	1,400	1,300	
3 7/16	6	11,600					10,100	8,500	7,200	6,400	5,700	5,500	
	10	8,500					7,400	6,300	5,300	4,700	4,200	4,000	
	14	6,700					5,800	4,900	4,200	3,700	3,300	3,200	
	20	5,100					4,400	3,800	3,200	2,800	2,500	2,400	
3 15/16	6	16,700						14,200	12,000	10,600	9,500	9,000	
	10	12,400						10,600	8,900	7,900	7,100	6,700	
	14	9,800						8,400	7,100	6,300	5,600	5,300	
	20	7,500						6,400	5,400	4,800	4,300	4,100	
4 7/16	8	19,600							19,100	16,100	14,200	12,700	12,100
	12	15,300							14,800	12,500	11,100	9,900	9,400
	16	12,500							12,100	10,300	9,100	8,100	7,700
	22	9,800							9,500	8,100	7,100	6,400	6,000



# PULLEY AND SHAFT ENGINEERING INFORMATION

TABLE 5 - RESULTANT LOADS FOR PULLEYS, BASED ON 8000 PSI SHAFT STRESS AND 0.0023 IN/IN SHAFT SLOPE

SHAFT DIAMETER	BC-F	FACE WIDTH									
		16	20	26	32	38	44	51	57	63	66
4 15/16	8	25,200					23,600		20,800	18,500	17,600
	12	19,900					18,600		16,400	14,600	13,900
	16	16,400					15,400		13,500	12,100	11,500
	22	13,000					12,200		10,700	9,600	9,100
5 7/16	10	26,600					25,100		22,300	21,100	
	14	22,000					20,700		18,400	17,500	
	18	18,700					17,700		15,700	14,900	
	24	15,300					14,500		12,800	12,200	
6	10	35,700					33,100		31,300		
	14	29,500					27,300		25,900		
	18	25,100					23,300		22,100		
	24	20,600					19,000		18,000		
6 1/2	12	39,200					38,000				
	16	33,200					32,100				
	20	28,800					27,800				
	26	24,000					23,200				
7	12	49,000					49,000				
	16	41,400					41,400				
	20	35,900					35,900				
	26	29,900					29,900				
7 1/2	14	54,100					54,100				
	18	46,500					46,500				
	22	40,800					40,800				
	28	34,400					34,400				
8	14	65,700					65,700				
	18	56,400					56,400				
	22	49,500					49,500				
	28	41,800					41,800				
8 1/2	16	67,700					67,700				
	20	59,400					59,400				
	24	52,900					52,900				
	30	45,400					45,400				
9	16	80,400					80,400				
	20	70,500					70,500				
	26	59,500					59,500				
	32	51,500					51,500				
9 1/2	16	94,500					94,500				
	22	78,100					78,100				
	28	66,500					66,500				
	34	57,900					57,900				
10	16	110,000					110,000				
	22	91,100					91,100				
	28	77,600					77,600				
	36	64,800					64,800				

# PULLEY AND SHAFT ENGINEERING INFORMATION

TABLE 6 - RESULTANT LOADS FOR PULLEYS, BASED ON 6000 PSI SHAFT STRESS AND 0.0015 IN/IN SHAFT SLOPE

SHAFT DIAMETER	BC-F	FACE WIDTH										
		12	16	20	26	32	38	44	51	57	63	66
1 3/16	2	740	510	390	280	230	190	160	140	120	110	100
	6	420	290	220	160	130	110	90	80	70	60	60
	10	290	200	150	110	90	70	60	50	50	40	40
	14	230	150	120	90	70	60	50	40	40	30	30
1 7/16	3	1,100	920	700	510	410	340	290	240	220	200	190
	6	760	620	470	350	270	230	190	170	150	130	130
	10	530	430	330	240	190	160	140	120	100	90	90
	14	410	330	250	190	150	120	100	90	80	70	70
1 11/16	3	1,800	1,700	1,300	970	770	640	540	460	410	370	350
	6	1,200	1,170	890	660	520	430	370	310	280	250	240
	10	850	820	620	460	360	300	260	220	190	170	170
	16	590	560	430	320	250	210	180	150	130	120	110
1 15/16	3	2,700		2,300	1,700	1,300	1,100	950	810	720	640	610
	6	1,900		1,600	1,100	910	750	640	550	480	440	410
	10	1,300		1,100	800	630	520	450	380	340	300	290
	16	890		750	550	430	360	310	260	230	210	200
2 3/16	3	3,900		3,700	2,800	2,200	1,800	1,500	1,300	1,200	1,000	1,000
	8	2,200		2,100	1,500	1,200	1,000	850	730	650	580	550
	12	1,600		1,500	1,100	890	740	630	540	480	430	410
	18	1,200		1,100	810	640	530	450	390	340	310	290
2 7/16	4	4,700			3,700	2,900	2,400	2,000	1,700	1,500	1,400	1,300
	8	3,000			2,400	1,900	1,500	1,300	1,100	1,000	900	850
	12	2,200			1,700	1,400	1,100	970	830	740	660	630
	18	1,600			1,200	990	820	700	590	530	470	450
2 11/16	4	6,100		5,300	4,200	3,400	2,900	2,500	2,200	2,000	1,900	
	8	4,000		3,400	2,700	2,200	1,900	1,600	1,400	1,300	1,200	
	12	3,000		2,600	2,000	1,700	1,400	1,200	1,100	970	920	
	18	2,100		1,800	1,500	1,200	1,000	870	770	700	660	
2 15/16	4	8,000		7,500	6,000	4,900	4,200	3,600	3,200	2,900	2,700	
	8	5,200		4,900	3,900	3,200	2,700	2,300	2,100	1,900	1,800	
	14	3,400		3,200	2,600	2,100	1,800	1,500	1,400	1,200	1,200	
	20	2,500		2,400	1,900	1,600	1,300	1,100	1,000	910	870	
3 7/16	6	8,700				8,000	6,600	5,600	4,700	4,200	3,700	3,600
	10	6,400				5,900	4,800	4,100	3,500	3,100	2,700	2,600
	14	5,000				4,600	3,800	3,200	2,700	2,400	2,200	2,100
	20	3,800				3,500	2,900	2,400	2,100	1,800	1,600	1,600
3 15/16	6	12,500					11,000	9,300	7,800	6,900	6,200	5,900
	10	9,300					8,200	6,900	5,800	5,100	4,600	4,400
	14	7,400					6,500	5,500	4,600	4,100	3,700	3,500
	20	5,600					5,000	4,200	3,500	3,100	2,800	2,700
4 7/16	8	14,700						12,500	10,500	9,300	8,300	7,900
	12	11,400						9,700	8,200	7,200	6,500	6,100
	16	9,400						7,900	6,700	5,900	5,300	5,000
	22	7,400						6,200	5,300	4,600	4,200	3,900

# PULLEY AND SHAFT ENGINEERING INFORMATION

TABLE 6 - RESULTANT LOADS FOR PULLEYS, BASED ON 6000 PSI SHAFT STRESS AND 0.0015 IN/IN SHAFT SLOPE

SHAFT DIAMETER	BC-F	FACE WIDTH									
		16	20	26	32	38	44	51	57	63	66
4 15/16	8	18,900				18,300	15,400	13,500	12,100	11,500	
	12	14,900				14,400	12,100	10,700	9,500	9,100	
	16	12,300				11,900	10,000	8,800	7,900	7,500	
	22	9,800				9,500	8,000	7,000	6,300	5,900	
5 7/16	10	19,900				18,700	16,400	14,600	13,800		
	14	16,500				15,500	13,500	12,000	11,400		
	18	14,000				13,200	11,500	10,200	9,700		
	24	11,500				10,800	9,400	8,400	7,900		
6	10	26,800				24,300	21,600	20,400			
	14	22,100				20,100	17,800	16,900			
	18	18,800				17,100	15,200	14,400			
	24	15,400				14,000	12,400	11,800			
6 1/2	12	29,400				26,200	24,800				
	16	24,900				22,100	20,900				
	20	21,600				19,200	18,200				
	26	18,000				16,000	15,100				
7	12	36,700				35,200	33,300				
	16	31,100				29,800	28,200				
	20	26,900				25,800	24,400				
	26	22,400				21,500	20,300				
7 1/2	14	40,600				39,700					
	18	34,900				34,200					
	22	30,600				30,000					
	28	25,800				25,300					
8	14	49,200									
	18	42,300									
	22	37,100									
	28	31,300									
8 1/2	16	50,800									
	20	44,500									
	24	39,600									
	30	34,000									
9	16	60,300									
	20	52,900									
	26	44,600									
	32	38,600									
9 1/2	16	70,900									
	22	58,600									
	28	49,900									
	34	43,400									
10	16	82,700									
	22	68,300									
	28	58,200									
	36	48,600									



# PART NUMBERING AND CROWN FACE STYLES

## XPD1226PXT30

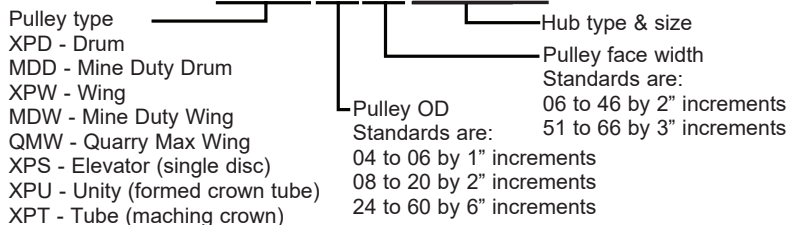

## X250207

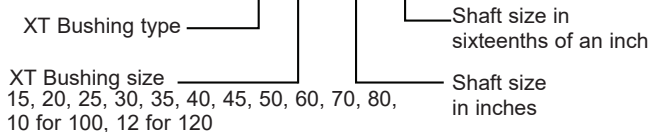

## QSF0207



### STANDARD CROWN FACE

PPI's standard face style is a full crown where the OD increases by 1/8" per foot from the edge to the center of the pulley.

### HIGH CROWN

Used on narrow face widths such as elevator pulleys. The crown extends across the entire pulley face similar to standard crown, however the crown rate is 50% to 100% more for better belt tracking.

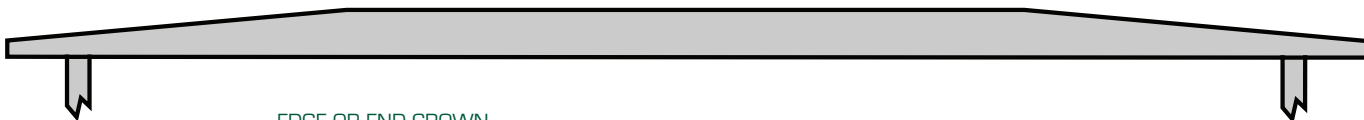

### EDGE OR END CROWN

This is a partial crown, commonly used on tube pulleys. The pulley crown is machined only on the edges at the standard crown rate. The center of the pulley is left unmachined.

### TRAP OR TRAPEZOIDAL CROWN

This is a partial crown, also used on tube pulleys. However, the entire face of the pulley is machined for better TIR throughout before crowning the ends at the standard crown rate.

# ENGINEERING DATA FOR DESIGN

Company: \_\_\_\_\_ Contact: \_\_\_\_\_

Address: \_\_\_\_\_ Phone #: \_\_\_\_\_

Project: \_\_\_\_\_

## CONVEYOR DATA

Belt: Fabric Steel Other \_\_\_\_\_ Width \_\_\_\_\_

Take-Up: Gravity Gravity wire rope Hydraulic Screw

Drive: Motor HP \_\_\_\_\_ Speed \_\_\_\_\_ FPM Capacity \_\_\_\_\_ TPH

Layout: Length \_\_\_\_\_ ft Lift \_\_\_\_\_ ft Material: \_\_\_\_\_

Service Life: Shifts per day \_\_\_\_\_ Months per year \_\_\_\_\_ Pulley Life \_\_\_\_\_ yrs

Quote: Bearings type \_\_\_\_\_ B10 Life \_\_\_\_\_ hrs TU Frame \_\_\_\_\_

Idlers Impact System EZSlider Smart Roll

CONVEYOR ID					
PULLEY LOCATION					
QUANTITY					
PULLEY TYPE					
OUTSIDE DIAMETER (OD) WITHOUT LAGGING					
FACE WIDTH					
CROWN OR FLAT FACE					
LAGGING THICKNESS					
LAGGING GROOVE					
LAGGING SPECS					
SHAFT DIAMETER @ HUB					
SHAFT DIAMETER @ BRG					
SHAFT DIAMETER @ DRIVE					
# KW					
SHAFT LENGTH					
BEARING CENTERS (BC)					
WRAP (ARC OF CONTACT)					
T1					
T2					

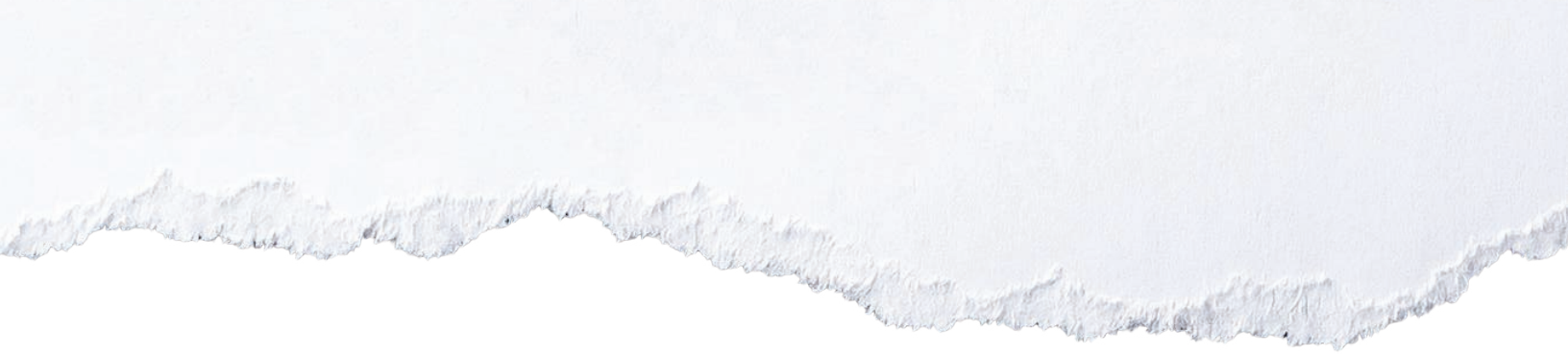

**GOODYEAR**  
RUBBER PRODUCTS, INC.

 **+1.727.342.5087**

También puede enviarnos un correo electrónico a  
[ventas@goodyearrubberproducts.com](mailto:ventas@goodyearrubberproducts.com)

# PPI<sup>®</sup>

PRECISION PULLEY & IDLER

[WWW.PPI-GLOBAL.COM](http://WWW.PPI-GLOBAL.COM) | [SALES@PPI-GLOBAL.COM](mailto:SALES@PPI-GLOBAL.COM)

Product shown are for illustrative purposes only and may display optional accessories or components. Please contact your sales representative for more information on product specifications. PPI respectively reserves the right to make changes in engineering, design and specifications; add improvements; or discontinue manufacturing at any time without notice obligation.

Craft-Lag, Fas-Lag, Herringbone Wing, Retro Rolls, P-FLEX, PPI and their respective logos are trademarks of Precision, Inc. in the US and/or other countries. Lorig is a trademark of US Steel.

**GOODYEAR**  
RUBBER PRODUCTS, INC.

+1.727.342.5087

También puede enviarnos un correo electrónico a  
[ventas@goodyearrubberproducts.com](mailto:ventas@goodyearrubberproducts.com)