

---

	Page
<b>Product Enhancements and Support Resources</b> .....	<b>1 - 10</b>
<b>Seal-Lok O-Ring Face Seal Fittings</b> .....	<b>Section A</b>
Introduction.....	A5
Visual Index.....	A2
<b>Triple-Lok 37° Flare Fittings</b> .....	<b>Section B</b>
Introduction.....	B6
Visual Index.....	B2
<b>Ferulok Flareless Bite Type Fittings</b> .....	<b>Section C</b>
Introduction.....	C4
Visual Index.....	C2
<b>EO and EO-2 Metric Bite Type Fittings</b> .....	<b>Section D</b>
Introduction.....	D6
Visual Index.....	D2
<b>Pipe Fittings and Port Adapters</b> .....	<b>Section E</b>
Introduction.....	E4
Visual Index.....	E2
<b>Pipe Swivels Adapters</b> .....	<b>Section F</b>
Introduction.....	F3
Visual Index.....	F2
<b>JIS Fittings Adapters</b> .....	<b>Section G</b>
Introduction.....	G3
Visual Index.....	G2
<b>K4 BSP Adapters</b> .....	<b>Section H</b>
Introduction.....	H3
Visual Index.....	H2

*Continued*

---

	Page
<b>Komatsu Style Adapters</b> .....	<b>Section I</b>
Introduction.....	I3
Visual Index .....	I2
<b>Conversion Adapters</b> .....	<b>Section J</b>
Visual Index .....	J2
<b>Hydraulic Code 61/62 Flange Connections &amp; Components</b> .....	<b>Section K</b>
Introduction.....	K5
Visual Index .....	K2
<b>Diagnostic, Orifice, Bleed Adapters, Screen and Specialty Fittings</b> .....	<b>Section L</b>
Introduction.....	L3
Visual Index .....	L2
<b>O-Rings and Seals</b> .....	<b>Section M</b>
Visual Index .....	M2
<b>ParKlamp Inch Tube Clamps</b> .....	<b>Section N</b>
Introduction.....	N4
Visual Index .....	N2
<b>Metric Clamps</b> .....	<b>Section O</b>
Introduction.....	O3
Visual Index .....	O2
<b>Metric Tube</b> .....	<b>Section P</b>
Introduction.....	P3
Assembly and Installation.....	P3

*Continued*



	Page
<b>Fabricating Equipment.....</b>	<b>Section Q</b>
<i>Visual Index .....</i>	<i>Q2</i>
<b>Assembly/Installation.....</b>	<b>Section R</b>
<i>Port End Assembly .....</i>	<i>R3</i>
<i>Tube End Assembly .....</i>	<i>R12</i>
<i>Seal-Lok O-Ring Face Seal Fittings and UPTC Assembly .....</i>	<i>R13</i>
<i>Triple-Lok 37° Flare Fittings.....</i>	<i>R20</i>
<i>Ferulok Flareless Bite Type Fittings.....</i>	<i>R30</i>
<i>Intru-Lok Flareless Bite Type Fittings.....</i>	<i>R34</i>
<i>EO Metric Bite Type Fittings .....</i>	<i>R35</i>
<i>EO-2 Metric Bite Type Fittings .....</i>	<i>R39</i>
<i>Bulkhead Locknut Assembly.....</i>	<i>R44</i>
<i>Pipe Swivel Assembly.....</i>	<i>R44</i>
<i>Routing and Clamping Recommendations.....</i>	<i>R45</i>
<i>Bending Tips.....</i>	<i>R48</i>
<i>Plumbing and Assembly Hints.....</i>	<i>R49</i>
<b>General Technical .....</b>	<b>Section S</b>
<i>STAMP Summary .....</i>	<i>S3</i>
<i>Fitting and Tube Selection Chart .....</i>	<i>S4</i>
<i>Size.....</i>	<i>S4</i>
<i>Temperature.....</i>	<i>S10</i>
<i>Application .....</i>	<i>S13</i>
<i>Media.....</i>	<i>S17</i>
<i>Pressure .....</i>	<i>S25</i>
<i>Fitting and Tube Selection Chart Competed Example.....</i>	<i>S31</i>
<i>Reference .....</i>	<i>S33</i>
<i>Port Details .....</i>	<i>S34</i>
<i>Selection of Fitting Type.....</i>	<i>S41</i>
<i>Fitting Materials .....</i>	<i>S46</i>
<i>How To Order (TFD Standard Nomenclature Construction).....</i>	<i>S48</i>

*Continued*

---

<b>Appendix .....</b>	<b>Section T</b>
<i>Applicable Standards For TFD Products by Standard Number .....</i>	<i>T3</i>
<i>Thread Designations and Standards for Threads Used in Fluid Connectors .....</i>	<i>T4</i>
<i>Document Sources for Connector Specifications .....</i>	<i>T5</i>
<i>Helpful Information .....</i>	<i>T6</i>
<i>Glossary of Key Tube Fittings, Fluid Power and Other Engineering Terms .....</i>	<i>T8</i>
<b>Numeric Index, Fitting End Size Chart &amp; Offer of Sale.....</b>	<b>Section U</b>



# Industrial Tube Fittings, Adapters and Equipment

Catalog 4300 PDF Version

PDF Version 2 — 6/2021



 **WARNING**

FAILURE OR IMPROPER SELECTION OR IMPROPER USE OF THE PRODUCTS AND/OR SYSTEMS DESCRIBED HEREIN OR RELATED ITEMS CAN CAUSE DEATH, PERSONAL INJURY AND PROPERTY DAMAGE.

This document and other information from Parker Hannifin Corporation, its subsidiaries and authorized distributors provide product and/or system options for further investigation by users having technical expertise. It is important that you analyze all aspects of your application and review the information concerning the product or system in the current product catalog. Due to the variety of operating conditions and applications for these products or systems, the user, through its own analysis and testing, is solely responsible for making the final selection of the products and systems and assuring that all performance, safety and warning requirements of the application are met.

The products described herein, including without limitation, product features, specifications, designs, availability and pricing, are subject to change by Parker Hannifin Corporation and its subsidiaries at any time without notice.

**Offer of Sale**

The items described in this document are hereby offered for sale by Parker Hannifin Corporation, its subsidiaries or its authorized distributors. This offer and its acceptance are governed by the provisions stated in the "Offer of Sale."

## Table of Contents

<b>O-Ring Face Seal Tube Fittings</b> .....	<b>Seal-Lok</b> .....	<b>A</b>
<b>37° Flare Tube Fittings and Adapters</b> .....	<b>Triple-Lok &amp; Triple-Lok 2</b> .....	<b>B</b>
<b>Flareless Bite Type Fittings</b> .....	<b>Ferulok</b> .....	<b>C</b>
<b>Metric Bite Type Fittings</b> .....	<b>EO and EO-2</b> .....	<b>D</b>
<b>Adapters</b> .....	<b>Pipe Fittings and Port Adapters</b> .....	<b>E</b>
	<b>Pipe Swivels</b> .....	<b>F</b>
	<b>JIS Fittings</b> .....	<b>G</b>
	<b>K4 BSP Adapters</b> .....	<b>H</b>
	<b>Komatsu Style Adapters</b> .....	<b>I</b>
	<b>Conversion Adapters</b> .....	<b>J</b>
<b>Code 61/62 Flange Connections</b> .....	<b>Hydraulic Flanges &amp; Components</b> .....	<b>K</b>
<b>Diagnostic, Orifice, Bleed Adapters, Screen and Specialty Fittings</b> .....		<b>L</b>
<b>O-Rings and Seals</b> .....		<b>M</b>
<b>Tube Clamps</b> .....	<b>ParKlamp Inch Tube Clamps</b> .....	<b>N</b>
	<b>Metric Clamps</b> .....	<b>O</b>
<b>Tube</b> .....	<b>Metric Tube</b> .....	<b>P</b>
<b>Fabricating Equipment</b> .....	<b>Equipment</b> .....	<b>Q</b>
<b>Assembly / Installation</b> .....		<b>R</b>
<b>General Technical</b> .....		<b>S</b>
<b>Appendix</b> .....		<b>T</b>
<b>Numeric Index, Fitting End Size Chart and Offer of Sale</b> .....		<b>U</b>





**IN THIS WORLD,  
THERE'S NO TIME  
FOR DOWNTIME.**



**GOODYEAR**  
RUBBER PRODUCTS, INC.

+1.727.342.5087

También puede enviarnos un correo electrónico a [ventas@goodyearrubberproducts.com](mailto:ventas@goodyearrubberproducts.com)



GETTING YOU RUNNING AND KEEPING YOU THERE: PRODUCTS, SERVICES, INNOVATION, AND LEAK-FREE PERFORMANCE DESIGNED WITH YOU IN MIND

Equipment makers and users both rely on Parker to keep downtime at bay. Because we understand that every lost minute impacts productivity, we continually add innovation to our products and services while helping our customers save money and time.

INDUSTRY STANDARDS



# LESS DOWNTIME BEGINS WITH MORE ADVANCED TESTING

Water. Salt. Oxygen. Chemicals. Vibration. Fatigue. High internal and external pressure. Put them together and you have the makings for premature connector failure. Parker's metallurgical lab is the first line of defense against the ravages of your application environment.

Our lab features the most advanced testing equipment, enabling us to evaluate our products under the same—or tougher—conditions they will face in their service life. Testing capabilities include:

- **High pressure test stand**, with the ability to achieve up to 75,000 psi of pressure to ensure safety while meeting the ever-increasing market demand for higher pressure applications.
- **Ingression tester** that allows us to test for leaks by simulating conditions that exist more than four miles below the ocean's surface.
- **Corrosion resistance testing chambers** enable us to ensure the prevention of corrosion throughout a product's life.
- **Force measurement equipment**—unique to Parker—evaluates the force required to pull apart our fittings, which leads to more robust and rugged designs.
- **Fatigue assessment** provides the critical data needed to ensure longer fitting life.
- **Inspection equipment that examines materials and surfaces** at the microscopic level, enabling us to understand a material's properties and microstructure, resulting in products with greater corrosion resistance and longer life.

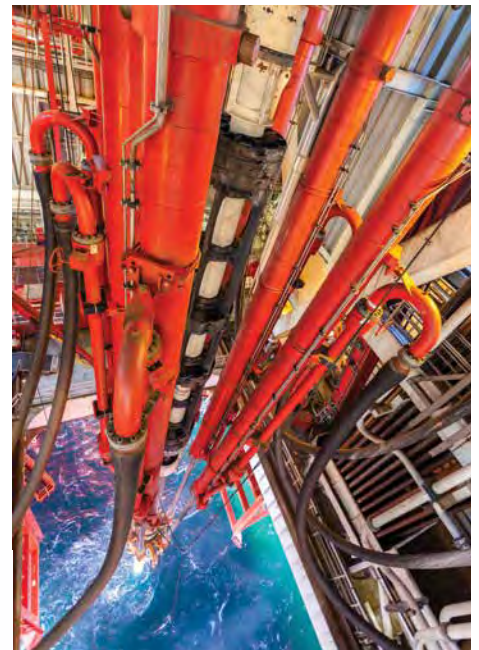

SEE OUR TESTING LAB VIDEO



# LISTENING TO CUSTOMERS TO DEVELOP IMPROVED SOLUTIONS

At Parker, we don't stand for standing still. By listening to and collaborating with customers, we gain an understanding of their daily challenges, and take action to improve their products and productivity.

## TRAP-SEAL™: Solving O-ring fallout and pinch

Parker Trap-Seal™ technology proactively protects against issues that some people experience when using ORFS fittings: O-ring fallout and O-ring pinch, both of which can compromise connection integrity.

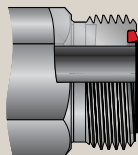

Trap-Seal in half-dovetail groove

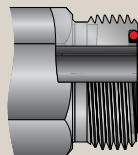

Standard O-ring in half-dovetail groove

To eliminate these potential issues, Parker developed Trap-Seal™, a trapezoidal-shaped seal that sits snugly in the ORFS fitting's captive O-ring groove (CORG). It ensures improved retention and provides maximum assurance for leak-free connections.

[▶ Learn more](#)

## ROBUST PORT STUD™: It's called "stud" for a reason

The O-ring pinch issue can happen on adjustable O-ring boss port ends due to thread exposure below the locknut that leads to a deformed backup washer, pinching the O-ring and creating an O-ring extrusion gap with the potential to leak. With a longer locknut, our Robust Port Stud eliminates exposed threads and the leak potential of adjustable O-ring boss port ends. This enhanced port end comes standard on all fittings with an adjustable O-ring boss port end.



Parker's SAE Robust Port Stud

Current SAE Adjustable Port Stud

## TOUGHSHIELD 1000: Rust protection that protects productivity

Anyone who has worked with industrial or heavy mobile equipment that spends much of its time outdoors has had to deal with the formation of rust. Dedicated to fundamentally understanding the cause of corrosion and how it progresses, Parker's metallurgy team has developed ToughShield 1000 (TS1000) plating.

TS1000 keeps steel fittings free of red rust for up to 1,000 hours according to ASTM B117 neutral salt spray testing – providing 10 times the SAE requirement. And, as always, we are working on even better plating technology to cut downtime down even further.

[▶ Learn more](#)



Hours (exposed to neutral salt spray test ASTM B11) Pictures and testing were completed by Miami Valley Materials Testing Center - an accredited independent test center.

# GOT A BIG IDEA? WE'LL MAKE WHAT YOU NEED, WHEN YOU NEED IT.

## CUSTOM MANUFACTURING: You dream it, we machine it

Never again work your designs around parts somebody else designed, just because that's what's readily available. At our dedicated **Custom Manufacturing Operation**, Parker can transform your unique concept into a finished part, manufacturing custom products to your specifications, drawings or world standards. Whether you need thousands or just that one-of-a-kind.



▶ [Learn more](#)

## TUBE FABRICATION RENTAL PROGRAM: To buy or not to buy?

When a short-term project requires fabricating tube assemblies, **Parker's Rental Program** can save you the costs of buying and owning equipment and tooling. Plus, you can rent and try equipment you are considering buying while enjoying the assurance of Parker quality, reliability and performance.

▶ [Learn more](#)



## RAPID SERVICE UNIT: It's what's in the name

When you urgently need a part, whether a standard, an uncommon jump size or a one-of-a-kind, contact the Parker Rapid Service Unit (RSU). Created within our **Custom Manufacturing Operation**, RSU designs, produces and delivers high-quality hydraulic and pneumatic fittings and adapters on your schedule. Minimize costly downtime with our quick-response quotes, and get parts in hand in as little as 24, 48 or 72 hours.



▶ [Learn more](#)

## EVERYWHERE YOU NEED US TO BE

13,000+ distributors, sales offices, and MRO outlets provide Parker customers with near-instant access to parts, products, maintenance, service and solutions of every kind. Globally, locally and ready to combat downtime.

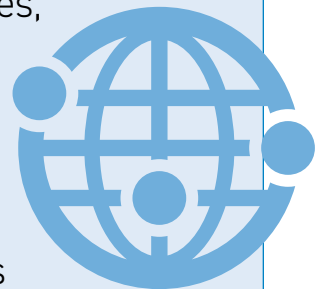

# RESOURCES: KNOWLEDGE, POWERING YOU THROUGH CHALLENGES

By system design tips, training, leak and assembly troubleshooting, and countless other resources, Parker helps its customers do their jobs better and more efficiently while holding downtime in check.

## techConnect

Every member an expert in fluid systems technology, Parker's **techConnect** team regularly publishes relevant articles that save customers time and make their jobs easier, from troubleshooting leaks to system design considerations. This rich online trove of information includes helpful videos and other reference materials.

▶ [Learn more](#)

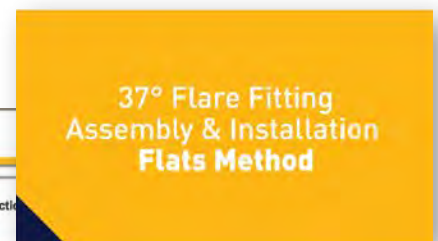
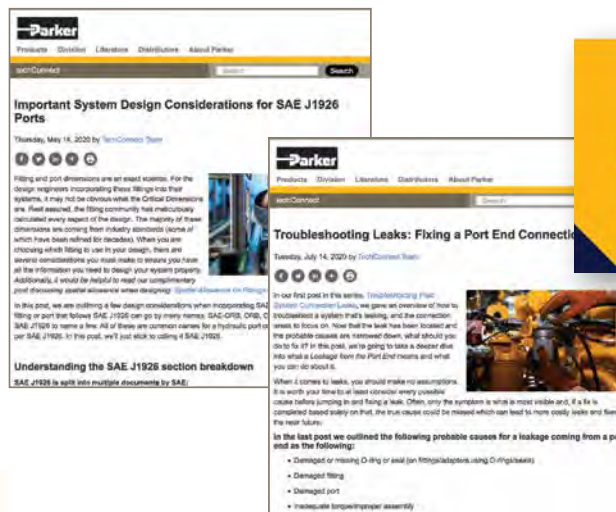

## Online tools: Design, specify, and train like the pro that you are

Not only is Parker's connection technology the most advanced, we have the tools you need to help best put that tech to work.

### toolSpec:

Our **easy-to-use web app** helps you identify tube fabrication equipment and the required tooling for your application.

▶ [Learn more](#)

### Online CAD models:

Parker makes it simple to download the **CAD models** you need to speed system design.

▶ [Learn more](#)





## RESOURCES: KNOWLEDGE, POWERING YOU THROUGH CHALLENGES

Online tools: Design, specify, and train like the pro that you are continued from page 7

### FittingFinder app with Competitive Interchange:



Available on the web or in your app store, Parker's FittingFinder

helps you easily locate the part number for the fitting you need. Plus, the new Competitive Interchange feature lets you convert a competitor's part number to a Parker one.

**[Parkerfittingfinder.com](http://Parkerfittingfinder.com)**

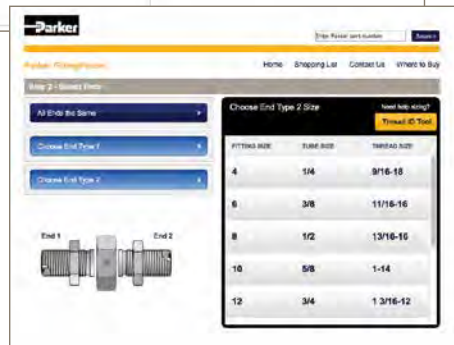
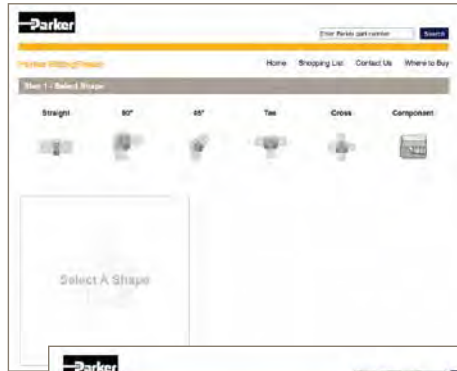

### Tube fittings FAQs, FYI:

Our FAQ page makes answers to the most common questions just a few clicks—or swipes—away.

Topics included:

- General questions, including CAD model questions
- Tube fittings and adapters questions
- Assembly and installation questions
- Thread ID and part number ID questions
- Tube fittings and adapter system leak questions
- Tube sizing, temperature, routing and clamping questions
- Tube fabrication equipment and tooling questions
- Tube fitting and adapter O-ring and seal questions

[▶ Learn more](#)

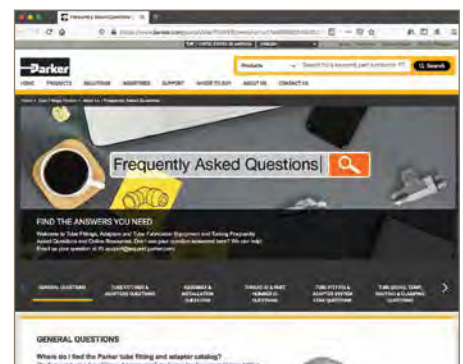

### Tube fabrication resource page:

Where to go to view videos showing how to operate our tube fab equipment.

[▶ Learn more](#)

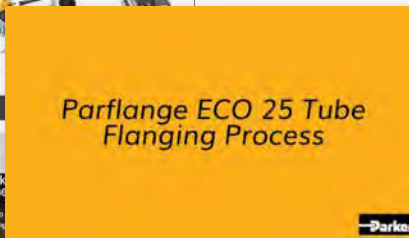
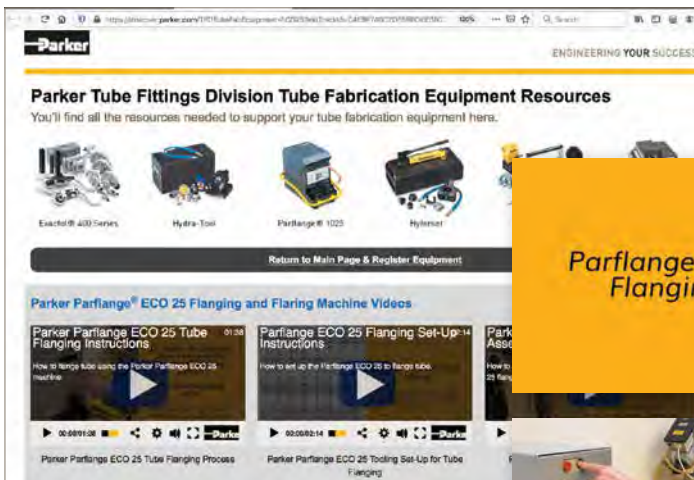

Make fast ORFS tube connections anywhere without brazing or flanging

# PARKER FASTSEAL™

## Faster connections for more uptime, speed, and cost savings

No one has time for downtime in the field. Every lost minute impacts productivity, and FastSeal is designed with uptime in mind. FastSeal eliminates the need for tube brazing and flanging equipment by utilizing Parker's proven flareless bite ring technology with an elastomeric seal to make strong, reliable tube connections that puts systems back on-line faster. There is no heavy equipment to buy, rent, or bring with you to the field; no extra storage space needed for equipment and tooling inventory; no messy or potentially unsafe brazing to perform; no leaving the work site for repairs; and no hassles.



Parker's patent-pending FastSeal ORFS connection allows assembly and maintenance teams to quickly preset the sleeve onto the tube end for a permanent flat-face connection, with no need for brazing or flanging equipment.

The FastSeal nut combines the bite-ring and sleeve with an integrated seal to make a simple, leak-free ORFS tube connection.

Works seamlessly with Parker Seal-Lok ORFS fittings, and can be used in the field regardless of connection type.

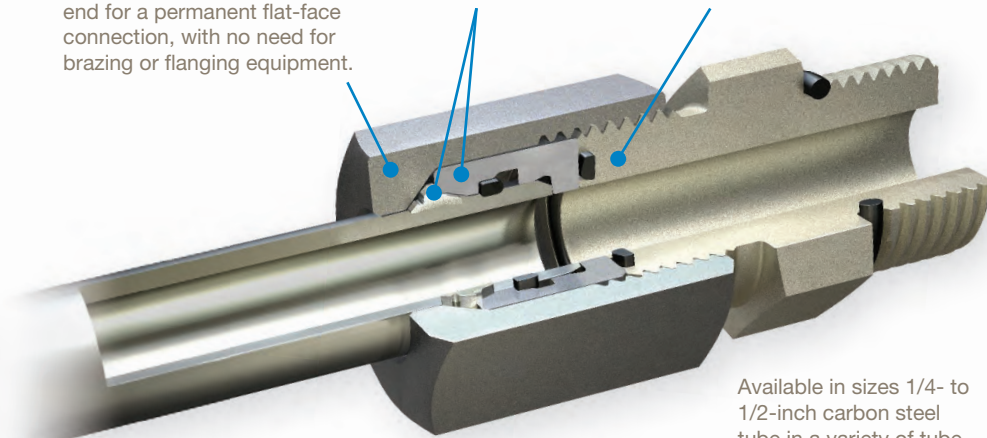

Available in sizes 1/4- to 1/2-inch carbon steel tube in a variety of tube wall thicknesses

## FastSeal connections are fast and easy anywhere

- 1** Select, cut, and deburr the tube. Use the FastSeal marking tool to check tube OD and ovality, ensure adequate deburr, and mark the tube insertion depth.
- 2** Thread the FastSeal nut onto the fitting body hand tight. Then, insert the tube into the nut, past the integrated seal, until it bottoms out and the tube insertion mark is reached.
- 3** With the tube fully inserted to the depth mark, preset the bite ring by tightening the nut to the specified turns. After inspection, tighten to the required Seal-Lok torque value.

**Mark.  
Insert.  
Tighten.**



Scan for FastSeal

## Pairs with Seal-Lok ORFS fittings or easily converts existing connections to ORFS

Combining the leak-free reliability of a standard Seal-Lok™ ORFS connection and the simple assembly technology of a bite-type connection, FastSeal bridges the gap and provides the best of both worlds to assemblers and maintenance personnel. So, no matter what tube assembly technology was originally used—tube assemblies using Parker FastSeal connectors will mate seamlessly to your ORFS fittings. In fact, other fitting connection technologies can be easily converted to ORFS connections using our quick field attachable FastSeal tube assemblies.



**TESTED.  
PROVEN.  
TRUSTED.**



FastSeal™ has been tested in accordance with industry standards and meets/exceeds the same requirements as Parker's Seal-Lok™ ORFS product line.

### Per SAE J1453 / ISO 19879

- Leak and burst
- Cyclic endurance (impulse)
- Vacuum
- Over torque
- Vibration (rotary flex)
- Remake

**GOODYEAR**  
RUBBER PRODUCTS, INC.

+1.727.342.5087

También puede enviarnos un correo electrónico a [ventas@goodyearrubberproducts.com](mailto:ventas@goodyearrubberproducts.com)



# The unmatched alternative for alternative fuels

# SEAL-LOK™ TECHNOLOGY

ROBUST.  
RELIABLE.  
REUSABLE.



As the push for cleaner fuel alternatives intensifies, Parker continues leading the way with products engineered to optimize fuel conveyance. Parker Seal-Lok™ technology introduces an O-ring face seal (ORFS) design that performs with a variety of fuels to achieve the most robust, leak-free connection in the industry – period. Seal-Lok fittings boost your bottom line with:



**Unlimited Reusability** – The ORFS design allows for in-field troubleshooting and maintenance by simply replacing the O-ring.

**Parflange® Technology** – Provides high-quality, consistent flanges fast with an exclusive orbital spindle motion. Parflange machines are available to purchase or rent to meet all production needs.

**Robust Port Stud™** – Features a longer locknut to cover the uppermost threads on adjustable port end fittings, eliminating the potential for backup washer damage and leaks.

**Corrosion-Resistant Materials** – All Seal-Lok product lines for alternative fuels are available in corrosion-resistant SAE/AISI 316/316L stainless

## SEAL-LOK SOLUTIONS FOR ALTERNATIVE FUELS

### Seal-Lok for CNG

- Meets all requirements of NGV 3.1, ECE R110, ISO 15500
- CNG compatible HNBR O-ring compound
- Sealing temperatures from -40°F to 300°F (-40°C to 149°C)
- Suitable for on-vehicle and infrastructure applications



### Seal-Lok XTREME for LNG

- Meets all requirements of ECE R110
- Uses patented metal seal for increased pressure capability in ORFS-design and SAE ORB fittings
- Sealing temperatures from -328°F to 1,200°F (-200°C to 649°C)
- Suitable for on-vehicle and infrastructure applications



### Seal-Lok for LPG

- Meets all requirements of ECE R110, ISO 15500
- LPG compatible HNBR O-ring compound
- Stainless steel and carbon steel with Zn-Ni plating
- Suitable for on-vehicle and infrastructure applications



### Seal-Lok for Hydrogen

- Meets all performance requirements of EC 79
- ORFS manufactured specifically for critical H<sub>2</sub> applications
- Custom port options for 700 bar (10,000 psi)
- Suitable for on-vehicle and infrastructure applications



# INNOVATION IN ACTION

Faster commissioning for oil & gas applications



## PHASTITE® FOR PIPE

### Permanent leak-free piping connections in minutes

Phastite is an innovative pipe connection technology that provides non-welded, stainless steel piping connections quickly and safely. The intuitive and fast fabrication process delivers permanent pipe connections in minutes, eliminating the time consuming steps required for welded piping connections.

A typical heavy-schedule pipe weld requires several hours to complete; and as pipe size and schedule increase, man-hours for welding dramatically grow.



### SIGNIFICANT TIME SAVINGS

In contrast, Phastite connections provide real-world time savings, **enabling permanent, installation-ready connections to be fabricated in 15 minutes versus 180 minutes or longer for welded connections.**

In fact, a high-pressure welding project typically requiring several weeks to commission may be reduced to several days and require less manpower using Phastite.

Phastite fittings also deliver consistency to the scheduling and commissioning process as one machine and fitting series is used across all available sizes and schedules.



Phastite fittings are available in common SAE 4-bolt hydraulic flanges (SAE J518/ISO 6162) and Dual Seal (seal-sub) subsea flanges.

### THE INSIDE STORY

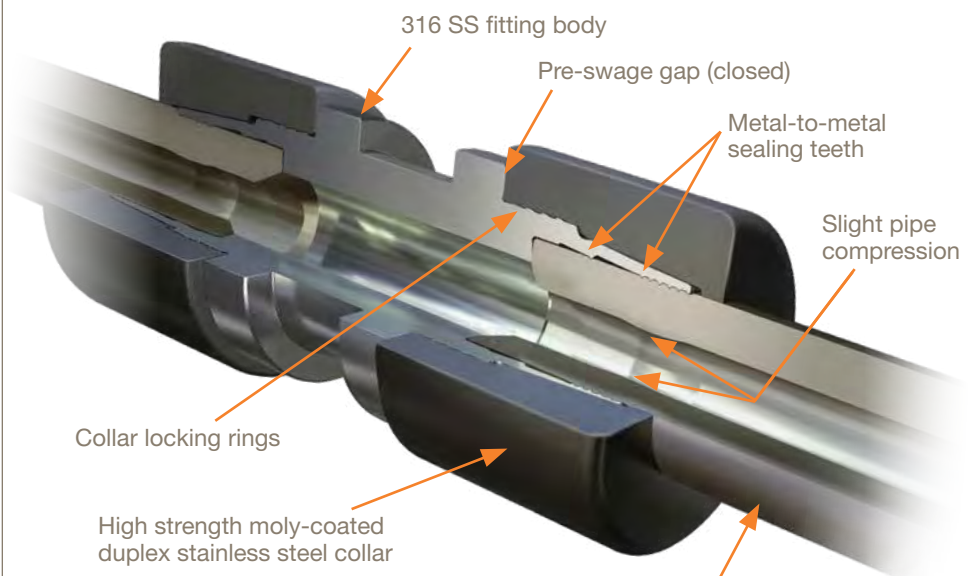



A











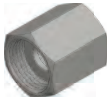











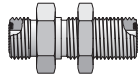
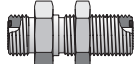
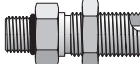

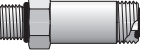

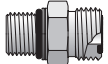

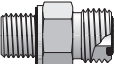







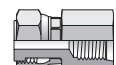

# SEAL-LOK™











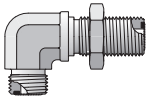
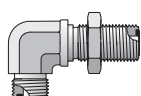
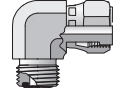
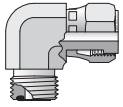
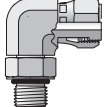
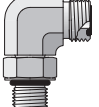
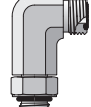
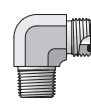
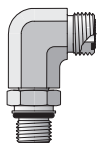
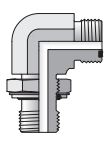
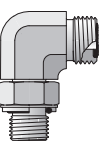

## O-Ring Face Seal Tube Fittings

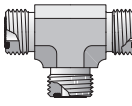
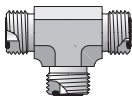
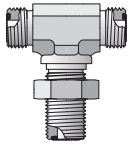
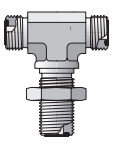
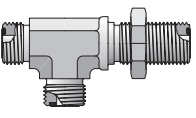
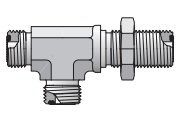
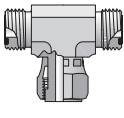
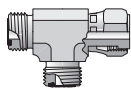
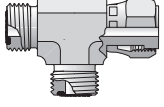
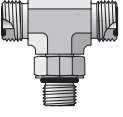
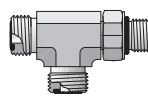
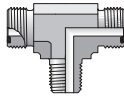
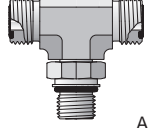
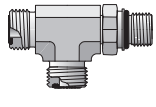
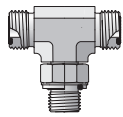
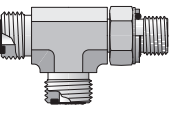

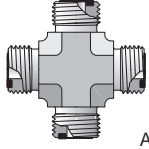

TABLE OF CONTENTS

<b>FastSeal</b>	<b>TLFA</b> FastSeal  A9	<b>Nuts, Sleeves, Locknuts</b>	<b>BL</b> Tube Nut  A9	<b>BML</b> Tube Nut - mm Hex  A9	<b>TPLS (Metric)</b> Parflange Sleeve  A10
<b>TPL (Inch)</b> Parflange Sleeve  A10	<b>TL (Inch)</b> Braze Reducer Sleeve  A11	<b>TLS (Metric)</b> Braze Reducer Sleeve  A11	<b>SBR (Inch and Metric)</b> Braze Ring  A12	<b>WLNL</b> Bulkhead Locknut  A12	<b>WLNML</b> Blkhd Locknut - mm Hex  A12
<b>Straights</b>	<b>HLO</b> Union  A13	<b>HMLLO</b> Union - mm Hex  A13	<b>WLO</b> Bulkhead Union  A13	<b>WMLO</b> Bulkhead Union - mm Hex  A14	<b>WF5OLO</b> ORFS Blkhd / SAE-ORB  A14
<b>F5OLO</b> ORFS / SAE-ORB  A15	<b>FF5OLO</b> ORFS - Long / SAE-ORB  A15	<b>FLO</b> ORFS / NPTF  A15	<b>GLO</b> ORFS / NPTF  A16	<b>F87OMLO</b> ORFS / ISO 6149  A16	<b>F82EDMLO</b> ORFS / Metric-ED  A16
<b>F42EDMLO</b> ORFS / BSPP-ED  A16	<b>LOHB3</b> ORFS / Braze Socket  A17	<b>MMLOHB3</b> ORFS / Braze - mm Hex  A17	<b>LOHT3</b> ORFS / Tube Weld  A17	<b>TLW1</b> Butt Weld / Sleeve  A18	<b>Straight Swivels</b>
<b>TRLON</b> Tube End Reducer  A18	<b>LOHL6</b> Extender and Expander  A19	<b>HL6</b> ORFS Swivel Union  A19	<b>F65OL</b> ORFS Swivel / SAE-ORB  A19	<b>G65L</b> ORFS Swivel / SAE-ORB  A19	<b>F6L</b> ORFS Swivel / NPTF  A20
<b>G6L</b> ORFS Swivel / NPTF  A20	<b>F687OML</b> ORFS Swivel / ISO 6149  A20	<b>F682EDML</b> ORFS Swivel / Metric-ED  A20	<b>F642EDML</b> ORFS Swivel / BSPP-ED  A21	<b>45° Elbows</b>	<b>WNLO</b> Bulkhead Union  A21
<b>WNMLO</b> Bulkhead Union - mm Hex  A22	<b>V6LO</b> ORFS Swivel Elbow  A22	<b>V5OLO</b> ORFS / SAE-ORB  A22	<b>V87OMLO</b> ORFS / ISO 6149  A22	<b>VLO</b> ORFS / NPTF  A23	<b>V4OMLO</b> ORFS / BSPP-ORR  A23

 <p><b>90° Elbows</b></p>	<p><b>ELO</b> Union Elbow</p>  <p>A23</p>	<p><b>EMLO</b> Union Elbow - mm Hex</p>  <p>A23</p>	<p><b>WELO</b> Bulkhead Union</p>  <p>A24</p>	<p><b>WEMLO</b> Bulkhead Union - mm Hex</p>  <p>A24</p>	<p><b>C6LO</b> ORFS Swivel Elbow</p>  <p>A25</p>
	<p><b>C6MLO</b> Swivel Elbow - mm Hex</p>  <p>A25</p>	<p><b>AOEL6</b> ORFS Swivel / SAE-ORB</p>  <p>A25</p>	<p><b>C5OLO</b> ORFS / SAE-ORB</p>  <p>A25</p>	<p><b>CC5OLO</b> ORFS / SAE-ORB - Long</p>  <p>A26</p>	<p><b>CLO</b> ORFS / NPTF</p>  <p>A26</p>
<p><b>CC87OMLO</b> ORFS / ISO 6149 - Long</p>  <p>A27</p>	<p><b>C8OMLO</b> ORFS / Metric-ORR</p>  <p>A27</p>	<p><b>C4OMLO</b> ORFS / BSPP-ORR</p>  <p>A28</p>	 <p><b>Tees</b></p>	<p><b>JLO</b> Union Tee</p>  <p>A28</p>	<p><b>JMLO</b> Union Tee - mm Hex</p>  <p>A29</p>
<p><b>WJLO</b> Bulkhead Branch</p>  <p>A29</p>	<p><b>WJMLO</b> Blkhd Branch - mm Hex</p>  <p>A29</p>	<p><b>WJJLO</b> Bulkhead Run</p>  <p>A30</p>		<p><b>WJJMLO</b> Bulkhead Run - mm Hex</p>  <p>A30</p>	<p><b>S6LO</b> ORFS Swivel Branch</p>  <p>A31</p>
<p><b>R6LO</b> ORFS Swivel Run</p>  <p>A31</p>	<p><b>R6MLO</b> Swivel Run - mm Hex</p>  <p>A31</p>	<p><b>S5OLO</b> SAE-ORB Branch Tee</p>  <p>A32</p>	<p><b>R5OLO</b> SAE-ORB Run Tee</p>  <p>A32</p>	<p><b>SLO</b> NPTF Branch Tee</p>  <p>A33</p>	<p><b>S87OMLO</b> ISO 6149 Branch Tee</p>  <p>A33</p>
<p><b>R87OMLO</b> ISO 6149 Run Tee</p>  <p>A34</p>	<p><b>S4OMLO</b> BSPP-ORR Branch Tee</p>  <p>A34</p>	<p><b>R4OMLO</b> BSPP-ORR Run Tee</p>  <p>A35</p>	 <p><b>Crosses</b></p>	<p><b>KLO</b> Union Cross</p>  <p>A35</p>	 <p><b>Plugs and Caps</b></p>
<p><b>PNLO</b> ORFS Plug</p>  <p>A36</p>	<p><b>PNMLO</b> ORFS Plug - mm Hex</p>  <p>A36</p>	<p><b>FNL</b> ORFS Cap</p>  <p>A36</p>		<p><b>FNML</b> ORFS Cap - mm Hex</p>  <p>A36</p>	

**A**

**TABLE OF CONTENTS**

### Conversion Adapters (Shown in Section J)







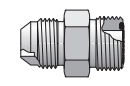
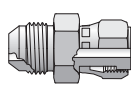
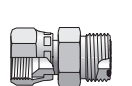
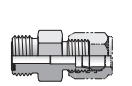
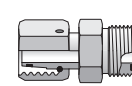
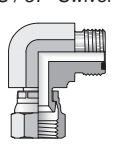

	<b>XHLO</b> 37° Flare / ORFS  J3	<b>XHL6</b> 37° Flare / ORFS Swivel  J3	<b>LOHX6</b> ORFS / 37° Swivel  J3	<b>BUHLO</b> ORFS / Flareless (inch)  J4	<b>LOHU86</b> Metric Swivel (EO)/ORFS  J4
	<b>LOEX6</b> ORFS / 37° Swivel  J3				

TABLE OF CONTENTS

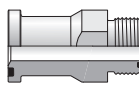
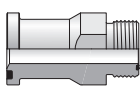

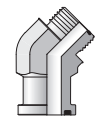

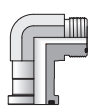

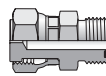
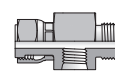
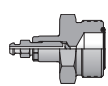
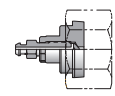
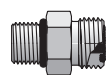

### Flange Adapters (Shown in Section K)

	<b>LOHQ1</b> Code 61 / ORFS  K12	<b>LOHQ2</b> Code 62 / ORFS  K12	<b>LOVQ1</b> Code 61 / ORFS  K32	<b>LOVQ2</b> Code 62 / ORFS  K32	<b>LOEQ1</b> Code 61 / ORFS  K33
	<b>LOEQ2</b> Code 62 / ORFS  K33				

### Diagnostic, Bleed Adapters & Screen Fittings (Shown in Section L)

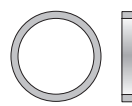
	<b>LOHL6 Orifice</b> Orifice Swivel with Orifice / ORFS  L9	<b>LOHL6G5TP</b> Orifice Swivel / ORFS / SAE-ORB  L5	<b>PNLOBA</b> Bleed Screw / ORFS  L10	<b>FNLBA</b> Bleed Screw / SAE-ORB  L10	<b>Screen Fittings</b>  L12

### O-Rings and Seals (Shown in Section M)

	<b>ORFS O-Ring</b>  M4	<b>SAE O-Ring</b>  M4	<b>ISO 6149 O-Ring</b>  M5	<b>Metric O-Ring</b>  M5	<b>Metric Retaining Ring</b>  M5
	<b>BSPP O-Ring</b>  M6	<b>BSPP Retaining O-Ring</b>  M6	<b>EOlastic Seal Ring</b>  M6		

## Seal-Lok Introduction

The Seal-Lok fitting meets or exceeds the strict requirements of SAE J1453 and ISO 8434-3. It is an O-ring face seal type fitting that consists of a nut, a body, an O-ring and a sleeve. As shown in Fig. A1, the tube is flanged to 90° (or the tube may be brazed instead to a braze-type sleeve). When the fitting is assembled, it compresses an O-ring in the precision machined groove of the fitting body to form a leak tight seal.

Seal-Lok fittings are suitable for a wide range of tube wall thicknesses and are readily adaptable to inch or metric tubing and hose. (Please refer to Table S14 located in the General Technical section for min./max. tube wall thickness). Seal-Lok's leak-free design and rugged construction make it suitable for a variety of applications where higher pressures, vibration and impulse are prevalent.

## How Seal-Lok Fittings Work

The Seal-Lok fitting body face contains a high durometer Trap-Seal to maximize retention in a precision machined groove, known as a Captive O-ring Groove (CORG) referenced in Fig. A2. As the nut is tightened onto the fitting body, the Trap-Seal is compressed between the body and flat face of the tube flange or braze sleeve to form a tight, positive seal (see Fig. A1).

As the two faces come in contact, further tightening of the nut produces a sharp rise in assembly torque. A solid pull of the wrench at this point, to recommended assembly torque, completes the assembly. The sharp torque rise gives a "solid feel" at assembly, minimizing the possibility of over tightening.

Because the sealing surfaces are flat and perpendicular to the assembly pull, they remain virtually free of distortion during assembly, giving Seal-Lok fittings practically unlimited remakeability. The seal should be inspected at each disassembly and replaced when necessary. **See the O-rings and Seals section for information on replacement ORFS O-rings.**

Because the tubing is a sealing surface, it must be smooth, free of any nicks, scratches, spiral tool marks, splits or weld beads. Seamless tube is recommended for Seal-Lok fittings for ease in flanging and bending. Certain types of harder tubes that are not fully annealed may not be suitable for flanging due to the potential for immediate or long-term cracking of the tube flange. For specific tube type and wall thickness recommendations, please see Table S11 and S14 in the General Technical Section.

## Reference locations

**Dynamic Pressure Ratings:** Please refer to the last column of the part number tables located on the following pages of this section for the appropriate dynamic pressure ratings.

**Recommended Tube Wall Thickness:** Please refer to Table S14 located in the General Technical section.

**Assembly and Installation:** Please refer to Seal-Lok Assembly located within the Assembly/Installation section of this catalog.

**Standard material specifications:** Please refer to Table T1 located in the Appendix section.

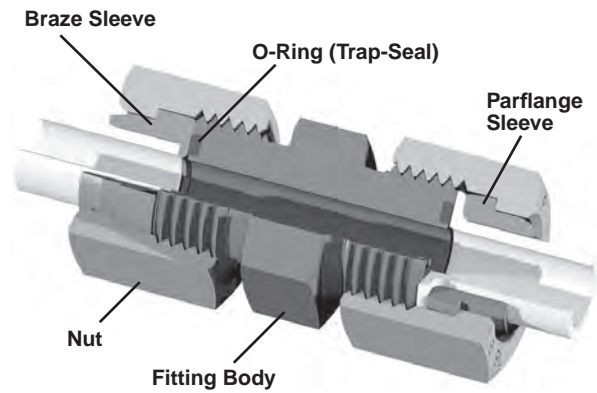

Fig. A1 — Seal-Lok Union cutaway with flanged and brazed assemblies

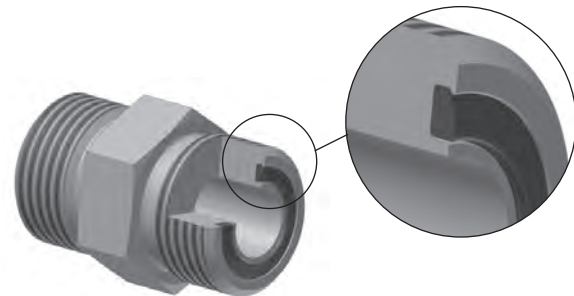

Fig. A2 — Captive O-ring Groove (CORG) Cutaway with Parker's Trap-Seal

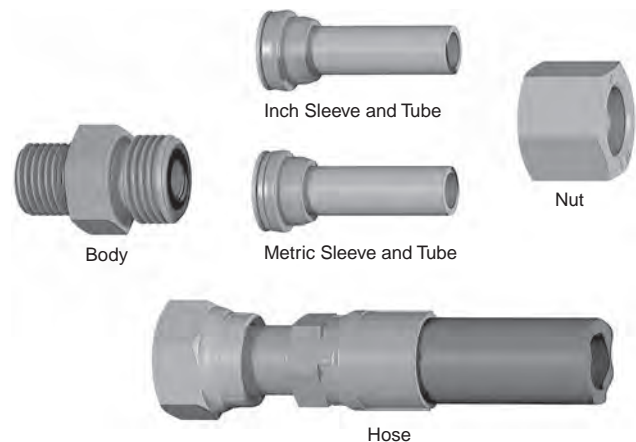

Fig. A3 — Seal-Lok Works with Inch or Metric Tube and Hose

A

TABLE  
OF  
CONTENTS

VISUAL  
INDEX

**Seal Material Selection:** Please refer to Table S12 in the General Technical section of this catalog.

## International Acceptance

The tube/hose end connection for metric Seal-Lok is the same as standard (inch) Seal-Lok. It consists of a nut, a body, an O-ring, & a sleeve. The difference is at the port end of the fitting. Instead of the SAE straight thread connection for example, it

features a similar connection with metric threads per ISO 6149-2 or ISO 9974-1. Additionally, the fitting body, tube nut and locknut are manufactured with metric hexes or wrench flats for shaped fittings. The metric Seal-Lok fittings meet or exceed all requirements of ISO 8434-3.

To identify the metric sleeves used for metric tubing, there is a groove machined into the TPLS & TLS sleeves.

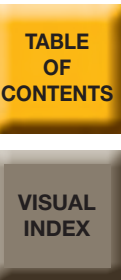

## Universal Push-to-Connect (UPTC) Introduction

Traditionally, the fluid power industry has utilized threaded connectors to make a leak free connection. The speed of making connections is slow and the reliability of the connection is dependent on proper assembly procedures. Parker's UPTC connectors, on the other hand, rely on a mechanical retaining mechanism (other than threads) for holding power. No tools are required to assemble, and the reliability and speed of making connections with the UPTC design is greatly improved.

## Design and Construction

UPTC Seal-Lok consists of a base Seal-Lok ORFS fitting, a UPTC nut (including internal sealing and retaining elements) and a UPTC hose assembly, as shown in figure A4. The base ORFS fitting is a highly reliable and widely available off-the-shelf standard SAE J1453 adapter. The sealing O-ring is supported by a pressure energized anti-extrusion ring that prevents O-ring extrusion and ensures tight sealing even under high pressure. Once fully engaged, the retaining element is positively trapped between the male and UPTC nut. The dust seal keeps contamination out as well as giving a visual indication that the male stud has been inserted all the way. There is also a clear tactile indicator at the end of the push indicating a proper connection. Once a proper connection is made, the dust seal is covered by the UPTC nut which provides proof of full engagement for easy inspection and quality control.

Once connected, the UPTC nut is permanently attached to the UPTC hose end similar to a traditional swivel nut. To disconnect, just use a wrench to unscrew the UPTC nut from the base adapter. Re-connection is possible by tightening the UPTC nut back to the base adapter, if the connection is not damaged. If the hose is damaged, it can be replaced by installing a readily available standard Seal-Lok ORFS hose assembly, or a new UPTC assembly.

### Features

- Available in sizes 1/4", 3/8", 1/2", 5/8", 3/4", and 1"
- Utilizes all Seal-Lok adapters for a wide variety of configurations, providing excellent field serviceability
- Meets or exceeds SAE 100R2 pressure ratings
- Includes visual and tactile installation indicators
- Self-aligning nipple eliminates hose twist during assembly
- No special tooling required for disassembly
- Utilizes elastomeric seals, including Parker's patented Trap-Seal

## Reference Locations

**Assembly and Installation:** Please refer to Seal-Lok Assembly located within the Assembly/Installation of this catalog.

**Dynamic Pressure Ratings:** Please refer to the last column of the part number tables located on the following pages of this section for the appropriate dynamic pressure ratings.



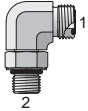
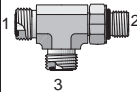

Fig. A4 — UPTC Seal-Lok is adaptable to a UPTC hydraulic or thermoplastic hose assembly. To be used with ET, EN, or EU hose ends.



## How to order examples

To order Seal-Lok UPTC, a couple key changes must be made to the standard Seal-Lok nomenclature:

1. "UR" must be inserted after the tube and port end sizes. This is the UPTC series callout.
2. A binary code is used to identify which fitting ends receive the UPTC subassembly. Specifically, a "1" denotes a UPTC end and a "0" denotes the standard ORFS or port end.

Base Seal-Lok Part	UPTC Part #	Explanation
	8 C5OLO-S	<b>8UR10 C5OLO-S</b> Uniform size, UPTC subassembly on 1st end only
	8-10 C5OLO-S	<b>8-10UR10 C5OLO-S</b> Jump size, UPTC subassembly on 1st end only
	8 R5OLO-S	<b>8UR101 R5OLO-S</b> Uniform size, UPTC subassembly on 1st and 3rd end
	8-10-8 R5OLO-S	<b>8-10-8UR001 R5OLO-S</b> Jump size, UPTC subassembly on 3rd end only
	8-10-8 R5OLO-S	<b>8-10-8UR100 R5OLO-S</b> Jump size, UPTC subassembly on 1st end only
	8M14F87OMLOS	<b>8M14UR10F87OMLOS</b> Compressed nomenclature, UPTC subassembly on 1st end only

## The Parker Advantage

**Trap Seal™:** The patented trapezoidal seal of the Seal-Lok tube end allows for maximum O-ring retention in the CORG groove. This advantage over the competition increases the productivity of assembly as well as offers the maximum assurance for a leak free connection. Ultimately, operational and maintenance costs can be avoided.

**Resistance to over-torque:** The minimum requirement for a Seal-Lok connection is to withstand 200% torque above the rated value. This reduces the frequency of metal distortion and the potential of leaks. Seal-Lok reduces production assembly and maintenance costs by its resistance to over-torque.

**Zero clearance:** The flat face of Seal-Lok allow maintenance for easy and fast drop-in installation. This reduces rework costs from a design and assembly perspective.

**High pressure rating:** Seal-Lok offers a high pressure rating which can be used in a wide range of applications. This provides the opportunity to standardize across multiple product lines, saving procurement and inventory costs.

**Superior Plating:** Parker's Seal-Lok steel fittings come standard with ToughShield (TS1000) plating, giving them unmatched protection against red rust. In ASTM B117 neutral salt spray testing, TS1000 remained rust free for up to 1,000 hours, far exceeding SAE industry requirements of 144 hours and also outperforming the competition. See [www.ravagesofredrust.com](http://www.ravagesofredrust.com) for more information.

**Robust Port Stud:** The adjustable port stud is manufactured with a longer locknut designed to cover the uppermost threads. Since the backup washer is never exposed to the upper threads, it cannot be damaged during assembly. During assembly, exposed upper threads, which are common with fittings from other fitting manufacturers, can lead to a deformed backup washer that can pinch the o-ring and create an o-ring extrusion gap that has the potential to leak. The longer locknut also provides a greater grip area for the wrench for easier assembly.

**Unlimited reusability:** When a Seal-Lok connection is completely assembled and disassembled, very little metal is distorting in the connection. Therefore, Seal-Lok allows for unlimited reusability in the field, reducing the component replacement and maintenance costs of the connection.

**Universal Push to Connect (UPTC):** Parker's UPTC offers a quick and easy way to assemble Seal-Lok configurations. UPTC is ideal for hard to reach applications or to speed up the process of assembly. The tangible operational and maintenance costs associated with each connection made will be reduced when using UPTC.

A

TABLE  
OF  
CONTENTS

VISUAL  
INDEX

Dimensions and pressures for reference only, subject to change.

# Seal-Lok O-Ring Face Seal Tube Ends

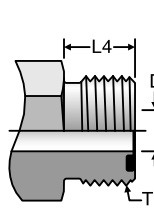

Seal-Lok Male Tube End

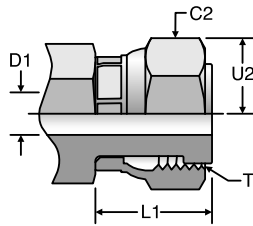

Seal-Lok Female Swivel

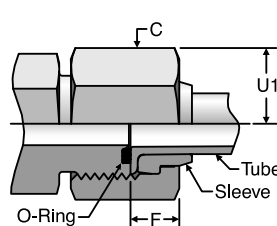

Seal-Lok Tube End Assembly

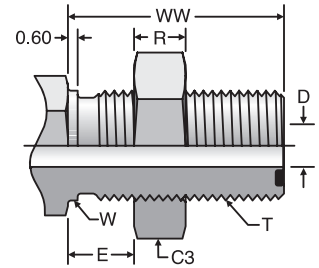

Seal-Lok Bulkhead

TABLE OF CONTENTS

VISUAL INDEX

SAE Dash	Tube O.D.		Thread	Tube Nut Hex		Swivel Nut Hex		Bulkhead Locknut Hex		Nominal Drill Tube End	Nominal Drill Swivel End	Max Bulkhead Thickness	Tube Nut Assembled Allowance	Swivel Turn Back	Male Turn Back	Bulkhead			Across Corners	
	T	C		C2	C3	Locknut Thickness	Pilot Dia	Length	Tube Nut Hex							Swivel Nut Hex				
Size	(in.)	(mm)	UN/UNF	(in.)	(mm)	(in.)	(mm)	(in.)	(mm)	(in)	(in)	(in)	(in)	(in)	(in)	(in)	(in)	(in)	(in)	(in)
4	1/4	6	9/16-18	11/16	17	11/16	17	13/16	22	0.177	0.157	0.55	0.270	0.650	0.394	0.27	0.563	1.24	0.80	0.80
6	3/8	8 10	11/16-16	13/16	22	13/16	22	1	27	0.256	0.256	0.55	0.340	0.715	0.443	0.32	0.688	1.34	0.94	0.94
8	1/2	12	13/16-16	15/16	24	15/16	24	1 1/8	30	0.374	0.354	0.55	0.400	0.865	0.512	0.35	0.813	1.44	1.08	1.08
10	5/8	14 15 16	1-14	1 1/8	30	1 1/8	30	1 5/16	36	0.492	0.453	0.55	0.455	0.980	0.610	0.41	1.000	1.60	1.30	1.30
12	3/4	18 20	1 3/16-12	1 3/8	36	1 3/8	36	1 1/2	41	0.610	0.551	0.55	0.510	1.110	0.677	0.41	1.188	1.64	1.58	1.58
14	7/8	—	1 5/16-12	1 1/2	—	1 1/2	—	1 5/8	—	0.709	0.709	0.55	0.512	1.145	0.697	0.41	1.313	1.66	1.74	1.74
16	1	22 25	1 7/16-12	1 5/8	41	1 5/8	41	1 3/4	46	0.807	0.787	0.55	0.596	1.190	0.697	0.41	1.438	1.66	1.88	1.88
20	1 1/4	28 30 32	1 11/16-12	1 7/8	50	1 7/8	50	2	50	1.024	1.024	0.55	0.566	1.251	0.697	0.41	1.688	1.66	2.16	2.12
24	1 1/2	35 38	2-12	2 1/4	60	2 1/4	60	2 3/8	60	1.260	1.260	0.55	0.545	1.330	0.697	0.41	2.000	1.66	2.60	2.60
32	2	42 50	2 1/2-12	2 7/8	—	2 7/8	—	2 3/4	—	1.772	1.732	0.50	0.606	1.690	0.874	0.55	2.500	1.83	3.32	3.32

- 1) D and D1 nominal may vary from the values shown in the chart by 0.004 to 0.008. Contact the Tube Fittings Division if there are any questions.
- 2) Recommended clearance hole = W + 0.015.
- 3) See page M4 for ORFS O-rings.
- 4) Note: For port and stud end dimensions reference section F: Pipe Fittings and Port Adapters.

Dimensions and pressures for reference only, subject to change.

Click here for CADs, Support Resources or to Configure Parts Online

# TLFA

FastSeal

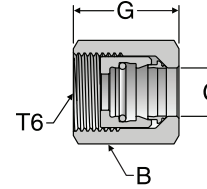

TUBE FITTING PART #	TUBE OD (in)	T6 UN/UNF - 2B	B Hex (in)	C (in)	G (in)	Dynamic Pressure (psi)* Tube Wall OD (in)			
						0.035	0.049	0.065	0.083
4 TLFA-S	1/4	9/16-18	11/16	0.25	0.95	3,350	5,150	-	-
6 TLFA-S	3/8	11/16-16	13/16	0.38	1.04	-	3,300	4,500	-
8 TLFA-S	1/2	13/16-16	15/16	0.50	1.10	-	2,400	3,250	4,300

\*NOTE: Pressure rating is based on tube wall OD for Carbon Steel Material. Consult Factory For Walls Outside Listed Range

Please see the Assembly and Installation section for FastSeal Assembly instructions and refer to the equipment section for FastSeal assembly tools.

Parker's patent-pending FastSeal creates quick leak-free permanent ORFS tube end connections with just a wrench. Get more details on this new technology now.

# BL

Tube Nut  
ORFS

SAE 520110

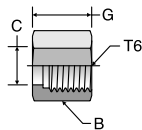

TUBE FITTING PART #	END SIZE (in.)	T6 UNF/UNF-2B	B HEX (in.)	C (in.)	G (in.)	Material	
						-S	-SS
4 BL	1/4	9/16 - 18	11/16	0.410	0.59	•	•
5 BL	5/16	5/8 - 18	3/4	0.470	0.63	•	•
6 BL	3/8	11/16 - 16	13/16	0.530	0.67	•	•
8 BL	1/2	13/16 - 16	15/16	0.650	0.79	•	•
10 BL	5/8	1 - 14	1 1/8	0.830	0.94	•	•
12 BL	3/4	1 3/16 - 12	1 3/8	0.950	1.04	•	•
12-14 BL	7/8	1 3/16 - 12	1 3/8	0.990	1.20	•	•
14 BL	7/8	1 5/16 - 12	1 1/2	1.075	1.04	•	•
16 BL	1	1 7/16 - 12	1 5/8	1.150	1.08	•	•
20 BL	1 1/4	1 11/16 - 12	1 7/8	1.420	1.08	•	•
24 BL	1 1/2	2 - 12	2 1/4	1.730	1.08	•	•
32 BL	2	2 1/2 - 12	2 7/8	2.220	1.30	•	•

\*\* These tube nuts should not be exposed to annealing temperatures, such as furnace brazing. Contact the Tube Fittings Division for information on special nuts.

• Stainless steel tube nuts are prelubricated for ease of assembly.

**WARNING:** This product can expose you to chemicals including Lead and Lead Compounds which is known to the State of California to cause cancer and birth defects or other reproductive harm. For more information go to [www.p65warnings.ca.gov](http://www.p65warnings.ca.gov).

# BML

Tube Nut – mm Hex  
ORFS

ISO 8434-3 NA  
SAE 52M0110A

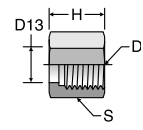

TUBE FITTING PART #	END SIZE		D THREAD UN/UNF-2B	D13 DRILL (mm)	H (mm)	S HEX (mm)	Material S
	(mm)	(in.)					
4BML	6	1/4	9/16 - 18	10.50	15.0	17	•
6BML	8,10	3/8	11/16 - 16	13.55	17.5	22	•
8BML	12	1/2	13/16 - 16	16.60	20.0	24	•
10BML	14,15,16	5/8	1 - 14	21.10	24.0	30	•
12BML	18,20	3/4	1 3/16 - 12	24.15	26.5	36	•
16BML	22,25	1	1 7/16 - 12	29.10	27.5	41	•
20BML	28,30,32	1 1/4	1 11/16 - 12	36.00	27.5	50	•
24BML	35,38	1 1/2	2 - 12	44.00	27.5	60	•

**WARNING:** This product can expose you to chemicals including Lead and Lead Compounds which is known to the State of California to cause cancer and birth defects or other reproductive harm. For more information go to [www.p65warnings.ca.gov](http://www.p65warnings.ca.gov).

A

TABLE OF CONTENTS

VISUAL INDEX

FAQs

ASSEMBLY

TUBE FAB EQUIP

GEN TECH



Click here for CADs, Support Resources or to Configure Parts Online

## TPLS (Metric)

Parflange Sleeve for  
Metric Tubing  
ORFS Mechanically  
Attachable Sleeve

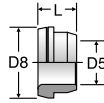

TUBE FITTING PART #	USED WITH FITTING SIZE	D5 END SIZE (mm)	D8 DIA (mm)	L (mm)	Material
					S
TPLS6	-4	6	12.75	7.5	•
TPLS8	-6	8	15.75	8.5	•
TPLS10	-6	10	15.75	8.5	•
TPLS12	-8	12	18.90	10.5	•
TPLS14	-10	14	23.50	10.5	•
TPLS15	-10	15	23.50	10.5	•
TPLS16	-10	16	23.50	10.5	•
TPLS18	-12	18	27.80	12.0	•
TPLS20	-12	20	27.80	12.0	•
TPLS25	-16	25	34.00	13.5	•
TPLS30	-20	30	40.50	13.0	•
TPLS32	-20	32	40.50	13.0	•
TPLS35	-24	35	48.50	12.5	•
TPLS38	-24	38	48.50	12.5	•

- Must be mechanically attached using Parflange system.
- Additional -S not required, TPLS6 is complete part number.

**⚠ WARNING:** This product can expose you to chemicals including Lead and Lead Compounds which is known to the State of California to cause cancer and birth defects or other reproductive harm. For more information go to [www.p65warnings.ca.gov](http://www.p65warnings.ca.gov).

## TPL (Inch)

Parflange Sleeve for  
Inch Tubing  
ORFS Mechanically  
Attachable Sleeve

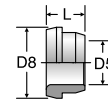

TUBE FITTING PART #	D5 END SIZE (in.)	D8 DIA (in.)	L (in.)	Material
				-S
4 TPL	1/4	0.50	0.30	•
6 TPL	3/8	0.62	0.34	•
8 TPL	1/2	0.74	0.42	•
10 TPL	5/8	0.92	0.42	•
12 TPL	3/4	1.09	0.47	•
16 TPL	1	1.34	0.53	•
20 TPL	1 1/4	1.59	0.51	•
24 TPL	1 1/2	1.91	0.49	•

- Must be mechanically attached using Parflange system.

**⚠ WARNING:** This product can expose you to chemicals including Lead and Lead Compounds which is known to the State of California to cause cancer and birth defects or other reproductive harm. For more information go to [www.p65warnings.ca.gov](http://www.p65warnings.ca.gov).

TABLE OF CONTENTS

VISUAL INDEX

FAQs

ASSEMBLY

TUBE FAB EQUIP

GEN TECH

Dimensions and pressures for reference only, subject to change.

Click here for CADs, Support Resources or to Configure Parts Online

## TL (Inch)

Braze Sleeve for Inch Tubing  
ORFS Silver Braze Sleeve Reducer

SAE 520115

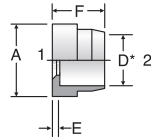

## TLS (Metric)

Braze Sleeve for Metric Tubing  
ORFS Silver Braze Sleeve

ISO 8434-3 BRSL  
SAE 5201M15

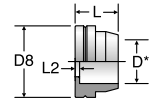

TUBE FITTING PART #	END SIZE		A (in.)	D* (in.)	E (in.)	F (in.)	Material	
	1 (in.)	2 (in.)					-S	-SS
4 TL	1/4		0.50	0.26	0.04	0.37	•	•
6 TL	3/8		0.62	0.38	0.04	0.37	•	•
6-4 TL	3/8	1/4	0.62	0.26	0.08	0.41	•	•
8 TL	1/2		0.75	0.51	0.04	0.37	•	•
8-4 TL	1/2	1/4	0.75	0.26	0.14	0.47	•	•
8-6 TL	1/2	3/8	0.75	0.38	0.14	0.47	•	•
10 TL	5/8		0.92	0.63	0.06	0.41	•	•
10-4 TL	5/8	1/4	0.92	0.26	0.20	0.53	•	•
10-6 TL	5/8	3/8	0.92	0.38	0.20	0.53	•	•
10-8 TL	5/8	1/2	0.92	0.51	0.20	0.53	•	•
12 TL	3/4		1.10	0.76	0.06	0.55	•	•
12-4 TL	3/4	1/4	1.10	0.26	0.24	0.57	•	•
12-6 TL	3/4	3/8	1.10	0.38	0.24	0.57	•	•
12-8 TL	3/4	1/2	1.10	0.51	0.24	0.57	•	•
12-10 TL	3/4	5/8	1.10	0.63	0.22	0.57	•	•
12-14 TL**	3/4	7/8	1.10	0.88	0.06	0.65	•	•
14 TL***	7/8		1.22	0.88	0.06	0.55	•	•
16 TL	1		1.35	1.01	0.06	0.61	•	•
16-8 TL	1	1/2	1.35	0.51	0.28	0.61	•	•
16-10 TL	1	5/8	1.35	0.63	0.26	0.61	•	•
16-12 TL	1	3/4	1.35	0.76	0.18	0.67	•	•
16-14 TL	1	7/8	1.35	0.88	0.18	0.67	•	•
20 TL	1 1/4		1.60	1.26	0.06	0.61	•	•
20-12 TL	1 1/4	3/4	1.60	0.76	0.28	0.77	•	•
20-16 TL	1 1/4	1	1.60	1.01	0.28	0.83	•	•
24 TL	1 1/2		1.91	1.51	0.06	0.61	•	•
24-16 TL	1 1/2	1	1.91	1.01	0.28	0.83	•	•
24-20 TL	1 1/2	1 1/4	1.91	1.26	0.28	0.83	•	•
32 TL	2		2.41	2.01	0.06	0.65	•	•

Unplated part, oil dipped for corrosion protection.

\* D is for silver brazing.

\*\* 12-14 TL must be assembled with 12-14 BL.

• Uses SBR silver braze rings

**WARNING:** This product can expose you to chemicals including Lead and Lead Compounds which is known to the State of California to cause cancer and birth defects or other reproductive harm. For more information go to [www.p65warnings.ca.gov](http://www.p65warnings.ca.gov).

TUBE FITTING PART #	USED WITH FITTING SIZE	D* END SIZE (mm)	D8 DIA (mm)	L (mm)	L2 (mm)	Material	
						S	SS
TLS6	-4	6	12.8	9.5	1.0	•	•
TLS8**	-6	8	15.8	9.5	1.0	•	•
TLS10	-6	10	15.8	9.5	1.0	•	•
TLS12	-8	12	18.9	9.5	1.0	•	•
TLS16	-10	16	23.5	10.5	1.5	•	•
TLS20	-12	20	27.9	14.0	1.5	•	•
TLS25	-16	25	34.2	15.5	1.5	•	•
TLS30	-20	30	40.6	15.5	1.5	•	•
TLS38	-24	38	48.5	15.5	1.5	•	•

Unplated part, oil dipped for corrosion protection.

\* D is for silver brazing.

• Uses SBR (metric) silver braze rings

• Stainless steel part number example: TLSS10

\*\*Different from SAE

**WARNING:** This product can expose you to chemicals including Lead and Lead Compounds which is known to the State of California to cause cancer and birth defects or other reproductive harm. For more information go to [www.p65warnings.ca.gov](http://www.p65warnings.ca.gov).

A

TABLE OF CONTENTS

VISUAL INDEX

FAQs

ASSEMBLY

TUBE FAB EQUIP

GEN TECH

Dimensions and pressures for reference only, subject to change.

Click here for CADs, Support Resources or to Configure Parts Online

## SBR (Inch)

Silver Braze Ring for Inch Tubing

TUBE FITTING PART #	END SIZE (in.)	A DIA (in.)	B (in.)	C (in.)	E (in.)
4 SBR	1/4	0.260	—	—	0.05
6 SBR	3/8	0.390	0.07	0.03	—
8 SBR	1/2	0.515	0.07	0.03	—
10 SBR	5/8	0.640	0.07	0.03	—
12 SBR	3/4	0.765	0.08	0.04	—
14 SBR	7/8	0.890	—	—	0.06
16 SBR	1	1.015	0.08	0.04	—
20 SBR	1 1/4	1.265	0.08	0.04	—
24 SBR	1 1/2	1.515	0.08	0.04	—
32 SBR	2	2.015	—	—	0.09

SBR recommended for steel or copper tubing. -S not required.  
SBR-SS recommended for stainless tubing, but can be used on steel tubing.  
Contact the Tube Fittings Division for braze rings used in marine or special applications.

**WARNING:** This product can expose you to chemicals including Cadmium which is known to the State of California to cause cancer and birth defects or other reproductive harm. For more information go to [www.p65warnings.ca.gov](http://www.p65warnings.ca.gov).

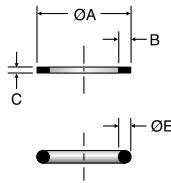
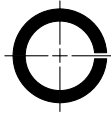

## SBR (Metric)

Silver Braze Ring for Metric Tubing

TUBE FITTING PART #	END SIZE (mm)	A DIA (mm)	E (mm)
SBR 6mm	6	6.4	1.2
SBR 8mm	8	8.4	1.2
SBR 10mm	10	10.4	1.2
SBR 12mm	12	12.4	1.2
SBR 16mm	16	16.4	1.2
SBR 20mm	20	20.4	1.6
SBR 25mm	25	25.4	1.6
SBR 30mm	30	30.4	1.6
SBR 38mm	38	38.4	1.6

SBR recommended for steel or copper tubing.  
SBR-SS recommended for stainless tubing, but can be used on steel tubing.  
Contact the Tube Fittings Division for braze rings used in marine or special applications.

**WARNING:** This product can expose you to chemicals including Cadmium which is known to the State of California to cause cancer and birth defects or other reproductive harm. For more information go to [www.p65warnings.ca.gov](http://www.p65warnings.ca.gov).

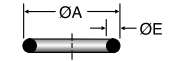
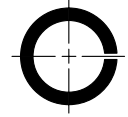

## WLNL

Bulkhead Locknut

SAE 520118

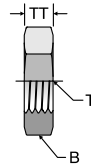

TUBE FITTING PART #	END SIZE (in.)	T TUBE END UN/UNF-2A	B HEX (in.)	TT (in.)	Material -S
4 WLNL	1/4	9/16 - 18	13/16	0.27	•
6 WLNL	3/8	11/16 - 16	1	0.31	•
8 WLNL	1/2	13/16 - 16	1 1/8	0.35	•
10 WLNL	5/8	1 - 14	1 5/16	0.41	•
12 WLNL	3/4	1 3/16 - 12	1 1/2	0.41	•
14 WLNL*	7/8	1 5/16 - 12	1 5/8	0.41	•
16 WLNL	1	1 7/16 - 12	1 3/4	0.41	•
20 WLNL	1 1/4	1 11/16 - 12	2	0.41	•
24 WLNL	1 1/2	2 - 12	2 3/8	0.41	•

\* Size 14 is not included in SAE J1453.

**WARNING:** This product can expose you to chemicals including Lead and Lead Compounds which is known to the State of California to cause cancer and birth defects or other reproductive harm. For more information go to [www.p65warnings.ca.gov](http://www.p65warnings.ca.gov).

## WLNML

Bulkhead Locknut – mm Hex

ISO 8434-3 BHLN  
SAE 52M0118

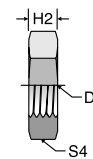

TUBE FITTING PART #	END SIZE		D TUBE END UN/UNF-2B	H2 (mm)	S4 HEX (mm)	Material S
	(mm)	(in.)				
4WLNML	6	1/4	9/16 - 18	7.0	22	•
6WLNML	8,10	3/8	11/16 - 16	8.0	27	•
8WLNML	12	1/2	13/16 - 16	9.0	30	•
10WLNML	14,15,16	5/8	1 - 14	10.5	36	•
12WLNML	18,20	3/4	1 3/16 - 12	10.5	41	•
16WLNML	22,25	1	1 7/16 - 12	10.5	46	•
20WLNML	28,30,32	1 1/4	1 11/16 - 12	10.5	50	•
24WLNML	35,38	1 1/2	2 - 12	10.5	60	•

**WARNING:** This product can expose you to chemicals including Lead and Lead Compounds which is known to the State of California to cause cancer and birth defects or other reproductive harm. For more information go to [www.p65warnings.ca.gov](http://www.p65warnings.ca.gov).

Dimensions and pressures for reference only, subject to change.

Click here for CADs, Support Resources or to Configure Parts Online

# HLO

Union  
ORFS / ORFS

SAE 520101

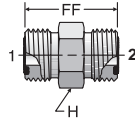

TUBE FITTING PART #	END SIZE		FF (in.)	H HEX (in.)	Dynamic Pressure (x 1,000 PSI)	
	1 (in.)	2 (in.)			-S	-SS
	4 HLO	1/4			1/4	1.08
6 HLO	3/8	3/8	1.22	3/4	9.2	9.2
6-4 HLO	3/8	1/4	1.18	3/4	9.2	9.2
8 HLO	1/2	1/2	1.40	7/8	9.2	9.2
8-6 HLO	1/2	3/8	1.32	7/8	9.2	9.2
10 HLO	5/8	5/8	1.67	1 1/16	6.0	6.0
10-8 HLO	5/8	1/2	1.57	1 1/16	6.0	6.0
12 HLO	3/4	3/4	1.85	1 1/4	6.0	6.0
12-8 HLO	3/4	1/2	1.69	1 1/4	6.0	6.0
12-10 HLO	3/4	5/8	1.79	1 1/4	6.0	6.0
16 HLO	1	1	1.95	1 1/2	6.0	6.0
16-12 HLO	1	3/4	1.93	1 1/2	6.0	6.0
20 HLO	1 1/4	1 1/4	2.03	1 3/4	6.0	6.0
20-16 HLO	1 1/4	1	2.03	1 3/4	6.0	6.0
24 HLO	1 1/2	1 1/2	2.09	2 1/8	5.0	5.0
32 HLO*	2	2	2.48	2 3/4	3.0	3.0

\* Hex different from SAE

**WARNING:** This product can expose you to chemicals including Lead and Lead Compounds which is known to the State of California to cause cancer and birth defects or other reproductive harm. For more information go to [www.p65warnings.ca.gov](http://www.p65warnings.ca.gov).

# HMLO

Union – mm Hex  
ORFS / ORFS

ISO 8434-3 S  
SAE 52M0101

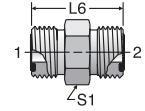

TUBE FITTING PART #	END SIZE 1 & 2		L6 (mm)	S1 HEX (mm)	Dynamic Pressure (x 1,000 PSI)	
	(mm)	(in.)			S	SS
	4HMLO	6			1/4	27.5
6HMLO	8,10	3/8	31.0	19	9.2	9.2
8HMLO	12	1/2	35.5	22	9.2	9.2
10HMLO	14,15,16	5/8	42.5	27	6.0	6.0
12HMLO	18,20	3/4	47.0	32	6.0	6.0
16HMLO	22,25	1	49.5	41	6.0	6.0
20HMLO	28,30,32	1 1/4	51.5	46	6.0	6.0
24HMLO	35,38	1 1/2	53.0	55	5.0	5.0

**WARNING:** This product can expose you to chemicals including Lead and Lead Compounds which is known to the State of California to cause cancer and birth defects or other reproductive harm. For more information go to [www.p65warnings.ca.gov](http://www.p65warnings.ca.gov).

# WLO

Bulkhead Union  
ORFS / ORFS

SAE 520601

WLO-WLNL Body with Locknut  
(See page A12 for WLNL)

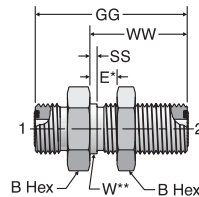

TUBE FITTING PART #	END SIZE (in.)	B HEX (in.)	E MAX (in.)	GG (in.)	SS	W DIA (in.)	WW (in.)	Dynamic Pressure (x 1,000 PSI)	
								-S	-SS
								4 WLO	1/4
6 WLO	3/8	1	0.55	2.09	0.06	0.69	1.34	9.2	0.12
8 WLO	1/2	1 1/8	0.55	2.30	0.06	0.81	1.44	9.2	0.12
10 WLO	5/8	1 5/16	0.55	2.62	0.06	1.00	1.59	6.0	0.12
12 WLO	3/4	1 1/2	0.55	2.72	0.06	1.19	1.63	6.0	0.12
16 WLO	1	1 3/4	0.55	2.76	0.06	1.44	1.65	6.0	0.12
20 WLO	1 1/4	2	0.55	2.76	0.06	1.69	1.65	6.0	0.12
24 WLO	1 1/2	2 3/8	0.55	2.76	0.06	2.00	1.65	5.0	0.12

\*\* W – Bulkhead pilot diameter. Recommended clearance hole is W + 0.015".

**WARNING:** This product can expose you to chemicals including Lead and Lead Compounds which is known to the State of California to cause cancer and birth defects or other reproductive harm. For more information go to [www.p65warnings.ca.gov](http://www.p65warnings.ca.gov).

A

TABLE OF CONTENTS

VISUAL INDEX

FAQs

ASSEMBLY

TUBE FAB EQUIP

GEN TECH

Dimensions and pressures for reference only, subject to change

[Click here for CADs, Support Resources or to Configure Parts Online](#)

## WMLO

Bulkhead Union – mm Hex  
ORFS / ORFS

ISO 8434-3 BHS  
SAE 52M0601

WMLO-WLNML - Body with Locknut  
(See page A12 for WLNML)

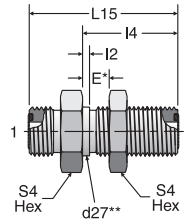

TUBE FITTING PART #	END SIZE		d27** (mm)	E (mm)	I4 (mm)	I2 (mm)	L15 (mm)	S4 HEX (mm)	Dynamic Pressure (x 1,000 PSI)	
	1 & 2								S	SS
	(mm)	(in.)								
4WMLO	6	1/4	14.3	14	31.5	1.5	48.0	22	9.2	9.2
6WMLO	8,10	3/8	17.5	14	34.0	1.5	53.0	27	9.2	9.2
8WMLO	12	1/2	20.6	14	36.5	1.5	58.5	30	9.2	9.2
10WMLO	14,15,16	5/8	25.4	14	40.5	1.5	66.5	36	6.0	6.0
12WMLO	18,20	3/4	30.2	14	41.5	1.5	69.0	41	6.0	6.0
16WMLO	22,25	1	36.5	14	42.0	1.5	70.0	46	6.0	6.0
20WMLO	28,30,32	1 1/4	42.9	14	42.0	1.5	70.0	50	6.0	6.0
24WMLO	35,38	1 1/2	50.8	14	42.0	1.5	70.0	60	5.0	5.0

\* E – Maximum bulkhead thickness.

\*\*d27 – Bulkhead pilot diameter. Recommended clearance hole is d27 + 0.4 mm

**WARNING:** This product can expose you to chemicals including Lead and Lead Compounds which is known to the State of California to cause cancer and birth defects or other reproductive harm. For more information go to [www.p65warnings.ca.gov](http://www.p65warnings.ca.gov).

## WF5OLO

Straight Thread Bulkhead  
Connector

ORFS / SAE-ORB

WF5OLO-WLNL - Body with Locknut  
(See page A12 for WLNL)

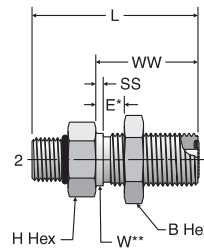

TUBE FITTING PART #	END SIZE		B HEX (in.)	E MAX (in.)	H HEX (in.)	L (in.)	SS (in.)	W DIA (in.)	WW (in.)	Dynamic Pressure (x 1,000 PSI)	
	1 (in.)	2 UN/UNF-2A								-S	-SS
	4 WF5OLO	1/4									
6 WF5OLO	3/8	9/16 - 18	1	0.55	1	2.31	0.06	0.69	1.34	9.2	9.2
8 WF5OLO	1/2	3/4 - 16	1 1/8	0.55	1 1/8	2.60	0.06	0.81	1.44	9.2	9.2
10 WF5OLO	5/8	7/8 - 14	1 5/16	0.55	1 5/16	2.69	0.06	1.00	1.59	6.0	6.0
12 WF5OLO	3/4	1 1/16 - 12	1 1/2	0.55	1 1/2	2.89	0.06	1.19	1.63	6.0	6.0
16 WF5OLO	1	1 5/16 - 12	1 3/4	0.55	1 3/4	2.95	0.06	1.44	1.65	6.0	6.0

\* E – Maximum bulkhead thickness.

\*\* W – Bulkhead pilot diameter. Recommended clearance hole is W + 0.015".

**WARNING:** This product can expose you to chemicals including Lead and Lead Compounds which is known to the State of California to cause cancer and birth defects or other reproductive harm. For more information go to [www.p65warnings.ca.gov](http://www.p65warnings.ca.gov).

- TABLE OF CONTENTS
- VISUAL INDEX
- FAQs
- ASSEMBLY
- TUBE FAB EQUIP
- GEN TECH

Dimensions and pressures for reference only, subject to change.

Click here for CADs, Support Resources or to Configure Parts Online

## F5OLO

Straight Thread Connector  
ORFS / SAE-ORB

SAE 520120

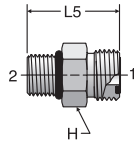

TUBE FITTING PART #	END SIZE		H HEX (in.)	L5 (in.)	Dynamic Pressure (x 1,000 PSI)	
	1 (in.)	2 UN/UNF-2A			-S	-SS
	4 F5OLO	1/4			7/16 - 20	5/8
4-5 F5OLO*	1/4	1/2 - 20	5/8	1.16	9.2	9.2
4-6 F5OLO	1/4	9/16 - 18	3/4	1.20	9.2	9.2
4-8 F5OLO	1/4	3/4 - 16	7/8	1.32	9.2	9.2
6 F5OLO	3/8	9/16 - 18	3/4	1.26	9.2	9.2
6-4 F5OLO	3/8	7/16 - 20	3/4	1.34	9.2	9.2
6-5 F5OLO	3/8	1/2 - 20	3/4	1.22	9.2	9.2
6-8 F5OLO	3/8	3/4 - 16	7/8	1.38	9.2	9.2
6-10 F5OLO	3/8	7/8 - 14	1	1.52	6.0	6.0
6-12 F5OLO	3/8	1 1/16 - 12	1 1/4	1.67	6.0	6.0
8 F5OLO	1/2	3/4 - 16	7/8	1.44	9.2	9.2
8-4 F5OLO	1/2	7/16 - 20	7/8	1.44	9.2	9.2
8-6 F5OLO	1/2	9/16 - 18	7/8	1.48	9.2	9.2
8-10 F5OLO	1/2	7/8 - 14	1	1.59	6.0	6.0
8-12 F5OLO	1/2	1 1/16 - 12	1 1/4	1.75	6.0	6.0
8-16 F5OLO	1/2	1 5/16 - 12	1 1/2	1.79	6.0	6.0
10 F5OLO	5/8	7/8 - 14	1 1/16	1.69	6.0	6.0
10-6 F5OLO	5/8	9/16 - 18	1 1/16	1.63	6.0	6.0
10-8 F5OLO	5/8	3/4 - 16	1 1/16	1.77	6.0	6.0
10-12 F5OLO	5/8	1 1/16 - 12	1 1/4	1.85	6.0	6.0
10-16 F5OLO	5/8	1 5/16 - 12	1 1/2	1.89	6.0	6.0
12 F5OLO	3/4	1 1/16 - 12	1 1/4	1.91	6.0	6.0
12-6 F5OLO	3/4	9/16 - 16	1 1/4	1.77	6.0	6.0
12-8 F5OLO	3/4	3/4 - 16	1 1/4	1.91	6.0	6.0
12-10 F5OLO	3/4	7/8 - 14	1 1/4	1.99	6.0	6.0
12-16 F5OLO	3/4	1 5/16 - 12	1 1/2	1.95	6.0	6.0
14 F5OLO*	7/8	1 3/16 - 12	1 3/8	1.91	3.0	3.0
16 F5OLO	1	1 5/16 - 12	1 1/2	1.97	6.0	6.0
16-8 F5OLO	1	3/4 - 16	1 1/2	1.96	6.0	6.0
16-10 F5OLO	1	7/8 - 14	1 1/2	2.05	6.0	6.0
16-12 F5OLO	1	1 1/16 - 12	1 1/2	2.15	6.0	6.0
16-20 F5OLO	1	1 5/8 - 12	1 7/8	2.07	6.0	6.0
16-24 F5OLO	1	1 7/8 - 12	2 1/8	2.13	5.0	5.0
20 F5OLO	1 1/4	1 5/8 - 12	1 7/8	2.07	6.0	6.0
20-16 F5OLO	1 1/4	1 5/16 - 12	1 7/8	2.28	6.0	6.0
20-24 F5OLO	1 1/4	1 7/8 - 12	2 1/8	2.13	5.0	5.0
24 F5OLO	1 1/2	1 7/8 - 12	2 1/8	2.13	5.0	5.0
24-20 F5OLO	1 1/2	1 5/8 - 12	2 1/8	2.34	5.0	5.0
32 F5OLO*	2	2 1/2 - 12	2 3/4	2.32	3.0	3.0

\*Different from SAE

**WARNING:** This product can expose you to chemicals including Lead and Lead Compounds which is known to the State of California to cause cancer and birth defects or other reproductive harm. For more information go to [www.p65warnings.ca.gov](http://www.p65warnings.ca.gov).

## FF5OLO

Long Straight Thread Connector  
ORFS-Long / SAE-ORB

SAE 521720 (previously 520122)

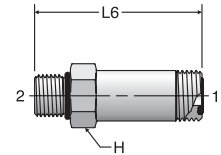

TUBE FITTING PART #	END SIZE		H HEX (in.)	L6 (in.)	Dynamic Pressure (x 1,000 PSI)	
	1 (in.)	2 UN/UNF-2A			-S	-SS
	4 FF5OLO	1/4			7/16 - 20	5/8
6 FF5OLO	3/8	9/16 - 18	3/4	2.27	9.2	9.2
6-4 FF5OLO	3/8	7/16 - 20	3/4	2.39	9.2	9.2
8 FF5OLO	1/2	3/4 - 16	7/8	2.67	9.2	9.2
10 FF5OLO	5/8	7/8 - 14	1 1/16	3.14	6.0	6.0
12 FF5OLO	3/4	1 1/16 - 12	1 1/4	3.76	6.0	6.0
16 FF5OLO	1	1 5/16 - 12	1 1/2	4.14	6.0	6.0
20 FF5OLO	1 1/4	1 5/8 - 12	1 7/8	4.76	6.0	6.0
24 FF5OLO	1 1/2	1 7/8 - 12	2 1/8	5.26	5.0	5.0

**WARNING:** This product can expose you to chemicals including Lead and Lead Compounds which is known to the State of California to cause cancer and birth defects or other reproductive harm. For more information go to [www.p65warnings.ca.gov](http://www.p65warnings.ca.gov).

## FLO

Male Pipe Connector  
ORFS / NPTF

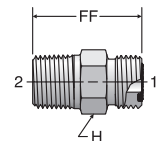

TUBE FITTING PART #	END SIZE		FF (in.)	H HEX (in.)	Dynamic Pressure (x 1,000 PSI)	
	1 (in.)	2 NPTF			-S	-SS
	4 FLO	1/4			1/8 - 27	1.07
4-4 FLO	1/4	1/4 - 18	1.26	5/8	6.0	6.0
4-6 FLO	1/4	3/8 - 18	1.32	3/4	6.0	6.0
4-8 FLO	1/4	1/2 - 14	1.52	7/8	6.0	6.0
6 FLO	3/8	1/4 - 18	1.25	3/4	6.0	6.0
6-2 FLO	3/8	1/8 - 27	1.16	3/4	6.0	6.0
6-6 FLO	3/8	3/8 - 18	1.34	3/4	6.0	6.0
6-8 FLO	3/8	1/2 - 14	1.55	7/8	6.0	6.0
8 FLO	1/2	3/8 - 18	1.48	7/8	6.0	6.0
8-4 FLO	1/2	1/4 - 18	1.48	7/8	6.0	6.0
8-8 FLO	1/2	1/2 - 14	1.64	7/8	6.0	6.0
8-12 FLO	1/2	3/4 - 14	1.69	1 1/8	6.0	6.0
10 FLO	5/8	1/2 - 14	1.82	1 1/16	6.0	6.0
10-12 FLO	5/8	3/4 - 14	1.82	1 1/8	5.5	5.5
12 FLO	3/4	3/4 - 14	1.93	1 1/4	5.5	5.5
12-8 FLO	3/4	1/2 - 14	1.93	1 1/4	6.0	6.0
12-16 FLO	3/4	1 - 11 1/2	2.13	1 3/8	4.5	4.5
16 FLO	1	1 - 11 1/2	2.19	1 1/2	4.5	4.5
16-12 FLO	1	3/4 - 14	2.00	1 1/2	5.5	5.5
16-20 FLO	1	1 1/4 - 11 1/2	2.30	1 3/4	3.0	3.0
20 FLO	1 1/4	1 1/4 - 11 1/2	2.30	1 7/8	3.0	3.0
20-12 FLO	1 1/4	3/4 - 14	2.02	1 7/8	5.5	5.5
20-16 FLO	1 1/4	1 - 11 1/2	2.27	1 7/8	4.5	4.5
24 FLO	1 1/2	1 1/2 - 11 1/2	2.40	2 1/8	3.0	3.0

**WARNING:** This product can expose you to chemicals including Lead and Lead Compounds which is known to the State of California to cause cancer and birth defects or other reproductive harm. For more information go to [www.p65warnings.ca.gov](http://www.p65warnings.ca.gov).

Dimensions and pressures for reference only, subject to change.

**A**

TABLE OF CONTENTS

VISUAL INDEX

FAQs

ASSEMBLY

TUBE FAB EQUIP

GEN TECH



Click here for CADs, Support Resources or to Configure Parts Online

## GLO

Female NPT  
ORFS / Female Pipe

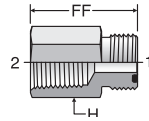

TUBE FITTING PART #	END SIZE		FF (in.)	H HEX (in.)	Dynamic Pressure (x 1,000 PSI)	
	1 (in.)	2 NPTF			-S	-SS
	4 GLO	1/4			1/8 - 27	1.03
4-4 GLO	1/4	1/4 - 18	1.25	3/4	6.0	6.0
6 GLO	3/8	1/4 - 18	1.30	3/4	6.0	6.0
6-6 GLO	3/8	3/8 - 18	1.34	7/8	6.0	6.0
8 GLO	1/2	3/8 - 18	1.34	7/8	6.0	6.0

**WARNING:** This product can expose you to chemicals including Lead and Lead Compounds which is known to the State of California to cause cancer and birth defects or other reproductive harm. For more information go to [www.p65warnings.ca.gov](http://www.p65warnings.ca.gov).

## F42EDMLO

Male Connector – BSPP  
(for ISO 1179-1 Port)  
ORFS / BSPP-ED

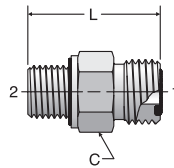

TUBE FITTING PART #	END SIZE			C HEX (mm)	L (mm)	Dynamic Pressure (x 1,000 PSI)	
	1 (mm)	2 (in.)	BSPP			S	SS
	4F42EDMLO	6	1/4			1/8 - 28	17
4-4F42EDMLO	6	1/4	1/4 - 19	19	30.5	9.2	9.2
4-6F42EDMLO	6	1/4	3/8 - 19	22	31.6	9.2	9.2
4-8F42EDMLO	6	1/4	1/2 - 14	27	35.4	6.0	6.0
6F42EDMLO	8,10	3/8	1/4 - 19	19	31.9	9.2	9.2
6-2F42EDMLO	8,10	3/8	1/8 - 28	19	31.1	9.2	9.2
6-6F42EDMLO	8,10	3/8	3/8 - 19	22	33.0	9.2	9.2
6-8F42EDMLO	8,10	3/8	1/2 - 14	27	36.5	6.0	6.0
6-12F42EDMLO	8,10	3/8	3/4 - 14	32	40.3	6.0	6.0
8F42EDMLO	12	1/2	3/8 - 19	22	34.6	9.2	9.2
8-4F42EDMLO	12	1/2	1/4 - 19	22	37.5	9.2	9.2
8-8F42EDMLO	12	1/2	1/2 - 14	27	38.4	6.0	6.0
8-12F42EDMLO	12	1/2	3/4 - 14	32	41.9	6.0	6.0
10F42EDMLO	14,15,16	5/8	1/2 - 14	27	41.1	6.0	6.0
10-6F42EDMLO	14,15,16	5/8	3/8 - 19	27	42.4	6.0	6.0
10-12F42EDMLO	14,15,16	5/8	3/4 - 14	32	44.3	6.0	6.0
12F42EDMLO	18,20	3/4	3/4 - 14	32	46.1	6.0	6.0
12-8F42EDMLO	18,20	3/4	1/2 - 14	32	48.5	6.0	6.0
12-16F42EDMLO	18,20	3/4	1 - 11	41	47.5	6.0	6.0
12-20F42EDMLO	18,20	3/4	1 1/4 - 11	50	53.0	6.0	6.0
16F42EDMLO	22,25	1	1 - 11	41	49.8	6.0	6.0
16-12F42EDMLO	22,25	1	3/4 - 14	38	50.3	6.0	6.0
16-20F42EDMLO	22,25	1	1 1/4 - 11	50	53.8	6.0	6.0
16-24F42EDMLO	22,25	1	1 1/2 - 11	55	57.5	5.0	5.0
20F42EDMLO	28,30,32	1 1/4	1 1/4 - 11	50	53.8	6.0	6.0
20-16F42EDMLO	28,30,32	1 1/4	1 - 11	48	55.9	6.0	6.0
20-24F42EDMLO	28,30,32	1 1/4	1 1/2 - 11	55	57.6	5.0	5.0
24F42EDMLO	38	1 1/2	1 1/2 - 11	55	57.6	5.0	5.0

**WARNING:** This product can expose you to chemicals including Lead and Lead Compounds which is known to the State of California to cause cancer and birth defects or other reproductive harm. For more information go to [www.p65warnings.ca.gov](http://www.p65warnings.ca.gov).

## F87OMLO

Metric Straight Thread Connector  
ORFS / ISO 6149

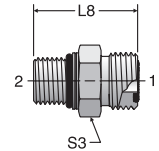

ISO 8434-3 SDS  
SAE 52M0187

TUBE FITTING PART #	END SIZE			L8 (mm)	S3 HEX (mm)	Dynamic Pressure (x 1,000 PSI)	
	1 (mm)	2 (in.)	ISO 261			S	SS
	4M12F87OMLO	6	1/4			M12X1.5	28.5
4M14F87OMLO	6	1/4	M14X1.5	29.5	19	9.2	9.2
6M12F87OMLO	8,10	3/8	M12X1.5	32.0	22	9.2	9.2
6M14F87OMLO	8,10	3/8	M14X1.5	32.0	22	9.2	9.2
6M16F87OMLO	8,10	3/8	M16X1.5	33.5	22	9.2	9.2
6M18F87OMLO	8,10	3/8	M18X1.5	36.1	24	9.2	9.2
8M14F87OMLO	12	1/2	M14X1.5	35.1	24	9.2	9.2
8M16F87OMLO	12	1/2	M16X1.5	36.6	24	9.2	9.2
8M18F87OMLO	12	1/2	M18X1.5	38.0	24	9.2	9.2
8M22F87OMLO	12	1/2	M22X1.5	39.6	27	6.0	6.0
8M27F87OMLO	12	1/2	M27X2.0	44.2	32	6.0	6.0
10M18F87OMLO	14,15,16	5/8	M18X1.5	41.0	27	6.0	6.0
10M22F87OMLO	14,15,16	5/8	M22X1.5	42.0	27	6.0	6.0
10M27F87OMLO	14,15,16	5/8	M27x2.0	47.0	32	6.0	6.0
12M22F87OMLO	18,20	3/4	M22X1.5	45.0	32	6.0	6.0
12M27F87OMLO	18,20	3/4	M27X2.0	48.5	32	6.0	6.0
12M33F87OMLO	18,20	3/4	M33X2.0	51.5	41	6.0	6.0
16M27F87OMLO	22,26	1	M27X2.0	33.6	41	6.0	6.0
16M33F87OMLO	22,25	1	M33X2.0	52.0	41	6.0	6.0
20M33F87OMLO	28,30,32	1 1/4	M33x2.0	35.1	46	6.0	6.0
20M42F87OMLO	28,30,32	1 1/4	M42X2.0	54.5	50	5.0	5.0
24M48F87OMLO	35,38	1 1/2	M48X2.0	57.0	55	5.0	5.0

**WARNING:** This product can expose you to chemicals including Lead and Lead Compounds which is known to the State of California to cause cancer and birth defects or other reproductive harm. For more information go to [www.p65warnings.ca.gov](http://www.p65warnings.ca.gov).

## F82EDMLO

Male Connector – Metric  
(for ISO 9974-1 Port)  
ORFS / Metric-ED

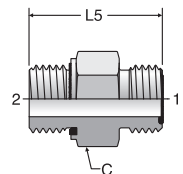

TUBE FITTING PART #	END SIZE			C HEX (mm)	L5 (mm)	Dynamic Pressure (x 1,000 PSI)	
	1 (mm)	2 (in.)	Metric			S	SS
	4M12F82EDMLO	6	1/4			M12X1.5	17
4M14F82EDMLO	6	1/4	M14X1.5	19	30.5	9.2	9.2
6M14F82EDMLO	8,10	3/8	M14X1.5	19	31.9	9.2	9.2
6M16F82EDMLO	8,10	3/8	M16X1.5	22	31.9	9.2	9.2
8M16F82EDMLO	12	1/2	M16X1.5	22	32.0	9.2	9.2
8M18F82EDMLO	12	1/2	M18X1.5	24	34.6	9.2	9.2
10M22F82EDMLO	14,15,16	5/8	M22X1.5	27	41.1	6.0	6.0
12M22F82EDMLO	18,20	3/4	M22X1.5	32	42.7	6.0	6.0
12M27F82EDMLO	18,20	3/4	M27X2	32	46.1	6.0	6.0
16M33F82EDMLO	22,25	1	M33X2	41	49.8	6.0	6.0
20M42F82EDMLO	28,30,32	1 1/4	M42X2	50	54.0	5.0	5.0

**WARNING:** This product can expose you to chemicals including Lead and Lead Compounds which is known to the State of California to cause cancer and birth defects or other reproductive harm. For more information go to [www.p65warnings.ca.gov](http://www.p65warnings.ca.gov).

Dimensions and pressures for reference only, subject to change.

Click here for CADs, Support Resources or to Configure Parts Online

# MMLOHB3

Braze Connector  
ORFS / Braze Socket

ISO 8434-3 BRS  
SAE 52M01M04

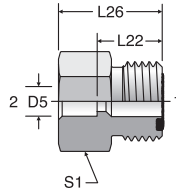

TUBE FITTING PART #	END SIZE		D5* TUBE SOCKET	L22 (mm)	L26 (mm)	S1 HEX	Dynamic Pressure (x 1,000 PSI)		
	1	2					S	SS	
	(mm)	(in.)					(mm)	(mm)	
4-6MMLOHB3	6	1/4	6	6.15	13.5	22.0	17	9.2	9.2
4-8MMLOHB3	6	1/4	8	8.15	13.5	22.0	17	9.2	9.2
6-10MMLOHB3	8, 10	3/8	10	10.15	14.5	23.0	19	9.2	9.2
8-12MMLOHB3	12	1/2	12	12.15	16.0	24.5	22	9.2	9.2
10-16MMLOHB3	14, 15, 16	5/8	16	16.15	19.0	27.5	27	6.0	6.0
12-20MMLOHB3	18, 20	3/4	20	20.18	21.0	33.5	32	6.0	6.0
16-25MMLOHB3	22, 25	1	25	25.18	24.5	38.5	41	6.0	6.0
20-30MMLOHB3	28, 30, 32	1 1/4	30	30.20	24.5	38.5	46	6.0	6.0
24-38MMLOHB3	35, 38	1 1/2	38	38.20	24.5	38.5	55	5.0	5.0

\* D5 is for silver brazing. Standard steel parts are not recommended for welding.

**WARNING:** This product can expose you to chemicals including Lead and Lead Compounds which is known to the State of California to cause cancer and birth defects or other reproductive harm. For more information go to [www.p65warnings.ca.gov](http://www.p65warnings.ca.gov).

# LOHB3

Braze Connector  
ORFS / Braze Socket

SAE 520104

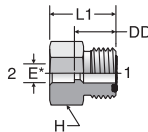

TUBE FITTING PART #	END SIZE		DD (in.)	E* DIA (in.)	H HEX (in.)	L1 (in.)	Dynamic Pressure (x 1,000 PSI)	
	1	2					-S	-SS
	(in.)	(in.)					(in.)	(in.)
4 LOHB3	1/4	1/4	0.53	0.26	5/8	0.86	9.2	9.2
4-6 LOHB3	1/4	3/8	0.53	0.38	5/8	0.86	9.2	9.2
6 LOHB3	3/8	3/8	0.57	0.38	3/4	0.90	9.2	9.2
6-4 LOHB3	3/8	1/4	0.57	0.26	3/4	0.90	9.2	9.2
6-8 LOHB3	3/8	1/2	0.57	0.51	3/4	0.90	9.2	9.2
8 LOHB3	1/2	1/2	0.63	0.51	7/8	0.97	9.2	9.2
8-4 LOHB3**	1/2	1/4	0.64	0.26	7/8	0.97	9.2	9.2
8-6 LOHB3	1/2	3/8	0.63	0.38	7/8	0.97	9.2	9.2
8-10 LOHB3	1/2	5/8	0.63	0.63	7/8	0.97	6.0	6.0
8-12 LOHB3**	1/2	3/4	0.67	0.76	1 1/16	1.16	6.0	6.0
10 LOHB3	5/8	5/8	0.74	0.63	1 1/16	1.07	6.0	6.0
10-6 LOHB3	5/8	3/8	0.74	0.38	1 1/16	1.07	6.0	6.0
10-8 LOHB3	5/8	1/2	0.74	0.51	1 1/16	1.07	6.0	6.0
10-12 LOHB3	5/8	3/4	0.74	0.76	1 1/16	1.23	6.0	6.0
12 LOHB3	3/4	3/4	0.83	0.76	1 1/4	1.32	6.0	6.0
12-8 LOHB3	3/4	1/2	0.83	0.51	1 1/4	1.16	6.0	6.0
12-10 LOHB3	3/4	5/8	0.83	0.63	1 1/4	1.16	6.0	6.0
12-16 LOHB3	3/4	1	0.83	1.01	1 1/2	1.38	6.0	6.0
16 LOHB3	1	1	0.97	1.01	1 1/2	1.52	6.0	6.0
16-8 LOHB3**	1	1/2	0.97	0.51	1 1/2	1.30	6.0	6.0
16-12 LOHB3	1	3/4	0.97	0.76	1 1/2	1.46	6.0	6.0
16-20 LOHB3	1	1 1/4	0.96	1.26	1 3/4	1.52	6.0	6.0
20 LOHB3	1 1/4	1 1/4	0.97	1.26	1 3/4	1.52	6.0	6.0
20-16 LOHB3	1 1/4	1	0.97	1.01	1 3/4	1.52	6.0	6.0
20-24 LOHB3	1 1/4	1 1/2	0.97	1.51	2 1/8	1.52	5.0	5.0
24 LOHB3	1 1/2	1 1/2	0.97	1.51	2 1/8	1.52	5.0	5.0
24-20 LOHB3	1 1/2	1 1/4	0.97	1.26	2 1/8	1.52	5.0	5.0

\* E is for silver brazing. Standard steel parts are not recommended for welding.

\*\* Size 14 is not included in SAE J1453.

**WARNING:** This product can expose you to chemicals including Lead and Lead Compounds which is known to the State of California to cause cancer and birth defects or other reproductive harm. For more information go to [www.p65warnings.ca.gov](http://www.p65warnings.ca.gov).

# LOHT3

Tube Stub Connector  
ORFS / Tube Weld

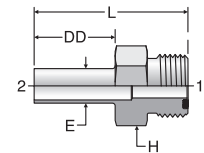

TUBE FITTING PART #	END SIZE	DD (in.)	E DIA (in.)	H HEX (in.)	L (in.)	Dynamic Pressure (x 1,000 PSI)	
						1 & 2	-SS
	(in.)					(in.)	
4-4X035 LOHT3	1/4	0.88	0.25	5/8	1.58	5.9	5.9
6-6X035 LOHT3	3/8	0.88	0.38	3/4	1.67	3.8	3.8
8-8X065 LOHT3	1/2	1.00	0.50	7/8	1.89	5.5	5.5
12-12X065 LOHT3	3/4	1.16	0.75	1 1/4	2.35	3.5	3.5
12-16X065 LOHT3	1	1.13	1.00	1 1/4	2.32	2.6	2.6
16-16X065 LOHT3	1	1.13	1.00	1 1/2	2.40	2.6	2.6

\* Contact Tube Fittings Division for pressure ratings.

**WARNING:** This product can expose you to chemicals including Lead and Lead Compounds which is known to the State of California to cause cancer and birth defects or other reproductive harm. For more information go to [www.p65warnings.ca.gov](http://www.p65warnings.ca.gov).

A

TABLE OF CONTENTS

VISUAL INDEX

FAQs

ASSEMBLY

TUBE FAB EQUIP

GEN TECH



Click here for CADs, Support Resources or to Configure Parts Online

# TLW1

Butt Weld Sleeve

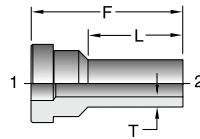

TUBE FITTING PART #	END SIZE		F (in.)	L (in.)	T (in.)	Dynamic Pressure (x 1,000 PSI)	
	1 (in.)	2 (in.)				-S	-SS
4-4X035 TLW1	1/4	1/4	1.20	0.75	0.035		5.9
6-4X035 TLW1	3/8	1/4	1.26	0.75	0.035		5.9
6-4X049 TLW1	3/8	1/4	1.26	0.75	0.049		8.6
6-6X035 TLW1	3/8	3/8	1.20	0.75	0.035		3.8
6-6X049 TLW1	3/8	3/8	1.20	0.75	0.049		5.5
6-6X065 TLW1	3/8	3/8	1.20	0.75	0.065		7.5
8-8X049 TLW1	1/2	1/2	1.20	0.75	0.049		4.0
8-8X065 TLW1	1/2	1/2	1.20	0.75	0.065		5.5
12-12X065 TLW1	3/4	3/4	1.39	0.75	0.065		3.5
12-12X083 TLW1	3/4	3/4	1.39	0.75	0.083		4.6
12-12X095 TLW1	3/4	3/4	1.39	0.75	0.095		5.3
12-8X049 TLW1	3/4	1/2	1.52	0.75	0.049		4.0
16-16X083 TLW1	1	1	1.43	0.75	0.083		3.4
16-16X095 TLW1	1	1	1.43	0.75	0.095		3.9

- TABLE OF CONTENTS
- VISUAL INDEX
- FAQs
- ASSEMBLY
- TUBE FAB EQUIP
- GEN TECH

# TRLON

Tube End Reducer  
ORFS Swivel / ORFS Tube End

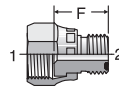

\* Assembled with Crimp Nut

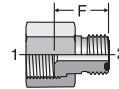

\*\* Assembled with Large BL Nut

SAE 520123 (body only)  
SAE 520123A (body with large nut)

TUBE FITTING PART #			END SIZE		F (in.)	Dynamic Pressure (x 1,000 PSI)	
TRLON	TRLON	TRLO	1 (in.)	2 (in.)		-S	-SS
*One Piece Design (With Crimp Nut)	**Two Piece Design (With Large Nut)	***Body Only (For Two-Piece Design Only)					
6-4 TRLON	—	—	3/8	1/4	0.77	9.2	9.2
—	8-4 TRLON	8-4 TRLO	1/2	1/4	0.87	9.2	9.2
8-6 TRLON	—	—	1/2	3/8	0.89	9.2	9.2
—	10-4 TRLON	10-4 TRLO	5/8	1/4	0.91	6.0	6.0
—	10-6 TRLON	10-6 TRLO	5/8	3/8	0.94	6.0	6.0
—	10-8 TRLON	10-8 TRLO	5/8	1/2	1.00	6.0	6.0
—	12-4 TRLON	12-4 TRLO	3/4	1/4	0.98	6.0	6.0
—	12-6 TRLON	12-6 TRLO	3/4	3/8	1.02	6.0	6.0
—	12-8 TRLON	12-8 TRLO	3/4	1/2	1.08	6.0	6.0
12-10 TRLON	—	—	3/4	5/8	1.16	6.0	6.0
—	16-8 TRLON	16-8 TRLO	1	1/2	1.14	6.0	6.0
—	16-10 TRLON	16-10 TRLO	1	5/8	1.26	6.0	6.0
16-12 TRLON	—	—	1	3/4	1.30	6.0	6.0
—	20-12 TRLON	20-12 TRLO	1 1/4	3/4	1.32	5.0	5.0
20-16 TRLON	—	—	1 1/4	1	1.34	5.0	5.0
—	24-12 TRLON-S	—	1 1/2	3/4	1.32	4.0	4.0
—	24-16 TRLON	24-16 TRLO	1 1/2	1	1.34	4.0	4.0
—	24-20 TRLON	24-20 TRLO	1 1/2	1 1/4	1.34	4.0	4.0
—	32-20 TRLON	32-20 TRLO	2	1 1/4	1.42	3.0	3.0
—	32-24 TRLON	32-24 TRLO	2	1 1/2	1.42	3.0	3.0

\* Assembled with crimp nut.

\*\* Assembled with large BL nut.

\*\*\*To order reducer without large nut (body only) remove the "N" from the part number (i.e., TRLO).

**WARNING:** This product can expose you to chemicals including Lead and Lead Compounds which is known to the State of California to cause cancer and birth defects or other reproductive harm. For more information go to [www.p65warnings.ca.gov](http://www.p65warnings.ca.gov).

Dimensions and pressures for reference only, subject to change.

Click here for CADs, Support Resources or to Configure Parts Online

## LOHL6

Tube End Extender / Expander  
ORFS / ORFS Swivel

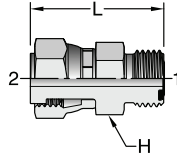

TUBE FITTING PART #	END SIZE		L (in.)	H HEX (in.)	Dynamic Pressure (x 1,000 PSI)	
	1 (in.)	2 (in.)			-S	-SS
	4 LOHL6	1/4			1/4	1.33
6 LOHL6	3/8	3/8	1.44	3/4	9.2	9.2
6-4 LOHL6	3/8	1/4	1.37	3/4	9.2	9.2
8 LOHL6	1/2	1/2	1.67	7/8	9.2	9.2
8-6 LOHL6	1/2	3/8	1.62	7/8	9.2	9.2
10-8 LOHL6	5/8	1/2	1.81	1 1/16	6.0	6.0
12-10 LOHL6	3/4	5/8	1.99	1 1/4	6.0	6.0
16-12 LOHL6	1	3/4	2.16	1 1/2	6.0	6.0
20-16 LOHL6	1 1/4	1	2.28	1 3/4	6.0	6.0
24-20 LOHL6	1 1/2	1 1/4	2.35	2 1/8	5.0	5.0

**WARNING:** This product can expose you to chemicals including Lead and Lead Compounds which is known to the State of California to cause cancer and birth defects or other reproductive harm. For more information go to [www.p65warnings.ca.gov](http://www.p65warnings.ca.gov).

## HL6

Swivel Nut Union  
ORFS Swivel / ORFS Swivel

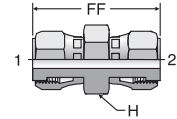

TUBE FITTING PART #	END SIZE		FF (in.)	H HEX (in.)	Dynamic Pressure (x 1,000 PSI)	
	1 (in.)	2 (in.)			-S	-SS
	4 HL6	1/4			1/4	1.59
6 HL6	3/8	3/8	1.77	3/4	9.2	9.2
8 HL6	1/2	1/2	2.12	7/8	9.2	9.2
10 HL6	5/8	5/8	2.42	1 1/16	6.0	6.0
12 HL6	3/4	3/4	2.74	1 1/4	6.0	6.0
16 HL6	1	1	2.95	1 7/16	6.0	6.0

**WARNING:** This product can expose you to chemicals including Lead and Lead Compounds which is known to the State of California to cause cancer and birth defects or other reproductive harm. For more information go to [www.p65warnings.ca.gov](http://www.p65warnings.ca.gov).

## F650L

Straight Thread Swivel Connector  
ORFS Swivel / SAE-ORB

SAE 520181

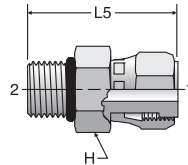

TUBE FITTING PART #	END SIZE		H HEX (in.)	L5 (in.)	Dynamic Pressure (x 1,000 PSI)	
	1 (in.)	2 UN/UNF-2A			-S	-SS
	4 F650L	1/4			7/16 - 20	5/8
6 F650L	3/8	9/16 - 18	3/4	1.57	9.2	9.2
8 F650L	1/2	3/4 - 16	7/8	1.95	9.2	9.2
10 F650L	5/8	7/8 - 14	1 1/16	2.13	6.0	6.0
12 F650L	3/4	1 1/16 - 12	1 1/4	2.34	6.0	6.0
16 F650L	1	1 5/16 - 12	1 1/2	2.66	6.0	6.0
20 F650L	1 1/4	1 5/8 - 12	1 7/8	2.66	5.0	5.0

**WARNING:** This product can expose you to chemicals including Lead and Lead Compounds which is known to the State of California to cause cancer and birth defects or other reproductive harm. For more information go to [www.p65warnings.ca.gov](http://www.p65warnings.ca.gov).

## G65L

Straight Thread Swivel  
Female Connector  
ORFS Swivel / SAE-ORB

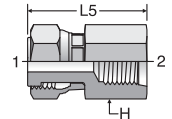

TUBE FITTING PART #	END SIZE		H HEX (in.)	L5 (in.)	Dynamic Pressure (x 1,000 PSI)	
	1 (in.)	2 UN/UNF-2B			-S	-SS
	4 G65L	1/4			7/16 - 20	3/4
4-6 G65L	1/4	9/16 - 18	13/16	1.45	6.0	6.0
6-4 G65L	3/8	7/16 - 20	3/4	1.51	6.0	6.0
8-4 G65L	1/2	7/16 - 20	7/8	1.57	6.0	6.0

**WARNING:** This product can expose you to chemicals including Lead and Lead Compounds which is known to the State of California to cause cancer and birth defects or other reproductive harm. For more information go to [www.p65warnings.ca.gov](http://www.p65warnings.ca.gov).

A

TABLE OF CONTENTS

VISUAL INDEX

FAQs

ASSEMBLY

TUBE FAB EQUIP

GEN TECH

Dimensions and pressures for reference only, subject to change.

Click here for CADs, Support Resources or to Configure Parts Online

## F6L

Pipe Thread Swivel Connector  
ORFS Swivel / NPTF

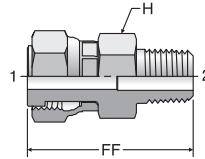

TUBE FITTING PART #	END SIZE		FF (in.)	H HEX (in.)	Dynamic Pressure (x 1,000 PSI)	
	1 (in.)	2 NPTF			-S	-SS
4-4 F6L	1/4	1/4 - 18	1.52	5/8	6.0	6.0
6 F6L	3/8	1/4 - 18	1.69	3/4	6.0	6.0
6-6 F6L	3/8	3/8 - 18	1.67	3/4	6.0	6.0
8 F6L	1/2	3/8 - 18	1.95	3/4	6.0	6.0
8-8 F6L	1/2	1/2 - 14	2.14	7/8	6.0	6.0
10 F6L	5/8	1/2 - 14	2.29	1 1/16	6.0	6.0
12 F6L	3/4	3/4 - 14	2.37	1 1/4	5.5	5.5
16 F6L	1	1 - 11 1/2	2.87	1 1/2	4.5	4.5

**WARNING:** This product can expose you to chemicals including Lead and Lead Compounds which is known to the State of California to cause cancer and birth defects or other reproductive harm. For more information go to [www.p65warnings.ca.gov](http://www.p65warnings.ca.gov).

## G6L

Female Pipe Thread Swivel Connector  
ORFS Swivel / NPTF

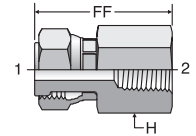

TUBE FITTING PART #	END SIZE		FF (in.)	H (in.)	Dynamic Pressure (x 1,000 PSI)	
	1 (in.)	2 NPTF			-S	-SS
6 G6L	3/8	1/4 - 18	1.60	7/8	6.0	6.0
8-4 G6L	1/2	1/4 - 18	1.75	7/8	6.0	6.0

**WARNING:** This product can expose you to chemicals including Lead and Lead Compounds which is known to the State of California to cause cancer and birth defects or other reproductive harm. For more information go to [www.p65warnings.ca.gov](http://www.p65warnings.ca.gov).

## F687OML

Swivel ISO 6149 Connector  
ORFS Swivel / ISO 6149

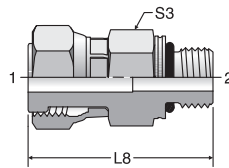

TUBE FITTING PART #	END SIZE			L8 (mm)	S3 HEX (mm)	Dynamic Pressure (x 1,000 PSI)	
	1		2 ISO 261			S	SS
	(mm)	(in.)					
4M12F687OML	6	1/4	M12x1.5	37.0	17	9.2	9.2
6M12F687OML	8, 10	3/8	M12x1.5	39.0	17	9.2	9.2
6M14F687OML	8, 10	3/8	M14x1.5	38.0	19	9.2	9.2
6M16F687OML	8, 10	3/8	M16x1.5	43.5	22	9.2	9.2
8M16F687OML	12	1/2	M16x1.5	48.0	22	9.2	9.2
10M22F687OML	14, 15, 16	5/8	M22x1.5	53.0	27	6.0	6.0
10M27F687OML	14, 15, 16	5/8	M27x2	57.0	32	6.0	6.0
12M27F687OML	18, 20	3/4	M27x2	59.5	32	6.0	6.0
16M33F687OML	22, 25	1	M33x2	67.5	41	6.0	6.0

**WARNING:** This product can expose you to chemicals including Lead and Lead Compounds which is known to the State of California to cause cancer and birth defects or other reproductive harm. For more information go to [www.p65warnings.ca.gov](http://www.p65warnings.ca.gov).

## F682EDML

Swivel Metric Connector  
ORFS Swivel / Metric-ED

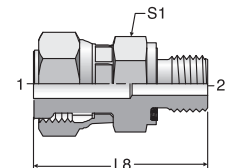

TUBE FITTING PART #	END SIZE			L8 (mm)	S1 HEX (mm)	Dynamic Pressure (x 1,000 PSI)	
	1		2 Metric			S	SS
	(mm)	(in.)					
4M12F682EDML	6	1/4	M12x1.5	38.2	17	9.2	9.2
6M14F682EDML	8, 10	3/8	M14x1.5	40.2	19	9.2	9.2
8M16F682EDML	12	1/2	M16x1.5	47.3	22	9.2	9.2
10M22F682EDML	14, 15, 16	5/8	M22X1.5	51.8	27	6.0	6.0
12M27F682EDML	18, 20	3/4	M27X2	57.2	32	6.0	6.0
16M33F682EDML	22, 25	1	M33X2	67.0	41	6.0	6.0

**WARNING:** This product can expose you to chemicals including Lead and Lead Compounds which is known to the State of California to cause cancer and birth defects or other reproductive harm. For more information go to [www.p65warnings.ca.gov](http://www.p65warnings.ca.gov).

TABLE OF CONTENTS

VISUAL INDEX

FAQs

ASSEMBLY

TUBE FAB EQUIP

GEN TECH

Dimensions and pressures for reference only, subject to change.

[Click here for CADs, Support Resources or to Configure Parts Online](#)

## F642EDML

Swivel BSPP Connector  
ORFS Swivel / BSPP-ED

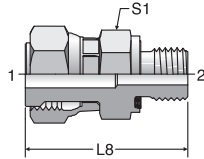

TUBE FITTING PART #	END SIZE			L8 (mm)	S1 HEX (mm)	Dynamic Pressure (x 1,000 PSI)	
	1		2			S	SS
	(mm)	(in.)	BSPP				
4F642EDML	6	1/4	1/8	34.0	14	7.2	7.2
6F642EDML	8, 10	3/8	1/4	40.2	19	9.2	9.2
8F642EDML	12	1/2	3/8	47.3	22	9.2	9.2
10F642EDML	14, 15, 16	5/8	1/2	51.8	27	6.0	6.0
12F642EDML	18, 20	3/4	3/4	57.2	32	6.0	6.0
16F642EDML	22, 25	1	1	67.0	46	6.0	6.0

**WARNING:** This product can expose you to chemicals including Lead and Lead Compounds which is known to the State of California to cause cancer and birth defects or other reproductive harm. For more information go to [www.p65warnings.ca.gov](http://www.p65warnings.ca.gov).

## WNLO

45° Bulkhead Union Elbow  
ORFS / ORFS

SAE 520801  
WNLO-WLNL - Body with Locknut  
(See page A12 for WLNL)

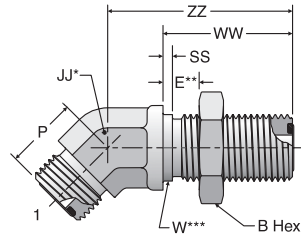

TUBE FITTING PART #	END SIZE		B HEX (in.)	E MAX (in.)	JJ (in.)	P (in.)	SS (in.)	W DIA (in.)	WW (in.)	ZZ (in.)	Dynamic Pressure (x 1,000 PSI)	
	1 (in.)	2 (in.)									-S	-SS
	4 WNLO	1/4									1/4	13/16
6 WNLO	3/8	3/8	1	0.55	3/4	0.75	0.06	0.69	1.34	1.91	9.2	9.2
8 WNLO	1/2	1/2	1 1/8	0.55	3/4	0.81	0.06	0.81	1.44	2.01	9.2	9.2
10 WNLO	5/8	5/8	1 5/16	0.55	1 1/16	0.93	0.06	1.00	1.59	2.22	6.0	6.0
12 WNLO	3/4	3/4	1 1/2	0.55	1 3/16	1.02	0.06	1.19	1.63	2.38	6.0	6.0
16 WNLO	1	1	1 3/4	0.55	1 7/16	1.18	0.06	1.44	1.65	2.56	6.0	6.0
20 WNLO	1 1/4	1 1/4	2	0.55	1 5/8	1.26	0.06	1.69	1.65	2.64	5.0	5.0
24 WNLO	1 1/2	1 1/2	2 3/8	0.55	1 7/8	1.46	0.06	2.00	1.65	2.64	4.0	4.0

\* JJ – Across wrench flats.

\*\* E – Maximum bulkhead thickness.

\*\*\* W – Bulkhead pilot diameter. Recommended clearance hole is  $W + 0.015$ ".

A

TABLE OF CONTENTS

VISUAL INDEX

FAQs

ASSEMBLY

TUBE FAB EQUIP

GEN TECH

Dimensions and pressures for reference only, subject to change.

Click here for CADs, Support Resources or to Configure Parts Online

## WNMLO

45° Bulkhead Union Elbow – mm Hex  
ORFS / ORFS

ISO 8434-3 BHE45  
SAE 52M0801  
WNMLO-WLNML - Body with Locknut  
(See page A12 for WLNML)

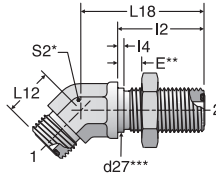

## V6LO

45° Swivel Nut Elbow  
ORFS / ORFS Swivel

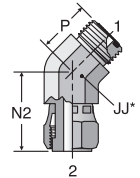

\* JJ – Across Wrench Flats

TUBE FITTING PART #	END SIZE		d27***	E	I2	I4	L12	L18	S2	Dynamic Pressure (x 1,000 PSI)	
	1 & 2									S	SS
	(mm)	(in.)									
4WNMLO	6	1/4	14.3	14	31.5	1.5	16.0	44.0	14	9.2	9.2
6WNMLO	8,10	3/8	17.5	14	34.0	1.5	19.0	48.5	19	9.2	9.2
8WNMLO	12	1/2	20.6	14	36.5	1.5	20.5	51.0	19	9.2	9.2
10WNMLO	14,15,16	5/8	25.4	14	40.5	1.5	23.5	56.5	27	6.0	6.0
12WNMLO	18,20	3/4	30.2	14	41.5	1.5	26.0	60.5	30	6.0	6.0
16WNMLO	22,25	1	36.5	14	42.0	1.5	30.0	65.0	36	6.0	6.0
20WNMLO	28,30,32	1 1/4	42.9	14	42.0	1.5	32.0	67.0	41	5.0	5.0
24WNMLO	35,38	1 1/2	50.8	14	42.0	1.5	37.0	67.0	50	4.0	4.0

\* S2 – Across Wrench Flats.

\*\* E – Maximum bulkhead thickness.

\*\*\*d27 – Bulkhead pilot diameter. Recommended clearance hole is d27 + 0.4 mm.

TUBE FITTING PART #	END SIZE		JJ	N2	P	Dynamic Pressure (x 1,000 PSI)	
	1 & 2					-S	-SS
	(in.)	(in.)					
4 V6LO	1/4	9/16	0.99	0.63	9.2	9.2	
6 V6LO	3/8	3/4	1.12	0.74	9.2	9.2	
8 V6LO	1/2	3/4	1.49	0.80	9.2	9.2	
10 V6LO	5/8	1 1/16	1.53	0.92	6.0	6.0	
12 V6LO	3/4	1 3/16	1.73	1.02	6.0	6.0	
16 V6LO	1	1 7/16	1.87	1.18	6.0	6.0	
20 V6LO	1 1/4	1 5/8	1.98	1.26	5.0	5.0	
24 V6LO	1 1/2	1 7/8	2.06	1.45	4.0	4.0	

**WARNING:** This product can expose you to chemicals including Lead and Lead Compounds which is known to the State of California to cause cancer and birth defects or other reproductive harm. For more information go to [www.p65warnings.ca.gov](http://www.p65warnings.ca.gov).

## V5OLO

45° Straight Thread Elbow  
ORFS / SAE-ORB

SAE 520320

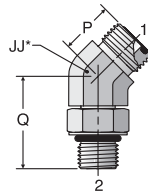

\* JJ – Across Hex Flats

## V87OMLO

45° Metric Straight Thread Elbow  
ORFS / ISO 6149

ISO 8434-3 SDE45  
SAE 52M0387

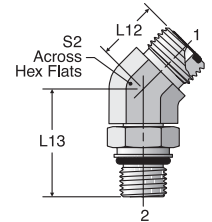

\* S2 – Across Hex Flats

TUBE FITTING PART #	END SIZE		JJ	P	Q	Dynamic Pressure (x 1,000 PSI)	
	1	2				-S	-SS
	(in.)	UN/UNF-2A					
4 V5OLO	1/4	7/16 - 20	9/16	0.63	1.18	6.0	6.0
4-6 V5OLO	1/4	9/16 - 18	3/4	0.69	1.30	6.0	6.0
6 V5OLO	3/8	9/16 - 18	3/4	0.75	1.30	6.0	6.0
6-4 V5OLO	3/8	7/16 - 20	3/4	0.75	1.22	6.0	6.0
6-8 V5OLO	3/8	3/4 - 16	3/4	0.75	1.44	6.0	6.0
8 V5OLO	1/2	3/4 - 16	3/4	0.81	1.44	6.0	6.0
8-6 V5OLO	1/2	9/16 - 18	3/4	0.81	1.28	6.0	6.0
8-10 V5OLO	1/2	7/8 - 14	3/4	0.85	1.75	6.0	6.0
10 V5OLO	5/8	7/8 - 14	1 1/16	0.93	1.75	6.0	6.0
10-8 V5OLO	5/8	3/4 - 16	1 1/16	0.93	1.57	6.0	6.0
10-12 V5OLO	5/8	1 1/16 - 12	1 3/16	0.96	1.97	6.0	6.0
12 V5OLO	3/4	1 1/16 - 12	1 3/16	1.02	1.97	6.0	6.0
12-10 V5OLO	3/4	7/8 - 14	1 3/16	1.02	1.81	6.0	6.0
12-16 V5OLO	3/4	1 5/16 - 12	1 7/16	1.16	2.07	5.5	5.5
16 V5OLO	1	1 5/16 - 12	1 7/16	1.18	2.07	5.5	5.5
16-10 V5OLO	1	7/8 - 14	1 7/16	1.18	2.03	6.0	6.0
16-12 V5OLO	1	1 1/16 - 12	1 7/16	1.18	2.03	6.0	6.0
16-20 V5OLO	1	1 5/8 - 12	1 5/8	1.26	2.11	4.0	4.0
20 V5OLO	1 1/4	1 5/8 - 12	1 5/8	1.26	2.11	4.0	4.0
24 V5OLO	1 1/2	1 7/8 - 12	1 7/8	1.46	2.11	4.0	4.0

TUBE FITTING PART #	END SIZE			L12	L13	S2	Dynamic Pressure (x 1,000 PSI)	
	1		2				S	SS
	(mm)	(in.)	ISO 261					
4M12V87OMLO	6	1/4	M12X1.5	16.0	30.0	14	6.0	6.0
4M14V87OMLO	6	1/4	M14X1.5	17.5	31.5	17	6.0	6.0
6M16V87OMLO	8,10	3/8	M16X1.5	19.0	33.5	19	6.0	6.0
8M18V87OMLO	12	1/2	M18X1.5	20.5	37.0	19	6.0	6.0
10M22V87OMLO	14,15,16	5/8	M22X1.5	23.5	44.0	27	6.0	6.0
12M27V87OMLO	18,20	3/4	M27X2	26.0	50.5	27	6.0	6.0
16M33V87OMLO	22,25	1	M33X2	30.0	52.5	36	5.0	5.0
20M42V87OMLO	28,30,32	1 1/4	M42X2	32.0	54.0	41	4.0	4.0
24M48V87OMLO	35,38	1 1/2	M48X2	37.0	56.5	50	4.0	4.0

**WARNING:** This product can expose you to chemicals including Lead and Lead Compounds which is known to the State of California to cause cancer and birth defects or other reproductive harm. For more information go to [www.p65warnings.ca.gov](http://www.p65warnings.ca.gov).

Dimensions and pressures for reference only, subject to change.



Click here for CADs, Support Resources or to Configure Parts Online

## VLO

45° Male Elbow  
ORFS / NPTF

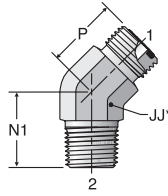

\* JJ – Across Wrench Flats

## V40MLO

Male 45° Elbow – BSPP  
(for ISO 1179-1 Port)  
ORFS / BSPP-ORR

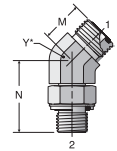

\* Y – Across Hex Flats

TUBE FITTING PART #	END SIZE		JJ (in.)	N1 (in.)	P (in.)	Dynamic Pressure (x 1,000 PSI)	
	1 (in.)	2 NPTF				-S	-SS
	4 VLO	1/4					
4-4 VLO	1/4	1/4 - 18	9/16	0.86	0.68	6.0	6.0
6 VLO	3/8	1/4 - 18	3/4	0.87	0.74	6.0	6.0
6-6 VLO	3/8	3/8 - 18	3/4	0.87	0.74	6.0	6.0
8 VLO	1/2	3/8 - 18	3/4	0.95	0.80	6.0	6.0
8-8 VLO	1/2	1/2 - 14	7/8	1.17	0.86	6.0	6.0
10 VLO	5/8	1/2 - 14	1 1/16	1.17	0.92	6.0	6.0
12 VLO	3/4	3/4 - 14	1 5/16	1.30	1.02	4.0	4.0
16 VLO	1	1 - 11 1/2	1 7/16	1.48	1.18	3.0	3.0
20 VLO	1 1/4	1 1/4 - 11 1/2	1 5/8	1.67	1.26	2.5	2.5

TUBE FITTING PART #	END SIZE			M (mm)	N (mm)	Y (mm)	Dynamic Pressure (x 1,000 PSI)	
	1		2 BSPP				S	SS
	(mm)	(in.)						
4V40MLO	6	1/4	1/8 - 28	16.0	27.5	14	4.0	4.0
4-4V40MLO	6	1/4	1/4 - 19	17.5	32.0	19	4.0	4.0
6V40MLO	8,10	3/8	1/4 - 19	19.0	32.0	19	4.0	4.0
6-6V40MLO	8,10	3/8	3/8 - 19	19.0	33.5	19	4.0	4.0
6-8V40MLO	8,10	3/8	1/2 - 14	19.5	43.5	27	4.0	4.0
8V40MLO	12	1/2	3/8 - 19	20.5	33.5	19	4.0	4.0
8-8V40MLO	12	1/2	1/2 - 14	21.0	43.5	27	4.0	4.0
10V40MLO	14,15,16	5/8	1/2 - 14	23.5	43.5	27	4.0	4.0
10-12V40MLO	14,15,16	5/8	3/4 - 14	24.5	46.5	30	4.0	4.0
12V40MLO	18,20	3/4	3/4 - 14	26.0	46.5	30	4.0	4.0
12-16V40MLO	18,20	3/4	1 - 11	26.0	51.0	37	4.0	4.0
16V40MLO	22,25	1	1 - 11	30.0	51.0	37	4.0	4.0

**WARNING:** This product can expose you to chemicals including Lead and Lead Compounds which is known to the State of California to cause cancer and birth defects or other reproductive harm. For more information go to [www.p65warnings.ca.gov](http://www.p65warnings.ca.gov).

## ELO

Union Elbow  
ORFS / ORFS

SAE 520201

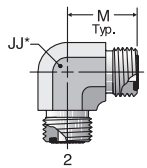

\* JJ – Across Wrench Flats

## EMLO

Union Elbow – mm Hex  
ORFS / ORFS

ISO 8434-3 E  
SAE 52M0201

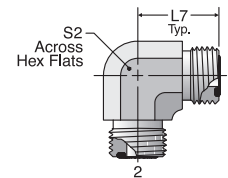

TUBE FITTING PART #	END SIZE		JJ (in.)	M (in.)	Dynamic Pressure (x 1,000 PSI)	
	1 (in.)	2 (in.)			-S	-SS
	4 ELO	1/4				
6 ELO	3/8	3/8	3/4	0.98	9.2	9.2
8 ELO	1/2	1/2	3/4	1.10	9.2	9.2
10 ELO	5/8	5/8	1 1/16	1.32	6.0	6.0
12 ELO	3/4	3/4	1 3/16	1.48	6.0	6.0
16 ELO	1	1	1 7/16	1.63	6.0	6.0
20 ELO	1 1/4	1 1/4	1 5/8	1.75	5.0	5.0
24 ELO	1 1/2	1 1/2	1 7/8	1.93	4.0	4.0
32 ELO*	2	2	2 1/2	2.76	3.0	3.0

\*\* Size 32 is not included in SAE J1453.

TUBE FITTING PART #	END SIZE		L7 (mm)	S2 (mm)	Dynamic Pressure (x 1,000 PSI)	
	1 & 2				S	SS
	(mm)	(in.)				
4EMLO	6	1/4	21.5	14	9.2	9.2
6EMLO	8,10	3/8	25.0	19	9.2	9.2
8EMLO	12	1/2	28.0	19	9.2	9.2
10EMLO	14,15,16	5/8	33.5	27	6.0	6.0
12EMLO	18,20	3/4	37.5	30	6.0	6.0
16EMLO	22,25	1	41.5	36	6.0	6.0
20EMLO	28,30,32	1 1/4	44.5	41	5.0	5.0
24EMLO	35,38	1 1/2	49.0	50	4.0	4.0

Dimensions and pressures for reference only, subject to change.

[Click here for CADs, Support Resources or to Configure Parts Online](#)

## WELO

Bulkhead Union Elbow  
ORFS / ORFS

SAE 520701  
WELO-WLNL - Body with Locknut  
(See page A12 for WLNL)

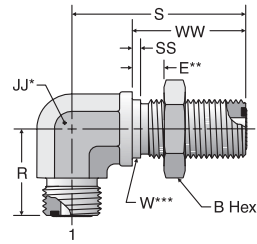

TUBE FITTING PART #	END SIZE		B HEX (in.)	E MAX (in.)	JJ (in.)	R (in.)	S (in.)	SS (in.)	W (in.)	WW (in.)	Dynamic Pressure (x 1,000 PSI)	
	1 (in.)	2 (in.)									-S	-SS
4 WELO	1/4	1/4	13/16	0.55	9/16	0.89	1.85	0.06	0.56	1.24	9.2	9.2
6 WELO	3/8	3/8	1	0.55	3/4	1.02	2.05	0.06	0.69	1.34	9.2	9.2
8 WELO	1/2	1/2	1 1/8	0.55	3/4	1.14	2.19	0.06	0.81	1.44	9.2	9.2
10 WELO	5/8	5/8	1 5/16	0.55	1 1/16	1.36	2.48	0.06	1.00	1.59	6.0	6.0
12 WELO	3/4	3/4	1 1/2	0.55	1 3/16	1.52	2.64	0.06	1.19	1.63	6.0	6.0
16 WELO	1	1	1 3/4	0.55	1 7/16	1.67	2.80	0.06	1.44	1.65	6.0	6.0
20 WELO	1 1/4	1 1/4	2	0.55	1 5/8	1.79	2.97	0.06	1.69	1.65	5.0	5.0
24 WELO	1 1/2	1 1/2	2 3/8	0.55	1 7/8	1.95	3.13	0.06	2.00	1.65	4.0	4.0

\* JJ – Across wrench flats.

\*\* E – Maximum bulkhead thickness.

\*\*\* W – Bulkhead pilot diameter. Recommended clearance hole is  $W + 0.015$ ".

## WEMLO

Bulkhead Union Elbow – mm Hex  
ORFS / ORFS

ISO 8434-3 BHE  
SAE 52M0701  
WEMLOWLNL - Body with Locknut  
(See page A12 for WLNML)

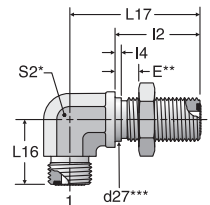

TUBE FITTING PART #	END SIZE		d27*** (mm)	E (mm)	l2 (mm)	l4 (mm)	L16 (mm)	L17 (mm)	S2 (mm)	Dynamic Pressure (x 1,000 PSI)	
	1 & 2 (mm)	(in.)								S	SS
4WEMLO	6	1/4	14.3	14	31.5	1.5	22.5	47.0	14	9.2	9.2
6WEMLO	8,10	3/8	17.5	14	34.0	1.5	26.0	52.0	19	9.2	9.2
8WEMLO	12	1/2	20.6	14	36.5	2.5	29.0	55.5	19	9.2	9.2
10WEMLO	14,15,16	5/8	25.4	14	40.5	2.5	34.5	63.0	27	6.0	6.0
12WEMLO	18,20	3/4	30.2	14	41.5	3.0	38.5	67.0	30	6.0	6.0
16WEMLO	22,25	1	36.5	14	42.0	3.0	42.5	71.0	36	6.0	6.0
20WEMLO	28,30,32	1 1/4	42.9	14	42.0	3.0	45.5	75.5	41	5.0	5.0
24WEMLO	35,38	1 1/2	50.8	14	42.0	3.0	49.5	79.5	50	4.0	4.0

\* S2 – Across wrench flats.

\*\* E – Maximum bulkhead thickness.

\*\*\*d27 - Bulkhead pilot diameter. Recommended clearance is  $d27 + 0.4$  mm.

TABLE OF CONTENTS

VISUAL INDEX

FAQs

ASSEMBLY

TUBE FAB EQUIP

GEN TECH

Dimensions and pressures for reference only, subject to change.

[Click here for CADs, Support Resources or to Configure Parts Online](#)

### C6LO

Swivel Nut Elbow  
ORFS / ORFS Swivel

SAE 520221

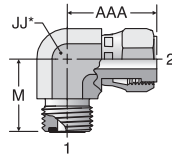

\* JJ – Across Wrench Flats

TUBE FITTING PART #	END SIZE		AAA (in.)	JJ (in.)	M (in.)	Dynamic Pressure (x 1,000 PSI)	
	1 (in.)	2 (in.)				-S	-SS
	4 C6LO	1/4					
6 C6LO	3/8	3/8	1.17	3/4	0.98	9.2	9.2
8 C6LO	1/2	1/2	1.50	3/4	1.10	9.2	9.2
10 C6LO	5/8	5/8	1.61	1 1/16	1.32	6.0	6.0
12 C6LO	3/4	3/4	1.83	1 3/16	1.48	6.0	6.0
16 C6LO	1	1	2.11	1 7/16	1.64	6.0	6.0
20 C6LO	1 1/4	1 1/4	2.28	1 5/8	1.75	5.0	5.0
24 C6LO	1 1/2	1 1/2	2.41	1 7/8	1.92	4.0	4.0

### C6MLO

Swivel Nut Elbow – mm Hex  
ORFS / ORFS Swivel

ISO 8434-3 SWE  
SAE 52M0221

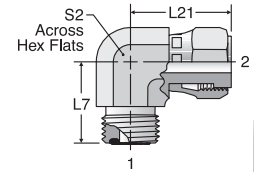

\* S2 – Across Hex Flats

TUBE FITTING PART #	END SIZE		L7 (mm)	L21 (mm)	S2 (mm)	Dynamic Pressure (x 1,000 PSI)	
	1 (mm)	2 (in.)				S	SS
	4C6MLO	6					
6C6MLO	8,10	3/8	25.0	29.7	19	9.2	9.2
8C6MLO	12	1/2	28.0	38.0	19	9.2	9.2
10C6MLO	14,15,16	5/8	33.5	41.0	27	6.0	6.0
12C6MLO	18,20	3/4	37.5	46.5	30	6.0	6.0
16C6MLO	22,25	1	41.6	53.5	36	6.0	6.0
20C6MLO	28,30,32	1 1/4	44.5	58.0	41	5.0	5.0
24C6MLO	35,38	1 1/2	48.8	61.0	50	4.0	4.0

### AOEL6

Straight Thread Swivel Elbow  
ORFS Swivel / SAE-ORB

SAE 520281

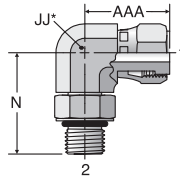

\* JJ – Across Wrench Flats

TUBE FITTING PART #	END SIZE		AAA (in.)	JJ (in.)	N (in.)	Dynamic Pressure (x 1,000 PSI)	
	1 (in.)	2 UN/UNF-2A				-S	-SS
	4 AOEL6	1/4					
6 AOEL6	3/8	9/16 - 18	1.17	3/4	1.46	6.0	6.0
8 AOEL6	1/2	3/4 - 16	1.50	3/4	1.59	6.0	6.0
10 AOEL6	5/8	7/8 - 14	1.65	1 1/16	1.97	6.0	6.0
12 AOEL6	3/4	1 1/16 - 12	1.79	1 1/16	2.17	6.0	6.0
16 AOEL6	1	1 5/16 - 12	2.07	1 5/8	2.34	5.5	5.5
20 AOEL6	1 1/4	1 5/8 - 12	2.28	1 5/8	2.44	4.0	4.0
24 AOEL6	1 1/2	1 7/8 - 12	2.40	1 7/8	2.60	4.0	4.0

### C5OLO

Straight Thread Elbow  
ORFS / SAE-ORB

SAE 520220

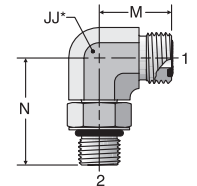

\* JJ – Across Wrench Flats

TUBE FITTING PART #	END SIZE		JJ (in.)	M (in.)	N (in.)	Dynamic Pressure (x 1,000 PSI)	
	1 (in.)	2 UN/UNF-2A				-S	-SS
	4 C5OLO	1/4					
4-6 C5OLO***	1/4	9/16 - 18	9/16	0.93	1.46	6.0	6.0
4-8 C5OLO	1/4	3/4 - 16	3/4	0.98	1.59	6.0	6.0
6 C5OLO	3/8	9/16 - 18	3/4	0.98	1.46	6.0	6.0
6-4 C5OLO	3/8	7/16 - 20	3/4	0.98	1.38	6.0	6.0
6-5 C5OLO	3/8	1/2 - 20	3/4	0.98	1.38	6.0	6.0
6-8 C5OLO	3/8	3/4 - 16	3/4	1.04	1.59	6.0	6.0
6-10 C5OLO***	3/8	7/8 - 14	7/8	1.15	1.97	6.0	6.0
6-12 C5OLO	3/8	1 1/16 - 12	1 1/16	1.28	2.17	6.0	6.0
8 C5OLO	1/2	3/4 - 16	3/4	1.10	1.59	6.0	6.0
8-6 C5OLO	1/2	9/16 - 18	3/4	1.10	1.44	6.0	6.0
8-10 C5OLO***	1/2	7/8 - 14	7/8	1.21	1.97	6.0	6.0
8-12 C5OLO	1/2	1 1/16 - 12	1 3/16	1.32	2.17	6.0	6.0
10 C5OLO	5/8	7/8 - 14	1 1/16	1.32	1.97	6.0	6.0
10-8 C5OLO	5/8	3/4 - 16	1 1/16	1.32	1.81	6.0	6.0
10-12 C5OLO	5/8	1 1/16 - 12	1 3/16	1.42	2.17	6.0	6.0
12 C5OLO	3/4	1 1/16 - 12	1 3/16	1.48	2.17	6.0	6.0
12-8 C5OLO	3/4	3/4 - 16	1 3/16	1.48	1.83	6.0	6.0
12-10 C5OLO	3/4	7/8 - 14	1 3/16	1.48	2.01	6.0	6.0
12-16 C5OLO	3/4	1 5/16 - 12	1 7/16	1.61	2.34	5.5	5.5
16 C5OLO	1	1 5/16 - 12	1 7/16	1.63	2.34	5.5	5.5
16-12 C5OLO	1	1 1/16 - 12	1 7/16	1.63	2.30	6.0	6.0
16-20 C5OLO	1	1 5/8 - 12	1 5/8	1.75	2.44	4.0	4.0
20 C5OLO	1 1/4	1 5/8 - 12	1 5/8	1.75	2.44	4.0	4.0
20-16 C5OLO	1 1/4	1 5/16 - 12	1 5/8	1.75	2.44	5.0	5.0
20-24 C5OLO	1 1/4	1 7/8 - 12	1 7/8	1.93	2.60	4.0	4.0
24 C5OLO	1 1/2	1 7/8 - 12	1 7/8	1.93	2.60	4.0	4.0
24-20 C5OLO	1 1/2	1 5/8 - 12	1 7/8	1.93	2.60	4.0	4.0
32 C5OLO	2	2 1/2 - 12	2 1/2	2.76	3.07	2.5	2.5

Dimensions and pressures for reference only, subject to change.

Click here for CADs, Support Resources or to Configure Parts Online

## CC5OLO

Long Straight Thread Elbow  
ORFS-Long / SAE-ORB

SAE 521520

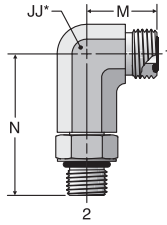

\* JJ – Across  
Wrench Flats

## CLO

Male Pipe Elbow  
ORFS / NPTF

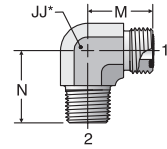

\* JJ – Across  
Wrench Flats

TUBE FITTING PART #	END SIZE		JJ (in.)	M (in.)	N (in.)	Dynamic Pressure (x 1,000 PSI)	
	1 (in.)	2 UN-UNF-2A				-S	-SS
	4 CC5OLO	1/4					
6 CC5OLO	3/8	9/16 - 18	7/8	0.98	2.62	6.0	6.0
8 CC5OLO	1/2	3/4 - 16	7/8	1.10	2.95	6.0	6.0
10 CC5OLO	5/8	7/8 - 14	1 1/16	1.32	3.50	6.0	6.0
12 CC5OLO	3/4	1 1/16 - 12	1 5/16	1.48	3.98	6.0	6.0
16 CC5OLO	1	1 5/16 - 12	1 5/8	1.63	4.49	5.5	5.5

TUBE FITTING PART #	END SIZE		JJ (in.)	M (in.)	N (in.)	Dynamic Pressure (x 1,000 PSI)	
	1 (in.)	2 NPTF				-S	-SS
	4 CLO	1/4					
4-4 CLO	1/4	1/4 - 18	9/16	0.85	1.12	6.0	6.0
4-6 CLO	1/4	3/8 - 18	3/4	0.97	1.22	6.0	6.0
4-8 CLO	1/4	1/2 - 14	7/8	1.07	1.47	6.0	6.0
6 CLO	3/8	1/4 - 18	3/4	0.98	1.09	6.0	6.0
6-6 CLO	3/8	3/8 - 18	3/4	0.98	1.22	6.0	6.0
6-8 CLO	3/8	1/2 - 14	7/8	1.15	1.47	6.0	6.0
8 CLO	1/2	3/8 - 18	3/4	1.10	1.22	6.0	6.0
8-4 CLO	1/2	1/4 - 18	3/4	1.10	1.22	6.0	6.0
8-8 CLO	1/2	1/2 - 14	7/8	1.10	1.47	6.0	6.0
8-12 CLO	1/2	3/4 - 14	1 1/16	1.32	1.59	4.0	4.0
10 CLO	5/8	1/2 - 14	1 1/16	1.31	1.47	6.0	6.0
10-6 CLO	5/8	3/8 - 18	1 1/16	1.31	1.28	6.0	6.0
10-12 CLO	5/8	3/4 - 14	1 3/16	1.41	1.59	4.0	4.0
12 CLO	3/4	3/4 - 14	1 3/16	1.47	1.59	4.0	4.0
12-8 CLO	3/4	1/2 - 14	1 3/16	1.47	1.59	6.0	6.0
12-16 CLO	3/4	1 - 11 1/2	1 5/16	1.62	1.97	3.0	3.0
16 CLO	1	1 - 11 1/2	1 7/16	1.64	1.97	3.0	3.0
16-12 CLO	1	3/4 - 14	1 7/16	1.64	1.78	4.0	4.0
20 CLO	1 1/4	1 1/4 - 11 1/2	1 5/8	1.76	2.38	2.5	2.5
24 CLO	1 1/2	1 1/2 - 11 1/2	1 7/8	1.92	2.64	2.5	2.5
24-20 CLO	1 1/2	1 1/4 - 11 1/2	1 7/8	1.92	2.61	2.5	2.5

## C87OMLO

90° Metric Straight Thread Elbow  
ORFS / ISO 6149

ISO 8434-3 SDE  
SAE 52M0287

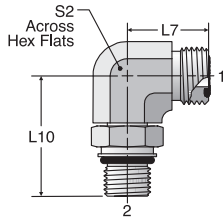

TUBE FITTING PART #	END SIZE			L7 (mm)	L10 (mm)	S2 (mm)	Dynamic Pressure (x 1,000 PSI)	
	1		2				S	SS
	(mm)	(in.)	ISO 261					
4M12C87OMLO	6	1/4	M12X1.5	21.5	33.0	14	6.0	6.0
4M14C87OMLO	6	1/4	M14X1.5	23.5	35.5	14	6.0	6.0
6M12C87OMLO	8,10	3/8	M12X1.5	25.0	35.5	19	6.0	6.0
6M14C87OMLO	8,10	3/8	M14X1.5	25.0	35.5	19	6.0	6.0
6M16C87OMLO	8,10	3/8	M16X1.5	25.0	37.5	19	6.0	6.0
8M14C87OMLO	12	1/2	M14X1.5	28.0	36.0	19	6.0	6.0
8M18C87OMLO	12	1/2	M18X1.5	28.0	41.0	19	6.0	6.0
8M22C87OMLO	12	1/2	M22X1.5	31.0	49.0	27	6.0	6.0
10M18C87OMLO	14,15,16	5/8	M18X1.5	33.5	47.5	27	6.0	6.0
10M22C87OMLO	14,15,16	5/8	M22X1.5	33.5	49.0	27	6.0	6.0
12M22C87OMLO	18,20	3/4	M22X1.5	37.5	49.0	27	6.0	6.0
12M27C87OMLO	18,20	3/4	M27X2	37.5	55.5	27	6.0	6.0
16M33C87OMLO	22,25	1	M33X2	41.5	59.5	36	5.0	5.0
20M38C87OMLO*	28,30,32	1 1/4	M38X2	44.5	62.0	41	4.0	4.0
20M42C87OMLO	28,30,32	1 1/4	M42X2	44.5	63.0	41	4.0	4.0
24M48C87OMLO	35,38	1 1/2	M48X2	49.0	71.5	50	4.0	4.0

\* For special M38x2 (ISO 6149-1 style) port. The current ISO 6149 does not include the M38 size.

**WARNING:** This product can expose you to chemicals including Lead and Lead Compounds which is known to the State of California to cause cancer and birth defects or other reproductive harm. For more information go to [www.p65warnings.ca.gov](http://www.p65warnings.ca.gov).

\*\*\* JJ for these parts does not conform to SAE.

Dimensions and pressures for reference only, subject to change.

TABLE OF CONTENTS

VISUAL INDEX

FAQs

ASSEMBLY

TUBE FAB EQUIP

GEN TECH



[Click here for CADs, Support Resources or to Configure Parts Online](#)

# CC87OMLO

Long 90° Metric Straight Thread Elbow  
ORFS-Long / ISO 6149

ISO 8434-3 SDEL  
SAE 52M1587

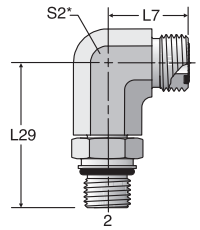

\* S2 – Across Hex Flats

TUBE FITTING PART #	END SIZE			L7 (mm)	L29 (mm)	S2 (mm)	Dynamic Pressure (x 1,000 PSI)	
	1		2				S	SS
	(mm)	(in.)	ISO 261					
4M12CC87OMLO	6	1/4	M12X1.5	21.5	56.5	14	6.0	6.0
6M14CC87OMLO	8,10	3/8	M14X1.5	25.0	56.5	17	6.0	6.0
6M16CC87OMLO	8,10	3/8	M16X1.5	25.0	66.5	17	6.0	6.0
8M18CC87OMLO	12	1/2	M18X1.5	28.0	75.0	19	6.0	6.0
8M22CC87OMLO	12	1/2	M22X1.5	31.5	88.0	27	6.0	6.0
10M22CC87OMLO	14,15,16	5/8	M22X1.5	33.5	88.0	27	6.0	6.0
12M27CC87OMLO	18,20	3/4	M27X2	37.5	100.5	27	6.0	6.0
16M33CC87OMLO	22,25	1	M33X2	41.5	114.5	36	5.0	5.0
20M42CC87OMLO	28,30,32	1 1/4	M42X2	44.5	126.5	41	4.0	4.0

**WARNING:** This product can expose you to chemicals including Lead and Lead Compounds which is known to the State of California to cause cancer and birth defects or other reproductive harm. For more information go to [www.p65warnings.ca.gov](http://www.p65warnings.ca.gov).

# C8OMLO

Metric Straight Thread Elbow  
ORFS / Metric-ORR

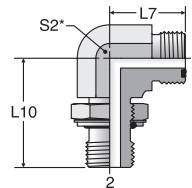

\* S2 – Across Hex Flats

TUBE FITTING PART #	END SIZE			L7 (mm)	L10 (mm)	S2 (mm)	Dynamic Pressure (x 1,000 PSI)	
	1		2				S	SS
	(mm)	(in.)	ISO 261					
4M12C8OMLO	6	1/4	M12X1.5	21.5	33.0	14	3.6	3.6
6M12C8OMLO	8, 10	3/8	M12X1.5	25.0	35.5	19	3.6	3.6
6M14C8OMLO	8, 10	3/8	M14X1.5	25.0	35.5	19	3.6	3.6
6M16C8OMLO	8, 10	3/8	M16X1.5	25.0	37.5	19	3.6	3.6
8M14C8OMLO	12	1/2	M14X1.5	28.0	36.0	19	3.6	3.6
8M18C8OMLO	12	1/2	M18X1.5	28.0	41.0	19	3.6	3.6
8M22C8OMLO	12	1/2	M22X1.5	31.5	49.0	27	3.6	3.6
10M22C8OMLO	14, 15, 16	5/8	M22X1.5	33.5	49.0	27	3.6	3.6
12M27C8OMLO	18, 20	3/4	M27X2	37.5	55.5	30	3.6	3.6
16M33C8OMLO	22, 25	1	M33X2	41.5	59.5	36	2.5	2.5
20M38C8OMLO	28, 30, 32	1 1/4	M38X2	44.5	62.0	41	2.5	2.5
20M42C8OMLO	28, 30, 32	1 1/4	M42X2	44.5	63.0	41	2.5	2.5

**WARNING:** This product can expose you to chemicals including Lead and Lead Compounds which is known to the State of California to cause cancer and birth defects or other reproductive harm. For more information go to [www.p65warnings.ca.gov](http://www.p65warnings.ca.gov).

Dimensions and pressures for reference only, subject to change.

- A
- TABLE OF CONTENTS
- VISUAL INDEX
- FAQs
- ASSEMBLY
- TUBE FAB EQUIP
- GEN TECH

[Click here for CADs, Support Resources or to Configure Parts Online](#)

## C4OMLO

Male Elbow – BSPP  
(for ISO 1179-1 Port)  
ORFS / BSPP-ORR

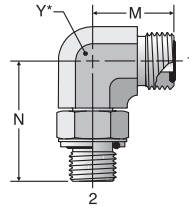

\* Y – Across  
Wrench Flats

## JLO

Union Tee  
ORFS (all three ends)

SAE 520401

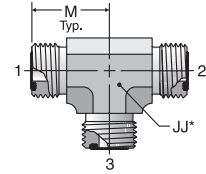

\* JJ – Across  
Wrench Flats

TUBE FITTING PART #	END SIZE		BSPP	M (mm)	N (mm)	Y (mm)	Dynamic Pressure (x 1,000 PSI)	
	1	2					S	SS
	(mm)	(in.)						
4C4OMLO	6	1/4	1/8 - 28	21.5	30.0	14	4.0	4.0
4-4C4OMLO	6	1/4	1/4 - 19	23.5	36.0	19	4.0	4.0
4-6C4OMLO	6	1/4	3/8 - 19	24.5	38.0	19	4.0	4.0
6C4OMLO	8,10	3/8	1/4 - 19	25.0	36.0	19	4.0	4.0
6-6C4OMLO	8,10	3/8	3/8 - 19	26.5	38.0	19	4.0	4.0
8-4C4OMLO	12	1/2	1/4 - 19	28.0	35.5	19	4.0	4.0
8C4OMLO	12	1/2	3/8 - 19	28.0	38.0	19	4.0	4.0
8-8C4OMLO	12	1/2	1/2 - 14	31.0	48.5	27	4.0	4.0
8-12C4OMLO	12	1/2	3/4 - 14	33.5	51.5	30	4.0	4.0
10-6C4OMLO	14,15,16	5/8	3/8 - 19	33.5	40.5	27	4.0	4.0
10C4OMLO	14,15,16	5/8	1/2 - 14	33.5	48.5	27	4.0	4.0
10-12C4OMLO	14,15,16	5/8	3/4 - 14	36.0	51.5	30	4.0	4.0
10-16C4OMLO	14,15,16	5/8	1 - 11	39.5	58.5	36	4.0	4.0
12-8C4OMLO	18,20	3/4	1/2 - 14	37.5	49.5	30	4.0	4.0
12C4OMLO	18,20	3/4	3/4 - 14	37.5	51.5	30	4.0	4.0
12-16C4OMLO	18,20	3/4	1 - 11	41.0	58.5	36	4.0	4.0
16-12C4OMLO	22,25	1	3/4 - 14	41.5	56.0	36	4.0	4.0
16C4OMLO	22,25	1	1 - 11	41.5	58.5	36	4.0	4.0
16-20C4OMLO	22,25	1	1 1/4 - 11	44.5	61.0	41	3.0	3.0
20-16C4OMLO	28,30,32	1 1/4	1 - 11	44.5	61.0	41	4.0	4.0
20C4OMLO	28,30,32	1 1/4	1 1/4 - 11	44.5	61.0	41	2.0	2.0
20-24C4OMLO	28,30,32	1 1/4	1 1/2 - 11	49.0	64.5	50	2.0	2.0
24C4OMLO	35,38	1 1/2	1 1/2 - 11	49.0	64.5	50	2.0	2.0

TUBE FITTING PART #	END SIZE	JJ (in.)	M (in.)	Dynamic Pressure (x 1,000 PSI)	
	1-3 (in.)			-S	-SS
	4 JLO			1/4	9/16
6 JLO	3/8	3/4	0.98	9.2	9.2
8 JLO	1/2	3/4	1.10	9.2	9.2
10 JLO	5/8	1 1/16	1.32	6.0	6.0
12 JLO	3/4	1 3/16	1.48	6.0	6.0
16 JLO	1	1 7/16	1.63	6.0	6.0
20 JLO	1 1/4	1 5/8	1.75	5.0	5.0
24 JLO	1 1/2	1 7/8	1.93	4.0	4.0
32 JLO	2	2 1/2	2.76	3.0	3.0

**WARNING:** This product can expose you to chemicals including Lead and Lead Compounds which is known to the State of California to cause cancer and birth defects or other reproductive harm. For more information go to [www.p65warnings.ca.gov](http://www.p65warnings.ca.gov).

- TABLE OF CONTENTS
- VISUAL INDEX
- FAQs
- ASSEMBLY
- TUBE FAB EQUIP
- GEN TECH

Dimensions and pressures for reference only, subject to change.

[Click here for CADs, Support Resources or to Configure Parts Online](#)

## JMLO

Union Tee – mm Hex  
ORFS (all three ends)

ISO 8434-3 T  
SAE 52M0401

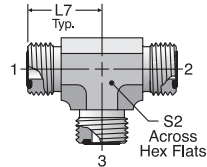

\* S2 – Across Hex Flats

## WJLO

Bulkhead Branch Tee  
ORFS (all three ends)

SAE 520959  
WJLO-WLNL - Body with Locknut  
(See page A12 for WLNL)

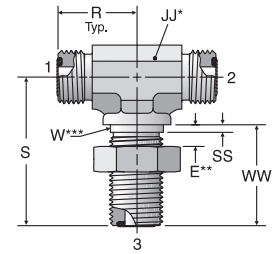

TUBE FITTING PART #	END SIZE		L7 (mm)	S2 (mm)	Dynamic Pressure (x 1,000 PSI)	
	1-3				S	SS
	(mm)	(in.)				
4JMLO	6	1/4	21.5	14	9.2	9.2
6JMLO	8,10	3/8	25.0	19	9.2	9.2
8JMLO	12	1/2	28.0	19	9.2	9.2
10JMLO	14,15,16	5/8	33.5	27	6.0	6.0
12JMLO	18,20	3/4	37.5	30	6.0	6.0
16JMLO	22,25	1	41.5	36	6.0	6.0
20JMLO	28,30,32	1 1/4	44.5	41	5.0	5.0
24JMLO	35,38	1 1/2	49.0	50	4.0	4.0

TUBE FITTING PART #	END SIZE 1-3 (in.)	E (in.)	JJ (in.)	R (in.)	S (in.)	SS (in.)	W DIA (in.)	WW (in.)	Dynamic Pressure (x 1,000 PSI)	
									-S	-SS
									4 WJLO	1/4
6 WJLO	3/8	0.55	3/4	1.02	2.05	0.06	0.69	1.34	9.2	9.2
8 WJLO	1/2	0.55	3/4	1.14	2.19	0.06	0.81	1.44	9.2	9.2
10 WJLO	5/8	0.55	1 1/16	1.36	2.48	0.06	1.00	1.59	6.0	6.0
12 WJLO	3/4	0.55	1 3/16	1.52	2.64	0.06	1.19	1.63	6.0	6.0
16 WJLO	1	0.55	1 7/16	1.67	2.80	0.06	1.44	1.65	6.0	6.0

\* JJ – Across wrench flats.

\*\* E – Maximum bulkhead thickness.

\*\*\* W – Bulkhead pilot diameter. Recommended clearance hole is W + 0.015".

## WJMLO

Bulkhead Union Tee – mm Hex  
ORFS (all three ends)

ISO 8434-3 BHBT  
SAE 52M0959  
WJMLOWLNML - Body with Locknut  
(See page A12 for WLNML)

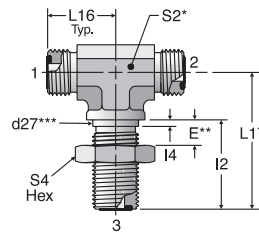

TUBE FITTING PART #	END SIZE		d27*** (mm)	E (mm)	I2 (mm)	I4 (mm)	L16 (mm)	L17 (mm)	S2 (mm)	S4 HEX (mm)	Dynamic Pressure (x 1,000 PSI)	
	1-3										S	SS
	(mm)	(in.)										
4WJMLO	6	1/4	14.3	14	31.5	1.5	22.5	47.0	14	22	9.2	9.2
6WJMLO	8,10	3/8	17.5	14	34.0	1.5	26.0	52.0	19	27	9.2	9.2
8WJMLO	12	1/2	20.6	14	36.5	2.5	29.0	55.5	19	30	9.2	9.2
10WJMLO	14,15,16	5/8	25.4	14	40.5	2.5	34.5	63.0	27	36	6.0	6.0
12WJMLO	18,20	3/4	30.2	14	41.5	3.0	38.5	67.0	30	41	6.0	6.0
16WJMLO	22,25	1	36.5	14	42.0	3.0	42.5	71.0	36	46	6.0	6.0
20WJMLO	28,30,32	1 1/4	42.9	14	42.0	3.0	45.5	75.5	41	50	5.0	5.0
24WJMLO	35,38	1 1/2	50.8	14	42.0	3.0	49.5	79.5	50	60	4.0	4.0

\* S2 – Across wrench flats.

\*\* E – Maximum bulkhead thickness.

\*\*\*d27 - Bulkhead pilot diameter. Recommended clearance hole is d27 + 0.4 mm.

**A**

**TABLE OF CONTENTS**

**VISUAL INDEX**

**FAQs**

**ASSEMBLY**

**TUBE FAB EQUIP**

**GEN TECH**

Dimensions and pressures for reference only, subject to change.

[Click here for CADs, Support Resources or to Configure Parts Online](#)

## WJJLO

Bulkhead Run Tee  
ORFS (all three ends)

SAE 520958

WJJLOWLNML - Body with Locknut  
(See page A12 for WLNML)

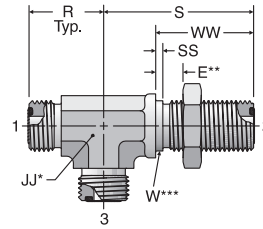

TUBE FITTING PART #	END SIZE	E MAX (in.)	JJ (in.)	R (in.)	S (in.)	SS (in.)	W DIA (in.)	WW (in.)	Dynamic Pressure (x 1,000 PSI)	
									-S	-SS
4 WJJLO	1/4	0.55	9/16	0.89	1.85	0.06	0.56	1.24	9.2	9.2
6 WJJLO	3/8	0.55	3/4	1.02	2.05	0.06	0.69	1.34	9.2	9.2
8 WJJLO	1/2	0.55	3/4	1.14	2.19	0.06	0.81	1.44	9.2	9.2
10 WJJLO	5/8	0.55	1 1/16	1.36	2.48	0.06	1.00	1.59	6.0	6.0
12 WJJLO	3/4	0.55	1 3/16	1.52	2.64	0.06	1.19	1.63	6.0	6.0
16 WJJLO	1	0.55	1 7/16	1.67	2.80	0.06	1.44	1.65	6.0	6.0
20 WJJLO	1 1/4	0.55	1 5/8	1.79	2.79	0.06	1.69	1.65	5.0	5.0
24 WJJLO	1 1/2	0.55	1 7/8	1.95	3.13	0.06	2.00	1.65	4.0	4.0

\* JJ – Across wrench flats.

\*\* E – Maximum bulkhead thickness.

\*\*\* W – Bulkhead pilot diameter. Recommended clearance hole is  $W + 0.015$ .

## WJJMLO

Bulkhead Run Tee – mm Hex  
ORFS (all three ends)

ISO 8434-3 BHRT

SAE 52M0958

WJJMLOWLNML - Body with Locknut  
(See page A12 for WLNML)

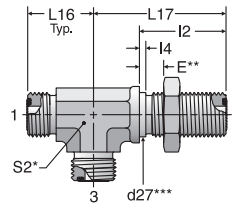

TUBE FITTING PART #	END SIZE		d27*** (mm)	E (mm)	I2 (mm)	I4 (mm)	L16 (mm)	L17 (mm)	S2 (mm)	Dynamic Pressure (x 1,000 PSI)	
	1-3 (mm)	1-3 (in.)								S	SS
4WJJMLO	6	1/4	14.3	14	31.5	1.5	22.5	47.0	14	9.2	9.2
6WJJMLO	8,10	3/8	17.5	14	34.0	1.5	26.0	52.0	19	9.2	9.2
8WJJMLO	12	1/2	20.6	14	36.5	2.5	29.0	55.5	19	9.2	9.2
10WJJMLO	14,15,16	5/8	25.4	14	40.5	2.5	34.5	63.0	27	6.0	6.0
12WJJMLO	18,20	3/4	30.2	14	41.5	3.0	38.5	67.0	30	6.0	6.0
16WJJMLO	22,25	1	36.5	14	42.0	3.0	42.5	71.0	36	6.0	6.0
20WJJMLO	28,30,32	1 1/4	42.9	14	42.0	3.0	45.5	71.0	41	5.0	5.0
24WJJMLO	35,38	1 1/2	50.8	14	42.0	3.0	49.5	79.5	50	4.0	4.0

\* S2 – Across wrench flats.

\*\* E – Maximum bulkhead thickness.

\*\*\*d27 - Bulkhead pilot diameter. Recommended clearance hole is  $d27 + 0.4$  mm.

TABLE OF CONTENTS

VISUAL INDEX

FAQs

ASSEMBLY

TUBE FAB EQUIP

GEN TECH

Dimensions and pressures for reference only, subject to change.



[Click here for CADs, Support Resources or to Configure Parts Online](#)

## S6LO

Swivel Nut Branch Tee  
ORFS / ORFS / ORFS Swivel

SAE 520433

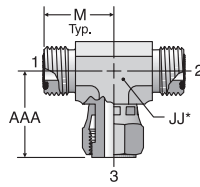

\* JJ – Across  
Wrench Flats

TUBE FITTING PART #	END SIZE		AAA (in.)	JJ (in.)	M (in.)	Dynamic Pressure (x 1,000 PSI)	
	1-3 (in.)	-S				-SS	
							4 S6LO
6 S6LO	3/8	1.17	3/4	0.98	0.98	9.2	9.2
8 S6LO	1/2	1.50	3/4	1.10	1.10	9.2	9.2
10 S6LO	5/8	1.61	1 1/16	1.32	1.32	6.0	6.0
12 S6LO	3/4	1.83	1 3/16	1.48	1.48	6.0	6.0
16 S6LO	1	2.11	1 7/16	1.63	1.63	6.0	6.0
20 S6LO	1 1/4	2.28	1 5/8	1.75	1.75	5.0	5.0
24 S6LO	1 1/2	2.40	1 7/8	1.93	1.93	4.0	4.0

## S6MLO

Swivel Nut Branch Tee – mm Hex  
ORFS / ORFS / ORFS Swivel

ISO 8434-3 SWBT  
SAE 52M0433

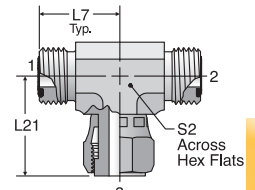

\* S2 – Across  
Wrench Flats

TUBE FITTING PART #	END SIZE		L7 (mm)	L21 (mm)	S2 (mm)	Dynamic Pressure (x 1,000 PSI)	
	1-3					S	SS
	(mm)	(in.)					
4S6MLO	6	1/4	21.5	27.2	14		
6S6MLO	8,10	3/8	25.0	29.7	19	9.2	9.2
8S6MLO	12	1/2	28.0	38.0	19	9.2	9.2
10S6MLO	14,15,16	5/8	33.5	41.0	27	6.0	6.0
12S6MLO	18,20	3/4	37.5	46.5	30	6.0	6.0
16S6MLO	22,25	1	41.5	53.5	36	6.0	6.0
20S6MLO	28,30,32	1 1/4	44.5	58.0	41	5.0	5.0
24S6MLO	35,38	1 1/2	49.0	61.0	50	4.0	4.0

## R6LO

Swivel Nut Run Tee  
ORFS / ORFS Swivel / ORFS

SAE 520432

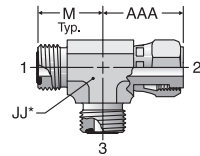

\* JJ – Across  
Wrench Flats

TUBE FITTING PART #	END SIZE		AAA (in.)	JJ (in.)	M (in.)	Dynamic Pressure (x 1,000 PSI)	
	1-3 (in.)	-S				-SS	
							4 R6LO
6 R6LO	3/8	1.17	3/4	0.98	0.98	9.2	9.2
8 R6LO	1/2	1.50	3/4	1.10	1.10	9.2	9.2
10 R6LO	5/8	1.61	1 1/16	1.32	1.32	6.0	6.0
12 R6LO	3/4	1.83	1 3/16	1.48	1.48	6.0	6.0
16 R6LO	1	2.11	1 7/16	1.63	1.63	6.0	6.0
20 R6LO	1 1/4	2.28	1 5/8	1.75	1.75	5.0	5.0
24 R6LO	1 1/2	2.40	1 7/8	1.93	1.93	4.0	4.0

## R6MLO

Swivel Nut Run Tee – mm Hex  
ORFS / ORFS Swivel / ORFS

ISO 8434-3 SWRT  
SAE 52M0432

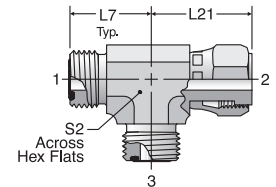

TUBE FITTING PART #	END SIZE		L7 (mm)	L21 (mm)	S2 (mm)	Dynamic Pressure (x 1,000 PSI)	
	1-3					S	SS
	(mm)	(in.)					
4R6MLO	6	1/4	21.5	27.2	14	9.2	9.2
6R6MLO	8,10	3/8	25.0	29.7	19	9.2	9.2
8R6MLO	12	1/2	28.0	38.0	19	9.2	9.2
10R6MLO	14,15,16	5/8	33.5	41.0	27	6.0	6.0
12R6MLO	18,20	3/4	37.5	46.5	30	6.0	6.0
16R6MLO	22,25	1	41.5	53.5	36	6.0	6.0
20R6MLO	28,30,32	1 1/4	44.5	58.0	41	5.0	5.0
24R6MLO	35,38	1 1/2	49.0	61.0	50	4.0	4.0

A

TABLE OF CONTENTS

VISUAL INDEX

FAQs

ASSEMBLY

TUBE FAB EQUIP

GEN TECH

Dimensions and pressures for reference only, subject to change.

[Click here for CADs, Support Resources or to Configure Parts Online](#)

## S5OLO

Straight Thread Branch Tee  
ORFS / ORFS / SAE-ORB

SAE 520429

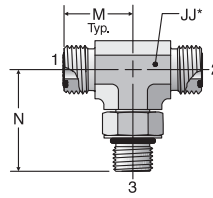

\* JJ – Across  
Wrench Flats

TUBE FITTING PART #	END SIZE			JJ (in.)	M (in.)	N (in.)	Dynamic Pressure (x 1,000 PSI)	
	1	2	3				-S	-SS
	(in.)	(in.)	UN/UNF-2A					
4 S5OLO	1/4	1/4	7/16 - 20	9/16	0.85	1.30	6.0	6.0
4-4-6 S5OLO	1/4	1/4	9/16 - 18	9/16	0.93	1.46	6.0	6.0
6 S5OLO	3/8	3/8	9/16 - 18	3/4	0.98	1.46	6.0	6.0
6-6-4 S5OLO	3/8	3/8	7/16 - 20	3/4	0.98	1.38	6.0	6.0
6-6-8 S5OLO	3/8	3/8	3/4 - 16	3/4	1.04	1.59	6.0	6.0
8 S5OLO	1/2	1/2	3/4 - 16	3/4	1.10	1.59	6.0	6.0
8-8-10 S5OLO	1/2	1/2	7/8 - 14	1 1/16	1.24	1.97	6.0	6.0
8-8-12 S5OLO	1/2	1/2	1 1/16 - 12	1 3/16	1.34	2.17	6.0	6.0
10 S5OLO	5/8	5/8	7/8 - 14	1 1/16	1.32	1.97	6.0	6.0
10-10-12 S5OLO	5/8	5/8	1 1/16 - 12	1 3/16	1.42	2.17	6.0	6.0
12 S5OLO	3/4	3/4	1 1/16 - 12	1 3/16	1.48	2.17	6.0	6.0
12-12-16 S5OLO	3/4	3/4	1 5/16 - 12	1 7/16	1.61	2.34	5.5	5.5
16 S5OLO	1	1	1 5/16 - 12	1 7/16	1.63	2.34	5.5	5.5
16-16-20 S5OLO	1	1	1 5/8 - 12	1 5/8	1.75	2.44	4.0	4.0
20 S5OLO	1 1/4	1 1/4	1 5/8 - 12	1 5/8	1.75	2.44	4.0	4.0
24 S5OLO	1 1/2	1 1/2	1 7/8 - 12	1 7/8	1.93	2.60	4.0	4.0

## R5OLO

Straight Thread Run Tee  
ORFS / SAE-ORB / ORFS

SAE 520428

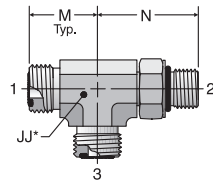

\* JJ – Across  
Wrench Flats

TUBE FITTING PART #	END SIZE			JJ (in.)	M (in.)	N (in.)	Dynamic Pressure (x 1,000 PSI)	
	1	2	3				-S	-SS
	(in.)	UN/UNF-2A	(in.)					
4 R5OLO	1/4	7/16 - 20	1/4	9/16	0.85	1.30	6.0	6.0
4-6-4 R5OLO	1/4	9/16 - 18	1/4	3/4	0.92	1.46	6.0	6.0
6 R5OLO	3/8	9/16 - 18	3/8	3/4	0.98	1.46	6.0	6.0
6-8-6 R5OLO	3/8	3/4 - 16	3/8	3/4	1.04	1.59	6.0	6.0
8 R5OLO	1/2	3/4 - 16	1/2	3/4	1.10	1.59	6.0	6.0
8-10-8 R5OLO	1/2	7/8 - 14	1/2	1 1/16	1.24	1.97	6.0	6.0
10 R5OLO	5/8	7/8 - 14	5/8	1 1/16	1.32	1.97	6.0	6.0
10-12-10 R5OLO	5/8	1 1/16 - 12	5/8	1 3/16	1.42	2.17	6.0	6.0
12 R5OLO	3/4	1 1/16 - 12	3/4	1 3/16	1.48	2.17	6.0	6.0
12-16-12 R5OLO	3/4	1 5/16 - 12	3/4	1 7/16	1.61	2.34	5.5	5.5
16 R5OLO	1	1 5/16 - 12	1	1 7/16	1.63	2.34	5.5	5.5
16-20-16 R5OLO	1	1 5/8 - 12	1	1 5/8	1.75	2.44	4.0	4.0
20 R5OLO	1 1/4	1 5/8 - 12	1 1/4	1 5/8	1.75	2.44	4.0	4.0
24 R5OLO	1 1/2	1 7/8 - 12	1 1/2	1 7/8	1.93	2.60	4.0	4.0

Dimensions and pressures for reference only, subject to change.

- TABLE OF CONTENTS
- VISUAL INDEX
- FAQs
- ASSEMBLY
- TUBE FAB EQUIP
- GEN TECH

Click here for CADs, Support Resources or to Configure Parts Online

# SLO

Male Pipe Tee  
ORFS / ORFS / NPTF

SAE 520425

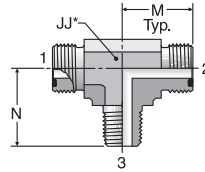

\* JJ – Across  
Wrench Flats

TUBE FITTING PART #	END SIZE		JJ (in.)	M (in.)	N (in.)	Dynamic Pressure (x 1,000 PSI)	
	1 & 2	3				-S	-SS
	(in.)	NPTF					
4-4-4 SLO	1/4	1/4 - 18	9/16	0.85	1.12	6.0	6.0
6 SLO	3/8	1/4 - 18	3/4	0.98	1.09	6.0	6.0
6-6-6 SLO	3/8	3/8 - 18	3/4	0.98	1.22	6.0	6.0
8 SLO	1/2	3/8 - 18	3/4	1.10	1.22	6.0	6.0
8-8-8 SLO	1/2	1/2 - 14	7/8	1.10	1.47	6.0	6.0
10 SLO	5/8	1/2 - 14	1 1/16	1.31	1.47	6.0	6.0
12 SLO	3/4	3/4 - 14	1 3/16	1.47	1.59	4.0	4.0
16 SLO	1	1 - 11 1/2	1 7/16	1.64	1.97	3.0	3.0
20 SLO	1 1/4	1 1/4 - 11 1/2	1 5/8	1.76	2.38	2.5	2.5

# S87OMLO

Metric Straight Thread Branch Tee  
ORFS / ORFS / ISO 6149

ISO 8434-3 SDBT  
SAE 52M0489

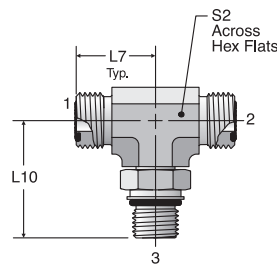

\* S2 – Across  
Hex Flats

TUBE FITTING PART #	END SIZE			L7 (mm)	L10 (mm)	S2 (mm)	Dynamic Pressure (x 1,000 PSI)	
	1 & 2	3	S				SS	
	(mm)	(in.)						ISO 261
4M12S87OMLO	6	1/4	M12X1.5	21.5	33.0	14	6.0	6.0
4M14S87OMLO	6	1/4	M14X1.5	23.5	35.5	19	6.0	6.0
6M14S87OMLO	8,10	3/8	M14X1.5	25.0	35.5	19	6.0	6.0
6M16S87OMLO	8,10	3/8	M16X1.5	25.0	37.5	19	6.0	6.0
8M14S87OMLO	12	1/2	M14X1.5	28.0	36.0	19	6.0	6.0
8M18S87OMLO	12	1/2	M18X1.5	28.0	41.0	19	6.0	6.0
8M22S87OMLO	12	1/2	M22X1.5	31.0	49.0	27	6.0	6.0
10M22S87OMLO	14,15,16	5/8	M22X1.5	33.5	49.0	27	6.0	6.0
12M27S87OMLO	18,20	3/4	M27X2	37.5	55.5	30	6.0	6.0
16M33S87OMLO	22,25	1	M33X2	41.5	59.5	36	5.1	5.1
20M42S87OMLO	28,30,32	1 1/4	M42X2	44.5	63.0	41	4.0	4.0
24M48S87OMLO	35,38	1 1/2	M48X2	49.0	71.5	50	4.0	4.0

**WARNING:** This product can expose you to chemicals including Lead and Lead Compounds which is known to the State of California to cause cancer and birth defects or other reproductive harm. For more information go to [www.p65warnings.ca.gov](http://www.p65warnings.ca.gov).

Dimensions and pressures for reference only, subject to change.

- A
- TABLE OF CONTENTS
- VISUAL INDEX
- FAQs
- ASSEMBLY
- TUBE FAB EQUIP
- GEN TECH

[Click here for CADs, Support Resources or to Configure Parts Online](#)

# R87OMLO

Metric Straight Thread Run Tee  
ORFS / ISO 6149 / ORFS

ISO 8434-3 SDRT  
SAE 52M0488

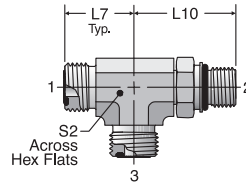

TUBE FITTING PART #	END SIZE			L7 (mm)	L10 (mm)	S2 (mm)	Dynamic Pressure (x 1,000 PSI)	
	1 & 3		2				S	SS
	(mm)	(in.)	ISO 261					
4M12R87OMLO	6	1/4	M12X1.5	21.5	33.0	14	6.0	6.0
4M14R87OMLO	6	1/4	M14X1.5	23.5	35.5	19	6.0	6.0
6M14R87OMLO	8,10	3/8	M14X1.5	25.0	35.5	19	6.0	6.0
6M16R87OMLO	8,10	3/8	M16X1.5	25.0	37.5	19	6.0	6.0
8M14R87OMLO	12	1/2	M14X1.5	28.0	36.0	19	6.0	6.0
8M18R87OMLO	12	1/2	M18X1.5	28.0	41.0	19	6.0	6.0
8M22R87OMLO	12	1/2	M22X1.5	31.0	49.0	27	6.0	6.0
10M22R87OMLO	14,15,16	5/8	M22X1.5	33.5	49.0	27	6.0	6.0
12M27R87OMLO	18,20	3/4	M27X2	37.5	55.5	30	6.0	6.0
16M33R87OMLO	22,25	1	M33X2	41.5	59.5	36	5.0	5.0
20M42R87OMLO	28,30,32	1 1/4	M42X2	44.5	63.0	41	4.0	4.0
24M48R87OMLO	35,38	1 1/2	M48X2	49.0	71.5	50	4.0	4.0

# S4OMLO

Branch Tee – BSPP  
(for ISO 1179-1 Port)  
ORFS / ORFS / BSPP-ORR

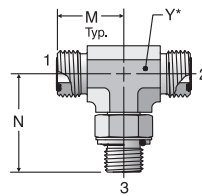

\*Y – Across Wrench Flats

TUBE FITTING PART #	END SIZE			M (mm)	N (mm)	Y (mm)	Dynamic Pressure (x 1,000 PSI)	
	1 & 2		3				S	SS
	(mm)	(in.)	BSPP					
4S4OMLO	6	1/4	1/8 - 28	21.5	30.0	14	4.0	4.0
4-4-4S4OMLO	6	1/4	1/4 - 19	23.5	36.0	19	4.0	4.0
6S4OMLO	8,10	3/8	1/4 - 19	25.0	36.0	19	4.0	4.0
6-6-6S4OMLO	8,10	3/8	3/8 - 19	26.5	38.0	19	4.0	4.0
8S4OMLO	12	1/2	3/8 - 19	28.0	38.0	19	4.0	4.0
8-8-8S4OMLO	12	1/2	1/2 - 14	31.0	48.5	27	4.0	4.0
10S4OMLO	14,15,16	5/8	1/2 - 14	33.5	48.5	27	4.0	4.0
12S4OMLO	18,20	3/4	3/4 - 14	37.5	51.5	30	4.0	4.0
16S4OMLO	22,25	1	1 - 11	41.5	58.5	36	4.0	4.0

**WARNING:** This product can expose you to chemicals including Lead and Lead Compounds which is known to the State of California to cause cancer and birth defects or other reproductive harm. For more information go to [www.p65warnings.ca.gov](http://www.p65warnings.ca.gov).

Dimensions and pressures for reference only, subject to change.

- TABLE OF CONTENTS
- VISUAL INDEX
- FAQs
- ASSEMBLY
- TUBE FAB EQUIP
- GEN TECH



Click here for CADs, Support Resources or to Configure Parts Online

# R40MLO

Run Tee – BSPP  
(for ISO 1179-1 Port)  
ORFS / BSPP-ORR / ORFS

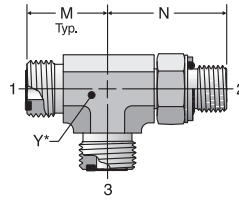

\* Y – Across  
Wrench Flats

TUBE FITTING PART #	END SIZE			M (mm)	N (mm)	Y (mm)	Dynamic Pressure (x 1,000 PSI)	
	1 & 3		2				S	SS
	(mm)	(in.)	BSPP					
4R40MLO	6	1/4	1/8 - 28	21.5	30.0	14	4.0	4.0
4-4-4R40MLO	6	1/4	1/4 - 19	23.5	36.0	19	4.0	4.0
6R40MLO	8,10	3/8	1/4 - 19	25.0	36.0	19	4.0	4.0
6-6-6R40MLO	8,10	3/8	3/8 - 19	26.5	38.0	19	4.0	4.0
8R40MLO	12	1/2	3/8 - 19	28.0	38.0	19	4.0	4.0
8-8-8R40MLO	12	1/2	1/2 - 14	31.0	48.5	27	4.0	4.0
10R40MLO	14,15,16	5/8	1/2 - 14	33.5	45.2	27	4.0	4.0
12R40MLO	18,20	3/4	3/4 - 14	37.5	51.5	30	4.0	4.0
16R40MLO	22,25	1	1 - 11	41.5	58.5	37	4.0	4.0

**WARNING:** This product can expose you to chemicals including Lead and Lead Compounds which is known to the State of California to cause cancer and birth defects or other reproductive harm. For more information go to [www.p65warnings.ca.gov](http://www.p65warnings.ca.gov).

# KLO

Union Cross  
ORFS (all four ends)

SAE 520501

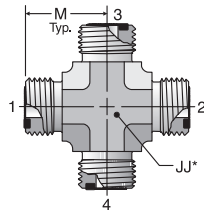

\* JJ – Across  
Wrench Flats

TUBE FITTING PART #	END SIZE		M (in.)	Dynamic Pressure (x 1,000 PSI)	
	1-4 (in.)	JJ (in.)		-S	-SS
4 KLO	1/4	9/16	0.85	9.2	9.2
6 KLO	3/8	3/4	0.98	9.2	9.2
8 KLO	1/2	3/4	1.10	9.2	9.2
10 KLO	5/8	1 1/16	1.32	6.0	6.0
12 KLO	3/4	1 3/16	1.48	6.0	6.0
16 KLO	1	1 5/8	1.63	6.0	6.0
20 KLO	1 1/4	1 5/8	1.75	5.0	5.0
24 KLO					

- A
- TABLE OF CONTENTS
- VISUAL INDEX
- FAQs
- ASSEMBLY
- TUBE FAB EQUIP
- GEN TECH

Dimensions and pressures for reference only, subject to change.

Click here for CADs, Support Resources or to Configure Parts Online

## PNLO

Plug  
ORFS

SAE 520109

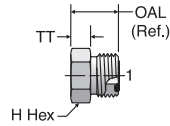

TUBE FITTING PART #	END SIZE	H HEX (in.)	OAL (REF) (in.)	TT (in.)	Dynamic Pressure (x 1,000 PSI)	
					-S	-SS
					1 (in.)	
4 PNLO	1/4	5/8	0.65	0.20	9.2	9.2
6 PNLO	3/8	3/4	0.75	0.32	9.2	9.2
8 PNLO	1/2	7/8	0.87	0.35	9.2	9.2
10 PNLO	5/8	1 1/16	1.02	0.41	6.0	6.0
12 PNLO	3/4	1 1/4	1.08	0.41	6.0	6.0
14 PNLO	7/8	1 3/8	1.10	0.49	6.0	6.0
16 PNLO	1	1 1/2	1.10	0.41	6.0	6.0
20 PNLO	1 1/4	1 3/4	1.10	0.41	6.0	6.0
24 PNLO	1 1/2	2 1/8	1.10	0.41	5.0	5.0
32 PNLO	2	2 3/4	1.40	0.50	3.0	3.0

**WARNING:** This product can expose you to chemicals including Lead and Lead Compounds which is known to the State of California to cause cancer and birth defects or other reproductive harm. For more information go to [www.p65warnings.ca.gov](http://www.p65warnings.ca.gov).

## PNMLO

Plug – mm Hex  
ORFS

ISO 8434-3 PL  
SAE 52M0109

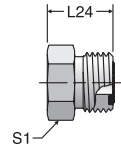

TUBE FITTING PART #	ORFS TUBE O.D.		L24 (mm)	S1 HEX (mm)	Dynamic Pressure (x 1,000 PSI)	
	(mm)	(in.)			S	SS
4PNMLO	6	1/4	16.5	17	9.2	9.2
6PNMLO	8,10	3/8	19.0	19	9.2	9.2
8PNMLO	12	1/2	22.0	22	9.2	9.2
10PNMLO	14,15,16	5/8	26.0	27	6.0	6.0
12PNMLO	18,20	3/4	27.5	32	6.0	6.0
16PNMLO	22,25	1	28.0	41	6.0	6.0
20PNMLO	28,30,32	1 1/4	28.0	46	6.0	6.0
24PNMLO	38	1 1/2	28.0	55	5.0	5.0

**WARNING:** This product can expose you to chemicals including Lead and Lead Compounds which is known to the State of California to cause cancer and birth defects or other reproductive harm. For more information go to [www.p65warnings.ca.gov](http://www.p65warnings.ca.gov).

- TABLE OF CONTENTS
- VISUAL INDEX
- FAQs
- ASSEMBLY
- TUBE FAB EQUIP
- GEN TECH

## FNL

Cap  
ORFS

SAE 520112

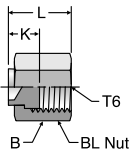

TUBE FITTING PART #	TUBE O.D. (in.)	T6 SWIVEL UN/UNF-2B	B HEX (in.)	K (in.)	L (in.)	Dynamic Pressure (x 1,000 PSI)	
						-S	-SS
4 FNL	1/4	9/16 - 18	11/16	0.35	0.66	9.2	9.2
6 FNL	3/8	11/16 - 16	13/16	0.41	0.74	9.2	9.2
8 FNL	1/2	13/16 - 16	15/16	0.47	0.87	9.2	9.2
10 FNL	5/8	1 - 14	1 1/8	0.53	1.02	6.0	6.0
12 FNL	3/4	1 3/16 - 12	1 3/8	0.59	1.12	6.0	6.0
14 FNL	7/8	1 5/16 - 12	1 1/2	0.59	1.12	6.0	6.0
16 FNL	1	1 7/16 - 12	1 5/8	0.63	1.16	6.0	6.0
20 FNL	1 1/4	1 11/16 - 12	1 7/8	0.63	1.16	6.0	6.0
24 FNL	1 1/2	2 - 12	2 1/4	0.63	1.16	5.0	5.0
32 FNL	2	2 1/2 - 12	2 7/8	0.79	1.46	3.0	3.0

**WARNING:** This product can expose you to chemicals including Lead and Lead Compounds which is known to the State of California to cause cancer and birth defects or other reproductive harm. For more information go to [www.p65warnings.ca.gov](http://www.p65warnings.ca.gov).

## FNML

Cap  
ORFS

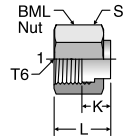

TUBE FITTING PART #	TUBE O.D.		T6 SWIVEL UN/UNF-2B	K (mm)	L (mm)	S HEX (mm)	Dynamic Pressure (x 1,000 PSI)	
	(mm)	(in.)					S	SS
4FNML	6	1/4	9/16 - 18	9.0	16.8	17	9.2	9.2
6FNML	8, 10	3/8	11/16 - 16	10.5	18.8	22	9.2	9.2
8FNML	12	1/2	13/16 - 16	12.0	22.0	24	9.2	9.2
10FNML	14, 15, 16	5/8	1 - 14	13.5	26.0	30	6.0	6.0
12FNML	18, 20	3/4	1 3/16 - 12	15.0	28.6	36	6.0	6.0
16FNML	22, 25	1	1 7/16 - 12	16.0	29.5	41	6.0	6.0
20FNML	28, 30, 32	1 1/4	1 11/16 - 12	16.0	29.5	50	6.0	6.0
24FNML	35, 38	1 1/2	2 - 12	16.0	29.5	60	5.0	5.0

**WARNING:** This product can expose you to chemicals including Lead and Lead Compounds which is known to the State of California to cause cancer and birth defects or other reproductive harm. For more information go to [www.p65warnings.ca.gov](http://www.p65warnings.ca.gov).

Dimensions and pressures for reference only, subject to change.

[Click here for CADs, Support Resources or to Configure Parts Online](#)

# UPTC Nut Assembly

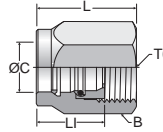

A

- TABLE OF CONTENTS
- VISUAL INDEX
- FAQs
- ASSEMBLY
- TUBE FAB EQUIP
- GEN TECH

TUBE FITTING PART #	END SIZE (in.)	T6 UN/UNF-2B	B HEX (in.)	L (in.)	L1 (in.)	C		Dynamic Pressure (x 1,000 PSI)
						Nominal Nipple Size		
						(in.)	(mm)	
4 UPTCL	1/4	9/16-18	11/16	0.97	0.68	0.31	8	5.8
6 UPTCL	3/8	11/16-16	13/16	1.06	0.74	0.47	12	5.0
8 UPTCL	1/2	13/16-16	15/16	1.19	0.81	0.59	15	4.2
10 UPTCL	5/8	1-14	1 1/8	1.34	0.87	0.71	18	4.0
12 UPTCL	3/4	1 3/16-12	1 3/8	1.38	0.86	0.87	22	3.1
16 UPTCL	1	1 7/16-12	1 5/8	1.48	0.94	0.98	25	3.1

To order as pre-torqued assembly on standard Seal-Lok adapters, see page A7.

**⚠ WARNING:** This product can expose you to chemicals including Lead and Lead Compounds which is known to the State of California to cause cancer and birth defects or other reproductive harm. For more information go to [www.p65warnings.ca.gov](http://www.p65warnings.ca.gov).

Dimensions and pressures for reference only, subject to change.



TABLE  
OF  
CONTENTS

VISUAL  
INDEX

B















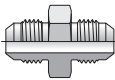
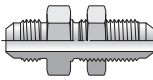
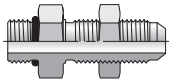
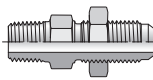
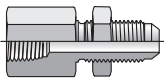

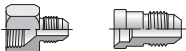
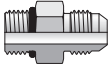
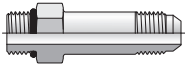



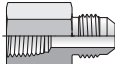

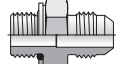

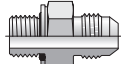
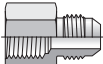
# TRIPLE-LOK™ & TRIPLE-LOK™ 2

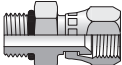

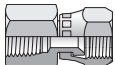

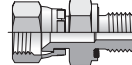
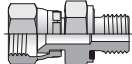
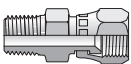
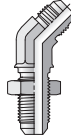

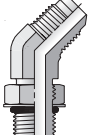
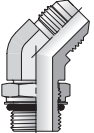
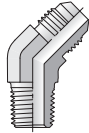

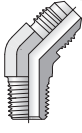
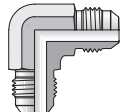
37° Flare Tube Fittings

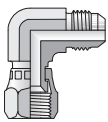
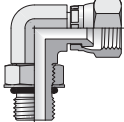
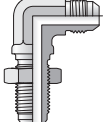
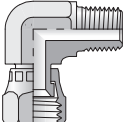
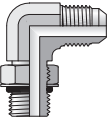
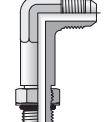
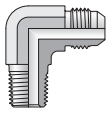
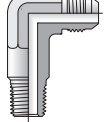
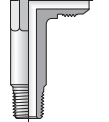
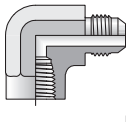
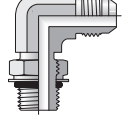
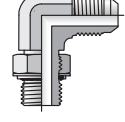
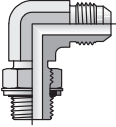
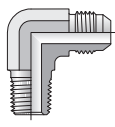

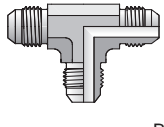
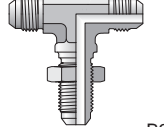
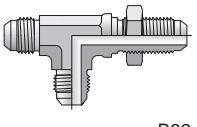
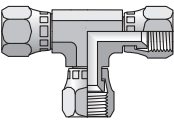
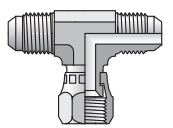
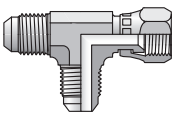
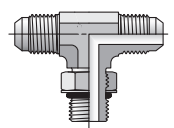
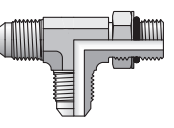
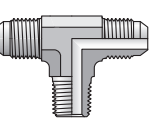
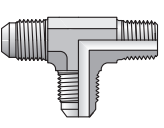
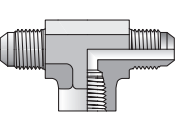
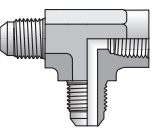
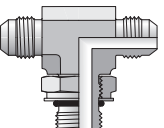
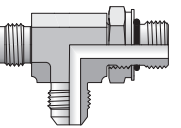
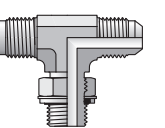
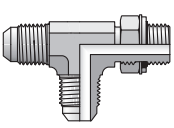

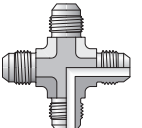
TABLE  
OF  
CONTENTS

<b>Nuts, Sleeves, Locknuts</b>	<b>BTX</b> Nut  B9	<b>TX and TX Metric</b> Sleeve  B9	<b>WLN</b> Bulkhead Locknut  B10	<b>SBR</b> Braze Ring  B10	
<b>Straights</b>	<b>HTX</b> Union  B11	<b>LHTX</b> Large Hex Union  B11	<b>WTX</b> Bulkhead Union  B12	<b>WF50X</b> SAE-ORB / 37° Bulkhead  B12	<b>WFTX</b> NPTF / 37° Bulkhead  B12
<b>WGTX</b> NPTF / 37° Bulkhead  B13	<b>HX6</b> Extender and Expander  B13	<b>TRTX / TRTXN</b> Reducer  B14	<b>F50X</b> SAE-ORB / 37° Flare  B15	<b>FF50X</b> SAE-ORB / 37° – Long  B15	<b>XHB3</b> Braze Socket / 37° Flare  B15
<b>FTX</b> NPTF / 37° Flare  B16	<b>FFTX</b> NPTF / 37° Flare – Long  B16	<b>GTX</b> NPTF / 37° Flare  B17	<b>F870MX</b> ISO 6149 / 37° Flare  B17	<b>F82EDMX</b> Metric-ED / 37° Flare  B17	<b>F80MX</b> Metric-ORR / 37° Flare  B18
<b>F42EDMX</b> BSPP-ED / 37° Flare  B18	<b>F40MX</b> BSPP-ORR / 37° Flare  B19	<b>G4MX</b> BSPP / 37° Flare  B19	<b>F3MX</b> BSPT / 37° Flare  B19	<b>Straight Swivels</b>	<b>HX6</b> 37° Swivel Union  B19
<b>F650X</b> SAE-ORB / 37° Swivel  B20	<b>F6X</b> NPTF / 37° Swivel  B20	<b>G6X</b> NPTF / 37° Swivel  B20	<b>F6870MX</b> ISO-6149 / 37° Swivel  B20	<b>F680MX</b> Metric-ORR / 37° Swivel  B21	<b>F682EDMX</b> Metric-ED / 37° Swivel  B21
<b>F642EDMX</b> BSPP-ED / 37° Swivel  B21	<b>F63MX</b> BSPT / 37° Swivel  B21	<b>45° Elbows</b>	<b>WNTX</b> Bulkhead Union  B22	<b>V6X</b> 37° Swivel Elbow  B22	<b>V50X</b> SAE-ORB / 37° Flare  B23
<b>V870MX</b> ISO-6149 / 37° Flare  B23	<b>VTX</b> NPTF / 37° Flare  B24	<b>V40MX</b> BSPP-ORR / 37° Flare  B24	<b>V3MX</b> BSPT / 37° Flare  B24	<b>90° Elbows</b>	<b>ETX</b> Union Elbow  B25

<b>C6X</b> 37° Swivel Elbow  B25	<b>AOEX6</b> SAE-ORB / 37° Swivel  B25	<b>WETX</b> Bulkhead Union  B26	<b>X6EF</b> NPTF / 37° Swivel  B27	<b>C5OX</b> SAE-ORB / 37° Flare  B27	<b>CC5OX</b> SAE-ORB / 37° – Long  B27
<b>CTX</b> NPTF / 37° Flare  B28	<b>CCTX</b> NPTF / 37° Flare – Long  B28	<b>CCCTX</b> NPTF / 37° – Extra Long  B28	<b>DTX</b> NPTF / 37° Flare  B29	<b>C87OMX</b> ISO-6149 / 37° Flare  B29	<b>C8OMX</b> Metric-ORR / 37° Flare  B29
<b>C4OMX</b> BSPP-ORR / 37° Flare  B30	<b>C3MX</b> BSPT / 37° Flare  B30	 Tees	<b>JTX</b> Union Tee  B31	<b>WJTX</b> Bulkhead Branch Tee  B31	<b>WJJTX</b> Bulkhead Run Tee  B32
<b>JX6</b> 37° Swivel Union Tee  B32	<b>S6X</b> 37° Swivel Branch Tee  B32	<b>R6X</b> 37° Swivel Run Tee  B33	<b>S5OX</b> SAE-ORB Branch Tee  B33	<b>R5OX</b> SAE-ORB Run Tee  B33	<b>STX</b> NPTF Branch Tee  B34
<b>RTX</b> NPTF Run Tee  B34	<b>OTX</b> NPTF Branch Tee  B34	<b>MTX</b> NPTF Run Tee  B34	<b>S87OMX</b> ISO 6149 Branch Tee  B35	<b>R87OMX</b> ISO 6149 Run Tee  B35	<b>S4OMX</b> BSPP-ORR Branch Tee  B35
<b>R4OMX</b> BSPP-ORR Run Tee  B35	 Cross	<b>KTX</b> Union Cross  B36	 Plug and Cap	<b>PNTX</b> 37° Plug  B36	<b>FNTX</b> 37° Cap  B36
<b>T22X</b> Mountie Cap  B36					

**B**

**TABLE  
OF  
CONTENTS**

### Triple-Lok® 2 Soft Seal Flare Tube Fittings









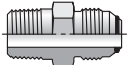

 <p><b>Straights</b></p>	<p><b>HTXO</b> Union</p>  <p>B37</p>	<p><b>F5OXO</b> SAE-ORB / 37° Flare</p>  <p>B37</p>	<p><b>FTXO</b> NPTF / 37° Flare</p>  <p>B37</p>	<p><b>GTXO</b> NPTF / 37° Flare</p>  <p>B37</p>
	<p><b>ETXO</b> Union Elbow</p>  <p>B38</p>	<p><b>C6XO</b> 37° Swivel Elbow</p>  <p>B38</p>	<p><b>CTXO</b> NPTF / 37° Flare</p>  <p>B38</p>	<p><b>C5OXO</b> SAE-ORB / 37° Flare</p>  <p>B38</p>
	<p><b>JTXO</b> Union Tee</p>  <p>B39</p>	<p><b>RTXO</b> 37° Swivel Run Tee</p>  <p>B39</p>	<p><b>R5OXO</b> SAE-ORB Run Tee</p>  <p>B39</p>	

TABLE  
 OF  
 CONTENTS

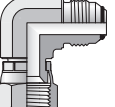
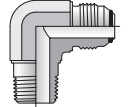
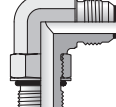
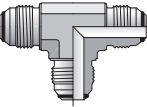
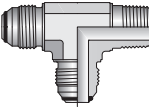
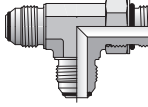
### Flange Adapters (Shown in Section K)

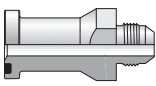
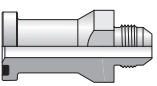

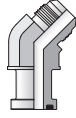
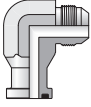
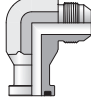
 <p><b>SAE Flange Adapters</b></p>	<p><b>XHQ1</b> Code 61 / 37° Flare</p>  <p>K12</p>	<p><b>XHQ2</b> Code 62 / 37° Flare</p>  <p>K12</p>	<p><b>XVQ1</b> Code 61 / 37° Flare</p>  <p>K32</p>	<p><b>XVQ2</b> Code 62 / 37° Flare</p>  <p>K32</p>	<p><b>XEQ1</b> Code 61 / 37° Flare</p>  <p>K33</p>
	<p><b>XEQ2</b> Code 62 / 37° Flare</p>  <p>K33</p>				

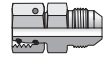
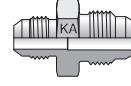
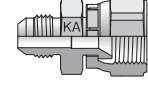
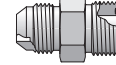
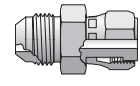
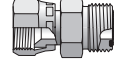
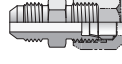
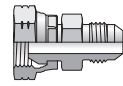
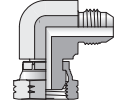
### Conversion Adapters (Shown in Sections I and J)

 <p><b>Conversion Adapters</b></p>	<p><b>XHU86</b> Metric Swivel (EO) / 37°</p>  <p>J6</p>	<p><b>XHMKA</b> Komatsu 30° / 37° Flare</p>  <p>I5</p>	<p><b>XHMKA6</b> Komatsu 30° Swivel / 37°</p>  <p>I6</p>	<p><b>XHLO</b> 37° Flare / ORFS</p>  <p>J3</p>	<p><b>XHL6</b> 37° Flare / ORFS Swivel</p>  <p>J3</p>
	<p><b>LOHX6</b> ORFS / 37° Swivel</p>  <p>J3</p>	<p><b>XHBU</b> 37° Flare / Flareless</p>  <p>J4</p>	<p><b>XHMK46</b> 37° Flare / BSPP Swivel</p>  <p>J5</p>	<p><b>XEMK46</b> 37° Flare / BSPP Swivel</p>  <p>J6</p>	

**B**  
**TABLE OF CONTENTS**

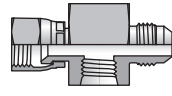
### Diagnostic and Orifice Fittings (Shown in Section L)

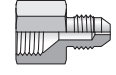
 <p><b>Diagnostic Tee</b></p>	<p><b>XHX6G5TP</b> 37° Flare / 37° Swivel / SAE-ORB</p>  <p>L5</p>	 <p><b>Orifice Fitting</b></p>	<p><b>XHX7</b> 37° Flare / 37° Female with Orifice</p>  <p>L9</p>
--	---	---	--



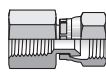
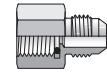



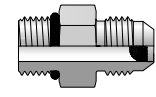

### Gauge Fittings (Shown in Section L)

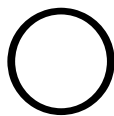
 <p><b>Gauge Fittings</b></p>	<p><b>G6X</b> NPT Gauge / 37° Swivel</p>  <p>L7</p>	<p><b>G4MXSMO</b> BSPP Gauge / 37° Flare</p>  <p>L6</p>
--	--	--

### Screen Fittings (Shown in Section L)

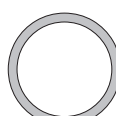
 <p><b>Screen Fittings</b></p>	<p>Screen Fittings</p>  <p>L12</p>
--	---

### O-Rings and Seals (Shown in Section M)

 <p><b>O-Rings and Seals</b></p>	<p><b>XO O-Ring</b></p>  <p>M4</p>	<p><b>SAE O-Ring</b></p>  <p>M4</p>	<p><b>ISO 6149 O-Ring</b></p>  <p>M5</p>	<p><b>Metric O-Ring</b></p>  <p>M5</p>	<p><b>Metric Retaining Ring</b></p>  <p>M5</p>
	<p><b>BSPP O-Ring</b></p>  <p>M6</p>	<p><b>BSPP Retaining Ring</b></p>  <p>M6</p>	<p><b>EOLastic Seal Ring</b></p>  <p>M6</p>		



## Triple-Lok

Parker Triple-Lok fittings meet the strict requirements of SAE J514 and ISO 8434-2 industry standards for 37° flare fittings. Its design is simple. It uses an easily produced flare at the tube end to seal and hold fluid under high pressure. The fitting consists of three pieces: the body, sleeve and nut. The tube is flared at a 37° angle (74° included angle) and held between the fitting nose (seat) and the sleeve (support) with the nut as shown in Fig. B1, providing a very effective seal between the fitting nose and the tube flare.

The design of Triple-Lok fittings is very efficient. The fitting incorporates the smallest seal area of all fitting types. This seal area, as seen in Fig. B1, is only slightly larger than the fluid flow area. The small seal area results in a compact design, low assembly torque, and a relatively high-pressure capability.

## How Triple-Lok Fittings Work

Tightening of the nut clamps the tube flare between the body nose (seat) producing a leak tight connection. This clamping on the 37° taper provides a measure of elasticity to the joint helping it to resist loosening under vibration. The clamping force results in a small radial load that tends to deform the fitting nose radially. The resistance of the nose to elastic deformation provides a constant preload (similar to a lockwasher) keeping it tight.

The clamping force provided by the nut resists the opposing force of the fluid under pressure. The joint remains leak tight as long as the clamping force is higher than the opposing pressure load. Properly assembled Triple-Lok fittings with appropriate tube will seal consistently under pressure until tube bursts.

Sealing in Triple-Lok fittings takes place between two smooth metal surfaces, the fitting nose and inside of the tube flare. Therefore, the sealing surfaces have to be smooth, free of any nicks, scratches, spiral tool marks, splits or weld beads. Seamless or welded and drawn fully annealed tube is recommended for Triple-Lok fittings for ease in flaring and bending. Certain types of harder tubes that are not fully annealed may not be suitable for flaring due to the potential for immediate or long-term cracking of the tube flare. For specific tube type and wall thickness recommendations, please see Table S11 and S14 in the General Technical Section.

## International Acceptance

The versatility of 37° flare fittings is a primary reason for its worldwide acceptance. To illustrate the versatility of Triple-Lok, refer to Fig. B2. The Triple-Lok adapter is attachable to either inch tube, metric tube, or a hose assembly. To adapt to metric tube, simply change the sleeve (using the standard inch adapter and nut). Please see Table S29 in the General Technical Section for a clear illustration of every "convertible sleeve" connection for the 37° design. For example, a 25 mm tube would use a standard SAE -16 (1") flare fitting and nut, however, a 25 mm metric sleeve (TXS25) would replace the inch size sleeve.

Triple-Lok fittings are available with many different port options for the various international hydraulic ports available, such as SAE straight thread, NPT/NPTF, BSPP, BSPT and Metric (including ISO 6149).

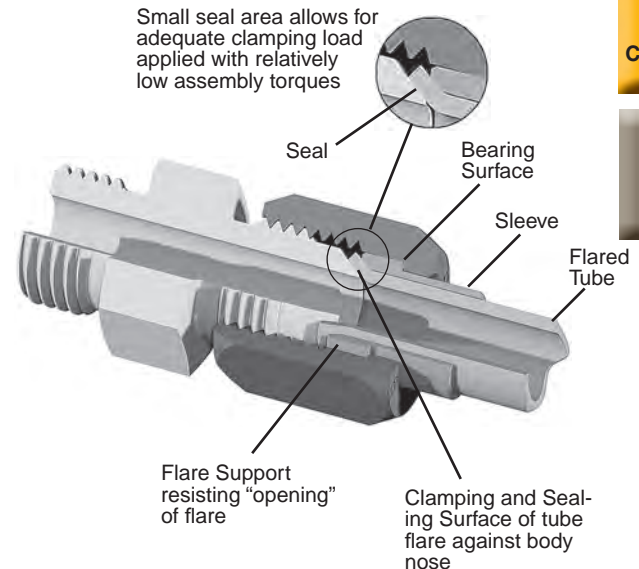

Fig. B1 – Triple-Lok Design and Features

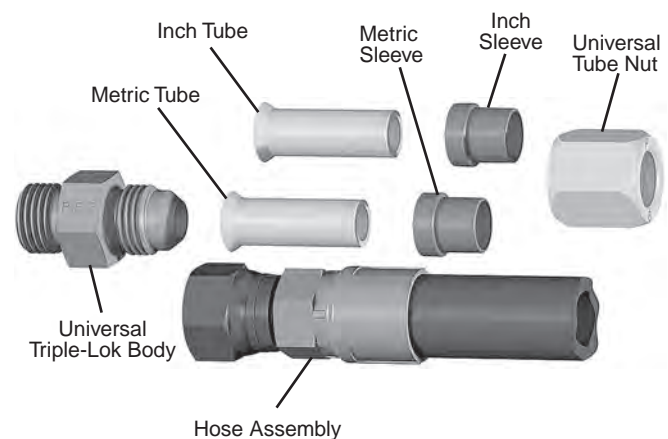

Fig. B2 – Triple-Lok's Adaptability to Inch Tube, Metric Tube, or Hose Assemblies

TABLE  
OF  
CONTENTS

VISUAL  
INDEX

## Triple-Lok 2

Triple-Lok 2 combines the versatility of stainless steel Triple-Lok with the added advantage of an elastomeric seal. It incorporates an O-ring that is positioned in the nose of the 37° flare so that elastomeric sealing occurs with the mating flared tube. Similar to the standard stainless steel Triple-Lok, Triple-Lok 2 consists of three pieces: the body (with O-ring), the standard Triple-Lok sleeve and standard Triple-Lok nut. The tube end is flared at a 37° angle (74° included angle) and held between the fitting nose and sleeve with the nut as shown in Fig. B3, providing a very effective elastomeric seal between the fitting nose and the tube flare.

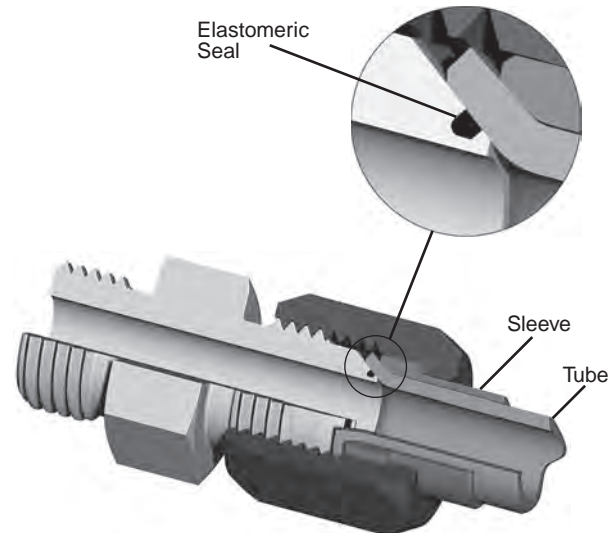
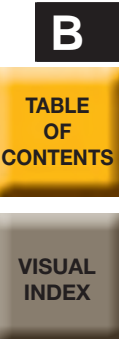

Fig. B3 – Triple-Lok 2 Design and Features



## The Parker Advantage

**Robust Port Stud:** The adjustable port stud is manufactured with a longer locknut designed to cover the uppermost threads completely. Since the backup washer is never exposed to the upper threads, it cannot be damaged during assembly. During assembly, exposed upper threads, as common with fittings from other fitting manufacturers, can lead to a deformed backup washer that can pinch the o-ring and create an o-ring extrusion gap that has the potential to leak. The longer locknut also provides a greater grip area for the wrench.

**Superior Plating:** Parker's Triple-Lok steel fittings come standard with ToughShield (TS1000) plating, giving them unmatched protection against red rust. In ASTM B117 neutral salt spray testing, TS1000 remained rust free for up to 1,000 hours, far exceeding SAE industry requirements of 96 hours and also outperforming the competition. See [www.ravagesofredrust.com](http://www.ravagesofredrust.com) for more information.

**Pre-Lubricated Stainless Steel Tube Nut:** All stainless steel Triple-Lok tube nuts have a pre-applied anti-seize lubricant to prevent galling during assembly.

**Wide Selection:** Triple-Lok fittings are available as standard in steel, stainless steel, brass and aluminum materials. Coupled with its broad line of configurations and port end options, Parker is well positioned to better service the hydraulic requirements of the international markets.

**Triple-Lok 2:** Triple-Lok 2 utilizes an elastomeric seal in the flare nose for improved seal reliability in applications where stainless steel fittings are required.

## Reference locations

**Dynamic Pressure Ratings:** Please refer to the last column of the part number tables located on the following pages of this section for the appropriate dynamic pressure ratings.

**Recommended Tube Wall Thickness:** Please refer to Table S14 located in the General Technical section.

**Assembly and Installation:** Please refer to Triple-Lok Assembly located within the Assembly/Installation section of this catalog.

**Standard material specifications:** Please refer to Table T1 located in the Appendix section.

**Seal Material Selection:** Please refer to Table S10 in the General Technical section of this catalog.

Dimensions and pressures for reference only, subject to change.

## Triple-Lok 37° Flared Tube Ends

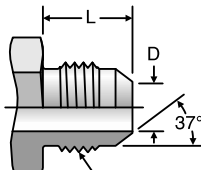

Triple-Lok Male Flare Tube End

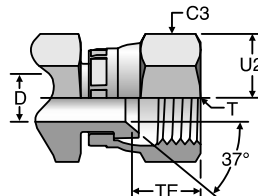

Triple-Lok Swivel

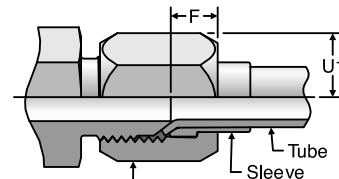

Triple-Lok Tube End Assembly

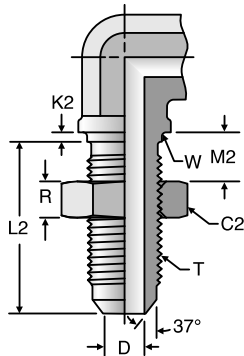

Triple-Lok Shape Bulkhead

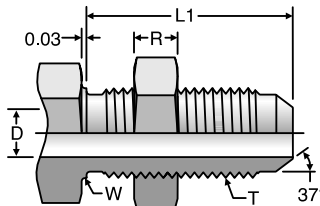

Triple-Lok Straight Bulkhead

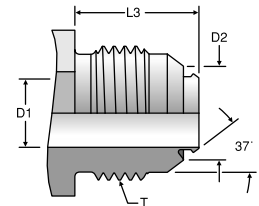

Triple-Lok 2 Male Flare Tube End

TABLE OF CONTENTS

VISUAL INDEX

SAE Dash Size	Tube O.D.		T	C	C2	C3	D	D1	L	L3	F	TE	Assembly Allowance		Bulkhead					Max Bulkhead Thickness		Min. Flare Dia.						
													Thread	Tube Nut Hex	Bulkhead Locknut Hex	Swivel Nut Hex	Max Drill	Male Turn Back	Tube Nut	Swivel Nut	Pilot Length - Shapes		Length - Straights	Length - Shapes	Locknut Thickness	Pilot Dia (Max)	Straights	Shapes
													(in.)	(mm)	UN/UNF	(in.)	(in.)	(in.)	(mm)	(in)	(in)		(in)	(in)	(in)	(in)	(in)	(in)
2	1/8	—	5/16-24	3/8	9/16	7/16	—	0.062	—	0.45	—	0.19	0.31	0.094	1.11	0.92	0.22	0.313	0.38	0.25	—							
3	3/16	—	3/8-24	7/16	5/8	1/2	—	0.125	—	0.48	—	0.25	0.33	0.094	1.11	0.92	0.22	0.375	0.38	0.25	—							
4	1/4	6	7/16-20	9/16	11/16	9/16	14	0.172	0.156	0.55	0.56	0.19	0.34	0.094	1.20	1.02	0.28	0.438	0.38	0.25	0.254							
5	5/16	8	1/2-20	5/8	3/4	5/8	16	0.234	0.217	0.55	0.56	0.30	0.38	0.094	1.20	1.02	0.28	0.500	0.38	0.25	0.314							
6	3/8	10	9/16-18	11/16	13/16	11/16	17	0.297	0.263	0.56	0.57	0.28	0.38	0.094	1.28	1.09	0.27	0.563	0.44	0.35	0.359							
8	1/2	12	3/4-16	7/8	1	7/8	22	0.391	0.391	0.66	0.66	0.31	0.42	0.125	1.44	1.25	0.31	0.750	0.44	0.35	0.510							
10	5/8	14 15 16	7/8-14	1	1 1/8	1	27	0.484	0.446	0.76	0.81	0.38	0.50	0.125	1.58	1.39	0.36	0.875	0.44	0.35	0.610							
12	3/4	18 20	1 1/16-12	1 1/4	1 3/8	1 1/4	32	0.610	0.578	0.86	0.91	0.36	0.56	0.125	1.75	1.56	0.41	1.063	0.44	0.35	0.753							
14	7/8	22	1 3/16-12	1 3/8	1 1/2	1 3/8	36	0.718	0.680	0.89	0.95	0.38	0.58	0.125	1.75	1.56	0.41	1.188	0.44	0.35	0.849							
16	1	25	1 5/16-12	1 1/2	1 5/8	1 1/2	38	0.844	0.769	0.91	0.99	0.34	0.59	0.125	1.75	1.56	0.41	1.313	0.44	0.35	0.940							
20	1 1/4	28 30 32	1 5/8-12	2	1 7/8	2	50	1.078	1.020	0.96	1.03	0.34	0.63	0.125	1.80	1.61	0.41	1.625	0.44	0.35	1.198							
24	1 1/2	35 38	1 7/8-12	2 1/4	2 1/8	2 1/4	60	1.312	1.230	1.08	1.16	0.50	0.73	0.125	1.81	1.62	0.41	1.875	0.31	0.22	1.416							
32	2	—	2 1/2-12	2 7/8	2 3/4	2 7/8	—	1.781	1.736	1.33	1.40	0.55	0.94	0.125	2.09	1.91	0.41	2.500	0.35	0.25	1.994							
40 <sup>2)</sup>	2 1/2	—	3-12	3 3/8	—	—	—	2.281	—	—	—	0.55	—	0.125	1.72	1.72	0.41	2.998	0.45	0.45	—							

1) Recommended clearance hole = W + 0.015.

2) Not a standard SAE J514 size.

[Click here for CADs, Support Resources or to Configure Parts Online](#)

# BTX

Nut  
37° Flare

SAE 070110  
HPD Base # 06B

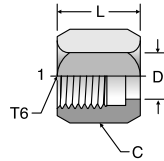

TUBE FITTING PART #	END SIZE		T6 UN/UNF-2B	C HEX (in.)	D (in.)	L (in.)	Material		
	(in.)	(mm)					-S	-SS	-B
2 BTX	1/8	—	5/16 - 24	3/8	0.180	0.55	•	•	•
3 BTX	3/16	—	3/8 - 24	7/16	0.240	0.61	•	•	•
4 BTX	1/4	6	7/16 - 20	9/16	0.310	0.62	•	•	•
5 BTX	5/16	8	1/2 - 20	5/8	0.380	0.68	•	•	•
6 BTX	3/8	10	9/16 - 18	11/16	0.440	0.73	•	•	•
8 BTX	1/2	12	3/4 - 16	7/8	0.570	0.85	•	•	•
10 BTX	5/8	14, 15, 16	7/8 - 14	1	0.700	0.98	•	•	•
12 BTX	3/4	18	1 1/16 - 12	1 1/4	0.840	1.03	•	•	•
20-12 BTX	—	20	1 1/16 - 12	1 1/4	0.862	0.87	•	•	•
14 BTX	7/8	22	1 3/16 - 12	1 3/8	0.960	1.09	•	•	•
16 BTX	1	25	1 5/16 - 12	1 1/2	1.090	1.13	•	•	•
20 BTX	1 1/4	28, 30, 32	1 5/8 - 12	2	1.350	1.23	•	•	•
24 BTX	1 1/2	35, 38	1 7/8 - 12	2 1/4	1.620	1.42	•	•	•
32 BTX	2	42, 50	2 1/2 - 12	2 7/8	2.170	1.75	•	•	•

Note: All stainless steel nuts are coated to prevent galling at assembly.

**WARNING:** This product can expose you to chemicals including Lead and Lead Compounds which is known to the State of California to cause cancer and birth defects or other reproductive harm. For more information go to [www.p65warnings.ca.gov](http://www.p65warnings.ca.gov).

# TX (inch)

Sleeve  
37° Flare

SAE 070115  
HPD Base # 06S

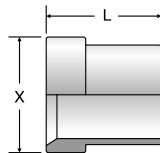

TUBE FITTING PART #	END SIZE (in.)	L (in.)	X (in.)	Material		
				-S	-SS	-B
2 TX	1/8	0.34	0.27	•	•	•
3 TX	3/16	0.34	0.33	•	•	•
4 TX	1/4	0.41	0.38	•	•	•
5 TX	5/16	0.44	0.45	•	•	•
6 TX	3/8	0.50	0.50	•	•	•
8 TX	1/2	0.56	0.68	•	•	•
10 TX	5/8	0.66	0.80	•	•	•
12 TX	3/4	0.69	0.97	•	•	•
14 TX	7/8	0.75	1.10	•	•	•
16 TX	1	0.78	1.22	•	•	•
20 TX	1 1/4	0.91	1.53	•	•	•
24 TX	1 1/2	1.13	1.78	•	•	•
32 TX	2	1.19	2.41	•	•	•

**WARNING:** This product can expose you to chemicals including Lead and Lead Compounds which is known to the State of California to cause cancer and birth defects or other reproductive harm. For more information go to [www.p65warnings.ca.gov](http://www.p65warnings.ca.gov).

# TX (metric)

Sleeve  
37° Flare

SAE 0701M15

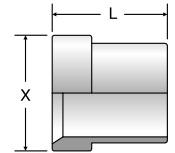

TUBE FITTING PART #	See Note	END SIZE (mm)	FITTING DASH SIZE	L (mm)	X (mm)	Material		
						S	SS	B
TXS6	3	6	-4	10.4	9.6	•	•	•
TXS8	3	8	-5	11.2	11.4	•	•	•
TXS10	3	10	-6	12.7	12.7	•	•	•
TXS12	3	12	-8	14.2	17.3	•	•	•
TXS14	3	14	-10	16.8	20.3	•	•	•
TXS15	3	15	-10	16.8	20.3	•	•	•
TXS16	3	16	-10	16.8	20.3	•	•	•
TXS18	3	18	-12	17.3	24.6	•	•	•
20-12 TX	2	20	-12	17.3	24.6	•	•	•
TXS22	3	22	-14	19.0	27.8	•	•	•
TXS25	3	25	-16	19.8	31.0	•	•	•
TXS28	3	28	-20	23.1	38.9	•	•	•
TXS30	3	30	-20	23.1	38.9	•	•	•
TXS32	3	32	-20	23.1	38.9	•	•	•
TXS35	3	35	-24	28.4	45.2	•	•	•
24 TX	1	38	-24	28.4	45.2	•	•	•

1. Inch sleeve for use with metric tubing.
2. Use with 20-12 BTX.
3. The part numbers above are for steel. Use "SS" in place of "S" for ordering stainless steel. Example: TXSS12

**WARNING:** This product can expose you to chemicals including Lead and Lead Compounds which is known to the State of California to cause cancer and birth defects or other reproductive harm. For more information go to [www.p65warnings.ca.gov](http://www.p65warnings.ca.gov).

B

TABLE OF CONTENTS

VISUAL INDEX

FAQs

ASSEMBLY

TUBE FAB EQUIP

GEN TECH



[Click here for CADs, Support Resources or to Configure Parts Online](#)

## WLN

Bulkhead Locknut

SAE 080118 and 070118  
HPD Base # 53-XN

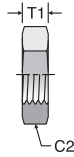

TUBE FITTING PART #	TUBE O.D. (in.)	C2 HEX (in.)	T1 (in.)	Material		
				-S	-SS	-B
3 WLN	3/16	5/8	0.22	•	•	•
4 WLN	1/4	11/16	0.28	•	•	•
5 WLN	5/16	3/4	0.28	•	•	•
6 WLN	3/8	13/16	0.27	•	•	•
8 WLN	1/2	1	0.31	•	•	•
10 WLN	5/8	1 1/8	0.36	•	•	•
12 WLN	3/4	1 3/8	0.41	•	•	•
14 WLN	7/8	1 1/2	0.41	•	•	•
16 WLN	1	1 5/8	0.41	•	•	•
20 WLN	1 1/4	1 7/8	0.41	•	•	•
24 WLN	1 1/2	2 1/8	0.41	•	•	•
32 WLN	2	2 3/4	0.41	•	•	•

**WARNING:** This product can expose you to chemicals including Lead and Lead Compounds which is known to the State of California to cause cancer and birth defects or other reproductive harm. For more information go to [www.p65warnings.ca.gov](http://www.p65warnings.ca.gov).

## SBR

Braze Ring

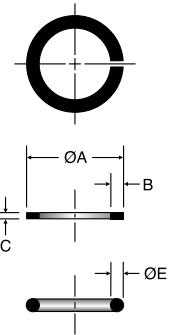

TUBE FITTING PART #	TUBE O.D. (in.)	A DIA. (in.)	B (in.)	C (in.)	E (in.)	Material		
						-S	-SS	-B
4 SBR	1/4	0.260	—	—	0.05	•	•	•
6 SBR	3/8	0.390	0.07	0.03	—	•	•	•
8 SBR	1/2	0.515	0.07	0.03	—	•	•	•
10 SBR	5/8	0.640	0.07	0.03	—	•	•	•
12 SBR	3/4	0.765	0.08	0.04	—	•	•	•
14 SBR	7/8	0.890	—	—	0.06	•	•	•
16 SBR	1	1.015	0.08	0.04	—	•	•	•
20 SBR	1 1/4	1.265	0.08	0.04	—	•	•	•
24 SBR	1 1/2	1.515	0.08	0.04	—	•	•	•
32 SBR	2	2.015	—	—	0.09	•	•	•

**WARNING:** This product can expose you to chemicals including Cadmium which is known to the State of California to cause cancer and birth defects or other reproductive harm. For more information go to [www.p65warnings.ca.gov](http://www.p65warnings.ca.gov).

- TABLE OF CONTENTS
- VISUAL INDEX
- FAQs
- ASSEMBLY
- TUBE FAB EQUIP
- GEN TECH

Click here for CADs, Support Resources or to Configure Parts Online

# HTX

Union  
37° Flare / 37° Flare

SAE 070101  
HPD Base # 0303

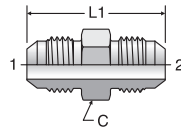

# LHTX

Large Hex Union  
37° Flare / 37° Flare

SAE 070119  
HPD Base # 03L3

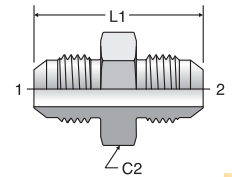

TUBE FITTING PART #	END SIZE		C HEX (in.)	L1 (in.)	Dynamic Pressure (x 1,000 PSI)		
	1 (in.)	2 (in.)			-S	-SS	-B
	2 HTX	1/8			1/8	7/16	1.17
3 HTX	3/16	3/16	7/16	1.23	7.5	9.0	3.3
4 HTX	1/4	1/4	1/2	1.37	7.5	9.0	3.3
4-2 HTX	1/4	1/8	1/2	1.27	7.5	9.0	3.3
4-3 HTX	1/4	3/16	1/2	1.30	7.5	9.0	3.3
5 HTX	5/16	5/16	9/16	1.37	6.0	7.2	3.3
5-4 HTX	5/16	1/4	9/16	1.38	6.0	7.2	3.3
6 HTX	3/8	3/8	5/8	1.41	6.0	7.2	3.3
6-4 HTX	3/8	1/4	5/8	1.41	6.0	7.2	3.3
6-5 HTX	3/8	5/16	5/8	1.41	6.0	7.2	3.3
8 HTX	1/2	1/2	13/16	1.62	6.0	7.2	3.3
8-4 HTX	1/2	1/4	13/16	1.52	6.0	7.2	3.3
8-6 HTX	1/2	3/8	13/16	1.52	6.0	7.2	3.3
10 HTX	5/8	5/8	15/16	1.88	5.0	6.0	3.3
10-8 HTX	5/8	1/2	15/16	1.78	5.0	6.0	3.3
12 HTX	3/4	3/4	1 1/8	2.16	5.0	6.0	3.3
12-8 HTX	3/4	1/2	1 1/8	1.95	5.0	6.0	3.3
12-10 HTX	3/4	5/8	1 1/8	2.05	5.0	6.0	3.3
14 HTX	7/8	7/8	1 1/4	2.22	5.0	6.0	2.6
16 HTX	1	1	1 3/8	2.25	4.5	5.4	2.9
16-12 HTX	1	3/4	1 3/8	2.20	4.5	5.4	2.9
20 HTX	1 1/4	1 1/4	1 11/16	2.43	4.0	4.8	2.6
24 HTX	1 1/2	1 1/2	2	2.75	3.0	3.6	2.0
24-10 HTX	1 1/2	5/8	2	2.42	3.0	3.6	2.0
24-12 HTX	1 1/2	3/4	2	2.53	3.0	3.6	2.0
24-16 HTX	1 1/2	1	2	2.58	3.0	3.6	2.0
32 HTX	2	2	2 5/8	3.40	2.0	2.4	1.3
32-24 HTX	2	1 1/2	2 5/8	2.81	2.0	2.4	1.3

TUBE FITTING PART #	END SIZE		C2 HEX (in.)	L1 (in.)	Dynamic Pressure (x 1,000 PSI)		
	1 (in.)	2 (in.)			-S	-SS	-B
	4 LHTX	1/4			1/4	11/16	1.38
4-3 LHTX	1/4	3/16	11/16	1.30	7.5	9.0	3.3
5 LHTX	5/16	5/16	3/4	1.37	6.0	7.2	3.3
6 LHTX	3/8	3/8	13/16	1.41	6.0	7.2	3.3
6-4 LHTX	3/8	1/4	13/16	1.41	6.0	7.2	3.3
8 LHTX	1/2	1/2	1	1.62	6.0	7.2	3.3
8-4 LHTX	1/2	1/4	1	1.52	6.0	7.2	3.3
8-6 LHTX	1/2	3/8	1	1.52	6.0	7.2	3.3
10 LHTX	5/8	5/8	1 1/8	1.88	5.0	6.0	3.3
12 LHTX	3/4	3/4	1 3/8	2.16	5.0	6.0	3.3
12-8 LHTX	3/4	1/2	1 3/8	1.95	5.0	6.0	3.3
16 LHTX	1	1	1 5/8	2.25	4.5	5.4	2.9
32 LHTX	2	2	2 3/4	3.40	2.0	2.4	1.3

**WARNING:** This product can expose you to chemicals including Lead and Lead Compounds which is known to the State of California to cause cancer and birth defects or other reproductive harm. For more information go to [www.p65warnings.ca.gov](http://www.p65warnings.ca.gov).

**WARNING:** This product can expose you to chemicals including Lead and Lead Compounds which is known to the State of California to cause cancer and birth defects or other reproductive harm. For more information go to [www.p65warnings.ca.gov](http://www.p65warnings.ca.gov).

B

TABLE OF CONTENTS

VISUAL INDEX

FAQs

ASSEMBLY

TUBE FAB EQUIP

GEN TECH

Click here for CADs, Support Resources or to Configure Parts Online

## WTX

Bulkhead Union  
37° Flare / 37° Flare

SAE 070601  
HPD Base # 0355  
WTX-WLN – Body with locknut  
(See page B10 for WLN)

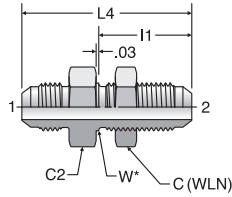

W\* – Bulkhead pilot dia.  
recommended clearance hole  
+.015 over W dia.

## WF5OX

SAE-ORB Bulkhead Connector  
37° Flare / SAE-ORB

HPD Base # 0355  
WF5OX-WLN – Body with locknut  
(See page B10 for WLN)

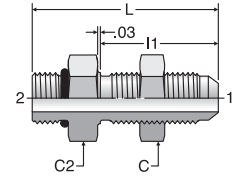

TABLE OF CONTENTS

TUBE FITTING PART #	END SIZE		C HEX (in.)	C2 HEX (in.)	I1 (in.)	L4 (in.)	W DIA (in.)	MAX BULKHEAD WALL THICKNESS (in.)	Dynamic Pressure (x 1,000 PSI)		
	1 & 2 (in.)	2 (in.)							-S	-SS	-B
3 WTX	3/16	5/8	5/8	1.11	1.90	0.38	0.38	7.5	9.0	3.3	
4 WTX	1/4	11/16	11/16	1.20	2.07	0.44	0.38	7.5	9.0	3.3	
5 WTX	5/16	3/4	3/4	1.20	2.07	0.50	0.38	6.0	7.2	3.3	
6 WTX	3/8	13/16	13/16	1.28	2.18	0.56	0.44	6.0	7.2	3.3	
8 WTX	1/2	1	1	1.44	2.44	0.75	0.44	6.0	7.2	3.3	
10 WTX	5/8	1 1/8	1 1/8	1.58	2.74	0.88	0.44	5.0	6.0	3.3	
12 WTX	3/4	1 3/8	1 3/8	1.75	3.09	1.06	0.44	5.0	6.0	3.3	
14 WTX	7/8	1 1/2	1 1/2	1.75	3.12	1.19	0.44	5.0	6.0	3.3	
16 WTX	1	1 5/8	1 5/8	1.75	3.14	1.31	0.44	4.5	5.4	2.9	
20 WTX	1 1/4	1 7/8	1 7/8	1.80	3.31	1.63	0.44	4.0	4.8	2.6	
24 WTX	1 1/2	2 1/8	2 1/8	1.81	3.52	1.88	0.31	3.0	3.6	2.0	
32 WTX	2	2 3/4	2 3/4	2.09	4.20	2.50	0.35	2.0	2.4	1.3	

TUBE FITTING PART #	END SIZE		C HEX (in.)	C2 HEX (in.)	I1 (in.)	L (in.)	MAX BULKHEAD WALL THICKNESS (in.)	Dynamic Pressure (x 1,000 PSI)		
	1 (in.)	2 UN/UNF-2A						-S	-SS	-B
4 WF5OX	1/4	7/16 - 20	11/16	11/16	1.20	1.84	0.38	7.5	9.0	3.3
6 WF5OX	3/8	9/16 - 18	13/16	13/16	1.28	2.02	0.44	6.0	7.2	3.3
8 WF5OX	1/2	3/4 - 16	1	1	1.44	2.19	0.44	6.0	7.2	3.3
10 WF5OX	5/8	7/8 - 14	1 1/8	1 1/8	1.58	2.47	0.44	5.0	6.0	3.3
12 WF5OX	3/4	1 1/16 - 12	1 3/8	1 3/8	1.75	2.79	0.44	5.0	6.0	3.3
16 WF5OX	1	1 5/16 - 12	1 5/8	1 5/8	1.75	2.90	0.44	4.5	5.4	2.9

VISUAL INDEX

FAQs

**WARNING:** This product can expose you to chemicals including Lead and Lead Compounds which is known to the State of California to cause cancer and birth defects or other reproductive harm. For more information go to [www.p65warnings.ca.gov](http://www.p65warnings.ca.gov).

**WARNING:** This product can expose you to chemicals including Lead and Lead Compounds which is known to the State of California to cause cancer and birth defects or other reproductive harm. For more information go to [www.p65warnings.ca.gov](http://www.p65warnings.ca.gov).

ASSEMBLY

TUBE FAB EQUIP

GEN TECH

## WFTX

Male Bulkhead Connector  
37° Flare / NPTF

HPD Base # 0153  
WFTX-WLN – Body with locknut  
(See page B10 for WLN)

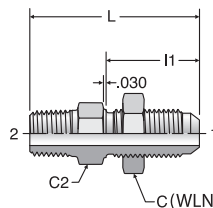

TUBE FITTING PART #	END SIZE		C HEX (in.)	C2 HEX (in.)	I1 (in.)	L (in.)	MAX BULKHEAD WALL THICKNESS (in.)	Dynamic Pressure (x 1,000 PSI)		
	1 (in.)	2 NPTF						-S	-SS	-B
4 WFTX	1/4	1/8 - 27	11/16	11/16	1.20	1.88	0.38	6.0	6.0	3.3
4-4 WFTX	1/4	1/4 - 18	11/16	11/16	1.20	2.10	0.38	6.0	6.0	3.3
6 WFTX	3/8	1/4 - 18	13/16	13/16	1.28	2.18	0.44	6.0	6.0	3.3
6-6 WFTX	3/8	3/8 - 18	13/16	13/16	1.28	2.16	0.44	6.0	6.0	3.3
6-8 WFTX	3/8	1/2 - 14	7/8	13/16	1.28	2.41	0.44	6.0	6.0	3.3
8 WFTX	1/2	3/8 - 18	1	1	1.44	2.34	0.44	6.0	6.0	3.3
8-8 WFTX	1/2	1/2 - 14	1	1	1.44	2.60	0.44	6.0	6.0	3.3
10 WFTX	5/8	1/2 - 14	1 1/8	1 1/8	1.58	2.74	0.44	5.0	5.0	3.3
12 WFTX	3/4	3/4 - 14	1 3/8	1 3/8	1.75	2.95	0.44	5.0	5.0	2.6
16 WFTX	1	1 - 11 1/2	1 5/8	1 5/8	1.75	3.14	0.44	4.5	4.5	2.0

**WARNING:** This product can expose you to chemicals including Lead and Lead Compounds which is known to the State of California to cause cancer and birth defects or other reproductive harm. For more information go to [www.p65warnings.ca.gov](http://www.p65warnings.ca.gov).

[Click here for CADs, Support Resources or to Configure Parts Online](#)

# WGTX

Female Bulkhead Connector  
37° Flare / NPTF

HPD Base # 0253  
WGTX-WLN – Body with locknut  
(See page B10 for WLN)

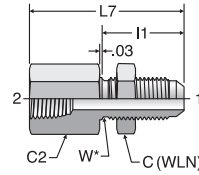

W\* – Bulkhead pilot dia.  
recommended clearance hole  
+.015 over W dia.

TUBE FITTING PART #	END SIZE		C HEX (in.)	C2 HEX (in.)	I1 (in.)	L7 (in.)	W DIA (in.)	MAX BULKHEAD WALL THICKNESS (in.)	Dynamic Pressure (x 1,000 PSI)		
	1 (in.)	2 NPTF							-S	-SS	-B
4 WGTX	1/4	1/8 - 27	11/16	11/16	1.20	1.84	0.44	0.38	6.0	6.0	3.3
4-4 WGTX	1/4	1/4 - 18	11/16	3/4	1.20	2.11	0.44	0.38	6.0	6.0	3.3
6 WGTX	3/8	1/4 - 18	13/16	13/16	1.28	2.12	0.56	0.44	6.0	6.0	3.3
6-6 WGTX	3/8	3/8 - 18	13/16	7/8	1.28	2.24	0.56	0.44	6.0	6.0	3.3
8 WGTX	1/2	3/8 - 18	1	1	1.44	2.34	0.75	0.44	6.0	6.0	3.3
8-8 WGTX	1/2	1/2 - 14	1	1 1/8	1.44	2.61	0.75	0.44	5.0	5.0	3.3
10 WGTX	5/8	1/2 - 14	1 1/8	1 1/8	1.58	2.71	0.88	0.44	5.0	5.0	3.3
12 WGTX	3/4	3/4 - 14	1 3/8	1 3/8	1.75	2.95	1.06	0.44	4.0	4.0	2.6
14 WGTX	7/8	3/4 - 14	1 3/8	1 1/2	1.75	2.92	1.19	0.41	4.0	4.0	2.6
16 WGTX	1	1 - 11 1/2	1 5/8	1 5/8	1.75	3.19	1.31	0.44	3.0	3.0	2.0
24 WGTX	1 1/2	1 1/2-11 1/2	2 1/8	2 1/4	1.81	3.35	1.88	0.31	2.0	2.0	1.3

**WARNING:** This product can expose you to chemicals including Lead and Lead Compounds which is known to the State of California to cause cancer and birth defects or other reproductive harm. For more information go to [www.p65warnings.ca.gov](http://www.p65warnings.ca.gov).

# XHX6

Extender and Expander  
37° Flare / 37° Flare Swivel  
SAE 070121

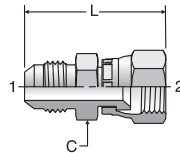

TUBE FITTING PART #	END SIZE		C HEX (in.)	L (in.)	Dynamic Pressure (x 1,000 PSI)		
	1 (in.)	2 (in.)			-S	-SS	-B
4 XHX6	1/4	1/4	9/16	1.39	7.5	7.7	3.3
6 XHX6	3/8	3/8	5/8	1.50	6.0	6.0	3.3
6-4 XHX6	3/8	1/4	5/8	1.50	6.0	6.0	3.3
8 XHX6	1/2	1/2	13/16	1.71	6.0	6.0	3.3
8-6 XHX6	1/2	3/8	13/16	1.72	6.0	6.0	3.3
10 XHX6	5/8	5/8	1	2.01	5.0	5.0	3.3
10-8 XHX6	5/8	1/2	15/16	1.93	5.0	5.0	3.3
12 XHX6	3/4	3/4	1 1/4	2.20	5.0	5.0	3.3
12-10 XHX6	3/4	5/8	1 1/8	2.19	5.0	5.0	3.3
16 XHX6	1	1	1 1/2	2.47	4.0	3.0	2.6
16-12 XHX6	1	3/4	1 1/2	2.24	4.0	3.0	2.6
20-16 XHX6	1 1/4	1	1 11/16	2.50	4.0	3.0	2.6

**WARNING:** This product can expose you to chemicals including Lead and Lead Compounds which is known to the State of California to cause cancer and birth defects or other reproductive harm. For more information go to [www.p65warnings.ca.gov](http://www.p65warnings.ca.gov).

B

TABLE OF CONTENTS

VISUAL INDEX

FAQs

ASSEMBLY

TUBE FAB EQUIP

GEN TECH



[Click here for CADs, Support Resources or to Configure Parts Online](#)

# TRTX / TRTXN

Reducer  
37° Flare

SAE 070123 / SAE 070123A / SAE 070105  
HPD Base # 0603 (TRTXN only)

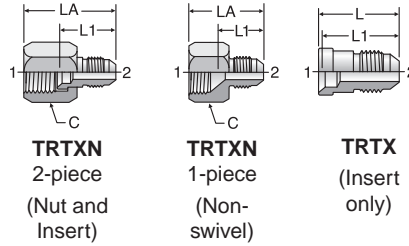

**TRTXN**  
2-piece  
(Nut and  
Insert)

**TRTXN**  
1-piece  
(Non-  
swivel)

**TRTX**  
(Insert  
only)

TUBE FITTING PART #			END SIZE		C HEX (in.)	L (TRTX) (in.)	LA (TRTXN) (in.)	L1 (TRTX & TRTXN) (in.)	Dynamic Pressure (x 1,000 PSI)		
TRTXN 2-pc. Design (with Large Nut)	TRTXN 1-pc. Design (Machined Female)	TRTX Reducer Insert (For 2-pc. Design Only)	1 (in.)	2 (in.)					-S	-SS	-B
4-2 TRTXN	-	4-2 TRTX	1/4	1/8	9/16	0.75	1.14	0.68	7.5	9.0	3.3
-	4-3 TRTXN	-	1/4	3/16	9/16	-	1.09	0.64	7.5	9.0	3.3
-	5-4 TRTXN	-	5/16	1/4	5/8	-	1.16	0.69	6.0	7.2	3.3
6-4 TRTXN	-	6-4 TRTX	3/8	1/4	11/16	0.97	1.40	0.90	6.0	7.2	3.3
-	6-5 TRTXN	-	3/8	5/16	11/16	-	1.19	0.73	6.0	7.2	3.3
8-4 TRTXN	-	8-4 TRTX	1/2	1/4	7/8	1.00	1.50	0.90	6.0	7.2	3.3
8-6 TRTXN	-	8-6 TRTX	1/2	3/8	7/8	1.00	1.50	0.90	6.0	7.2	3.3
10-4 TRTXN	-	10-4 TRTX	5/8	1/4	1	1.03	1.61	0.93	5.0	6.0	3.3
10-6 TRTXN	-	10-6 TRTX	5/8	3/8	1	1.03	1.61	0.93	5.0	6.0	3.3
-	10-8 TRTXN	-	5/8	1/2	1	-	1.48	0.85	5.0	6.0	3.3
12-4 TRTXN	-	12-4 TRTX	3/4	1/4	1 1/4	1.09	1.69	0.95	5.0	6.0	3.3
12-6 TRTXN	-	12-6 TRTX	3/4	3/8	1 1/4	1.09	1.69	0.95	5.0	6.0	3.3
12-8 TRTXN	-	12-8 TRTX	3/4	1/2	1 1/4	1.19	1.79	1.05	5.0	6.0	3.3
-	12-10 TRTXN	-	3/4	5/8	1 1/4	-	1.66	0.96	5.0	6.0	3.3
14-6 TRTXN	-	14-6 TRTX	7/8	3/8	1 3/8	1.13	1.78	1.00	5.0	6.0	3.3
14-10 TRTXN	-	14-10 TRTX	7/8	5/8	1 3/8	1.33	1.98	1.20	5.0	6.0	3.3
-	14-12 TRTXN	-	7/8	3/4	1 3/8	-	1.84	1.11	5.0	6.0	3.3
16-4 TRTXN	-	16-4 TRTX	1	1/4	1 1/2	1.22	1.90	1.09	4.5	5.4	2.9
16-6 TRTXN	-	16-6 TRTX	1	3/8	1 1/2	1.22	1.90	1.09	4.5	5.4	2.9
16-8 TRTXN	-	16-8 TRTX	1	1/2	1 1/2	1.27	1.95	1.14	4.5	5.4	2.9
16-10 TRTXN	-	16-10 TRTX	1	5/8	1 1/2	1.38	2.06	1.25	4.5	5.4	2.9
16-12 TRTXN	-	16-12 TRTX	1	3/4	1 1/2	1.47	2.15	1.34	4.5	5.4	2.9
-	16-14 TRTXN	-	1	7/8	1 1/2	-	1.91	1.15	4.5	5.4	2.9
-	-	20-8 TRTX	1 1/4	1/2	-	1.41	-	1.25	4.0	4.8	2.6
20-12 TRTXN	-	20-12 TRTX	1 1/4	3/4	2	1.53	2.17	1.37	4.0	4.8	2.6
20-16 TRTXN	-	20-16 TRTX	1 1/4	1	2	1.59	2.23	1.43	4.0	4.8	2.6
-	-	24-4 TRTX	1 1/2	1/4	-	1.47	-	1.32	3.0	3.6	2.0
24-8 TRTXN	-	24-8 TRTX	1 1/2	1/2	2 1/4	1.56	2.33	1.41	3.0	3.6	2.0
24-12 TRTXN	-	24-12 TRTX	1 1/2	3/4	2 1/4	1.63	2.40	1.48	3.0	3.6	2.0
24-16 TRTXN	-	24-16 TRTX	1 1/2	1	2 1/4	1.59	2.40	1.48	3.0	3.6	2.0
24-20 TRTXN	-	24-20 TRTX	1 1/2	1 1/4	2 1/4	1.69	2.46	1.54	3.0	3.6	2.0
-	-	32-12 TRTX	2	3/4	-	2.00	-	1.81	2.0	2.4	1.3
-	-	32-20 TRTX	2	1 1/4	-	1.78	-	1.59	2.0	2.4	1.3
32-24 TRTXN	-	32-24 TRTX	2	1 1/2	2 7/8	1.91	2.97	1.71	2.0	2.4	1.3

**WARNING:** This product can expose you to chemicals including Lead and Lead Compounds which is known to the State of California to cause cancer and birth defects or other reproductive harm. For more information go to [www.p65warnings.ca.gov](http://www.p65warnings.ca.gov).

- TABLE OF CONTENTS
- VISUAL INDEX
- FAQs
- ASSEMBLY
- TUBE FAB EQUIP
- GEN TECH

Click here for CADs, Support Resources or to Configure Parts Online

## F50X

Straight Thread Connector  
37° Flare / SAE-ORB

SAE 070120  
HPD Base # 0503

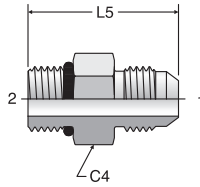

## FF50X

Long Straight Thread Connector  
37° Flare / SAE-ORB

SAE 071720  
HPD Base # 053E

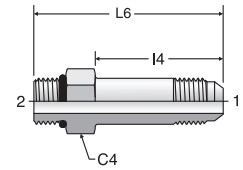

TUBE FITTING PART #	END SIZE		C4 HEX (in.)	L5 (in.)	Dynamic Pressure (x 1,000 PSI)		
	1 (in.)	2 UN/UNF-2A			-S	-SS	-B
2 F50X	1/8	5/16 - 24	7/16	1.06	7.5	9.0	3.3
3 F50X	3/16	3/8 - 24	1/2	1.10	7.5	9.0	3.3
3-2 F50X	3/16	5/16 - 24	1/2	1.10	7.5	9.0	3.3
4 F50X	1/4	7/16 - 20	9/16	1.23	7.5	9.0	3.3
4-2 F50X	1/4	5/16 - 24	9/16	1.17	7.5	9.0	3.3
4-3 F50X	1/4	3/8 - 24	9/16	1.19	7.5	9.0	3.3
4-5 F50X	1/4	1/2 - 20	5/8	1.23	6.0	7.2	3.3
4-6 F50X	1/4	9/16 - 18	11/16	1.29	6.0	7.2	3.3
4-8 F50X	1/4	3/4 - 16	7/8	1.38	6.0	7.2	3.3
4-10 F50X	1/4	7/8 - 14	1	1.49	5.0	6.0	3.3
5 F50X	5/16	1/2 - 20	5/8	1.23	6.0	7.2	3.3
5-4 F50X	5/16	7/16 - 20	9/16	1.23	6.0	7.2	3.3
5-6 F50X	5/16	9/16 - 18	11/16	1.30	6.0	7.2	3.3
5-8 F50X	5/16	3/4 - 16	7/8	1.37	6.0	7.2	3.3
6 F50X	3/8	9/16 - 18	11/16	1.30	6.0	7.2	3.3
6-4 F50X	3/8	7/16 - 20	5/8	1.27	6.0	7.2	3.3
6-5 F50X	3/8	1/2 - 20	5/8	1.27	6.0	7.2	3.3
6-8 F50X	3/8	3/4 - 16	7/8	1.38	6.0	7.2	3.3
6-10 F50X	3/8	7/8 - 14	1	1.50	5.0	6.0	3.3
6-12 F50X	3/8	1 1/16 - 12	1 1/4	1.66	5.0	6.0	3.3
8 F50X	1/2	3/4 - 16	7/8	1.48	6.0	7.2	3.3
8-4 F50X	1/2	7/16 - 20	13/16	1.50	6.0	7.2	3.3
8-6 F50X	1/2	9/16 - 18	13/16	1.44	6.0	7.2	3.3
8-10 F50X	1/2	7/8 - 14	1.00	1.60	5.0	6.0	3.3
8-12 F50X	1/2	1 1/16 - 12	1 1/4	1.76	5.0	6.0	3.3
8-16 F50X	1/2	1 5/16 - 12	1 1/2	1.78	4.5	5.4	2.9
10 F50X	5/8	7/8 - 14	1	1.70	5.0	6.0	3.3
10-6 F50X	5/8	9/16 - 18	15/16	1.71	5.0	6.0	3.3
10-8 F50X	5/8	3/4 - 16	15/16	1.64	5.0	6.0	3.3
10-12 F50X	5/8	1 1/16 - 12	1 1/4	1.86	5.0	6.0	3.3
10-16 F50X	5/8	1 5/16 - 12	1 1/2	1.89	4.5	5.4	2.9
12 F50X	3/4	1 1/16 - 12	1 1/4	1.97	5.0	6.0	3.3
12-8 F50X	3/4	3/4 - 16	1 1/8	1.94	5.0	6.0	3.3
12-10 F50X	3/4	7/8 - 14	1 1/8	1.88	5.0	6.0	3.3
12-14 F50X	3/4	1 3/16 - 12	1 3/8	1.96	5.0	6.0	3.3
12-16 F50X	3/4	1 5/16 - 12	1 1/2	1.99	4.5	5.4	2.9
12-20 F50X	3/4	1 5/8 - 12	1 7/8	2.08	4.0	4.8	2.6
14 F50X	7/8	1 3/16 - 12	1 3/8	1.99	5.0	6.0	3.3
14-16 F50X	7/8	1 5/16 - 12	1 1/2	2.02	4.5	5.4	2.9
16 F50X	1	1 5/16 - 12	1 1/2	2.04	4.5	5.4	2.9
16-8 F50X	1	3/4 - 16	1 3/8	1.78	4.5	5.4	2.9
16-10 F50X	1	7/8 - 14	1 3/8	2.08	4.5	5.4	2.9
16-12 F50X	1	1 1/16 - 12	1 3/8	1.99	4.5	5.4	2.9
16-14 F50X	1	1 3/16 - 12	1 3/8	2.05	4.5	5.4	2.9
16-20 F50X	1	1 5/8 - 12	1 7/8	2.12	4.0	4.8	2.6
16-24 F50X	1	1 7/8 - 12	2 1/8	2.20	3.0	3.6	2.0
20 F50X	1 1/4	1 5/8 - 12	1 7/8	2.17	4.0	4.8	2.6
20-12 F50X	1 1/4	1 1/16 - 12	1 11/16	2.30	4.0	4.8	2.6
20-16 F50X	1 1/4	1 5/16 - 12	1 11/16	2.33	4.0	4.8	2.6
20-24 F50X	1 1/4	1 7/8 - 12	2 1/8	2.24	3.0	3.6	2.0
24 F50X	1 1/2	1 7/8 - 12	2 1/8	2.38	3.0	3.6	2.0
24-20 F50X	1 1/2	1 5/8 - 12	2	2.53	3.0	3.6	2.0
24-32 F50X	1 1/2	2 1/2 - 12	2 3/4	2.53	2.0	2.4	1.3
32 F50X	2	2 1/2 - 12	2 3/4	2.78	2.0	2.4	1.3
32-24 F50X	2	1 7/8 - 12	2 5/8	2.94	2.0	2.4	1.3

**WARNING:** This product can expose you to chemicals including Lead and Lead Compounds which is known to the State of California to cause cancer and birth defects or other reproductive harm. For more information go to [www.p65warnings.ca.gov](http://www.p65warnings.ca.gov).

TUBE FITTING PART #	END SIZE		C4 HEX (in.)	I4 (in.)	L6 (in.)	Dynamic Pressure (x 1,000 PSI)		
	1 (in.)	2 UN/UNF-2A				-S	-SS	-B
4 FF50X	1/4	7/16 - 20	9/16	1.39	2.08	7.5	9.0	3.3
4-6 FF50X	1/4	9/16 - 18	11/16	1.38	2.13	6.0	7.2	3.3
6 FF50X	3/8	9/16 - 18	11/16	1.56	2.31	6.0	7.2	3.3
8 FF50X	1/2	3/4 - 16	7/8	1.88	2.70	6.0	7.2	3.3
10 FF50X	5/8	7/8 - 14	1	2.09	3.04	5.0	6.0	3.3
12 FF50X	3/4	1 1/16 - 12	1 1/4	2.50	3.61	5.0	6.0	3.3
16 FF50X	1	1 5/16 - 12	1 1/2	2.84	3.98	4.5	5.4	2.9
20 FF50X	1 1/4	1 5/8 - 12	1 7/8	3.47	4.69	4.0	4.8	2.6

**WARNING:** This product can expose you to chemicals including Lead and Lead Compounds which is known to the State of California to cause cancer and birth defects or other reproductive harm. For more information go to [www.p65warnings.ca.gov](http://www.p65warnings.ca.gov).

## XHB3

Braze Socket  
37° Flare / Inch Tube Braze  
SAE 070172

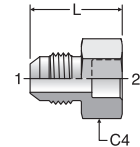

TUBE FITTING PART #	END SIZE		C4 HEX (in.)	L (in.)	Dynamic Pressure (x 1,000 PSI)		
	1 (in.)	2 (in.)			-S	-SS	-B
4 XHB3	1/4	1/4	9/16	0.97	7.5	7.5	3.3
6 XHB3	3/8	3/8	5/8	1.00	6.0	6.0	3.3
6-4 XHB3	3/8	1/4	5/8	1.00	6.0	6.0	3.3
6-8 XHB3	3/8	1/2	5/8	1.00	6.0	6.0	3.3
8 XHB3	1/2	1/2	13/16	1.12	6.0	6.0	3.3
8-10 XHB3	1/2	5/8	13/16	1.12	5.0	5.0	3.3
10 XHB3	5/8	5/8	15/16	1.21	5.0	5.0	3.3
10-8 XHB3	5/8	1/2	15/16	1.21	5.0	5.0	3.3
10-12 XHB3	5/8	3/4	1 1/8	1.37	5.0	5.0	3.3
12 XHB3	3/4	3/4	1 1/4	1.51	5.0	5.0	3.3
12-10 XHB3	3/4	5/8	1 1/8	1.51	5.0	5.0	3.3
12-16 XHB3	3/4	1	1 1/4	1.57	4.0	4.0	2.6
16 XHB3	1	1	1 3/8	1.63	4.0	4.0	2.6
16-20 XHB3	1	1 1/4	1 11/16	1.73	4.0	4.0	2.6
20 XHB3	1 1/4	1 1/4	1 11/16	1.71	4.0	4.0	2.6
20-24 XHB3	1 1/4	1 1/2	2	1.71	3.0	3.0	2.0
24 XHB3	1 1/2	1 1/2	2	1.84	3.0	3.0	2.0
32 XHB3	2	2	2 5/8	2.16	2.0	2.0	1.3

Note: Braze rings are on page B10.

**WARNING:** This product can expose you to chemicals including Lead and Lead Compounds which is known to the State of California to cause cancer and birth defects or other reproductive harm. For more information go to [www.p65warnings.ca.gov](http://www.p65warnings.ca.gov).

**B**

TABLE OF CONTENTS

VISUAL INDEX

FAQs

ASSEMBLY

TUBE FAB EQUIP

GEN TECH

Click here for CADs, Support Resources or to Configure Parts Online

## FTX

Male Connector  
37° Flare / NPTF

SAE 070102  
HPD Base # 0103

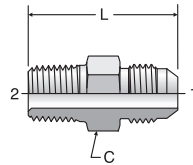

## FFTX

Long Male Connector  
37° Flare / NPTF

SAE 071802  
HPD Base # 013E

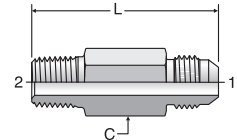

TUBE FITTING PART #	END SIZE		C HEX (in.)	L (in.)	Dynamic Pressure (x 1,000 PSI)		
	1 (in.)	2 NPTF			-S	-SS	-B
3 FTX	3/16	1/8 - 27	7/16	1.14	6.0	6.0	3.3
4 FTX	1/4	1/8 - 27	1/2	1.22	6.0	6.0	3.3
4-4 FTX	1/4	1/4 - 18	9/16	1.42	6.0	6.0	3.3
4-6 FTX	1/4	3/8 - 18	3/4	1.44	6.0	6.0	3.3
4-8 FTX	1/4	1/2 - 14	7/8	1.69	6.0	6.0	3.3
5 FTX	5/16	1/8 - 27	9/16	1.22	6.0	6.0	3.3
5-4 FTX	5/16	1/4 - 18	9/16	1.42	6.0	6.0	3.3
5-6 FTX	5/16	3/8 - 18	3/4	1.44	6.0	6.0	3.3
6 FTX	3/8	1/4 - 18	5/8	1.43	6.0	6.0	3.3
6-2 FTX	3/8	1/8 - 27	5/8	1.24	6.0	6.0	3.3
6-6 FTX	3/8	3/8 - 18	3/4	1.43	6.0	6.0	3.3
6-8 FTX	3/8	1/2 - 14	7/8	1.69	6.0	6.0	3.3
6-12 FTX	3/8	3/4 - 14	1 1/8	1.75	5.5	5.5	3.3
8 FTX	1/2	3/8 - 18	13/16	1.53	6.0	6.0	3.3
8-2 FTX	1/2	1/8 - 27	13/16	1.34	6.0	6.0	3.3
8-4 FTX	1/2	1/4 - 18	13/16	1.53	6.0	6.0	3.3
8-8 FTX	1/2	1/2 - 14	7/8	1.79	6.0	6.0	3.3
8-12 FTX	1/2	3/4 - 14	1 1/8	1.85	5.5	5.5	2.6
8-16 FTX	1/2	1 - 11 1/2	1 3/8	2.05	4.5	4.5	2.0
10 FTX	5/8	1/2 - 14	15/16	1.89	5.0	5.0	3.3
10-6 FTX	5/8	3/8 - 18	15/16	1.70	5.0	5.0	3.3
10-12 FTX	5/8	3/4 - 14	1 1/8	1.95	5.0	5.0	2.6
12 FTX	3/4	3/4 - 14	1 1/8	2.06	5.0	5.0	2.6
12-6 FTX	3/4	3/8 - 18	1 1/8	1.87	5.0	5.0	3.3
12-8 FTX	3/4	1/2 - 14	1 1/8	2.06	5.0	5.0	3.3
12-16 FTX	3/4	1 - 11 1/2	1 3/8	2.25	5.0	5.0	2.0
12-20 FTX	3/4	1 1/4 - 11 1/2	1 11/16	2.36	3.0	3.0	1.6
14 FTX	7/8	3/4 - 14	1 1/4	2.09	5.0	5.0	2.9
16 FTX	1	1 - 11 1/2	1 3/8	2.30	4.5	4.5	2.0
16-8 FTX	1	1/2 - 14	1 3/8	2.11	4.5	4.5	2.9
16-12 FTX	1	3/4 - 14	1 3/8	2.11	4.5	4.5	2.6
16-20 FTX	1	1 1/4 - 11 1/2	1 11/16	2.40	3.0	3.0	1.6
16-24 FTX	1	1 1/2 - 11 1/2	2	2.50	3.0	3.0	1.3
20 FTX	1 1/4	1 1/4 - 11 1/2	1 11/16	2.45	3.0	3.0	1.6
20-16 FTX	1 1/4	1 - 11 1/2	1 11/16	2.42	3.0	3.0	2.0
20-24 FTX	1 1/4	1 1/2 - 11 1/2	2	2.55	3.0	3.0	1.3
24 FTX	1 1/2	1 1/2 - 11 1/2	2	2.68	3.0	3.0	1.3
24-16 FTX	1 1/2	1 - 11 1/2	2	2.62	3.0	3.0	2.0
24-20 FTX	1 1/2	1 1/4 - 11 1/2	2	2.66	3.0	3.0	1.6
24-32 FTX	1 1/2	2 - 11 1/2	2 5/8	2.86	2.0	2.0	1.0
32 FTX	2	2 - 11 1/2	2 5/8	3.11	2.0	2.0	1.0
32-24 FTX	2	1 1/2 - 11 1/2	2 5/8	3.08	2.0	2.0	1.3
40 FTX	2 1/2	2 1/2 - 8	3 1/4	3.38	1.0	1.0	0.5

**WARNING:** This product can expose you to chemicals including Lead and Lead Compounds which is known to the State of California to cause cancer and birth defects or other reproductive harm. For more information go to [www.p65warnings.ca.gov](http://www.p65warnings.ca.gov).

TUBE FITTING PART #	END SIZE		C (in.)	L (in.)	Dynamic Pressure (x 1,000 PSI)		
	1 (in.)	2 NPTF			-S	-SS	-B
4-4 FFTX	1/4	1/4 - 18	9/16	2.25	6.0	6.0	3.3
6 FFTX	3/8	1/4 - 18	5/8	2.25	6.0	6.0	3.3
6-6 FFTX	3/8	3/8 - 18	3/4	2.50	6.0	6.0	3.3
8 FFTX	1/2	3/8 - 18	13/16	2.75	6.0	6.0	3.3
8-8 FFTX	1/2	1/2 - 14	15/16	2.80	6.0	6.0	3.3
10 FFTX	5/8	1/2 - 14	15/16	3.12	5.0	5.0	3.3
12 FFTX	3/4	3/4 - 14	1 1/8	3.50	5.0	5.0	2.6

**WARNING:** This product can expose you to chemicals including Lead and Lead Compounds which is known to the State of California to cause cancer and birth defects or other reproductive harm. For more information go to [www.p65warnings.ca.gov](http://www.p65warnings.ca.gov).

- TABLE OF CONTENTS
- VISUAL INDEX
- FAQs
- ASSEMBLY
- TUBE FAB EQUIP
- GEN TECH

Click here for CADs, Support Resources or to Configure Parts Online

# GTX

Female Connector  
37° Flare / NPTF

SAE 070103  
HPD Base # 0203

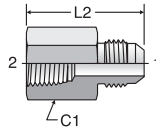

TUBE FITTING PART #	END SIZE		C1 HEX (in.)	L2 (in.)	Dynamic Pressure (x 1,000 PSI)		
	1 (in.)	2 NPTF			-S	-SS	-B
3 GTX	3/16	1/8 - 27	9/16	1.13	6.0	6.0	3.3
4 GTX	1/4	1/8 - 27	9/16	1.19	6.0	6.0	3.3
4-4 GTX	1/4	1/4 - 18	3/4	1.39	6.0	6.0	3.3
4-6 GTX	1/4	3/8 - 18	7/8	1.45	6.0	6.0	3.3
4-8 GTX	1/4	1/2 - 14	1 1/8	1.68	6.0	6.0	3.3
5 GTX	5/16	1/8 - 27	9/16	1.17	6.0	6.0	3.3
5-4 GTX	5/16	1/4 - 18	3/4	1.39	6.0	6.0	3.3
6 GTX	3/8	1/4 - 18	3/4	1.40	6.0	6.0	3.3
6-2 GTX	3/8	1/8 - 27	5/8	1.19	6.0	6.0	3.3
6-6 GTX	3/8	3/8 - 18	7/8	1.46	6.0	6.0	3.3
6-8 GTX	3/8	1/2 - 14	1 1/8	1.69	5.0	5.0	3.3
8 GTX	1/2	3/8 - 18	7/8	1.56	6.0	6.0	3.3
8-4 GTX	1/2	1/4 - 18	13/16	1.55	6.0	6.0	3.3
8-8 GTX	1/2	1/2 - 14	1 1/8	1.79	5.0	5.0	3.3
8-12 GTX	1/2	3/4 - 14	1 3/8	1.85	4.0	4.0	2.6
10 GTX	5/8	1/2 - 14	1 1/8	1.89	5.0	5.0	3.3
10-12 GTX	5/8	3/4 - 14	1 3/8	1.95	4.0	4.0	2.6
12 GTX	3/4	3/4 - 14	1 3/8	2.06	4.0	4.0	2.6
12-8 GTX	3/4	1/2 - 14	1 1/8	2.05	5.0	5.0	2.6
12-16 GTX	3/4	1 - 11 1/2	1 5/8	2.30	3.0	3.0	2.0
14 GTX	7/8	3/4 - 14	1 3/8	2.06	4.0	4.0	2.6
16 GTX	1	1 - 11 1/2	1 5/8	2.35	3.0	3.0	2.0
16-12 GTX	1	3/4 - 14	1 3/8	2.13	4.0	4.0	2.6
16-20 GTX	1	1 1/4 - 11 1/2	2	2.44	2.5	2.5	1.6
20 GTX	1 1/4	1 1/4 - 11 1/2	2	2.49	2.5	2.5	1.6
20-16 GTX	1 1/4	1 - 11 1/2	1 3/4	2.47	3.0	3.0	2.0
24 GTX	1 1/2	1 1/2 - 11 1/2	2 3/8	2.62	2.0	2.0	1.3
32 GTX	2	2 - 11 1/2	2 7/8	2.97	1.5	1.5	1.0

**WARNING:** This product can expose you to chemicals including Lead and Lead Compounds which is known to the State of California to cause cancer and birth defects or other reproductive harm. For more information go to [www.p65warnings.ca.gov](http://www.p65warnings.ca.gov).

# F870MX

Male Connector – ISO 6149  
37° Flare / ISO 6149  
SAE 070187

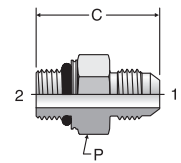

TUBE FITTING PART #	END SIZE		Male Metric Parallel Thread	C (mm)	P (mm)	Dynamic Pressure (x 1,000 PSI)		
	1 (mm)	2 (in.)				S	SS	B
5M12F870MX	8	5/16	M12x1.5	33.1	19	6.0	5.0	3.3
6M14F870MX	10	3/8	M14x1.5	34.1	19	6.0	5.0	3.3
6M16F870MX	10	3/8	M16x1.5	35.5	22	6.0	5.0	3.3
8M16F870MX	12	1/2	M16x1.5	38.0	22	6.0	5.0	3.3
8M18F870MX	12	1/2	M18x1.5	39.1	24	5.0	5.0	3.3
10M18F870MX	14, 15, 16	5/8	M18x1.5	43.1	24	5.0	5.0	3.3
10M22F870MX	14, 15, 16	5/8	M22x1.5	43.5	27	5.0	5.0	3.3
12M22F870MX	18, 20	3/4	M22x1.5	48.0	27	5.0	5.0	3.3
12M27F870MX	18, 20	3/4	M27x2	50.9	32	5.0	5.0	3.3
16M27F870MX	25	1	M27x2	50.5	36	5.0	5.0	3.3
16M33F870MX	25	1	M33x2	52.7	41	4.0	4.0	2.6
20M42F870MX	30, 32	1 1/4	M42x2	55.0	50	4.0	3.0	2.0
24M48F870MX	38	1 1/2	M48x2	59.4	55	3.0	2.0	1.3

**WARNING:** This product can expose you to chemicals including Lead and Lead Compounds which is known to the State of California to cause cancer and birth defects or other reproductive harm. For more information go to [www.p65warnings.ca.gov](http://www.p65warnings.ca.gov).

# F82EDMX

Male Connector – Metric  
37° Flare / Metric-ED

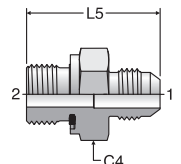

TUBE FITTING PART #	END SIZE		Male Metric Parallel Thread	C4 (mm)	L5 (mm)	Dynamic Pressure (x 1,000 PSI)		
	1 (mm)	2 (in.)				S	SS	B
5M12F82EDMX	8	5/16	M12x1.5	17	34.0	6.0	5.0	3.3
6M14F82EDMX	10	3/8	M14x1.5	19	35.0	6.0	5.0	3.3
6M16F82EDMX	10	3/8	M16x1.5	22	36.0	6.0	5.0	3.3
8M16F82EDMX	12	1/2	M16x1.5	22	38.5	6.0	5.0	3.3
8M18F82EDMX	12	1/2	M18x1.5	24	38.5	5.0	5.0	3.3
10M18F82EDMX	14,15,16	5/8	M18x1.5	24	42.5	5.0	5.0	3.3
10M22F82EDMX	14,15,16	5/8	M22x1.5	27	44.5	5.0	5.0	3.3
12M22F82EDMX	18,20	3/4	M22x1.5	27	49.0	5.0	5.0	3.3
12M27F82EDMX	18,20	3/4	M27x2	32	51.0	5.0	5.0	3.3
16M33F82EDMX	25	1	M33x2	41	54.5	4.0	4.0	2.6
20M42F82EDMX	30,32	1 1/4	M42x2	50	60.0	4.0	3.0	2.0

**WARNING:** This product can expose you to chemicals including Lead and Lead Compounds which is known to the State of California to cause cancer and birth defects or other reproductive harm. For more information go to [www.p65warnings.ca.gov](http://www.p65warnings.ca.gov).

**B**

TABLE OF CONTENTS

VISUAL INDEX

FAQs

ASSEMBLY

TUBE FAB EQUIP

GEN TECH



[Click here for CADs, Support Resources or to Configure Parts Online](#)

## F8OMX

Male Connector – Metric  
37° Flare / Metric-ORR

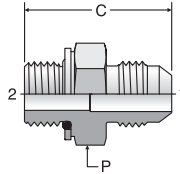

## F42EDMX

Male Connector – BSPP  
37° Flare / BSPP-ED

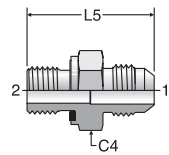

TUBE FITTING PART #	END SIZE		Male Metric Parallel Thread	C (mm)	P (mm)	Dynamic Pressure (x 1,000 PSI)		
	1					2		
	(mm)	(in.)				S	SS	B
4M10F8OMX	6	1/4	M10x1	30.0	14	5.0	5.0	3.3
5M12F8OMX	8	5/16	M12x1.5	33.1	19	6.0	6.0	3.3
6M14F8OMX	10	3/8	M14x1.5	34.1	19	5.0	5.0	3.3
8M16F8OMX	12	1/2	M16x1.5	38.0	22	5.0	5.0	3.3
8M18F8OMX	12	1/2	M18x1.5	39.1	24	3.6	3.6	2.3
10M18F8OMX	14, 15, 16	5/8	M18x1.5	43.1	24	3.6	3.6	2.3
10M22F8OMX	14, 15, 16	5/8	M22x1.5	43.5	27	3.6	3.6	2.3
12M22F8OMX	18, 20	3/4	M22x1.5	48.0	27	3.6	3.6	2.3
12M24F8OMX	18, 20	3/4	M24x1.5	44.5	30	3.0	3.0	2.0
12M27F8OMX	18, 20	3/4	M27x2	50.9	32	3.0	3.0	2.0
16M27F8OMX	25	1	M27x2	50.5	36	3.0	3.0	2.0
16M33F8OMX	25	1	M33x2	52.7	41	3.0	3.0	2.0
20M42F8OMX	30, 32	1 1/4	M42x2	54.9	50	3.0	3.0	2.0
24M48F8OMX	38	1 1/2	M48x2	59.4	55	2.0	2.0	1.3

**Note:** If F8OMX is not available, use F82EDMX.

**WARNING:** This product can expose you to chemicals including Lead and Lead Compounds which is known to the State of California to cause cancer and birth defects or other reproductive harm. For more information go to [www.p65warnings.ca.gov](http://www.p65warnings.ca.gov).

TUBE FITTING PART #	END SIZE			C4 (mm)	L5 (mm)	Dynamic Pressure (x 1,000 PSI)		
	1		2			2		
	(mm)	(in.)	BSPP			S	SS	B
4F42EDMX	6	1/4	1/8 - 28	14	30.2	7.2	5.0	3.3
4-4F42EDMX	6	1/4	1/4 - 19	19	35.0	6.0	5.0	3.3
4-6F42EDMX	6	1/4	3/8 - 19	22	36.0	6.0	5.0	3.3
4-8F42EDMX	6	1/4	1/2 - 14	27	39.5	5.0	5.0	3.3
5F42EDMX	8	5/16	1/8 - 28	14	30.0	6.0	5.0	3.3
5-4F42EDMX	8	5/16	1/4 - 19	19	35.0	6.0	5.0	3.3
5-6F42EDMX	8	5/16	3/8 - 19	22	36.0	6.0	5.0	3.3
6-2F42EDMX	10	3/8	1/8 - 28	17	31.2	6.0	5.0	3.3
6F42EDMX	10	3/8	1/4 - 19	19	35.0	6.0	5.0	3.3
6-6F42EDMX	10	3/8	3/8 - 19	22	36.0	6.0	5.0	3.3
6-8F42EDMX	10	3/8	1/2 - 14	27	39.5	5.0	5.0	3.3
8F42EDMX	12	1/2	3/8 - 19	22	38.6	6.0	5.0	3.3
8-4F42EDMX	12	1/2	1/4 - 19	19	39.0	6.0	5.0	3.3
8-8F42EDMX	12	1/2	1/2 - 14	27	42.0	5.0	5.0	3.3
8-12F42EDMX	12	1/2	3/4 - 14	32	45.7	5.0	5.0	3.3
10F42EDMX	14, 15, 16	5/8	1/2 - 14	27	45.0	5.0	5.0	3.3
10-6F42EDMX	14, 15, 16	5/8	3/8 - 19	24	43.0	5.0	5.0	3.3
10-12F42EDMX	14, 15, 16	5/8	3/4 - 14	32	48.2	5.0	5.0	3.3
12F42EDMX	18, 20	3/4	3/4 - 14	32	51.0	5.0	5.0	3.3
12-6F42EDMX	18, 20	3/4	3/8 - 19	27	50.0	5.0	5.0	3.3
12-8F42EDMX	18, 20	3/4	1/2 - 14	27	49.0	5.0	5.0	3.3
12-16F42EDMX	18, 20	3/4	1 - 11	41	53.5	4.0	4.0	2.6
16F42EDMX	25	1	1 - 11	41	55.0	4.0	4.0	2.6
16-12F42EDMX	25	1	3/4 - 14	36	53.0	4.0	4.0	2.6
16-20F42EDMX	25	1	1 1/4 - 11	50	59.0	4.0	4.0	2.6
20-16F42EDMX	30, 32	1 1/4	1 - 11	46	62.0	4.0	3.0	2.0
20F42EDMX	30, 32	1 1/4	1 1/4 - 11	50	60.0	4.0	3.0	2.0
20-24F42EDMX	30, 32	1 1/4	1 1/2 - 11	55	64.0	3.0	2.0	1.3
24F42EDMX	38	1 1/2	1 1/2 - 11	55	67.0	3.0	2.0	1.3
24-20F42EDMX	38	1 1/2	1 1/4 - 11	50	62.0	3.0	3.0	2.0

**WARNING:** This product can expose you to chemicals including Lead and Lead Compounds which is known to the State of California to cause cancer and birth defects or other reproductive harm. For more information go to [www.p65warnings.ca.gov](http://www.p65warnings.ca.gov).

TABLE OF CONTENTS

VISUAL INDEX

FAQs

ASSEMBLY

TUBE FAB EQUIP

GEN TECH

Click here for CADs, Support Resources or to Configure Parts Online

## F4OMX

Male Connector – BSPP  
37° Flare / BSPP-ORR

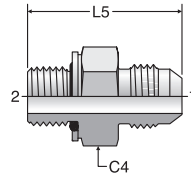

TUBE FITTING PART #	END SIZE			C4 (mm)	L5 (mm)	Dynamic Pressure (x 1,000 PSI)		
	1		2 BSPP			S	SS	B
	(mm)	(in.)						
4F4OMX	6	1/4	1/8 - 28	17	28.3	5.0	5.0	3.3
4-4F4OMX	6	1/4	1/4 - 19	19	32.2	5.0	5.0	3.3
4-6F4OMX	6	1/4	3/8 - 19	22	33.1	5.0	5.0	3.3
4-8F4OMX	6	1/4	1/2 - 14	30	38.6	5.0	5.0	3.3
5-4F4OMX	8	5/16	1/4 - 19	19	32.2	5.0	5.0	3.3
5-6F4OMX	8	5/16	3/8 - 19	22	33.1	5.0	5.0	3.3
6F4OMX	10	3/8	1/4 - 19	19	32.5	5.0	5.0	3.3
6-6F4OMX	10	3/8	3/8 - 19	22	33.4	5.0	5.0	3.3
6-8F4OMX	10	3/8	1/2 - 14	30	38.0	5.0	5.0	3.3
8-4F4OMX	12	1/2	1/4 - 19	19	35.0	5.0	5.0	3.3
8F4OMX	12	1/2	3/8 - 19	22	35.9	5.0	5.0	3.3
8-8F4OMX	12	1/2	1/2 - 14	30	41.4	5.0	5.0	3.3
8-12F4OMX	12	1/2	3/4 - 14	36	42.2	4.0	4.0	2.6
10-6F4OMX	14, 15, 16	5/8	3/8 - 19	24	39.1	5.0	5.0	3.3
10F4OMX	14, 15, 16	5/8	1/2 - 14	30	43.1	5.0	5.0	3.3
12-8F4OMX	18, 20	3/4	1/2 - 14	30	46.7	5.0	5.0	3.3
12F4OMX	18, 20	3/4	3/4 - 14	36	47.5	4.0	3.6	2.3
12-16F4OMX	18, 20	3/4	1 - 11	46	52.6	4.0	3.6	2.3
16-12F4OMX	25	1	3/4 - 14	36	48.5	4.0	3.6	2.3
16F4OMX	25	1	1 - 11	46	53.6	4.0	3.6	2.3
16-20F4OMX	25	1	1 1/4 - 11	50	54.7	3.6	2.5	1.6
20F4OMX	30, 32	1 1/4	1 1/4 - 11	50	56.0	3.6	2.5	1.6
24-20F4OMX	38	1 1/2	1 1/4 - 11	50	60.4	3.0	2.0	1.3
24F4OMX	38	1 1/2	1 1/2 - 11	55	61.1	3.0	2.0	1.3

Note: If F4OMX is not available, use F42EDMX.

**WARNING:** This product can expose you to chemicals including Lead and Lead Compounds which is known to the State of California to cause cancer and birth defects or other reproductive harm. For more information go to [www.p65warnings.ca.gov](http://www.p65warnings.ca.gov).

## G4MX

Female Connector – BSPP  
37° Flare / BSPP

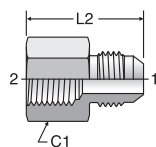

TUBE FITTING PART #	END SIZE			C1 (mm)	L2 (mm)	Dynamic Pressure (x 1,000 PSI)		
	1		2 BSPP			S	SS	B
	(mm)	(in.)						
4G4MX	6	1/4	1/8 - 28	17	30.2	4.5	4.5	2.9
4-4G4MX	6	1/4	1/4 - 19	19	35.3	5.8	5.8	3.3
5G4MX	8	5/16	1/8 - 28	17	29.7	4.5	4.5	2.9
6G4MX	10	3/8	1/4 - 19	19	35.6	5.8	5.8	3.3
6-6G4MX	10	3/8	3/8 - 19	22	37.1	5.0	5.0	3.3
8G4MX	12	1/2	3/8 - 19	22	39.6	5.0	5.0	3.3
8-8G4MX	12	1/2	1/2 - 14	30	45.5	5.0	5.0	3.3
10G4MX	14,15,16	5/8	1/2 - 14	30	48.0	5.0	5.0	3.3
12G4MX	18, 20	3/4	3/4 - 14	36	52.3	4.5	4.5	2.9
16G4MX	25	1	1 - 11	46	59.7	4.0	4.0	2.6

**WARNING:** This product can expose you to chemicals including Lead and Lead Compounds which is known to the State of California to cause cancer and birth defects or other reproductive harm. For more information go to [www.p65warnings.ca.gov](http://www.p65warnings.ca.gov).

## F3MX

Male Connector – BSPT  
37° Flare / BSPT

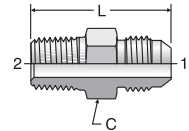

TUBE FITTING PART #	END SIZE			C HEX (mm)	L (mm)	Dynamic Pressure (x 1,000 PSI)		
	1		2 BSPT			S	SS	B
	(mm)	(in.)						
4F3MX	6	1/4	1/8 - 28	13	30.7	4.5	4.5	2.9
4-4F3MX	6	1/4	1/4 - 19	14	35.3	4.5	4.5	2.9
5F3MX	8	5/16	1/8 - 28	14	30.7	4.5	4.5	2.9
5-4F3MX	8	5/16	1/4 - 19	14	35.3	4.5	4.5	2.9
6F3MX	10	3/8	1/4 - 19	17	35.6	4.5	4.5	2.9
6-6F3MX	10	3/8	3/8 - 19	19	36.4	4.5	4.5	2.9
6-8F3MX	10	3/8	1/2 - 14	22	42.9	4.5	4.5	2.9
8-4F3MX	12	1/2	1/4 - 19	19	38.1	4.5	4.5	2.9
8F3MX	12	1/2	3/8 - 19	19	38.9	4.5	4.5	2.9
8-8F3MX	12	1/2	1/2 - 14	22	45.5	4.5	4.5	2.9
10-6F3MX	14, 15, 16	5/8	3/8 - 19	24	43.2	4.5	4.5	2.9
10F3MX	14, 15, 16	5/8	1/2 - 14	24	48.0	4.5	4.5	2.9
10-12F3MX	14, 15, 16	5/8	3/4 - 14	27	48.3	2.3	2.3	1.5
12-8F3MX	18, 20	3/4	1/2 - 14	27	50.8	4.5	4.5	2.9
12F3MX	18, 20	3/4	3/4 - 14	27	50.8	2.3	2.3	1.5
12-16F3MX	18, 20	3/4	1 - 11	36	57.1	2.3	2.3	1.5
16-12F3MX	25	1	3/4 - 14	36	53.6	2.3	2.3	1.5
16F3MX	25	1	1 - 11	36	58.5	2.3	2.3	1.5
20-16F3MX	30, 32	1 1/4	1 - 11	46	61.4	2.3	2.3	1.5
20F3MX	30, 32	1 1/4	1 1/4 - 11	46	62.2	2.3	2.3	1.5
24F3MX	38	1 1/2	1 1/2 - 11	50	68.1	2.3	2.0	1.3

**WARNING:** This product can expose you to chemicals including Lead and Lead Compounds which is known to the State of California to cause cancer and birth defects or other reproductive harm. For more information go to [www.p65warnings.ca.gov](http://www.p65warnings.ca.gov).

## HX6

Swivel Nut Union  
37° Swivel / 37° Swivel  
SAE 070108

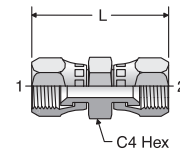

HPD Base # 0606

TUBE FITTING PART #	END SIZE		C4 HEX (in.)	L (in.)	Dynamic Pressure (x 1,000 PSI)		
	1 & 2 (in.)				-S	-SS	-B
4 HX6	1/4	9/16	1.48	7.5	7.7	3.3	
6 HX6	3/8	11/16	1.75	6.0	6.0	3.3	
8 HX6	1/2	7/8	2.02	6.0	6.0	3.3	
10 HX6	5/8	1	2.24	5.0	5.0	3.3	
12 HX6	3/4	1 1/4	2.31	5.0	5.0	3.3	
16 HX6	1	1 1/2	2.75	4.0	3.0	2.6	

**WARNING:** This product can expose you to chemicals including Lead and Lead Compounds which is known to the State of California to cause cancer and birth defects or other reproductive harm. For more information go to [www.p65warnings.ca.gov](http://www.p65warnings.ca.gov).

**B**

TABLE OF CONTENTS

VISUAL INDEX

FAQs

ASSEMBLY

TUBE FAB EQUIP

GEN TECH

Click here for CADs, Support Resources or to Configure Parts Online

## F650X

Swivel Straight Thread Connector  
37° Swivel / SAE-ORB

HPD Base # 0506

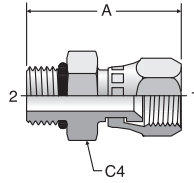

TUBE FITTING PART #	END SIZE		A (in.)	C4 HEX (in.)	Dynamic Pressure (x 1,000 PSI)		
	1 (in.)	2 UN/UNF-2A			-S	-SS	-B
	4 F650X	1/4					
4-6 F650X	1/4	9/16 - 18	1.33	11/16	6.0	7.2	3.3
5 F650X	5/16	1/2 - 20	1.39	5/8	6.0	7.2	3.3
6 F650X	3/8	9/16 - 18	1.43	11/16	6.0	7.2	3.3
6-4 F650X	3/8	7/16 - 20	1.37	9/16	6.0	7.2	3.3
6-8 F650X	3/8	3/4 - 16	1.50	7/8	6.0	7.2	3.3
8 F650X	1/2	3/4 - 16	1.61	7/8	6.0	7.2	3.3
8-6 F650X	1/2	9/16 - 18	1.54	13/16	6.0	7.2	3.3
8-10 F650X	1/2	7/8 - 14	1.78	1	5.0	6.0	3.3
10 F650X	5/8	7/8 - 14	1.81	1	5.0	6.0	3.3
10-8 F650X	5/8	3/4 - 16	1.75	1	5.0	6.0	3.3
10-12 F650X	5/8	1 1/16 - 12	1.85	1 1/4	5.0	6.0	3.3
12 F650X	3/4	1 1/16 - 12	2.07	1 1/4	5.0	6.0	3.3
12-10 F650X	3/4	7/8 - 14	2.10	1 1/4	5.0	6.0	3.3
12-16 F650X	3/4	1 5/16 - 12	2.04	1 1/2	4.5	4.5	2.9
16 F650X	1	1 5/16 - 12	2.14	1 1/2	4.0	4.0	2.6
16-12 F650X	1	1 1/16 - 12	2.14	1 1/2	4.0	4.0	2.6
20 F650X	1 1/4	1 5/8 - 12	2.55	2	4.0	4.0	2.6

**WARNING:** This product can expose you to chemicals including Lead and Lead Compounds which is known to the State of California to cause cancer and birth defects or other reproductive harm. For more information go to [www.p65warnings.ca.gov](http://www.p65warnings.ca.gov).

## G6X

Swivel Nut Female Connector  
37° Swivel / NPTF

HPD Base # 0206

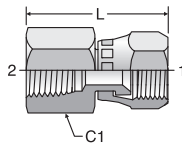

TUBE FITTING PART #	END SIZE		C1 (in.)	L (in.)	Dynamic Pressure (x 1,000 PSI)		
	1 (in.)	2 NPTF			-S	-SS	-B
	4 G6X	1/4					
4-4 G6X	1/4	1/4 - 18	3/4	1.43	6.0	6.0	3.3
6 G6X	3/8	1/4 - 18	3/4	1.44	5.0	5.0	3.3
6-6 G6X	3/8	3/8 - 18	7/8	1.54	5.0	5.0	3.3
6-8 G6X	3/8	1/2 - 14	1 1/8	1.80	5.0	5.0	3.3
8 G6X	1/2	3/8 - 18	7/8	1.69	5.0	5.0	3.3
8-8 G6X	1/2	1/2 - 14	1 1/8	1.94	5.0	5.0	3.3
10 G6X	5/8	1/2 - 14	1 1/8	1.98	5.0	5.0	3.3
12 G6X	3/4	3/4 - 14	1 3/8	2.01	4.0	4.0	2.6
12-8 G6X	3/4	1/2 - 14	1 1/4	2.00	5.0	5.0	3.3
16 G6X	1	1 - 11 1/2	1 5/8	2.48	3.0	3.0	2.0
20 G6X	1 1/4	1 1/4 - 11 1/2	2	2.86	2.5	2.5	1.6
24 G6X	1 1/2	1 1/2 - 11 1/2	2 3/8	3.01	2.0	2.0	1.3
32 G6X	2	2 - 11 1/2	2 7/8	3.40	1.5	1.5	1.0

**WARNING:** This product can expose you to chemicals including Lead and Lead Compounds which is known to the State of California to cause cancer and birth defects or other reproductive harm. For more information go to [www.p65warnings.ca.gov](http://www.p65warnings.ca.gov).

## F6X

Swivel Connector  
37° Swivel / NPTF  
SAE 070106

HPD Base # 0106

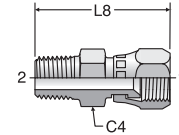

TUBE FITTING PART #	END SIZE		C4 (in.)	L8 (in.)	Dynamic Pressure (x 1,000 PSI)		
	1 (in.)	2 NPTF			-S	-SS	-B
	4 F6X	1/4					
4-4 F6X	1/4	1/4 - 18	9/16	1.54	6.0	6.0	3.3
5-4 F6X	5/16	1/4 - 18	5/8	1.60	6.0	6.0	3.3
6 F6X	3/8	1/4 - 18	11/16	1.66	5.0	5.0	3.3
6-6 F6X	3/8	3/8 - 18	3/4	1.69	5.0	5.0	3.3
8 F6X	1/2	3/8 - 18	7/8	1.74	5.0	5.0	3.3
8-8 F6X	1/2	1/2 - 14	7/8	1.97	5.0	5.0	3.3
10 F6X	5/8	1/2 - 14	1	2.05	5.0	5.0	3.3
10-6 F6X	5/8	3/8 - 18	1	1.84	5.0	5.0	3.3
12 F6X	3/4	3/4 - 14	1 1/4	2.15	5.0	5.0	3.3
12-8 F6X	3/4	1/2 - 14	1 1/4	2.15	5.0	5.0	3.3
16 F6X	1	1 - 11 1/2	1 1/2	2.50	3.6	3.6	2.3
16-12 F6X	1	3/4 - 14	1 1/2	2.33	3.6	3.6	2.3
20 F6X	1 1/4	1 1/4 - 11 1/2	2	2.76	3.0	3.0	2.0
24 F6X	1 1/2	1 1/2 - 11 1/2	2 1/4	3.05	2.5	2.5	1.6
32 F6X	2	2 - 11 1/2	2 5/8	3.53	2.0	2.0	1.3

**WARNING:** This product can expose you to chemicals including Lead and Lead Compounds which is known to the State of California to cause cancer and birth defects or other reproductive harm. For more information go to [www.p65warnings.ca.gov](http://www.p65warnings.ca.gov).

## F6870MX

Swivel – ISO 6149 Connector  
37° Swivel / ISO 6149

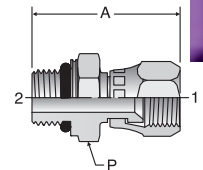

TUBE FITTING PART #	END SIZE		Male Metric Parallel Thread	A (mm)	P (mm)	Dynamic Pressure (x 1,000 PSI)		
	1 (mm)	2 (in.)				S	SS	B
	4M10F6870MX	6						
5M12F6870MX	8	5/16	M12x1.5	35.6	17	6.0	5.0	3.3
6M14F6870MX	10	3/8	M14x1.5	37.2	19	5.0	5.0	3.3
8M16F6870MX	12	1/2	M16x1.5	41.8	22	5.0	5.0	3.3
10M22F6870MX	14, 15, 16	5/8	M22x1.5	47.6	27	5.0	5.0	3.3
12M27F6870MX	18, 20	3/4	M27x2	51.7	32	5.0	5.0	3.3
16M33F6870MX	25	1	M33x2	56.9	41	3.6	3.6	2.3

**WARNING:** This product can expose you to chemicals including Lead and Lead Compounds which is known to the State of California to cause cancer and birth defects or other reproductive harm. For more information go to [www.p65warnings.ca.gov](http://www.p65warnings.ca.gov).

- TABLE OF CONTENTS
- VISUAL INDEX
- FAQs
- ASSEMBLY
- TUBE FAB EQUIP
- GEN TECH

Click here for CADs, Support Resources or to Configure Parts Online

## F68OMX

Swivel Metric ORR Connector  
Metric-ORR / 37° Swivel

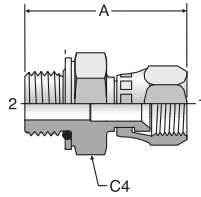

TUBE FITTING PART #	END SIZE			A (mm)	C4 (mm)	Dynamic Pressure (x 1,000 PSI)		
	1		2 Male Metric Parallel Thread			S	SS	B
	(mm)	(in.)						
4M10F68OMX	6	1/4	M10x1	30.2	14	5.0	5.0	3.3
5M12F68OMX	8	5/16	M12x1.5	35.6	17	6.0	6.0	3.3
6M14F68OMX	10	3/8	M14x1.5	37.2	19	5.0	5.0	3.3
8M16F68OMX	12	1/2	M16x1.5	42.4	22	3.6	3.6	2.3
10M22F68OMX	14, 15, 16	5/8	M22x1.5	47.9	27	3.6	3.6	2.3
12M27F68OMX	18, 20	3/4	M27x2	52.3	32	3.0	3.0	2.0
16M33F68OMX	25	1	M33x2	57.4	41	3.0	3.0	2.0

**WARNING:** This product can expose you to chemicals including Lead and Lead Compounds which is known to the State of California to cause cancer and birth defects or other reproductive harm. For more information go to [www.p65warnings.ca.gov](http://www.p65warnings.ca.gov).

## F682EDMX

Metric-ED / 37° Swivel

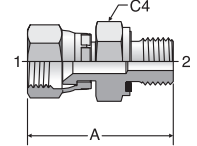

TUBE FITTING PART #	END SIZE			A (mm)	C4 (mm)	Dynamic Pressure (x 1,000 PSI)		
	1		2 Male Metric Parallel Thread			S	SS	B
	(mm)	(in.)						
4M10F682EDMX	6	1/4	M10x1	29.7	14	7.2	5.0	3.3
5M12F682EDMX	8	5/16	M12x1.5	36.6	17	6.0	5.0	3.3
6M14F682EDMX	10	3/8	M14x1.5	38.2	19	5.0	5.0	3.3
8M16F682EDMX	12	1/2	M16x1.5	42.3	22	5.0	5.0	3.3
10M22F682EDMX	14, 15, 16	5/8	M22x1.5	48.6	27	5.0	5.0	3.3
12M27F682EDMX	18, 20	3/4	M27x2	51.7	32	5.0	5.0	3.3
16M33F682EDMX	25	1	M33x2	59.0	41	3.6	3.6	2.3

**WARNING:** This product can expose you to chemicals including Lead and Lead Compounds which is known to the State of California to cause cancer and birth defects or other reproductive harm. For more information go to [www.p65warnings.ca.gov](http://www.p65warnings.ca.gov).

## F642EDMX

Swivel – BSPP Connector  
37° Swivel / BSPP-ED

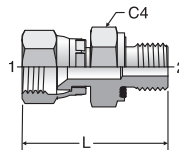

TUBE FITTING PART #	END SIZE			C4 (mm)	L (mm)	Dynamic Pressure (x 1,000 PSI)		
	1		2 BSPP			S	SS	B
	(mm)	(in.)						
4F642EDMX	6	1/4	1/8 - 28	14	29.7	7.2	5.0	3.3
4-4F642EDMX	6	1/4	1/4 - 19	19	35.2	6.0	5.0	3.3
5F642EDMX	8	5/16	1/8 - 28	14	32.8	6.0	5.0	3.3
5-4F642EDMX	8	5/16	1/4 - 19	19	37.2	6.0	6.0	3.3
6F642EDMX	10	3/8	1/4 - 19	19	38.7	5.0	5.0	3.3
6-6F642EDMX	10	3/8	3/8 - 19	22	39.2	5.0	5.0	3.3
8F642EDMX	12	1/2	3/8 - 19	22	42.3	5.0	5.0	3.3
8-4F642EDMX	12	1/2	1/4 - 19	19	42.3	5.0	5.0	3.3
10F642EDMX	14, 15, 16	5/8	1/2 - 14	27	48.6	5.0	5.0	3.3
10-6F642EDMX	14, 15, 16	5/8	3/8 - 19	22	46.6	5.0	5.0	3.3
12F642EDMX	18, 20	3/4	3/4 - 14	32	51.7	5.0	5.0	3.3
12-8F642EDMX	18, 20	3/4	1/2 - 14	27	49.7	5.0	5.0	3.3
16F642EDMX	25	1	1 - 11	41	59.0	3.6	3.6	2.3
16-12F642EDMX	25	1	3/4 - 14	32	57.0	3.6	3.6	2.3
20F642EDMX	28, 30, 32	1 1/4	1 1/4 - 11	50	63.4	3.6	3.0	2.0
20-16F642EDMX	28, 30, 32	1 1/4	1 - 11	41	65.9	3.6	3.0	2.0
24F642EDMX	35, 38	1 1/2	1 1/2 - 11	55	74.1	2.5	2.0	1.3
24-20F642EDMX	35, 38	1 1/2	1 1/4 - 11	50	69.1	2.5	2.0	1.3

**WARNING:** This product can expose you to chemicals including Lead and Lead Compounds which is known to the State of California to cause cancer and birth defects or other reproductive harm. For more information go to [www.p65warnings.ca.gov](http://www.p65warnings.ca.gov).

## F63MX

Swivel – BSPT Connector  
37° Swivel / BSPT

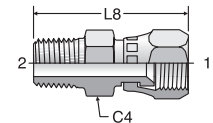

TUBE FITTING PART #	END SIZE			C4 (mm)	L8 (mm)	Dynamic Pressure (x 1,000 PSI)		
	1		2 BSPT			S	SS	B
	(mm)	(in.)						
4F63MX	6	1/4	1/8 - 20	13	31.0	4.5	4.5	2.9
4-4F63MX	6	1/4	1/4 - 19	14	35.7	4.5	4.5	2.9
5-4F63MX	8	5/16	1/4 - 19	14	38.4	4.5	4.5	2.9
6F63MX	10	3/8	1/4 - 19	14	39.7	4.5	4.5	2.9
6-6F63MX	10	3/8	3/8 - 19	19	39.7	4.5	4.5	2.9
8-4F63MX	12	1/2	1/4 - 19	19	42.8	4.5	4.5	2.9
8F63MX	12	1/2	3/8 - 19	19	42.8	4.5	4.5	2.9
10F63MX	14, 15, 16	5/8	1/2 - 14	22	51.2	4.5	4.5	2.9
12-8F63MX	20	3/4	1/2 - 14	27	53.2	4.5	4.5	2.9
12F63MX	18, 20	3/4	3/4 - 14	27	53.2	2.3	2.3	1.5
16-12F63MX	25	1	3/4 - 14	32	55.7	2.3	2.3	1.5
16F63MX	25	1	1 - 11	36	62.5	2.3	2.3	1.5
20F63MX	30, 32	1 1/4	1 1/4 - 11	46	70.6	2.3	2.3	1.5

**WARNING:** This product can expose you to chemicals including Lead and Lead Compounds which is known to the State of California to cause cancer and birth defects or other reproductive harm. For more information go to [www.p65warnings.ca.gov](http://www.p65warnings.ca.gov).

B

TABLE OF CONTENTS

VISUAL INDEX

FAQs

ASSEMBLY

TUBE FAB EQUIP

GEN TECH



Click here for CADs, Support Resources or to Configure Parts Online

# WNTX

45° Bulkhead Union Elbow  
37° Flare / 37° Flare

SAE 070801  
HPD Base # 3353  
WNTX-WLN – Body with locknut  
(See page B10 for WLN)

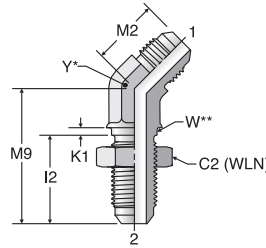

Y\* – Across wrench flats.  
W\*\* – Bulkhead pilot dia.  
recommended clearance hole  
+.015 over W dia.

TUBE FITTING PART #	END SIZE	C2 HEX (in.)	I2 (in.)	K1 (in.)	M2 (in.)	M9 (in.)	W DIA (in.)	MAX BULKHEAD WALL THICKNESS (in.)	Y (in.)	Dynamic Pressure (x 1,000 PSI)		
										-S	-SS	-B
										1 & 2 (in.)	M2 (in.)	M6 (in.)
4 WNTX	1/4	11/16	1.02	0.09	0.72	1.53	0.44	0.25	7/16	7.5	7.7	3.3
5 WNTX	5/16	3/4	1.02	0.09	0.77	1.66	0.56	0.25	9/16	6.0	6.0	3.3
6 WNTX	3/8	13/16	1.09	0.09	0.83	1.67	0.56	0.35	9/16	6.0	6.0	3.3
8 WNTX	1/2	1	1.25	0.13	0.98	1.94	0.75	0.35	3/4	6.0	6.0	3.3
10 WNTX	5/8	1 1/8	1.39	0.13	1.11	2.17	0.82	0.35	7/8	5.0	5.0	3.3
12 WNTX	3/4	1 3/8	1.56	0.13	1.28	2.44	1.06	0.35	1 1/16	5.0	5.0	2.9
16 WNTX	1	1 5/8	1.56	0.13	1.47	2.56	1.31	0.35	1 5/16	4.0	3.5	2.3
20 WNTX	1 1/4	1 7/8	1.61	0.13	1.59	2.66	1.63	0.35	1 5/8	4.0	3.0	2.0

**WARNING:** This product can expose you to chemicals including Lead and Lead Compounds which is known to the State of California to cause cancer and birth defects or other reproductive harm. For more information go to [www.p65warnings.ca.gov](http://www.p65warnings.ca.gov).

# V6X

45° Swivel Nut Elbow  
37° Flare / 37° Swivel

SAE 070321  
HPD Base # 3703

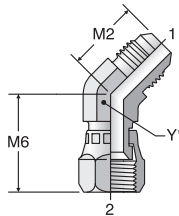

Y\* – Across wrench flats

TUBE FITTING PART #	END SIZE	M2 (in.)	M6 (in.)	Y (in.)	Dynamic Pressure (x 1,000 PSI)		
					-S	-SS	-B
					1 & 2 (in.)	M2 (in.)	M6 (in.)
4 V6X	1/4	0.72	0.94	7/16	7.5	7.7	3.3
5 V6X	5/16	0.77	1.00	9/16	6.0	6.0	3.3
6 V6X	3/8	0.83	1.12	9/16	6.0	6.0	3.3
8 V6X	1/2	0.98	1.28	3/4	6.0	6.0	3.3
10 V6X	5/8	1.11	1.44	7/8	5.0	5.0	3.3
12 V6X	3/4	1.28	1.50	1 1/16	5.0	5.0	3.3
14 V6X	7/8	1.45	1.62	1 3/16	5.0	5.0	3.3
16 V6X	1	1.47	1.75	1 5/16	4.0	3.0	2.6
20 V6X	1 1/4	1.59	2.03	1 5/8	4.0	3.0	2.6
24 V6X	1 1/2	1.78	2.18	1 7/8	3.0	2.5	2.0
32 V6X	2	2.22	2.76	2 1/2	2.0	1.5	1.3

**WARNING:** This product can expose you to chemicals including Lead and Lead Compounds which is known to the State of California to cause cancer and birth defects or other reproductive harm. For more information go to [www.p65warnings.ca.gov](http://www.p65warnings.ca.gov).

TABLE OF CONTENTS

VISUAL INDEX

FAQs

ASSEMBLY

TUBE FAB EQUIP

GEN TECH

Click here for CADs, Support Resources or to Configure Parts Online

# V50X

45° Straight Thread Elbow  
37° Flare / SAE-ORB

SAE 070320  
HPD Base # 3503

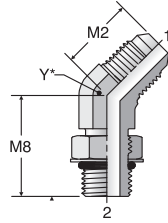

Y\* – Across wrench flats

TUBE FITTING PART #	END SIZE		M2 (in.)	M8 (in.)	Y (in.)	Dynamic Pressure (x 1,000 PSI)		
	1 (in.)	2 UN/UNF-2A				-S	-SS	-B
	4 V50X	1/4						
4-6 V50X	1/4	9/16 - 18	0.82	1.14	9/16	6.0	5.4	3.3
5 V50X	5/16	1/2 - 20	0.77	1.05	9/16	6.0	5.4	3.3
6 V50X	3/8	9/16 - 18	0.83	1.14	9/16	6.0	5.4	3.3
6-4 V50X	3/8	7/16 - 20	0.83	1.08	9/16	6.0	5.4	3.3
6-8 V50X	3/8	3/4 - 16	0.86	1.30	3/4	6.0	5.4	3.3
8 V50X	1/2	3/4 - 16	0.98	1.30	3/4	6.0	5.4	3.3
8-6 V50X	1/2	9/16 - 18	0.98	1.09	3/4	6.0	5.4	3.3
8-10 V50X	1/2	7/8 - 14	1.00	1.52	7/8	5.0	5.4	3.3
8-12 V50X	1/2	1 1/16 - 12	1.04	1.73	1 1/16	5.0	5.4	3.3
10 V50X	5/8	7/8 - 14	1.11	1.52	7/8	5.0	5.4	3.3
10-8 V50X	5/8	3/4 - 16	1.11	1.38	7/8	5.0	5.4	3.3
10-12 V50X	5/8	1 1/16 - 12	1.16	1.73	1 1/16	5.0	5.4	3.3
12 V50X	3/4	1 1/16 - 12	1.28	1.73	1 1/16	5.0	5.4	3.3
12-10 V50X	3/4	7/8 - 14	1.28	1.58	1 1/16	5.0	5.4	3.3
12-16 V50X	3/4	1 5/16 - 12	1.42	1.86	1 5/16	4.0	3.0	2.6
14 V50X	7/8	1 3/16 - 12	1.45	1.86	1 5/16	5.0	5.4	3.3
16 V50X	1	1 5/16 - 12	1.47	1.86	1 5/16	4.0	3.0	2.6
16-12 V50X	1	1 1/16 - 12	1.47	1.86	1 5/16	4.0	3.0	2.6
16-20 V50X	1	1 5/8 - 12	1.55	1.91	1 5/8	3.0	2.5	2.0
20 V50X	1 1/4	1 5/8 - 12	1.59	1.91	1 5/8	3.0	2.5	2.0
20-16 V50X	1 1/4	1 5/16 - 12	1.59	1.91	1 5/8	4.0	2.5	2.0
24 V50X	1 1/2	1 7/8 - 12	1.78	1.91	1 7/8	3.0	2.0	1.5
32 V50X	2	2 1/2 - 12	2.22	1.86	2 1/2	2.0	1.5	1.3

**WARNING:** This product can expose you to chemicals including Lead and Lead Compounds which is known to the State of California to cause cancer and birth defects or other reproductive harm. For more information go to [www.p65warnings.ca.gov](http://www.p65warnings.ca.gov).

# V870MX

Male 45° Elbow – ISO 6149  
37° Flare / ISO 6149  
SAE 070387

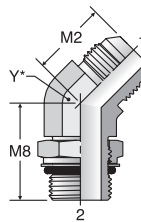

Y\* – Across wrench flats

TUBE FITTING PART #	END SIZE		Male Metric Parallel Thread	M2 (mm)	M8 (mm)	Y (mm)	Dynamic Pressure (x 1,000 PSI)		
	1 (mm)	2 (in.)					S	SS	B
	4M12V870MX	6							
6M14V870MX	10	3/8	M14X1.5	21.1	28.0	14	6.0	6.0	3.3
8M16V870MX	12	1/2	M16 X 1.5	24.9	33.0	19	5.0	5.0	3.3
10M22V870MX	14, 15, 16	5/8	M22 X 1.5	28.2	37.5	22	5.0	5.0	3.3
12M27V870MX	18, 20	3/4	M27 X 2.0	32.5	46.0	27	5.0	5.0	3.3
16M33V870MX	25	1	M33 X 2.0	37.3	45.5	33	4.0	4.0	2.6

**WARNING:** This product can expose you to chemicals including Lead and Lead Compounds which is known to the State of California to cause cancer and birth defects or other reproductive harm. For more information go to [www.p65warnings.ca.gov](http://www.p65warnings.ca.gov).

B

TABLE OF CONTENTS

VISUAL INDEX

FAQs

ASSEMBLY

TUBE FAB EQUIP

GEN TECH

Click here for CADs, Support Resources or to Configure Parts Online

## VTX

45° Male Elbow  
37° Flare / NPTF

SAE 070302  
HPD Base # 3103

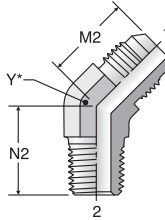

Y\* – Across wrench flats

## V40MX

Male 45° Elbow – BSPP  
37° Flare / BSPP-ORR

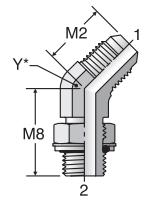

Y\* – Across wrench flats

TUBE FITTING PART #	END SIZE		M2 (in.)	N2 (in.)	Y (in.)	Dynamic Pressure (x 1,000 PSI)		
	1 (in.)	2 NPTF				-S	-SS	-B
	2 VTX	1/8						
3 VTX	3/16	1/8 - 27	0.69	0.52	7/16	6.0	6.0	3.3
4 VTX	1/4	1/8 - 27	0.72	0.64	7/16	6.0	6.0	3.3
4-4 VTX	1/4	1/4 - 18	0.82	0.86	9/16	6.0	6.0	3.3
4-6 VTX	1/4	3/8 - 18	0.85	0.95	3/4	6.0	6.0	3.3
5 VTX	5/16	1/8 - 27	0.77	0.64	9/16	6.0	6.0	3.3
5-4 VTX	5/16	1/4 - 18	0.82	0.86	9/16	6.0	6.0	3.3
6 VTX	3/8	1/4 - 18	0.83	0.86	9/16	6.0	6.0	3.3
6-2 VTX	3/8	1/8 - 27	0.83	0.67	9/16	6.0	6.0	3.3
6-6 VTX	3/8	3/8 - 18	0.87	0.95	3/4	6.0	6.0	3.3
6-8 VTX	3/8	1/2 - 14	0.88	1.17	7/8	6.0	6.0	3.3
8 VTX	1/2	3/8 - 18	0.98	0.95	3/4	6.0	6.0	3.3
8-4 VTX	1/2	1/4 - 18	0.98	0.95	3/4	6.0	6.0	3.3
8-8 VTX	1/2	1/2 - 14	0.99	1.17	7/8	6.0	6.0	3.3
8-12 VTX	1/2	3/4 - 14	1.04	1.20	1 1/16	4.0	4.0	2.6
10 VTX	5/8	1/2 - 14	1.11	1.17	7/8	5.0	5.0	3.3
10-6 VTX	5/8	3/8 - 18	1.11	0.98	7/8	5.0	5.0	3.3
10-12 VTX	5/8	3/4 - 14	1.28	1.20	1 1/16	4.0	4.0	2.6
12 VTX	3/4	3/4 - 14	1.28	1.20	1 1/16	4.0	4.0	2.6
12-8 VTX	3/4	1/2 - 14	1.28	1.20	1 1/16	5.0	5.0	2.9
12-16 VTX	3/4	1 - 11 1/2	1.42	1.49	1 5/16	3.0	3.0	2.0
14 VTX	7/8	3/4 - 14	1.45	1.30	1 5/16	4.0	4.0	2.3
16 VTX	1	1 - 11 1/2	1.47	1.48	1 5/16	3.0	3.0	2.0
16-12 VTX	1	3/4 - 14	1.47	1.29	1 5/16	4.0	4.0	2.3
16-20 VTX	1	1 1/4 - 11 1/2	1.59	1.67	1 5/8	2.5	2.5	1.6
20 VTX	1 1/4	1 1/4 - 11 1/2	1.59	1.67	1 5/8	2.5	2.5	1.6
20-16 VTX	1 1/4	1 - 11 1/2	1.59	1.63	1 5/8	3.0	3.0	2.0
24 VTX	1 1/2	1 1/2 - 11 1/2	1.78	1.77	1 7/8	2.5	2.5	1.6
32 VTX	2	2 - 11 1/2	2.22	2.11	2 1/2	2.0	2.0	1.3

**WARNING:** This product can expose you to chemicals including Lead and Lead Compounds which is known to the State of California to cause cancer and birth defects or other reproductive harm. For more information go to [www.p65warnings.ca.gov](http://www.p65warnings.ca.gov).

TUBE FITTING PART #	END SIZE		M2 (mm)	M8 (mm)	Y (mm)	Dynamic Pressure (x 1,000 PSI)			
	1 (mm)	2 (in.) BSPP				S	SS	B	
	4V40MX	6							1/4
6V40MX	10	3/8	1/4 - 19	21.1	29.0	14	3.6	3.6	2.3
8V40MX	12	1/2	3/8 - 19	24.9	33.0	19	3.6	3.6	2.3
10V40MX	14,15,16	5/8	1/2 - 14	28.2	38.5	22	3.6	3.6	2.3
12V40MX	18,20	3/4	3/4 - 14	32.5	44.0	27	3.6	3.6	2.3
16V40MX	25	1	1 - 11	37.3	47.0	33	3.6	3.6	2.3

**WARNING:** This product can expose you to chemicals including Lead and Lead Compounds which is known to the State of California to cause cancer and birth defects or other reproductive harm. For more information go to [www.p65warnings.ca.gov](http://www.p65warnings.ca.gov).

## V3MX

Male 45° Elbow – BSPT  
37° Flare / BSPT

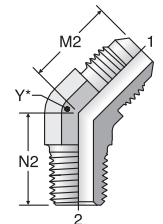

Y\* – Across wrench flats

TUBE FITTING PART #	END SIZE		M2 (mm)	N2 (mm)	Y (mm)	Dynamic Pressure (x 1,000 PSI)			
	1 (mm)	2 (in.) BSPT				S	SS	B	
	4V3MX	6							1/4
4-4V3MX	6	1/4	1/4 - 19	20.8	21.8	14	4.5	4.5	2.9
6V3MX	10	3/8	1/4 - 19	21.1	21.8	14	4.5	4.5	2.9
6-6V3MX	10	3/8	3/8 - 19	22.1	24.1	19	4.5	4.5	2.9
8V3MX	12	1/2	3/8 - 19	24.9	24.1	19	4.5	4.5	2.9
8-8V3MX	12	1/2	1/2 - 14	25.2	29.7	22	4.5	4.5	2.9
12V3MX	18, 20	3/4	3/4 - 14	32.5	30.5	27	2.3	2.3	1.5

**WARNING:** This product can expose you to chemicals including Lead and Lead Compounds which is known to the State of California to cause cancer and birth defects or other reproductive harm. For more information go to [www.p65warnings.ca.gov](http://www.p65warnings.ca.gov).

TABLE OF CONTENTS

VISUAL INDEX

FAQs

ASSEMBLY

TUBE FAB EQUIP

GEN TECH

Click here for CADs, Support Resources or to Configure Parts Online

## ETX

Union Elbow  
37° Flare / 37° Flare

SAE 070201  
HPD Base # 2303

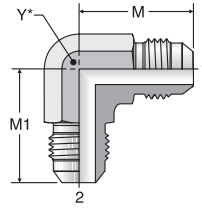

Y\* – Across wrench flats

TUBE FITTING PART #	END SIZE		M (in.)	M1 (in.)	Y (in.)	Dynamic Pressure (x 1,000 PSI)		
	1 (in.)	2 (in.)				-S	-SS	-B
2 ETX	1/8	1/8	0.78	0.78	7/16	7.5	7.7	3.3
3 ETX	3/16	3/16	0.83	0.83	7/16	7.5	7.7	3.3
4 ETX	1/4	1/4	0.89	0.89	7/16	7.5	7.7	3.3
5 ETX	5/16	5/16	0.97	0.97	9/16	6.0	6.0	3.3
6 ETX	3/8	3/8	1.06	1.06	9/16	6.0	6.0	3.3
6-4 ETX	3/8	1/4	1.06	1.05	9/16	6.0	6.0	3.3
8 ETX	1/2	1/2	1.25	1.25	3/4	6.0	6.0	3.3
8-6 ETX	1/2	3/8	1.25	1.14	3/4	6.0	6.0	3.3
10 ETX	5/8	5/8	1.45	1.45	7/8	5.0	5.0	3.3
10-8 ETX	5/8	1/2	1.45	1.33	7/8	5.0	5.0	3.3
12 ETX	3/4	3/4	1.66	1.66	1 1/16	5.0	5.0	3.3
12-8 ETX	3/4	1/2	1.66	1.42	1 1/16	5.0	5.0	3.3
12-10 ETX	3/4	5/8	1.66	1.54	1 1/16	5.0	5.0	3.3
14 ETX	7/8	7/8	1.80	1.80	1 3/16	5.0	5.0	3.3
16 ETX	1	1	1.81	1.81	1 5/16	4.0	3.5	2.3
16-12 ETX	1	3/4	1.81	1.77	1 5/16	4.0	3.5	2.3
20 ETX	1 1/4	1 1/4	2.06	2.06	1 5/8	4.0	3.0	2.0
24 ETX	1 1/2	1 1/2	2.33	2.33	1 7/8	3.0	2.0	1.3
32 ETX	2	2	3.06	3.06	2 1/2	2.0	1.5	1.0

**WARNING:** This product can expose you to chemicals including Lead and Lead Compounds which is known to the State of California to cause cancer and birth defects or other reproductive harm. For more information go to [www.p65warnings.ca.gov](http://www.p65warnings.ca.gov).

## AOEX6

Swivel Elbow Straight  
Thread Connector  
SAE-ORB / 37° Swivel

HPD Base # 2506

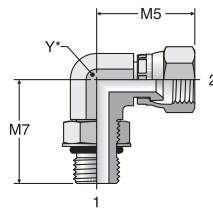

Y\* – Across wrench flats

TUBE FITTING PART #	END SIZE		M5 (in.)	M7 (in.)	Y (in.)	Dynamic Pressure (x 1,000 PSI)		
	1 UN/UNF-2A	2 (in.)				-S	-SS	-B
4 AOEX6	7/16 - 20	1/4	1.00	1.03	7/16	6.0	6.0	3.3
6 AOEX6	9/16 - 18	3/8	1.25	1.25	9/16	6.0	6.0	3.3
8 AOEX6	3/4 - 16	1/2	1.38	1.45	3/4	6.0	6.0	3.3
10 AOEX6	7/8 - 14	5/8	1.62	1.70	7/8	5.0	5.0	3.3
12 AOEX6	1 1/16 - 12	3/4	1.75	1.94	1 1/16	5.0	5.0	3.3
16 AOEX6	1 5/16 - 12	1	2.00	2.05	1 5/16	4.0	3.0	2.6

**WARNING:** This product can expose you to chemicals including Lead and Lead Compounds which is known to the State of California to cause cancer and birth defects or other reproductive harm. For more information go to [www.p65warnings.ca.gov](http://www.p65warnings.ca.gov).

## C6X

Swivel Nut Elbow  
37° Flare / 37° Swivel

SAE 070221  
HPD Base # 3903

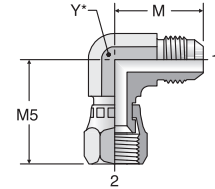

Y\* – Across wrench flats

TUBE FITTING PART #	END SIZE		M (in.)	M5 (in.)	Y (in.)	Dynamic Pressure (x 1,000 PSI)		
	1 (in.)	2 (in.)				-S	-SS	-B
3 C6X	3/16	3/16	0.83	1.00	7/16	7.5	7.7	3.3
4 C6X	1/4	1/4	0.89	1.00	7/16	7.5	7.7	3.3
5 C6X	5/16	5/16	0.95	1.06	9/16	6.0	6.0	3.3
6 C6X	3/8	3/8	1.06	1.25	9/16	6.0	6.0	3.3
8 C6X	1/2	1/2	1.25	1.38	3/4	6.0	6.0	3.3
10 C6X	5/8	5/8	1.45	1.62	7/8	5.0	5.0	3.3
12 C6X	3/4	3/4	1.66	1.75	1 1/16	5.0	5.0	3.3
12-24 C6X	3/4	1 1/2	2.11	2.59	1 7/8	3.0	2.5	2.0
14 C6X	7/8	7/8	1.81	1.78	1 5/16	5.0	5.0	3.3
16 C6X	1	1	1.81	2.00	1 5/16	4.0	3.0	2.6
16-12 C6X	1	3/4	1.81	1.87	1 5/16	4.0	3.0	2.6
20 C6X	1 1/4	1 1/4	2.06	2.31	1 5/8	4.0	3.0	2.6
24 C6X	1 1/2	1 1/2	2.33	2.59	1 7/8	3.0	2.5	2.0
32 C6X	2	2	3.06	3.51	2 1/2	2.0	1.5	1.3

**WARNING:** This product can expose you to chemicals including Lead and Lead Compounds which is known to the State of California to cause cancer and birth defects or other reproductive harm. For more information go to [www.p65warnings.ca.gov](http://www.p65warnings.ca.gov).

B

TABLE OF CONTENTS

VISUAL INDEX

FAQs

ASSEMBLY

TUBE FAB EQUIP

GEN TECH



[Click here for CADs, Support Resources or to Configure Parts Online](#)

# WETX

Bulkhead Union Elbow  
37° Flare / 37° Flare

SAE 070701  
HPD Base # 2353  
WETX-WLN – Body with locknut  
(See page B10 for WLN)

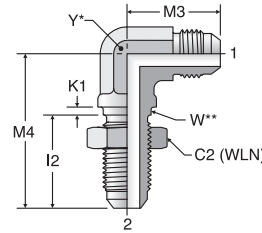

Y\* – Across wrench flats.  
W\*\* – Bulkhead pilot dia.  
recommended clearance hole  
+.015 over W dia.

TUBE FITTING PART #	END SIZE (in.)	C2 HEX (in.)	I2 (in.)	K1 (in.)	M3 (in.)	M4 (in.)	W DIA (in.)	MAX BULKHEAD WALL THICKNESS (in.)	Y (in.)	Dynamic Pressure (x 1,000 PSI)		
										-S	-SS	-B
										3 WETX	3/16	5/8
4 WETX	1/4	11/16	1.02	0.09	0.97	1.59	0.44	0.25	7/16	7.5	7.7	3.3
5 WETX	5/16	3/4	1.02	0.09	1.06	1.72	0.50	0.25	9/16	6.0	6.0	3.3
6 WETX	3/8	13/16	1.09	0.09	1.09	1.81	0.56	0.35	9/16	6.0	6.0	3.3
8 WETX	1/2	1	1.25	0.13	1.36	2.11	0.75	0.35	3/4	6.0	6.0	3.3
10 WETX	5/8	1 1/8	1.39	0.13	1.56	2.39	0.88	0.35	7/8	5.0	5.0	3.3
12 WETX	3/4	1 3/8	1.56	0.13	1.78	2.67	1.06	0.35	1 1/16	5.0	5.0	3.3
14 WETX	7/8	1 1/2	1.56	0.13	1.92	2.80	1.19	0.35	1 5/8	5.0	5.0	3.3
16 WETX	1	1 5/8	1.56	0.13	1.94	2.80	1.31	0.35	1 5/8	4.0	3.5	2.3
20 WETX	1 1/4	1 7/8	1.61	0.13	2.17	3.13	1.63	0.35	1 5/8	4.0	3.0	2.0

**WARNING:** This product can expose you to chemicals including Lead and Lead Compounds which is known to the State of California to cause cancer and birth defects or other reproductive harm. For more information go to [www.p65warnings.ca.gov](http://www.p65warnings.ca.gov).

TABLE OF CONTENTS

VISUAL INDEX

FAQs

ASSEMBLY

TUBE FAB EQUIP

GEN TECH

Click here for CADs, Support Resources or to Configure Parts Online

## X6EF

Swivel Elbow Connector  
37° Swivel / NPTF

HPD Base # 2106

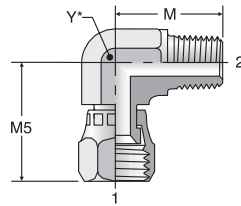

Y\* – Across wrench flats

TUBE FITTING PART #	END SIZE		M (in.)	M5 (in.)	Y (in.)	Dynamic Pressure (x 1,000 PSI)		
	1 (in.)	2 NPTF				-S	-SS	-B
4 X6EF	1/4	1/8 - 27	0.78	1.01	7/16	6.0	6.0	3.3
4-4 X6EF	1/4	1/4 - 18	1.09	1.13	9/16	6.0	6.0	3.3
6 X6EF	3/8	1/4 - 18	1.09	1.25	9/16	6.0	6.0	3.3
6-6 X6EF	3/8	3/8 - 18	1.22	1.27	3/4	6.0	6.0	3.3
8 X6EF	1/2	3/8 - 18	1.22	1.38	3/4	6.0	6.0	3.3
8-8 X6EF	1/2	1/2 - 14	1.47	1.48	7/8	6.0	6.0	3.3
10 X6EF	5/8	1/2 - 14	1.47	1.62	7/8	5.0	5.0	3.3
12 X6EF	3/4	3/4 - 14	1.59	1.75	1 1/16	4.0	4.0	2.6
16 X6EF	1	1 - 11	1.97	2.01	1 5/16	3.0	3.0	2.0

**WARNING:** This product can expose you to chemicals including Lead and Lead Compounds which is known to the State of California to cause cancer and birth defects or other reproductive harm. For more information go to [www.p65warnings.ca.gov](http://www.p65warnings.ca.gov).

## CC50X

Long Straight Thread Elbow  
37° Flare / SAE-ORB

SAE 071620  
HPD Base # 5503

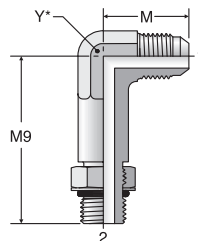

Y\* – Across wrench flats

TUBE FITTING PART #	END SIZE		M (in.)	M9 (in.)	Y (in.)	Dynamic Pressure (x 1,000 PSI)		
	1 (in.)	2 UN/UNF-2A				-S	-SS	-B
4 CC50X	1/4	7/16 - 20	0.89	1.73	9/16	6.0	6.0	3.3
6 CC50X	3/8	9/16 - 18	1.06	2.08	9/16	6.0	5.4	3.3
8 CC50X	1/2	3/4 - 16	1.25	2.50	7/8	6.0	5.4	3.3
10 CC50X	5/8	7/8 - 14	1.45	2.89	7/8	5.0	5.4	3.3
12 CC50X	3/4	1 1/16 - 12	1.66	3.34	1 1/16	5.0	5.4	3.3
16 CC50X	1	1 5/16 - 12	1.81	3.72	1 5/16	4.0	3.0	2.6

**WARNING:** This product can expose you to chemicals including Lead and Lead Compounds which is known to the State of California to cause cancer and birth defects or other reproductive harm. For more information go to [www.p65warnings.ca.gov](http://www.p65warnings.ca.gov).

## C50X

Straight Thread Elbow  
37° Flare / SAE-ORB

SAE 070220  
HPD Base # 2503

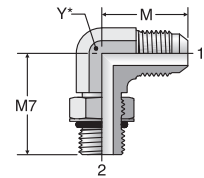

Y\* – Across wrench flats

TUBE FITTING PART #	END SIZE		M (in.)	M7 (in.)	Y (in.)	Dynamic Pressure (x 1,000 PSI)		
	1 (in.)	2 UN/UNF-2A				-S	-SS	-B
2 C50X	1/8	5/16 - 24	0.77	0.94	7/16	5.0	6.0	3.3
3 C50X	3/16	3/8 - 24	0.83	0.94	7/16	5.0	6.0	3.3
4 C50X	1/4	7/16 - 20	0.89	1.03	7/16	6.0	6.0	3.3
4-2 C50X	1/4	5/16 - 24	0.89	0.92	7/16	5.0	6.0	3.3
4-6 C50X	1/4	9/16 - 18	1.05	1.25	9/16	6.0	5.4	3.3
4-8 C50X	1/4	3/4 - 16	1.13	1.45	3/4	6.0	5.4	3.3
5 C50X	5/16	1/2 - 20	0.95	1.13	9/16	6.0	5.4	3.3
5-4 C50X	5/16	7/16 - 20	0.95	1.13	9/16	6.0	5.4	3.3
5-6 C50X	5/16	9/16 - 18	1.06	1.25	9/16	6.0	5.4	3.3
6 C50X	3/8	9/16 - 18	1.06	1.25	9/16	6.0	5.4	3.3
6-4 C50X	3/8	7/16 - 20	1.06	1.19	9/16	6.0	5.4	3.3
6-5 C50X	3/8	1/2 - 20	1.06	1.19	9/16	6.0	5.4	3.3
6-8 C50X	3/8	3/4 - 16	1.14	1.45	3/4	6.0	5.4	3.3
6-10 C50X	3/8	7/8 - 14	1.23	1.70	7/8	6.0	5.4	3.3
8 C50X	1/2	3/4 - 16	1.25	1.45	3/4	6.0	5.4	3.3
8-4 C50X	1/2	7/16 - 20	1.25	1.26	3/4	6.0	5.4	3.3
8-6 C50X	1/2	9/16 - 18	1.25	1.34	3/4	6.0	5.4	3.3
8-10 C50X	1/2	7/8 - 14	1.33	1.70	7/8	5.0	5.4	3.3
8-12 C50X	1/2	1 1/16 - 12	1.42	1.94	1 1/16	5.0	5.4	3.3
8-16 C50X	1/2	1 5/16 - 12	1.52	2.05	1 5/16	4.0	3.0	2.6
10 C50X	5/8	7/8 - 14	1.45	1.70	7/8	5.0	5.4	3.3
10-6 C50X	5/8	9/16 - 18	1.45	1.41	7/8	5.0	5.4	3.3
10-8 C50X	5/8	3/4 - 16	1.45	1.55	7/8	5.0	5.4	3.3
10-12 C50X	5/8	1 1/16 - 12	1.53	1.94	1 1/16	5.0	5.4	3.3
10-16 C50X	5/8	1 5/16 - 12	1.64	2.05	1 5/16	4.0	3.0	2.6
12 C50X	3/4	1 1/16 - 12	1.66	1.94	1 1/16	5.0	5.4	3.3
12-8 C50X	3/4	3/4 - 16	1.66	1.63	1 1/16	5.0	5.4	3.3
12-10 C50X	3/4	7/8 - 14	1.66	1.78	1 1/16	5.0	5.4	3.3
12-14 C50X	3/4	1 3/16 - 12	1.77	2.00	1 5/16	5.0	5.4	3.3
12-16 C50X	3/4	1 5/16 - 12	1.76	2.05	1 5/16	4.0	3.0	2.6
12-20 C50X	3/4	1 5/8 - 12	1.97	2.25	1 5/8	3.0	3.0	2.6
14 C50X	7/8	1 3/16 - 12	1.80	2.05	1 5/16	5.0	5.4	3.3
16 C50X	1	1 5/16 - 12	1.81	2.05	1 5/16	4.0	3.0	2.6
16-12 C50X	1	1 1/16 - 12	1.81	2.05	1 5/16	4.0	3.0	2.6
16-14 C50X	1	1 3/16 - 12	1.81	2.05	1 5/16	4.0	3.0	2.6
16-20 C50X	1	1 5/8 - 12	2.01	2.25	1 5/8	3.0	2.5	2.0
16-24 C50X	1	1 7/8 - 12	2.16	2.39	1 7/8	3.0	2.5	2.0
20 C50X	1 1/4	1 5/8 - 12	2.06	2.25	1 5/8	3.0	2.5	2.0
20-16 C50X	1 1/4	1 5/16 - 12	2.06	2.25	1 5/8	4.0	2.5	2.0
20-24 C50X	1 1/4	1 7/8 - 12	2.20	2.39	1 7/8	3.0	2.5	2.0
24 C50X	1 1/2	1 7/8 - 12	2.33	2.39	1 7/8	3.0	2.0	1.5
24-20 C50X	1 1/2	1 5/8 - 12	2.33	2.39	1 7/8	3.0	2.0	1.5
32 C50X	2	2 1/2 - 12	3.06	2.89	2 1/2	2.0	1.5	1.3
32-24 C50X	2	1 7/8 - 12	3.06	2.89	2 1/2	2.0	1.5	1.3

**WARNING:** This product can expose you to chemicals including Lead and Lead Compounds which is known to the State of California to cause cancer and birth defects or other reproductive harm. For more information go to [www.p65warnings.ca.gov](http://www.p65warnings.ca.gov).

**B**

TABLE OF CONTENTS

VISUAL INDEX

FAQs

ASSEMBLY

TUBE FAB EQUIP

GEN TECH

Click here for CADs, Support Resources or to Configure Parts Online

# CTX

Male Elbow  
37° Flare / NPTF

SAE 070202  
HPD Base # 2103

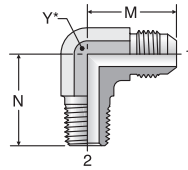

Y\* – Across wrench flats

TUBE FITTING PART #	END SIZE		M (in.)	N (in.)	Y (in.)	Dynamic Pressure (x 1,000 PSI)		
	1 (in.)	2 NPTF				-S	-SS	-B
2 CTX	1/8	1/8 - 27	0.77	0.72	5/16	6.0	6.0	3.3
3 CTX	3/16	1/8 - 27	0.83	0.72	3/8	6.0	6.0	3.3
4 CTX	1/4	1/8 - 27	0.89	0.78	7/16	6.0	6.0	3.3
4-4 CTX	1/4	1/4 - 18	1.05	1.09	9/16	6.0	6.0	3.3
4-6 CTX	1/4	3/8 - 18	1.12	1.22	3/4	6.0	6.0	3.3
4-8 CTX	1/4	1/2 - 14	1.21	1.47	7/8	6.0	6.0	3.3
5 CTX	5/16	1/8 - 27	0.95	0.78	9/16	6.0	6.0	3.3
5-4 CTX	5/16	1/4 - 18	1.05	1.09	9/16	6.0	6.0	3.3
5-6 CTX	5/16	3/8 - 18	1.12	1.22	3/4	6.0	6.0	3.3
6 CTX	3/8	1/4 - 18	1.06	1.09	9/16	6.0	6.0	3.3
6-2 CTX	3/8	1/8 - 27	1.06	0.90	9/16	6.0	6.0	3.3
6-6 CTX	3/8	3/8 - 18	1.14	1.22	3/4	6.0	6.0	3.3
6-8 CTX	3/8	1/2 - 14	1.22	1.47	7/8	6.0	6.0	3.3
6-12 CTX	3/8	3/4 - 14	1.31	1.59	1 1/16	4.0	4.0	2.6
8 CTX	1/2	3/8 - 18	1.25	1.22	3/4	6.0	6.0	3.3
8-4 CTX	1/2	1/4 - 18	1.25	1.22	3/4	6.0	6.0	3.3
8-8 CTX	1/2	1/2 - 14	1.33	1.47	7/8	6.0	6.0	3.3
8-12 CTX	1/2	3/4 - 14	1.42	1.59	1 1/16	4.0	4.0	2.6
8-16 CTX	1/2	1 - 11 1/2	1.52	1.97	1 5/16	3.0	3.0	2.0
10 CTX	5/8	1/2 - 14	1.45	1.47	7/8	5.0	5.0	3.3
10-6 CTX	5/8	3/8 - 18	1.45	1.28	7/8	5.0	5.0	3.3
10-12 CTX	5/8	3/4 - 14	1.53	1.59	1 1/16	4.0	4.0	2.6
10-16 CTX	5/8	1 - 11 1/2	1.64	1.97	1 5/16	3.0	3.0	2.0
12 CTX	3/4	3/4 - 14	1.66	1.59	1 1/16	4.0	4.0	2.6
12-6 CTX	3/4	3/8 - 18	1.66	1.40	1 1/16	5.0	5.0	3.3
12-8 CTX	3/4	1/2 - 14	1.66	1.59	1 1/16	5.0	5.0	2.9
12-16 CTX	3/4	1 - 11 1/2	1.76	1.97	1 5/16	3.0	3.0	2.0
14 CTX	7/8	3/4 - 14	1.80	1.69	1 5/16	4.0	4.0	2.3
16 CTX	1	1 - 11 1/2	1.81	1.97	1 5/16	3.0	3.0	2.0
16-8 CTX	1	1/2 - 14	1.81	1.66	1 5/16	4.0	4.0	2.3
16-12 CTX	1	3/4 - 14	1.81	1.78	1 5/16	4.0	4.0	2.3
16-20 CTX	1	1 1/4 - 11 1/2	2.01	2.38	1 5/8	2.5	2.5	1.6
20 CTX	1 1/4	1 1/4 - 11 1/2	2.06	2.38	1 5/8	2.5	2.5	1.6
20-16 CTX	1 1/4	1 - 11 1/2	2.06	2.06	1 5/8	3.0	3.0	2.0
20-24 CTX	1 1/4	1 1/2 - 11 1/2	2.21	2.64	1 7/8	2.5	2.5	1.6
24 CTX	1 1/2	1 1/2 - 11 1/2	2.33	2.64	1 7/8	2.5	2.5	1.6
24-20 CTX	1 1/2	1 1/4 - 11 1/2	2.33	2.25	1 7/8	2.5	2.5	1.6
24-32 CTX	1 1/2	2 - 11 1/2	2.81	3.00	2 1/2	2.0	2.0	1.3
32 CTX	2	2 - 11 1/2	3.06	3.00	2 1/2	2.0	2.0	1.3
32-24 CTX	2	1 1/2 - 11 1/2	3.06	2.97	2 1/2	2.0	2.0	1.3
40 CTX	2 1/2	2 1/2 - 8	2.86	3.57	3 1/4	1.0	1.0	0.6

**WARNING:** This product can expose you to chemicals including Lead and Lead Compounds which is known to the State of California to cause cancer and birth defects or other reproductive harm. For more information go to [www.p65warnings.ca.gov](http://www.p65warnings.ca.gov).

# CCTX

Long Male Elbow  
37° Flare / NPTF

SAE 071502  
HPD Base # 5603

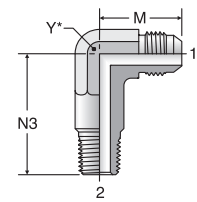

Y\* – Across wrench flats

TUBE FITTING PART #	END SIZE		M (in.)	N3 (in.)	Y (in.)	Dynamic Pressure (x 1,000 PSI)		
	1 (in.)	2 NPTF				-S	-SS	-B
4 CCTX	1/4	1/8 - 27	0.89	1.17	7/16	6.0	6.0	3.3
4-4 CCTX	1/4	1/4 - 18	1.05	1.58	9/16	6.0	6.0	3.3
5 CCTX	5/16	1/8 - 27	0.95	1.17	9/16	6.0	6.0	3.3
6 CCTX	3/8	1/4 - 18	1.06	1.58	9/16	6.0	6.0	3.3
6-6 CCTX	3/8	3/8 - 18	1.14	1.82	3/4	6.0	6.0	3.3
8 CCTX	1/2	3/8 - 18	1.25	1.82	3/4	6.0	6.0	3.3
8-8 CCTX	1/2	1/2 - 14	1.33	2.17	7/8	6.0	6.0	3.3
8-12 CCTX	1/2	3/4 - 14	1.42	2.44	1 1/16	4.0	4.0	2.6
10 CCTX	5/8	1/2 - 14	1.45	2.17	7/8	5.0	5.0	3.3
12 CCTX	3/4	3/4 - 14	1.66	2.44	1 1/16	4.0	4.0	2.6
14 CCTX	7/8	3/4 - 14	1.80	2.59	1 5/16	4.0	4.0	2.3
16 CCTX	1	1 - 11 1/2	1.81	3.01	1 5/16	3.0	3.0	2.0
20 CCTX	1 1/4	1 1/4 - 11 1/2	2.06	3.69	1 5/8	2.5	2.5	1.6

**WARNING:** This product can expose you to chemicals including Lead and Lead Compounds which is known to the State of California to cause cancer and birth defects or other reproductive harm. For more information go to [www.p65warnings.ca.gov](http://www.p65warnings.ca.gov).

# CCCTX

Extra Long Male Elbow  
37° Flare / NPTF

SAE 071602  
HPD Base # 5703

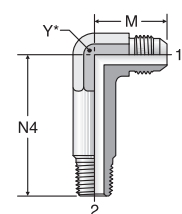

Y\* – Across wrench flats

TUBE FITTING PART #	END SIZE		M (in.)	N4 (in.)	Y (in.)	Dynamic Pressure (x 1,000 PSI)		
	1 (in.)	2 NPTF				-S	-SS	-B
4 CCCTX	1/4	1/8 - 27	0.89	1.56	7/16	6.0	6.0	3.3
4-4 CCCTX	1/4	1/4 - 18	1.05	2.07	9/16	6.0	6.0	3.3
5 CCCTX	5/16	1/8 - 27	0.97	1.63	9/16	6.0	6.0	3.3
6 CCCTX	3/8	1/4 - 18	1.06	2.07	9/16	6.0	6.0	3.3
6-6 CCCTX	3/8	3/8 - 18	1.14	2.34	3/4	6.0	6.0	3.3
8 CCCTX	1/2	3/8 - 18	1.25	2.34	3/4	6.0	6.0	3.3
8-8 CCCTX	1/2	1/2 - 14	1.33	2.87	7/8	6.0	6.0	3.3
10 CCCTX	5/8	1/2 - 14	1.45	2.87	7/8	5.0	5.0	3.3
12 CCCTX	3/4	3/4 - 14	1.66	3.28	1 1/16	4.0	4.0	2.3
16 CCCTX	1	1 - 11 1/2	1.81	4.05	1 5/16	3.0	3.0	2.0
20 CCCTX	1 1/4	1 1/4 - 11 1/2	2.06	5.00	1 5/8	2.5	2.5	1.6

**WARNING:** This product can expose you to chemicals including Lead and Lead Compounds which is known to the State of California to cause cancer and birth defects or other reproductive harm. For more information go to [www.p65warnings.ca.gov](http://www.p65warnings.ca.gov).

TABLE OF CONTENTS

VISUAL INDEX

FAQs

ASSEMBLY

TUBE FAB EQUIP

GEN TECH

Click here for CADs, Support Resources or to Configure Parts Online

# DTX

Femle Elbow  
37° Flare / NPTF

SAE 070203  
HPD Base # 2203

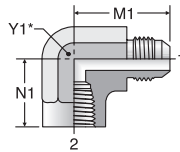

Y\* – Across wrench flats

# C870MX

Male Elbow – ISO 6149  
37° Flare / ISO 6149  
SAE 070287

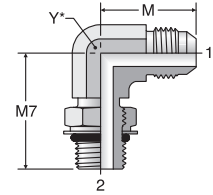

Y\* – Across wrench flats

TUBE FITTING PART #	END SIZE		M1 (in.)	N1 (in.)	Y1 (in.)	Dynamic Pressure (x 1,000 PSI)		
	1 (in.)	2 NPTF				-S	-SS	-B
	4 DTX	1/4						
4-4 DTX	1/4	1/4 - 18	1.22	0.88	3/4	5.0	5.0	3.3
5 DTX	5/16	1/8 - 27	1.08	0.66	9/16	5.0	5.0	3.3
5-4 DTX	5/16	1/4 - 18	1.22	0.88	3/4	5.0	5.0	3.3
6 DTX	3/8	1/4 - 18	1.23	0.88	3/4	5.0	5.0	3.3
6-2 DTX	3/8	1/8 - 27	1.23	0.67	9/16	5.0	5.0	3.3
6-6 DTX	3/8	3/8 - 18	1.31	1.02	7/8	4.5	4.5	2.9
8 DTX	1/2	3/8 - 18	1.42	1.02	7/8	4.5	4.5	2.9
8-4 DTX	1/2	1/4 - 18	1.42	1.01	3/4	4.5	4.5	2.9
8-8 DTX	1/2	1/2 - 14	1.52	1.23	1 1/16	3.0	3.0	2.0
10 DTX	5/8	1/2 - 14	1.64	1.23	1 1/16	3.0	3.0	2.0
12 DTX	3/4	3/4 - 14	1.89	1.36	1 5/16	3.0	3.0	2.0
12-8 DTX	3/4	1/2 - 14	1.89	1.35	1 1/16	3.0	3.0	2.0
14 DTX	7/8	3/4 - 14	1.86	1.42	1 5/16	3.0	3.0	2.0
16 DTX	1	1 - 11 1/2	2.17	1.62	1 5/8	1.8	1.8	1.2
20 DTX	1 1/4	1 1/4 - 11 1/2	2.33	1.70	1 7/8	1.5	1.5	1.0
24 DTX	1 1/2	1 1/2 - 11 1/2	2.89	2.08	2 1/2	1.5	1.5	1.0

**WARNING:** This product can expose you to chemicals including Lead and Lead Compounds which is known to the State of California to cause cancer and birth defects or other reproductive harm. For more information go to [www.p65warnings.ca.gov](http://www.p65warnings.ca.gov).

TUBE FITTING PART #	END SIZE		M (mm)	M7 (mm)	Y (mm)	Dynamic Pressure (x 1,000 PSI)		
	1 (mm)	2 Male Metric Parallel Thread (in.)				S	SS	B
	4M10C870MX	6						
5M12C870MX	8	5/16 M12x1.5	24.1	30.5	13	6.0	5.0	3.3
6M14C870MX	10	3/8 M14x1.5	26.9	33.5	14	6.0	5.0	3.3
8M16C870MX	12	1/2 M16x1.5	31.8	38.0	19	5.0	5.0	3.3
8M18C870MX	12	1/2 M18x1.5	31.8	38.0	19	5.0	5.0	3.3
10M18C870MX	14, 15, 16	5/8 M18x1.5	36.8	41.5	22	5.0	5.0	3.3
10M22C870MX	14, 15, 16	5/8 M22x1.5	36.8	42.5	22	5.0	5.0	3.3
12M22C870MX	18, 20	3/4 M22x.15	42.2	45.0	27	5.0	5.0	3.3
12M27C870MX	18, 20	3/4 M27x2	42.2	51.0	27	5.0	5.0	3.3
16M33C870MX	25	1 M33x2	46.0	53.0	33	4.0	4.0	2.6

**WARNING:** This product can expose you to chemicals including Lead and Lead Compounds which is known to the State of California to cause cancer and birth defects or other reproductive harm. For more information go to [www.p65warnings.ca.gov](http://www.p65warnings.ca.gov).

# C80MX

Male Elbow – Metric-ORR  
37° Flare / Metric-ORR

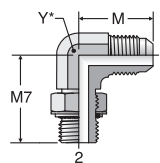

Y\* – Across wrench flats

TUBE FITTING PART #	END SIZE		Male Metric Parallel Thread	M (mm)	M7 (mm)	Y (mm)	Dynamic Pressure (x 1,000 PSI)		
	1 (mm)	2 (in.)					S	SS	B
	4M10C80MX	6							
5M12C80MX	8	5/16	M12x1.5	24.1	30.5	13	3.6	3.6	2.3
6M14C80MX	10	3/8	M14x1.5	26.9	33.5	14	3.6	3.6	2.3
8M16C80MX	12	1/2	M16x1.5	31.8	38.0	19	3.6	3.6	2.3
8M18C80MX	12	1/2	M18x1.5	31.8	38.0	19	3.6	3.6	2.3
10M18C80MX	14, 15, 16	5/8	M18x1.5	36.8	41.5	22	3.6	3.6	2.3
10M22C80MX	14, 15, 16	5/8	M22x1.5	36.8	42.5	22	3.6	3.6	2.3
12M22C80MX	18, 20	3/4	M22x.15	42.2	45.0	27	3.6	3.6	2.3
12M27C80MX	18, 20	3/4	M27x2.0	42.2	51.0	27	2.5	2.5	1.6
16M33C80MX	25	1	M33x2.0	46.0	53.0	33	2.0	2.0	1.3

**WARNING:** This product can expose you to chemicals including Lead and Lead Compounds which is known to the State of California to cause cancer and birth defects or other reproductive harm. For more information go to [www.p65warnings.ca.gov](http://www.p65warnings.ca.gov).

**B**

TABLE OF CONTENTS

VISUAL INDEX

FAQs

ASSEMBLY

TUBE FAB EQUIP

GEN TECH

[Click here for CADs, Support Resources or to Configure Parts Online](#)

## C4OMX

Male Elbow – BSPP  
37° Flare / BSPP-ORR

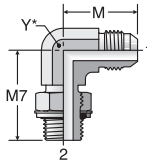

Y\* – Across wrench flats

## C3MX

Male Elbow – BSPT  
37° Flare / BSPT

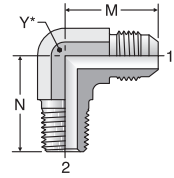

Y\* – Across wrench flats

TUBE FITTING PART #	END SIZE			M (mm)	M7 (mm)	Y (mm)	Dynamic Pressure (x 1,000 PSI)		
	1		2				S	SS	B
	(mm)	(in.)	BSPP						
4C4OMX	6	1/4	1/8-28	22.6	26.5	11	3.6	3.6	2.3
4-4C4OMX	6	1/4	1/4-19	26.9	32.0	14	3.6	2.9	1.9
5C4OMX	8	5/16	1/8-28	24.1	27.0	13	3.6	3.6	2.3
5-4C4OMX	8	5/16	1/4-19	26.6	32.0	14	3.6	2.9	1.9
5-6C4OMX	8	5/16	3/8-19	28.5	37.0	19	3.6	2.9	1.9
6C4OMX	10	3/8	1/4-19	26.9	32.0	14	3.6	2.9	1.9
6-6C4OMX	10	3/8	3/8-19	29.0	37.0	19	3.6	2.9	1.9
8-4C4OMX	12	1/2	1/4-19	31.8	37.0	19	3.6	2.9	1.9
8C4OMX	12	1/2	3/8-19	31.8	37.0	19	3.6	2.9	1.9
8-8C4OMX	12	1/2	1/2-14	33.8	43.0	22	3.6	2.9	1.9
10-6C4OMX	16	5/8	3/8-19	36.8	36.0	22	3.6	2.9	1.9
10C4OMX	14,15,16	5/8	1/2-14	36.8	43.0	22	3.6	2.9	1.9
10-12C4OMX	15	5/8	3/4-14	39.2	49.5	27	3.6	2.9	1.9
12-8C4OMX	18,20	3/4	1/2-14	42.2	49.5	27	3.6	2.9	1.9
12C4OMX	18,20	3/4	3/4-14	42.2	49.5	27	3.6	2.9	1.9
12-16C4OMX	18	3/4	1-11	44.7	52.0	33	3.6	2.9	1.9
16-12C4OMX	25	1	3/4-14	46.0	47.0	33	3.6	2.9	1.9
16C4OMX	25	1	1-11	46.0	52.0	33	3.6	2.9	1.9
20-16C4OMX	30,32	1 1/4	1-11	52.3	57.0	41	3.6	2.3	1.5
20C4OMX	30,32	1 1/4	1 1/4-11	52.3	57.0	41	3.0	2.3	1.5
24-20C4OMX	38	1 1/2	1 1/4-11	59.2	60.5	48	3.0	2.0	1.3
24C4OMX	38	1 1/2	1 1/2-11	59.2	60.5	48	2.0	2.0	1.3

**WARNING:** This product can expose you to chemicals including Lead and Lead Compounds which is known to the State of California to cause cancer and birth defects or other reproductive harm. For more information go to [www.p65warnings.ca.gov](http://www.p65warnings.ca.gov).

TUBE FITTING PART #	END SIZE			M (mm)	N (mm)	Y (mm)	Dynamic Pressure (x 1,000 PSI)		
	1		2				S	SS	B
	(mm)	(in.)	BSPT						
4C3MX	6	1/4	1/8 - 28	22.6	19.8	11	4.5	4.5	2.9
4-4C3MX	6	1/4	1/4 - 19	26.6	27.7	14	4.5	4.5	2.9
5C3MX	8	5/16	1/8 - 28	24.1	19.8	13	4.5	4.5	2.9
5-4C3MX	8	5/16	1/4 - 19	26.6	27.7	14	4.5	4.5	2.9
6C3MX	10	3/8	1/4 - 19	26.9	27.7	14	4.5	4.5	2.9
6-6C3MX	10	3/8	3/8 - 19	29.0	31.0	19	4.5	4.5	2.9
6-8C3MX	10	3/8	1/2 - 14	31.0	37.3	22	4.5	4.5	2.9
8-4C3MX	12	1/2	1/4 - 19	31.8	31.0	19	4.5	4.5	2.9
8C3MX	12	1/2	3/8 - 19	31.8	31.0	19	4.5	4.5	2.9
8-8C3MX	12	1/2	1/2 - 14	33.8	37.3	22	4.5	4.5	2.9
10-6C3MX	14,15,16	5/8	3/8 - 19	36.8	32.5	22	4.5	4.5	2.9
10C3MX	14,15,16	5/8	1/2 - 14	36.8	37.3	22	4.5	4.5	2.9
10-12C3MX	14,15,16	5/8	3/4 - 14	39.2	40.4	27	2.3	2.3	1.5
12-8C3MX	18,20	3/4	1/2 - 14	42.2	40.4	27	4.5	4.5	2.9
12C3MX	18,20	3/4	3/4 - 14	42.2	40.4	27	2.3	2.3	1.5
16-12C3MX	25	1	3/4 - 14	46.0	45.2	33	2.3	2.3	1.5
16C3MX	25	1	1 - 11	46.0	50.0	33	2.3	2.3	1.5
20-16C3MX	30,32	1 1/4	1 - 11	52.3	59.7	41	2.3	2.3	1.5
20C3MX	30,32	1 1/4	1 1/4 - 11	52.3	60.5	41	2.3	2.3	1.5
24C3MX	38	1 1/2	1 1/2 - 11	59.2	67.1	48	2.3	2.0	1.3

**WARNING:** This product can expose you to chemicals including Lead and Lead Compounds which is known to the State of California to cause cancer and birth defects or other reproductive harm. For more information go to [www.p65warnings.ca.gov](http://www.p65warnings.ca.gov).

TABLE OF CONTENTS

VISUAL INDEX

FAQs

ASSEMBLY

TUBE FAB EQUIP

GEN TECH



[Click here for CADs, Support Resources or to Configure Parts Online](#)

# JTX

Union Tee  
37° Flare (all three ends)

SAE 070401  
HPD Base # 033T

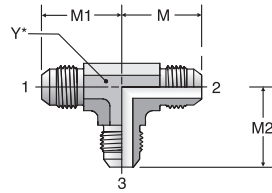

Y\* – Across wrench flats

TUBE FITTING PART #	END SIZE			M (in.)	M1 (in.)	M2 (in.)	Y (in.)	Dynamic Pressure (x 1,000 PSI)		
	1 (in.)	2 (in.)	3 (in.)					-S	-SS	-B
2 JTX	1/8	1/8	1/8	0.77	0.77	0.77	5/16	7.5	7.7	3.3
3 JTX	3/16	3/16	3/16	0.83	0.83	0.83	7/16	7.5	7.7	3.3
4 JTX	1/4	1/4	1/4	0.89	0.89	0.89	7/16	7.5	7.7	3.3
4-4-3 JTX	1/4	1/4	3/16	0.89	0.89	0.81	7/16	7.5	7.7	3.3
5 JTX	5/16	5/16	5/16	0.95	0.95	0.95	9/16	6.0	6.0	3.3
6 JTX	3/8	3/8	3/8	1.06	1.06	1.06	9/16	6.0	6.0	3.3
8 JTX	1/2	1/2	1/2	1.25	1.25	1.25	3/4	6.0	6.0	3.3
10 JTX	5/8	5/8	5/8	1.45	1.45	1.45	7/8	5.0	5.0	3.3
12 JTX	3/4	3/4	3/4	1.66	1.66	1.66	1 1/16	5.0	5.0	2.9
12-12-8 JTX	3/4	3/4	1/2	1.66	1.66	1.42	1 1/16	5.0	5.0	2.9
12-16-12 JTX	3/4	1	3/4	1.77	1.81	1.77	1 5/16	4.0	3.5	2.3
14 JTX	7/8	7/8	7/8	1.80	1.80	1.80	1 5/16	5.0	5.0	2.9
16 JTX	1	1	1	1.81	1.81	1.81	1 5/16	4.0	3.5	2.3
20 JTX	1 1/4	1 1/4	1 1/4	2.06	2.06	2.06	1 5/8	4.0	3.0	2.0
24 JTX	1 1/2	1 1/2	1 1/2	2.33	2.33	2.33	1 7/8	3.0	2.0	1.5
24-16-16 JTX	1 1/2	1	1	2.33	2.16	2.16	1 7/8	3.0	2.0	1.5
32 JTX	2	2	2	3.06	3.06	3.06	2 1/2	2.0	1.5	1.0

**WARNING:** This product can expose you to chemicals including Lead and Lead Compounds which is known to the State of California to cause cancer and birth defects or other reproductive harm. For more information go to [www.p65warnings.ca.gov](http://www.p65warnings.ca.gov).

# WJTX

Bulkhead Branch Tee  
37° Flare (all three ends)

SAE 070959  
HPD Base # 543T  
WJTX-WLN – Body with locknut  
(See page B10 for WLN)

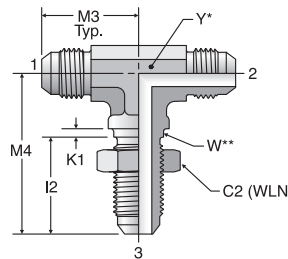

Y\* – Across wrench flats.  
W\*\* – Bulkhead pilot dia. recommended clearance hole +.015 over W dia.

TUBE FITTING PART #	END SIZE 1-3 (in.)	C2 HEX (in.)	I2 (in.)	K1 (in.)	M3 (in.)	M4 (in.)	W DIA (in.)	MAX BULKHEAD WALL THICKNESS (in.)	Y (in.)	Dynamic Pressure (x 1,000 PSI)		
										-S	-SS	-B
4 WJTX	1/4	11/16	1.02	0.09	0.97	1.59	0.44	0.25	7/16	7.5	7.7	3.3
6 WJTX	3/8	13/16	1.09	0.09	1.09	1.81	0.56	0.35	9/16	6.0	6.0	3.3
8 WJTX	1/2	1	1.25	0.13	1.36	2.11	0.75	0.35	3/4	6.0	6.0	3.3
10 WJTX	5/8	1 1/8	1.39	0.13	1.56	2.39	0.88	0.35	1 1/16	5.0	5.0	3.3
12 WJTX	3/4	1 3/8	1.56	0.13	1.78	2.67	1.06	0.35	1 1/16	5.0	5.0	2.9
16 WJTX	1	1 5/8	1.56	0.13	1.94	2.80	1.31	0.35	1 5/16	4.0	3.5	2.3
20 WJTX***	1 1/4	1 7/8	1.61	0.13	2.17	3.12	1.63	0.35	1 5/8	4.0	3.0	2.0

\*\*\*Machined from one-piece milled bar stock.

**WARNING:** This product can expose you to chemicals including Lead and Lead Compounds which is known to the State of California to cause cancer and birth defects or other reproductive harm. For more information go to [www.p65warnings.ca.gov](http://www.p65warnings.ca.gov).

B

TABLE OF CONTENTS

VISUAL INDEX

FAQs

ASSEMBLY

TUBE FAB EQUIP

GEN TECH

[Click here for CADs, Support Resources or to Configure Parts Online](#)

# WJJTX

Bulkhead Run Tee  
37° Flare (all three ends)

SAE 070958  
HPD Base # 533T  
WJJTX-WLN – Body with locknut  
(See page B10 for WLN)

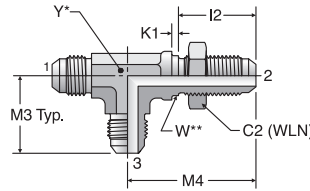

Y\* – Across wrench flats.  
W\*\* – Bulkhead pilot dia.  
recommended clearance hole  
+.015 over W dia.

TUBE FITTING PART #	END SIZE (in.)	C2 HEX (in.)	I2 (in.)	K1 (in.)	M3 (in.)	M4 (in.)	W DIA (in.)	MAX BULKHEAD WALL THICKNESS (in.)	Y (in.)	Dynamic Pressure (x 1,000 PSI)		
										-S	-SS	-B
4 WJJTX	1/4	11/16	1.02	0.09	0.97	1.59	0.44	0.25	7/16	7.5	7.7	3.3
6 WJJTX	3/8	13/16	1.09	0.09	1.09	1.81	0.56	0.35	9/16	6.0	6.0	3.3
8 WJJTX	1/2	1	1.25	0.13	1.36	2.11	0.75	0.35	3/4	6.0	6.0	3.3
10 WJJTX	5/8	1 1/8	1.39	0.13	1.56	2.39	0.88	0.35	7/8	5.0	5.0	3.3
12 WJJTX	3/4	1 3/8	1.56	0.13	1.78	2.67	1.06	0.35	1 1/16	5.0	5.0	2.9
16 WJJTX***	1	1 5/8	1.56	0.13	1.94	2.80	1.31	0.35	1 7/16	4.0	3.5	2.3
20 WJJTX***	1 1/4	1 7/8	1.61	0.13	2.17	3.12	1.63	0.35	1 5/8	4.0	3.0	2.0

\*\*\*Machined from one-piece milled bar stock.

**WARNING:** This product can expose you to chemicals including Lead and Lead Compounds which is known to the State of California to cause cancer and birth defects or other reproductive harm. For more information go to [www.p65warnings.ca.gov](http://www.p65warnings.ca.gov).

# JX6

Swivel Nut Union Tee  
37° Swivel (all three ends)

HPD Base # 069T

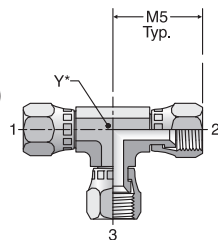

Y\* – Across wrench flats

TUBE FITTING PART #	END SIZE (in.)	M5 (in.)	Y (in.)	Dynamic Pressure (x 1,000 PSI)		
				-S	-SS	-B
4 JX6	1/4	1.00	7/16	7.5	7.7	3.3
6 JX6	3/8	1.25	9/16	6.0	6.0	3.3
8 JX6	1/2	1.38	3/4	6.0	6.0	3.3
10 JX6	5/8	1.62	3/4	5.0	5.0	3.3
12 JX6	3/4	1.75	1 1/16	5.0	5.0	3.3
16 JX6	1	2.00	1 3/16	4.0	3.0	2.6

**WARNING:** This product can expose you to chemicals including Lead and Lead Compounds which is known to the State of California to cause cancer and birth defects or other reproductive harm. For more information go to [www.p65warnings.ca.gov](http://www.p65warnings.ca.gov).

# S6X

Swivel Nut Branch Tee  
37° Flare / 37° Flare / 37° Swivel

SAE 070433  
HPD Base # 393T

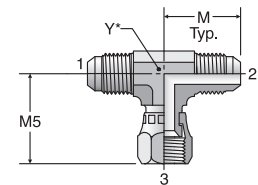

Y\* – Across wrench flats

TUBE FITTING PART #	END SIZE (in.)	M (in.)	M5 (in.)	Y (in.)	Dynamic Pressure (x 1,000 PSI)		
					-S	-SS	-B
4 S6X	1/4	0.89	1.00	7/16	7.5	7.7	3.3
5 S6X	5/16	0.95	1.06	9/16	6.0	6.0	3.3
6 S6X	3/8	1.06	1.25	9/16	6.0	6.0	3.3
8 S6X	1/2	1.25	1.38	3/4	6.0	6.0	3.3
10 S6X	5/8	1.45	1.62	7/8	5.0	5.0	3.3
12 S6X	3/4	1.66	1.75	1 1/16	5.0	5.0	3.3
14 S6X	7/8	1.80	1.78	1 5/16	5.0	5.0	3.3
16 S6X	1	1.81	2.00	1 5/16	4.0	3.0	2.6
20 S6X	1 1/4	2.06	2.31	1 5/8	4.0	3.0	2.6
24 S6X	1 1/2	2.33	2.59	1 7/8	3.0	2.5	2.0

**WARNING:** This product can expose you to chemicals including Lead and Lead Compounds which is known to the State of California to cause cancer and birth defects or other reproductive harm. For more information go to [www.p65warnings.ca.gov](http://www.p65warnings.ca.gov).

TABLE OF CONTENTS

VISUAL INDEX

FAQs

ASSEMBLY

TUBE FAB EQUIP

GEN TECH

Click here for CADs, Support Resources or to Configure Parts Online

## R6X

Swivel Nut Run Tee  
37° Flare / 37° Swivel /  
37° Flare

SAE 070432  
HPD Base # 063T

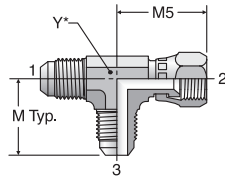

Y\* – Across wrench flats

## S50X

Straight Thread Branch Tee  
37° Flare / 37° Flare /  
SAE-ORB

SAE 070429  
HPD Base # 253T

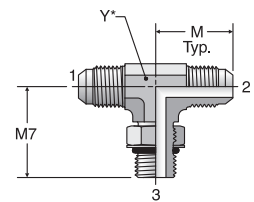

Y\* – Across wrench flats

TUBE FITTING PART #	END SIZE				Dynamic Pressure (x 1,000 PSI)		
	1-3 (in.)	M (in.)	M5 (in.)	Y (in.)	-S	-SS	-B
	4 R6X	1/4	0.89	1.00	7/16	7.5	7.7
5 R6X	5/16	0.95	1.06	9/16	6.0	6.0	3.3
6 R6X	3/8	1.06	1.25	9/16	6.0	6.0	3.3
8 R6X	1/2	1.25	1.38	3/4	6.0	6.0	3.3
10 R6X	5/8	1.45	1.62	7/8	5.0	5.0	3.3
12 R6X	3/4	1.66	1.75	1 1/16	5.0	5.0	3.3
14 R6X	7/8	1.80	1.78	1 5/16	5.0	5.0	3.3
16 R6X	1	1.81	2.00	1 5/16	4.0	3.0	2.6
20 R6X	1 1/4	2.06	2.31	1 5/8	4.0	3.0	2.6
24 R6X	1 1/2	2.33	2.59	1 7/8	3.0	2.5	2.0

**WARNING:** This product can expose you to chemicals including Lead and Lead Compounds which is known to the State of California to cause cancer and birth defects or other reproductive harm. For more information go to [www.p65warnings.ca.gov](http://www.p65warnings.ca.gov).

TUBE FITTING PART #	END SIZE			M (in.)	M7 (in.)	Y (in.)	Dynamic Pressure (x 1,000 PSI)		
	1 (in.)	2 (in.)	3 UN/UNF-2A				-S	-SS	-B
	4 S50X	1/4	1/4				7/16 - 20	0.89	1.03
4-4-6 S50X	1/4	1/4	9/16 - 18	1.05	1.25	9/16	6.0	5.4	3.3
5 S50X	5/16	5/16	1/2 - 20	0.97	1.13	9/16	6.0	5.4	3.3
6 S50X	3/8	3/8	9/16 - 18	1.06	1.25	9/16	6.0	5.4	3.3
6-6-8 S50X	3/8	3/8	3/4 - 16	1.14	1.45	3/4	6.0	5.4	3.3
8 S50X	1/2	1/2	3/4 - 16	1.25	1.45	3/4	6.0	5.4	3.3
8-8-10 S50X	1/2	1/2	7/8 - 14	1.33	1.70	7/8	5.0	5.4	3.3
10 S50X	5/8	5/8	7/8 - 14	1.45	1.70	7/8	5.0	5.4	3.3
10-10-12 S50X	5/8	5/8	1 1/16 - 12	1.53	1.94	1 1/16	5.0	5.4	3.3
12 S50X	3/4	3/4	1 1/16 - 12	1.66	1.94	1 1/16	5.0	5.4	3.3
12-12-16 S50X	3/4	3/4	1 5/16 - 12	1.76	2.05	1 5/16	4.0	3.0	2.6
16 S50X	1	1	1 5/16 - 12	1.81	2.05	1 5/16	4.0	3.0	2.6
20 S50X	1 1/4	1 1/4	1 5/8 - 12	2.06	2.25	1 5/8	3.0	2.5	2.0
24 S50X	1 1/2	1 1/2	1 7/8 - 12	2.33	2.39	1 7/8	3.0	2.0	1.5
32 S50X	2	2	2 1/2 - 12	3.06	2.89	2 1/2	2.0	1.5	1.3

## R50X

Straight Thread Run Tee  
37° Flare / SAE-ORB /  
37° Flare

SAE 070428  
HPD Base # 053T

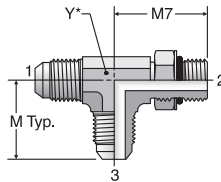

Y\* – Across wrench flats

TUBE FITTING PART #	END SIZE			M (in.)	M7 (in.)	Y (in.)	Dynamic Pressure (x 1,000 PSI)		
	1 (in.)	2 UN/UNF-2A	3 (in.)				-S	-SS	-B
	4 R50X	1/4	7/16 - 20				1/4	0.89	1.03
4-6-4 R50X	1/4	9/16 - 18	1/4	1.05	1.25	9/16	6.0	5.4	3.3
5 R50X	5/16	1/2 - 20	5/16	0.97	1.13	9/16	6.0	5.4	3.3
6 R50X	3/8	9/16 - 18	3/8	1.06	1.25	9/16	6.0	5.4	3.3
6-8-6 R50X	3/8	3/4 - 16	3/8	1.14	1.45	3/4	6.0	5.4	3.3
8 R50X	1/2	3/4 - 16	1/2	1.25	1.45	3/4	6.0	5.4	3.3
8-6-8 R50X	1/2	9/16 - 18	1/2	1.25	1.33	3/4	6.0	5.4	3.3
8-10-8 R50X	1/2	7/8 - 14	1/2	1.33	1.70	7/8	5.0	5.4	3.3
8-12-8 R50X	1/2	1 1/16 - 12	1/2	1.42	1.94	1 1/16	5.0	5.4	3.3
10 R50X	5/8	7/8 - 14	5/8	1.45	1.70	7/8	5.0	5.4	3.3
10-12-10 R50X	5/8	1 1/16 - 12	5/8	1.53	1.94	1 1/16	5.0	5.4	3.3
12 R50X	3/4	1 1/16 - 12	3/4	1.66	1.94	1 1/16	5.0	5.4	3.3
12-16-12 R50X	3/4	1 5/16 - 12	3/4	1.76	2.05	1 5/16	4.0	3.0	2.6
16 R50X	1	1 5/16 - 12	1	1.81	2.05	1 5/16	4.0	3.0	2.6
20 R50X	1 1/4	1 5/8 - 12	1 1/4	2.06	2.25	1 5/8	3.0	2.5	2.0
24 R50X	1 1/2	1 7/8 - 12	1 1/2	2.33	2.39	1 7/8	3.0	2.0	1.5
32 R50X	2	2 1/2 - 12	2	3.06	2.89	2 1/2	2.0	1.5	1.3

B

TABLE OF CONTENTS

VISUAL INDEX

FAQs

ASSEMBLY

TUBE FAB EQUIP

GEN TECH

Click here for CADs, Support Resources or to Configure Parts Online

## STX

Male Branch Tee  
37° Flare / 37° Flare / NPTF

SAE 070425  
HPD Base # 213T

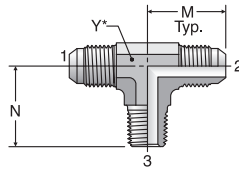

Y\* – Across wrench flats

TUBE FITTING PART #	END SIZE		M (in.)	N (in.)	Y (in.)	Dynamic Pressure (x 1,000 PSI)		
	1 & 2 (in.)	3 NPTF				-S	-SS	-B
3 STX	3/16	1/8 - 27	0.83	0.72	7/16	6.0	6.0	3.3
4 STX	1/4	1/8 - 27	0.89	0.78	7/16	6.0	6.0	3.3
4-4-4 STX	1/4	1/4 - 18	1.05	1.09	9/16	6.0	6.0	3.3
4-4-6 STX	1/4	3/8 - 18	1.12	1.22	3/4	6.0	6.0	3.3
5 STX	5/16	1/8 - 27	0.95	0.78	9/16	6.0	6.0	3.3
5-5-4 STX	5/16	1/4 - 18	1.05	1.09	9/16	6.0	6.0	3.3
6 STX	3/8	1/4 - 18	1.06	1.09	9/16	6.0	6.0	3.3
6-6-6 STX	3/8	3/8 - 18	1.14	1.22	3/4	6.0	6.0	3.3
8 STX	1/2	3/8 - 18	1.25	1.22	3/4	6.0	6.0	3.3
8-8-8 STX	1/2	1/2 - 14	1.33	1.47	7/8	6.0	6.0	3.3
10 STX	5/8	1/2 - 14	1.45	1.47	7/8	5.0	5.0	3.3
12 STX	3/4	3/4 - 14	1.66	1.59	1 1/16	4.0	4.0	2.6
14 STX	7/8	3/4 - 14	1.80	1.69	1 5/16	4.0	4.0	2.3
16 STX	1	1 - 11 1/2	1.81	1.97	1 5/16	3.0	3.0	2.0
20 STX	1 1/4	1 1/4 - 11 1/2	2.06	2.38	1 5/8	2.5	2.5	1.6
24 STX	1 1/2	1 1/2 - 11 1/2	2.33	2.64	1 7/8	2.5	2.5	1.6

**WARNING:** This product can expose you to chemicals including Lead and Lead Compounds which is known to the State of California to cause cancer and birth defects or other reproductive harm. For more information go to [www.p65warnings.ca.gov](http://www.p65warnings.ca.gov).

## RTX

Male Run Tee  
37° Flare / NPTF / 37° Flare

SAE 070424  
HPD Base # 013T

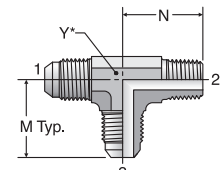

Y\* – Across wrench flats

TUBE FITTING PART #	END SIZE		M (in.)	N (in.)	Y (in.)	Dynamic Pressure (x 1,000 PSI)		
	1 & 3 (in.)	2 NPTF				-S	-SS	-B
3 RTX	3/16	1/8 - 27	0.83	0.72	7/16	6.0	6.0	3.3
4 RTX	1/4	1/8 - 27	0.89	0.78	7/16	6.0	6.0	3.3
4-4-4 RTX	1/4	1/4 - 18	1.05	1.09	9/16	6.0	6.0	3.3
5 RTX	5/16	1/8 - 27	0.95	0.78	9/16	6.0	6.0	3.3
5-4-5 RTX	5/16	1/4 - 18	1.05	1.09	9/16	6.0	6.0	3.3
6 RTX	3/8	1/4 - 18	1.06	1.09	9/16	6.0	6.0	3.3
6-6-6 RTX	3/8	3/8 - 18	1.14	1.22	3/4	6.0	6.0	3.3
8 RTX	1/2	3/8 - 18	1.25	1.22	3/4	6.0	6.0	3.3
8-8-8 RTX	1/2	1/2 - 14	1.33	1.47	7/8	6.0	6.0	3.3
10 RTX	5/8	1/2 - 14	1.45	1.47	7/8	5.0	5.0	3.3
12 RTX	3/4	3/4 - 14	1.66	1.59	1 1/16	4.0	4.0	2.6
12-8-12 RTX	3/4	1/2 - 14	1.66	1.59	1 1/16	5.0	5.0	2.9
14 RTX	7/8	3/4 - 14	1.80	1.69	1 5/16	4.0	4.0	2.3
16 RTX	1	1 - 11 1/2	1.81	1.97	1 5/16	3.0	3.0	2.0
20 RTX	1 1/4	1 1/4 - 11 1/2	2.06	2.38	1 5/8	2.5	2.5	1.6
24 RTX	1 1/2	1 1/2 - 11 1/2	2.33	2.64	1 7/8	2.5	2.5	1.6

**WARNING:** This product can expose you to chemicals including Lead and Lead Compounds which is known to the State of California to cause cancer and birth defects or other reproductive harm. For more information go to [www.p65warnings.ca.gov](http://www.p65warnings.ca.gov).

## OTX

Female Branch Tee  
37° Flare / 37° Flare / NPTF

SAE 070427  
HPD Base # 223T

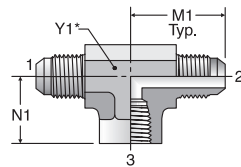

Y1\* – Across wrench flats

TUBE FITTING PART #	END SIZE		M1 (in.)	N1 (in.)	Y1 (in.)	Dynamic Pressure (x 1,000 PSI)		
	1 & 2 (in.)	3 NPTF				-S	-SS	-B
4 OTX	1/4	1/8 - 27	1.08	0.66	9/16	5.0	5.0	3.3
4-4-4 OTX	1/4	1/4 - 18	1.13	0.88	3/4	5.0	5.0	3.3
5 OTX	5/16	1/8 - 27	1.08	0.66	9/16	5.0	5.0	3.3
6 OTX	3/8	1/4 - 18	1.23	0.88	3/4	5.0	5.0	3.3
6-6-6 OTX	3/8	3/8 - 18	1.23	1.02	7/8	4.5	4.5	2.9
8 OTX	1/2	3/8 - 18	1.42	1.02	7/8	4.5	4.5	2.9
8-8-8 OTX	1/2	1/2 - 14	1.42	1.23	1 1/16	3.0	3.0	2.0
10 OTX	5/8	1/2 - 14	1.64	1.23	1 1/16	3.0	3.0	2.0
12 OTX	3/4	3/4 - 14	1.89	1.36	1 5/16	3.0	3.0	2.0
14 OTX	7/8	3/4 - 14	1.86	1.42	1 5/16	3.0	3.0	2.0
16 OTX	1	1 - 11 1/2	2.17	1.62	1 5/8	1.8	1.8	1.2
20 OTX	1 1/4	1 1/4 - 11 1/2	2.33	1.70	1 7/8	1.5	1.5	1.0
24 OTX	1 1/2	1 1/2 - 11 1/2	2.89	2.08	2 1/2	1.5	1.5	1.0

**WARNING:** This product can expose you to chemicals including Lead and Lead Compounds which is known to the State of California to cause cancer and birth defects or other reproductive harm. For more information go to [www.p65warnings.ca.gov](http://www.p65warnings.ca.gov).

## MTX

Female Run Tee  
37° Flare / NPTF / 37° Flare

SAE 070426  
HPD Base # 023T

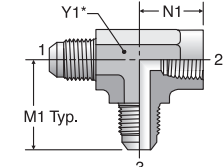

Y1\* – Across wrench flats

TUBE FITTING PART #	END SIZE		M1 (in.)	N1 (in.)	Y1 (in.)	Dynamic Pressure (x 1,000 PSI)		
	1 & 3 (in.)	2 NPTF				-S	-SS	-B
4 MTX	1/4	1/8 - 27	1.08	0.66	9/16	5.0	5.0	3.3
4-4-4 MTX	1/4	1/4 - 18	1.13	0.88	3/4	5.0	5.0	3.3
6 MTX	3/8	1/4 - 18	1.23	0.88	3/4	5.0	5.0	3.3
8 MTX	1/2	3/8 - 18	1.42	1.02	7/8	4.5	4.5	2.9
8-8-8 MTX	1/2	1/2 - 14	1.42	1.23	1 1/16	3.0	3.0	2.0
10 MTX	5/8	1/2 - 14	1.64	1.23	1 1/16	3.0	3.0	2.0
12 MTX	3/4	3/4 - 14	1.89	1.36	1 5/16	3.0	3.0	2.0
14 MTX	7/8	3/4 - 14	1.86	1.42	1 5/16	3.0	3.0	2.0
16 MTX	1	1 - 11 1/2	2.17	1.62	1 5/8	1.8	1.8	1.2
20 MTX	1 1/4	1 1/4 - 11 1/2	2.33	1.70	1 7/8	1.5	1.5	1.0
24 MTX	1 1/2	1 1/2 - 11 1/2	2.89	2.08	2 1/2	1.5	1.5	1.0

**WARNING:** This product can expose you to chemicals including Lead and Lead Compounds which is known to the State of California to cause cancer and birth defects or other reproductive harm. For more information go to [www.p65warnings.ca.gov](http://www.p65warnings.ca.gov).

TABLE OF CONTENTS

VISUAL INDEX

FAQs

ASSEMBLY

TUBE FAB EQUIP

GEN TECH

[Click here for CADs, Support Resources or to Configure Parts Online](#)

# S870MX

ISO 6149 Branch Tee  
37° Flare / 37° Flare / ISO 6149  
SAE 070489

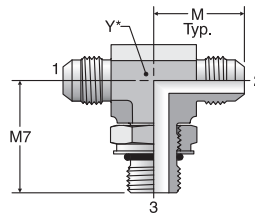

Y\* – Across wrench flats

TUBE FITTING PART #	END SIZE			M (mm)	M7 (mm)	Y (mm)	Dynamic Pressure (x 1,000 PSI)		
	1 & 2		3				S	SS	B
	(mm)	(in.)	Male Metric Parallel Thread						
6M14S870MX	10	3/8	M14 x 1.5	26.9	33.5	14	6.0	6.0	3.3
8M16S870MX	12	1/2	M16 x 1.5	31.8	38.0	19	5.0	5.0	3.3
10M22S870MX	14,15,16	5/8	M22 x 1.5	36.8	42.5	22	5.0	5.0	3.3
12M27S870MX	18,20	3/4	M27 x 2	42.2	51.0	27	5.0	5.0	3.3

**WARNING:** This product can expose you to chemicals including Lead and Lead Compounds which is known to the State of California to cause cancer and birth defects or other reproductive harm. For more information go to [www.p65warnings.ca.gov](http://www.p65warnings.ca.gov).

# R870MX

ISO 6149 Run Tee  
37° Flare / ISO 6149 / 37° Flare  
SAE 070488

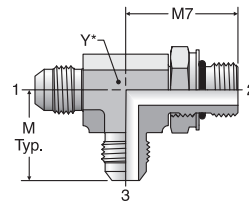

Y\* – Across wrench flats

TUBE FITTING PART #	END SIZE			M (mm)	M7 (mm)	Y (mm)	Dynamic Pressure (x 1,000 PSI)		
	1 & 3		2				S	SS	B
	(mm)	(in.)	Male Metric Parallel Thread						
6M14R870MX	10	3/8	M14 x 1.5	26.9	33.5	14	6.0	6.0	3.3
8M16R870MX	12	1/2	M16 x 1.5	31.8	38.0	19	5.0	5.0	3.3
10M22R870MX	14,15,16	5/8	M22 x 1.5	36.8	42.5	22	5.0	5.0	3.3
12M27R870MX	18, 20	3/4	M27 x 1.5	42.2	51.0	27	5.0	5.0	3.3

# S40MX

Male Branch Tee – BSPP  
37° Flare / 37° Flare /  
BSPP-ORR

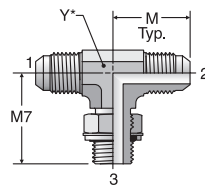

Y\* – Across wrench flats

TUBE FITTING PART #	END SIZE			M (mm)	M7 (mm)	Y (mm)	Dynamic Pressure (x 1,000 PSI)		
	1 & 2		3				S	SS	B
	(mm)	(in.)	BSPP						
4S40MX	6	1/4	1/8 - 28	22.6	26.5	11	3.6	3.6	2.3
6S40MX	10	3/8	1/4 - 19	26.9	32.0	14	3.6	2.9	1.9
8S40MX	12	1/2	3/8 - 19	31.8	37.0	19	3.6	2.9	1.9
10S40MX	14,15,16	5/8	1/2 - 14	36.8	43.0	22	3.6	2.9	1.9
12S40MX	18,20	3/4	3/4 - 14	42.2	49.5	27	3.6	2.9	1.9
16S40MX	25	1	1 - 11	46.0	52.0	33	3.6	2.9	1.9

**WARNING:** This product can expose you to chemicals including Lead and Lead Compounds which is known to the State of California to cause cancer and birth defects or other reproductive harm. For more information go to [www.p65warnings.ca.gov](http://www.p65warnings.ca.gov).

# R40MX

Male Run Tee – BSPP  
37° Flare / BSPP-ORR /  
37° Flare

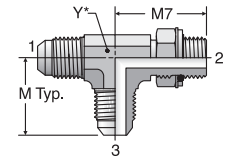

Y\* – Across wrench flats

TUBE FITTING PART #	END SIZE			M (mm)	M7 (mm)	Y (mm)	Dynamic Pressure (x 1,000 PSI)		
	1 & 3		2				S	SS	B
	(mm)	(in.)	BSPP						
4R40MX	6	1/4	1/8 - 28	22.6	26.5	11	3.6	3.6	2.3
6R40MX	10	3/8	1/4 - 19	26.6	32.0	14	3.6	2.9	1.9
8R40MX	12	1/2	3/8 - 19	31.8	36.8	19	3.6	2.9	1.9
10R40MX	14,15,16	5/8	1/2 - 14	36.8	43.0	22	3.6	2.9	1.9
12R40MX	18,20	3/4	3/4 - 14	42.2	49.5	27	3.6	2.9	1.9
16R40MX	25	1	1 - 11	46.0	52.0	33	3.6	2.9	1.9
20R40MX	28, 30, 32	1 1/4	1 1/4 - 11	52.3	57.0	41	3.0	2.3	1.5

**WARNING:** This product can expose you to chemicals including Lead and Lead Compounds which is known to the State of California to cause cancer and birth defects or other reproductive harm. For more information go to [www.p65warnings.ca.gov](http://www.p65warnings.ca.gov).

B

TABLE OF CONTENTS

VISUAL INDEX

FAQs

ASSEMBLY

TUBE FAB EQUIP

GEN TECH



Click here for CADs, Support Resources or to Configure Parts Online

## KTX

Union Cross  
37° Flare (all four ends)

SAE 070501  
HPD Base # 033X

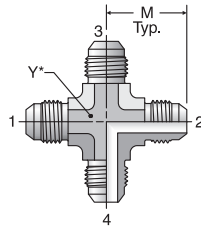

Y\* – Across wrench flats

TUBE FITTING PART #	END SIZE 1-4 (in.)	M (in.)	Y (in.)	Dynamic Pressure (x 1,000 PSI)		
				-S	-SS	-B
4 KTX	1/4	0.89	7/16	7.5	7.7	3.3
5 KTX	5/16	0.95	9/16	6.0	6.0	3.3
6 KTX	3/8	1.06	9/16	6.0	6.0	3.3
8 KTX	1/2	1.25	3/4	6.0	6.0	3.3
10 KTX	5/8	1.45	7/8	5.0	5.0	3.3
12 KTX	3/4	1.66	1 1/16	5.0	5.0	2.9
16 KTX	1	1.81	1 5/16	4.0	3.5	2.3

**WARNING:** This product can expose you to chemicals including Lead and Lead Compounds which is known to the State of California to cause cancer and birth defects or other reproductive harm. For more information go to [www.p65warnings.ca.gov](http://www.p65warnings.ca.gov).

## PNTX

Plug  
37° Flare

SAE 070109  
HPD Base # 03CP

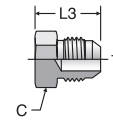

TUBE FITTING PART #	END SIZE 1 (in.)	C HEX (in.)	L3 (in.)	Dynamic Pressure (x 1,000 PSI)		
				-S	-SS	-B
2 PNTX	1/8	7/16	0.70	7.5	9	3.3
3 PNTX	3/16	7/16	0.73	7.5	9	3.3
4 PNTX	1/4	1/2	0.80	7.5	9	3.3
5 PNTX	5/16	9/16	0.80	6.0	7.2	3.3
6 PNTX	3/8	5/8	0.84	6.0	7.2	3.3
8 PNTX	1/2	13/16	0.94	6.0	7.2	3.3
10 PNTX	5/8	15/16	1.10	5.0	6.0	3.3
12 PNTX	3/4	1 1/8	1.28	5.0	6.0	3.3
14 PNTX	7/8	1 1/4	1.31	5.0	5.0	3.3
16 PNTX	1	1 3/8	1.33	4.5	5.4	2.9
20 PNTX	1 1/4	1 11/16	1.45	4.0	4.8	2.6
24 PNTX	1 1/2	2	1.65	4.0	4.8	2.6
32 PNTX	2	2 5/8	2.05	2.0	2.4	1.3

**WARNING:** This product can expose you to chemicals including Lead and Lead Compounds which is known to the State of California to cause cancer and birth defects or other reproductive harm. For more information go to [www.p65warnings.ca.gov](http://www.p65warnings.ca.gov).

## FNTX

Cap  
37° Flare

SAE 070112A  
HPD Base # 06CP

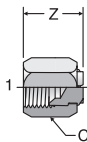

TUBE FITTING PART #	END SIZE 1 (in.)	C HEX (in.)	Z (in.)	Dynamic Pressure (x 1,000 PSI)		
				-S	-SS	-B
2 FNTX	1/8	3/8	0.60	7.5	9.0	3.3
3 FNTX	3/16	7/16	0.66	7.5	9.0	3.3
4 FNTX	1/4	9/16	0.67	7.5	9.0	3.3
5 FNTX	5/16	5/8	0.77	6.0	7.2	3.3
6 FNTX	3/8	11/16	0.81	6.0	7.2	3.3
8 FNTX	1/2	7/8	0.94	6.0	7.2	3.3
10 FNTX	5/8	1	1.07	5.0	6.0	3.3
12 FNTX	3/4	1 1/4	1.24	5.0	6.0	3.3
14 FNTX	7/8	1 3/8	1.26	5.0	6.0	3.3
16 FNTX	1	1 1/2	1.29	4.5	5.4	2.9
20 FNTX	1 1/4	2	1.39	4.0	4.8	2.6
24 FNTX	1 1/2	2 1/4	1.70	3.0	3.6	2.0
32 FNTX	2	2 7/8	2.01	2.0	2.4	1.3

**WARNING:** This product can expose you to chemicals including Lead and Lead Compounds which is known to the State of California to cause cancer and birth defects or other reproductive harm. For more information go to [www.p65warnings.ca.gov](http://www.p65warnings.ca.gov).

## T22X

Mountie Cap

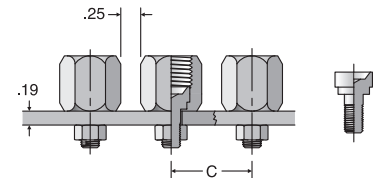

TUBE FITTING PART #	END SIZE		C (in.)	L (in.)	Dynamic Pressure (x 1,000 PSI)		
	1 (in.)	2 UNC/UNF-2A			-S	-SS	-B
4 T22X	1/4	1/4 - 20	0.91	0.72	7.5	9.0	3.3
6 T22X	3/8	1/4 - 20	1.08	0.81	6.0	7.2	3.3
8 T22X	1/2	5/16 - 18	1.25	0.97	6.0	7.2	3.3

**WARNING:** This product can expose you to chemicals including Lead and Lead Compounds which is known to the State of California to cause cancer and birth defects or other reproductive harm. For more information go to [www.p65warnings.ca.gov](http://www.p65warnings.ca.gov).

TABLE OF CONTENTS

VISUAL INDEX

FAQs

ASSEMBLY

TUBE FAB EQUIP

GEN TECH

[Click here for CADs, Support Resources or to Configure Parts Online](#)

## HTXO

Union  
37° Flare

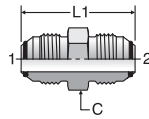

TUBE FITTING PART #	END SIZE		C HEX (in.)	L1 (in.)	Dynamic Pressure (x 1,000 PSI) -SS
	1 & 2 (in.)				
4 HTXO	1/4	1/2	1.39	9.0	
6 HTXO	3/8	5/8	1.42	7.7	
8 HTXO	1/2	13/16	1.66	7.7	
10 HTXO	5/8	15/16	1.98	6.0	
12 HTXO	3/4	1 1/8	2.24	6.0	
16 HTXO	1	1 3/8	2.41	5.4	
20 HTXO	1 1/4	1 11/16	2.58	5.0	
24 HTXO	1 1/2	2	2.90	5.0	

## F5OXO

Straight Thread Connector  
37° Flare / SAE-ORB

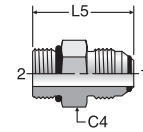

TUBE FITTING PART #	END SIZE		C4 HEX (in.)	L5 (in.)	Dynamic Pressure (x 1,000 PSI) -SS
	1 (in.)	2 UN/UNF-2A			
4 F5OXO	1/4	7/16 - 20	9/16	1.23	9.0
4-6 F5OXO	1/4	9/16 - 18	11/16	1.28	7.7
6 F5OXO	3/8	9/16 - 18	11/16	1.30	7.7
6-4 F5OXO	3/8	7/16 - 20	5/8	1.27	7.7
6-8 F5OXO	3/8	3/4 - 16	7/8	1.38	7.7
8 F5OXO	1/2	3/4 - 16	7/8	1.48	7.7
8-6 F5OXO	1/2	9/16 - 18	13/16	1.44	7.7
10 F5OXO	5/8	7/8 - 14	1	1.75	6.0
12 F5OXO	3/4	1 1/16 - 12	1 1/4	1.97	6.0
16 F5OXO	1	1 5/16 - 12	1 1/2	2.05	5.4
20 F5OXO	1 1/4	1 5/8 - 12	1 7/8	2.17	5.0
24 F5OXO	1 1/2	1 7/8 - 12	2 1/8	2.37	4.0
32 F5OXO	2	2 1/2 - 12	2 3/4	2.78	2.4

## FTXO

Male Connector  
37° Flare / NPTF

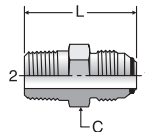

TUBE FITTING PART #	END SIZE		C HEX (in.)	L (in.)	Dynamic Pressure (x 1,000 PSI) -SS
	1 (in.)	2 NPTF			
4 FTXO	1/4	1/8 - 27	1/2	1.23	6.0
4-4 FTXO	1/4	1/4 - 18	9/16	1.43	6.0
6 FTXO	3/8	1/4 - 18	5/8	1.45	6.0
6-6 FTXO	3/8	3/8 - 18	3/4	1.46	6.0
8 FTXO	1/2	3/8 - 18	13/16	1.53	6.0
8-8 FTXO	1/2	1/2 - 14	7/8	1.78	6.0
10 FTXO	5/8	1/2 - 14	15/16	1.94	5.0
12 FTXO	3/4	3/4 - 14	1 1/8	2.10	5.0
16 FTXO	1	1 - 11 1/2	1 3/8	2.38	4.5
20 FTXO	1 1/4	1 1/4 - 11 1/2	1 11/16	2.52	3.0
24 FTXO	1 1/2	1 1/2 - 11 1/2	2	2.76	3.0
32 FTXO	2	2 - 11 1/2	2 5/8	3.18	2.0

## GTXO

Female Connector  
37° Flare / NPTF

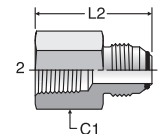

TUBE FITTING PART #	END SIZE		C1 HEX (in.)	L2 (in.)	Dynamic Pressure (x 1,000 PSI) -SS
	1 (in.)	2 NPTF			
4 GTXO	1/4	1/8 - 27	9/16	1.20	6.0
6 GTXO	3/8	1/4 - 18	3/4	1.41	6.0
8 GTXO	1/2	3/8 - 18	7/8	1.58	6.0
10 GTXO	5/8	1/2 - 14	1 1/8	1.94	5.0
12 GTXO	3/4	3/4 - 14	1 3/8	2.10	4.8
16 GTXO	1	1 - 11 1/2	1 5/8	2.43	3.6
20 GTXO	1 1/4	1 1/4 - 11 1/2	2	2.56	3.0
24 GTXO	1 1/2	1 1/2 - 11 1/2	2 3/8	2.70	2.4

B

TABLE OF CONTENTS

VISUAL INDEX

FAQs

ASSEMBLY

TUBE FAB EQUIP

GEN TECH

[Click here for CADs, Support Resources or to Configure Parts Online](#)

## ETXO

Union Elbow  
37° Flare / 37° Flare

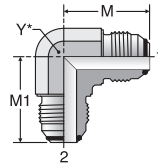

TUBE FITTING PART #	END SIZE 1 & 2 (in.)	M (in.)	M1 (in.)	Y (in.)	Dynamic Pressure (x 1,000 PSI)
					-SS
4 ETXO	1/4	0.90	0.90	7/16	7.7
6 ETXO	3/8	1.08	1.08	9/16	6.0
8 ETXO	1/2	1.25	1.25	3/4	6.0
10 ETXO	5/8	1.50	1.50	7/8	5.0
12 ETXO	3/4	1.70	1.70	1 1/16	5.0
16 ETXO	1	1.89	1.89	1 5/16	5.0
20 ETXO	1 1/4	2.13	2.13	1 5/8	5.0
24 ETXO	1 1/2	2.33	2.33	1 7/8	5.0

## C6XO

Swivel Nut Elbow  
37° Flare / 37° Swivel

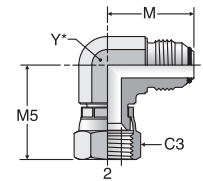

TUBE FITTING PART #	END SIZE 1 & 2 (in.)	C3 HEX (in.)	M (in.)	M5 (in.)	M10 (in.)	Y (in.)	Dynamic Pressure (x 1,000 PSI)
							-SS
4 C6XO	1/4	9/16	0.90	1.00	0.66	7/16	7.7
6 C6XO	3/8	11/16	1.08	1.25	0.88	9/16	6.0
8 C6XO	1/2	7/8	1.25	1.38	0.95	3/4	6.0
10 C6XO	5/8	1	1.50	1.62	1.13	7/8	5.0
12 C6XO	3/4	1 1/4	1.70	1.75	1.19	1 1/16	5.0
16 C6XO	1	1 1/2	1.89	2.00	1.41	1 5/16	2.5
20 C6XO	1 1/4	2	2.13	2.31	1.69	1 5/8	2.5

## CTXO

Male Elbow  
37° Flare / NPTF

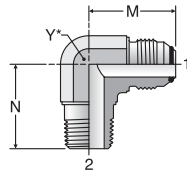

TUBE FITTING PART #	END SIZE		M (in.)	N (in.)	Y (in.)	Dynamic Pressure (x 1,000 PSI)
	1 (in.)	2 NPTF				-SS
4 CTXO	1/4	1/8 - 27	0.90	0.78	7/16	6.0
4-4 CTXO	1/4	1/4 - 18	1.06	1.09	9/16	6.0
6 CTXO	3/8	1/4 - 18	1.08	1.09	9/16	6.0
6-6 CTXO	3/8	3/8 - 18	1.16	1.22	3/4	6.0
8 CTXO	1/2	3/8 - 18	1.25	1.22	3/4	6.0
8-8 CTXO	1/2	1/2 - 14	1.33	1.47	7/8	6.0
10 CTXO	5/8	1/2 - 14	1.51	1.47	7/8	5.0
12 CTXO	3/4	3/4 - 14	1.70	1.59	1 1/16	4.0
16 CTXO	1	1 - 11 1/2	1.89	1.97	1 5/16	3.0
20 CTXO	1 1/4	1 1/4 - 11 1/2	2.13	2.38	1 5/8	2.5
24 CTXO	1 1/2	1 1/2 - 11 1/2	2.41	2.64	1 7/8	2.5
32 CTXO	2	2 - 11 1/2	3.13	3.00	2 1/2	2.0

## C5OXO

Straight Thread Elbow  
37° Flare / SAE-ORB

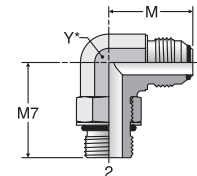

TUBE FITTING PART #	END SIZE		M (in.)	M7 (in.)	Y (in.)	Dynamic Pressure (x 1,000 PSI)
	1 (in.)	2 UN/UNF-2A				-SS
4 C5OXO	1/4	7/16 - 20	0.90	1.03	7/16	6.0
6 C5OXO	3/8	9/16 - 18	1.08	1.25	9/16	5.4
8 C5OXO	1/2	3/4 - 16	1.25	1.45	3/4	5.4
10 C5OXO	5/8	7/8 - 14	1.50	1.70	7/8	5.4
12 C5OXO	3/4	1 1/16 - 12	1.70	1.94	1 1/16	5.4
16 C5OXO	1	1 5/16 - 12	1.89	2.05	1 5/16	3.7
20 C5OXO	1 1/4	1 5/8 - 12	2.13	2.25	1 5/8	2.8
24 C5OXO	1 1/2	1 7/8 - 12	2.41	2.39	1 7/8	2.5
32 C5OXO	2	2 1/2 - 12	3.13	2.89	2 1/2	1.5

TABLE OF CONTENTS

VISUAL INDEX

FAQs

ASSEMBLY

TUBE FAB EQUIP

GEN TECH

[Click here for CADs, Support Resources or to Configure Parts Online](#)

## JTXO

Union Tee  
37° Flare (all three ends)

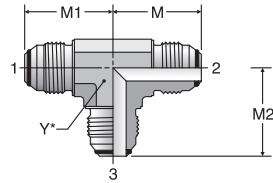

TUBE FITTING PART #	END SIZE		M (in.)	M1 (in.)	M2 (in.)	Y (in.)	Dynamic Pressure (x 1,000 PSI) -SS
	1 - 3 (in.)						
4 JTXO	1/4		0.90	0.90	0.90	7/16	7.7
6 JTXO	3/8		1.08	1.08	1.08	9/16	6.0
8 JTXO	1/2		1.25	1.25	1.25	3/4	6.0
10 JTXO	5/8		1.50	1.50	1.50	7/8	5.0
12 JTXO	3/4		1.70	1.70	1.70	1 1/16	5.0
16 JTXO	1		1.89	1.89	1.89	1 5/16	5.0
20 JTXO	1 1/4		2.13	2.13	2.13	1 5/8	5.0
24 JTXO	1 1/2		2.41	2.41	2.41	1 7/8	5.0

## RTXO

Male Run Tee  
37° Flare / NPTF / 37° Flare

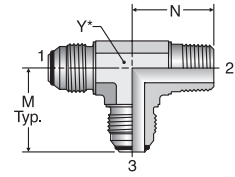

TUBE FITTING PART #	END SIZE		M (in.)	N (in.)	Y (in.)	Dynamic Pressure (x 1,000 PSI) -SS
	1 & 3 (in.)	2 NPTF				
4 RTXO	1/4	1/8 - 27	0.90	0.78	7/16	6.0
6 RTXO	3/8	1/4 - 18	1.08	1.09	9/16	6.0
8 RTXO	1/2	3/8 - 18	1.25	1.22	3/4	6.0
10 RTXO	5/8	1/2 - 14	1.51	1.47	7/8	5.0
12 RTXO	3/4	3/4 - 14	1.70	1.59	1 1/16	4.0
16 RTXO	1	1 - 11 1/2	1.89	1.97	1 5/16	3.0
20 RTXO	1 1/4	1 1/4 - 11 1/2	2.13	2.38	1 5/8	2.5
24 RTXO	1 1/2	1 1/2 - 11 1/2	2.41	2.64	1 7/8	2.5

## R5OXO

Straight Thread Run Tee  
37° Flare / SAE-ORB / 37° Flare

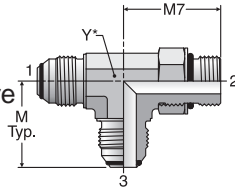

TUBE FITTING PART #	END SIZE		M (in.)	M7 (in.)	Y (in.)	Dynamic Pressure (x 1,000 PSI) -SS
	1 (in.)	2 UN/UNF-2A				
4 R5OXO	1/4	7/16 - 20	0.90	1.03	7/16	6.0
6 R5OXO	3/8	9/16 - 18	1.08	1.25	9/16	5.4
8 R5OXO	1/2	3/4 - 16	1.25	1.45	3/4	5.4
10 R5OXO	5/8	7/8 - 14	1.51	1.70	7/8	5.4
12 R5OXO	3/4	1 1/16 - 12	1.70	1.94	1 1/16	5.4
16 R5OXO	1	1 5/16 - 12	1.89	2.05	1 5/16	3.7
20 R5OXO	1 1/4	1 5/8 - 12	2.13	2.25	1 5/8	2.8

B

TABLE OF CONTENTS

VISUAL INDEX

FAQs

ASSEMBLY

TUBE FAB EQUIP

GEN TECH

[Click here for CADs, Support Resources or to Configure Parts Online](#)

TABLE  
OF  
CONTENTS

VISUAL  
INDEX

FAQs

ASSEMBLY

TUBE FAB  
EQUIP

GEN TECH



C

# FERULOK<sup>®</sup>

## Flareless Bite Type Fittings















<p><b>Nuts, Ferrules, Locknuts</b></p>	<p><b>BU</b> Nut</p>  <p>C7</p>	<p><b>TU</b> Ferrules</p>  <p>C7</p>	<p><b>WLN</b> Bulkhead Locknut</p>  <p>C7</p>	<p><b>Straights</b></p>	<p><b>HBU</b> Union</p>  <p>C7</p>
<p><b>WBU</b> Bulkhead Union</p>  <p>C8</p>	<p><b>F5BU</b> SAE-ORB / Flareless</p>  <p>C8</p>	<p><b>FBU</b> NPTF / Flareless</p>  <p>C8</p>	<p><b>GBU</b> NPTF / Flareless</p>  <p>C9</p>	<p><b>TRBU</b> Tube End Reducer</p>  <p>C9</p>	
<p><b>45° Elbows</b></p>	<p><b>V5BU</b> SAE-ORB / Flareless</p>  <p>C9</p>	<p><b>VBU</b> NPTF / Flareless</p>  <p>C9</p>	<p><b>90° Elbows</b></p>	<p><b>EBU</b> Union Elbow</p>  <p>C10</p>	<p><b>WEBU</b> Bulkhead Union Elbow</p>  <p>C10</p>
<p><b>C6BU</b> Flareless Swivel/Flareless</p>  <p>C10</p>	<p><b>C5BU</b> SAE-ORB / Flareless</p>  <p>C10</p>	<p><b>CC5BU</b> SAE-ORB / Flareless</p>  <p>C11</p>	<p><b>CBU</b> NPTF / Flareless</p>  <p>C11</p>	<p><b>DBU</b> NPTF / Flareless</p>  <p>C11</p>	
<p><b>Tees</b></p>	<p><b>JBU</b> Union Tee</p>  <p>C12</p>	<p><b>S6BU</b> Swivel Branch Tee</p>  <p>C12</p>	<p><b>R6BU</b> Swivel Run Tee</p>  <p>C12</p>	<p><b>S5BU</b> SAE-ORB Branch Tee</p>  <p>C12</p>	<p><b>R5BU</b> SAE-ORB Run Tee</p>  <p>C13</p>
<p><b>SBU</b> NPTF Branch Tee</p>  <p>C13</p>	<p><b>RBU</b> NPTF Run Tee</p>  <p>C13</p>	<p><b>OBU</b> NPTF Branch Tee</p>  <p>C13</p>	<p><b>MBU</b> NPTF Run Tee</p>  <p>C14</p>	<p><b>Cross</b></p>	<p><b>KBU</b> Union Cross</p>  <p>C14</p>
<p><b>Plugs and Caps</b></p>	<p><b>PNU</b> Plug</p>  <p>C14</p>	<p><b>FNU</b> Cap</p>  <p>C14</p>			

TABLE OF CONTENTS

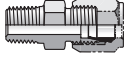
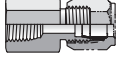
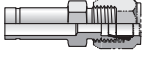

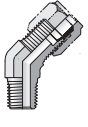
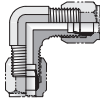
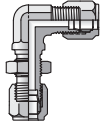
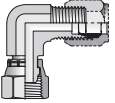
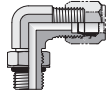
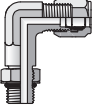
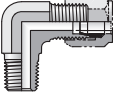
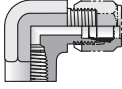
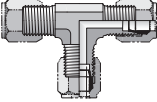
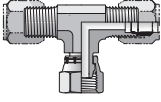
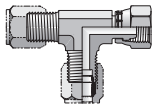
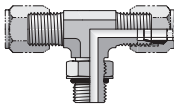
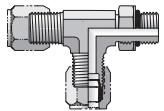
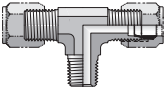
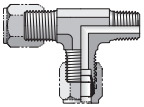
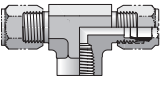
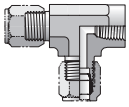
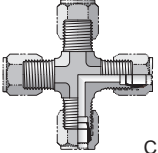
Dimensions and pressures for reference only, subject to change.

### Conversion Adapters (Shown in Section J)

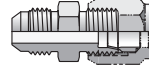
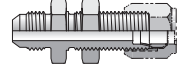
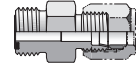
 <p>Conversion Adapters</p>	<p><b>XHBU</b>                      37° Flare / Flareless</p>  <p>J4</p>	<p><b>XHBU2</b>                      37° / Flareless Bulkhead</p>  <p>J4</p>	<p><b>BUHLO</b>                      ORFS / 24° Flareless</p>  <p>J4</p>
--	---	---	---

**C**  
**TABLE OF CONTENTS**

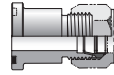
### Flange Adapters (Shown in Section K)

 <p>Flange Adapters</p>	<p><b>BUHQ1</b>                      Code 61 / Flareless</p>  <p>K12</p>	<p><b>BUVQ1</b>                      Code 61 / Flareless</p>  <p>K32</p>	<p><b>BUEQ1</b>                      Code 61 / Flareless</p>  <p>K33</p>
--	---	---	---

### O-Rings and Seals (Shown in Section M)

 <p>O-Rings</p>	<p><b>SAE O-Ring</b></p>  <p>M4</p>
--	--

Dimensions and pressures for reference only, subject to change.

[Click here for CADs, Support Resources or to Configure Parts Online](#)

## Introduction

The Ferulok fitting design and performance capabilities far exceed the strict requirements of SAE J514. The Ferulok fitting is a flareless fitting that consists of a body, a one-piece ferrule, and a nut. On assembly, the ferrule “bites” into the outer surface of the tube with sufficient strength to hold the tube against pressure and seal the fluid, without considerable distortion of the inside tube diameter. Ferulok fittings have a visible bite, allowing the fitting assembler to visually inspect the bite quality, thus significantly minimizing the risk of improper assembly and related service problems. Ferulok fittings are especially suitable for use with tube wall thickness ranging from medium to extra heavy.

## How Ferulok Fittings Work

The ferrule in the Ferulok fitting forms pressure tight seals with the tube and the fitting body. These seals are the result of several key characteristics graphically shown in Fig. C1. Below are detailed explanations of each of these key features.

- A. When properly assembled, the wedging action of the Ferulok design will cause the end of the tube to press firmly against the seat in the body. This action will cause the tube to develop a small indentation circumferentially on the bottom of the tube. This indentation serves as a good post assembly inspection criterion.
- B. As the ferrule moves forward, it contacts the tapered seat of the body, which causes the ferrule to move inward into the tube. The leading edge of the hardened ferrule makes a clean 360° cut into the outside diameter of the tube. This cut is often termed a “bite” and thus “bite type fitting”. As the ferrule makes its bite, a small ridge of material is plowed up in front of the ferrule. This intimate contact of the tube ridge with the ferrule’s front face and bite edge gives the fitting its ability to retain high pressure without leaking or blowing off. A second seal point is also created between the now bowed ferrule and the fitting body seat.
- C. As the ferrule bites into the tube, the mid section will bow and the inside diameter of the back area firmly grips the tube. This action keeps the stresses, caused by flexural and vibration loading, from being concentrated in the bite area. The “compression grip” at the back end is a key factor for long life in rigorous applications.

All Ferulok parts come with the ferrule, and nut. However, Ferulok fittings can be purchased without nuts and sleeves for use with hose crimp fittings (Fig. C2). This can be done by dropping the ‘B’ from the part number. For example, (4 CBU-S, 4 CU-S). When used with a hose crimp fitting, sealing occurs between the 24° cone of the fitting body and the hose swivel as shown.

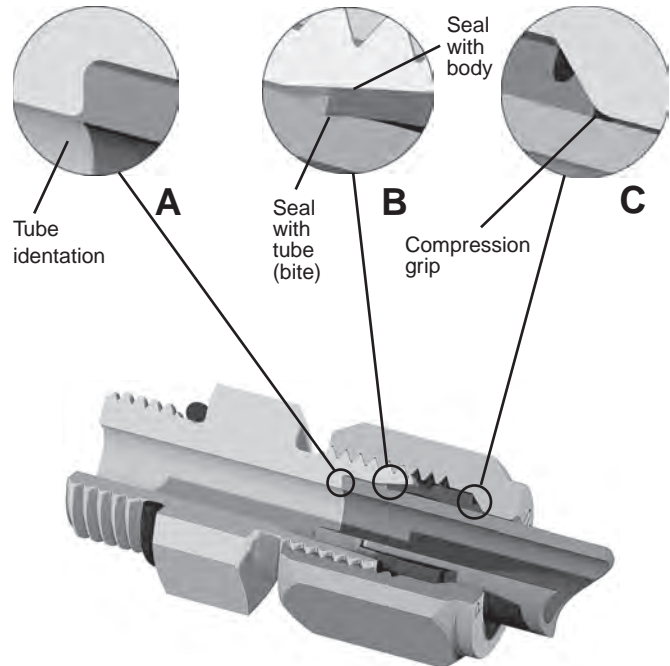

Fig. C1 – Assembled Ferulok Fitting with Tube

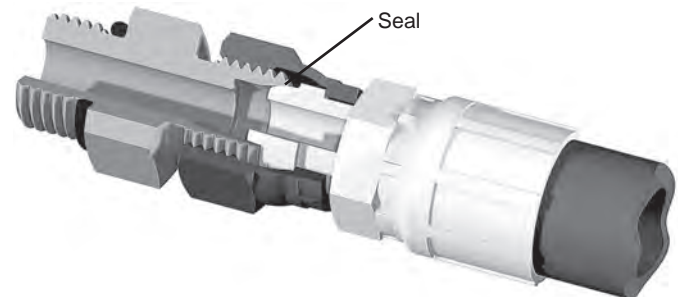

Fig. C2 – Ferulok Fitting with Hose Assembly

TABLE  
OF  
CONTENTS

VISUAL  
INDEX

Dimensions and pressures for reference only, subject to change.

[Click here for CADs, Support Resources or to Configure Parts Online](#)

## The Parker Advantage

**Robust Port Stud:** The adjustable port stud is manufactured with a longer locknut designed to cover the uppermost threads completely. Since the backup washer is never exposed to the upper threads, it cannot be damaged during assembly. During assembly, exposed upper threads, as common with fittings from other fitting manufacturers, can lead to a deformed backup washer that can pinch the o-ring and create an o-ring extrusion gap that has the potential to leak. The longer locknut also provides a greater grip area for the wrench.

**Visible bite:** The style A (SAE 080115A) ferrule design allows for an easy inspection of the bite in the tubing. A verification can quickly be achieved which reduces time and assures proper assembly. This assurance also eliminates the risk of leaks and catastrophic failures.

**Rear compression grip:** The ferrule is also designed with a rear bevel to firmly hold the nut and tubing. This enhancement dampens the effects of vibration in the connection; thus extending the life of the joint.

**Metal-to-metal sealing:** The metal to metal sealing function broadens the range of both temperatures and media types. The temperature and media range of Ferulok is not limited by an elastomeric seal, but by the range of steel and stainless steel (see page S17 of the General Technical section for material temperature and media compatibility).

**Superior Plating:** Parker's Ferulok steel fittings come standard with ToughShield (TS1000) plating, giving them unmatched protection against red rust. In ASTM B117 neutral salt spray testing, TS1000 remained rust free for up to 1,000 hours, far exceeding SAE industry requirements of 96 hours and also outperforming the competition. See [www.ravagesofredrust.com](http://www.ravagesofredrust.com) for more information.

**No special tooling required:** Neither flaring nor flanging tools are required to make a Ferulok connection. Smaller sizes of Ferulok can be assembled by a wrench thus reducing tooling costs and assembly time. However, portable presetting equipment is available for larger sizes and/or high production (see Section Q of the catalog for equipment available).

## Reference locations

**Standard Material Specifications:** Refer to Table S34 in General Technical Section page S46.

**Assembly and Installation:** Please refer to Ferulok Assembly located within the Assembly/Installation section of this catalog.

**Recommended Tube Wall Thickness:** Please refer to Table S14 located in the General Technical section.

**Dynamic Pressure Ratings:** Please refer to the last column of the part number tables located on the following pages of this section for the appropriate dynamic pressure ratings.

**Seal Material Selection:** Please refer to Table S10 in the General Technical section of this catalog for elastomeric seal information.

## Tube Recommendation

Maximum tube wall thickness is based on the pressure holding capability of Ferulok fittings. Tubes above the recommended range can be used. However, the pressure holding capability of the assembly will be limited to the fitting capacity. The proper Ferulok assembly procedures as outlined on pages R30 - R33 of this catalog are critical to the performance of the fitting. Steel Ferulok works best with seamless or welded and drawn fully annealed tube, SAE J356, SAE J524, SAE J525 (max. hardness, RB72) or equivalent specification steel tube. For stainless steel Ferulok fittings, types 304 and 316 of ASTM A269, ASTM A213 (max. hardness, RB90) or equivalent stainless steel tube is recommended.

Ferulok fittings are also suitable for use with soft metal tube and various types of plastic tubes such as nylon, polyethylene, etc. When used with plastic tube, it is strongly recommended that a tube insert, such as T23UI, be used to reduce tube collapse and prevent tube pull out due to tensile loading.

See Table T3 in Appendix on Page T6. Consult the Parker Hannifin Tube Fittings Division for other combinations of tube and tube fitting materials not shown.

C

TABLE  
OF  
CONTENTS

VISUAL  
INDEX

Dimensions and pressures for reference only, subject to change.



[Click here for CADs, Support Resources or to Configure Parts Online](#)

# Ferulok Flareless Tube Ends

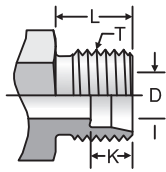

**Ferulok Male Stud Tube End**

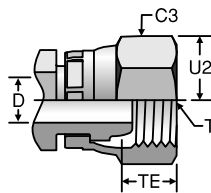

**Ferulok Female Swivel End**

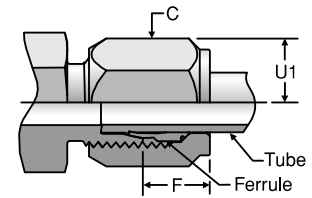

**Ferulok Tube End Assembly**

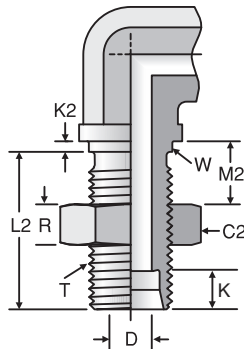

**Ferulok Shape Bulkhead**

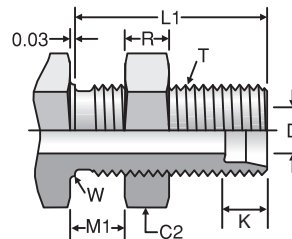

**Ferulok Straight Bulkhead**

TABLE OF CONTENTS

VISUAL INDEX

SAE Dash Size	Tube O.D. (in.)	T UN/UNF	C (in.)	C2 (in.)	C3 (in.)	D (in.)	Allowance		Male Turn Back	Bulkhead					Max Bulkhead Thickness		Thread Engagement	Across Corners	
							Tube Nut Assembled	Tube		Pilot Length Shapes	Length - Straights	Length - Shapes	Locknut Thickness	Pilot Dia	Straights	Shapes		Tube Nut Hex	Swivel Nut Hex
							F (in)	K (in)	L (in)	K2 (in)	L1 (in)	L2 (in)	R (in)	W <sup>1)</sup> (in)	M1 (in)	M2 (in)	TE (in)	U1 (in)	U2 (in)
2	1/8	5/16-24	3/8	9/16	7/16	0.093	0.31	0.19	0.375	0.09	1.02	0.83	0.22	0.31	0.28	0.38	0.22	0.22	0.25
3	3/16	3/8-24	7/16	5/8	1/2	0.125	0.34	0.24	0.422	0.09	1.06	0.88	0.22	0.37	0.28	0.38	0.25	0.25	0.29
4	1/4	7/16-20	9/16	11/16	9/16	0.203	0.42	0.24	0.453	0.09	1.12	0.94	0.28	0.44	0.38	0.28	0.29	0.33	0.33
5	5/16	1/2-20	5/8	3/4	5/8	0.234	0.42	0.26	0.453	0.09	1.12	0.94	0.28	0.50	0.28	0.38	0.31	0.36	0.36
6	3/8	9/16-18	11/16	13/16	11/16	0.281	0.47	0.26	0.469	0.09	1.17	0.98	0.27	0.56	0.40	0.31	0.34	0.40	0.40
8	1/2	3/4-16	7/8	1	7/8	0.422	0.50	0.31	0.562	0.13	1.31	1.12	0.31	0.75	0.40	0.31	0.32	0.51	0.51
10	5/8	7/8-14	1	1 1/8	1	0.500	0.53	0.36	0.625	0.13	1.45	1.27	0.36	0.88	0.44	0.38	0.37	0.58	0.59
12	3/4	1 1/16-12	1 1/4	1 3/8	1 1/4	0.656	0.56	0.36	0.688	0.13	1.56	1.38	0.41	1.06	0.44	0.38	0.42	0.72	0.73
14	7/8	1 3/16-12	1 3/8	1 1/2	1 3/8	0.719	0.53	0.36	0.688	0.13	1.56	1.38	0.41	1.19	0.44	0.38	0.34	0.79	0.79
16	1	1 5/16-12	1 1/2	1 5/8	1 1/2	0.875	0.66	0.42	0.688	0.13	1.56	1.38	0.41	1.31	0.44	0.38	0.32	0.87	0.88
20	1 1/4	1 5/8-12	2	1 7/8	2	1.094	0.72	0.42	0.688	0.13	1.56	1.38	0.41	1.62	0.44	0.38	0.33	1.15	1.17
24	1 1/2	1 7/8-12	2 1/4	2 1/8	2 1/4	1.344	0.72	0.49	0.688	0.13	1.56	1.38	0.41	1.87	0.44	0.38	0.34	1.30	1.29
32	2	2 1/2-12	2 7/8	2 3/4	2 7/8	1.813	0.84	0.49	0.688	0.13	1.77	1.58	0.41	2.50	0.63	0.56	0.34	1.66	1.64

1) Recommended clearance hole +0.015 over W dia.

Note: For port and stud end dimensions reference Section E: Pipe Fittings and Port Adapters.

Dimensions and pressures for reference only, subject to change.

Click here for CADs, Support Resources or to Configure Parts Online

**BU**  
Nut  
Flareless

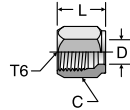

SAE 080110

TUBE FITTING PART #	TUBE O.D. (in.)	T6 UN/UNF-2B	C HEX (in.)	D DRILL (in.)	L (in.)	Material	
						-S	-SS
2 BU	1/8	5/16 - 24	3/8	0.130	0.53	•	•
3 BU	3/16	3/8 - 24	7/16	0.193	0.61	•	•
4 BU	1/4	7/16 - 20	9/16	0.255	0.70	•	•
5 BU	5/16	1/2 - 20	5/8	0.318	0.72	•	•
6 BU	3/8	9/16 - 18	11/16	0.380	0.75	•	•
8 BU	1/2	3/4 - 16	7/8	0.505	0.84	•	•
10 BU	5/8	7/8 - 14	1	0.631	0.92	•	•
12 BU	3/4	1 1/16 - 12	1 1/4	0.756	0.97	•	•
14 BU	7/8	1 3/16 - 12	1 3/8	0.881	1.00	•	•
16 BU	1	1 5/16 - 12	1 1/2	1.006	1.05	•	•
20 BU	1 1/4	1 5/8 - 12	2	1.260	1.05	•	•
24 BU	1 1/2	1 7/8 - 12	2 1/4	1.510	1.03	•	•
32 BU	2	2 1/2 - 12	2 7/8	2.014	1.12	•	•

Note: All stainless steel nuts are coated to prevent galling at assembly.

**WARNING:** This product can expose you to chemicals including Lead and Lead Compounds which is known to the State of California to cause cancer and birth defects or other reproductive harm. For more information go to [www.p65warnings.ca.gov](http://www.p65warnings.ca.gov).

**WLN**  
Bulkhead Locknut  
Flareless

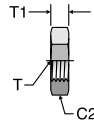

SAE 080118 and 070118

TUBE FITTING PART #	TUBE O.D. (in.)	T UN/UNF-2B	C2 HEX (in.)	T1 (in.)	Material	
					-S	-SS
3 WLN	3/16	3/8 - 24	5/8	0.22	•	•
4 WLN	1/4	7/16 - 20	11/16	0.28	•	•
5 WLN	5/16	1/2 - 20	3/4	0.28	•	•
6 WLN	3/8	9/16 - 18	13/16	0.27	•	•
8 WLN	1/2	3/4 - 16	1	0.31	•	•
10 WLN	5/8	7/8 - 14	1 1/8	0.36	•	•
12 WLN	3/4	1 1/16 - 12	1 3/8	0.41	•	•
14 WLN	7/8	1 3/16 - 12	1 1/2	0.41	•	•
16 WLN	1	1 5/16 - 12	1 5/8	0.41	•	•
20 WLN	1 1/4	1 5/8 - 12	1 7/8	0.41	•	•
24 WLN	1 1/2	1 7/8 - 12	2 1/8	0.41	•	•
32 WLN	2	2 1/2 - 12	2 3/4	0.41	•	•

**WARNING:** This product can expose you to chemicals including Lead and Lead Compounds which is known to the State of California to cause cancer and birth defects or other reproductive harm. For more information go to [www.p65warnings.ca.gov](http://www.p65warnings.ca.gov).

**TU**  
Ferrule  
Flareless

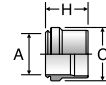

SAE 080115A

TUBE FITTING PART #	TUBE O.D. (in.)	A (in.)	C (in.)	H (in.)	Material	
					-S	-SS
2 TU	1/8	0.13	0.24	0.29	•	•
3 TU	3/16	0.19	0.31	0.33	•	•
4 TU	1/4	0.26	0.37	0.36	•	•
5 TU	5/16	0.32	0.43	0.37	•	•
6 TU	3/8	0.38	0.50	0.39	•	•
8 TU	1/2	0.51	0.66	0.43	•	•
10 TU	5/8	0.63	0.78	0.44	•	•
12 TU	3/4	0.76	0.93	0.48	•	•
14 TU	7/8	0.88	1.06	0.48	•	•
16 TU	1	1.01	1.19	0.48	•	•
20 TU	1 1/4	1.26	1.45	0.48	•	•
24 TU	1 1/2	1.51	1.69	0.48	•	•
32 TU	2	2.01	2.21	0.51	•	•

Steel TU sleeves are plated with a zinc phos.

**WARNING:** This product can expose you to chemicals including Lead and Lead Compounds which is known to the State of California to cause cancer and birth defects or other reproductive harm. For more information go to [www.p65warnings.ca.gov](http://www.p65warnings.ca.gov).

**HBU**  
Union  
Flareless / Flareless

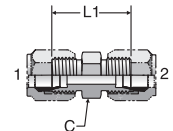

SAE 080101

TUBE FITTING PART #	END SIZE		C HEX (in.)	L1 (in.)	Dynamic Pressure (x 1,000 PSI)	
	1 (in.)	2 (in.)			-S	-SS
	2 HBU	1/8			1/8	7/16
3 HBU	3/16	3/16	7/16	1.11	6.0	6.0
4 HBU	1/4	1/4	1/2	1.19	6.0	6.0
5 HBU	5/16	5/16	9/16	1.19	6.0	6.0
6 HBU	3/8	3/8	5/8	1.24	6.0	6.0
6-4 HBU	3/8	1/4	5/8	1.22	6.0	6.0
8 HBU	1/2	1/2	13/16	1.42	5.0	5.0
8-6 HBU	1/2	3/8	13/16	1.33	5.0	5.0
10 HBU	5/8	5/8	15/16	1.61	5.0	5.0
10-8 HBU	5/8	1/2	15/16	1.55	5.0	5.0
12 HBU	3/4	3/4	1 1/8	1.81	4.5	4.5
14 HBU	7/8	7/8	1 1/4	1.81	4.0	4.0
16 HBU	1	1	1 3/8	1.81	4.0	4.0
20 HBU	1 1/4	1 1/4	1 11/16	1.89	3.0	3.0
24 HBU	1 1/2	1 1/2	2	1.96	2.0	2.0
32 HBU	2	2	2 5/8	2.11	1.5	1.5

**WARNING:** This product can expose you to chemicals including Lead and Lead Compounds which is known to the State of California to cause cancer and birth defects or other reproductive harm. For more information go to [www.p65warnings.ca.gov](http://www.p65warnings.ca.gov).

C

TABLE OF CONTENTS

VISUAL INDEX

FAQs

ASSEMBLY

TUBE FAB EQUIP

GEN TECH

Dimensions and pressures for reference only, subject to change.

Click here for CADs, Support Resources or to Configure Parts Online

## WBU

Bulkhead Union  
Flareless / Flareless Bulkhead

SAE 080601

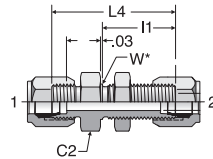

\* W – Bulkhead pilot dia.  
recommended clearance  
hole is +.015 over W dia.

TUBE FITTING PART #	END SIZE		C2 HEX (in.)	I1 (in.)	L4 (in.)	W (in.)	Max. Bulkhead Thickness	Dynamic Pressure (x 1,000 PSI)	
	1 (in.)	2 (in.)						-S	-SS
4 WBU	1/4	1/4	11/16	1.12	1.89	0.44	0.38	6.0	6.0
6 WBU	3/8	3/8	13/16	1.17	1.98	0.56	0.40	6.0	6.0
8 WBU	1/2	1/2	1	1.31	2.22	0.75	0.40	5.0	5.0
10 WBU	5/8	5/8	1 1/8	1.45	2.48	0.88	0.44	5.0	5.0
12 WBU	3/4	3/4	1 3/8	1.56	2.72	1.06	0.44	4.5	4.5
16 WBU	1	1	1 5/8	1.56	2.72	1.31	0.44	4.0	4.0

Part comes with the WLN locknut.

**WARNING:** This product can expose you to chemicals including Lead and Lead Compounds which is known to the State of California to cause cancer and birth defects or other reproductive harm. For more information go to [www.p65warnings.ca.gov](http://www.p65warnings.ca.gov).

## F5BU

Straight Thread Connector  
Flareless / SAE-ORB

SAE 080120

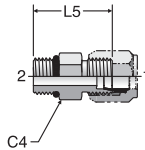

TUBE FITTING PART #	END SIZE		C4 HEX (in.)	L5 (in.)	Dynamic Pressure (x 1,000 PSI)	
	1 (in.)	2 UN/UNF-2A			-S	-SS
2 F5BU	1/8	5/16 - 24	7/16	0.99	6.0	6.0
3 F5BU	3/16	3/8 - 24	1/2	1.05	6.0	6.0
4 F5BU	1/4	7/16 - 20	9/16	1.13	6.0	6.0
4-5 F5BU	1/4	1/2 - 20	5/8	1.13	6.0	6.0
4-6 F5BU	1/4	9/16 - 18	11/16	1.20	6.0	6.0
5 F5BU	5/16	1/2 - 20	5/8	1.13	6.0	6.0
6 F5BU	3/8	9/16 - 18	11/16	1.22	6.0	6.0
6-4 F5BU	3/8	7/16 - 20	5/8	1.19	6.0	6.0
6-8 F5BU	3/8	3/4 - 16	7/8	1.28	6.0	6.0
8 F5BU	1/2	3/4 - 16	7/8	1.38	5.0	5.0
8-6 F5BU	1/2	9/16 - 18	13/16	1.28	5.0	5.0
8-10 F5BU	1/2	7/8 - 14	1	1.50	5.0	5.0
8-12 F5BU	1/2	1 1/16 - 12	1 1/4	1.67	4.5	4.5
10 F5BU	5/8	7/8 - 14	1	1.56	5.0	5.0
10-12 F5BU	5/8	1 1/16 - 12	1 1/4	1.73	4.5	4.5
12 F5BU	3/4	1 1/16 - 12	1 1/4	1.78	4.5	4.5
12-8 F5BU	3/4	3/4 - 16	1 1/8	1.75	4.5	4.5
12-16 F5BU	3/4	1 5/16 - 12	1 1/2	1.81	4.0	4.0
16 F5BU	1	1 5/16 - 12	1 1/2	1.81	4.0	4.0
16-12 F5BU	1	1 1/16 - 12	1 3/8	1.81	4.0	4.0
16-20 F5BU	1	1 5/8 - 12	1 7/8	1.91	3.0	3.0
20 F5BU	1 1/4	1 5/8 - 12	1 7/8	1.91	3.0	3.0
24 F5BU	1 1/2	1 7/8 - 12	2 1/8	1.97	3.0	3.0
32 F5BU	2	2 1/2 - 12	2 3/4	2.13	2.0	2.0

**WARNING:** This product can expose you to chemicals including Lead and Lead Compounds which is known to the State of California to cause cancer and birth defects or other reproductive harm. For more information go to [www.p65warnings.ca.gov](http://www.p65warnings.ca.gov).

## FBU

Male Connector  
Flareless / NPTF

SAE 080102

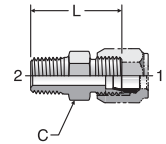

TUBE FITTING PART #	END SIZE		C HEX (in.)	L (in.)	Dynamic Pressure (x 1,000 PSI)	
	1 (in.)	2 NPTF			-S	-SS
2 FBU	1/8	1/8 - 27	7/16	1.04	6.0	6.0
2-4 FBU	1/8	1/4 - 18	9/16	1.24	6.0	6.0
3 FBU	3/16	1/8 - 27	7/16	1.09	6.0	6.0
4 FBU	1/4	1/8 - 27	1/2	1.12	6.0	6.0
4-4 FBU	1/4	1/4 - 18	9/16	1.32	6.0	6.0
4-6 FBU	1/4	3/8 - 18	3/4	1.33	6.0	6.0
4-8 FBU	1/4	1/2 - 14	7/8	1.58	6.0	6.0
5 FBU	5/16	1/8 - 27	9/16	1.12	6.0	6.0
5-4 FBU	5/16	1/4 - 18	9/16	1.32	6.0	6.0
6 FBU	3/8	1/4 - 18	5/8	1.34	6.0	6.0
6-2 FBU	3/8	1/8 - 27	5/8	1.15	6.0	6.0
6-6 FBU	3/8	3/8 - 18	3/4	1.35	6.0	6.0
6-8 FBU	3/8	1/2 - 14	15/16	1.60	6.0	6.0
8 FBU	1/2	3/8 - 18	13/16	1.44	5.0	5.0
8-4 FBU	1/2	1/4 - 18	13/16	1.44	5.0	5.0
8-8 FBU	1/2	1/2 - 14	7/8	1.69	5.0	5.0
8-12 FBU	1/2	3/4 - 14	1 1/8	1.76	4.0	4.0
10 FBU	5/8	1/2 - 14	15/16	1.75	4.5	4.5
10-6 FBU	5/8	3/8 - 18	15/16	1.56	4.5	4.5
10-12 FBU	5/8	3/4 - 14	1 1/8	1.82	4.0	4.0
12 FBU	3/4	3/4 - 14	1 1/8	1.88	4.0	4.0
12-8 FBU	3/4	1/2 - 14	1 1/8	1.88	4.0	4.0
14 FBU	7/8	3/4 - 14	1 1/4	1.88	3.0	3.0
16 FBU	1	1 - 11 1/2	1 3/8	2.07	3.0	3.0
16-12 FBU	1	3/4 - 14	1 3/8	1.88	3.0	3.0
20 FBU	1 1/4	1 1/4 - 11 1/2	1 11/16	2.18	2.5	2.5
24 FBU	1 1/2	1 1/2 - 11 1/2	2	2.28	2.5	2.5
32 FBU	2	2 - 11 1/2	2 3/4	2.46	2.0	2.0

**WARNING:** This product can expose you to chemicals including Lead and Lead Compounds which is known to the State of California to cause cancer and birth defects or other reproductive harm. For more information go to [www.p65warnings.ca.gov](http://www.p65warnings.ca.gov).

- TABLE OF CONTENTS
- VISUAL INDEX
- FAQs
- ASSEMBLY
- TUBE FAB EQUIP
- GEN TECH

Dimensions and pressures for reference only, subject to change.

Click here for CADs, Support Resources or to Configure Parts Online

## GBU

Female Connector  
Flareless / NPTF

SAE 080103

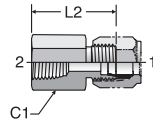

TUBE FITTING PART #	END SIZE		C1 HEX (in.)	L2 (in.)	Dynamic Pressure (x 1,000 PSI)	
	1 (in.)	2 NPTF			-S	-SS
	2 GBU	1/8			1/8 - 27	9/16
4 GBU	1/4	1/8 - 27	9/16	1.09	5.0	5.0
4-4 GBU	1/4	1/4 - 18	3/4	1.29	5.0	5.0
5 GBU	5/16	1/8 - 27	9/16	1.08	5.0	5.0
6 GBU	3/8	1/4 - 18	3/4	1.31	5.0	5.0
6-6 GBU	3/8	3/8 - 18	7/8	1.34	5.0	5.0
6-8 GBU	3/8	1/2 - 14	1 1/8	1.59	5.0	5.0
8 GBU	1/2	3/8 - 18	7/8	1.47	5.0	5.0
8-4 GBU	1/2	1/4 - 18	7/8	1.46	5.0	5.0
8-8 GBU	1/2	1/2 - 14	1 1/8	1.69	5.0	5.0
10 GBU	5/8	1/2 - 14	1 1/8	1.77	4.5	4.5
12 GBU	3/4	3/4 - 14	1 3/8	1.89	4.0	4.0
14 GBU	7/8	3/4 - 14	1 3/8	1.86	3.0	3.0
16 GBU	1	1 - 11 1/2	1 5/8	2.13	3.0	3.0
20 GBU	1 1/4	1 1/4 - 11 1/2	2	2.22	2.5	2.5
24 GBU	1 1/2	1 1/2 - 11 1/2	2 3/8	2.23	2.5	2.5

**WARNING:** This product can expose you to chemicals including Lead and Lead Compounds which is known to the State of California to cause cancer and birth defects or other reproductive harm. For more information go to [www.p65warnings.ca.gov](http://www.p65warnings.ca.gov).

## TRBU

Tube End Reducer  
Tube / Flareless

SAE 080123

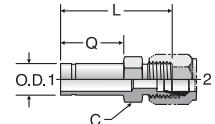

TUBE FITTING PART #	END SIZE		C HEX (in.)	L (in.)	Q (in.)	Dynamic Pressure (x 1,000 PSI)	
	1 (in.)	2 (in.)				-S	-SS
	6-4 TRBU	3/8				1/4	1/2
8-4 TRBU	1/2	1/4	9/16	1.73	1.00	5.0	5.0
8-6 TRBU	1/2	3/8	5/8	1.77	1.00	5.0	5.0
10-6 TRBU	5/8	3/8	11/16	1.86	1.09	5.0	5.0
10-8 TRBU	5/8	1/2	13/16	1.95	1.09	4.5	4.5
12-6 TRBU	3/4	3/8	13/16	1.94	1.16	4.5	4.5
12-8 TRBU	3/4	1/2	13/16	2.03	1.16	4.5	4.5
12-10 TRBU	3/4	5/8	15/16	2.16	1.16	4.5	4.5
14-10 TRBU	7/8	5/8	15/16	2.14	1.16	4.0	4.0
16-8 TRBU	1	1/2	1 1/16	2.05	1.13	4.0	4.0
16-10 TRBU	1	5/8	1 1/16	2.11	1.13	4.0	4.0
16-12 TRBU	1	3/4	1 1/8	2.25	1.13	4.0	4.0
20-16 TRBU	1 1/4	1	1 3/8	2.28	1.16	3.0	3.0
24-12 TRBU	1 1/2	3/4	1 5/8	2.45	1.25	2.0	2.0
24-16 TRBU	1 1/2	1	1 5/8	2.45	1.25	2.0	2.0
24-20 TRBU	1 1/2	1 1/4	1 7/8	2.45	1.25	2.0	2.0

**WARNING:** This product can expose you to chemicals including Lead and Lead Compounds which is known to the State of California to cause cancer and birth defects or other reproductive harm. For more information go to [www.p65warnings.ca.gov](http://www.p65warnings.ca.gov).

## V5BU

45° Straight Thread Elbow  
Flareless / SAE-ORB

SAE 080320

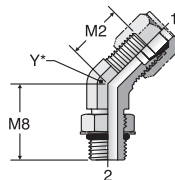

\* Y – Across wrench flats

TUBE FITTING PART #	END SIZE		M2 (in.)	M8 (in.)	Y (in.)	Dynamic Pressure (x 1,000 PSI)	
	1 (in.)	2 UN/UNF-2A				-S	-SS
	4 V5BU	1/4				7/16 - 20	0.70
6 V5BU	3/8	9/16 - 18	0.83	1.14	9/16	5.0	5.0
8 V5BU	1/2	3/4 - 16	0.98	1.30	3/4	5.0	5.0
12 V5BU	3/4	1 1/16 - 12	1.27	1.73	1 1/16	4.0	4.0
16 V5BU	1	1 5/16 - 12	1.36	1.86	1 5/16	3.0	3.0

## VBU

45° Male Elbow  
Flareless / NPTF

SAE 080302

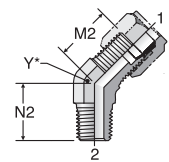

\* Y – Across wrench flats

TUBE FITTING PART #	END SIZE		M2 (in.)	N2 (in.)	Y (in.)	Dynamic Pressure (x 1,000 PSI)	
	1 (in.)	2 NPTF				-S	-SS
	3 VBU	3/16				1/8 - 27	0.64
4 VBU	1/4	1/8 - 27	0.70	0.64	7/16	5.0	5.0
4-4 VBU	1/4	1/4 - 18	0.81	0.86	9/16	5.0	5.0
5 VBU	5/16	1/8 - 27	0.75	0.66	9/16	5.0	5.0
6 VBU	3/8	1/4 - 18	0.83	0.86	9/16	5.0	5.0
8 VBU	1/2	3/8 - 18	0.98	0.95	3/4	5.0	5.0
10 VBU	5/8	1/2 - 14	1.08	1.17	7/8	4.5	4.5
12 VBU	3/4	3/4 - 14	1.27	1.20	1 1/16	4.0	4.0
14 VBU	7/8	3/4 - 14	1.34	1.30	1 5/16	3.0	3.0
16 VBU	1	1 - 11 1/2	1.36	1.48	1 5/16	3.0	3.0
20 VBU	1 1/4	1 1/4 - 11 1/2	1.45	1.67	1 5/8	2.5	2.5

Dimensions and pressures for reference only, subject to change

[Click here for CADs, Support Resources or to Configure Parts Online](#)

## EBU

Union Elbow  
Flareless / Flareless

SAE 080201

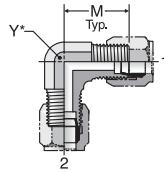

\* Y – Across wrench flats

## WEBU

Bulkhead Union Elbow  
Flareless / Flareless Bulkhead

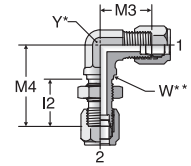

\* Y – Across wrench flats.  
W\*\* – Bulkhead pilot dia. recommended clearance hole is +.015 over W dia.

TUBE FITTING PART #	END SIZE		M (in.)	Y (in.)	Dynamic Pressure (x 1,000 PSI)	
	1 (in.)	2 (in.)			-S	-SS
	2 EBU	1/8				
4 EBU	1/4	1/4	0.89	7/16	5.0	5.0
5 EBU	5/16	5/16	0.95	9/16	5.0	5.0
8 EBU	3/8	3/8	1.05	9/16	5.0	5.0
8 EBU	1/2	1/2	1.25	3/4	5.0	5.0
10 EBU	5/8	5/8	1.42	7/8	4.5	4.5
12 EBU	3/4	3/4	1.58	1 1/16	4.0	4.0
14 EBU	7/8	7/8	1.66	1 5/16	3.0	3.0
16 EBU	1	1	1.73	1 5/16	3.0	3.0
20 EBU	1 1/4	1 1/4	1.89	1 5/8	2.5	2.5
24 EBU	1 1/2	1 1/2	2.02	1 7/8	2.0	2.0
32 EBU	2	2	2.45	2 1/2	1.5	1.5

TUBE FITTING PART #	END SIZE		I2 (in.)	M3 (in.)	M4 (in.)	W DIA (in.)	Y (in.)	Max. Bulkhead Thickness	Dynamic Pressure (x 1,000 PSI)	
	1 (in.)	2 (in.)							-S	-SS
	4 WEBU	1/4								
6 WEBU	3/8	3/8	0.98	1.08	1.70	0.56	9/16	0.26	5.0	5.0
8 WEBU	1/2	1/2	1.12	1.33	1.97	0.75	3/4	0.30	5.0	5.0
10 WEBU	5/8	5/8	1.27	1.52	2.27	0.88	7/8	0.38	4.5	4.5
12 WEBU	3/4	3/4	1.38	1.64	2.48	1.06	1 1/16	0.38	4.0	4.0
16 WEBU	1	1	1.38	1.73	2.61	1.31	1 5/16	0.38	3.0	3.0

Includes WLN locknut.

TABLE OF CONTENTS

VISUAL INDEX

FAQs

ASSEMBLY

TUBE FAB EQUIP

GEN TECH

## C6BU

Swivel Nut Elbow  
Flareless / Flareless Swivel

SAE 080221

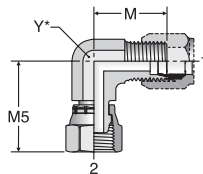

\* Y – Across wrench flats

## C5BU

Straight Thread Elbow  
Flareless / SAE-ORB

SAE 080220

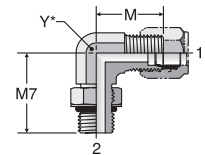

\* Y – Across wrench flats

TUBE FITTING PART #	END SIZE		M (in.)	M5 (in.)	Y (in.)	Dynamic Pressure (x 1,000 PSI)	
	1 (in.)	2 (in.)				-S	-SS
	4 C6BU	1/4					
6 C6BU	3/8	3/8	1.05	1.25	9/16	5.0	5.0
8 C6BU	1/2	1/2	1.25	1.38	3/4	5.0	5.0
10 C6BU	5/8	5/8	1.42	1.62	7/8	4.5	4.5
12 C6BU	3/4	3/4	1.58	1.75	1 1/16	4.0	4.0
16 C6BU	1	1	1.73	2.00	1 5/16	3.0	3.0
20 C6BU	1 1/4	1 1/4	1.89	2.31	1 5/8	2.5	2.5

TUBE FITTING PART #	END SIZE		M (in.)	M7 (in.)	Y (in.)	Dynamic Pressure (x 1,000 PSI)	
	1 (in.)	2 UN/UNF-2A (in.)				-S	-SS
3 C5BU	3/16	3/8 - 24	0.84	0.94	7/16		
4 C5BU	1/4	7/16 - 20	0.89	1.03	7/16	5.0	5.0
5 C5BU	5/16	1/2 - 20	0.95	1.13	9/16	5.0	5.0
6 C5BU	3/8	9/16 - 18	1.05	1.25	9/16	5.0	5.0
6-8 C5BU	3/8	3/4 - 16	1.14	1.45	3/4	5.0	5.0
8 C5BU	1/2	3/4 - 16	1.25	1.45	3/4	5.0	5.0
8-6 C5BU	1/2	9/16 - 18	1.27	1.33	3/4	5.0	5.0
8-10 C5BU	1/2	7/8 - 14	1.34	1.70	7/8	4.5	4.5
8-12 C5BU	1/2	1 1/16 - 12	1.43	1.94	1 1/16	4.0	4.0
10 C5BU	5/8	7/8 - 14	1.42	1.70	7/8	4.5	4.5
12 C5BU	3/4	1 1/16 - 12	1.58	1.94	1 1/16	4.0	4.0
12-8 C5BU	3/4	3/4 - 16	1.58	1.63	1 1/16	4.0	4.0
12-10 C5BU	3/4	7/8 - 14	1.58	1.78	1 1/16	4.0	4.0
12-16 C5BU	3/4	1 5/16 - 12	1.73	2.05	1 5/16	3.0	3.0
16 C5BU	1	1 5/16 - 12	1.73	2.05	1 5/16	3.0	3.0
16-12 C5BU	1	1 1/16 - 12	1.73	2.05	1 5/16	3.0	3.0
20 C5BU	1 1/4	1 5/8 - 12	1.89	2.25	1 5/8	2.5	2.5
24 C5BU	1 1/2	1 7/8 - 12	2.02	2.39	1 7/8	2.0	2.0
32 C5BU	2	2 1/2 - 12	2.45	2.89	2 1/2	1.5	1.5

Dimensions and pressures for reference only, subject to change.



[Click here for CADs, Support Resources or to Configure Parts Online](#)

## CC5BU

Straight Thread Elbow  
Flareless / SAE-ORB Long

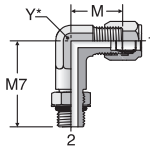

\*Y – Across wrench flats

## CBU

Male Elbow  
Flareless / NPTF

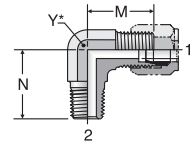

\*Y – Across wrench flats

TUBE FITTING PART #	END SIZE		M (in.)	M7 (in.)	Y (in.)	Dynamic Pressure (x 1,000 PSI)	
	1 (in.)	2 UN/UNF-2A				-S	-SS
	4 CC5BU	1/4					
6 CC5BU	3/8	9/16 - 18	1.05	1.72	9/16	5.0	5.0
8 CC5BU	1/2	3/4 - 16	1.25	2.02	3/4	5.0	5.0
10 CC5BU	5/8	7/8 - 14	1.42	2.39	7/8	4.5	4.5
12 CC5BU	3/4	1 1/16 - 12	1.58	2.69	1 1/16	4.0	4.0
16 CC5BU	1	1 5/16 - 12	1.73	3.13	1 5/16	3.0	3.0

TUBE FITTING PART #	END SIZE		M (in.)	N (in.)	Y (in.)	Dynamic Pressure (x 1,000 PSI)	
	1 (in.)	2 NPTF				-S	-SS
	2 CBU	1/8					
3 CBU	3/16	1/8 - 27	0.83	0.72	7/16	5.0	5.0
4 CBU	1/4	1/8 - 27	0.89	0.78	7/16	5.0	5.0
4-4 CBU	1/4	1/4 - 18	1.03	1.09	9/16	5.0	5.0
4-6 CBU	1/4	3/8 - 18	1.12	1.22	3/4	5.0	5.0
5 CBU	5/16	1/8 - 27	0.95	0.81	9/16	5.0	5.0
5-4 CBU	5/16	1/4 - 18	1.03	1.09	9/16	5.0	5.0
6 CBU	3/8	1/4 - 18	1.05	1.09	9/16	5.0	5.0
6-2 CBU	3/8	1/8 - 27	1.05	0.90	9/16	5.0	5.0
6-6 CBU	3/8	3/8 - 18	1.14	1.22	3/4	5.0	5.0
6-8 CBU	3/8	1/2 - 14	1.24	1.47	7/8	5.0	5.0
8 CBU	1/2	3/8 - 18	1.25	1.22	3/4	5.0	5.0
8-4 CBU	1/2	1/4 - 18	1.25	1.16	3/4	5.0	5.0
8-8 CBU	1/2	1/2 - 14	1.35	1.47	7/8	5.0	5.0
8-12 CBU	1/2	3/4 - 14	1.43	1.59	1 1/16	4.0	4.0
10 CBU	5/8	1/2 - 14	1.42	1.47	7/8	4.5	4.5
10-6 CBU	5/8	3/8 - 18	1.42	1.28	7/8	4.5	4.5
12 CBU	3/4	3/4 - 14	1.58	1.59	1 1/16	4.0	4.0
12-8 CBU	3/4	1/2 - 14	1.58	1.59	1 1/16	4.0	4.0
14 CBU	7/8	3/4 - 14	1.66	1.69	1 5/16	3.0	3.0
16 CBU	1	1 - 11 1/2	1.73	1.97	1 5/16	3.0	3.0
16-12 CBU	1	3/4 - 14	1.73	1.78	1 5/16	3.0	3.0
20 CBU	1 1/4	1 1/4 - 11 1/2	1.89	2.38	1 5/8	2.5	2.5
24 CBU	1 1/2	1 1/2 - 11 1/2	2.02	2.64	1 7/8	2.5	2.5
32 CBU	2	2 - 11 1/2	2.45	3.00	2 1/2	2.0	2.0

## DBU

Female Elbow  
Flareless / NPTF

SAE 080203

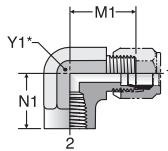

\*Y1 – Across wrench flats

TUBE FITTING PART #	END SIZE		M1 (in.)	N1 (in.)	Y1 (in.)	Dynamic Pressure (x 1,000 PSI)	
	1 (in.)	2 NPTF				-S	-SS
	4 DBU	1/4					
4-4 DBU	1/4	1/4 - 18	1.03	0.88	3/4	5.0	5.0
5 DBU	5/16	1/8 - 27	0.95	0.66	9/16	5.0	5.0
6 DBU	3/8	1/4 - 18	1.05	0.88	3/4	5.0	5.0
6-6 DBU	3/8	3/8 - 18	1.13	1.02	7/8	4.5	4.5
8 DBU	1/2	3/8 - 18	1.23	1.02	7/8	3.0	3.0
8-4 DBU	1/2	1/4 - 18	1.23	0.88	3/4	5.0	5.0
8-8 DBU	1/2	1/2 - 14	1.34	1.23	1 1/16	3.0	3.0
10 DBU	5/8	1/2 - 14	1.42	1.23	1 1/16	3.0	3.0
12 DBU	3/4	3/4 - 14	1.58	1.36	1 5/16	3.0	3.0
14 DBU	7/8	3/4 - 14	1.62	1.42	1 5/16	3.0	3.0
16 DBU	1	1 - 11 1/2	1.73	1.63	1 5/8	1.7	1.7
20 DBU	1 1/4	1 1/4 - 11 1/2	2.08	1.70	1 7/8	1.5	1.5
24 DBU	1 1/2	1 1/2 - 11 1/2	2.58	2.08	2 1/2	1.0	1.0

C

TABLE OF CONTENTS

VISUAL INDEX

FAQs

ASSEMBLY

TUBE FAB EQUIP

GEN TECH

Dimensions and pressures for reference only, subject to change

[Click here for CADs, Support Resources or to Configure Parts Online](#)

## JBU

Union Tee  
Flareless (all three ends)

SAE 080401

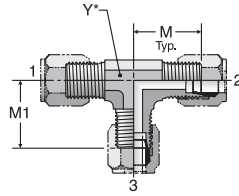

\* Y – Across wrench flats

TUBE FITTING PART #	END SIZE			M (in.)	M1 (in.)	Y (in.)	Dynamic Pressure (x 1,000 PSI)	
	1 (in.)	2 (in.)	3 (in.)				-S	-SS
2 JBU	1/8	1/8	1/8	0.77	0.77	7/16	5.0	5.0
3 JBU	3/16	3/16	3/16	0.84	0.84	7/16	5.0	5.0
4 JBU	1/4	1/4	1/4	0.89	0.89	7/16	5.0	5.0
5 JBU	5/16	5/16	5/16	0.95	0.95	9/16	5.0	5.0
6 JBU	3/8	3/8	3/8	1.05	1.05	9/16	5.0	5.0
8 JBU	1/2	1/2	1/2	1.25	1.25	3/4	5.0	5.0
8-8-6 JBU	1/2	1/2	3/8	1.25	1.14	3/4	5.0	5.0
10 JBU	5/8	5/8	5/8	1.42	1.42	7/8	4.5	4.5
12 JBU	3/4	3/4	3/4	1.58	1.58	1 1/16	4.0	4.0
14 JBU	7/8	7/8	7/8	1.66	1.66	1 5/16	3.0	3.0
16 JBU	1	1	1	1.73	1.73	1 5/16	3.0	3.0
20 JBU	1 1/4	1 1/4	1 1/4	1.89	1.89	1 5/8	2.5	2.5
24 JBU	1 1/2	1 1/2	1 1/2	2.02	2.02	1 7/8	2.0	2.0

## S6BU

Swivel Nut Branch Tee  
Flareless / Flareless Swivel

SAE 080433

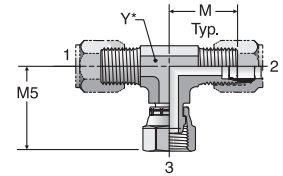

\* Y – Across wrench flats

TUBE FITTING PART #	END SIZE			M (in.)	M5 (in.)	Y (in.)	Dynamic Pressure (x 1,000 PSI)	
	1 (in.)	2 (in.)	3 (in.)				-S	-SS
4 S6BU	1/4	1/4	1/4	0.89	1.00	7/16	5.0	5.0
6 S6BU	3/8	3/8	3/8	1.05	1.25	9/16	5.0	5.0
8 S6BU	1/2	1/2	1/2	1.25	1.38	3/4	5.0	5.0
12 S6BU	3/4	3/4	3/4	1.58	1.75	1 1/16	4.0	4.0
16 S6BU	1	1	1	1.73	2.00	15/16	3.0	3.0

TABLE OF CONTENTS

VISUAL INDEX

FAQs

ASSEMBLY

TUBE FAB EQUIP

GEN TECH

## R6BU

Swivel Nut Run Tee  
Flareless / Flareless Swivel

SAE 080432

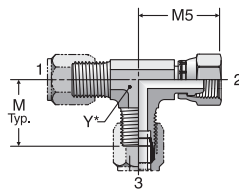

\* Y – Across wrench flats

TUBE FITTING PART #	END SIZE			M (in.)	M5 (in.)	Y (in.)	Dynamic Pressure (x 1,000 PSI)	
	1 (in.)	2 (in.)	3 (in.)				-S	-SS
4 R6BU	1/4	1/4	1/4	0.89	1.00	7/16	5.0	5.0
6 R6BU	3/8	3/8	3/8	1.05	1.25	9/16	5.0	5.0
8 R6BU	1/2	1/2	1/2	1.25	1.38	3/4	5.0	5.0
12 R6BU	3/4	3/4	3/4	1.58	1.75	1 1/16	4.0	4.0
16 R6BU	1	1	1	1.73	2.00	1 5/16	3.0	3.0

## S5BU

Straight Thread Branch Tee  
Flareless / SAE-ORB

SAE 080429

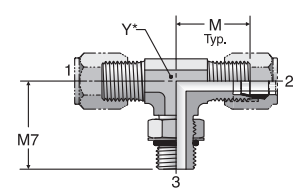

\* Y – Across wrench flats

TUBE FITTING PART #	END SIZE			M (in.)	M7 (in.)	Y (in.)	Dynamic Pressure (x 1,000 PSI)	
	1 (in.)	2 (in.)	3 UN/UNF-2A				-S	-SS
4 S5BU	1/4	1/4	7/16 - 20	0.89	1.03	7/16	5.0	5.0
6 S5BU	3/8	3/8	9/16 - 18	1.05	1.25	9/16	5.0	5.0
8 S5BU	1/2	1/2	3/4 - 16	1.25	1.45	3/4	5.0	5.0
12 S5BU	3/4	3/4	1 1/16 - 12	1.58	1.94	1 1/16	4.0	4.0
16 S5BU	1	1	1 5/16 - 12	1.73	2.05	1 5/16	3.0	3.0

Dimensions and pressures for reference only, subject to change.

Click here for CADs, Support Resources or to Configure Parts Online

### R5BU

Straight Thread Run Tee  
Flareless / SAE-ORB

SAE 080428

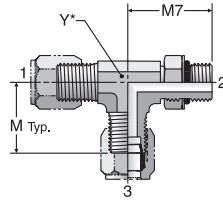

\*Y – Across wrench flats

### SBU

Male Branch Tee  
Flareless / NPTF

SAE 080425

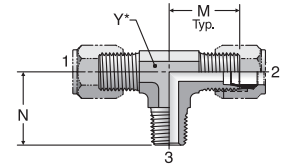

\*Y – Across wrench flats

TUBE FITTING PART #	END SIZE			M (in.)	M7 (in.)	Y (in.)	Dynamic Pressure (x 1,000 PSI)	
	1 (in.)	2 UN/UNF-2A	3 (in.)				-S	-SS
	4 R5BU	1/4	7/16 - 20					
6 R5BU	3/8	9/16 - 18	3/8	1.05	1.25	9/16	5.0	5.0
8 R5BU	1/2	3/4 - 16	1/2	1.25	1.45	3/4	5.0	5.0
10 R5BU	5/8	7/8 - 14	5/8	1.42	1.70	7/8	4.5	4.5
12 R5BU	3/4	1 1/16 - 12	3/4	1.58	1.94	1 1/16	4.0	4.0
16 R5BU	1	1 5/16 - 12	1	1.73	2.05	1 5/16	3.0	3.0

TUBE FITTING PART #	END SIZE			M (in.)	N (in.)	Y (in.)	Dynamic Pressure (x 1,000 PSI)	
	1 (in.)	2 (in.)	3 NPTF				-S	-SS
	2 SBU	1/8	1/8					
4 SBU	1/4	1/4	1/8 - 27	0.89	0.78	7/16	5.0	5.0
4-4-4 SBU	1/4	1/4	1/4 - 18	1.03	1.09	9/16	5.0	5.0
5 SBU	5/16	5/16	1/8 - 27	0.95	0.81	9/16	5.0	5.0
6 SBU	3/8	3/8	1/4 - 18	1.05	1.09	9/16	5.0	5.0
8 SBU	1/2	1/2	3/8 - 18	1.25	1.22	3/4	5.0	5.0
8-8-8 SBU	1/2	1/2	1/2 - 14	1.35	1.47	7/8	5.0	5.0
10 SBU	5/8	5/8	1/2 - 14	1.42	1.47	7/8	4.5	4.5
12 SBU	3/4	3/4	3/4 - 14	1.58	1.59	1 1/16	4.0	4.0
14 SBU	7/8	7/8	3/4 - 14	1.66	1.69	1 5/16	3.0	3.0
16 SBU	1	1	1 - 11 1/2	1.73	1.97	1 5/16	3.0	3.0

TABLE OF CONTENTS

VISUAL INDEX

FAQs

ASSEMBLY

TUBE FAB EQUIP

GEN TECH

### RBU

Male Run Tee  
Flareless / NPTF

SAE 080424

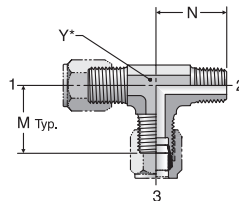

\*Y – Across wrench flats

### OBU

Female Branch Tee  
Flareless / NPTF

SAE 080427

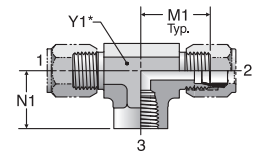

\*Y1 – Across wrench flats

TUBE FITTING PART #	END SIZE			M (in.)	N (in.)	Y (in.)	Dynamic Pressure (x 1,000 PSI)	
	1 (in.)	2 NPTF	3 (in.)				-S	-SS
	4 RBU	1/4	1/8 - 27					
4-4-4 RBU	1/4	1/4 - 18	1/4	1.03	1.09	9/16	5.0	5.0
5 RBU	5/16	1/8 - 27	5/16	0.95	0.81	9/16	5.0	5.0
6 RBU	3/8	1/4 - 18	3/8	1.05	1.09	9/16	5.0	5.0
8 RBU	1/2	3/8 - 18	1/2	1.25	1.22	3/4	5.0	5.0
8-8-8 RBU	1/2	1/2 - 14	1/2	1.35	1.47	7/8	5.0	5.0
10 RBU	5/8	1/2 - 14	5/8	1.42	1.47	7/8	4.5	4.5
12 RBU	3/4	3/4 - 14	3/4	1.58	1.59	1 1/16	4.0	4.0
14 RBU	7/8	3/4 - 14	7/8	1.66	1.69	1 5/16	3.0	3.0
16 RBU	1	1 - 11 1/2	1	1.73	1.97	1 5/16	3.0	3.0

TUBE FITTING PART #	END SIZE			M1 (in.)	N1 (in.)	Y1 (in.)	Dynamic Pressure (x 1,000 PSI)	
	1 (in.)	2 (in.)	3 NPTF				-S	-SS
	4 OBU	1/4	1/4					
4-4-4 OBU	1/4	1/4	1/4 - 18	1.03	0.88	3/4	5.0	5.0
6 OBU	3/8	3/8	1/4 - 18	1.05	0.88	3/4	5.0	5.0
8 OBU	1/2	1/2	3/8 - 18	1.23	1.02	7/8	3.0	3.0
10 OBU	5/8	5/8	1/2 - 14	1.42	1.23	1 1/16	3.0	3.0
12 OBU	3/4	3/4	3/4 - 14	1.58	1.36	1 5/16	3.0	3.0
14 OBU	7/8	7/8	3/4 - 14	1.62	1.42	1 5/16	3.0	3.0
16 OBU	1	1	1 - 11 1/2	1.73	1.63	1 5/8	1.7	1.7
20 OBU	1 1/4	1 1/4	1 1/4 - 11 1/2	2.08	1.70	1 7/8	1.5	1.5

**WARNING:** This product can expose you to chemicals including Lead and Lead Compounds which is known to the State of California to cause cancer and birth defects or other reproductive harm. For more information go to [www.p65warnings.ca.gov](http://www.p65warnings.ca.gov).

**WARNING:** This product can expose you to chemicals including Lead and Lead Compounds which is known to the State of California to cause cancer and birth defects or other reproductive harm. For more information go to [www.p65warnings.ca.gov](http://www.p65warnings.ca.gov).

Click here for CADs, Support Resources or to Configure Parts Online

## MBU

Female Run Tee  
Flareless / NPTF

SAE 080426

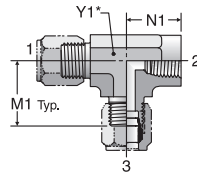

\*Y1 – Across wrench flats

TUBE FITTING PART #	END SIZE			M1 (in.)	N1 (in.)	Y1 (in.)	Dynamic Pressure (x 1,000 PSI)	
	1 (in.)	2 NPTF	3 (in.)				-S	-SS
4 MBU	1/4	1/8 - 27	1/4	0.89	0.66	9/16	5.0	5.0
6 MBU	3/8	1/4 - 18	3/8	1.05	0.88	3/4	5.0	5.0
8 MBU	1/2	3/8 - 18	1/2	1.23	1.02	7/8	3.0	3.0
10 MBU	5/8	1/2 - 14	5/8	1.42	1.23	1 1/16	3.0	3.0
12 MBU	3/4	3/4 - 14	3/4	1.58	1.36	1 5/16	3.0	3.0
16 MBU	1	1 - 11 1/2	1	1.73	1.62	1 5/8	1.7	1.7

## KBU

Union Cross  
Flareless (all four ends)

SAE 080501

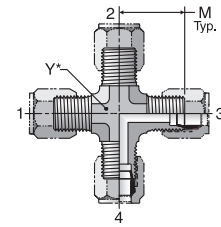

\*Y – Across wrench flats

TUBE FITTING PART #	END SIZE	M (in.)	Y (in.)	Dynamic Pressure (x 1,000 PSI)	
	1-4 (in.)			-S	-SS
4 KBU	1/4	0.89	7/16	5.0	5.0
6 KBU	3/8	1.05	9/16	5.0	5.0
8 KBU	1/2	1.25	3/4	5.0	5.0
12 KBU	3/4	1.58	1 1/16	4.0	4.0

TABLE OF CONTENTS

VISUAL INDEX

FAQs

ASSEMBLY

TUBE FAB EQUIP

GEN TECH

## PNU

Plug  
Flareless

SAE 080109

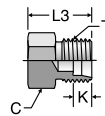

## FNU

Cap  
Flareless Swivel

SAE 080112

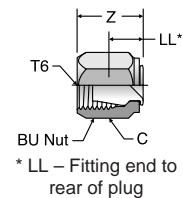

\*LL – Fitting end to rear of plug

TUBE FITTING PART #	TUBE O.D. (in.)	T TUBE END UN/UNF-2A	C HEX (in.)	K (in.)	L3 (in.)	Dynamic Pressure (x 1,000 PSI)	
						-S	-SS
2 PNU	1/8	5/16 - 24	7/16	0.19	0.63	6.0	6.0
4 PNU	1/4	7/16 - 20	1/2	0.24	0.72	6.0	6.0
5 PNU	5/16	1/2 - 20	9/16	0.26	0.72	6.0	6.0
6 PNU	3/8	9/16 - 18	5/8	0.26	0.75	6.0	6.0
8 PNU	1/2	3/4 - 16	13/16	0.31	0.84	5.0	5.0
10 PNU	5/8	7/8 - 14	15/16	0.36	0.97	5.0	5.0
12 PNU	3/4	1 1/16 - 12	1 1/8	0.36	1.09	4.5	4.5
16 PNU	1	1 5/16 - 12	1 3/8	0.42	1.09	4.0	4.0

**WARNING:** This product can expose you to chemicals including Lead and Lead Compounds which is known to the State of California to cause cancer and birth defects or other reproductive harm. For more information go to [www.p65warnings.ca.gov](http://www.p65warnings.ca.gov).

TUBE FITTING PART #	TUBE O.D. (in.)	T6 UN/UNF-2B	C HEX (in.)	LL (in.)	Z (in.)
2 FNU	1/8	5/16 - 24	3/8	0.34	0.55
4 FNU	1/4	7/16 - 20	9/16	0.36	0.73
5 FNU	5/16	1/2 - 20	5/8	0.40	0.77
6 FNU	3/8	9/16 - 18	11/16	0.42	0.80
8 FNU	1/2	3/4 - 16	7/8	0.44	0.87
10 FNU	5/8	7/8 - 14	1	0.47	0.98
12 FNU	3/4	1 1/16 - 12	1 1/4	0.48	1.00
16 FNU	1	1 5/16 - 12	1 1/2	0.58	1.08
20 FNU	1 1/4	1 5/8 - 12	2	0.64	1.11

**WARNING:** This product can expose you to chemicals including Lead and Lead Compounds which is known to the State of California to cause cancer and birth defects or other reproductive harm. For more information go to [www.p65warnings.ca.gov](http://www.p65warnings.ca.gov).

Dimensions and pressures for reference only, subject to change.

















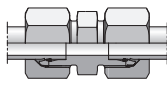
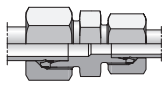
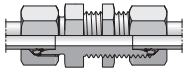

D

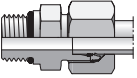
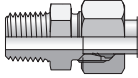
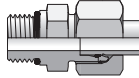
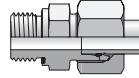

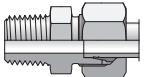
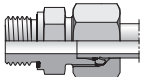

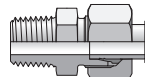
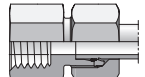
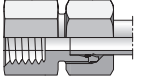

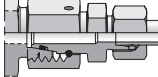
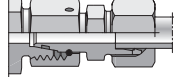
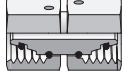
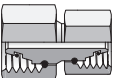

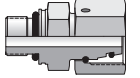
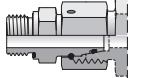
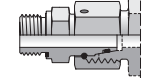
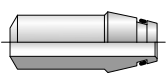
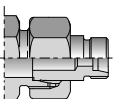
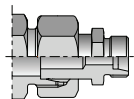
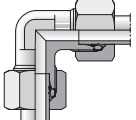
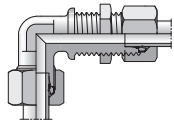
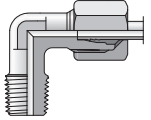
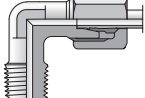
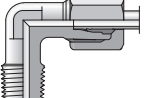
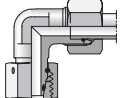
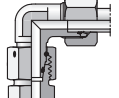
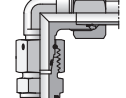
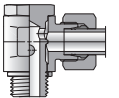
# EO & EO-2

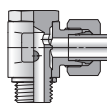
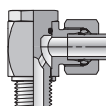
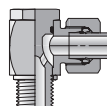
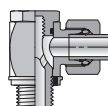
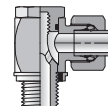
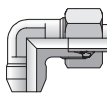

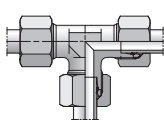
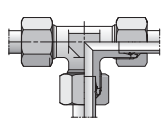
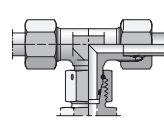
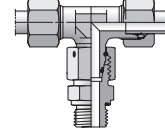
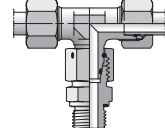
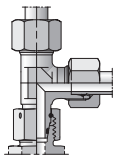
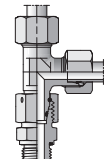
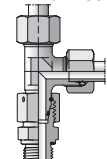
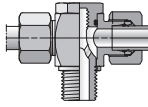
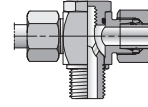
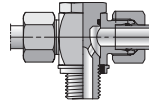
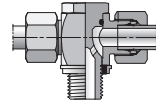
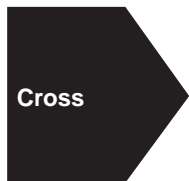
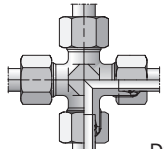

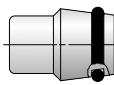
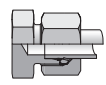
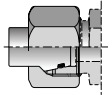

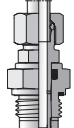
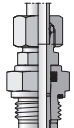
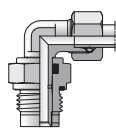
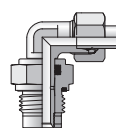

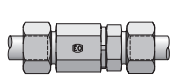
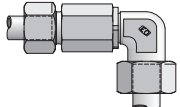
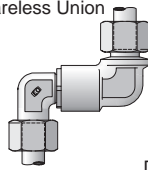
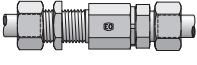
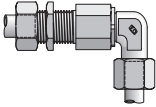
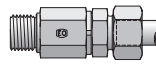
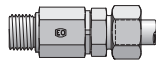
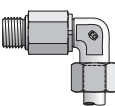
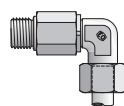
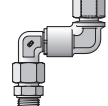
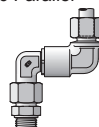

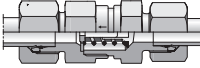
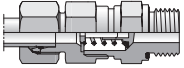

## Metric Bite Type Fittings



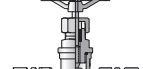

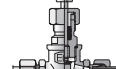
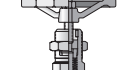
<p><b>Nuts, Sleeves, Locknut, Inserts</b></p>	<p><b>M</b> Nut  D15</p>	<p><b>FM</b> Functional Nut  D16</p>	<p><b>DPR</b> Progressive Ring  D18</p>	<p><b>D</b> Cutting Ring  D19</p>	<p><b>PSR</b> Progressive Ring  D19</p>
<p><b>GM</b> Bulkhead Locknut  D20</p>	<p><b>E</b> Insert for Plastic Tube  D21</p>	<p><b>VH</b> Insert for Metal Tube  D22</p>	<p><b>Straights</b></p>	<p><b>G</b> Union  D23</p>	<p><b>GR</b> Reducer Union  D24</p>
<p><b>SV</b> Bulkhead Union  D25</p>	<p><b>ESV</b> Weld Bulkhead Union  D26</p>	<p><b>GE-UNF/UN</b> SAE-ORB / Flareless  D27</p>	<p><b>GE-NPT</b> NPT / Flareless  D28</p>	<p><b>GEO</b> ISO 6149 / Flareless  D30</p>	<p><b>GE-R-ED</b> BSPP-ED / Flareless  D31</p>
<p><b>GE-R</b> BSPP / Flareless  D33</p>	<p><b>GE-R keg</b> BSPT / Flareless  D34</p>	<p><b>GE-M-ED</b> Metric-ED / Flareless  D35</p>	<p><b>GE-M</b> Metric / Flareless  D36</p>	<p><b>GE-M keg</b> Metric Taper / Flareless  D37</p>	<p><b>GAI-R</b> Female BSPP / Flareless  D38</p>
<p><b>GAI-M</b> Female Metric / Flareless  D39</p>	<p><b>AS</b> Butt Weld / Flareless  D40</p>	<p><b>Straight Swivels</b></p>	<p><b>RED</b> Tube End Reducer  D41</p>	<p><b>DA</b> Extender  D45</p>	<p><b>GZ</b> Swivel Union  D46</p>
<p><b>GZR</b> Swivel Union Reducer  D47</p>	<p><b>EGE-NPT</b> NPT / Flareless Swivel  D49</p>	<p><b>EGEO</b> ISO 6149 / Flareless Swivel  D50</p>	<p><b>EGE-R-ED</b> BSPP-ED / Flareless Swivel  D51</p>	<p><b>EGE-M-ED</b> Metric-ED / Flareless Swivel  D52</p>	<p><b>SKA</b> Butt Weld / Flareless Swivel  D53</p>
<p><b>KOR</b> Tube End Reducer Steel  D54</p>	<p><b>KOR</b> Tube End Reducer Stainless Steel  D57</p>	<p><b>90° Elbows</b></p>	<p><b>W</b> Union Elbow  D59</p>	<p><b>WSV</b> Bulkhead Union Elbow  D60</p>	<p><b>WE-NPT</b> NPT / Flareless  D61</p>
<p><b>WE-R keg</b> BSPT / Flareless  D62</p>	<p><b>WE-M keg</b> Metric Taper / Flareless  D63</p>	<p><b>EW</b> Flareless Swivel / Flareless  D64</p>	<p><b>EW-R-ED</b> BSPP-ED / Flareless  D65</p>	<p><b>EW-M-ED</b> Metric-ED / Flareless  D66</p>	<p><b>SWVE-R</b> Banjo BSPP / Flareless  D67</p>

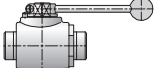
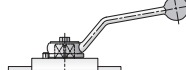
<b>SWVE-M</b> Banjo Metric / Flareless  D68	<b>WH-R</b> Banjo BSPP / Flareless  D69	<b>WH-M</b> Banjo Metric / Flareless  D70	<b>WH-R-KDS</b> Banjo BSPP / Flareless  D71	<b>WH-M-KDS</b> Banjo Metric / Flareless  D72	<b>WAS</b> Butt Weld / Flareless  D73
<b>Tees</b> 	<b>T</b> Union Tee  D74	<b>TR</b> Reducer Tee  D75	<b>ET</b> Swivel Branch Tee  D77	<b>ET-R-ED</b> BSPP-ED Branch Tee  D78	<b>ET-M-ED</b> Metric-ED Branch Tee  D79
<b>EL</b> Swivel Run Tee  D80	<b>EL-R-ED</b> BSPP-ED Run Tee  D81	<b>EL-M-ED</b> Metric-ED Run Tee  D82	<b>TH-R</b> Banjo BSPP Branch Tee  D83	<b>TH-M</b> Banjo Metric Branch Tee  D84	<b>TH-R-KDS</b> Banjo BSPP Branch Tee  D85
<b>TH-M-KDS</b> Banjo Metric Branch Tee  D86	<b>Cross</b> 	<b>K</b> Union Cross  D87			
<b>Caps and Plugs</b> 	<b>VKA</b> Flareless Cap  D88	<b>ROV</b> Flareless Plug  D89	<b>VKAM</b> Blanking Plug  D90		
<b>Plain Bearing Rotary Fittings</b> 	<b>DVGE-R</b> BSPP-ED / Flareless  D91	<b>DVGE-M</b> Metric-ED / Flareless  D92	<b>DVWE-R</b> BSPP-ED / Flareless  D93	<b>DVWE-M</b> Metric-ED / Flareless  D94	
<b>Ball Bearing Rotary Fittings</b> 	<b>DG101</b> Flareless Union  D95	<b>DG103</b> Flareless Union  D96	<b>DG105</b> Flareless Union  D97	<b>DG107</b> Union Bulkhead  D98	<b>DG108</b> 90° Union Bulkhead  D99
<b>DG102-R</b> BSPP-ED / Flareless  D100	<b>DG102-M</b> Metric-ED / Flareless  D101	<b>DG104-R</b> 90° BSPP-ED / Flareless  D102	<b>DG104-M</b> 90° Metric-ED / Flareless  D103	<b>DG106-R</b> 24° Flareless / BSPP with EOlastic Seal  D104	<b>DG106-M</b> 24° Flareless / Metric Parallel  D105

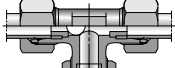
 <p><b>Check Valves</b></p>	<p><b>RHD</b> Union</p>  <p>D106</p>	<p><b>RHV-R-ED</b> BSPP-ED / Flareless</p>  <p>D107</p>	<p><b>RHV-M-ED</b> Metric-ED / Flareless</p>  <p>D108</p>	<p><b>RHZ-R-ED</b> BSPP-ED / Flareless</p>  <p>D109</p>	<p><b>RHZ-M-ED</b> Metric-ED / Flareless</p>  <p>D110</p>
<p><b>RHDI</b> Female BSPP Union</p>  <p>D111</p>	<p><b>RVP</b> Cartridge</p>  <p>D112</p>	<p><b>I-TL</b> Internal Parts</p>  <p>D113</p>	<p><b>DV</b> 24° Flareless/24° Flareless</p>  <p>D114</p>	<p><b>LD</b> 24° Flareless/24° Flareless</p>  <p>D115</p>	<p><b>VDHA</b> 24° Flareless/24° Flareless</p>  <p>D116</p>
<p><b>VDHB</b> 24° Flareless/24° Flareless</p>  <p>D117</p>	 <p><b>Ball Valves</b></p>	<p><b>KH</b> 2-Way Flareless Union</p>  <p>D118</p>	<p><b>KH-BSPP</b> 2-Way Female BSPP</p>  <p>D120</p>	<p><b>KH-NPT</b> 2-Way Female NPT</p>  <p>D122</p>	
 <p><b>Alternating Valves</b></p>	<p><b>WV</b> Union Tee</p>  <p>D124</p>				



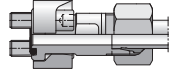
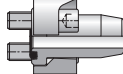
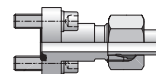
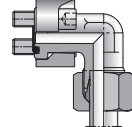
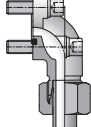



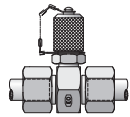
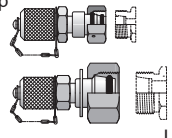
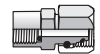
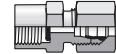

### Flange Adapters (Shown in Section K)

 <p><b>Flange Adapters</b></p>	<p><b>GFS</b> Code 61, 62 / Metric Flareless</p>  <p>K14</p>	<p><b>AS</b> Code 61, 62 / Weld Butt – Tube Metric</p>  <p>K28</p>	<p><b>BFG</b> DIN Flange / Metric Flareless</p>  <p>K15</p>	<p><b>WFS</b> Code 61, 62 / Metric Flareless</p>  <p>K35</p>	<p><b>BFW</b> DIN Flange / Metric Flareless</p>  <p>K36</p>
---	---	---	--	---	--

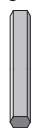
### Diagnostic and Specialty Adapters (Shown in Section L)

 <p><b>Test Point Connectors</b></p>	<p><b>GMA3</b> EO Tube / EO Tube / EMA-3 Diagnostic Tip</p>  <p>L5</p>	<p><b>VKA3</b> EO Swivel / Diagnostic Tip</p>  <p>L8</p>	<p><b>MAVE</b> BSPP Gauge / EO Swivel</p>  <p>L6</p>	<p><b>MAV</b> BSPP Gauge / EO Tube</p>  <p>L6</p>
---	---	---	---	--

### O-Rings and Seals (Shown in Section M)

 <p><b>O-Rings and Seals</b></p>	<p><b>KDS</b> Bonded Seal for Banjo Fittings</p>  <p>M8</p>	<p><b>DKA</b> Metal Seal for Banjo Fittings</p>  <p>M8</p>	<p><b>DKI</b> Pressure Gauge Sealing Ring</p>  <p>M9</p>	<p><b>EO</b> EOlastic Seal Ring</p>  <p>M6</p>	<p><b>OR</b> EO O-Ring</p>  <p>M10</p>
	<p><b>DOZ</b> EO-2 Sealing Ring</p>  <p>M7</p>	<p><b>RR</b> Metric Retaining Ring</p>  <p>M5</p>			

## EO Progressive Ring Fittings — Introduction

The flareless bite type fitting was pioneered by Ermeto in Germany in the early 1930's. When Parker Hannifin acquired Ermeto, it introduced the EO fittings to the US. Today, the EO fittings are the most widely used bite type fittings in the world.

The EO progressive ring fitting is a flareless metric fitting (for metric tube) that consists of a body, a progressive ring (ferrule) and a nut. On assembly, two cutting edges of the progressive ring "bite" into the outer surface of the tube ensuring the necessary holding power and seal for high operating pressures.



Fig. D1 — EO fitting components: Body, progressive ring and nut

The fittings and components listed in this catalog are intended solely for the assembly of connections for fluid applications.

Three series of EO tube fittings (LL, L and S) and accessories are manufactured in accordance with DIN 2353 (summary) which today is represented by international standard 8434-1 on the basis of decades of experience.\*

To ensure functional safety of EO tube fittings, only EO parts should be used in their assembly. Routing of tubes should be carried out in accordance with Parker/EO recommended practices. Assembly instructions are available.

## Design and Construction

The three components of EO fittings are designed and manufactured to produce a strong, reliable, leak-free joint upon proper assembly.

**The EO Body.** EO fitting bodies are available in over thirty configurations. The shaped products (i.e., elbows, tees, crosses) are hot forged, then machined to the stringent EO fitting specifications. The forging process used by Parker further improves the strength and metallurgical properties of the fitting material.

Straight products are made from cold drawn bar stock. The cold drawing operation ensures consistently tight dimensional tolerances, as well as significantly improved strength.

**The EO Progressive Ring (Cutting Ring).** EO progressive rings are precision machined with all dimensions and surfaces, particularly the critical bite edges, monitored on an ongoing basis. The rings are then heat treated in a manner that provides

the hardness, strength, and toughness necessary to satisfy the demanding service conditions that exist in industry today. The original progressive ring, known as DPR, is now being replaced with the new generation, called PSR. PSR is stronger and features a "positive stop" to eliminate over-tightening.

**The EO Nut.** EO fitting nuts are either cold formed, hot formed or machined from cold drawn material. The cold forming and cold drawing operations provide a more tightly packed grain structure, thus improving the material's strength. In addition, cold forming significantly improves the fatigue properties or endurance limits of the nuts.

## Standard Material Specifications

### Steel fittings:

EO tube fittings – Materials according to DIN 3859-1

### Stainless steel fittings:

EO tube fittings – X6CrNiMoTi 17122 in accordance with DIN 17440 / EN 10088, material no. 1.4571.

### Brass fittings:

EO tube fittings – CUZN35Ni2 in accordance with DIN 17660, material no. 2.0540.

**Elastomer seals:** NBR (BUNA-N), FKM (Fluorocarbon)

### Surface Finish - Steel fittings:

Standard	Body, Nuts, and Rings	Surface Finish
LL Series	Body, Nuts, and Rings	– Zinc clear chromate, Chromium 6 Free
L+S Series	Body and Nuts	– Zinc clear chromate, Chromium 6 Free
	Progressive Rings (PSR)	– Zinc clear chromate, Chromium 6 Free

Short codes for surface protection procedure in accordance with DIN 267 part 9 or DIN 50942.

## How EO Fittings Work: Function of Progressive Ring Fittings

The EO progressive ring fitting produces a low to high pressure, leak free connection of tubes and components in fluid systems. The basic function of the EO progressive ring is the controlled progressive bite of the ring into the tube due to a unique internal geometry.

The front cutting edge has already started cutting into the tube before the second cutting edge starts. As soon as both cutting edges have cut the tube to the designed depth further advance is limited by the stop edge.

Owing to the design of both cutting edges and stop edge all forces arising are equally distributed. This distribution along with the specially designed interior collar of the ring guarantees increased robustness, particularly with regard to vibration and flexure stresses. The design and function of the progressive cutting ring ensure that service vibration loading is not present in the areas of the tubing where the bite is made.

\*The selection of LL, L or S design should be made by the user on the basis of intended system pressure. The pertinent maximum recommended working pressures are shown throughout this catalog in individual data charts of the various fitting configurations.

TABLE OF CONTENTS

VISUAL INDEX



The stop edge causes a sharp increase in tightening forces which is clearly perceptible. After assembly, a visible collar of cut tube material must completely fill the space in front of the first cutting edge. With stainless steel tube and hose connections made from free cutting steel, the collar is less due to the harder material.

During assembly, it is absolutely essential that the tube is held firmly against the stop in the inner cone of the fitting; if not, the cutting process will not take place satisfactorily. Reassembly can be performed an unlimited number of times.

## Assembly and Installation

Please refer to Section R for the assembly and installation instructions for EO and EO-2 Metric Bite type fittings.

### Weld Nipples

EO weld nipple fittings with an O-ring seal between weld nipple and body give impressive pull out resistance and sealing integrity, and a sensible alternative to the progressive ring. Fittings bodies and nuts are fully interchangeable for weld nipple and progressive ring fittings of the same series and tube outside diameter. Weld nipples SKA conform to DIN 3865 form A, which today is represented by international standard ISO 8434-4.

### Ball Bearing Rotary Fittings

**DG Ball Bearing Rotary Fittings:** These compact, maintenance-free construction, service proven fittings combine ball and plain bearings with constant lubrication and relatively wear resistant annular piston seals. They are rated for working pressures up to 250 bar, have a low starting torque and have a suitable pressure/RPM rate.

Ball bearing rotary fittings are designed for connecting a fixed point to a rotating, swiveling or moving machine part via tubing or hoses. Thus axial torsion of tubing or hoses can be prevented. They are suitable for hydraulic oils and lubricants of mineral oil base, not suitable for water or gases. Nominal temperature range is -25°C to +80°C.

#### Fitting Instructions:

The life of rotary fitting depends considerably in a stress-free line connection. Therefore, the direct connection with tube is to be avoided. For connection to hoses the use of swivel nut fittings is recommended with short, straight lines (approx. length 5x hose O.D.). Thus shocks and vibrations can be absorbed.

Assemble tube ends in accordance with the Tube End Assembly Information on pages R12 through R13. Assemble BSPP and metric stud ends in accordance with torque values on page R5.

### Plain Bearing Rotary Fittings

**Plain Bearing Rotary Fittings:** These compact, maintenance-free construction, service proven fittings are rated for low pressure tube and hose with slow rotating, swiveling or moving machine parts up to 64 bar (L series) and 160 bar (S series).

Plain bearing rotary fittings are designed for connecting a fixed point to a rotating, swiveling or moving machine part via tubing or hoses. Thus axial torsion of tubing or hoses can be prevented. They are suitable for hydraulic oils and lubricants of mineral oil base, not suitable for water or gases. Nominal temperature range is -35°C to +100°C.

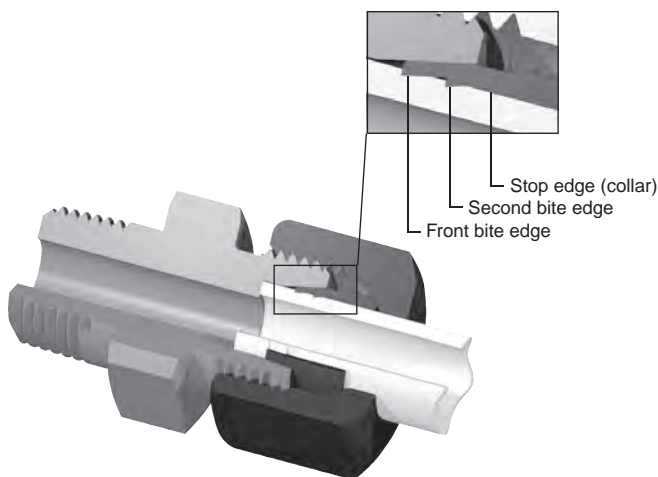

Fig. D2 — How EO fittings work

Tube O.D.	Nominal bore (mm)	Permissible number of revolutions (rpm) under a working pressure** of:					Torque at 250 bar/Nm
		25 bar	64 bar	100 bar	160 bar	250 bar	
6 8	5.0	1500	750	400	200	85	0.08
12 16	9.5	800	400	200	100	45	0.24
20 25	16.0	300	150	75	38	15	0.8
30 38	26.0	200	100	50	25	10	2.0

Table D1 — Ball Bearing Recommended RPM and Starting Torques

\*\*A minimum working pressure of 10 bar is necessary.

Series L Tube O.D.	6	8	10	12	15	18	22	28	35	
Permissible RPM	28	28	21	17	13	10	10	7	7	
Series S Tube O.D.	6	8	10	12	14	16	20	25	30	38
Permissible RPM	11	11	9	7	5	5	4	4	3	3

Table D2 — Plain Bearing Recommended RPM

TABLE OF CONTENTS

VISUAL INDEX

D

### Fitting Instructions:

The life of a rotary fitting depends considerably in a stress-free line connection. Therefore, the direct connection with tube is to be avoided. For connection to hoses, the use of swivel nut fittings is recommended with short, straight lines (approx. length 5x hose O.D.). Thus, shocks and vibrations can be absorbed.

### Non-Return Valves

**Characteristics:** Sealing is achieved by using a 90° cone with a packing washer of synthetic material. Valve has a lift stop which provides safe free outlet, shock-absorbing, muffled opening and no reduction of cross section. Maximum flow velocity not more than 8 m/sec (for higher flow velocities special tests are required).

**Opening Pressure:** Approximately 1 bar standard (on request also 0.2, 0.5, 2, 3, 4, 5 & 6 bar are available). Please specify nonstandard opening pressures on order as follows: Tube Fitting part number, opening pressure, material. Ex: RHD12L2BCF is a RHD12LCF with 2 bar opening pressure. Tolerance of (cracking) pressure is ±20%.

## Tube Recommendations

**For steel and stainless steel tube recommendations, as well as tube wall thickness information, please refer to Metric Tube, Section P.**

Seamless cold drawn steel tubes made from material St. 35.4 or from conditioned base material St. 37.4 in accordance with DIN 1630, state of delivery NBK (normal annealed) with tube outer and inner diameter tolerances in accordance with DIN 2391/ISO 3304. Max. hardness: HRB 75.

**For stainless steel fittings:  
Material no. 1.4571 and 1.4541**

Seamless drawn tubes made from austenitic, stainless steel materials no. 1.4571 and 1.4541, in accordance with DIN/EN/ISO 1127. Max. hardness: HRB 90.

These tubes are particularly recommended for tube fittings, since the tube outer diameter and wall thickness, tolerances correspond to those of steel tubes in accordance with DIN 2391/ISO 3304.

**For brass fittings:**

Seamless drawn copper tube made from material with short code SF-Cu F37 in accordance with DIN 1786.

**Tube wall thicknesses:**

In order to determine the necessary tube wall thicknesses for applications, refer to the calculated pressures provided in the tables for EO metric tubing. The calculated pressures DIN 2413-I are for static and DIN 2413-III for dynamic loads.

The maximum wall thickness is based on the pressure holding capacity of the fitting. In some cases, the wall thickness of the tube might be too thin for reliable service and an insert must be used to prevent excessive tube collapse. See assembly section for recommended tube wall thicknesses.

**Plastic tube:**

EO fittings are suitable for use with various types of plastic tubes such as nylon, polyethylene, etc. When used with plastic tube, an insert (see page D21) must be used to prevent tube pull out

## Features, Advantages & Benefits

- **Visible Bite** — The critical front bite of the progressive ring is clearly visible to tube fitters & inspectors. The presence of the recommended bite virtually eliminates any risk of catastrophic blow-off. This is a very important safety feature.
- **Sealing Capability** — EO fittings have demonstrated a remarkable ability to remain leak free under various service conditions ranging from sealing high vacuum and small molecules gases to high pressure hydraulic fluids.
- **Distributed Stresses** — Stresses due to service flexural loading are distributed at several points in the joint, thus stress concentration in the bite is minimized.
- **Vibration Control** — The rear bevel of the ferrule firmly grips tubing, thus dampening the effects of system vibration in the joint.
- **Progressive Ring Design** — The progressive ring design provides a second bite for improved reliability and higher working pressure capability. This design also decreases the risk of improper assembly because of the sharp, high torque rise which occurs when the fitting is properly tightened.
- **Envelope Size** — EO fittings are relatively small and compact, making it a suitable selection for plumbing in limited or tight space.
- **Temperature Rating** — EO fittings are suitable for sub-zero through elevated temperature applications. Service temperature rating is limited by the material chosen.
- **Compatibility** — Since EO fittings can be manufactured from a wide range of metals, its compatibility factor with various fluids and atmospheric conditions is virtually limitless. One simply has to select and specify EO fittings from an acceptable material that best satisfies the service conditions.
- **Tube Wall** — EO fittings are suitable for use with light wall, medium wall, heavy wall, and extra heavy wall tubing. (Light wall tube may require support sleeve (VH), as shown in Assembly/Installation Section.)
- **Re-Usability / Remakeability** — Joints can be disassembled and reassembled many times to facilitate system maintenance. This reduces the labor and material costs that would otherwise result from tube and fittings replacement.
- **Assembly** — No expensive, complicated tooling is necessary to assemble EO fittings. Assembly is simple when the procedures described in the Assembly / Installation section are followed (see pages R35 - R43).
- **Materials** — EO fittings can be manufactured from almost any metallic material. The more popular materials currently used for EO fittings are: stainless steel, carbon steel, and brass. On request, the Tube Fitting Division will machine EO fittings from other appropriate material specified by users.
- **Manufacture** — EO fittings are manufactured under tight quality control which ensures that the product routinely satisfies or surpasses the requirements of the pertinent industrial standards.
- **World Wide Popularity** — The bite type fitting design has worldwide acceptance and is especially popular in Europe.
- **Superior Plating:** Parker's EO/EO2 steel fittings come standard with ToughShield (TS1000) plating, giving them unmatched protection against red rust. In ASTM B117 neutral salt spray testing, TS1000 remained rust free for up to 1,000 hours, far exceeding SAE industry requirements of 96 hours and also outperforming the competition. See [www.ravagesofredrust.com](http://www.ravagesofredrust.com) for more information.



- **Finish** — Steel EO fittings have a zinc clear Chromium-6 Free finish. This finish provides good corrosion protection.
- **Silver Plated Nuts** — Stainless steel tube nuts are pre-lubricated with silver plated threads (size 15L-42L, 12S-38S). Thread galling is eliminated and assembly torque is reduced as much as 40 percent. This increases the speed and efficiency for stainless steel fitting assembly.
- **Availability** — EO fittings are available as standard in over thirty different configurations, and as many as twenty-seven different size combinations in some configurations.
- **Configurations** — Popular configurations for EO fittings are shown in the Visual Index. Other configurations can be manufactured on request.

## EO-2 Fitting System — Introduction

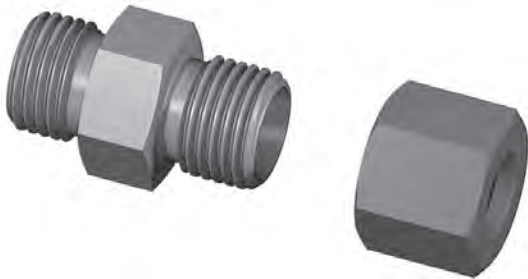

Fig. D3 — EO-2: Fitting body and functional nut

The EO-2 high pressure tube fitting generation is the most recent development of the Tube Fitting Division Europe. It was introduced in an effort to eliminate leakage in all fluid systems.

The common feature of all EO-2 fittings is elastomeric seals on all joints. This assures leakfree operation without retightening — even under severe working conditions. Another breakthrough in bite-type technology is the simple assembly and cost-saving handling of the unique EO-2 Functional Nut.

EO-2 is a true metric design according to 24° bite-type standards such as: ISO 8434-1, DIN 2353 or DIN 3861. It covers all three series (LL, L and S) of the broad EO tube fitting program.

This resulted in a great acceptance with equipment manufactures that are targeting an absolute leakfree systems without sacrificing the convenience of using metric bite type fittings.

## Design and Construction

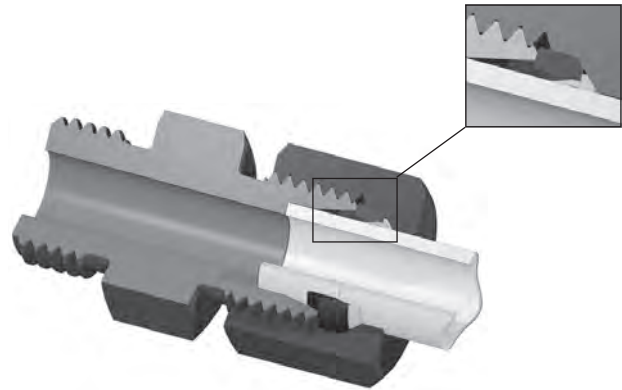

Fig. D4 — EO-2: The metallic support of the sealing ring acts just like an integrated preassembly tool.

### Elastomeric Sealing

The elastomeric seal assures a hermetically sealed tube joint. It is located in between the inner cone of the fitting body and the tube surface, thus blocking the only possible leak path. Due to its large cross-section, the seal effectively compensates for all manufacturing tolerances on tube and fitting cone.

The sealing effect is pressure supported which makes the EO-2 fitting suitable for high pressure applications. The static compression also eliminates air-ingress into the fluid system at underpressure conditions.

Elastomerically sealed EO-2 fittings do not require any retightening even in heavy-duty applications. Seal extrusion is prevented by proper housing without gaps or dead volume. The sealing lip is bonded to a metallic support ring.

## Standard Material Specifications

### Steel fittings:

EO-2 tube fittings — Materials according to DIN 3859-1

### Stainless steel fittings:

EO-2 tube fittings — X6CrNiMoTi 17122 in accordance with DIN 17440 / EN 10088, material no. 1.4571.

### Brass fittings:

EO-2 tube fittings — CUZN35Ni2 in accordance with DIN 17660, material no. 2.0540.

**Elastomer seals:** NBR (BUNA-N), FPM (Fluorocarbon)

### Surface Finish - Steel fittings:

Standard

LL Series	Body, Nuts, and Rings	- Zinc clear chromate, Chromium 6 Free
L+S Series	Body and Nuts	- Zinc clear chromate, Chromium 6 Free

Short codes for surface protection procedure in accordance with DIN 267 part 9 or DIN 50942.

TABLE OF CONTENTS

VISUAL INDEX

D



## How EO-2 Fittings Work

The retaining ring bites into the tube in accordance to the proven bite ring principle. The elastomeric seal reduces the danger of over- or underassembly by a special EO-2 design feature: Before assembly there is a gap in between the flat surfaces of the retaining ring and the metallic support ring of the seal. As soon as the retaining ring has reached the proper incision depth, the gap closes, resulting in a sharp increase of assembly torque. This results in uniform and reliable fitting assemblies. The assembly result can easily be inspected by just checking if the gap is closed.

The separation of sealing and holding functions to two separate elements finally allows a more effective solution of the over- and undertightening problems typically associated with bite type fittings.

## Assembly and Installation

Please refer to Section R for the assembly and installation instructions for EO and EO-2 Metric Bite type fittings.

### Integrated Assembly Tool

The metallic support ring of the seal is made of a specially designed material and heat-treatment to act as an assembly tool. This makes sure that the retaining ring securely cuts into the tube surface without damaging the sensitive inner cone of the fitting body.

This unique feature of EO-2 fittings even allows direct assembly of tube without any additional pre-assembly process. An EOMAT machine (or other hydraulic tool) is strongly recommended to allow easy assembly of large dimension tube and drastically save total assembly time, effort and costs. The integrated assembly tool of EO-2 fittings even helps to save further costs and trouble when using an EOMAT-type presetting machine: As the presetting cone is only in contact with the elastomeric sealing lip, it cannot be worn out or damaged even after thousands of assemblies. This not only saves replacement costs but also avoids leakage problems caused by worn presetting tools.

### The Functional Nut



Fig. D5 — The unique Functional Nut allows easy handling and quick assembly.

The unique Functional Nut simplifies handling of fitting components and helps to minimize storage and procurement costs.

The sealing and retaining rings are combined as a pair and are inserted into the internal thread of the nut in such a manner that they cannot fall out, so that these three parts form one functional element.

Individual components such as seal or retaining ring cannot be forgotten, confused or assembled in the wrong orientation. Time and cost are saved by eliminating searching and arranging the components to make up individual joints.

Functional Nuts are completely interchangeable with the full range of EO tube fitting ends.

After assembly and disassembly, the sealing ring can be replaced individually without cutting off the tube end.

## Tube Recommendations

### For steel fittings:

Seamless cold drawn steel tubes made from material St. 35.4 or from conditioned base material St. 37.4 in accordance with DIN 1630, state of delivery NBK (normal annealed) with tube outer and inner diameter tolerances in accordance with DIN 2391/ISO 3304. Max. hardness: HRB 75.

### For stainless steel fittings:

#### Material no. 1.4571 and 1.4541

Seamless drawn tubes made from austenitic, stainless steel materials no. 1.4571 and 1.4541, in accordance with DIN/EN/ISO 1127. Max. hardness: HRB 90.

These tubes are particularly recommended for tube fittings, since the tube outer diameter and wall thickness, tolerances correspond to those of steel tubes in accordance with DIN 2391/ISO 3304.

### Tube wall thicknesses:

In order to determine the necessary tube wall thicknesses for applications, refer to the calculated pressures provided in the tables for EO metric tubing. The calculated pressures DIN 2413-I are for static and DIN 2413-III for dynamic loads.

The maximum wall thickness is based on the pressure holding capacity of the fitting. In some cases, the wall thickness of the tube might be too thin for reliable service and an insert must be used to prevent excessive tube collapse. See assembly section for recommended tube wall thicknesses.

### Plastic tube:

EO-2 fittings are suitable for use with various types of plastic tubes such as nylon, polyethylene, etc. When used with plastic tube, an insert (see page D21) must be used to prevent tube pull out due to tensile loading.

## Features, Advantages and Benefits of the EO-2 Fitting System

In addition to the general advantages of the EO tube fitting system, the unique EO-2 fitting features offer even more specific benefits:

- **Sealing Capability** — An elastomeric seal forms the primary sealing element, thus assuring leak-free sealing. Even low-viscosity media such as water or gas are hermetically sealed. Hydraulic systems, therefore, do not “sweat” at fittings.
- **High Pressure Resistance** — EO-2 fittings are rated up to Pmax 900 bar. Sealing lip and seal arrangements have both been designed so that the sealing effect is supported by system pressure. The interaction of the retaining ring and the integrated preassembly tool results in uniform and reliable fitting assembly.
- **Durability** — The elastomeric seal does not require any retightening even after years of operation under severe working conditions.
- **Bite Control** — The ideal bite depth is controlled by the fitting design rather than by the fitters force. Closing the gap at the end of the manual assembly, the fitter gets clear signal that setting is completed and the joint is ready for inspection.
- **Functional Nut** — Individual components such as the retaining ring or seal cannot be lost, forgotten, confused or assembled in the wrong orientation. This dramatically saves assembly cost and helps to avoid dangerous assembly errors.
- **Assembly Cost** — With less than 10 seconds cycle time on the EOMAT III/A (actual presetting process: 1.4 seconds), the cost of presetting EO-2 is extremely low.
- **Integrated Preassembly Tool** — Each EO-2 Functional Nut comes assembled with an integrated assembly tool that makes sure that the retaining ring securely cuts into the tube surface without damaging the sensitive inner cone of the fitting body. This greatly reduces the danger of tube blow-off, even when using stainless steel tube.
- **Unlimited Presetting Tool Lifetime** — When EOMAT machines are used for cost-efficient presetting, the preassembly tools do not wear out as they are only in contact with the rubber seal. This avoids dangerous blow-off which can result when traditional bite-type fittings are assembled using worn presetting tools.
- **Make-up** — From the wrench-tight position of the preset EO-2 joint, one short pull on the wrench (approx. 1/6 to 1/4 turn) gives the assembly a quick high rise to required torque. EO-2 fittings have a solid “hit-home-feel” and excellent over-torque resistance.
- **Visible Inspection** — There is no doubt if an EO-2 Functional Nut has been preset correctly or not. Inspection is as simple as checking if the gap between retaining ring and sealing ring is completely closed. The tube end does not have to be disassembled out of the fitting for bite inspection.
- **No Phantom Leaks** — Lubrication is not mandatory for the assembly of steel EO-2 fittings. The machine operator will not be irritated about lubricant coming out of the fittings once the hydraulic system gets hot.
- **Re-Usability/Remakeability** — EO-2 fittings can be disassembled and reassembled many times. There is no wear or widening of the vulnerable inner cone. Damaged seals can easily be replaced. All spare DOZ-seals are marked by size-code (e.g.: 12-L).
- **On-Site Maintenance** — For the maintenance and replacement of EO-2 fittings a set of wrenches is sufficient. Additional in line components, such as test points (GMA), ball valves (KH) or T-fittings can be added to an existing assembly within minutes.
- **Interchangeability** — The EO-2 Functional Nut can be used for the whole variety of the broad range of more than 50 configurations in some 25 sizes of standard EO LL, L and S-series fittings. Changeover from Progressive ring or weld nipple is easy by the simple use of EO-2 Functional Nuts.
- **Reliability** — Millions of EO-2 fittings are working trouble-free in applications like: Mobile construction equipment, stationary machine tools, hydraulic presses, plastic injection molding machines, shipbuilding, offshore exploration, submarines, railway trains and military equipment. Leakage does not occur on EO-2 pipework.
- **Trouble-Free** — Regular bite type fittings allow typical assembly-errors such as: confusion of bite type ring material and size. Also, the use of worn-out preassembly tool may result in fitting failure. The clever EO-2 design eliminates most of these mistakes without making the assembly process more complicated.
- **Popularity** — EO-2 fittings are as easy to assemble as traditional bite type fittings, but they eliminate most of their typical assembly problems. EO-2 fittings are therefore appreciated by an increasing number of original equipment manufacturers. EO-2 also has become the fitting of choice of end-users that appreciate the leakfree performance, the easy maintenance and the global availability of the metric soft-seal bite type system.

TABLE  
OF  
CONTENTS

VISUAL  
INDEX

D



# How to order



DIN fittings

## GE-R-ED Male stud connector

Male BSPP thread – ED-seal (ISO 1179) / EO 24° cone end

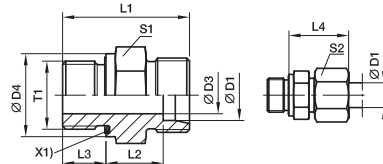

X1) Elastoc-sealing ED

Series	D1	T1	D3	D4	L1	L2	L3	L4	S1	S2	Weight g/1 piece	Order code*	PN (bar <sup>1)</sup> )		
													CF	71	MS
LL <sup>2)</sup>	G 1/8 A	3	14	20.0	9.5	6.5	19	14	10	10	10	GE04LLREDOMD	100	100	63
	G 1/8 A	4	14	20.0	8.0	6.5	20	14	12	11	11	GE06LLREDOMD	100	100	63
L <sup>3)</sup>	G 1/8 A	4	14	23.5	8.5	8.0	23	14	14	13	13	GE06LREDOMD	500	315	200
	G 1/4 A	4	19	29.0	10.0	12.0	25	19	14	28	28	GE06LR1/4EDOMD	500	315	200
G 3/8 A	4	22	30.5	11.5	12.0	26	22	14	44	44	44	GE06LR3/8EDOMD	420	315	200
G 1/2 A	4	27	33.0	12.0	14.0	27	27	14	61	61	61	GE06LR1/2EDOMD	400	315	200
G 1/4 A	6	19	29.0	10.0	12.0	25	19	17	27	27	27	GE08LREDOMD	500	315	200
G 1/8 A	4	14	24.5	9.5	8.0	24	14	17	16	16	16	GE08LR1/8EDOMD	500	315	200
G 3/8 A	6	22	30.5	11.5	12.0	26	22	17	45	45	45	GE08LR3/8EDOMD	420	315	200
G 1/2 A	6	27	33.0	12.0	14.0	27	27	17	74	74	74	GE08LR1/2EDOMD	400	315	200
G 1/4 A	6	19	30.0	11.0	12.0	26	19	19	29	29	29	GE10LREDOMD	500	315	200
G 1/8 A	4	14	25.5	10.5	8.0	25	17	19	21	21	21	GE10LR1/8EDOMD	500	315	200
G 3/8 A	8	22	31.5	12.5	12.0	27	22	19	43	43	43	GE10LR3/8EDOMD	420	315	200
G 1/2 A	8	27	34.0	13.0	14.0	28	27	19	71	71	71	GE12LR1/8EDOMD	400	315	200
G 3/8 A	9	22	31.5	12.5	12.0	27	22	22	41	41	41	GE12LR1/4EDOMD	420	315	200
G 1/8 A	4	14	26.5	11.5	8.0	26	19	22	26	26	26	GE12LR1/2EDOMD	420	315	200
G 1/4 A	6	19	31.0	12.0	12.0	27	19	22	35	35	35	GE12LR3/4EDOMD	400	315	200
G 1/2 A	10	27	34.0	13.0	14.0	28	27	22	59	59	59	GE15LR3/8EDOMD	400	315	200
G 3/4 A	10	32	37.0	14.0	16.0	29	32	22	110	110	110	GE15LR1/2EDOMD	400	315	200
G 1/2 A	11	27	35.0	14.0	14.0	29	27	27	77	77	77	GE15LR3/4EDOMD	400	315	200
G 3/8 A	9	22	32.5	13.5	12.0	29	24	27	110	110	110	GE15LR3/8EDOMD	400	315	200
G 3/4 A	12	32	38.0	15.0	16.0	30	32	27	110	110	110	GE15LR3/4EDOMD	400	315	200
G 1/2 A	14	27	36.0	14.5	14.0	31	27	32	110	110	110	GE18LREDOMD	250	160	100
G 3/8 A	9	22	33.5	14.0	12.0	30	27	32	66	66	66	GE22LR1/2EDOMD	250	160	100
G 3/4 A	15	32	38.0	14.5	16.0	31	32	32	110	110	110	GE22LR1/4EDOMD	250	160	100
G 1/4 A	18	32	40.0	16.5	16.0	33	32	36	102	102	102	GE22LR1/8EDOMD	250	160	100
G 1/2 A	14	27	38.0	16.5	14.0	33	32	36	91	91	91	GE22LR1/2EDOMD	250	160	100
G 1 A	19	40	43.0	17.5	18.0	34	41	36	189	189	189	GE28LREDOMD	250	160	100
G 3/4 A	23	40	43.0	17.5	18.0	34	41	41	170	170	170	GE28LR3/4EDOMD	250	160	100
G 1/4 A	18	32	41.0	17.5	16.0	34	41	41	159	159	159	GE28LR1/4EDOMD	250	160	100
G 1/4 A	24	50	48.0	18.5	20.0	35	50	41	316	316	316	GE28LR1/4EDOMD	250	160	100
G 1/4 A	30	50	48.0	17.5	20.0	39	50	50	272	272	272	GE35LREDOMD	250	160	100
G 1 A	23	40	46.0	17.5	18.0	39	46	50	226	226	226	GE35LR1EDOMD	250	160	100
G 1/2 A	30	55	52.0	19.5	22.0	41	55	50	423	423	423	GE35LR11/2EDOMD	250	160	100
G 1/2 A	36	55	52.0	19.0	22.0	42	55	60	343	343	343	GE42LREDOMD	250	160	100
G 1 A	23	40	48.0	19.0	18.0	42	55	60	324	324	324	GE42LR1/4EDOMD	250	160	100
G 1/4 A	30	50	50.0	19.0	20.0	42	55	60	348	348	348	GE42LR11/4EDOMD	250	160	100

<sup>1)</sup> Pressure shown = item deliverable  
<sup>2)</sup> LL = very light series; <sup>3)</sup> L = light series  
PN (bar) = PN (MPa)  
10

Delivery without nut and ring. Information on ordering complete fittings or alternative sealing materials see page 17.

\*Please add the suffixes below according to the material/surface required.

Material	Standard sealing material (no additional suffix needed)
Steel, zinc plated, Cr(VI)-free	NBR
Stainless Steel	VIT
Brass	NBR

## The right way to order made easy!

### Step 1 Selecting order code

- All fitting sizes available in our fitting program are clearly listed in the index at the front of this catalogue.
- Open the catalogue at the corresponding page containing detailed information of the product of your choice.
- Select the required fitting size! The basic order code is printed in bold type on the right-hand side of the table of dimensions.

Example: **GE16SREDOMD**

### Step 2 Selecting material, surface and sealing-material

Now simply add the corresponding code for the surface and material variant of the product you require to the basic order code. This code is contained in the table printed at the bottom of every page.

#### 2.1 Alternative sealing material

Example: Cr(VI)-free steel fitting with ED-seal in FKM material.  
GE16SRED+OMD+VIT+CF  
= **GE16SREDVITOMDCF**

Example: Stainless steel fitting with ED-seal in NBR material (e. g. Perbunan).  
GE16SREDOMD+NBR+71  
= **GE16SREDNBROMD71**

### Step 3 When ordering fittings complete with nuts and rings

- Metal sealed cutting rings PSR/DPR/D: For these types please delete the 'OMD' or 'X' suffixes.  
Example: **GE16SREDCF**
- Soft sealed EO-2 functional nut: For these types please delete the 'OMD' or 'X' suffixes and add a 'Z' before the series suffix (LL, L, S)  
Example: **order with EO-2 functional nut**  
GE16(+Z)SREDCF  
= **GE16ZSREDCF**

Perbunan = registered trademark of Bayer



## How to order EO-Fittings:

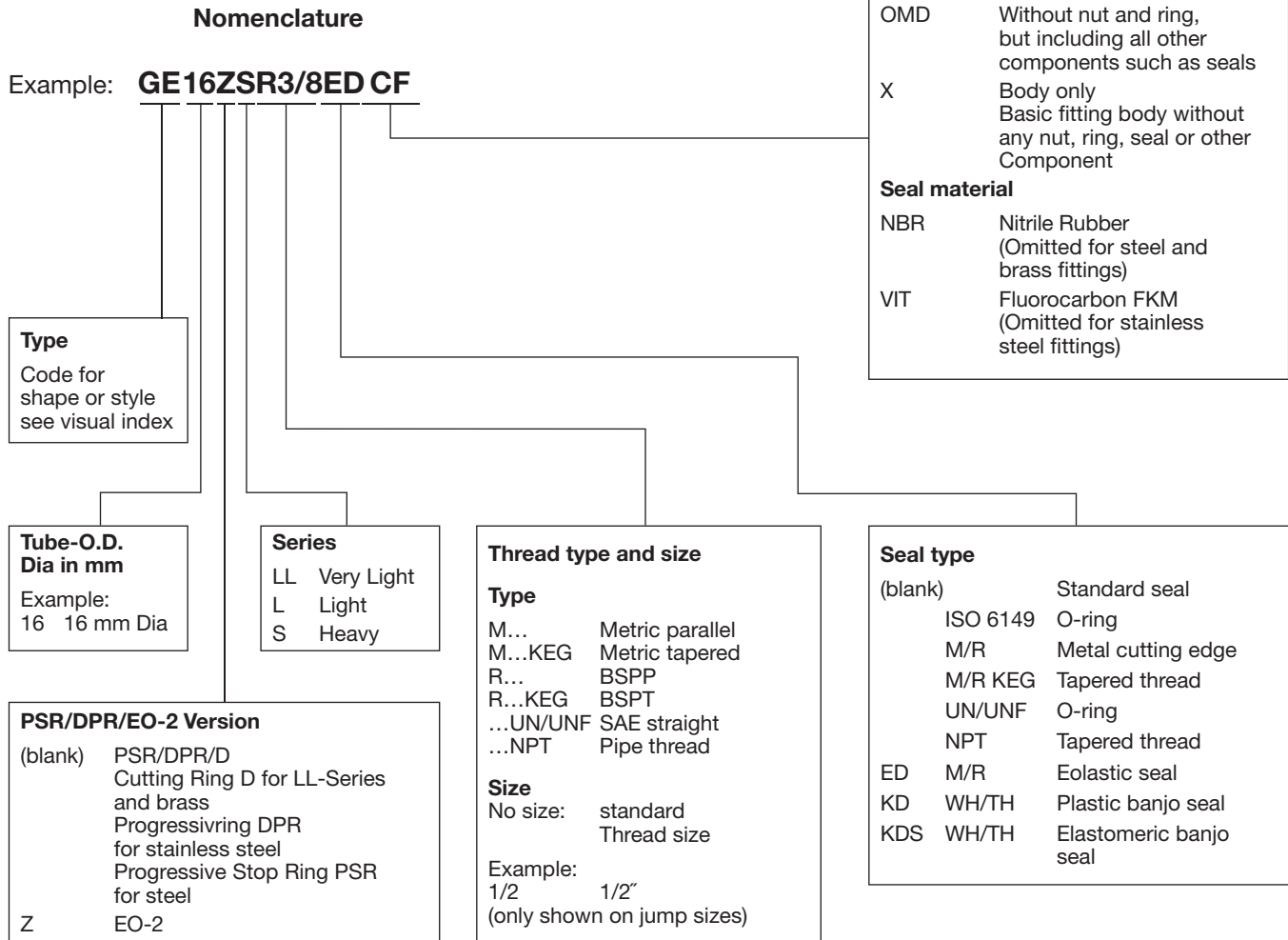

Examples		Examples	
Order code	Description	Order code	Description
GE12ZSR1/2EDCF	Straight male stud, EO-2, 20 mm tube O.D., heavy series, G 1/2 BSPP, Eolastic seal, complete with nut and ring, Cr(VI)-free steel fitting, all seals NBR	EVT08LOMDMS	Adjustable standpipe branch tee, 8 mm tube O.D., light series, brass fitting without nut and ring, standpipe preassembled with nut and ring.
GE12LR71X	Straight male stud, 12 mm tube O.D., light series, G 3/8 BSPP, metal seal type B, stainless steel fitting, body only	EL38VITOMDCF	Adjustable swivel nut run tee 38 mm tube O.D., heavy series, zinc-plated steel fitting without nut and ring. Swivel nut end with FKM seal
		DOZ04LL	Spare seal for EO-2 joints, 4 mm O.D., very light series, steel with nitrile rubber seal

Perbunan = registered trademark of Bayer

# EO and EO-2 Metric Tube Ends

TABLE OF CONTENTS

VISUAL INDEX

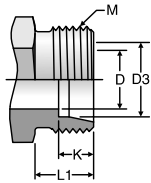

EO/EO-2 Male Tube End

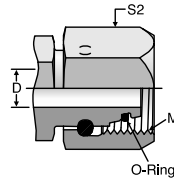

EO/EO-2 Swivel

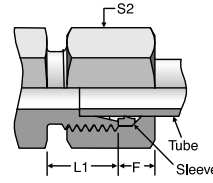

EO/EO-2 Assembly

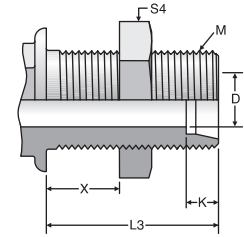

EO/EO-2 Bulkhead

	End Size	Thread	Drill	Tube Nut Assembled Allowance	Tube Depth	Male Turn Back	Bulkhead Length	Tube/Swivel Nut Hex	Bulkhead Nut Hex	Max Bulkhead Thickness
Size	D3 (mm)	M Metric	D (mm)	F (mm)	K (mm)	L1 (mm)	L3 (mm)	S2 (mm)	S4 (mm)	X (mm)
4LL	4	M8x1	3	5.5	4.2	8	—	10	—	—
6LL	6	M10x1	4.5	6	5.7	8	—	12	—	—
8LL	8	M12x1	6	6	5.7	9	—	14	—	—
10LL	10	M14x1	8	6	5.7	9	—	17	—	—
12LL	12	M16x1	10	6	6.2	9	—	19	—	—
6L	6	M12x1.5	4	8	7.2	10	34	14	17	16
8L	8	M14x1.5	6	8	7.2	10	34	17	19	16
10L	10	M16x1.5	8	8	7.2	11	35	19	22	16
12L	12	M18x1.5	10	8	7.2	11	36	22	24	16
15L	15	M22x1.5	12	8	7.2	12	38	27	30	16
18L	18	M26x1.5	15	9	7.7	12	40	32	36	16
22L	22	M30x2	19	9	7.7	14	42	36	41	16
28L	28	M36x2	24	9	7.7	14	43	41	46	16
35L	35	M45x2	30	11	10.7	16	47	50	55	16
42L	42	M52x2	36	12	11.2	16	47	60	65	16
6S	6	M14x1.5	4	8	7.2	12	36	17	19	16
8S	8	M16x1.5	5	8	7.2	12	36	19	22	16
10S	10	M18x1.5	7	9	7.7	12	37	22	24	16
12S	12	M20x1.5	8	9	7.7	12	38	24	27	16
14S	14	M22x1.5	10	10	8.2	14	40	27	30	16
16S	16	M24x1.5	12	10	8.7	14	41	30	32	16
20S	20	M30x2	16	11	10.7	16	44	36	41	16
25S	25	M36x2	20	12	12.2	18	47	46	46	16
30S	30	M42x2	25	13	13.7	20	51	50	50	16
38S	38	M52x2	32	15	16.2	22	53	60	65	16

Note: For port and stud end dimensions reference section E: Pipe Fittings and Port Adapters.

Click here for CADs, Support Resources or to Configure Parts Online

**M**  
Nut

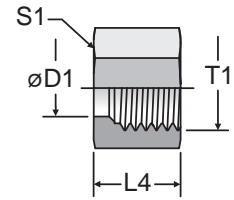

TABLE OF CONTENTS

VISUAL INDEX

**D**

FAQs

ASSEMBLY

TUBE FAB EQUIP

GEN TECH

Series	D1	T1	L4	S1	Weight g/1 piece	Order code*	PN (bar) <sup>1)</sup>		
							CF	71	MS
LL <sup>2)</sup>	04	M 08×1.0	11.0	10	4	M04LL	100	100	63
	06	M 10×1.0	11.5	12	6	M06LL	100	100	63
	08	M 12×1.0	12.0	14	7	M08LL	100	100	63
	10	M 14×1.0	12.5	17	11	M10LL	100	100	63
	12	M 16×1.0	13.0	19	13	M12LL	100	100	63
L <sup>3)</sup>	06	M 12×1.5	14.5	14	10	M06L	500	315	200
	08	M 14×1.5	14.5	17	15	M08L	500	315	200
	10	M 16×1.5	15.5	19	18	M10L	500	315	200
	12	M 18×1.5	15.5	22	25	M12L	400	315	200
	15	M 22×1.5	17.0	27	42	M15L	400	315	200
	18	M 26×1.5	18.0	32	62	M18L	400	315	200
	22	M 30×2.0	20.0	36	82	M22L	250	160	100
	28	M 36×2.0	21.0	41	89	M28L	250	160	100
	35	M 45×2.0	24.0	50	137	M35L	250	160	100
	42	M 52×2.0	24.0	60	216	M42L	250	160	100
S <sup>4)</sup>	06	M 14×1.5	16.5	17	17	M06S	800	630	400
	08	M 16×1.5	16.5	19	20	M08S	800	630	400
	10	M 18×1.5	17.5	22	31	M10S	800	630	400
	12	M 20×1.5	17.5	24	34	M12S	630	630	400
	16	M 24×1.5	20.5	30	66	M16S	630	400	250
	20	M 30×2.0	24.0	36	102	M20S	420	400	250
	25	M 36×2.0	27.0	46	202	M25S	420	400	250
	30	M 42×2.0	29.0	50	219	M30S	420	400	250
	38	M 52×2.0	32.5	60	339	M38S	420	315	200

<sup>1)</sup> Pressure shown = item deliverable

<sup>2)</sup> LL = very light series; <sup>3)</sup> L = light series; <sup>4)</sup> S = heavy series

$$\frac{\text{PN (bar)}}{10} = \text{PN (MPa)}$$

**WARNING:** This product can expose you to chemicals including Lead and Lead Compounds which is known to the State of California to cause cancer and birth defects or other reproductive harm. For more information go to [www.p65warnings.ca.gov](http://www.p65warnings.ca.gov).

\*Please add the **suffixes** below according to the material/surface required.

Order code suffixes		
Material	Suffix surface and material	Example
Steel, zinc plated, Cr(VI)-free	CFX	M16SCFX
Stainless Steel	EODURX	M16SEODURX
Brass	MSX	M16SMSX

[Click here for CADs, Support Resources or to Configure Parts Online](#)

# FM

## EO-2 Dual Function Nut

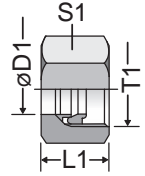

X1) Retaining ring

TABLE OF CONTENTS

VISUAL INDEX

FAQs

ASSEMBLY

TUBE FAB EQUIP

GEN TECH

Series	D1 	T1	L1	S1	Order code				Weight g/1 piece	
					FM...CF Steel, zinc plated Cr(VI) free passiv. +Sealing Sealing NBR	PN (bar)	FM...VITCF Steel, zinc plated Cr(VI) free passiv. +Sealing Sealing FKM	PN (bar)		
LL	04	M 08×1.0	11.0	10	FM04LLCF	100	—	100	5	
	06	M 10×1.0	11.5	12	—	—	—	—	6	
L	06	M 12×1.5	14.5	14	FM06LCF	500	FM06LVITCF	500	12	
	08	M 14×1.5	14.5	17	FM08LCF	500	FM08LVITCF	500	17	
	10	M 16×1.5	15.5	19	FM10LCF	500	FM10LVITCF	500	22	
	12	M 18×1.5	15.5	22	FM12LCF	400	FM12LVITCF	400	30	
	15	M 22×1.5	17.0	27	FM15LCF	400	FM15LVITCF	400	48	
	18	M 26×1.5	18.0	32	FM18LCF	400	FM18LVITCF	400	70	
	22	M 30×2.0	20.0	36	FM22LCF	250	FM22LVITCF	250	94	
	28	M 36×2.0	21.0	41	FM28LCF	250	FM28LVITCF	250	106	
	35	M 45×2.0	24.0	50	FM35LCF	250	FM35LVITCF	250	160	
	42	M 52×2.0	24.0	60	FM42LCF	250	FM42LVITCF	250	244	
	S	06	M 14×1.5	16.5	17	FM06SCF	800	FM06SVITCF	800	20
		08	M 16×1.5	16.5	19	FM08SCF	800	FM08SVITCF	800	23
10		M 18×1.5	17.5	22	FM10SCF	800	FM10SVITCF	800	37	
12		M 20×1.5	17.5	24	FM12SCF	630	FM12SVITCF	630	39	
16		M 24×1.5	20.5	30	FM16SCF	630	FM16SVITCF	630	72	
20		M 30×2.0	24.0	36	FM20SCF	420	FM20SVITCF	420	121	
25		M 36×2.0	27.0	46	FM25SCF	420	FM25SVITCF	420	221	
30		M 42×2.0	29.0	50	FM30SCF	420	FM30SVITCF	420	248	
38		M 52×2.0	32.5	60	FM38SCF	420	FM38SVITCF	420	367	

$\frac{\text{PN (bar)}}{10} = \text{PN (MPa)}$

**WARNING:** This product can expose you to chemicals including Lead and Lead Compounds which is known to the State of California to cause cancer and birth defects or other reproductive harm. For more information go to [www.p65warnings.ca.gov](http://www.p65warnings.ca.gov).



[Click here for CADs, Support Resources or to Configure Parts Online](#)

# FM

## EO-2 Dual Function Nut

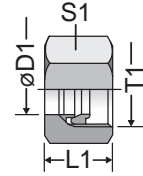

X1) Retaining ring

TABLE OF CONTENTS

VISUAL INDEX

D

FAQs

ASSEMBLY

TUBE FAB EQUIP

GEN TECH

Series	D1	T1	L1	S1	Order code								Weight g/1 piece
					FM...71 Stainless Steel		FM...NBR71 Stainless Steel		FM...SSA Steel, zinc plated Cr(VI) free passiv. +Sealing, Retaining ring: Stainless Steel		FM...VITSSA Steel, zinc plated Cr(VI) free passiv. +Sealing, Retaining ring: Stainless Steel		
					Sealing FKM	PN (bar)	Sealing NBR	PN (bar)	Sealing NBR	PN (bar)	Sealing FKM	PN (bar)	
LL	04	M 08×1.0	11.0	10	—	—	—	—	FM04LLSSA	100	—	—	5
	06	M 10×1.0	11.5	12	—	—	—	—	FM06LLSSA	100	—	—	6
L	06	M 12×1.5	14.5	14	FM06L71	315	FM06LNBR71	315	FM06LSSA	315	FM06LVITSSA	315	12
	08	M 14×1.5	14.5	17	FM08L71	315	FM08LNBR71	315	FM08LSSA	315	FM08LVITSSA	315	17
	10	M 16×1.5	15.5	19	FM10L71	315	FM10LNBR71	315	FM10LSSA	315	FM10LVITSSA	315	22
	12	M 18×1.5	15.5	22	FM12L71	315	FM12LNBR71	315	FM12LSSA	315	FM12LVITSSA	315	30
	15	M 22×1.5	17.0	27	FM15L71	315	FM15LNBR71	315	FM15LSSA	315	FM15LVITSSA	315	48
	18	M 26×1.5	18.0	32	FM18L71	315	FM18LNBR71	315	FM18LSSA	315	FM18LVITSSA	315	70
	22	M 30×2.0	20.0	36	FM22L71	160	FM22LNBR71	160	FM22LSSA	160	FM22LVITSSA	160	94
	28	M 36×2.0	21.0	41	FM28L71	160	FM28LNBR71	160	FM28LSSA	160	FM28LVITSSA	160	106
	35	M 45×2.0	24.0	50	FM35L71	160	FM35LNBR71	160	FM35LSSA	160	FM35LVITSSA	160	160
	42	M 52×2.0	24.0	60	FM42L71	160	FM42LNBR71	160	FM42LSSA	160	FM42LVITSSA	160	244
S	06	M 14×1.5	16.5	17	FM06S71	630	FM06SNBR71	630	FM06SSSA	630	FM06SVITSSA	630	20
	08	M 16×1.5	16.5	19	FM08S71	630	FM08SNBR71	630	FM08SSSA	630	FM08SVITSSA	630	23
	10	M 18×1.5	17.5	22	FM10S71	630	FM10SNBR71	630	FM10SSSA	630	FM10SVITSSA	630	37
	12	M 20×1.5	17.5	24	FM12S71	630	FM12SNBR71	630	FM12SSSA	630	FM12SVITSSA	630	39
	16	M 24×1.5	20.5	30	FM16S71	400	FM16SNBR71	400	FM16SSSA	400	FM16SVITSSA	400	72
	20	M 30×2.0	24.0	36	FM20S71	400	FM20SNBR71	400	FM20SSSA	400	FM20SVITSSA	400	121
	25	M 36×2.0	27.0	46	FM25S71	400	FM25SNBR71	400	FM25SSSA	400	FM25SVITSSA	400	221
	30	M 42×2.0	29.0	50	FM30S71	400	FM30SNBR71	400	FM30SSSA	400	FM30SVITSSA	400	248
	38	M 52×2.0	32.5	60	FM38S71	315	FM38SNBR71	315	FM38SSSA	315	FM38SVITSSA	315	367

$$\frac{\text{PN (bar)}}{10} = \text{PN (MPa)}$$

[Click here for CADs, Support Resources or to Configure Parts Online](#)

# DPR

Progressive Ring  
For L and S series only

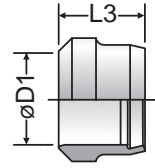

Progressive ring: DPR

TABLE OF CONTENTS

VISUAL INDEX

FAQs

ASSEMBLY

TUBE FAB EQUIP

GEN TECH

Series	D1 	L3	Progressive ring DPR Order code		PN (bar)	Weight g/1 piece
			Stainless Steel	Stainless Steel SPH		
L	06	9.0	DPR06L71X	DPR06LSPH71X	315	1.7
	08	9.0	DPR08L71X	DPR08LSPH71X	315	2.2
	10	9.5	DPR10L71X	DPR10LSPH71X	315	3.1
	12	9.8	DPR12L71X	DPR12LSPH71X	315	3.5
	15	9.5	DPR15L71X	DPR15LSPH71X	315	4.5
	18	9.5	DPR18L71X	DPR18LSPH71X	315	5.5
	22	10.5	DPR22L71X	DPR22LSPH71X	160	7.3
	28	11.0	DPR28L71X	DPR28LSPH71X	160	9.4
	35	13.5	DPR35L71X	DPR35LSPH71X	160	20.0
	42	13.5	DPR42L71X	DPR42LSPH71X	160	23.0
S	06	9.0	DPR06L71X	DPR06LSPH71X	630	1.7
	08	9.0	DPR08L71X	DPR08LSPH71X	630	3.2
	10	9.5	DPR10L71X	DPR10LSPH71X	630	3.1
	12	9.8	DPR12L71X	DPR12LSPH71X	630	3.5
	16	9.5	DPR16S71X	DPR16SSPH71X	400	5.6
	20	12.5	DPR20S71X	DPR20SSPH71X	400	11.4
	25	12.5	DPR25S71X	DPR25SSPH71X	400	13.3
	38	13.0	DPR38S71X	DPR38SSPH71X	315	22.5

$$\frac{\text{PN (bar)}}{10} = \text{PN (MPa)}$$

[Click here for CADs, Support Resources or to Configure Parts Online](#)

## D

Cutting (Locking) Ring  
For LL series and all brass

## PSR

Progressive Ring  
For L and S series only

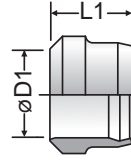

Cutting ring:  
D

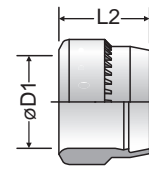

Progressive stop ring:  
PSR

TABLE  
OF  
CONTENTS

VISUAL  
INDEX

D

FAQs

ASSEMBLY

TUBE FAB  
EQUIP

GEN TECH

Series	D1	L1	Cutting ring D Order code						Progressive stop ring PSR Order code			Weight g/1 pc.
			Steel, zinc plated Cr(VI) free	PN (bar)	Stainless Steel	PN (bar)	Brass	PN (bar)	L2	Steel, zinc plated Cr(VI) free	PN (bar)	
LL	04	6.0	D04LLX	100	D04LL71X	100	D04LLMSX	63	—	—	—	0.3
	06	7.0	D06LLX	100	D06LL71X	100	D06LLMSX	63	—	—	—	0.8
	08	7.0	D08LLX	100	D08LL71X	100	D08LLMSX	63	—	—	—	1.0
	10	7.0	D10LLX	100	D10LL71X	100	D10LLMSX	63	—	—	—	1.3
	12	7.5	D12LLX	100	D12LL71X	100	D12LLMSX	63	—	—	—	1.6
L	06	9.5	—	—	—	—	D06LMSX	200	9.5	PSR06LX	500	1.7
	08	9.0	—	—	—	—	D08LMSX	200	9.5	PSR08LX	500	2.2
	10	10.0	—	—	—	—	D10LMSX	200	10.0	PSR10LX	500	3.1
	12	10.0	—	—	—	—	D12LMSX	200	10.0	PSR12LX	400	3.5
	15	10.0	—	—	—	—	D15LMSX	200	10.0	PSR15LX	400	4.5
	18	10.0	—	—	—	—	D18LMSX	200	10.0	PSR18LX	400	5.5
	22	10.5	—	—	—	—	D22LMSX	100	10.5	PSR22LX	250	7.3
	28	10.5	—	—	—	—	D28LMSX	100	10.5	PSR28LX	250	9.4
	35	13.0	—	—	—	—	D35LMSX	100	13.0	PSR35LX	250	20.0
	42	13.5	—	—	—	—	D42LMSX	100	13.0	PSR42LX	250	23.0
S	06	9.5	—	—	—	—	D06LMSX	400	9.5	PSR06LX	800	1.7
	08	9.0	—	—	—	—	D08LMSX	400	9.5	PSR08LX	800	3.2
	10	10.0	—	—	—	—	D10LMSX	400	10.0	PSR10LX	800	3.1
	12	10.0	—	—	—	—	D12LMSX	400	10.0	PSR12LX	630	3.5
	16	10.5	—	—	—	—	D16SMSX	250	10.0	PSR16SX	630	5.6
	20	12.5	—	—	—	—	D20SMSX	250	13.0	PSR20SX	420	11.4
	25	12.5	—	—	—	—	D25SMSX	250	13.0	PSR25SX	420	13.3
	30	13.0	—	—	—	—	D30SMSX	250	13.0	PSR30SX	420	19.3
38	13.5	—	—	—	—	D38SMSX	200	13.0	PSR38SX	420	22.5	

$\frac{\text{PN (bar)}}{10} = \text{PN (MPa)}$

**WARNING:** This product can expose you to chemicals including Lead and Lead Compounds which is known to the State of California to cause cancer and birth defects or other reproductive harm. For more information go to [www.p65warnings.ca.gov](http://www.p65warnings.ca.gov).

[Click here for CADs, Support Resources or to Configure Parts Online](#)

# GM

## Bulkhead Lockout

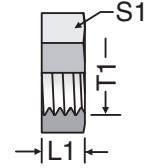

TABLE OF CONTENTS

VISUAL INDEX

FAQs

ASSEMBLY

TUBE FAB EQUIP

GEN TECH

Series	Tube O.D.	T1	L1	S1	Weight g/1 piece	Order code		
						Steel CF	Stainless Steel 71	Brass MS
L <sup>3)</sup>	06	M 12x1.5	6	17	7	GM06LCFX	GM06L71X	GM06LMSX
	08	M 14x1.5	6	19	8	GM08LCFX	GM08L71X	GM08LMSX
	10	M 16x1.5	6	22	11	GM10LCFX	GM10L71X	GM10LMSX
	12	M 18x1.5	6	24	12	GM12LCFX	GM12L71X	GM12LMSX
	15	M 22x1.5	7	30	23	GM15LCFX	GM15L71X	GM15LMSX
	18	M 26x1.5	8	36	37	GM18LCFX	GM18L71X	GM18LMSX
	22	M 30x2.0	8	41	46	GM22LCFX	GM22L71X	GM22LMSX
	28	M 36x2.0	9	46	58	GM28LCFX	GM28L71X	GM28LMSX
	35	M 45x2.0	9	55	71	GM35LCFX	GM35L71X	GM35LMSX
	42	M 52x2.0	10	65	123	GM42LCFX	GM42L71X	GM42LMSX
S <sup>4)</sup>	06	M 14x1.5	6	19	8	GM08LCFX	GM08L71X	GM06LMSX
	08	M 16x1.5	6	22	11	GM10LCFX	GM10L71X	GM10LMSX
	10	M 18x1.5	6	24	12	GM12LCFX	GM12L71X	GM12LMSX
	12	M 20x1.5	6	27	15	GM12SCFX	GM12S71X	GM12SMSX
	16	M 24x1.5	7	32	24	GM16SCFX	GM16S71X	GM16SMSX
	20	M 30x2.0	8	41	46	GM22LCFX	GM22L71X	GM22LMSX
	25	M 36x2.0	9	46	58	GM28LCFX	GM28L71X	GM28LMSX
	30	M 42x2.0	9	50	58	GM30SCFX	GM30S71X	GM30SMSX
	38	M 52x2.0	10	65	123	GM42LCFX	GM42L71X	GM42LMSX

<sup>3)</sup> L = light series; <sup>4)</sup> S = heavy series

**WARNING:** This product can expose you to chemicals including Lead and Lead Compounds which is known to the State of California to cause cancer and birth defects or other reproductive harm. For more information go to [www.p65warnings.ca.gov](http://www.p65warnings.ca.gov).

[Click here for CADs, Support Resources or to Configure Parts Online](#)

**E**  
Tube Insert  
For Plastic Tube

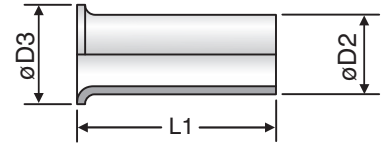

TABLE  
OF  
CONTENTS

VISUAL  
INDEX

**D**

FAQs

ASSEMBLY

TUBE FAB  
EQUIP

GEN TECH

Tube O.D.	Tube I.D.	D2	D3	L1	Weight g/1 piece	Order code Brass
04	2.0	2.0	3.5	8	1	E04/02X
04	2.5	2.5	4.0	8	1	E04/2.5X
05	3.0	3.0	5.0	14	1	E0506/03X
06	3.0	3.0	5.0	14	1	E0506/03X
05	4.0	4.0	5.0	14	1	E0506/04X
06	4.0	4.0	5.0	14	1	E0506/04X
08	4.0	4.0	6.6	14	1	E08/04X
06	5.0	5.0	6.0	14	1	E06/05X
08	5.0	5.0	6.0	14	1	E08/05X
10	6.0	6.0	8.0	15	1	E0810/06X
08	6.0	6.0	8.0	15	1	E0810/06X
10	8.0	8.0	10.0	15	1	E10/08X
12	8.0	8.0	12.0	15	2	E12/08X
12	9.0	9.0	12.0	15	2	E12/09X
12	10.0	10.0	12.0	15	2	E1215/10X
15	12.0	12.0	14.8	15	3	E15/12X
15	12.5	12.5	14.8	15	3	E1516/12.5X
16	12.5	12.5	14.8	15	3	E1516/12.5X
18	14.0	14.0	17.8	15	4	E18/14X
18	16.0	16.0	17.8	20	4	E1820/16X
20	16.0	16.0	17.8	20	4	E1820/16X
22	18.0	18.0	21.8	16	5	E22/18X

**WARNING:** This product can expose you to chemicals including Lead and Lead Compounds which is known to the State of California to cause cancer and birth defects or other reproductive harm. For more information go to [www.p65warnings.ca.gov](http://www.p65warnings.ca.gov).



[Click here for CADs, Support Resources or to Configure Parts Online](#)

# VH

Tube Insert  
For Thin Walled Metal Tube

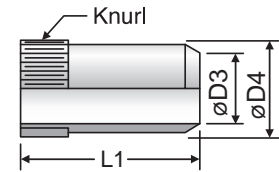

TABLE OF CONTENTS

VISUAL INDEX

FAQs

ASSEMBLY

TUBE FAB EQUIP

GEN TECH

Tube I.D.	D3	D4	L1	Weight g/1 piece	Order code		
					Steel CF	Stainless Steel 71	Brass MS
4.00	2.6	3.8	14.0	0.7	VH04CFX	VH0471X	VH04MSX
4.50	3.1	4.3	14.0	0.8	VH04.5CFX	VH04.571X	VH04.5MSX
5.00	3.6	4.8	14.0	0.8	VH05CFX	VH0571X	VH05MSX
6.00	4.6	5.8	14.0	1.0	VH06CFX	VH0671X	VH06MSX
6.50	5.1	6.3	14.0	1.0	VH06.5CFX	VH06.571X	VH06.5MSX
7.00	5.6	6.8	15.5	1.3	VH07CFX	VH0771X	VH07MSX
8.00	6.6	7.8	15.5	1.6	VH08CFX	VH0871X	VH08MSX
9.00	7.6	8.8	15.5	1.8	VH09CFX	VH0971X	VH09MSX
10.00	8.6	9.8	15.5	2.1	VH10CFX	VH1071X	VH10MSX
10.05	8.6	9.8	15.5	2.1	VH10.05CFX	VH10.0571X	VH10.05MSX
10.50	9.1	10.3	15.5	2.3	VH10.5CFX	VH10.571X	VH10.5MSX
11.00	9.6	10.8	15.5	2.6	VH11CFX	VH1171X	VH11MSX
12.00	10.2	11.8	17.0	3.7	VH12CFX	VH1271X	VH12MSX
12.95	11.2	12.8	17.0	3.9	VH12.95CFX	VH12.9571X	VH12.95MSX
13.00	11.2	12.8	17.0	3.9	VH13CFX	VH1371X	VH13MSX
14.00	12.2	13.8	17.0	4.3	VH14CFX	VH1471X	VH14MSX
15.00	13.2	14.8	20.0	5.7	VH15CFX	VH1571X	VH15MSX
16.00	14.2	15.8	20.0	5.8	VH16.00CFX	VH16.0071X	VH16.00MSX
16.20	14.2	15.8	20.0	5.8	VH16CFX	VH1671X	VH16MSX
17.00	15.2	16.8	20.0	6.3	VH17CFX	VH1771X	VH17MSX
18.00	16.2	17.8	20.0	6.3	VH18CFX	VH1871X	VH18MSX
19.00	17.2	18.8	16.0	5.8	VH19CFX	VH1971X	VH19MSX
19.90	18.2	19.8	21.5	7.9	VH19.90CFX	VH19.9071X	VH19.90MSX
20.00	18.2	19.8	21.5	7.9	VH20CFX	VH2071X	VH20MSX
21.00	19.2	20.8	21.5	8.0	VH21CFX	VH2171X	VH21MSX
22.00	20.2	21.8	23.5	9.7	VH22CFX	VH2271X	VH22MSX
23.00	21.2	22.8	23.5	10.6	VH23CFX	VH2371X	VH23MSX
24.00	22.2	23.8	23.5	11.1	VH24CFX	VH2471X	VH24MSX
24.90	23.3	24.8	23.5	10.8	VH24.90CFX	VH24.9071X	VH2490MSX
25.00	23.2	24.8	23.5	10.8	VH25CFX	VH2571X	VH25MSX
26.00	24.2	25.8	23.5	12.7	VH26CFX	VH2671X	VH26MSX
27.00	25.2	26.8	23.5	12.2	VH27CFX	VH2771X	VH27MSX
30.00	27.8	29.8	26.5	18.7	VH30CFX	VH3071X	VH30MSX
31.00	28.8	30.8	26.5	20.7	VH31CFX	VH3171X	VH31MSX
32.00	29.8	31.8	26.5	19.2	VH32CFX	VH3271X	VH32MSX
32.10	29.8	31.8	26.5	19.2	VH32.10CFX	VH32.1071X	VH32.10MSX
33.00	30.8	32.8	26.5	19.9	VH33CFX	VH3371X	VH33MSX
34.00	31.8	33.8	26.5	26.5	VH34CFX	VH3471X	VH34MSX
37.80	35.8	37.7	31.0	19.5	VH37.8CFX	VH37.871X	VH37.8MSX
38.00	35.8	37.8	21.0	19.7	VH38CFX	VH3871X	VH38MSX
39.00	36.8	38.8	21.0	19.5	VH39CFX	VH3971X	VH39MSX

**WARNING:** This product can expose you to chemicals including Lead and Lead Compounds which is known to the State of California to cause cancer and birth defects or other reproductive harm. For more information go to [www.p65warnings.ca.gov](http://www.p65warnings.ca.gov).

[Click here for CADs, Support Resources or to Configure Parts Online](#)

**G**  
Union  
24° Flareless / 24° Flareless

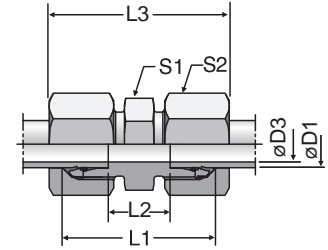

Series	D1	D3	L1	L2	L3	S1	S2	Weight g/1 piece	Order code*	PN (bar) <sup>1)</sup>		
										CF	71	MS
LL <sup>2)</sup>	04	3.0	20	12	31	9	10	5	G04LL	100	100	63
	06	4.5	20	9	32	11	12	7	G06LL	100	100	63
	08	6.0	23	12	35	12	14	10	G08LL	100	100	63
	10	8.0	23	12	35	14	17	13	G10LL	100	100	63
	12	10.0	23	11	35	17	19	16	G12LL	100	100	63
L <sup>3)</sup>	06	4.0	24	10	39	12	14	12	G06L	500	315	200
	08	6.0	25	11	40	14	17	16	G08L	500	315	200
	10	8.0	27	13	42	17	19	23	G10L	500	315	200
	12	10.0	28	14	43	19	22	28	G12L	400	315	200
	15	12.0	30	16	46	24	27	51	G15L	400	315	200
	18	15.0	31	16	48	27	32	69	G18L	400	315	200
	22	19.0	35	20	52	32	36	90	G22L	250	160	100
	28	24.0	36	21	54	41	41	137	G28L	250	160	100
	35	30.0	41	20	63	46	50	214	G35L	250	160	100
	42	36.0	43	21	66	55	60	296	G42L	250	160	100
S <sup>4)</sup>	06	4.0	30	16	45	14	17	26	G06S	800	630	400
	08	5.0	32	18	47	17	19	37	G08S	800	630	400
	10	7.0	32	17	49	19	22	44	G10S	800	630	400
	12	8.0	34	19	51	22	24	60	G12S	630	630	400
	16	12.0	38	21	57	27	30	90	G16S	630	400	250
	20	16.0	44	23	66	32	36	143	G20S	420	400	250
	25	20.0	50	26	74	41	46	251	G25S	420	400	250
	30	25.0	54	27	80	46	50	330	G30S	420	400	250
38	32.0	61	29	90	55	60	545	G38S	420	315	200	

<sup>1)</sup> Pressure shown = item deliverable

<sup>2)</sup> LL = very light series; <sup>3)</sup> L = light series; <sup>4)</sup> S = heavy series

$$\frac{\text{PN (bar)}}{10} = \text{PN (MPa)}$$

Part numbers shown are body only level. To order with a nut and progressive ring (sleeve) included, please see pages D12 and D13 for part number ordering instructions. Instructions for ordering the fitting as EO-2 is also included on these pages.

**WARNING:** This product can expose you to chemicals including Lead and Lead Compounds which is known to the State of California to cause cancer and birth defects or other reproductive harm. For more information go to [www.p65warnings.ca.gov](http://www.p65warnings.ca.gov).

\*Please add the **suffixes** below according to the material/surface required.

Order code suffixes		
Material	Suffix surface and material	Example
Steel, zinc plated, Cr(VI)-free	CFX	G16SCFX
Stainless Steel	71X	G16S71X
Brass	MSX	G16SMSX

TABLE OF CONTENTS

VISUAL INDEX

D

FAQs

ASSEMBLY

TUBE FAB EQUIP

GEN TECH

[Click here for CADs, Support Resources or to Configure Parts Online](#)

# GR

Union Reducer  
24° Flareless / 24° Flareless

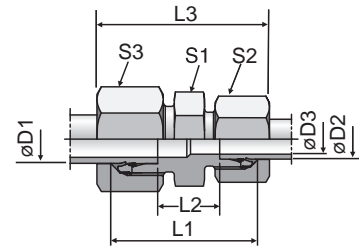

TABLE OF CONTENTS

VISUAL INDEX

FAQs

ASSEMBLY

TUBE FAB EQUIP

GEN TECH

Series	D1	D2	D3	L1	L2	L3	S1	S2	S3	Weight g/1 piece	Order code*	PN (bar) <sup>1)</sup>		
												CF	71	MS
LL <sup>2)</sup>	06	04	3.0	20	10.5	32	11	10	12	7	GR06/04LL	100	100	63
	08	04	3.0	22	12.5	34	12	10	14	9	GR08/04LL	100	100	63
	08	06	4.5	22	11.0	34	12	12	14	11	GR08/06LL	100	100	63
L <sup>3)</sup>	08	06	4.0	25	11.0	40	14	14	17	16	GR08/06L	500	315	200
	10	06	4.0	26	12.0	41	17	14	19	21	GR10/06L	500	315	200
	10	08	6.0	26	12.0	41	17	17	19	21	GR10/08L	500	315	200
	12	06	4.0	27	13.0	42	19	14	22	26	GR12/06L	400	315	200
	12	08	6.0	27	13.0	42	19	17	22	26	GR12/08L	400	315	200
	12	10	8.0	28	14.0	43	19	19	22	29	GR12/10L	400	315	200
	15	10	8.0	29	15.0	45	24	19	27	46	GR15/10L	400	315	200
	15	12	10.0	29	15.0	45	24	22	27	45	GR15/12L	400	315	200
	18	10	8.0	30	15.5	46	27	19	32	65	GR18/10L	400	315	200
	18	12	10.0	30	15.5	46	27	22	32	64	GR18/12L	400	315	200
	18	15	12.0	31	16.5	48	27	27	32	65	GR18/15L	400	315	200
	22	12	10.0	32	17.5	48	32	22	36	80	GR22/12L	250	160	100
	22	15	12.0	33	18.5	50	32	27	36	89	GR22/15L	250	160	100
	22	18	15.0	33	18.0	50	32	32	36	89	GR22/18L	250	160	100
	28	18	15.0	34	19.0	52	41	32	41	142	GR28/18L	250	160	100
	28	22	19.0	36	21.0	54	41	36	41	139	GR28/22L	250	160	100
	35	22	19.0	39	21.0	59	46	36	50	202	GR35/22L	250	160	100
	35	28	24.0	39	21.0	59	46	41	50	206	GR35/28L	250	160	100
	42	35	30.0	43	21.5	66	55	50	60	330	GR42/35L	250	160	100
	S <sup>4)</sup>	08	06	4.0	32	18.0	47	17	17	19	35	GR08/06S	800	630
10		06	4.0	32	17.5	48	19	17	22	41	GR10/06S	800	630	400
10		08	5.0	32	17.5	48	19	19	22	42	GR10/08S	800	630	400
12		06	4.0	34	19.5	50	22	17	24	56	GR12/06S	630	630	400
12		08	5.0	34	19.5	50	22	19	24	57	GR12/08S	630	630	400
12		10	7.0	34	19.0	51	22	22	24	59	GR12/10S	630	630	400
16		10	7.0	36	20.0	54	27	22	30	80	GR16/10S	630	400	250
16		12	8.0	36	20.0	54	27	24	30	87	GR16/12S	630	400	250
16		14	10.0	36	21.5	57	27	27	30	79	GR16/14S	630	400	250
20		10	7.0	40	22.0	60	32	22	36	129	GR20/10S	420	400	250
20		12	8.0	40	22.0	60	32	24	36	131	GR20/12S	420	400	250
20		16	12.0	42	23.0	63	32	30	36	134	GR20/16S	420	400	250
25		16	12.0	46	25.5	68	41	30	46	236	GR25/16S	420	400	250
25		20	16.0	48	25.5	71	41	36	46	235	GR25/20S	420	400	250
30		20	16.0	50	26.0	74	46	36	50	299	GR30/20S	420	400	250
30	25	20.0	52	26.5	77	46	46	50	317	GR30/25S	420	400	250	
38	30	25.0	59	29.5	87	55	50	60	522	GR38/30S	420	315	200	

<sup>1)</sup> Pressure shown = item deliverable

<sup>2)</sup> LL = very light series; <sup>3)</sup> L = light series; <sup>4)</sup> S = heavy series

$$\frac{\text{PN (bar)}}{10} = \text{PN (MPa)}$$

Part numbers shown are body only level. To order with a nut and progressive ring (sleeve) included, please see pages D12 and D13 for part number ordering instructions. Instructions for ordering the fitting as EO-2 is also included on these pages.

**WARNING:** This product can expose you to chemicals including Lead and Lead Compounds which is known to the State of California to cause cancer and birth defects or other reproductive harm. For more information go to [www.p65warnings.ca.gov](http://www.p65warnings.ca.gov).

Order code suffixes		
Material	Suffix surface and material	Example
Steel, zinc plated, Cr(VI)-free	CFX	GR16/12SCFX
Stainless Steel	71X	GR16/12S71X
Brass	MSX	GR16/12SMSX

\*Please add the suffixes below according to the material/surface required.

[Click here for CADs, Support Resources or to Configure Parts Online](#)

# SV

Bulkhead Union  
24° Flareless / 24° Flareless

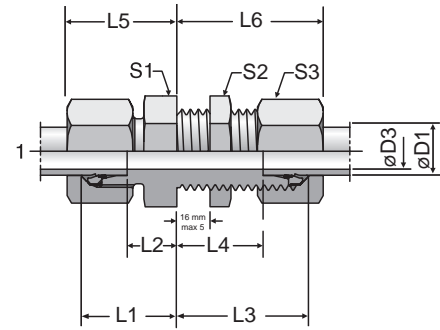

- TABLE OF CONTENTS
- VISUAL INDEX
- D
- FAQs
- ASSEMBLY
- TUBE FAB EQUIP
- GEN TECH

Series	D1	D3	L1	L2	L3	L4	L5	L6	S1	S2	S3	Weight g/1 piece	Order code*	PN (bar) <sup>1)</sup>		
														CF	71	MS
L <sup>3)</sup>	06	4	14	7.0	34	27.0	22	42	17	17	14	39	SV06LOMD	500	315	200
	08	6	15	8.0	34	27.0	23	42	19	19	17	50	SV08LOMD	500	315	200
	10	8	17	10.0	35	28.0	25	43	22	22	19	67	SV10LOMD	500	315	200
	12	10	17	10.0	36	29.0	25	44	24	24	22	78	SV12LOMD	400	315	200
	15	12	19	12.0	38	31.0	27	46	27	30	27	128	SV15LOMD	400	315	200
	18	15	21	13.5	40	32.5	30	49	32	36	32	198	SV18LOMD	400	315	200
	22	19	24	16.5	42	34.5	33	51	36	41	36	254	SV22LOMD	250	160	100
	28	24	26	18.5	43	35.5	35	52	41	46	41	335	SV28LOMD	250	160	100
	35	30	29	18.5	47	36.5	40	58	50	55	50	546	SV35LOMD	250	160	160
	42	36	30	19.0	47	36.0	42	59	60	65	60	758	SV42LOMD	250	160	160
S <sup>4)</sup>	06	4	19	12.0	36	29.0	27	44	19	19	17	65	SV06SOMD	800	630	400
	08	5	20	13.0	36	29.0	28	44	22	22	19	87	SV08SOMD	800	630	400
	10	7	22	14.5	37	29.5	31	46	24	24	22	112	SV10SOMD	800	630	400
	12	8	22	14.5	38	30.5	31	47	27	27	24	141	SV12SOMD	630	630	400
	16	12	25	16.5	40	31.5	35	50	32	32	30	201	SV16SOMD	630	400	250
	20	16	28	17.5	44	33.5	39	55	41	41	36	462	SV20SOMD	420	400	250
	25	20	32	20.0	47	35.0	44	59	46	46	46	492	SV25SOMD	420	400	250
	30	25	35	21.5	51	37.5	48	64	50	50	50	631	SV30SOMD	420	400	250
	38	32	38	22.0	53	37.0	53	68	65	65	60	1083	SV38SOMD	420	315	

<sup>1)</sup> Pressure shown = item deliverable

<sup>3)</sup> L = light series; <sup>4)</sup> S = heavy series

<sup>5)</sup> Bulkhead thickness min.

06-18 L and 06-16 S = 3 mm

22-42 L and 20-38 S = 4 mm

$$\frac{\text{PN (bar)}}{10} = \text{PN (MPa)}$$

Part numbers shown are body only level. To order with a nut and progressive ring (sleeve) included, please see pages D12 and D13 for part number ordering instructions. Instructions for ordering the fitting as EO-2 is also included on these pages.

**WARNING:** This product can expose you to chemicals including Lead and Lead Compounds which is known to the State of California to cause cancer and birth defects or other reproductive harm. For more information go to [www.p65warnings.ca.gov](http://www.p65warnings.ca.gov).

\*Please add the **suffixes** below according to the material/surface required.

Order code suffixes		
Material	Suffix surface and material	Example
Steel, zinc plated, Cr(VI)-free	CF	SV16SOMDCF
Stainless Steel	71	SV16SOMD71
Brass	MS	SV16SOMDMS

[Click here for CADs, Support Resources or to Configure Parts Online](#)

# ESV

Weld Bulkhead Fitting  
24° Flareless / 24° Flareless

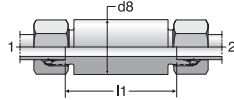

TUBE FITTING PART #	END SIZE		d8 (mm)	l1 (mm)	Pressure Rating (bar)			
	1 (mm)	2 (mm)			EO		EO-2	
					CF	71	CF	71
ESV06L	6	6	18	56	500	315	500	315
ESV08L	8	8	20	56	500	315	500	315
ESV10L	10	10	22	58	500	315	500	315
ESV12L	12	12	25	58	400	315	400	315
ESV15L	15	15	28	70	400	315	400	315
ESV18L	18	18	32	69	400	315	400	315
ESV22L	22	22	36	73	250	160	250	160
ESV28L	28	28	40	73	250	160	250	160
ESV35L	35	35	50	71	250	160	250	160
ESV42L	42	42	60	70	250	160	250	160
ESV06S	6	6	20	60	800	630	800	630
ESV08S	8	8	22	60	800	630	800	630
ESV10S	10	10	25	59	800	630	800	630
ESV12S	12	12	28	59	630	630	630	630
ESV14S	14	14	30	72	630	630	630	630
ESV16S	16	16	35	71	630	400	630	400
ESV20S	20	20	38	71	420	400	420	400
ESV25S	25	25	45	72	420	400	420	400
ESV30S	30	30	50	73	420	400	420	400
ESV38S	38	38	60	72	420	315	420	315

For EO-2 part number, insert "Z" between size and pressure series.

Example: ESV06ZL71

Note: Weld fitting. Omit "CF" in the part number for steel material.

**WARNING:** This product can expose you to chemicals including Lead and Lead Compounds which is known to the State of California to cause cancer and birth defects or other reproductive harm. For more information go to [www.p65warnings.ca.gov](http://www.p65warnings.ca.gov).

TABLE OF CONTENTS

VISUAL INDEX

FAQs

ASSEMBLY

TUBE FAB EQUIP

GEN TECH



[Click here for CADs, Support Resources or to Configure Parts Online](#)

# GE-UNF/UN

Male Connector  
24° Flareless / SAE-ORB

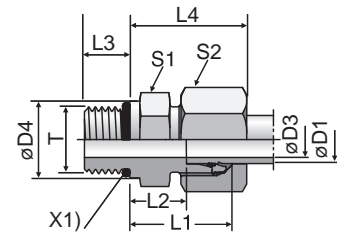

X1) O-ring OR

TABLE OF CONTENTS

VISUAL INDEX

D

FAQs

ASSEMBLY

TUBE FAB EQUIP

GEN TECH

Series	D1	T	D3	D4	L1	L2	L3	L4	S1	S2	Weight g/1 piece	Order code*	PN (bar <sup>1)</sup> )	
													CF	71
L <sup>3)</sup>	08	7/16-20UNF-2A	5.0	-	26	10.0	9.0	25	17	17	21	GE08L7/16UNFOMD	315	315
	10	7/16-20UNF-2A	5.0	-	27	11.0	9.0	26	17	19	23	GE10L7/16UNFOMD	315	315
	12	9/16-18UNF-2A	7.0	-	28	11.0	10.0	26	19	22	32	GE12L9/16UNFOMD	315	315
	12	3/4-16UNF-2A	10.0	-	31	13.0	11.0	28	24	22	52	GE12L3/4UNFOMD	315	315
	12	7/8-14UNF-2A	10.0	-	34	14.3	12.7	29	27	22	77	GE12L7/8UNFOMD	315	315
	15	3/4-16UNF-2A	11.0	-	32	14.0	11.0	29	24	27	57	GE15L3/4UNFOMD	315	315
	15	7/8-14UNF-2A	12.0	-	35	15.3	12.7	30	27	27	81	GE15L7/8UNFOMD	315	315
	18	3/4-16UNF-2A	11.0	23.9	33	14.5	11.0	31	27	32	68	GE18L3/4UNFOMD	315	315
	18	7/8-14UNF-2A	14.0	-	35	14.8	12.7	31	27	32	72	GE18L7/8UNFOMD	315	315
	22	7/8-14UNF-2A	14.0	-	37	16.8	12.7	33	32	36	94	GE22L7/8UNFOMD	160	160
	22	1 1/16-12UN-2A	18.0	-	39	16.5	15.0	33	32	36	103	GE22L11/16UNOMD	160	160
	22	1 5/16-12UN-2A	19.0	-	40	17.5	15.0	34	41	36	163	GE22L15/16UNOMD	160	160
	28	1 1/16-12UN-2A	18.0	33.3	40	17.5	15.0	34	41	41	152	GE28L11/16UNOMD	160	160
	28	1 5/16-12UN-2A	23.0	-	40	17.5	15.0	34	41	41	163	GE28L15/16UNOMD	160	160
35	1 5/16-12UN-2A	23.0	39.6	43	17.5	15.0	39	46	50	222	GE35L15/16UNOMD	160	160	
35	1 5/8-12UN-2A	29.0	-	43	17.5	15.0	39	50	50	257	GE35L15/8UNOMD	160	160	
42	1 5/8-12UN-2A	29.0	47.7	45	19.0	15.0	42	55	60	339	GE42L15/8UNOMD	160	160	
S <sup>4)</sup>	08	7/16-20UNF-2A	4.0	-	31	13.0	11.0	30	17	19	33	GE08S7/16UNFOMD	630	630
	10	9/16-18UNF-2A	6.0	-	32	12.5	12.0	31	19	22	42	GE10S9/16UNFOMD	630	630
	12	9/16-18UNF-2A	6.0	19.0	32	12.5	12.0	31	22	24	50	GE12S9/16UNFOMD	630	630
	12	3/4-16UNF-2A	8.0	-	36	14.5	14.0	34	24	24	73	GE12S3/4UNFOMD	630	630
	16	3/4-16UNF-2A	10.0	-	35	12.5	14.0	34	24	30	90	GE16S3/4UNFOMD	400	400
	16	7/8-14UNF-2A	12.0	-	40	15.5	16.0	37	27	30	95	GE16S7/8UNFOMD	400	400
	20	3/4-16UNF-2A	10.0	23.9	42	17.5	14.0	42	32	36	132	GE20S3/4UNFOMD	400	400
	20	7/8-14UNF-2A	12.0	26.9	44	17.5	16.0	42	32	36	141	GE20S7/8UNFOMD	400	400
	20	1 1/16-12UN-2A	16.0	-	46	17.0	18.5	42	32	36	163	GE20S11/16UNOMD	400	400
	25	1 1/16-12UN-2A	16.0	33.3	50	19.5	18.5	47	36	46	206	GE25S11/16UNOMD	400	400
	25	1 5/16-12UN-2A	20.0	-	50	19.5	18.5	47	41	46	258	GE25S15/16UNOMD	400	400
	30	1 5/16-12UN-2A	20.0	39.6	52	20.0	18.5	50	46	50	327	GE30S15/16UNOMD	400	400
	30	1 5/8-12UN-2A	24.0	-	52	20.0	18.5	50	50	50	422	GE30S15/8UNOMD	400	400
	38	1 5/8-12UN-2A	24.0	47.7	57	22.5	18.5	57	55	60	554	GE38S15/8UNOMD	315	315

<sup>1)</sup> Pressure shown = item deliverable

<sup>3)</sup> L = light series; <sup>4)</sup> S = heavy series

$$\frac{PN(\text{bar})}{10} = PN(\text{MPa})$$

Part numbers shown are body only level. To order with a nut and progressive ring (sleeve) included, please see pages D12 and D13 for part number ordering instructions. Instructions for ordering the fitting as EO-2 is also included on these pages.

**WARNING:** This product can expose you to chemicals including Lead and Lead Compounds which is known to the State of California to cause cancer and birth defects or other reproductive harm. For more information go to [www.p65warnings.ca.gov](http://www.p65warnings.ca.gov).

Order code suffixes			
Material	Suffix surface and material	Example	Standard sealing material (no additional suffix needed)
Steel, zinc plated, Cr(VI)-free	CF	GE16S3/4UNFOMDCF	NBR
Stainless Steel	71	GE16S3/4UNFOMD71	VIT

\*Please add the suffixes below according to the material/surface required.

[Click here for CADs, Support Resources or to Configure Parts Online](#)

# GE-NPT

Male Connector  
24° Flareless / NPTF

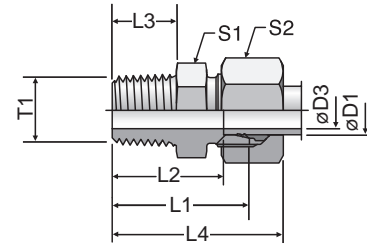

TABLE OF CONTENTS

VISUAL INDEX

FAQs

ASSEMBLY

TUBE FAB EQUIP

GEN TECH

Series	D1	T1	D3	L1	L2	L3	L4	S1	S2	Weight g/1 piece	Order code*	PN (bar) <sup>1)</sup>		
												CF	71	MS
LL <sup>2)</sup>	04	1/8-27 NPT	3.0	22.0	18.0	10.0	28	11*	10	9	GE04LL1/8NPT	100	100	
	06	1/8-27 NPT	4.5	22.0	16.5	10.0	28	11*	12	9	GE06LL1/8NPT	100	100	63
	08	1/8-27 NPT	5.0	24.0	18.5	10.0	30	12	14	11	GE08LL1/8NPT	100	100	63
L <sup>3)</sup>	06	1/8-27 NPT	4.0	24.0	17.0	10.0	32	12	14	12	GE06L1/8NPT	315	315	200
	06	1/4-18 NPT	4.0	30.0	23.0	14.5	38	17	14	27	GE06L1/4NPT	315	315	200
	06	3/8-18 NPT	4.0	30.0	23.0	14.5	38	19	14	32	GE06L3/8NPT	315	315	
	06	1/2-14 NPT	4.0	36.0	29.0	19.5	44	22	14	53	GE06L1/2NPT	315	315	
	08	1/8-27 NPT	4.0	25.0	18.0	10.0	33	14	17	16	GE08L1/8NPT	315	315	
	08	1/4-18 NPT	6.0	30.0	23.0	14.5	38	17	17	25	GE08L1/4NPT	315	315	200
	08	3/8-18 NPT	6.0	30.0	23.0	14.5	38	19	17	34	GE08L3/8NPT	315	315	
	08	1/2-14 NPT	6.0	36.0	29.0	19.5	44	22	17	54	GE08L1/2NPT	315	315	
	10	1/8-27 NPT	4.0	25.0	18.0	10.0	33	17	19	19	GE10L1/8NPT	315	315	
	10	1/4-18 NPT	7.0	31.0	24.0	14.5	39	17	19	25	GE10L1/4NPT	315	315	200
	10	3/8-18 NPT	7.0	32.0	25.0	14.5	40	19	19	40	GE10L3/8NPT	315	315	
	10	1/2-14 NPT	8.0	37.0	30.0	19.5	45	22	19	54	GE10L1/2NPT	315	315	
	10	3/4-14 NPT	8.0	38.0	31.0	19.5	46	30	19	93	GE10L3/4NPT	315	315	
	12	1/8-27 NPT	4.0	26.0	19.0	10.0	34	19	22	52	GE12L1/8NPT	315	315	
	12	1/4-18 NPT	7.0	32.0	25.0	14.5	40	19	22	31	GE12L1/4NPT	315	315	200
	12	3/8-18 NPT	8.0	32.0	25.0	14.5	40	19	22	37	GE12L3/8NPT	315	315	200
	12	1/2-14 NPT	10.0	37.0	30.0	19.5	45	22	22	62	GE12L1/2NPT	315	315	200
	15	3/8-18 NPT	8.0	33.0	26.0	14.5	41	24	27	53	GE15L3/8NPT	315	315	
	15	1/2-14 NPT	12.0	38.0	31.0	19.5	46	24	27	63	GE15L1/2NPT	315	315	200
	15	3/4-14 NPT	12.0	39.0	32.0	19.5	47	30	27	112	GE15L3/4NPT	315	315	
	15	1-11.5 NPT	12.0	45.0	38.0	24.5	53	36	27	158	GE15L1NPT	315	315	
	18	3/8-18 NPT	8.0	34.0	26.5	14.5	43	27	32	69	GE18L3/8NPT	315	315	
	18	1/2-14 NPT	12.0	39.0	31.5	19.5	48	27	32	79	GE18L1/2NPT	315	315	200
	18	3/4-14 NPT	15.0	39.0	31.5	19.5	48	30	32	104	GE18L3/4NPT	315	315	
	18	1-11.5 NPT	15.0	45.0	37.5	24.5	54	36	32	159	GE18L1NPT	315	315	
	22	3/8-18 NPT	8.0	36.5	29.0	14.5	45	32	36	91	GE22L3/8NPT	160	160	
	22	1/2-14 NPT	12.0	41.0	33.5	19.5	50	32	36	96	GE22L1/2NPT	160	160	
	22	3/4-14 NPT	16.0	41.0	33.5	19.5	50	32	36	108	GE22L3/4NPT	160	160	100
	22	1-11.5 NPT	19.0	47.0	39.5	24.5	56	36	36	174	GE22L1NPT	160	160	
	28	3/4-14 NPT	16.0	42.0	34.5	19.5	51	41	41	157	GE28L3/4NPT	160	160	
	28	1-11.5 NPT	21.0	47.0	39.5	24.5	56	41	41	197	GE28L1NPT	160	160	100
	28	1 1/4-11.5 NPT	24.0	49.0	41.5	25.0	58	46	41	266	GE28L11/4NPT	160	160	
	35	1-11.5 NPT	22.0	50.0	39.5	24.5	61	46	50	280	GE35L1NPT	160	160	
	35	1 1/4-11.5 NPT	28.0	51.0	40.5	25.0	62	46	50	285	GE35L11/4NPT	160	160	
	42	1 1/4-11.5 NPT	28.0	53.0	42.0	25.0	65	55	60	382	GE42L11/4NPT	160	160	
	42	1 1/2-11.5 NPT	36.0	53.0	42.0	26.0	65	55	60	377	GE42L11/2NPT	160	160	

<sup>1)</sup> Pressure shown = item deliverable

<sup>2)</sup> LL = very light series; <sup>3)</sup> L = light series

$$\frac{PN(\text{bar})}{10} = PN(\text{MPa})$$

Part numbers shown are body only level. To order with a nut and progressive ring (sleeve) included, please see pages D12 and D13 for part number ordering instructions. Instructions for ordering the fitting as EO-2 is also included on these pages.

\*S1=SW12 in 1.4571

Order code suffixes		
Material	Suffix surface and material	Example
Steel, zinc plated, Cr(VI)-free	CFX	GE18L1/2NPTCFX
Stainless Steel	71X	GE18L1/2NPT71X
Brass	MSX	GE18L1/2NPTMSX

**WARNING:** This product can expose you to chemicals including Lead and Lead Compounds which is known to the State of California to cause cancer and birth defects or other reproductive harm. For more information go to [www.p65warnings.ca.gov](http://www.p65warnings.ca.gov).

[Click here for CADs, Support Resources or to Configure Parts Online](#)

# GE-NPT

Male Connector  
24° Flareless / NPTF

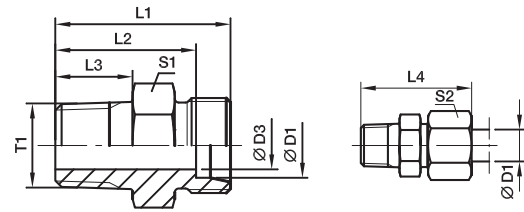

**TABLE OF CONTENTS**

**VISUAL INDEX**

**D**

Series	D1	T1	D3	L1	L2	L3	L4	S1	S2	Weight g/1 piece	Order code*	PN (bar) <sup>1)</sup>		
												CF	71	MS
S <sup>2)</sup>	06	1/8-27 NPT	4	28	21.0	10.0	36	14	17	21	GE06S1/8NPT	630	630	400
	06	1/4-18 NPT	4	35	28.0	14.5	43	17	17	37	GE06S1/4NPT	630	630	
	06	3/8-18 NPT	4	33	26.0	14.5	41	19	17	40	GE06S3/8NPT	630	630	
	06	1/2-14 NPT	4	42	35.0	19.5	50	22	17	71	GE06S1/2NPT	630	630	400
	08	1/4-18 NPT	5	35	28.0	14.5	43	17	19	38	GE08S1/4NPT	630	630	
	08	3/8-18 NPT	5	35	28.0	14.5	43	19	19	46	GE08S3/8NPT	630	630	
	08	1/2-14 NPT	5	42	35.0	19.5	50	22	19	73	GE08S1/2NPT	630	630	400
	10	1/4-18 NPT	5	35	27.5	14.5	44	19	22	45	GE10S1/4NPT	630	630	
	10	3/8-18 NPT	7	35	27.5	14.5	44	19	22	49	GE10S3/8NPT	630	630	
	10	1/2-14 NPT	7	42	34.5	19.5	51	22	22	73	GE10S1/2NPT	630	630	400
	10	3/4-14 NPT	7	44	36.5	19.5	53	30	22	125	GE10S3/4NPT	630	630	
	12	1/4-18 NPT	5	37	29.5	14.5	46	22	24	57	GE12S1/4NPT	630	630	
	12	3/8-18 NPT	8	37	29.5	14.5	46	22	24	62	GE12S3/8NPT	630	630	400
	12	1/2-14 NPT	8	42	34.5	19.5	51	22	24	83	GE12S1/2NPT	630	630	
	12	3/4-14 NPT	8	44	36.5	19.5	53	30	24	126	GE12S3/4NPT	630	630	
	16	3/8-18 NPT	8	39	30.5	14.5	49	27	30	84	GE16S3/8NPT	400	400	250
	16	1/2-14 NPT	12	48	39.5	19.5	58	32	30	97	GE16S1/2NPT	400	400	
	16	3/4-14 NPT	12	46	37.5	19.5	56	30	30	130	GE16S3/4NPT	400	400	
	16	1-11.5 NPT	12	51	42.5	24.5	61	36	30	178	GE16S1NPT	400	400	250
	20	1/2-14 NPT	12	48	37.5	19.5	59	32	36	144	GE20S1/2NPT	400	400	
	20	3/4-14 NPT	16	48	37.5	19.5	59	32	36	149	GE20S3/4NPT	400	400	
	20	1-11.5 NPT	16	55	44.5	24.5	66	36	36	243	GE20S1NPT	400	400	100
	25	3/4-14 NPT	16	52	40.0	19.5	64	41	46	240	GE25S3/4NPT	400	400	
	25	1-11.5 NPT	20	57	45.0	24.5	69	41	46	278	GE25S1NPT	400	400	
	25	1 1/4-11.5 NPT	20	58	46.0	25.0	70	46	46	396	GE25S11/4NPT	400	400	100
	25	1 1/2-11.5 NPT	20	61	49.0	26.0	73	50	46	469	GE25S11/2NPT	400	400	
	30	3/4-14 NPT	16	54	40.5	19.5	67	46	50	307	GE30S3/4NPT	400	400	
	30	1-11.5 NPT	20	59	45.5	24.5	72	46	50	343	GE30S1NPT	400	400	100
	30	1 1/4-11.5 NPT	25	60	46.5	25.0	73	46	50	397	GE30S11/4NPT	400	400	
	30	1 1/2-11.5 NPT	25	60	46.5	26.0	73	50	50	440	GE30S11/2NPT	400	400	
	38	1-11.5 NPT	22	64	48.0	24.5	79	55	60	510	GE38S1NPT	315	315	
	38	1 1/4-11.5 NPT	25	65	49.0	25.0	80	55	60	535	GE38S11/4NPT	315	315	
	38	1 1/2-11.5 NPT	32	65	49.0	26.0	80	55	60	571	GE38S11/2NPT	315	315	

<sup>1)</sup> Pressure shown = item deliverable

<sup>2)</sup> S = heavy series

$$\frac{PN \text{ (bar)}}{10} = PN \text{ (MPa)}$$

Part numbers shown are body only level. To order with a nut and progressive ring (sleeve) included, please see pages D12 and D13 for part number ordering instructions. Instructions for ordering the fitting as EO-2 is also included on these pages.

\*S1=SW12 in 1.4571

**FAQs**

**ASSEMBLY**

**TUBE FAB EQUIP**

**GEN TECH**

Order code suffixes		
Material	Suffix surface and material	Example
Steel, zinc plated, Cr(VI)-free	CFX	GE16S1/2NPTCFX
Stainless Steel	71X	GE16S1/2NPT71X
Brass	MSX	GE16S1/2NPTMSX

\*Please add the **suffixes** below according to the material/surface required.

[Click here for CADs, Support Resources or to Configure Parts Online](#)

# GEO

Male Connector  
24° Flareless / ISO 6149

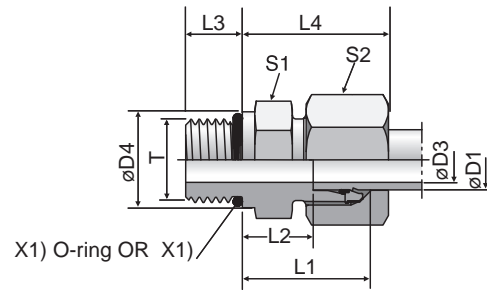

TABLE OF CONTENTS

VISUAL INDEX

FAQs

ASSEMBLY

TUBE FAB EQUIP

GEN TECH

Series	D1	T	D3	D4	L1	L2	L3	L4	S1	S2	Weight g/1 piece	Order code*	PN (bar) <sup>1)</sup>	
													CF	71
LL <sup>2)</sup>	04	M 08×1.0	3.0	10.8	20.0	9.5	6.5	19.0	11*	10	8	GEO04LLMOMD	100	100
	04	M 10×1.0	3.0	12.8	20.0	9.5	6.5	19.0	13	10	11	GEO04LLM10X1OMD	100	
	06	M 10×1.0	4.5	12.8	20.0	8.0	6.5	19.5	13	12	10	GEO06LLMOMD	100	
L <sup>3)</sup>	06	M 10×1.0	4.5	14.0	24.0	8.5	8.5	23.0	14	14	15	GEO06LMOMD	500	315
	08	M 12×1.5	6.0	17.0	28.0	10.0	11.0	25.0	17	17	23	GEO08LMOMD	500	315
	10	M 14×1.5	7.5	19.0	29.0	11.0	11.0	26.0	19	19	28	GEO10LMOMD	500	315
	12	M 16×1.5	9.0	22.0	31.0	12.5	11.5	27.0	22	22	40	GEO12LMOMD	400	315
	15	M 18×1.5	11.0	24.0	33.0	13.5	12.5	29.0	24	27	56	GEO15LMOMD	400	315
	18	M 22×1.5	14.0	27.0	35.0	14.5	13.0	31.0	27	32	80	GEO18LMOMD	400	315
	22	M 27×2.0	18.0	32.0	40.0	16.5	16.0	33.0	32	36	104	GEO22LM27X2OMD	250	160
	28	M 33×2.0	23.0	41.0	41.0	17.5	16.0	34.0	41	41	171	GEO28LMOMD	250	160
	35	M 42×2.0	30.0	50.0	44.0	17.5	16.0	39.0	50	50	278	GEO35LMOMD	250	160
	42	M 48×2.0	36.0	55.0	47.5	19.0	17.5	42.0	55	60	340	GEO42LMOMD	250	160
S <sup>4)</sup>	06	M 12×1.5	4.0	17.0	31.0	13.0	11.0	28.0	17	17	29	GEO06SMOMD	800	630
	08	M 14×1.5	6.0	19.0	33.0	15.0	11.0	30.0	19	19	41	GEO08SMOMD	800	630
	10	M 16×1.5	7.0	22.0	35.0	15.0	12.5	31.0	22	22	55	GEO10SMOMD	800	630
	12	M 18×1.5	9.0	24.0	38.5	17.0	14.0	33.0	24	24	73	GEO12SMOMD	630	630
	16	M 22×1.5	12.0	27.0	42.0	18.5	15.0	37.0	27	30	102	GEO16SMOMD	630	400
	20	M 27×2.0	15.0	32.0	49.5	20.5	18.5	42.0	32	36	169	GEO20SMOMD	420	400
	25	M 33×2.0	20.0	41.0	53.5	23.0	18.5	47.0	41	46	274	GEO25SMOMD	420	400
	30	M 42×2.0	26.0	50.0	56.0	23.5	19.0	50.0	50	50	412	GEO30SMOMD	420	400
	38	M 48×2.0	32.0	55.0	63.5	26.0	21.5	57.0	55	60	580	GEO38SMOMD	420	315

<sup>1)</sup> Pressure shown = item deliverable

<sup>2)</sup> LL = very light series; <sup>3)</sup> L = light series; <sup>4)</sup> S = heavy series

$$\frac{PN \text{ (bar)}}{10} = PN \text{ (MPa)}$$

Part numbers shown are body only level. To order with a nut and progressive ring (sleeve) included, please see pages D12 and D13 for part number ordering instructions. Instructions for ordering the fitting as EO-2 is also included on these pages.

\*S1=SW12 in 1.4571

**WARNING:** This product can expose you to chemicals including Lead and Lead Compounds which is known to the State of California to cause cancer and birth defects or other reproductive harm. For more information go to [www.p65warnings.ca.gov](http://www.p65warnings.ca.gov).

\*Please add the suffixes below according to the material/surface required.

Order code suffixes			
Material	Suffix surface and material	Example	Standard sealing material (no additional suffix needed)
Steel, zinc plated, Cr(VI)-free	CF	GEO16SMOMDCF	NBR
Stainless Steel	71	GEO16SMOMD71	VIT

[Click here for CADs, Support Resources or to Configure Parts Online](#)

# GE-R-ED

Male Connector  
24° Flareless / BSPP

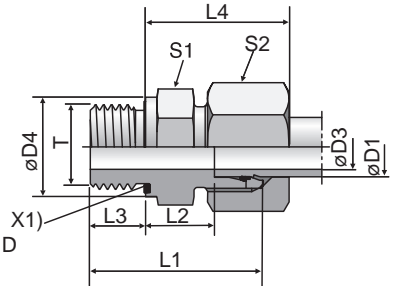

X1) Elastic-sealing ED

TABLE OF CONTENTS

VISUAL INDEX

D

FAQs

ASSEMBLY

TUBE FAB EQUIP

GEN TECH

Series	D1	T1	D3	D4	L1	L2	L3	L4	S1	S2	Weight g/1 piece	Order code*	PN (bar) <sup>1)</sup>		
													CF	71	MS
LL <sup>2)</sup>	04	G 1/8 A	3	14	20.0	9.5	6.5	19	14	10	10	GE04LLREDOMD	100	100	63
	06	G 1/8 A	4	14	20.0	8.0	6.5	20	14	12	11	GE06LLREDOMD	100	100	63
L <sup>3)</sup>	06	G 1/8 A	4	14	23.5	8.5	8.0	23	14	14	13	GE06LREDOMD	500	315	200
	06	G 1/4 A	4	19	29.0	10.0	12.0	25	19	14	28	GE06LR1/4EDOMD	500	315	200
	06	G 3/8 A	4	22	30.5	11.5	12.0	26	22	14	44	GE06LR3/8EDOMD	420	315	200
	06	G 1/2 A	4	27	33.0	12.0	14.0	27	27	14	61	GE06LR1/2EDOMD	400	315	200
	08	G 1/4 A	6	19	29.0	10.0	12.0	25	19	17	27	GE08LREDOMD	500	315	200
	08	G 1/8 A	4	14	24.5	9.5	8.0	24	14	17	16	GE08LR1/8EDOMD	500	315	200
	08	G 3/8 A	6	22	30.5	11.5	12.0	26	22	17	45	GE08LR3/8EDOMD	420	315	200
	08	G 1/2 A	6	27	33.0	12.0	14.0	27	27	17	74	GE08LR1/2EDOMD	400	315	200
	10	G 1/4 A	6	19	30.0	11.0	12.0	26	19	19	29	GE10LREDOMD	500	315	200
	10	G 1/8 A	4	14	25.5	10.5	8.0	25	17	19	21	GE10LR1/8EDOMD	500	315	200
	10	G 3/8 A	8	22	31.5	12.5	12.0	27	22	19	43	GE10LR3/8EDOMD	420	315	200
	10	G 1/2 A	8	27	34.0	13.0	14.0	28	27	19	71	GE10LR1/2EDOMD	400	315	200
	12	G 3/8 A	9	22	31.5	12.5	12.0	27	22	22	41	GE12LREDOMD	420	315	200
	12	G 1/8 A	4	14	26.5	11.5	8.0	26	19	22	26	GE12LR1/8EDOMD	420	315	200
	12	G 1/4 A	6	19	31.0	12.0	12.0	27	19	22	31	GE12LR1/4EDOMD	400	315	200
	12	G 1/2 A	10	27	34.0	13.0	14.0	28	27	22	67	GE12LR1/2EDOMD	400	315	200
	12	G 3/4 A	10	32	37.0	14.0	16.0	29	32	22	118	GE12LR3/4EDOMD	250	160	100
	15	G 1/2 A	11	27	35.0	14.0	14.0	29	27	27	72	GE15LREDOMD	400	315	200
	15	G 3/8 A	9	22	32.5	13.5	12.0	29	24	27	54	GE15LR3/8EDOMD	400	315	200
	15	G 3/4 A	12	32	38.0	15.0	16.0	30	32	27	116	GE15LR3/4EDOMD	250	160	100
	18	G 1/2 A	14	27	36.0	14.5	14.0	31	27	32	71	GE18LREDOMD	400	315	200
	18	G 3/8 A	9	22	33.5	14.0	12.0	30	27	32	66	GE18LR3/8EDOMD	400	315	200
	18	G 3/4 A	15	32	38.0	14.5	16.0	31	32	32	110	GE18LR3/4EDOMD	250	160	100
	22	G 3/4 A	18	32	40.0	16.5	16.0	33	32	36	102	GE22LREDOMD	250	160	100
	22	G 1/2 A	14	27	38.0	16.5	14.0	33	32	36	91	GE22LR1/2EDOMD	250	160	100
	22	G 1 A	19	40	43.0	17.5	18.0	34	41	36	189	GE22LR1EDOMD	250	160	100
	28	G 1 A	23	40	43.0	17.5	18.0	34	41	41	170	GE28LREDOMD	250	160	100
	28	G 3/4 A	18	32	41.0	17.5	16.0	34	41	41	159	GE28LR3/4EDOMD	250	160	100
28	G 1 1/4 A	24	50	46.0	18.5	20.0	35	50	41	316	GE28LR11/4EDOMD	250	160	100	
35	G 1 1/4 A	30	50	48.0	17.5	20.0	39	50	50	272	GE35LREDOMD	250	160	100	
35	G 1 A	23	40	46.0	17.5	18.0	39	46	50	226	GE35LR1EDOMD	250	160	100	
35	G 1 1/2 A	30	55	52.0	19.5	22.0	41	55	50	423	GE35LR11/2EDOMD	250	160	100	
42	G 1 1/2 A	36	55	52.0	19.0	22.0	42	55	60	343	GE42LREDOMD	250	160	100	
42	G 1 A	23	40	48.0	19.0	18.0	42	55	60	324	GE42LR1EDOMD	250	160	100	
42	G 1 1/4 A	30	50	50.0	19.0	20.0	42	55	60	348	GE42LR11/4EDOMD	250	160	100	

<sup>1)</sup> Pressure shown = item deliverable

<sup>2)</sup> LL = very light series; <sup>3)</sup> L = light series

$$\frac{\text{PN (bar)}}{10} = \text{PN (MPa)}$$

Part numbers shown are body only level. To order with a nut and progressive ring (sleeve) included, please see pages D12 and D13 for part number ordering instructions. Instructions for ordering the fitting as EO-2 is also included on these pages.

**WARNING:** This product can expose you to chemicals including Lead and Lead Compounds which is known to the State of California to cause cancer and birth defects or other reproductive harm. For more information go to [www.p65warnings.ca.gov](http://www.p65warnings.ca.gov).

Order code suffixes			
Material	Suffix surface and material	Example	Standard sealing material (no additional suffix needed)
Steel, zinc plated, Cr(VI)-free	CF	GE18LREDOMDCF	NBR
Stainless Steel	71	GE18LREDOMD71	VIT
Brass	MS	GE18LREDOMDMS	NBR



[Click here for CADs, Support Resources or to Configure Parts Online](#)

# GE-R-ED

Male Connector  
24° Flareless / BSPP

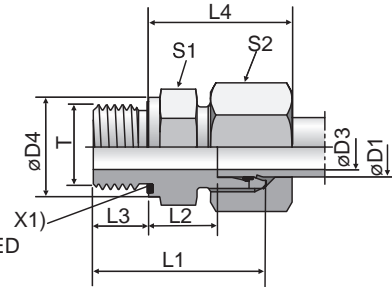

X1) Elastic-sealing ED

Series	D1	T1	D3	D4	L1	L2	L3	L4	S1	S2	Weight g/1 piece	Order code*	PN (bar) <sup>1)</sup>		
													CF	71	MS
S <sup>4)</sup>	06	G 1/4 A	4	19	32.0	13.0	12	28	19	17	35	GE06SREDOMD	800	630	400
	06	G 1/8 A	4	14	27.5	12.5	8	27	14	17	21	GE06SR1/8EDOMD	500	315	
	06	G 3/8 A	4	22	34.5	15.5	12	30	22	17	52	GE06SR3/8EDOMD	630	630	
	06	G 1/2 A	4	27	39.0	18.0	14	33	27	17	83	GE06SR1/2EDOMD	630	400	
	08	G 1/4 A	5	19	34.0	15.0	12	30	19	19	41	GE08SREDOMD	800	630	400
	08	G 3/8 A	5	22	34.5	15.5	12	30	22	19	57	GE08SR3/8EDOMD	800	630	
	08	G 1/2 A	5	27	39.0	18.0	14	33	27	19	89	GE08SR1/2EDOMD	630	400	
	10	G 3/8 A	7	22	34.5	15.0	12	31	22	22	55	GE10SREDOMD	800	630	400
	10	G 1/4 A	5	19	34.0	14.5	12	31	19	22	42	GE10SR1/4EDOMD	800	630	
	10	G 1/2 A	7	27	39.0	17.5	14	34	27	22	97	GE10SR1/2EDOMD	630	630	
	12	G 3/8 A	8	22	36.5	17.0	12	33	22	24	62	GE12SREDOMD	630	630	400
	12	G 1/4 A	5	19	36.0	16.5	12	33	22	24	61	GE12SR1/4EDOMD	630	630	
	12	G 1/2 A	8	27	39.0	17.5	14	34	27	24	99	GE12SR1/2EDOMD	630	630	
	16	G 1/2 A	12	27	41.0	18.5	14	37	27	30	91	GE16SREDOMD	630	400	250
	16	G 3/8 A	8	22	38.5	18.0	12	36	27	30	83	GE16SR3/8EDOMD	630	400	
	16	G 3/4 A	12	32	45.0	20.5	16	39	32	30	152	GE16SR3/4EDOMD	420	400	
	20	G 3/4 A	16	32	47.0	20.5	16	42	32	36	149	GE20SREDOMD	420	400	250
	20	G 1/2 A	12	27	45.0	20.5	14	42	32	36	142	GE20SR1/2EDOMD	420	400	
	20	G 1 A	16	40	51.0	22.5	18	44	41	36	265	GE20SR1EDOMD	420	400	
	20	G 1 1/4 A	16	50	53.0	22.5	20	44	50	36	404	GE20SR11/4EDOMD	420	400	
	25	G 1 A	20	40	53.0	23.0	18	47	41	46	266	GE25SREDOMD	420	400	250
	25	G 1/2 A	12	27	49.0	23.0	14	47	41	46	228	GE25SR1/2EDOMD	420	400	
	25	G 3/4 A	16	32	51.0	23.0	16	47	41	46	255	GE25SR3/4EDOMD	420	400	
	25	G 1 1/4 A	20	50	55.0	23.0	20	47	50	46	411	GE25SR11/4EDOMD	420	400	
	25	G 1 1/2 A	20	55	60.0	26.0	22	50	55	46	549	GE25SR11/2EDOMD	315	315	
	30	G 1 1/4 A	25	50	57.0	23.5	20	50	50	50	418	GE30SREDOMD	420	400	250
	30	G 1 A	20	40	55.0	23.5	18	50	46	50	344	GE30SR1EDOMD	420	400	
	30	G 1 1/2 A	25	55	62.0	26.5	22	53	55	50	530	GE30SR11/2EDOMD	315	315	
	38	G 1 1/2 A	32	55	64.0	26.0	22	57	55	60	563	GE38SREDOMD	420	315	200
	38	G 1 1/4 A	25	50	62.0	26.0	20	57	55	60	575	GE38SR11/4EDOMD	420	315	

<sup>1)</sup> Pressure shown = item deliverable

<sup>4)</sup> S = heavy series

$$\frac{PN \text{ (bar)}}{10} = PN \text{ (MPa)}$$

Part numbers shown are body only level. To order with a nut and progressive ring (sleeve) included, please see pages D12 and D13 for part number ordering instructions. Instructions for ordering the fitting as EO-2 is also included on these pages.

**WARNING:** This product can expose you to chemicals including Lead and Lead Compounds which is known to the State of California to cause cancer and birth defects or other reproductive harm. For more information go to [www.p65warnings.ca.gov](http://www.p65warnings.ca.gov).

Order code suffixes			
Material	Suffix surface and material	Example	Standard sealing material (no additional suffix needed)
Steel, zinc plated, Cr(VI)-free	CF	GE16SREDOMDCF	NBR
Stainless Steel	71	GE16SREDOMD71	VIT
Brass	MS	GE16SREDOMDMS	NBR

TABLE OF CONTENTS

VISUAL INDEX

FAQs

ASSEMBLY

TUBE FAB EQUIP

GEN TECH

[Click here for CADs, Support Resources or to Configure Parts Online](#)

# GE-R

Male Connector  
24° Flareless / BSPT or BSPP

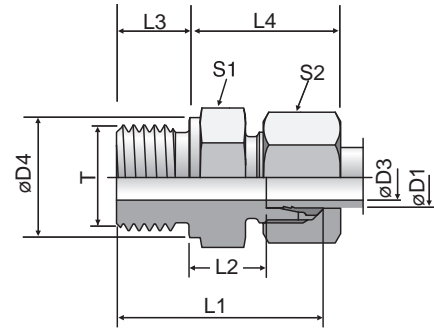

**TABLE OF CONTENTS**

**VISUAL INDEX**

**D**

**FAQs**

**ASSEMBLY**

**TUBE FAB EQUIP**

**GEN TECH**

Series	D1	T	D3	D4	L1	L2	L3	L4	S1	S2	Weight g/1 piece	Order code*	PN (bar) <sup>1)</sup>		
													CF	71	MS
L <sup>3)</sup>	06	G 1/8 A	4	14	23.5	8.5	8	23.0	14	14	14	GE06LR	315	315	200
	06	G 1/4 A	4	18	29.0	10.0	12	25.0	19	14	60	GE06LR1/4	315	315	200
	06	G 3/8 A	4	22	30.5	11.5	12	26.0	22	14	45	GE06LR3/8	315	315	200
	06	G 1/2 A	4	26	33.0	12.0	14	27.0	27	14	60	GE06LR1/2	315	315	200
	08	G 1/4 A	6	18	29.0	10.0	12	25.0	19	17	26	GE08LR	315	315	200
	08	G 1/8 A	4	14	24.5	8.5	8	23.0	14	17	16	GE08LR1/8	315	315	200
	08	G 3/8 A	6	22	30.5	11.5	12	26.0	22	17	44	GE08LR3/8	315	315	200
	08	G 1/2 A	6	26	33.0	12.0	14	27.0	27	17	74	GE08LR1/2	315	315	200
	10	G 1/4 A	6	18	30.0	11.0	12	26.0	19	19	31	GE10LR	315	315	200
	10	G 1/8 A	4	14	25.5	10.5	8	25.0	17	19	21	GE10LR1/8	315	315	200
	10	G 3/8 A	8	22	31.5	12.5	12	27.0	22	19	44	GE10LR3/8	315	315	200
	10	G 1/2 A	8	26	34.0	13.0	14	28.0	27	19	72	GE10LR1/2	315	315	200
	12	G 3/8 A	9	22	31.5	12.5	12	27.0	22	22	43	GE12LR	315	315	200
	12	G 1/8 A	4	14	26.5	11.5	8	26.0	19	22	27	GE12LR1/8	315	315	200
	12	G 1/4 A	6	18	31.0	12.0	12	27.0	19	22	32	GE12LR1/4	315	315	200
	12	G 1/2 A	10	26	34.0	13.0	14	28.0	27	22	67	GE12LR1/2	315	315	200
	12	G 3/4 A	10	32	37.0	14.0	16	29.0	32	22	120	GE12LR3/4	315	315	200
	15	G 1/2 A	11	26	35.0	14.0	14	29.0	27	27	72	GE15LR	250	250	160
	15	G 3/8 A	9	22	32.5	13.5	12	29.0	24	27	56	GE15LR3/8	250	250	160
	15	G 3/4 A	12	32	38.0	15.0	16	30.0	32	27	118	GE15LR3/4	250	250	160
	18	G 1/2 A	14	26	36.0	14.5	14	31.0	27	32	72	GE18LR	250	250	160
	18	G 3/8 A	9	22	33.5	14.0	12	29.5	27	32	69	GE18LR3/8	250	250	160
	18	G 3/4 A	15	32	38.0	14.5	16	30.0	32	32	112	GE18LR3/4	250	250	160
	22	G 3/4 A	18	32	40.0	16.5	16	33.0	32	36	103	GE22LR	160	160	100
	22	G 1/2 A	14	26	38.0	16.5	14	33.0	32	36	91	GE22LR1/2	160	160	100
	22	G 1 A	19	39	43.0	17.5	18	33.5	41	36	184	GE22LR1	160	160	100
	28	G 1 A	23	39	43.0	17.5	18	34.0	41	41	168	GE28LR	160	160	100
	28	G 1/2 A	14	26	39.0	17.5	14	34.0	41	41	141	GE28LR1/2	160	160	100
	28	G 3/4 A	18	32	41.0	17.5	16	34.0	41	41	156	GE28LR3/4	160	160	100
	28	G 1 1/4 A	24	50	46.0	18.3	20	35.0	50	41	314	GE28LR11/4	160	160	100
	35	G 1 1/4 A	30	49	48.0	17.5	20	39.0	50	50	276	GE35LR	160	160	100
	35	G 1/2 A	14	26	42.0	17.5	14	39.0	46	50	194	GE35LR1/2	160	160	100
	35	G 3/4 A	18	32	44.0	17.5	16	39.0	46	50	202	GE35LR3/4	160	160	100
	35	G 1 A	23	39	46.0	17.5	18	39.0	46	50	234	GE35LR1	160	160	100
	35	G 1 1/2 A	30	55	52.0	19.5	22	41.0	55	50	355	GE35LR11/2	160	160	100
	42	G 1 1/2 A	36	55	52.0	19.0	22	42.0	55	60	349	GE42LR	160	160	100
	42	G 1 A	23	39	48.0	19.0	18	42.0	55	60	327	GE42LR1	160	160	100
	42	G 1 1/4 A	30	49	50.0	19.0	20	42.0	55	60	336	GE42LR11/4	160	160	100

<sup>1)</sup> Pressure shown = item deliverable

<sup>3)</sup> L = light series

$$\frac{\text{PN (bar)}}{10} = \text{PN (MPa)}$$

Part numbers shown are body only level. To order with a nut and progressive ring (sleeve) included, please see pages D12 and D13 for part number ordering instructions. Instructions for ordering the fitting as EO-2 is also included on these pages.

**WARNING:** This product can expose you to chemicals including Lead and Lead Compounds which is known to the State of California to cause cancer and birth defects or other reproductive harm. For more information go to [www.p65warnings.ca.gov](http://www.p65warnings.ca.gov).

\*Please add the suffixes below according to the material/surface required.

Order code suffixes		
Material	Suffix surface and material	Example
Steel, zinc plated, Cr(VI)-free	CFX	GE18LRFCFX
Stainless Steel	71X	GE18LR71X
Brass	MSX	GE18LRMSX

[Click here for CADs, Support Resources or to Configure Parts Online](#)

# GE-R keg

Male Connector  
24° Flareless / BSPT or BSPP

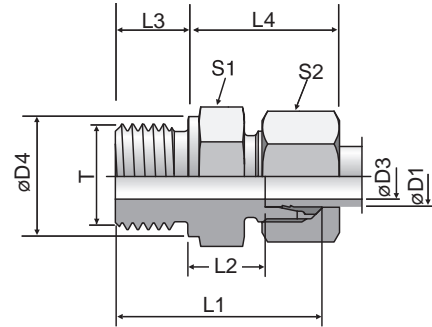

TABLE OF CONTENTS

VISUAL INDEX

FAQs

ASSEMBLY

TUBE FAB EQUIP

GEN TECH

Series	D1	T	D3	D4	L1	L2	L3	L4	S1	S2	Weight g/1 piece	Order code*	PN (bar) <sup>1)</sup>		
													CF	71	MS
S <sup>4)</sup>	06	G 1/4 A	4	18	32.0	13.0	12	28	19	17	35	GE06SR	400	400	250
	06	G 1/8 A	3	14	27.5	12.5	8	27	14	17	22	GE06SR1/8	400	400	
	06	G 3/8 A	4	22	34.5	15.5	12	30	22	17	57	GE06SR3/8	400	400	
	06	G 1/2 A	4	26	39.0	18.0	14	33	27	17	83	GE06SR1/2	400	400	
	08	G 1/4 A	5	18	34.0	15.0	12	30	19	19	41	GE08SR	400	400	250
	08	G 3/8 A	5	22	34.5	15.5	12	30	22	19	59	GE08SR3/8	400	400	
	08	G 1/2 A	5	26	39.0	18.0	14	33	27	19	100	GE08SR1/2	400	400	
	10	G 3/8 A	7	22	34.5	15.0	12	31	22	22	56	GE10SR	400	400	250
	10	G 1/4 A	5	18	34.0	14.5	12	31	19	22	43	GE10SR1/4	400	400	
	10	G 1/2 A	7	26	39.0	17.5	14	34	27	22	97	GE10SR1/2	400	400	
	12	G 3/8 A	8	22	36.5	17.0	12	33	22	24	62	GE12SR	400	400	250
	12	G 1/4 A	5	18	36.0	16.5	12	33	22	24	57	GE12SR1/4	400	400	
	12	G 1/2 A	8	26	39.0	17.5	14	34	27	24	57	GE12SR1/2	400	400	
	16	G 1/2 A	12	26	41.0	18.5	14	37	27	30	92	GE16SR	400	400	250
	16	G 3/8 A	8	22	38.5	18.0	12	36	27	30	83	GE16SR3/8	400	400	
	16	G 3/4 A	12	32	45.0	20.5	16	39	32	30	157	GE16SR3/4	400	400	
	20	G 3/4 A	16	32	47.0	20.5	16	42	32	36	151	GE20SR	400	400	250
	20	G 1/2 A	12	26	45.0	20.5	14	42	32	36	142	GE20SR1/2	400	400	
	20	G 1 A	16	39	51.0	22.5	18	44	41	36	273	GE20SR1	250	250	
	20	G 1 1/4 A	16	49	53.0	22.5	20	44	50	36	387	GE20SR11/4	160	160	
	25	G 1 A	20	39	53.0	23.0	18	47	41	46	267	GE25SR	250	250	160
	25	G 3/4 A	16	32	51.0	23.0	16	47	41	46	245	GE25SR3/4	250	250	
	25	G 1 1/4 A	20	49	55.0	23.0	20	47	50	46	422	GE25SR11/4	160	160	
	30	G 1 1/4 A	25	49	57.0	23.5	20	50	50	50	422	GE30SR	160	160	100
	30	G 1 A	20	39	55.0	23.5	18	50	46	50	337	GE30SR1	160	160	
	38	G 1 1/2 A	32	55	64.0	26.0	22	57	55	60	560	GE38SR	160	160	100
	38	G 1 1/4 A	25	49	62.0	26.0	20	57	55	60	578	GE38SR11/4	160	160	

<sup>1)</sup> Pressure shown = item deliverable

<sup>4)</sup> S = heavy series

$$\frac{\text{PN (bar)}}{10} = \text{PN (MPa)}$$

Part numbers shown are body only level. To order with a nut and progressive ring (sleeve) included, please see pages D12 and D13 for part number ordering instructions. Instructions for ordering the fitting as EO-2 is also included on these pages.

Order code suffixes		
Material	Suffix surface and material	Example
Steel, zinc plated, Cr(VI)-free	CFX	GE16SRCFX
Stainless Steel	71X	GE16SR71X
Brass	MSX	GE16SRMSX

\*Please add the **suffixes** below according to the material/surface required.

**WARNING:** This product can expose you to chemicals including Lead and Lead Compounds which is known to the State of California to cause cancer and birth defects or other reproductive harm. For more information go to [www.p65warnings.ca.gov](http://www.p65warnings.ca.gov).

[Click here for CADs, Support Resources or to Configure Parts Online](#)

# GE-M-ED

Male Connector  
24° Flareless / Metric with  
EOlastic Seal

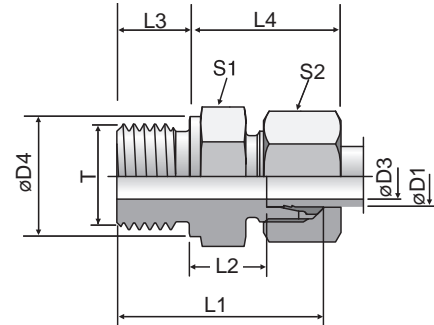

- TABLE OF CONTENTS
- VISUAL INDEX
- D
- FAQs
- ASSEMBLY
- TUBE FAB EQUIP
- GEN TECH

Series	D1	T	D3	D4	L1	L2	L3	L4	S1	S2	Weight g/1 piece	Order code*	PN (bar) <sup>1)</sup>		
													CF	71	MS
L <sup>3)</sup>	06	M 10×1.0	4	14	23.5	8.5	8	23	14	14	13	GE06LM	315	315	200
	08	M 12×1.5	6	17	29.0	10.0	12	25	17	17	22	GE08LM	315	315	200
	10	M 14×1.5	7	19	30.0	11.0	12	26	19	19	31	GE10LM	315	315	200
	10	M 10×1.0	4	14	25.5	10.5	8	25	17	19	20	GE10LM10X1	315	315	
	10	M 12×1.5	6	17	30.0	11.0	12	26	17	19	25	GE10LM12X1.5	315	315	
	10	M 16×1.5	8	21	31.5	12.0	12	27	22	19	41	GE10LM16X1.5	315	315	
	10	M 18×1.5	8	23	31.5	12.5	12	27	24	19	50	GE10LM18X1.5	315	315	
	10	M 22×1.5	8	27	35.0	14.0	14	29	27	19	72	GE10LM22X1.5	315	315	
	12	M 14×1.5	7	19	30.0	11.0	12	26	19	22	30	GE12LM14X1.5	315	315	
	12	M 16×1.5	9	21	31.5	12.5	12	27	22	22	40	GE12LM	315	315	
	12	M 18×1.5	10	23	31.5	12.5	12	27	24	22	47	GE12LM18X1.5	315	315	
	12	M 22×1.5	10	27	35.0	14.0	14	29	27	22	76	GE12LM22X1.5	315	315	
	15	M 16×1.5	9	21	32.0	13.0	12	28	24	27	50	GE15LM16X1.5	250	250	
	15	M 18×1.5	11	23	32.5	13.5	12	29	24	27	52	GE15LM	250	250	160
	15	M 22×1.5	12	27	36.0	15.0	14	30	27	27	77	GE15LM22X1.5	250	250	
	18	M 18×1.5	11	23	33.5	14.0	12	30	27	32	68	GE18LM18X1.5	250	250	
	18	M 22×1.5	14	27	36.0	14.5	14	31	27	32	77	GE18LM	250	250	160
	22	M 22×1.5	14	27	38.0	16.5	14	33	32	36	92	GE22LM22X1.5	160	160	
	22	M 26×1.5	18	31	40.0	16.5	16	33	32	36	102	GE22LM	160	160	100
	28	M 33×2.0	23	39	43.0	17.5	18	34	41	41	168	GE28LM	160	160	100
35	M 42×2.0	30	49	48.0	17.5	20	39	50	50	280	GE35LM	160	160	100	
42	M 48×2.0	36	55	52.0	19.0	22	42	55	60	354	GE42LM	160	160	100	
S <sup>4)</sup>	06	M 12×1.5	4	17	32.0	13.0	12	28	17	17	30	GE06SM	400	400	250
	06	M 14×1.5	4	19	34.0	15.0	12	30	19	17	42	GE06SM14X1.5	400	400	
	08	M 14×1.5	5	19	34.0	15.0	12	30	19	19	43	GE08SM	400	400	250
	10	M 16×1.5	7	21	34.5	15.0	12	31	22	22	54	GE10SM	400	400	250
	12	M 18×1.5	8	23	36.5	17.0	12	33	24	24	72	GE12SM	400	400	250
	12	M 14×1.5	5	19	36.0	16.5	12	33	22	24	60	GE12SM14X1.5	400	400	
	12	M 22×1.5	8	27	39.0	17.5	14	34	27	24	103	GE12SM22X1.5	400	400	
	16	M 18×1.5	8	23	38.5	18.0	12	36	27	30	88	GE16SM18X1.5	400	400	
	16	M 22×1.5	12	27	41.0	18.5	14	37	27	30	97	GE16SM	400	400	250
	20	M 27×2.0	16	32	47.0	20.5	16	42	32	36	155	GE20SM	400	400	250
	25	M 33×2.0	20	39	53.0	23.0	18	47	41	46	268	GE25SM	250	250	160
	30	M 42×2.0	25	49	57.0	23.5	20	50	50	50	421	GE30SM	160	160	100
	38	M 48×2.0	32	55	64.0	26.0	22	57	55	60	568	GE38SM	160	160	100

<sup>1)</sup> Pressure shown = item deliverable

<sup>3)</sup> L = light series; <sup>4)</sup> S = heavy series

$$\frac{PN \text{ (bar)}}{10} = PN \text{ (MPa)}$$

Part numbers shown are body only level. To order with a nut and progressive ring (sleeve) included, please see pages D12 and D13 for part number ordering instructions. Instructions for ordering the fitting as EO-2 is also included on these pages.

\*Please add the suffixes below according to the material/surface required.

**! WARNING:** This product can expose you to chemicals including Lead and Lead Compounds which is known to the State of California to cause cancer and birth defects or other reproductive harm. For more information go to [www.p65warnings.ca.gov](http://www.p65warnings.ca.gov).

Order code suffixes		
Material	Suffix surface and material	Example
Steel, zinc plated, Cr(VI)-free	CFX	GE16SMCFX
Stainless Steel	71X	GE16SM71X
Brass	MSX	GE16SMMSX

[Click here for CADs, Support Resources or to Configure Parts Online](#)

# GE-M

Male Connector  
24° Flareless / Metric

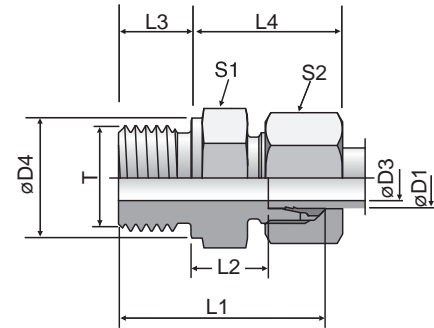

TABLE OF CONTENTS

VISUAL INDEX

FAQs

ASSEMBLY

TUBE FAB EQUIP

GEN TECH

Series	D1	T	D3	D4	L1	L2	L3	L4	S1	S2	Weight g/1 piece	Order code*	PN (bar) <sup>1)</sup>		
													CF	71	MS
L <sup>3)</sup>	06	M 10×1.0	4	14	23.5	8.5	8	23	14	14	13	GE06LM	315	315	200
	08	M 12×1.5	6	17	29.0	10.0	12	25	17	17	22	GE08LM	315	315	200
	10	M 14×1.5	7	19	30.0	11.0	12	26	19	19	31	GE10LM	315	315	200
	10	M 10×1.0	4	14	25.5	10.5	8	25	17	19	20	GE10LM10X1	315	315	
	10	M 12×1.5	6	17	30.0	11.0	12	26	17	19	25	GE10LM12X1.5	315	315	
	10	M 16×1.5	8	21	31.5	12.0	12	27	22	19	41	GE10LM16X1.5	315	315	
	10	M 18×1.5	8	23	31.5	12.5	12	27	24	19	50	GE10LM18X1.5	315	315	
	10	M 22×1.5	8	27	35.0	14.0	14	29	27	19	72	GE10LM22X1.5	315	315	
	12	M 14×1.5	7	19	30.0	11.0	12	26	19	22	30	GE12LM14X1.5	315	315	
	12	M 16×1.5	9	21	31.5	12.5	12	27	22	22	40	GE12LM	315	315	
	12	M 18×1.5	10	23	31.5	12.5	12	27	24	22	47	GE12LM18X1.5	315	315	
	12	M 22×1.5	10	27	35.0	14.0	14	29	27	22	76	GE12LM22X1.5	315	315	
	15	M 16×1.5	9	21	32.0	13.0	12	28	24	27	50	GE15LM16X1.5	250	250	
	15	M 18×1.5	11	23	32.5	13.5	12	29	24	27	52	GE15LM	250	250	160
	15	M 22×1.5	12	27	36.0	15.0	14	30	27	27	77	GE15LM22X1.5	250	250	
	18	M 18×1.5	11	23	33.5	14.0	12	30	27	32	68	GE18LM18X1.5	250	250	
	18	M 22×1.5	14	27	36.0	14.5	14	31	27	32	77	GE18LM	250	250	160
	22	M 22×1.5	14	27	38.0	16.5	14	33	32	36	92	GE22LM22X1.5	160	160	
	22	M 26×1.5	18	31	40.0	16.5	16	33	32	36	102	GE22LM	160	160	100
	28	M 33×2.0	23	39	43.0	17.5	18	34	41	41	168	GE28LM	160	160	100
35	M 42×2.0	30	49	48.0	17.5	20	39	50	50	280	GE35LM	160	160	100	
42	M 48×2.0	36	55	52.0	19.0	22	42	55	60	354	GE42LM	160	160	100	
S <sup>4)</sup>	06	M 12×1.5	4	17	32.0	13.0	12	28	17	17	30	GE06SM	400	400	250
	06	M 14×1.5	4	19	34.0	15.0	12	30	19	17	42	GE06SM14X1.5	400	400	
	08	M 14×1.5	5	19	34.0	15.0	12	30	19	19	43	GE08SM	400	400	250
	10	M 16×1.5	7	21	34.5	15.0	12	31	22	22	54	GE10SM	400	400	250
	12	M 18×1.5	8	23	36.5	17.0	12	33	24	24	72	GE12SM	400	400	250
	12	M 14×1.5	5	19	36.0	16.5	12	33	22	24	60	GE12SM14X1.5	400	400	
	12	M 22×1.5	8	27	39.0	17.5	14	34	27	24	103	GE12SM22X1.5	400	400	
	16	M 18×1.5	8	23	38.5	18.0	12	36	27	30	88	GE16SM18X1.5	400	400	
	16	M 22×1.5	12	27	41.0	18.5	14	37	27	30	97	GE16SM	400	400	250
	20	M 27×2.0	16	32	47.0	20.5	16	42	32	36	155	GE20SM	400	400	250
	25	M 33×2.0	20	39	53.0	23.0	18	47	41	46	268	GE25SM	250	250	160
	30	M 42×2.0	25	49	57.0	23.5	20	50	50	50	421	GE30SM	160	160	100
38	M 48×2.0	32	55	64.0	26.0	22	57	55	60	568	GE38SM	160	160	100	

<sup>1)</sup> Pressure shown = item deliverable

<sup>3)</sup> L = light series; <sup>4)</sup> S = heavy series

$$\frac{\text{PN (bar)}}{10} = \text{PN (MPa)}$$

Part numbers shown are body only level. To order with a nut and progressive ring (sleeve) included, please see pages D12 and D13 for part number ordering instructions. Instructions for ordering the fitting as EO-2 is also included on these pages.

\*Please add the suffixes below according to the material/surface required.

**WARNING:** This product can expose you to chemicals including Lead and Lead Compounds which is known to the State of California to cause cancer and birth defects or other reproductive harm. For more information go to [www.p65warnings.ca.gov](http://www.p65warnings.ca.gov).

Order code suffixes		
Material	Suffix surface and material	Example
Steel, zinc plated, Cr(VI)-free	CFX	GE16SMCFX
Stainless Steel	71X	GE16SM71X
Brass	MSX	GE16SMMSX



[Click here for CADs, Support Resources or to Configure Parts Online](#)

# GE-M keg

Male Connector  
24° Flareless / Metric

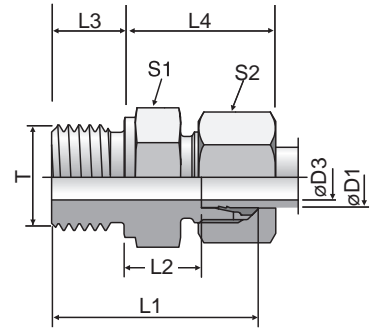

- TABLE OF CONTENTS
- VISUAL INDEX
- D
- FAQs
- ASSEMBLY
- TUBE FAB EQUIP
- GEN TECH

Series	D1	T	D3	L1	L2	L3	L4	S1	S2	Weight g/1 piece	Order code*	PN (bar) <sup>1)</sup>		
												CF	71	MS
LL <sup>2)</sup>	04	M 06×1.0 tap.	2.0	20	16.0	8	26	9*	10	5	GE04LLM6X1KEG	100		
	04	M 08×1.0 tap.	3.0	20	16.0	8	26	10*	10	7	GE04LLM	100	100	63
	06	M 10×1.0 tap.	4.5	20	14.5	8	26	11*	12	9	GE06LLM	100	100	63
	06	M 08×1.0 tap.	3.5	20	14.5	8	26	11*	12	9	GE06LLM8X1KEG	100		
	08	M 10×1.0 tap.	6.0	22	16.5	8	28	12*	14	10	GE08LLM	100	100	63

<sup>1)</sup> Pressure shown = item deliverable

<sup>2)</sup> LL = very light series

$$\frac{PN \text{ (bar)}}{10} = PN \text{ (MPa)}$$

Part numbers shown are body only level. To order with a nut and progressive ring (sleeve) included, please see pages D12 and D13 for part number ordering instructions. Instructions for ordering the fitting as EO-2 is also included on these pages.

\*S1=SW12 in 1.4571

**WARNING:** This product can expose you to chemicals including Lead and Lead Compounds which is known to the State of California to cause cancer and birth defects or other reproductive harm. For more information go to [www.p65warnings.ca.gov](http://www.p65warnings.ca.gov).

\*Please add the suffixes below according to the material/surface required.

Order code suffixes		
Material	Suffix surface and material	Example
Steel, zinc plated, Cr(VI)-free	CFX	GE06LLMCFX
Stainless Steel	71X	GE06LLM71X
Brass	MSX	GE06LLMMSX

[Click here for CADs, Support Resources or to Configure Parts Online](#)

# GAI-R

Female Connector  
24° Flareless / BSPP

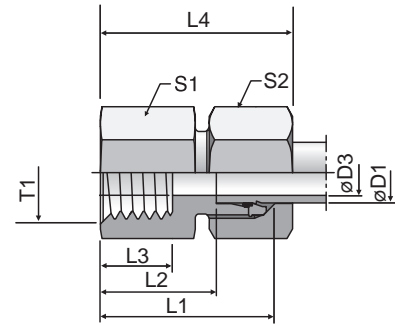

TABLE OF CONTENTS

VISUAL INDEX

FAQs

ASSEMBLY

TUBE FAB EQUIP

GEN TECH

Series	D1	T1	D3	L1	L2	L3	L4	S1	S2	Weight g/1 piece	Order code*	PN (bar) <sup>1)</sup>		
												CF	71	MS
L <sup>3)</sup>	06	G 1/8	4	26.0	19.0	8.0	34	14	14	18	GAI06LR	315	315	200
	06	G 1/4	4	31.0	24.0	12.0	39	19	14	39	GAI06LR1/4	315	315	200
	08	G 1/4	6	31.0	24.0	12.0	39	19	17	39	GAI08LR	315	315	200
	08	G 3/8	6	32.0	25.0	12.0	40	24	17	61	GAI08LR3/8	315	315	200
	08	G 1/2	6	36.0	29.0	14.0	44	27	17	80	GAI08LR1/2	315	315	200
	10	G 1/4	8	32.0	25.0	12.0	40	19	19	40	GAI10LR	315	315	200
	10	G 3/8	8	33.0	26.0	12.0	41	24	19	63	GAI10LR3/8	315	315	200
	10	G 1/2	8	37.0	30.0	14.0	45	27	19	81	GAI10LR1/2	315	315	200
	12	G 3/8	10	33.0	26.0	12.0	41	24	22	64	GAI12LR	315	315	200
	12	G 1/2	10	37.0	30.0	14.0	45	27	22	83	GAI12LR1/2	315	315	200
	15	G 1/2	12	38.0	31.0	14.0	46	27	27	87	GAI15LR	315	315	200
	18	G 1/2	15	38.0	30.5	14.0	47	27	32	89	GAI18LR	315	315	200
	18	G 3/8	15	34.0	26.5	12.0	43	27	32	95	GAI18LR3/8	315	315	200
	22	G 3/4	19	43.0	35.5	16.0	52	36	36	173	GAI22LR	160	160	100
	28	G 1	24	45.5	38.0	18.0	55	41	41	211	GAI28LR	160	160	100
	35	G 1 1/4	30	51.5	41.0	20.0	63	55	50	469	GAI35LR	160	160	100
42	G 1 1/2	36	53.5	42.5	22.0	65	60	60	540	GAI42LR	160	160	100	
S <sup>4)</sup>	06	G 1/4	4	33.0	26.0	12.0	41	19	17	43	GAI06SR	400	400	
	08	G 1/4	5	33.0	26.0	12.0	41	19	19	47	GAI08SR	400	400	
	10	G 3/8	7	34.0	26.5	12.0	43	24	22	68	GAI10SR	400	400	
	12	G 3/8	8	34.0	26.5	12.0	43	24	24	71	GAI12SR	400	400	
	12	G 1/2	8	38.0	30.5	14.0	47	30	24	121	GAI12SR1/2	400	400	
	16	G 1/2	12	40.0	31.5	14.0	50	30	30	126	GAI16SR	400	400	
	20	G 3/4	16	45.0	34.5	16.0	56	36	36	196	GAI20SR	315	315	
	25	G 1	20	49.5	37.5	18.0	62	41	46	246	GAI25SR	315	315	
	30	G 1 1/4	25	55.5	42.0	22.0	69	55	50	537	GAI30SR	315	315	
	38	G 1 1/2	32	59.5	43.5	22.0	74	60	60	649	GAI38SR	250	250	

<sup>1)</sup> Pressure shown = item deliverable

<sup>3)</sup> L = light series; <sup>4)</sup> S = heavy series

$$\frac{PN \text{ (bar)}}{10} = PN \text{ (MPa)}$$

Part numbers shown are body only level. To order with a nut and progressive ring (sleeve) included, please see pages D12 and D13 for part number ordering instructions. Instructions for ordering the fitting as EO-2 is also included on these pages.

**WARNING:** This product can expose you to chemicals including Lead and Lead Compounds which is known to the State of California to cause cancer and birth defects or other reproductive harm. For more information go to [www.p65warnings.ca.gov](http://www.p65warnings.ca.gov).

Order code suffixes		
Material	Suffix surface and material	Example
Steel, zinc plated, Cr(VI)-free	CFX	GAI16SRCFX
Stainless Steel	71X	GAI16SR71X
Brass	MSX	GAI16SRMSX

[Click here for CADs, Support Resources or to Configure Parts Online](#)

# GAI-M

Female Connector  
24° Flareless / Metric

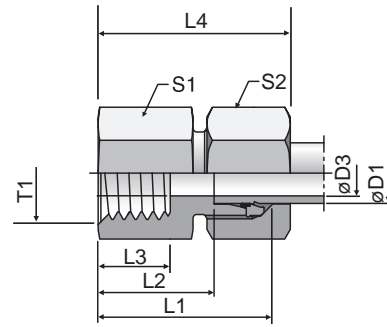

Series	D1	T1	D3	L1	L2	L3	L4	S1	S2	Weight g/1 piece	Order code*	PN (bar) <sup>1)</sup>	
												CF	71
L <sup>3)</sup>	06	M 10×1.0	4	26.5	19.5	8.0	34	14	14	18	GAI06LM	315	315
	08	M 12×1.5	6	31.0	24.0	12.0	39	17	17	32	GAI08LM	315	315
	10	M 14×1.5	8	32.0	25.0	12.0	40	19	19	39	GAI10LM	315	315
	12	M 16×1.5	10	33.0	26.0	12.0	41	22	22	52	GAI12LM	315	315
	15	M 18×1.5	12	35.0	28.0	12.0	43	24	27	68	GAI15LM	315	315
	18	M 22×1.5	15	37.0	29.5	14.0	46	30	32	111	GAI18LM	315	315
	22	M 26×1.5	19	42.0	34.5	16.0	51	32	36	123	GAI22LM	160	160
	28	M 33×2.0	24	45.0	37.5	18.0	54	41	41	211	GAI28LM	160	160
	35	M 42×2.0	30	51.0	40.5	20.0	62	55	50	459	GAI35LM	160	160
	42	M 48×2.0	36	53.0	42.0	22.0	65	60	60	522	GAI42LM	160	160
S <sup>4)</sup>	06	M 12×1.5	4	33.0	26.0	12.0	41	17	17	35	GAI06SM	400	400
	08	M 14×1.5	5	33.0	26.0	12.0	41	17	19	42	GAI08SM	400	400
	10	M 16×1.5	7	34.0	26.5	12.0	43	22	22	58	GAI10SM	400	400
	12	M 18×1.5	8	35.0	27.5	12.0	44	24	24	70	GAI12SM	400	400
	16	M 22×1.5	12	39.0	30.5	14.0	49	30	30	114	GAI16SM	400	400
	20	M 27×2.0	16	45.0	34.5	16.0	56	36	36	189	GAI20SM	315	315
	25	M 33×2.0	20	49.0	37.0	18.0	61	41	46	235	GAI25SM	315	315
	30	M 42×2.0	25	55.0	41.5	20.0	68	55	50	490	GAI30SM	315	315
38	M 48×2.0	32	59.0	43.0	22.0	74	60	60	597	GAI38SM	250	250	

<sup>1)</sup> Pressure shown = item deliverable

<sup>3)</sup> L = light series; <sup>4)</sup> S = heavy series

$$\frac{\text{PN (bar)}}{10} = \text{PN (MPa)}$$

Part numbers shown are body only level. To order with a nut and progressive ring (sleeve) included, please see pages D12 and D13 for part number ordering instructions. Instructions for ordering the fitting as EO-2 is also included on these pages.

\*Please add the **suffixes** below according to the material/ surface required.

Order code suffixes		
Material	Suffix surface and material	Example
Steel, zinc plated, Cr(VI)-free	CFX	GAI16SMCFX
Stainless Steel	71X	GAI16SM71X

TABLE OF CONTENTS

VISUAL INDEX

D

FAQs

ASSEMBLY

TUBE FAB EQUIP

GEN TECH

[Click here for CADs, Support Resources or to Configure Parts Online](#)

# AS

Weld Connector  
24° Flareless / Butt Weld

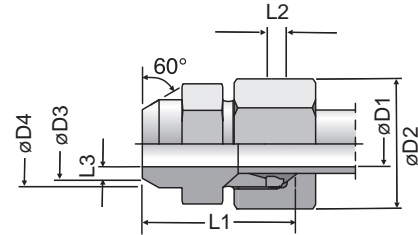

TABLE OF CONTENTS

VISUAL INDEX

FAQs

ASSEMBLY

TUBE FAB EQUIP

GEN TECH

## 6000 PSI Series

Nom. flange size		Tube	D1	D2	D3	D4	L1	L2	L3	Weight (steel) kg/piece	O-ring face Order code*	Flat face Order code*	PN (bar) <sup>1)</sup>	
SAE (in.)	ISO (DN)												S	SS
1/2	13	16x3.0	10	31.8	16	24.0	45	7.8	3.0	0.12	AS62/16X3	ASG62/16X3	420	420
1/2	13	21.3x3.2	13	31.8	22	24.0	45	7.8	4.5	0.12	AS62/21.3X3.2	ASG62/21.3X3.2	420	420
3/4	19	16x3.0	10	41.3	16	31.8	50	8.8	3.0	0.20	AS63/16X3	ASG63/16X3	420	420
3/4	19	20x4.0	12	41.3	20	31.8	50	8.8	4.0	0.19	AS63/20X4	ASG63/20X4	420	420
3/4	19	26.9x4.0	18	41.3	28	32.0	50	8.8	5.0	0.21	AS63/26.9X4	ASG63/26.9X4	420	420
3/4	19	25x5.0	15	41.3	25	31.8	50	8.8	5.0	0.21	AS63/25X5	ASG63/25X5	420	420
1	25	25x5.0	15	47.6	25	38.0	55	9.5	5.0	0.30	AS64/25X5	ASG64/25X5	420	420
1	25	30x4.0	22	47.6	30	38.0	55	9.5	4.0	0.27	AS64/30X4	ASG64/30X4	420	420
1	25	30x6.0	18	47.3	30	38.0	67	9.5	6.0	0.33	AS64/30X6	ASG64/30X6	420	420
1	25	33.7x6.3	22	47.6	35	38.0	55	9.5	6.5	0.32	AS64/33.7X6.3	ASG64/33.7X6.3	420	420
1 1/4	32	30x4.0	22	54.0	30	44.0	60	10.3	4.0	0.48	AS65/30X4	ASG65/30X4	420	420
1 1/4	32	30x6.0	18	54.0	30	44.0	60	10.3	6.0	0.54	AS65/30X6	ASG65/30X6	420	420
1 1/4	32	38x5.0	28	54.0	38	44.0	60	10.3	5.0	0.45	AS65/38X5	ASG65/38X5	420	420
1 1/4	32	38x8.0	22	54.0	38	44.0	60	10.3	8.0	0.54	AS65/38X8	ASG65/38X8	420	420
1 1/4	32	42.4x6.3	29	54.0	44	44.0	60	10.3	7.5	0.48	AS65/42.4X6.3	ASG65/42.4X6.3	420	420
1 1/2	38	38x5.0	28	63.5	38	50.8	65	12.5	5.0	0.72	AS66/38X5	ASG66/38X5	420	420
1 1/2	38	38x8.0	22	63.5	38	50.8	65	12.5	8.0	0.85	AS66/38X8	ASG66/38X8	420	420
1 1/2	38	48.3x8.0	35	63.5	51	51.0	65	12.5	8.0	0.66	AS66/48.3X8	ASG66/48.3X8	420	420
2	51	50x9.0	32	79.4	50	66.6	70	12.5	9.0	1.24	AS68/50X9	ASG68/50X9	420	420
2	51	65x8.0	49	79.4	65	66.6	70	12.5	8.0	0.98	AS68/65X8	ASG68/65X8	420	420
2	51	60.3x10.0	43	79.4	61	67.0	70	12.5	9.0	1.12	AS68/60.3X10	ASG68/60.3X10	420	420
2 1/2	64	73x14.0	45	107.8	74	88.9	90	20.6	14.5	3.38	AS610/73X14	ASG610/73X14	420	420
3	76	88.6x16.0	58	131.7	90	113.8	110	25.6	16.0	6.70	AS612/88.6X16	ASG612/88.6X16	420	420

<sup>1)</sup>Pressure shown = Item deliverable

$$\frac{PN \text{ (bar)}}{10} = PN \text{ (MPa)}$$

The pressures given here are the maximum allowable for the flange fittings. If the pipe or tube used has a lower pressure rating, then the welded assembly rating will be the lower one, assuming the weld is adequately strong.

Stainless steel parts may have dimensional deviations. Additional information on request.

\*Please add the suffixes below according to the material/surface required.

Order code suffixes					
Material	Suffix surface and material	Example only flange adapter	Example incl. splitflanges, metr. bolts and O-ring	Example incl. splitflanges, UNC bolts and O-ring	Standard sealing material (no additional suffix needed)
Steel, oil dipped	S	AS62/16X3S	AS62/16X3SM	AS62/16X3SU	NBR
Stainless steel	SS	AS62/16X3SS	AS62/16X3SSM	—	VIT

Click here for CADs, Support Resources or to Configure Parts Online

# RED

Tube End Reducer  
Flareless Swivel / 24° Flareless

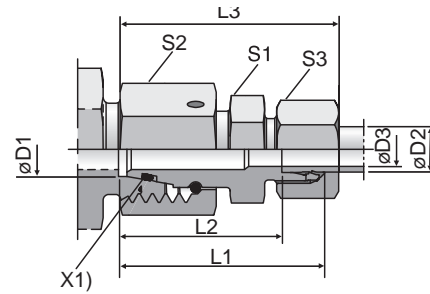

X1) O-ring OR

## L-Series

Series (3) (3) (4)	D1	D2	D3	L1	L2	L3	S1	S2	S3	Weight g/1 piece	Order code*	PN (bar) <sup>1)</sup>	
												CF	71
L/LL	06	04	2.5	28.5	24.5	34.0	9	14	10	17	RED06L/04LLOMD	100	100
L	08	06	4.0	30.5	23.5	38.0	12	17	14	29	RED08/06LOMD	500	315
L	10	06	4.0	32.0	25.0	40.0	14	19	14	36	RED10/06LOMD	500	315
L	10	08	6.0	32.0	25.0	40.0	14	19	17	38	RED10/08LOMD	500	315
L	12	06	4.0	32.0	25.0	40.0	17	22	14	49	RED12/06LOMD	400	315
L	12	08	6.0	32.0	25.0	40.0	17	22	17	49	RED12/08LOMD	400	315
L	12	10	8.0	33.0	26.0	41.0	17	22	19	51	RED12/10LOMD	400	315
L	15	06	4.0	35.5	28.5	43.0	19	27	14	81	RED15/06LOMD	400	315
L	15	08	6.0	35.5	28.5	43.0	19	27	17	85	RED15/08LOMD	400	315
L	15	10	8.0	36.5	29.5	44.0	19	27	19	83	RED15/10LOMD	400	315
L	15	12	10.0	36.5	29.5	44.0	19	27	22	83	RED15/12LOMD	400	315
L	18	06	4.0	35.0	28.0	43.0	24	32	14	109	RED18/06LOMD	400	315
L	18	08	6.0	35.0	28.0	43.0	24	32	17	111	RED18/08LOMD	400	315
L	18	10	8.0	36.0	29.0	44.0	24	32	19	110	RED18/10LOMD	400	315
L	18	12	10.0	36.0	29.0	44.0	24	32	22	110	RED18/12LOMD	400	315
L	18	15	12.0	37.0	30.0	45.0	24	32	27	115	RED18/15LOMD	400	315
L/S	18	16	12.0	40.0	31.5	49.5	27	32	30	138	RED18L/16SOMD	400	315
L	22	06	4.0	39.0	32.0	47.0	27	36	14	158	RED22/06LOMD	250	160
L	22	08	6.0	39.0	32.0	47.0	27	36	17	158	RED22/08LOMD	250	160
L	22	10	8.0	40.0	33.0	48.0	27	36	19	159	RED22/10LOMD	250	160
L	22	12	10.0	40.0	33.0	48.0	27	36	22	157	RED22/12LOMD	250	160
L	22	15	12.0	41.0	34.0	49.0	27	36	27	164	RED22/15LOMD	250	160
L/S	22	16	12.0	43.0	34.5	52.5	27	36	30	173	RED22L/16SOMD	250	160
L	22	18	15.0	41.0	33.5	50.0	27	36	32	167	RED22/18LOMD	250	160
L/S	22	20	16.0	45.0	34.5	56.0	32	36	36	203	RED22L/20SOMD	250	160
L	28	06	4.0	41.0	34.0	49.0	32	41	14	219	RED28/06LOMD	250	160
L	28	08	6.0	41.0	34.0	49.0	32	41	17	221	RED28/08LOMD	250	160
L	28	10	8.0	42.0	35.0	50.0	32	41	19	213	RED28/10LOMD	250	160
L	28	12	10.0	42.0	35.0	50.0	32	41	22	213	RED28/12LOMD	250	160
L	28	15	12.0	43.0	36.0	51.0	32	41	27	218	RED28/15LOMD	250	160
L/S	28	16	12.0	45.0	36.5	54.5	32	41	30	227	RED28L/16SOMD	250	160
L	28	18	15.0	43.0	35.5	52.0	32	41	32	220	RED28/18LOMD	250	160
L	28	22	19.0	45.0	37.5	54.0	32	41	36	222	RED28/22LOMD	250	160
L/S	28	25	20.0	50.0	38.0	62.0	41	41	46	300	RED28L/25SOMD	250	160
L	35	06	4.0	44.0	37.0	52.0	41	50	14	318	RED35/06LOMD	250	160
L	35	08	6.0	44.0	37.0	52.0	41	50	17	318	RED35/08LOMD	250	160
L	35	10	8.0	45.0	38.0	53.0	41	50	19	318	RED35/10LOMD	250	160
L	35	12	10.0	45.0	38.0	53.0	41	50	22	324	RED35/12LOMD	250	160
L	35	15	12.0	46.0	39.0	54.0	41	50	27	328	RED35/15LOMD	250	160
L	35	18	15.0	46.0	38.5	55.0	41	50	32	328	RED35/18LOMD	250	160
L	35	22	19.0	48.0	40.5	57.0	41	50	36	331	RED35/22LOMD	250	160

**WARNING:** This product can expose you to chemicals including Lead and Lead Compounds which is known to the State of California to cause cancer and birth defects or other reproductive harm. For more information go to [www.p65warnings.ca.gov](http://www.p65warnings.ca.gov).

TABLE OF CONTENTS

VISUAL INDEX

D

FAQs

ASSEMBLY

TUBE FAB EQUIP

GEN TECH



[Click here for CADs, Support Resources or to Configure Parts Online](#)

# RED

Tube End Reducer  
Flareless Swivel / 24° Flareless

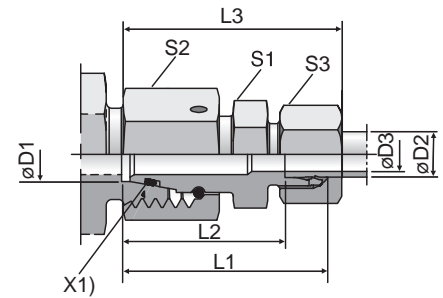

X1) O-ring OR

# L-Series

Series 2) 3) 4)	D1	D2	D3	L1	L2	L3	S1	S2	S3	Weight g/1 piece	Order code*	PN (bar) <sup>1)</sup>	
												CF	71
L/S	35	25	20.0	52.0	40.0	64.0	41	50	46	366	RED35L/25SOMD	250	160
L	35	28	24.0	48.0	40.5	57.0	41	50	41	327	RED35/28LOMD	250	160
L/S	35	30	25.0	55.0	41.5	68.0	46	50	50	435	RED35L/30SOMD	250	160
L	42	10	8.0	48.5	41.5	56.0	50	60	19	537	RED42/10LOMD	250	160
L	42	12	10.0	48.5	41.5	56.0	50	60	22	538	RED42/12LOMD	250	160
L	42	15	12.0	49.5	42.5	58.0	50	60	27	534	RED42/15LOMD	250	160
L	42	18	15.0	49.5	42.0	58.0	50	60	32	544	RED42/18LOMD	250	160
L	42	22	19.0	51.5	44.0	60.0	50	60	36	543	RED42/22LOMD	250	160
L	42	28	24.0	51.5	44.0	61.0	50	60	41	539	RED42/28LOMD	250	160
L/S	42	30	25.0	57.5	44.0	70.5	50	60	50	588	RED42L/30SOMD	250	160
L	42	35	30.0	53.5	43.0	65.0	50	60	50	541	RED42/35LOMD	250	160
L/S	42	38	32.0	61.5	45.5	76.0	55	60	60	701	RED42L/38SOMD	250	160

<sup>1)</sup> Pressure shown = item deliverable

<sup>2)</sup> LL = very light series; <sup>3)</sup> L = light series; <sup>4)</sup> S = heavy series

$$\frac{PN \text{ (bar)}}{10} = PN \text{ (MPa)}$$

Part numbers shown are body only level. To order with a nut and progressive ring (sleeve) included, please see pages D12 and D13 for part number ordering instructions. Instructions for ordering the fitting as EO-2 is also included on these pages.

Order code suffixes			
Material	Suffix surface and material	Example	Standard sealing material (no additional suffix needed)
Steel, zinc plated, Cr(VI)-free	CF	RED18/15LOMDCF	NBR
Stainless Steel	71	RED18/15LOMD71	VIT

**WARNING:** This product can expose you to chemicals including Lead and Lead Compounds which is known to the State of California to cause cancer and birth defects or other reproductive harm. For more information go to [www.p65warnings.ca.gov](http://www.p65warnings.ca.gov).

[Click here for CADs, Support Resources or to Configure Parts Online](#)

# RED

Tube End Reducer  
Flareless Swivel / 24° Flareless

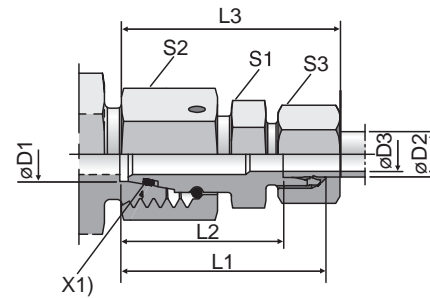

X1) O-ring OR

# S-Series

Series (1)	D1	D2	D3	L1	L2	L3	S1	S2	S3	Weight g/1 piece	Order code*	PN (bar) <sup>1)</sup>	
												CF	71
S	08	06	4	34.0	27.0	42	14	19	17	42	RED08/06SOMD	800	630
S	10	06	4	34.5	27.5	42	17	22	17	55	RED10/06SOMD	800	630
S	10	08	5	34.5	27.5	42	17	22	19	58	RED10/08SOMD	800	630
S	12	06	4	36.0	29.0	44	17	24	17	66	RED12/06SOMD	630	630
S	12	08	5	36.0	29.0	44	17	24	19	68	RED12/08SOMD	630	630
S	12	10	7	37.0	29.5	46	19	24	22	75	RED12/10SOMD	630	630
S	16	06	4	39.0	32.0	47	22	30	17	112	RED16/06SOMD	630	400
S	16	08	5	39.0	32.0	47	22	30	19	114	RED16/08SOMD	630	400
S	16	10	7	39.0	31.5	48	22	30	22	115	RED16/10SOMD	630	400
S	16	12	8	39.0	31.5	48	22	30	24	118	RED16/12SOMD	630	400
S/L	16	15	11	39.0	32.0	47	24	30	27	120	RED16S/15LOMD	400	315
S	20	06	4	43.0	36.0	51	27	36	17	172	RED20/06SOMD	420	400
S	20	08	5	43.0	36.0	51	27	36	19	174	RED20/08SOMD	420	400
S	20	10	7	43.0	35.5	52	27	36	22	174	RED20/10SOMD	420	400
S	20	12	8	43.0	35.5	52	27	36	24	177	RED20/12SOMD	420	400
S/L	20	15	12	43.0	36.0	51	27	36	27	173	RED20S/15LOMD	400	315
S	20	16	12	45.0	36.5	55	27	36	30	182	RED20/16SOMD	420	400
S/L	20	18	14	43.0	35.5	51	27	36	32	178	RED20S/18LOMD	400	315
S	25	06	4	45.5	38.5	53	32	46	17	294	RED25/06SOMD	420	400
S	25	08	5	45.5	38.5	53	32	46	19	295	RED25/08SOMD	420	400
S	25	10	7	45.5	38.0	54	32	46	22	296	RED25/10SOMD	420	400
S	25	12	8	45.5	38.0	54	32	46	24	299	RED25/12SOMD	420	400
S	25	16	12	47.5	39.0	57	32	46	30	304	RED25/16SOMD	420	400
S/L	25	18	15	45.5	38.0	54	32	46	32	299	RED25S/18LOMD	400	315
S	25	20	16	49.5	39.0	61	32	46	36	315	RED25/20SOMD	420	400
S/L	25	22	18	47.5	40.0	56	32	46	36	304	RED25S/22LOMD	250	160
S	30	06	4	51.0	44.0	59	41	50	17	412	RED30/06SOMD	420	400
S	30	08	5	51.0	44.0	59	41	50	19	404	RED30/08SOMD	420	400
S	30	10	7	51.0	43.5	60	41	50	22	405	RED30/10SOMD	420	400
S	30	12	8	51.0	43.5	60	41	50	24	405	RED30/12SOMD	420	400
S	30	16	12	53.0	44.5	63	41	50	30	412	RED30/16SOMD	420	400
S	30	20	16	55.0	44.5	66	41	50	36	421	RED30/20SOMD	420	400
S/L	30	22	19	53.0	45.5	61	41	50	36	406	RED30S/22LOMD	250	160
S	30	25	20	57.0	45.0	69	41	50	46	439	RED30/25SOMD	420	400
S/L	30	28	23	53.0	45.5	62	41	50	41	406	RED30S/28LOMD	250	160
S	38	06	4	54.5	47.5	62	50	60	17	556	RED38/06SOMD	420	315
S	38	08	5	54.5	47.5	62	50	60	19	581	RED38/08SOMD	420	315
S	38	10	7	54.5	47.0	63	50	60	22	579	RED38/10SOMD	420	315
S	38	12	8	54.5	47.0	63	50	60	24	577	RED38/12SOMD	420	315
S	38	16	12	56.5	48.0	66	50	60	30	580	RED38/16SOMD	420	315

\*Please add the suffixes below according to the material/surface required.

**WARNING:** This product can expose you to chemicals including Lead and Lead Compounds which is known to the State of California to cause cancer and birth defects or other reproductive harm. For more information go to [www.p65warnings.ca.gov](http://www.p65warnings.ca.gov).

TABLE OF CONTENTS

VISUAL INDEX

D

FAQs

ASSEMBLY

TUBE FAB EQUIP

GEN TECH

[Click here for CADs, Support Resources or to Configure Parts Online](#)

## RED

Tube End Reducer  
Flareless Swivel / 24° Flareless

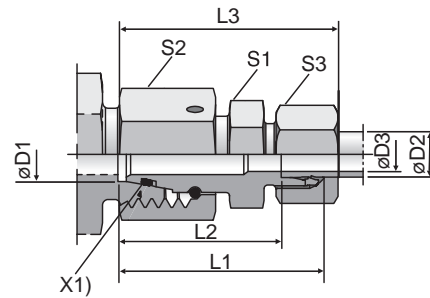

X1) O-ring OR

## S-Series

Series <sup>3) 4)</sup>	D1	D2	D3	L1	L2	L3	S1	S2	S3	Weight g/1 piece	Order code*	PN (bar) <sup>1)</sup>	
												CF	71
S	38	20	16	58.5	48.0	70	50	60	36	601	RED38/20SOMD	420	315
S	38	25	20	60.5	48.5	73	50	60	46	615	RED38/25SOMD	420	315
S/L	38	28	24	56.5	49.0	65	50	60	41	573	RED38S/28LOMD	250	160
S	38	30	25	62.5	49.0	76	50	60	50	625	RED38/30SOMD	420	315
S/L	38	35	30	58.5	48.0	69	50	60	50	588	RED38S/35LOMD	250	160

<sup>1)</sup> Pressure shown = item deliverable

<sup>3)</sup> L = light series; <sup>4)</sup> S = heavy series

$\frac{PN \text{ (bar)}}{10} = PN \text{ (MPa)}$

Part numbers shown are body only level. To order with a nut and progressive ring (sleeve) included, please see pages D12 and D13 for part number ordering instructions. Instructions for ordering the fitting as EO-2 is also included on these pages.

TABLE  
OF  
CONTENTS

VISUAL  
INDEX

FAQs

ASSEMBLY

TUBE FAB  
EQUIP

GEN TECH

**WARNING:** This product can expose you to chemicals including Lead and Lead Compounds which is known to the State of California to cause cancer and birth defects or other reproductive harm. For more information go to [www.p65warnings.ca.gov](http://www.p65warnings.ca.gov).

[Click here for CADs, Support Resources or to Configure Parts Online](#)

# DA

Distance Piece Adapter  
Flareless Swivel / 24° Flareless

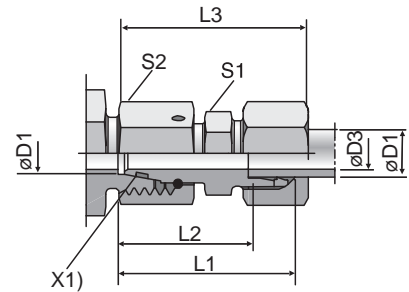

X1) O-ring OR

TABLE OF CONTENTS

VISUAL INDEX

D

FAQs

ASSEMBLY

TUBE FAB EQUIP

GEN TECH

Series	D1	D3	L1	L2	L3	S1	S2	Weight g/1 piece	Order code*	PN (bar) <sup>1)</sup>		
										CF	71	MS
L <sup>3)</sup>	06	2.5	43.0	36	51	12	14	33	DA06LOMD	500	315	200
	08	4.0	43.0	36	51	14	17	46	DA08LOMD	500	315	200
	10	6.0	43.0	36	51	17	19	60	DA10LOMD	500	315	200
	12	8.0	43.0	36	51	19	22	75	DA12LOMD	400	315	200
	15	10.0	43.0	36	51	24	27	118	DA15LOMD	400	315	200
	18	13.0	43.5	36	52	27	32	153	DA18LOMD	400	315	200
	22	17.0	47.5	40	56	32	36	210	DA22LOMD	250	160	100
	28	22.0	47.5	40	57	41	41	279	DA28LOMD	250	160	100
	35	28.0	60.5	50	72	46	50	468	DA35LOMD	250	160	100
	42	34.0	71.0	60	83	55	60	802	DA42LOMD	250	160	100
S <sup>4)</sup>	06	2.5	43.0	36	51	14	17	48	DA06SOMD	800	630	400
	08	4.0	43.0	36	51	17	19	64	DA08SOMD	800	630	400
	10	6.0	43.5	36	52	19	22	81	DA10SOMD	800	630	400
	12	8.0	43.5	36	52	22	24	97	DA12SOMD	630	630	400
	16	11.0	48.5	40	58	27	30	166	DA16SOMD	630	400	250
	20	14.0	56.5	46	68	32	36	265	DA20SOMD	420	400	250
	25	18.0	62.0	50	74	41	46	466	DA25SOMD	420	400	250
	30	23.0	69.5	56	83	46	50	601	DA30SOMD	420	400	250
38	30.0	76.0	60	91	55	60	871	DA38SOMD	420	315	200	

<sup>1)</sup> Pressure shown = item deliverable

<sup>3)</sup> L = light series; <sup>4)</sup> S = heavy series

$$\frac{\text{PN (bar)}}{10} = \text{PN (MPa)}$$

Part numbers shown are body only level. To order with a nut and progressive ring (sleeve) included, please see pages D12 and D13 for part number ordering instructions. Instructions for ordering the fitting as EO-2 is also included on these pages.

\*Please add the suffixes below according to the material/surface required.

Order code suffixes			
Material	Suffix surface and material	Example	Standard sealing material (no additional suffix needed)
Steel, zinc plated, Cr(VI)-free	CF	DA16SOMDCF	NBR
Stainless Steel	71	DA16SOMD71	VIT
Brass	MS	DA16SOMDMS	NBR

**WARNING:** This product can expose you to chemicals including Lead and Lead Compounds which is known to the State of California to cause cancer and birth defects or other reproductive harm. For more information go to [www.p65warnings.ca.gov](http://www.p65warnings.ca.gov).

[Click here for CADs, Support Resources or to Configure Parts Online](#)

# GZ

Swivel Union  
Flareless Swivel /  
Flareless Swivel

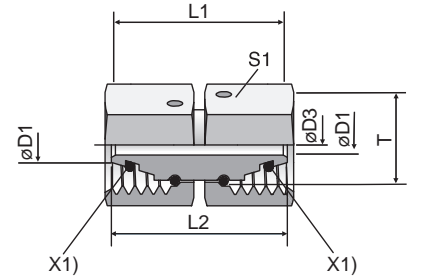

X1) O-ring OR

TABLE OF CONTENTS

VISUAL INDEX

FAQs

ASSEMBLY

TUBE FAB EQUIP

GEN TECH

Series	D1 <i>a</i>	T	D3	L1	L2	S1	Weight g/1 piece	Order code*	PN (bar) <sup>1)</sup>	
									CF	71
L <sup>3)</sup>	06	M 12×1.5	2.5	32	32	14	28	GZ06L	500	315
	08	M 14×1.5	4.0	32	32	17	41	GZ08L	500	315
	10	M 16×1.5	6.0	33	33	19	53	GZ10L	500	315
	12	M 18×1.5	8.0	33	33	22	71	GZ12L	400	315
	15	M 22×1.5	10.0	38	38	27	129	GZ15L	400	315
	18	M 26×1.5	13.0	36	38	32	165	GZ18L	400	315
	22	M 30×2.0	17.0	42	44	36	243	GZ22L	250	160
	28	M 36×2.0	22.0	46	48	41	319	GZ28L	250	160
	35	M 45×2.0	28.0	48	52	50	449	GZ35L	250	160
	42	M 52×2.0	34.0	52	57	60	737	GZ42L	250	160
S <sup>4)</sup>	06	M 14×1.5	2.5	32	33	17	41	GZ06S	800	630
	08	M 16×1.5	4.0	33	34	19	54	GZ08S	800	630
	10	M 18×1.5	6.0	33	35	22	74	GZ10S	800	630
	12	M 20×1.5	8.0	36	38	24	95	GZ12S	630	630
	16	M 24×1.5	11.0	39	42	30	172	GZ16S	630	400
	20	M 30×2.0	14.0	44	48	36	261	GZ20S	420	400
	25	M 36×2.0	18.0	46	53	46	477	GZ25S	420	400
	30	M 42×2.0	23.0	52	62	50	605	GZ30S	420	400
	38	M 52×2.0	30.0	52	67	60	826	GZ38S	420	315

<sup>1)</sup> Pressure shown = item deliverable

<sup>3)</sup> L = light series; <sup>4)</sup> S = heavy series

$$\frac{\text{PN (bar)}}{10} = \text{PN (MPa)}$$

\*Please add the **suffixes** below according to the material/surface required.

Order code suffixes			
Material	Suffix surface and material	Example	Standard sealing material (no additional suffix needed)
Steel, zinc plated, Cr(VI)-free	CF	GZ16SCF	NBR
Stainless Steel	71	GZ16S71	VIT

**WARNING:** This product can expose you to chemicals including Lead and Lead Compounds which is known to the State of California to cause cancer and birth defects or other reproductive harm. For more information go to [www.p65warnings.ca.gov](http://www.p65warnings.ca.gov).



Click here for CADs, Support Resources or to Configure Parts Online

# GZR

Swivel Union Reducer

Flareless Swivel / Flareless Swivel

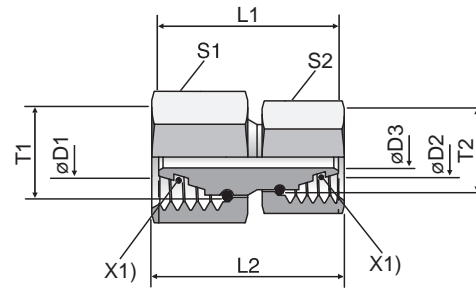

X1) O-ring OR

Series 3) 4)	D1 	D2 	T1	T2	D3	L1	L2	S1	S2	Weight g/1 piece	Order code*	PN (bar) <sup>1)</sup>	
												CF	71
L/S	06	06	M 14×1.5	M 12×1.5	2.5	32	32.0	17	14	34	GZR06L/06S	500	500
L	08	06	M 14×1.5	M 12×1.5	2.5	32	32.0	17	14	36	GZR08/06L	500	500
L/S	08	08	M 16×1.5	M 14×1.5	4.0	33	33.0	19	17	48	GZR08L/08S	500	500
L	10	06	M 16×1.5	M 12×1.5	2.5	33	33.0	19	14	44	GZR10/06L	500	500
L	10	08	M 16×1.5	M 14×1.5	4.0	34	34.0	19	17	50	GZR10/08L	500	500
L/S	10	10	M 18×1.5	M 16×1.5	6.0	33.5	33.5	22	19	63	GZR10L/10S	500	500
L	12	06	M 18×1.5	M 12×1.5	2.5	33	33.0	22	14	56	GZR12/06L	400	400
L	12	08	M 18×1.5	M 14×1.5	4.0	33	33.0	22	17	62	GZR12/08L	400	400
L	12	10	M 18×1.5	M 16×1.5	6.0	33	33.0	22	19	65	GZR12/10L	400	400
L/S	12	12	M 20×1.5	M 18×1.5	8.0	36	36.0	24	22	85	GZR12L/12S	400	400
L	15	08	M 22×1.5	M 14×1.5	4.0	38	38.0	27	17	98	GZR15/08L	400	400
L	15	10	M 22×1.5	M 16×1.5	6.0	38	38.0	27	19	101	GZR15/10L	400	400
L	15	12	M 22×1.5	M 18×1.5	8.0	38	38.0	27	22	108	GZR15/12L	400	400
L	18	10	M 26×1.5	M 16×1.5	6.0	36	37.5	32	19	125	GZR18/10L	400	400
L	18	12	M 26×1.5	M 18×1.5	8.0	36	37.5	32	22	132	GZR18/12L	400	400
L	18	15	M 26×1.5	M 22×1.5	10.0	38	39.5	32	27	155	GZR18/15L	400	400
L/S	18	16	M 26×1.5	M 24×1.5	11.0	39	41.5	32	30	177	GZR18L/16S	400	400
L	22	12	M 30×2.0	M 18×1.5	8.0	42	43.5	36	22	195	GZR22/12L	250	250
L	22	15	M 30×2.0	M 22×1.5	10.0	42	43.5	36	27	215	GZR22/15L	250	250
L	22	18	M 30×2.0	M 26×1.5	13.0	42	44.0	36	32	228	GZR22/18L	250	250
L/S	22	20	M 30×2.0	M 30×2.0	14.0	44	47.0	36	36	266	GZR22L/20S	250	250
L	28	15	M 36×2.0	M 22×1.5	10.0	46	47.5	41	27	143	GZR28/15L	250	250
L	28	18	M 36×2.0	M 26×1.5	13.0	46	48.0	41	32	311	GZR28/18L	250	250
L	28	22	M 36×2.0	M 30×2.0	17.0	46	46.0	41	36	309	GZR28/22L	250	250
L/S	28	25	M 36×2.0	M 36×2.0	18.0	46	50.5	41	46	419	GZR28L/25S	250	250
L	35	18	M 45×2.0	M 26×1.5	13.0	48	51.0	50	32	430	GZR35/18L	250	250
L	35	22	M 45×2.0	M 30×2.0	17.0	48	51.0	50	36	429	GZR35/22L	250	250
L	35	28	M 45×2.0	M 36×2.0	22.0	48	51.0	50	41	415	GZR35/28L	250	250
L/S	35	30	M 45×2.0	M 42×2.0	23.0	52	59.0	50	50	577	GZR35L/30S	250	250
L	42	22	M 52×2.0	M 30×2.0	17.0	52	55.5	60	36	653	GZR42/22L	250	250
L	42	28	M 52×2.0	M 36×2.0	22.0	52	55.5	60	41	648	GZR42/28L	250	250
L	42	35	M 52×2.0	M 45×2.0	28.0	52	56.5	60	50	662	GZR42/35L	250	250
L/S	42	38	M 52×2.0	M 52×2.0	30.0	52	62.0	60	60	822	GZR42L/38S	250	250
S	08	06	M 16×1.5	M 14×1.5	2.5	33	34.0	19	17	49	GZR08/06S	800	800
S	10	06	M 18×1.5	M 14×1.5	2.5	33	34.5	22	17	60	GZR10/06S	800	800
S	10	08	M 18×1.5	M 16×1.5	4.0	33	34.5	22	19	66	GZR10/08S	800	800
S	12	06	M 20×1.5	M 14×1.5	2.5	36	37.5	24	17	77	GZR12/06S	630	630
S	12	08	M 20×1.5	M 16×1.5	4.0	36	37.5	24	19	82	GZR12/08S	630	630
S	12	10	M 20×1.5	M 18×1.5	6.0	36	38.0	24	22	89	GZR12/10S	630	630
S	16	10	M 24×1.5	M 18×1.5	6.0	39	41.5	30	22	138	GZR16/10S	630	630
S	16	12	M 24×1.5	M 20×1.5	8.0	39	41.5	30	24	143	GZR16/12S	630	630
S/L	16	15	M 24×1.5	M 22×1.5	10.0	39	41.0	30	27	153	GZR16S/15L	400	400
S	20	12	M 30×2.0	M 20×1.5	8.0	44	47.0	36	24	204	GZR20/12S	420	420

**WARNING:** This product can expose you to chemicals including Lead and Lead Compounds which is known to the State of California to cause cancer and birth defects or other reproductive harm. For more information go to [www.p65warnings.ca.gov](http://www.p65warnings.ca.gov).

TABLE OF CONTENTS

VISUAL INDEX

D

FAQs

ASSEMBLY

TUBE FAB EQUIP

GEN TECH

[Click here for CADs, Support Resources or to Configure Parts Online](#)

# GZR

Swivel Union Reducer  
Flareless Swivel / Flareless Swivel

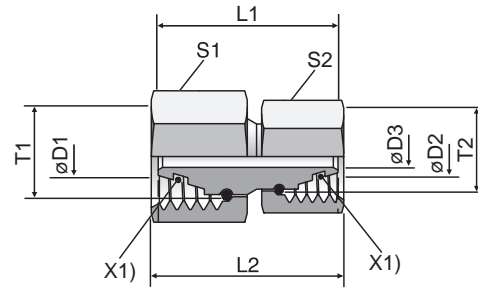

X1) O-ring OR

Series 3) 4)	D1	D2	T1	T2	D3	L1	L2	S1	S2	Weight g/1 piece	Order code*	PN (bar) <sup>1)</sup>	
												CF	71
S	20	16	M 30x2.0	M 24x1.5	11.0	44	47.5	36	30	232	<b>GZR20/16S</b>	420	420
S/L	20	18	M 30x2.0	M 26x1.5	13.0	44	47.0	36	32	224	<b>GZR20S/18L</b>	400	400
S	25	16	M 36x2.0	M 24x1.5	11.0	46	51.0	46	30	224	<b>GZR25/16S</b>	420	420
S	25	20	M 36x2.0	M 30x2.0	14.0	46	51.5	46	36	364	<b>GZR25/20S</b>	420	420
S/L	25	22	M 36x2.0	M 30x2.0	17.0	46	50.5	46	36	475	<b>GZR25S/22L</b>	250	250
S	30	16	M 42x2.0	M 24x1.5	11.0	52	58.5	50	30	475	<b>GZR30/16S</b>	420	420
S	30	20	M 42x2.0	M 30x2.0	14.0	52	59.0	50	36	500	<b>GZR30/20S</b>	420	420
S	30	25	M 42x2.0	M 36x2.0	18.0	52	60.5	50	46	589	<b>GZR30/25S</b>	420	420
S/L	30	28	M 42x2.0	M 36x2.0	22.0	52	58.0	50	41	476	<b>GZR30S/28L</b>	250	250
S	38	20	M 52x2.0	M 30x2.0	14.0	52	61.5	60	36	671	<b>GZR38/20S</b>	420	420
S	38	25	M 52x2.0	M 36x2.0	18.0	52	63.0	60	46	759	<b>GZR38/25S</b>	420	420
S	38	30	M 52x2.0	M 42x2.0	23.0	52	64.5	60	50	767	<b>GZR38/30S</b>	420	420
S/L	38	35	M 52x2.0	M 45x2.0	28.0	52	61.5	60	50	662	<b>GZR38S/35L</b>	250	250

1) Pressure shown = item deliverable

3) L = light series; 4) S = heavy series

$$\frac{\text{PN (bar)}}{10} = \text{PN (MPa)}$$

TABLE OF CONTENTS

VISUAL INDEX

FAQs

ASSEMBLY

TUBE FAB EQUIP

GEN TECH

Order code suffixes			
Material	Suffix surface and material	Example	Standard sealing material (no additional suffix needed)
Steel, zinc plated, Cr(VI)-free	CF	GZR16/12SCF	NBR
Stainless steel	71	GZR16/12S71	VIT

\*Please add the **suffixes** below according to the material/surface required.

**WARNING:** This product can expose you to chemicals including Lead and Lead Compounds which is known to the State of California to cause cancer and birth defects or other reproductive harm. For more information go to [www.p65warnings.ca.gov](http://www.p65warnings.ca.gov).

[Click here for CADs, Support Resources or to Configure Parts Online](#)

# EGE-NPT

Swivel Connector  
Flareless Swivel / NPT

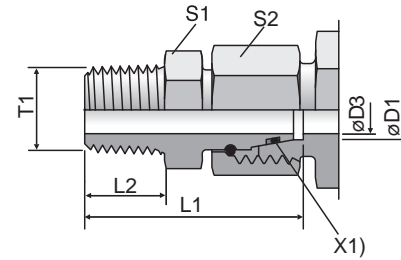

X1) O-ring OR

Series	D1	T1	D3	L1	L2	S1	S2	Weight g/1 piece	Order code*	PN (bar) <sup>1)</sup>	CF
L <sup>3)</sup>	06	1/8-27 NPT	2.5	31.5	10.0	11	14	23	EGE06L1/8NPT	315	315
	08	1/4-18 NPT	4.0	37.5	14.5	14	17	41	EGE08L1/4NPT	315	315
	10	1/4-18 NPT	6.0	38.0	14.5	14	19	44	EGE10L1/4NPT	315	315
	12	3/8-18 NPT	8.0	40.0	14.5	19	22	69	EGE12L3/8NPT	315	315
	15	1/2-14 NPT	10.0	49.5	19.5	22	27	127	EGE15L1/2NPT	315	315
	18	1/2-14 NPT	12.0	49.0	19.5	24	32	142	EGE18L1/2NPT	315	315
	22	3/4-14 NPT	16.0	52.0	19.5	27	36	200	EGE22L3/4NPT	160	160
	28	1-11.5 NPT	22.0	61.0	24.5	36	41	306	EGE28L1NPT	160	160
	35	1 1/4-11.5 NPT	28.0	65.5	25.0	46	50	486	EGE35L11/4NPT	160	160
	42	1 1/2-11.5 NPT	34.0	68.5	26.0	50	60	662	EGE42L11/2NPT	160	160
S <sup>4)</sup>	06	1/4-18 NPT	2.5	37.5	14.5	14	17	42	EGE06S1/4NPT	630	630
	08	1/4-18 NPT	4.0	38.0	14.5	14	19	47	EGE08S1/4NPT	630	630
	10	3/8-18 NPT	6.0	40.5	14.5	19	22	75	EGE10S3/8NPT	630	630
	12	3/8-18 NPT	8.0	42.0	14.5	19	24	81	EGE12S3/8NPT	630	630
	16	1/2-14 NPT	11.0	51.0	19.5	22	30	145	EGE16S1/2NPT	400	400
	20	3/4-14 NPT	14.0	54.0	19.5	27	36	221	EGE20S3/4NPT	400	400
	25	1-11.5 NPT	18.0	63.5	24.5	36	46	422	EGE25S1NPT	400	400
	30	1 1/4-11.5 NPT	23.0	70.5	25.0	46	50	628	EGE30S11/4NPT	400	400
	38	1 1/2-11.5 NPT	30.0	73.5	26.0	50	60	770	EGE38S11/2NPT	315	315

<sup>1)</sup> Pressure shown = item deliverable

<sup>3)</sup> L = light series; <sup>4)</sup> S = heavy series

$$\frac{\text{PN (bar)}}{10} = \text{PN (MPa)}$$



**WARNING:** This product can expose you to chemicals including Lead and Lead Compounds which is known to the State of California to cause cancer and birth defects or other reproductive harm. For more information go to [www.p65warnings.ca.gov](http://www.p65warnings.ca.gov).

\*Please add the **suffixes** below according to the material/surface required.

Order code suffixes			
Material	Suffix surface and material	Example	Standard sealing material (no additional suffix needed)
Steel, zinc plated, Cr(VI)-free	CF	EGE16S1/2NPTCF	NBR

TABLE OF CONTENTS

VISUAL INDEX

D

FAQs

ASSEMBLY

TUBE FAB EQUIP

GEN TECH

[Click here for CADs, Support Resources or to Configure Parts Online](#)

# EGEO

Swivel Connector

Metric ISO 6149 / Flareless Swivel

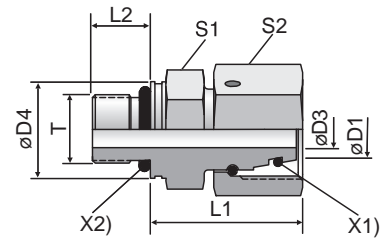

X2) O-ring OR

X1) O-ring OR

Series	D1	T	D3	D4	L1	L2	S1	S2	Weight g/1 piece	Order code*	PN (bar) <sup>1)</sup> CF
L <sup>3)</sup>	06	M 10×1.0	2.5	13.8	24.5	8.5	14	14	29	EGEO06LM	500
	08	M 12×1.5	4.0	16.8	26.5	11.0	17	17	43	EGEO08LM	500
	10	M 14×1.5	6.0	18.8	27.5	11.0	19	19	57	EGEO10LM	500
	12	M 16×1.5	8.0	21.8	30.5	11.5	22	22	85	EGEO12LM	400
	15	M 18×1.5	10.0	23.8	31.5	12.5	24	27	115	EGEO15LM	400
	18	M 22×1.5	13.0	26.8	31.5	13.0	27	32	152	EGEO18LM	400
	22	M 27×2.0	17.0	31.8	32.5	16.0	32	36	207	EGEO22LM27X2	250
	28	M 33×2.0	22.0	40.8	35.0	16.0	41	41	294	EGEO28LM	250
	35	M 42×2.0	28.0	49.8	42.5	16.0	50	50	516	EGEO35LM	250
42	M 48×2.0	34.0	54.8	46.5	17.5	55	60	718	EGEO42LM	250	
S <sup>4)</sup>	06	M 12×1.5	2.5	16.8	27.0	11.0	17	17	49	EGEO06SM	800
	08	M 14×1.5	4.0	18.8	29.5	11.0	19	19	69	EGEO08SM	800
	10	M 16×1.5	6.0	21.8	32.0	12.5	22	22	96	EGEO10SM	800
	12	M 18×1.5	8.0	23.8	34.0	14.0	24	24	116	EGEO12SM	630
	16	M 22×1.5	11.0	26.8	37.0	15.0	27	30	179	EGEO16SM	630
	20	M 27×2.0	14.0	31.8	43.0	18.5	32	36	280	EGEO20SM	420
	25	M 33×2.0	18.0	40.8	48.0	18.5	41	46	502	EGEO25SM	420
	30	M 42×2.0	23.0	49.8	51.0	19.0	50	50	697	EGEO30SM	420
	38	M 48×2.0	30.0	54.8	60.0	21.5	55	60	965	EGEO38SM	420

<sup>1)</sup> Pressure shown = item deliverable

<sup>3)</sup> L = light series; <sup>4)</sup> S = heavy series

$$\frac{PN \text{ (bar)}}{10} = PN \text{ (MPa)}$$

**WARNING:** This product can expose you to chemicals including Lead and Lead Compounds which is known to the State of California to cause cancer and birth defects or other reproductive harm. For more information go to [www.p65warnings.ca.gov](http://www.p65warnings.ca.gov).

\*Please add the **suffixes** below according to the material/surface required.

Order code suffixes			
Material	Suffix surface and material	Example	Standard sealing material (no additional suffix needed)
Steel, zinc plated, Cr(VI)-free	CF	EGEO16SMCF	NBR

TABLE OF CONTENTS

VISUAL INDEX

FAQs

ASSEMBLY

TUBE FAB EQUIP

GEN TECH

[Click here for CADs, Support Resources or to Configure Parts Online](#)

## EGE-R-ED

Swivel Connector  
Flareless Swivel / BSPP with  
EOlastic Seal

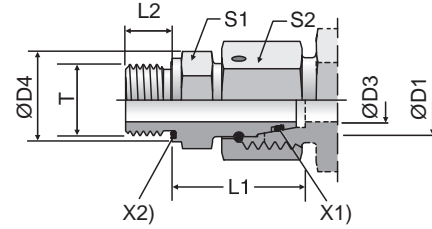

X2) Eolastic-sealing ED X1) O-ring OR

TABLE  
OF  
CONTENTS

VISUAL  
INDEX

D

FAQs

ASSEMBLY

TUBE FAB  
EQUIP

GEN TECH

Series	D1	T	D3	D4	L1	L2	S1	S2	Weight g/1 piece	Order code*	PN (bar) <sup>1)</sup>	
											CF	71
L <sup>3)</sup>	06	G 1/8 A	2.5	14	24.5	8	14	14	27	EGE06LRED	500	315
	08	G 1/4 A	4.0	19	29.5	12	19	17	28	EGE08LRED	500	315
	10	G 1/4 A	6.0	19	27.5	12	19	19	54	EGE10LRED	500	315
	10	G 3/8 A	6.0	22	29.0	12	22	19	70	EGE10LR3/8ED	400	315
	12	G 3/8 A	8.0	22	34.0	12	22	22	95	EGE12LRED	400	315
	12	G 1/4 A	6.0	19	27.5	12	19	22	65	EGE12LR1/4ED	400	315
	12	G 1/2 A	8.0	27	29.5	14	27	22	114	EGE12LR1/2ED	400	315
	15	G 1/2 A	10.0	27	32.0	14	27	27	137	EGE15LRED	400	315
	18	G 1/2 A	13.0	27	31.5	14	27	32	143	EGE18LRED	400	315
	18	G 3/4 A	13.0	32	29.5	16	32	32	182	EGE18LR3/4ED	250	160
	22	G 3/4 A	17.0	32	32.5	16	32	36	200	EGE22LRED	250	160
	28	G 1 A	22.0	40	35.0	18	41	41	289	EGE28LRED	250	160
	35	G 1 1/4 A	28.0	50	42.5	20	50	50	500	EGE35LRED	250	160
	42	G 1 1/2 A	34.0	55	46.5	22	55	60	718	EGE42LRED	250	160
S <sup>4)</sup>	06	G 1/4 A	2.5	19	27.0	12	19	17	53	EGE06SRED	800	630
	08	G 1/4 A	4.0	19	29.5	12	19	19	64	EGE08SRED	800	630
	10	G 3/8 A	6.0	22	32.0	12	22	22	93	EGE10SRED	800	630
	12	G 3/8 A	8.0	22	34.0	12	22	24	100	EGE12SRED	630	630
	12	G 1/4 A	5.0	19	31.5	12	19	24	140	EGE12SR1/4ED	630	630
	12	G 1/2 A	8.0	27	35.0	14	27	24	140	EGE12SR1/2ED	630	630
	16	G 1/2 A	11.0	27	37.0	14	27	30	170	EGE16SRED	630	400
	20	G 3/4 A	14.0	32	43.0	16	32	36	273	EGE20SRED	420	400
	25	G 1 A	18.0	40	48.0	18	41	46	493	EGE25SRED	420	400
	30	G 1 1/4 A	23.0	50	51.0	20	50	50	691	EGE30SRED	420	400
38	G 1 1/2 A	30.0	55	60.0	22	55	60	934	EGE38SRED	420	315	

<sup>1)</sup> Pressure shown = item deliverable

<sup>3)</sup> L = light series; <sup>4)</sup> S = heavy series

$$\frac{\text{PN (bar)}}{10} = \text{PN (MPa)}$$

**WARNING:** This product can expose you to chemicals including Lead and Lead Compounds which is known to the State of California to cause cancer and birth defects or other reproductive harm. For more information go to [www.p65warnings.ca.gov](http://www.p65warnings.ca.gov).

\*Please add the **suffixes** below according to the material/surface required.

Order code suffixes			
Material	Suffix surface and material	Example	Standard sealing material (no additional suffix needed)
Steel, zinc plated, Cr(VI)-free	CF	EGE16SREDCF	NBR
Stainless Steel	71	EGE16SRED71	VIT



Click here for CADs, Support Resources or to Configure Parts Online

# EGE-M-ED

Swivel Connector  
Flareless Swivel / Metric with  
EOlastic Seal

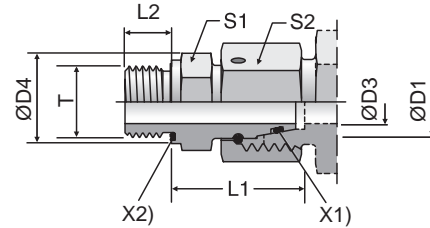

X2) Eolastic-sealing ED X1) O-ring OR

TABLE OF CONTENTS

VISUAL INDEX

FAQs

ASSEMBLY

TUBE FAB EQUIP

GEN TECH

Series	D1	T	D3	D4	L1	L2	S1	S2	Weight g/1 piece	Order code*	PN (bar) <sup>1)</sup>	
											CF	71
L <sup>3)</sup>	06	M 10×1.0	2.5	14	24.5	8	14	14	27	EGE06LMED	500	315
	08	M 12×1.5	4.0	17	26.5	12	17	17	45	EGE08LMED	500	315
	10	M 14×1.5	6.0	19	27.5	12	19	19	57	EGE10LMED	500	315
	12	M 16×1.5	8.0	22	30.5	12	22	22	82	EGE12LMED	400	315
	12	M 22×1.5	8.0	27	27.0	14	27	22	92	EGE12LM22X1.5ED	400	315
	15	M 18×1.5	10.0	24	31.5	12	24	27	113	EGE15LMED	400	315
	15	M 22×1.5	10.0	27	32.0	14	27	27	142	EGE15LM22X1.5ED	400	315
	18	M 22×1.5	13.0	27	31.5	14	27	32	148	EGE18LMED	400	315
	22	M 26×1.5	17.0	32	32.5	16	32	36	203	EGE22LMED	250	160
	28	M 33×2.0	22.0	40	35.0	18	41	41	289	EGE28LMED	250	160
S <sup>4)</sup>	35	M 42×2.0	28.0	50	42.5	20	50	50	511	EGE35LMED	250	160
	42	M 48×2.0	34.0	55	46.5	22	55	60	711	EGE42LMED	250	160
	06	M 12×1.5	2.5	17	27.0	12	17	17	47	EGE06SMED	800	630
	08	M 14×1.5	4.0	19	29.5	12	19	19	65	EGE08SMED	800	630
	10	M 16×1.5	6.0	22	32.0	12	22	22	91	EGE10SMED	800	630
	12	M 18×1.5	8.0	24	34.0	12	24	24	112	EGE12SMED	630	630
	16	M 22×1.5	11.0	27	37.0	14	27	30	174	EGE16SMED	630	400
	20	M 27×2.0	14.0	32	43.0	16	32	36	274	EGE20SMED	420	400
	25	M 33×2.0	18.0	40	48.0	18	41	46	497	EGE25SMED	420	400
	30	M 42×2.0	23.0	50	51.0	20	50	50	691	EGE30SMED	420	400
38	M 48×2.0	30.0	55	60.0	22	55	60	957	EGE38SMED	420	315	

<sup>1)</sup> Pressure shown = item deliverable

<sup>3)</sup> L = light series; <sup>4)</sup> S = heavy series

$$\frac{\text{PN (bar)}}{10} = \text{PN (MPa)}$$

**WARNING:** This product can expose you to chemicals including Lead and Lead Compounds which is known to the State of California to cause cancer and birth defects or other reproductive harm. For more information go to [www.p65warnings.ca.gov](http://www.p65warnings.ca.gov).

\*Please add the **suffixes** below according to the material/surface required.

Order code suffixes			
Material	Suffix surface and material	Example	Standard sealing material (no additional suffix needed)
Steel, zinc plated, Cr(VI)-free	CF	EGE16SMEDCF	NBR
Stainless Steel	71	EGE16SMED71	VIT

[Click here for CADs, Support Resources or to Configure Parts Online](#)

# SKA

Weld Nipple  
24° Flareless /  
ISO 8434-4 Butt Weld

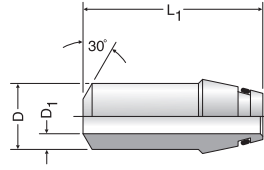

TUBE FITTING PART #	D (mm)	D1 (mm)	L1 (mm)	Pressure Rating (bar)	
				EO	
				CF	71
SKA10X1	10	8	32.5	249	240
SKA10X1.5	10	7	32.5	358	350
SKA10X2	10	6	32.5	460	445
SKA12X1.5	12	9	32.5	305	300
SKA12X2	12	8	32.5	393	380
SKA12X2.5	12	7	32.5	476	460
SKA16X1.5	16	13	39.0	234	225
SKA16X2	16	12	39.0	305	295
SKA16X2.5	16	11	39.0	372	360
SKA16X3	16	10	39.0	400	390
SKA20X2	20	16	45.0	249	240
SKA20X2.5	20	15	45.0	305	300
SKA20X3	20	14	45.0	358	350
SKA20X4	20	12	45.0	400	390
SKA25X3	25	19	49.5	294	285
SKA25X4	25	17	49.5	379	365
SKA25X5	25	15	49.5	400	390
SKA30X3	30	24	52.0	249	240
SKA30X4	30	22	52.0	323	314
SKA30X5	30	20	52.0	393	380
SKA30X6	30	18	52.0	400	390
SKA38X4	38	30	56.5	261	254
SKA38X5	38	28	56.5	315	315
SKA38X6	38	26	56.5	315	315
SKA38X7	38	24	56.5	315	315

**WARNING:** This product can expose you to chemicals including Cadmium which is known to the State of California to cause cancer and birth defects or other reproductive harm. For more information go to [www.p65warnings.ca.gov](http://www.p65warnings.ca.gov).

TABLE OF CONTENTS

VISUAL INDEX

D

FAQs

ASSEMBLY

TUBE FAB EQUIP

GEN TECH

[Click here for CADs, Support Resources or to Configure Parts Online](#)

# KOR

Tube End Reducer Steel  
Steel and Brass  
EO stand pipe adjustable / EO 24° cone end

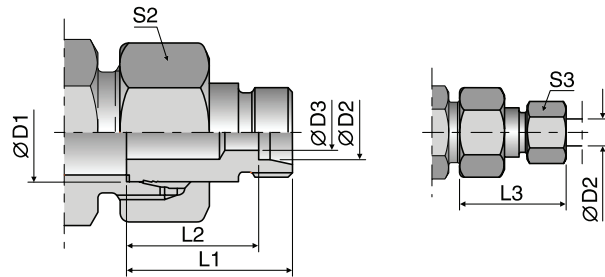

With pre-assembled nut and progressive ring for connection.  
Final assembly (in appropriate body) at least 1/4 turn beyond the point of clearly perceptible resistance.

Series 2) 3)	D1	D2	D3	L1	L2	L3	S2	S3	Weight g/1 piece	Order code*	PN (bar) <sup>1)</sup>	
											CF	MS
LL	06	04	3.0	28.5	24.5	34	12	10	16	KOR06/04LLOMD	100	
LL	08	04	3.0	28.5	24.5	34	14	10	16	KOR08/04LLOMD	100	
LL	08	06	4.5	23.0	17.5	29	14	12	14	KOR08/06LLOMD	100	
L/LL	06	04	3.0	28.5	24.5	34	14	10	16	KOR06L/04LLOMD	100	
L/LL	08	04	3.0	28.5	24.5	34	17	10	16	KOR08L/04LLOMD	100	
L	08	06	4.0	30.5	23.5	38	17	14	27	KOR08/06LOMD	315	200
L/LL	10	04	3.0	28.5	24.5	34	19	10	32	KOR10L/04LLOMD	100	
L	10	06	4.0	30.5	23.5	38	19	14	34	KOR10/06LOMD	315	200
L	10	08	6.0	30.5	23.5	38	19	17	35	KOR10/08LOMD	315	200
L/LL	12	04	3.0	28.5	24.5	34	22	10	41	KOR12L/04LLOMD	100	
L	12	06	4.0	30.5	23.5	38	22	14	45	KOR12/06LOMD	315	200
L	12	08	6.0	30.5	23.5	38	22	17	45	KOR12/08LOMD	315	200
L	12	10	8.0	31.5	24.5	39	22	19	46	KOR12/10LOMD	315	200
L	15	06	4.0	30.5	23.5	38	27	14	68	KOR15/06LOMD	315	200
L	15	08	6.0	30.5	23.5	38	27	17	69	KOR15/08LOMD	315	200
L	15	10	8.0	31.5	24.5	39	27	19	70	KOR15/10LOMD	315	200
L	15	12	10.0	31.5	24.5	39	27	22	70	KOR15/12LOMD	315	200
L	18	06	4.0	31.5	24.5	39	32	14	100	KOR18/06LOMD	315	200
L	18	08	6.0	31.5	24.5	39	32	17	102	KOR18/08LOMD	315	200
L	18	10	8.0	32.5	25.5	40	32	19	102	KOR18/10LOMD	315	200
L	18	12	10.0	32.5	25.5	40	32	22	101	KOR18/12LOMD	315	200
L	18	15	12.0	33.5	26.5	42	32	27	106	KOR18/15LOMD	315	200
L	22	06	4.0	32.5	25.5	40	36	14	137	KOR22/06LOMD	160	100
L	22	08	6.0	32.5	25.5	40	36	17	136	KOR22/08LOMD	160	100
L	22	10	8.0	33.5	26.5	41	36	19	138	KOR22/10LOMD	160	100
L	22	12	10.0	33.5	26.5	41	36	22	138	KOR22/12LOMD	160	100
L	22	15	12.0	34.5	27.5	43	36	27	143	KOR22/15LOMD	160	100
L	22	18	15.0	34.5	27.0	43	36	32	143	KOR22/18LOMD	160	100
L	28	06	4.0	33.5	26.5	41	41	14	177	KOR28/06LOMD	160	100
L	28	08	6.0	33.5	26.5	41	41	17	179	KOR28/08LOMD	160	100
L	28	10	8.0	34.5	27.5	42	41	19	180	KOR28/10LOMD	160	100
L	28	12	10.0	34.5	27.5	42	41	22	180	KOR28/12LOMD	160	100
L	28	15	12.0	35.5	28.5	44	41	27	185	KOR28/15LOMD	160	100
L	28	18	15.0	35.5	28.0	44	41	32	184	KOR28/18LOMD	160	100
L	28	22	19.0	37.5	30.0	46	41	36	188	KOR28/22LOMD	160	100
L	35	06	4.0	38.5	31.5	46	50	14	302	KOR35/06LOMD	160	
L	35	08	6.0	38.5	31.5	46	50	17	306	KOR35/08LOMD	160	
L	35	10	8.0	39.5	32.5	47	50	19	305	KOR35/10LOMD	160	100
L	35	12	10.0	39.5	32.5	47	50	22	304	KOR35/12LOMD	160	100
L	35	15	12.0	40.5	33.5	49	50	27	308	KOR35/15LOMD	160	100
L	35	18	15.0	40.5	33.0	49	50	32	316	KOR35/18LOMD	160	100
L	35	22	19.0	42.5	35.0	51	50	36	310	KOR35/22LOMD	160	100
L	35	28	24.0	42.5	35.0	52	50	41	305	KOR35/28LOMD	160	100

Note: Weld fitting. Omit "CF" in the part number for steel material. Part does not include the tube nut. Size 10 and 12 SKA will work for Series L & S

**WARNING:** This product can expose you to chemicals including Lead and Lead Compounds which is known to the State of California to cause cancer and birth defects or other reproductive harm. For more information go to [www.p65warnings.ca.gov](http://www.p65warnings.ca.gov).

TABLE OF CONTENTS

VISUAL INDEX

FAQs

ASSEMBLY

TUBE FAB EQUIP

GEN TECH

[Click here for CADs, Support Resources or to Configure Parts Online](#)

# KOR

Tube End Reducer Steel  
Steel and Brass  
EO stand pipe adjustable / EO 24° cone end

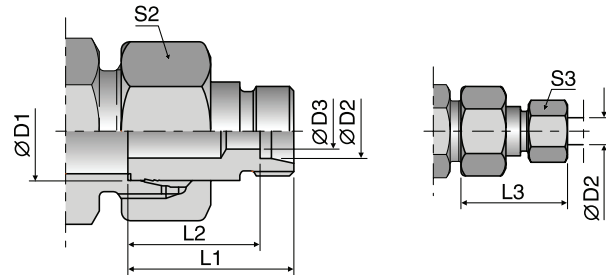

With pre-assembled nut and progressive ring for connection.  
Final assembly (in appropriate body) at least 1/4 turn beyond the point of clearly perceptible resistance.

Series 2) 3)	D1	D2	D3	L1	L2	L3	S2	S3	Weight g/1 piece	Order code*	PN (bar) <sup>1)</sup>	
											CF	MS
L	42	10	8.0	40.5	33.5	48	60	19	455	KOR42/10LOMD	160	
L	42	12	10.0	40.5	33.5	48	60	22	438	KOR42/12LOMD	160	
L	42	15	12.0	41.5	34.5	50	60	27	438	KOR42/15LOMD	160	100
L	42	18	15.0	41.5	34.0	50	60	32	449	KOR42/18LOMD	160	100
L	42	22	19.0	43.5	36.0	52	60	36	461	KOR42/22LOMD	160	100
L	42	28	24.0	43.5	36.0	53	60	41	443	KOR42/28LOMD	160	100
L	42	35	30.0	45.5	35.0	57	60	50	444	KOR42/35LOMD	160	100

<sup>1)</sup> Pressure shown = item deliverable

<sup>2)</sup> LL = very light series; <sup>3)</sup> L = light series

$$\frac{\text{PN (bar)}}{10} = \text{PN (MPa)}$$

The use of the swivel nut fitting RED is to be preferred (see page D41).

Part numbers shown are body only level. To order with a nut and progressive ring (sleeve) included, please see pages D12 and D13 for part number ordering instructions. Instructions for ordering the fitting as EO-2 is also included on these pages.

\*Please add the suffixes below according to the material/surface required.

Order code suffixes		
Material	Suffix surface and material	Example
Steel, zinc plated, Cr(VI)-free	CF	KOR18/15LOMDCF
Brass	MS	KOR18/15LOMDMS

**WARNING:** This product can expose you to chemicals including Lead and Lead Compounds which is known to the State of California to cause cancer and birth defects or other reproductive harm. For more information go to [www.p65warnings.ca.gov](http://www.p65warnings.ca.gov).

[Click here for CADs, Support Resources or to Configure Parts Online](#)

# KOR

Tube End Reducer Steel  
Steel and Brass  
EO stand pipe adjustable / EO 24° cone end

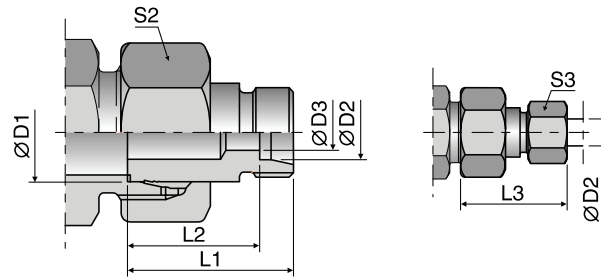

With pre-assembled nut and progressive ring for connection.  
Final assembly (in appropriate body) at least 1/4 turn beyond the point of clearly perceptible resistance.

Series	D1	D2	D3	L1	L2	L3	S2	S3	Weight g/1 piece	Order code*	PN (bar) <sup>1)</sup>	
											CF	MS
S <sup>4)</sup>	08	06	4	32	25.0	40	19	17	37	KOR08/06SOMD	630	400
	10	06	4	33	26.0	41	22	17	53	KOR10/06SOMD	630	400
	10	08	5	33	26.0	41	22	19	55	KOR10/08SOMD	630	400
	12	06	4	34	27.0	42	24	17	61	KOR12/06SOMD	630	400
	12	08	5	34	27.0	42	24	19	63	KOR12/08SOMD	630	400
	12	10	7	34	26.5	43	24	22	64	KOR12/10SOMD	630	400
	16	06	4	36	29.0	44	30	17	106	KOR16/06SOMD	400	250
	16	08	5	36	29.0	44	30	19	108	KOR16/08SOMD	400	250
	16	10	7	36	28.5	45	30	22	114	KOR16/10SOMD	400	250
	16	12	8	36	28.5	45	30	24	115	KOR16/12SOMD	400	250
	20	06	4	41	34.0	49	36	17	175	KOR20/06SOMD	400	250
	20	08	5	41	34.0	49	36	19	177	KOR20/08SOMD	400	250
	20	10	7	41	33.5	50	36	22	178	KOR20/10SOMD	400	250
	20	12	8	41	33.5	50	36	24	180	KOR20/12SOMD	400	250
	20	16	12	43	34.5	53	36	30	182	KOR20/16SOMD	400	250
	25	06	4	44	37.0	52	46	17	306	KOR25/06SOMD	400	250
25	08	5	44	37.0	52	46	19	311	KOR25/08SOMD	400	250	
25	10	7	44	36.5	53	46	22	313	KOR25/10SOMD	400	250	
25	12	8	44	36.5	53	46	24	317	KOR25/12SOMD	400	250	
25	16	12	45	36.5	55	46	30	315	KOR25/16SOMD	400	250	
25	20	16	48	37.5	59	46	36	328	KOR25/20SOMD	400	250	
30	06	4	46	39.0	54	50	17	373	KOR30/06SOMD	400	250	
30	08	5	46	39.0	54	50	19	376	KOR30/08SOMD	400	250	
30	10	7	46	38.5	55	50	22	376	KOR30/10SOMD	400	250	
30	12	8	46	38.5	55	50	24	377	KOR30/12SOMD	400	250	
30	16	12	48	39.5	58	50	30	381	KOR30/16SOMD	400	250	
30	20	16	50	39.5	61	50	36	386	KOR30/20SOMD	400	250	
30	25	20	52	40.0	64	50	46	406	KOR30/25SOMD	400	250	
38	06	4	50	43.0	58	60	17	571	KOR38/06SOMD	315	200	
38	08	5	50	43.0	58	60	19	567	KOR38/08SOMD	315	200	
38	10	7	50	42.5	59	60	22	571	KOR38/10SOMD	315	200	
38	12	8	50	42.5	59	60	24	571	KOR38/12SOMD	315	200	
38	16	12	52	43.5	62	60	30	580	KOR38/16SOMD	315	200	
38	20	16	54	43.5	65	60	36	593	KOR38/20SOMD	315	200	
38	25	20	56	44.0	68	60	46	605	KOR38/25SOMD	315	200	
38	30	25	58	44.5	71	60	50	614	KOR38/30SOMD	315	200	

<sup>1)</sup> Pressure shown = item deliverable

<sup>4)</sup> S = heavy series

$$\frac{\text{PN (bar)}}{10} = \text{PN (MPa)}$$

The use of the swivel nut fitting RED is to be preferred (see page D41).

Part numbers shown are body only level. To order with a nut and progressive ring (sleeve) included, please see pages D12 and D13 for part number ordering instructions. Instructions for ordering the fitting as EO-2 is also included on these pages.

\*Please add the suffixes below according to the material/surface required.

**WARNING:** This product can expose you to chemicals including Lead and Lead Compounds which is known to the State of California to cause cancer and birth defects or other reproductive harm. For more information go to [www.p65warnings.ca.gov](http://www.p65warnings.ca.gov).

Order code suffixes		
Material	Suffix surface and material	Example
Steel, zinc plated, Cr(VI)-free	CF	KOR16/10SOMDCF
Brass	MS	KOR16/10SOMDMS

TABLE OF CONTENTS

VISUAL INDEX

FAQs

ASSEMBLY

TUBE FAB EQUIP

GEN TECH



[Click here for CADs, Support Resources or to Configure Parts Online](#)

# KOR

Tube End Reducer Steel  
Stainless Steel  
EO stand pipe adjustable / EO 24° cone end

With pre-assembled nut and progressive ring for connection.  
Final assembly (in appropriate body) at least 1/4 turn beyond the point of clearly perceptible resistance.

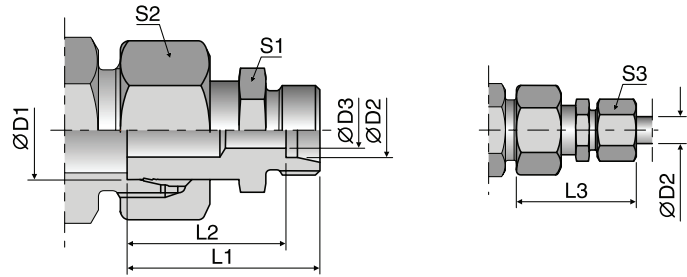

Series	D1	D2	D3	L1	L2	L3	S1	S2	S3	Weight g/1 piece	Order code*	PN (bar) <sup>1)</sup> 71
L <sup>3)</sup>	08	06	4	33.5	26.5	41	12	17	14	32	KOR08/06LOMD71	315
	10	06	4	34.5	27.5	42	12	19	14	39	KOR10/06LOMD71	315
	10	08	6	35.5	28.5	43	14	19	17	40	KOR10/08LOMD71	315
	12	06	4	36.5	29.5	44	14	22	14	49	KOR12/06LOMD71	315
	12	08	6	36.5	29.5	44	14	22	17	53	KOR12/08LOMD71	315
	12	10	8	37.5	30.5	45	17	22	19	55	KOR12/10LOMD71	315
	15	06	4	37.0	30.0	45	17	27	14	79	KOR15/06LOMD71	315
	15	08	6	37.0	30.0	45	17	27	17	78	KOR15/08LOMD71	315
	15	10	8	38.0	31.0	46	17	27	19	85	KOR15/10LOMD71	315
	15	12	10	39.0	32.0	47	19	27	22	84	KOR15/12LOMD71	315
	18	06	4	37.5	30.5	45	19	32	14	112	KOR18/06LOMD71	315
	18	08	6	37.5	30.5	45	19	32	17	113	KOR18/08LOMD71	315
	18	10	8	38.5	31.5	46	19	32	19	113	KOR18/10LOMD71	315
	18	12	10	38.5	31.5	46	19	32	22	122	KOR18/12LOMD71	315
	18	15	12	39.5	32.5	48	24	32	27	131	KOR18/15LOMD71	315
	22	06	4	38.5	31.5	46	24	36	14	154	KOR22/06LOMD71	160
	22	08	6	38.5	31.5	46	24	36	17	155	KOR22/08LOMD71	160
	22	10	8	39.5	32.5	47	24	36	19	156	KOR22/10LOMD71	160
	22	12	10	39.5	32.5	47	24	36	22	157	KOR22/12LOMD71	160
	22	15	12	40.5	33.5	49	24	36	27	160	KOR22/15LOMD71	160
	22	18	15	41.5	34.0	50	27	36	32	173	KOR22/18LOMD71	160
	28	06	4	41.0	34.0	49	30	41	14	220	KOR28/06LOMD71	160
	28	08	6	41.0	34.0	49	30	41	17	217	KOR28/08LOMD71	160
	28	10	8	42.0	35.0	50	30	41	19	211	KOR28/10LOMD71	160
28	12	10	42.0	35.0	50	30	41	22	219	KOR28/12LOMD71	160	
28	15	12	43.0	36.0	51	30	41	27	188	KOR28/15LOMD71	160	
28	18	15	43.0	35.5	52	30	41	32	218	KOR28/18LOMD71	160	
28	22	19	45.0	37.5	54	32	41	36	228	KOR28/22LOMD71	160	
35	06	4	48.5	41.5	56	36	50	14	307	KOR35/06LOMD71	160	
35	08	6	48.5	41.5	56	36	50	17	313	KOR35/08LOMD71	160	
35	10	8	49.5	42.5	57	36	50	19	370	KOR35/10LOMD71	160	
35	12	10	49.5	42.5	57	36	50	22	371	KOR35/12LOMD71	160	
35	15	12	50.5	43.5	59	36	50	27	380	KOR35/15LOMD71	160	
35	18	15	50.5	43.0	59	36	50	32	382	KOR35/18LOMD71	160	
35	22	19	52.5	45.0	61	36	50	36	380	KOR35/22LOMD71	160	
35	28	24	52.5	45.0	62	41	50	41	400	KOR35/28LOMD71	160	
42	10	8	52.5	45.5	60	46	60	19	551	KOR42/10LOMD71	160	
42	12	10	52.5	45.5	60	46	60	22	551	KOR42/12LOMD71	160	
42	15	12	53.5	46.5	62	46	60	27	687	KOR42/15LOMD71	160	
42	18	15	53.5	46.0	62	46	60	32	555	KOR42/18LOMD71	160	
42	22	19	55.5	48.0	64	46	60	36	568	KOR42/22LOMD71	160	
42	28	24	55.5	48.0	65	46	60	41	559	KOR42/28LOMD71	160	
42	35	30	57.5	47.0	69	46	60	50	588	KOR42/35LOMD71	160	

<sup>1)</sup> Pressure shown = item deliverable

<sup>3)</sup> L = light series

$$\frac{\text{PN (bar)}}{10} = \text{PN (MPa)}$$

The use of the swivel nut fitting RED is to be preferred (see page D41).

Part numbers shown are body only level. To order with a nut and progressive ring (sleeve) included, please see pages D12 and D13 for part number ordering instructions. Instructions for ordering the fitting as EO-2 is also included on these pages.

**WARNING:** This product can expose you to chemicals including Lead and Lead Compounds which is known to the State of California to cause cancer and birth defects or other reproductive harm. For more information go to [www.p65warnings.ca.gov](http://www.p65warnings.ca.gov).

TABLE OF CONTENTS

VISUAL INDEX

D

FAQs

ASSEMBLY

TUBE FAB EQUIP

GEN TECH

[Click here for CADs, Support Resources or to Configure Parts Online](#)

# KOR

Tube End Reducer Steel  
Stainless Steel  
EO stand pipe adjustable / EO 24° cone end

With pre-assembled nut and progressive ring for connection.  
Final assembly (in appropriate body) at least 1/4 turn beyond the point of clearly perceptible resistance.

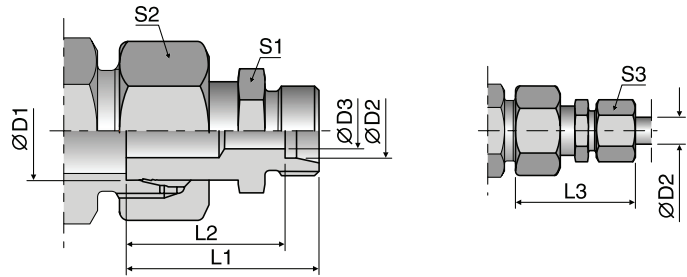

Series	D1	D2	D3	L1	L2	L3	S1	S2	S3	Weight g/1 piece	Order code*	PN (bar) <sup>1)</sup>
												71
S <sup>4)</sup>	08	06	4	36.5	29.5	44	14	19	17	16	KOR08/06SOMD71	630
	10	06	4	38.5	31.5	46	14	22	17	16	KOR10/06SOMD71	630
	10	08	5	38.5	31.5	46	17	22	19	14	KOR10/08SOMD71	630
	12	06	4	38.5	31.5	46	14	24	17	16	KOR12/06SOMD71	630
	12	08	5	38.5	31.5	46	17	24	19	16	KOR12/08SOMD71	630
	12	10	7	39.5	32.0	48	19	24	22	27	KOR12/10SOMD71	630
	16	06	4	41.0	34.0	49	17	30	17	44	KOR16/06SOMD71	400
	16	08	5	41.0	34.0	49	17	30	19	45	KOR16/08SOMD71	400
	16	10	7	42.0	34.5	51	19	30	22	46	KOR16/10SOMD71	400
	16	12	8	42.0	34.5	51	22	30	24	68	KOR16/12SOMD71	400
	20	06	4	46.0	39.0	54	22	36	17	70	KOR20/06SOMD71	400
	20	08	5	46.0	39.0	54	22	36	19	70	KOR20/08SOMD71	400
	20	10	7	46.0	38.5	55	22	36	22	100	KOR20/10SOMD71	400
	20	12	8	46.0	38.5	55	22	36	24	101	KOR20/12SOMD71	400
	20	16	12	49.0	40.5	59	27	36	30	101	KOR20/16SOMD71	400
	25	06	4	50.5	43.5	58	27	46	17	106	KOR25/06SOMD71	400
	25	08	5	50.5	43.5	58	27	46	19	136	KOR25/08SOMD71	400
	25	10	7	50.5	43.0	59	27	46	22	136	KOR25/10SOMD71	400
25	12	8	50.5	43.0	59	27	46	24	138	KOR25/12SOMD71	400	
25	16	12	52.5	44.0	62	27	46	30	143	KOR25/16SOMD71	400	
25	20	16	54.5	44.0	66	32	46	36	143	KOR25/20SOMD71	400	
30	06	4	53.0	46.0	61	32	50	17	177	KOR30/06SOMD71	400	
30	08	5	53.0	46.0	61	32	50	19	179	KOR30/08SOMD71	400	
30	10	7	53.0	45.5	62	32	50	22	180	KOR30/10SOMD71	400	
30	12	8	53.0	45.5	62	32	50	24	180	KOR30/12SOMD71	400	
30	16	12	55.0	46.5	65	32	50	30	184	KOR30/16SOMD71	400	
30	20	16	57.0	46.5	68	32	50	36	188	KOR30/20SOMD71	400	
30	25	20	60.0	48.0	72	41	50	46	302	KOR30/25SOMD71	400	
38	06	4	60.0	53.0	68	41	60	17	306	KOR38/06SOMD71	315	
38	08	5	60.0	53.0	68	41	60	19	305	KOR38/08SOMD71	315	
38	10	7	60.0	52.5	69	41	60	22	304	KOR38/10SOMD71	315	
38	12	8	60.0	52.5	69	41	60	24	308	KOR38/12SOMD71	315	
38	16	12	62.0	53.5	72	41	60	30	310	KOR38/16SOMD71	315	
38	20	16	64.0	53.5	75	41	60	36	305	KOR38/20SOMD71	315	
38	25	20	66.0	54.0	78	41	60	46	455	KOR38/25SOMD71	315	
38	30	25	69.0	55.5	82	46	60	50	438	KOR38/30SOMD71	315	

<sup>1)</sup> Pressure shown = item deliverable

<sup>4)</sup> S = heavy series

$$\frac{PN \text{ (bar)}}{10} = PN \text{ (MPa)}$$

The use of the swivel nut fitting RED is to be preferred (see page D41).

Part numbers shown are body only level. To order with a nut and progressive ring (sleeve) included, please see pages D12 and D13 for part number ordering instructions. Instructions for ordering the fitting as EO-2 is also included on these pages.

**WARNING:** This product can expose you to chemicals including Lead and Lead Compounds which is known to the State of California to cause cancer and birth defects or other reproductive harm. For more information go to [www.p65warnings.ca.gov](http://www.p65warnings.ca.gov).

[Click here for CADs, Support Resources or to Configure Parts Online](#)

# W

Elbow Union  
24° Flareless / 24° Flareless

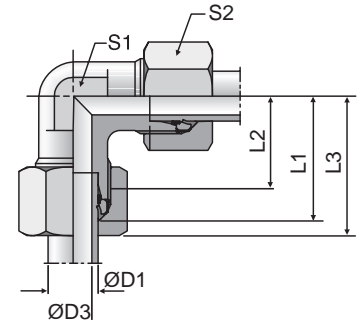

TABLE OF CONTENTS

VISUAL INDEX

D

FAQs

ASSEMBLY

TUBE FAB EQUIP

GEN TECH

Series	D1	D3	L1	L2	L3	S1	S2	Weight g/1 piece	Order code*	PN (bar) <sup>1)</sup>		
										CF	71	MS
LL <sup>2)</sup>	04	3.0	15	11.0	21	9	10	13	W04LL	100	100	63
	06	4.5	15	9.5	21	9	12	15	W06LL	100	100	63
	08	6.0	17	11.5	23	12	14	23	W08LL	100	100	63
	10	8.0	18	12.5	24	12	17	32	W10LL	100	100	63
	12	10.0	19	13.0	25	14	19	41	W12LL	100	100	63
L <sup>3)</sup>	06	4.0	19	12.0	27	12	14	29	W06L	500	315	200
	08	6.0	21	14.0	29	12	17	43	W08L	500	315	200
	10	8.0	22	15.0	30	14	19	54	W10L	500	315	200
	12	10.0	24	17.0	32	19	22	80	W12L	400	315	200
	15	12.0	28	21.0	36	19	27	81	W15L	400	315	200
	18	15.0	31	23.5	40	24	32	140	W18L	400	315	200
	22	19.0	35	27.5	44	27	36	178	W22L	250	160	100
	28	24.0	38	30.5	47	36	41	340	W28L	250	160	100
	35	30.0	45	34.5	56	41	50	458	W35L	250	160	100
	42	36.0	51	40.0	63	50	60	776	W42L	250	160	100
S <sup>4)</sup>	06	4.0	23	16.0	31	12	17	52	W06S	800	630	400
	08	5.0	24	17.0	32	14	19	74	W08S	800	630	400
	10	7.0	25	17.5	34	19	22	97	W10S	800	630	400
	12	8.0	29	21.5	38	19*	24	137	W12S	630	630	400
	16	12.0	33	24.5	43	24	30	162	W16S	630	400	250
	20	16.0	37	26.5	48	27	36	221	W20S	420	400	250
	25	20.0	42	30.0	54	36	46	424	W25S	420	400	250
	30	25.0	49	35.5	62	41	50	603	W30S	420	400	250
38	32.0	57	41.0	72	50	60	1010	W38S	420	315	200	

<sup>1)</sup> Pressure shown = item deliverable

<sup>2)</sup> LL = very light series; <sup>3)</sup> L = light series; <sup>4)</sup> S = heavy series

\*S1 = 17 in 1.4571

$$\frac{\text{PN (bar)}}{10} = \text{PN (MPa)}$$

Part numbers shown are body only level. To order with a nut and progressive ring (sleeve) included, please see pages D12 and D13 for part number ordering instructions. Instructions for ordering the fitting as EO-2 is also included on these pages.

Order code suffixes		
Material	Suffix surface and material	Example
Steel, zinc plated, Cr(VI)-free	CFX	W16SCFX
Stainless Steel	71X	W16S71X
Brass	MSX	W16SMSX

**WARNING:** This product can expose you to chemicals including Lead and Lead Compounds which is known to the State of California to cause cancer and birth defects or other reproductive harm. For more information go to [www.p65warnings.ca.gov](http://www.p65warnings.ca.gov).

[Click here for CADs, Support Resources or to Configure Parts Online](#)

# WSV

Bulkhead Union Elbow  
24° Flareless / 24° Flareless

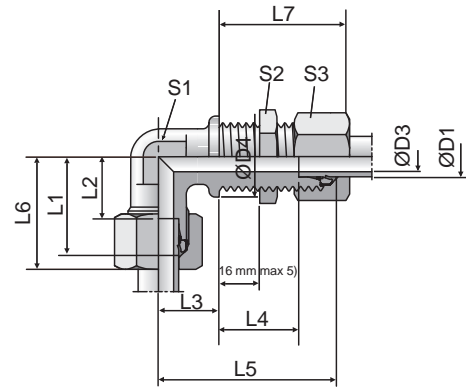

TABLE OF CONTENTS

VISUAL INDEX

FAQs

ASSEMBLY

TUBE FAB EQUIP

GEN TECH

Series	D1	D3	D4	L1	L2	L3	L4	L5	L6	L7	S1	S2	S3	Weight g/1 piece	Order code*	PN (bar) <sup>1)</sup>		
																CF	71	MS
L <sup>3)</sup>	06	4	17	19	12.0	14	27.0	48	27	42	12	17	14	51	WSV06LOMD	315	315	200
	08	6	19	21	14.0	17	27.0	51	29	42	12	19	17	61	WSV08LOMD	315	315	200
	10	8	22	22	15.0	18	28.0	53	30	43	14	22	19	78	WSV10LOMD	315	315	200
	12	10	24	24	17.0	20	29.0	56	32	44	17	24	22	85	WSV12LOMD	315	315	200
	15	12	27	28	21.0	23	31.0	61	36	46	19	30	27	150	WSV15LOMD	315	315	200
	18	15	32	31	23.5	24	32.5	64	40	49	24	36	32	238	WSV18LOMD	315	315	200
	22	19	36	35	27.5	30	34.5	72	44	51	27	41	36	327	WSV22LOMD	160	160	
	28	24	42	38	30.5	34	35.5	77	47	52	36	46	41	482	WSV28LOMD	160	160	
	35	30	50	45	34.5	39	36.5	86	56	58	41	55	50	729	WSV35LOMD	160	160	
	42	36	60	51	40.0	43	36.0	90	63	59	50	65	60	1091	WSV42LOMD	160	160	
S <sup>4)</sup>	06	4	19	23	16.0	17	29.0	53	31	44	12	19	17	72	WSV06SOMD	630	630	
	08	5	22	24	17.0	18	29.0	54	32	44	14	22	19	99	WSV08SOMD	630	630	
	10	7	24	25	17.5	20	29.5	57	34	46	17	24	22	128	WSV10SOMD	630	630	
	12	8	27	29	21.5	21	30.5	59	38	47	17	27	24	168	WSV12SOMD	630	630	
	16	12	30	33	24.5	24	31.5	64	43	50	24	32	30	249	WSV16SOMD	400	400	
	20	16	36	37	26.5	30	33.5	74	48	55	27	41	36	390	WSV20SOMD	400	400	
	25	20	42	42	30.0	34	35.0	81	54	59	36	46	46	618	WSV25SOMD	400	400	
	30	25	50	49	35.5	39	37.5	90	62	64	41	50	50	889	WSV30SOMD	400	400	
	38	32	60	57	41.0	43	37.0	96	72	68	50	65	60	1337	WSV38SOMD	315	315	

<sup>1)</sup> Pressure shown = item deliverable

<sup>3)</sup> L = light series; <sup>4)</sup> S = heavy series

<sup>5)</sup> Bulkhead thickness min.

06-18 L and 06-16 S = 3 mm

22-42 L and 20-38 S = 4 mm

$$\frac{\text{PN (bar)}}{10} = \text{PN (MPa)}$$

Part numbers shown are body only level. To order with a nut and progressive ring (sleeve) included, please see pages D12 and D13 for part number ordering instructions. Instructions for ordering the fitting as EO-2 is also included on these pages.

\*Please add the **suffixes** below according to the material/surface required.

Order code suffixes		
Material	Suffix surface and material	Example
Steel, zinc plated, Cr(VI)-free	CF	WSV16SOMDCF
Stainless Steel	71	WSV16SOMD71
Brass	MS	WSV18LOMDMS

[Click here for CADs, Support Resources or to Configure Parts Online](#)

# WE-NPT

Male Elbow  
24° Flareless / NPT

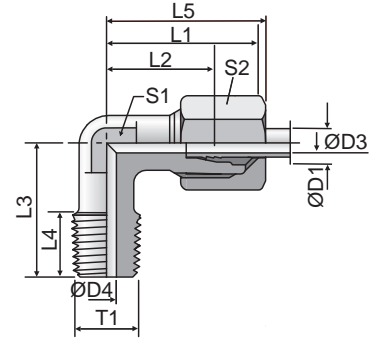

TABLE OF CONTENTS

VISUAL INDEX

D

FAQs

ASSEMBLY

TUBE FAB EQUIP

GEN TECH

Series	D1	T1	D3	D4	L1	L2	L3	L4	L5	S1	S2	Weight g/1 piece	Order code*	PN (bar) <sup>1)</sup>			
														CF	71	MS	
LL <sup>2)</sup>	04	1/8-27 NPT	3.0	4.0	15	11.0	17	10.0	21	9	10	18	WE04LL1/8NPT	100			
	06	1/8-27 NPT	4.5	4.5	15	9.5	17	10.0	21	9	12	17	WE06LL1/8NPT	100			
	08	1/8-27 NPT	6.0	5.0	17	11.5	20	10.0	23	12	14	25	WE08LL1/8NPT	100			
L <sup>3)</sup>	06	1/8-27 NPT	4.0	4.0	19	12.0	20	10.0	27	12	14	29	WE06L1/8NPT	315	315	200	
	06	1/4-18 NPT	4.0	7.0	21	14.0	26	14.5	29	12	14	44	WE06L1/4NPT	315	315	200	
	06	3/8-18 NPT	4.0	8.0	25	18.0	28	14.5	33	17	14	55	WE06L3/8NPT	315	315	200	
	08	1/8-27 NPT	6.0	4.0	21	14.0	26	10.0	29	12	17	48	WE08L1/8NPT	315	315	200	
	08	1/4-18 NPT	6.0	6.0	21	14.0	26	14.5	29	12	17	47	WE08L1/4NPT	315	315	200	
	10	1/4-18 NPT	8.0	7.0	22	15.0	27	14.5	30	14	19	61	WE10L1/4NPT	315	315	200	
	10	3/8-18 NPT	8.0	8.0	24	17.0	28	14.5	32	17	19	92	WE10L3/8NPT	315	315	200	
	12	1/4-18 NPT	10.0	7.0	24	17.0	28	14.5	32	17	22	82	WE12L1/4NPT	315	315	200	
	12	3/8-18 NPT	10.0	8.0	24	17.0	28	14.5	32	17	22	92	WE12L3/8NPT	315	315	200	
	12	1/2-14 NPT	10.0	11.0	28	21.0	34	19.5	36	19	22	90	WE12L1/2NPT	315	315	200	
	15	1/2-14 NPT	12.0	11.0	28	21.0	34	19.5	36	19	27	89	WE15L1/2NPT	315	315	200	
	18	1/2-14 NPT	15.0	12.0	31	23.5	36	19.5	40	24	32	150	WE18L1/2NPT	315	315	200	
	22	3/4-14 NPT	19.0	16.0	35	27.5	42	19.5	44	27	36	176	WE22L3/4NPT	160	160	100	
	28	1-11.5 NPT	24.0	21.0	38	30.5	48	24.5	47	36	41	314	WE28L1NPT	160	160	100	
	35	1 1/4-11.5 NPT	30.0	28.0	45	34.5	54	25.0	56	41	50	465	WE35L11/4NPT	160	160	100	
	42	1 1/2-11.5 NPT	36.0	34.0	51	40.0	61	26.0	63	50	60	849	WE42L11/2NPT	160	160	100	
	S <sup>4)</sup>	06	1/4-18 NPT	4.0	4.0	23	16.0	26	14.5	31	12	17	56	WE06S1/4NPT	630	630	400
		08	1/4-18 NPT	5.0	5.0	24	17.0	27	14.5	32	14	19	73	WE08S1/4NPT	630	630	400
08		3/8-18 NPT	5.0	8.0	25	18.0	28	14.5	33	17	19	77	WE08S3/8NPT	630	630	400	
08		1/2-14 NPT	5.0	10.0	30	23.0	34	19.5	38	19	19	75	WE08S1/2NPT	630	630	400	
10		1/4-18 NPT	7.0	5.0	25	17.5	28	14.5	34	17	22	96	WE10S1/4NPT	630	630	400	
10		3/8-18 NPT	7.0	7.0	25	17.5	28	14.5	34	17	22	98	WE10S3/8NPT	630	630	400	
12		1/4-18 NPT	8.0	5.0	29	21.5	29	14.5	38	17	24	73	WE12S1/4NPT	630	630	400	
12		3/8-18 NPT	8.0	8.0	29	22.5	28	14.5	38	17	24	123	WE12S3/8NPT	630	630	400	
12		1/2-14 NPT	8.0	10.0	30	22.5	34	19.5	39	19	24	107	WE12S1/2NPT	630	630	400	
16		1/2-14 NPT	12.0	12.0	33	24.5	36	19.5	43	24	30	157	WE16S1/2NPT	400	400	250	
20		3/4-14 NPT	16.0	16.0	37	26.5	42	19.5	48	27	36	205	WE20S3/4NPT	400	400	250	
25		1-11.5 NPT	20.0	20.0	42	30.0	48	24.5	54	36	46	381	WE25S1NPT	400	400	250	
30		1 1/4-11.5 NPT	25.0	25.0	49	35.5	54	25.0	62	41	50	598	WE30S11/4NPT	400	400	250	
38		1 1/2-11.5 NPT	32.0	32.0	57	41.0	61	26.0	72	50	60	1029	WE38S11/2NPT	315	315	200	

<sup>1)</sup> Pressure shown = item deliverable  
<sup>2)</sup> LL = very light series; <sup>3)</sup> L = light series; <sup>4)</sup> S = heavy series

<sup>\*)</sup>Please add the suffixes below according to the material/surface required.

$$\frac{\text{PN (bar)}}{10} = \text{PN (MPa)}$$

Part numbers shown are body only level. To order with a nut and progressive ring (sleeve) included, please see pages D12 and D13 for part number ordering instructions. Instructions for ordering the fitting as EO-2 is also included on these pages.

Order code suffixes		
Material	Suffix surface and material	Example
Steel, zinc plated, Cr(VI)-free	CFX	WE16S1/2NPTCFX
Stainless Steel	71X	WE16S1/2NPT71X
Brass	MSX	WE16S1/2NPTMSX



[Click here for CADs, Support Resources or to Configure Parts Online](#)

# WE-R keg

Male Elbow  
24° Flareless / BSPT

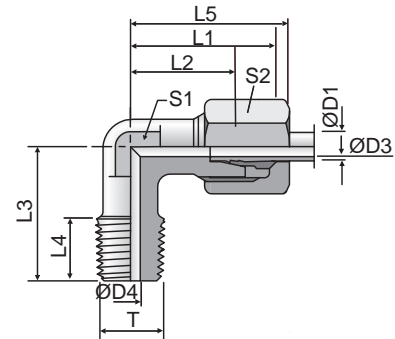

TABLE OF CONTENTS

VISUAL INDEX

FAQs

ASSEMBLY

TUBE FAB EQUIP

GEN TECH

Series	D1	T	D3	D4	L1	L2	L3	L4	L5	S1	S2	Weight g/1 piece	Order code*	PN (bar) <sup>1)</sup>			
														CF	71	MS	
LL <sup>2)</sup>	04	R 1/8 tap.	3.0	4.0	15	11.0	17	8	21	9	10	17	WE04LLR	100	100	63	
	06	R 1/8 tap.	4.5	4.5	15	9.5	17	8	21	9	12	17	WE06LLR	100	100	63	
	08	R 1/8 tap.	6.0	6.0	17	11.5	20	8	23	12	14	24	WE08LLR	100	100	63	
	10	R 1/4 tap.	8.0	7.0	18	12.5	23	12	24	12	17	36	WE10LLR	100			
	12	R 1/4 tap.	10.0	7.0	19	13.0	23	12	25	14	19	46	WE12LLR	100			
L <sup>3)</sup>	06	R 1/8 tap.	4.0	4.0	19	12.0	20	8	27	12	14	30	WE06LR	315	315	200	
	06	R 1/4 tap.	4.0	6.0	21	14.0	26	12	29	12	14	47	WE06LR1/4	315	315		
	08	R 1/4 tap.	6.0	6.0	21	14.0	26	12	29	12	17	46	WE08LR	315	315	200	
	08	R 1/8 tap.	6.0	4.0	21	14.0	26	8	29	12	17	49	WE08LR1/8	315	315		
	08	R 3/8 tap.	6.0	9.0	24	17.0	28	12	32	17	17	94	WE08LR3/8	315	315		
	10	R 1/4 tap.	8.0	7.0	22	15.0	27	12	30	14	19	61	WE10LR	315	315	200	
	10	R 3/8 tap.	8.0	9.0	24	17.0	28	12	32	17	19	87	WE10LR3/8	315	315		
	12	R 3/8 tap.	10.0	9.0	24	17.0	28	12	32	17	22	88	WE12LR	315	315	200	
	12	R 1/4 tap.	10.0	7.0	24	17.0	27	12	32	17	22	80	WE12LR1/4	315	315		
	12	R 1/2 tap.	10.0	11.0	28	21.0	34	14	36	19	22	89	WE12LR1/2	315	315		
	15	R 1/2 tap.	12.0	11.0	28	21.0	34	14	36	19	27	94	WE15LR	315	315	200	
	18	R 1/2 tap.	15.0	14.0	31	23.5	36	14	40	24	32	141	WE18LR	315	315	200	
	S <sup>4)</sup>	06	R 1/4 tap.	4.0	4.0	23	16.0	26	12	31	12	17	56	WE06SR	400	400	250
		06	R 3/8 tap.	4.0	7.0	25	18.0	28	12	33	17	17	61	WE06SR3/8	400	400	
08		R 1/4 tap.	5.0	5.0	24	17.0	27	12	32	14	19	73	WE08SR	400	400	250	
08		R 3/8 tap.	5.0	7.0	25	18.0	28	12	33	17	19	63	WE08SR3/8	400	400		
10		R 3/8 tap.	7.0	7.0	25	17.5	28	12	34	17	22	104	WE10SR	400	400	250	
10		R 1/4 tap.	7.0	5.0	25	17.5	28	12	34	17	22	59	WE10SR1/4	400	400		
10		R 1/2 tap.	7.0	10.0	30	22.5	32	14	39	19	22	98	WE10SR1/2	400	400		
12		R 3/8 tap.	8.0	8.0	29	21.5	28	12	38	17	24	126	WE12SR	400	400	250	
12		R 1/2 tap.	8.0	11.0	30	22.5	32	14	39	19	24	97	WE12SR1/2	400	400		
16		R 1/2 tap.	12.0	12.0	33	24.5	32	14	43	24	30	150	WE16SR	400	400	250	

<sup>1)</sup> Pressure shown = item deliverable

<sup>2)</sup> LL = very light series; <sup>3)</sup> L = light series; <sup>4)</sup> S = heavy series

$$\frac{PN(\text{bar})}{10} = PN(\text{MPa})$$

Part numbers shown are body only level. To order with a nut and progressive ring (sleeve) included, please see pages D12 and D13 for part number ordering instructions. Instructions for ordering the fitting as EO-2 is also included on these pages.

Order code suffixes		
Material	Suffix surface and material	Example
Steel, zinc plated, Cr(VI)-free	CFX	WE16SRCFX
Stainless Steel	71X	WE16SR71X
Brass	MSX	WE16SRMSX

\*Please add the suffixes below according to the material/surface required.

**WARNING:** This product can expose you to chemicals including Lead and Lead Compounds which is known to the State of California to cause cancer and birth defects or other reproductive harm. For more information go to [www.p65warnings.ca.gov](http://www.p65warnings.ca.gov).

[Click here for CADs, Support Resources or to Configure Parts Online](#)

# WE-M keg

Male Elbow

24° Flareless / Metric Taper Thread

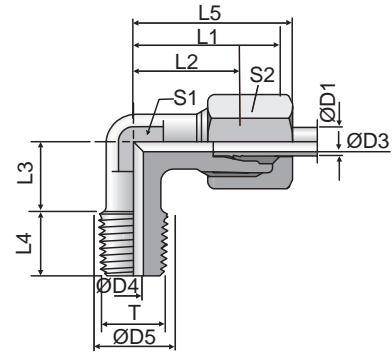

TABLE OF CONTENTS

VISUAL INDEX

D

FAQs

ASSEMBLY

TUBE FAB EQUIP

GEN TECH

Series	D1	T	D3	D4	D5	L1	L2	L3	L4	L5	S1	S2	Weight g/1 piece	Order code*	PN (bar) <sup>1)</sup>	
															CF	71
L <sup>3)</sup>	22	M 26×1.5	19	18	31	35	27.5	26	16	44	27	36	173	WE22LM	160	160
	28	M 33×2.0	24	23	39	38	30.5	30	18	47	36	41	303	WE28LM	160	160
	35	M 42×2.0	30	30	49	45	34.5	34	20	56	41	50	469	WE35LM	160	160
	42	M 48×2.0	36	36	55	51	40.0	39	22	63	50	60	661	WE42LM	160	160
S <sup>4)</sup>	20	M 27×2.0	16	16	32	37	26.5	26	16	48	27	36	208	WE20SM	400	400
	25	M 33×2.0	20	20	39	42	30.0	30	18	54	36	46	396	WE25SM	250	250
	30	M 42×2.0	25	25	49	49	35.5	34	20	62	41	50	632	WE30SM	160	160
	38	M 48×2.0	32	32	55	57	41.0	39	22	72	50	60	907	WE38SM	160	160

<sup>1)</sup> Pressure shown = item deliverable

<sup>3)</sup> L = light series; <sup>4)</sup> S = heavy series

$$\frac{\text{PN (bar)}}{10} = \text{PN (MPa)}$$

Part numbers shown are body only level. To order with a nut and progressive ring (sleeve) included, please see pages D12 and D13 for part number ordering instructions. Instructions for ordering the fitting as EO-2 is also included on these pages.

\*Please add the **suffixes** below according to the material/surface required.

Order code suffixes		
Material	Suffix surface and material	Example
Steel, zinc plated, Cr(VI)-free	CFX	WE20SMCFX
Stainless Steel	71X	WE20SM71X

[Click here for CADs, Support Resources or to Configure Parts Online](#)

# EW

Swivel Nut Elbow  
24° Flareless / Flareless Swivel

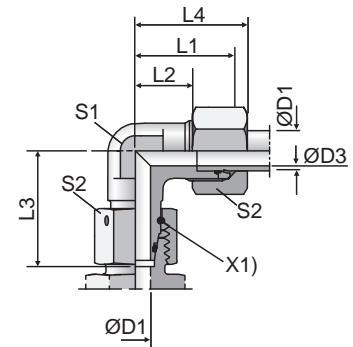

X1) O-ring OR

TABLE OF CONTENTS

VISUAL INDEX

FAQs

ASSEMBLY

TUBE FAB EQUIP

GEN TECH

Series	D1	D3	L1	L2	L3	L4	S1	S2	Weight g/1 piece	Order code*	PN (bar) <sup>1)</sup>	
											CF	71
L <sup>3)</sup>	06	4	19	12.0	26.0	27	12	14	34	EW06LOMD	500	315
	08	6	21	14.0	27.5	29	12	17	43	EW08LOMD	500	315
	10	8	22	15.0	29.0	30	14	19	58	EW10LOMD	500	315
	12	10	24	17.0	29.5	32	17	22	81	EW12LOMD	400	315
	15	12	28	21.0	32.5	36	19	27	128	EW15LOMD	400	315
	18	15	31	23.5	35.5	40	24	32	197	EW18LOMD	400	315
	22	19	35	27.5	38.5	44	27	36	258	EW22LOMD	250	160
	28	24	38	30.5	41.5	47	36	41	370	EW28LOMD	250	160
	35	30	45	34.5	51.0	56	41	50	593	EW35LOMD	250	160
	42	36	51	40.0	56.0	63	50	60	993	EW42LOMD	250	160
S <sup>4)</sup>	06	4	23	16.0	27.0	31	12	17	48	EW06SOMD	800	630
	08	5	24	17.0	27.5	32	14	19	65	EW08SOMD	800	630
	10	6	25	17.5	30.0	34	17	22	92	EW10SOMD	800	630
	12	8	29	21.5	31.0	38	17	24	107	EW12SOMD	630	630
	16	12	33	24.5	36.5	43	24	30	212	EW16SOMD	630	400
	20	16	37	26.5	44.5	48	27	36	309	EW20SOMD	420	400
	25	20	42	30.0	50.0	54	36	46	547	EW25SOMD	420	400
	30	25	49	35.5	55.0	62	41	50	744	EW30SOMD	420	400
	38	32	57	41.0	63.0	72	50	60	1222	EW38SOMD	420	315

<sup>1)</sup> Pressure shown = item deliverable

<sup>3)</sup> L = light series; <sup>4)</sup> S = heavy series

$$\frac{PN(\text{bar})}{10} = PN(\text{MPa})$$

Part numbers shown are body only level. To order with a nut and progressive ring (sleeve) included, please see pages D12 and D13 for part number ordering instructions. Instructions for ordering the fitting as EO-2 is also included on these pages.

Order code suffixes			
Material	Suffix surface and material	Example	Standard sealing material (no additional suffix needed)
Steel, zinc plated, Cr(VI)-free	CF	EW16SOMDCF	NBR
Stainless Steel	71	EW16SOMD71	VIT

\*Please add the **suffixes** below according to the material/surface required.

[Click here for CADs, Support Resources or to Configure Parts Online](#)

# EW-R-ED

Assembled Adjustable Swivel Elbow  
24° Flareless / BSPP with EOlastic Seal

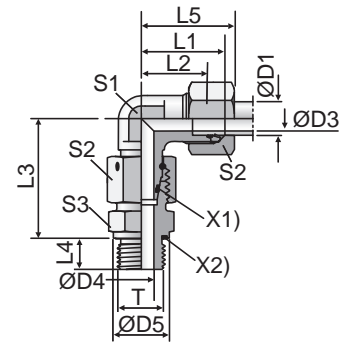

X1) O-ring OR  
X2) Eolastic-sealing ED

TABLE OF CONTENTS

VISUAL INDEX

D

FAQs

ASSEMBLY

TUBE FAB EQUIP

GEN TECH

Series	D1	T	D3	D4	D5	L1	L2	L3	L4	L5	S1	S2	S3	Weight g/1 piece	Order code*	PN (bar <sup>1)</sup> )	
																CF	71
L <sup>3)</sup>	06	G 1/8 A	4	4	14	19	12.0	34.5	8	27	12	14	14	47	EW06LREDOMD	500	315
	08	G 1/4 A	6	6	19	21	14.0	37.5	12	29	12	17	19	69	EW08LREDOMD	500	315
	10	G 1/4 A	8	6	19	22	15.0	40.0	12	30	14	19	19	87	EW10LREDOMD	500	315
	12	G 3/8 A	10	9	22	24	17.0	42.0	12	32	17	22	22	122	EW12LREDOMD	400	315
	15	G 1/2 A	12	11	27	28	21.0	46.5	14	36	19	27	27	199	EW15LREDOMD	400	315
	18	G 1/2 A	15	14	27	31	23.5	50.0	14	40	24	32	27	268	EW18LREDOMD	400	315
	22	G 3/4 A	19	18	32	35	27.5	55.0	16	44	27	36	32	360	EW22LREDOMD	250	160
	28	G 1 A	24	23	40	38	30.5	59.0	18	47	36	41	41	539	EW28LREDOMD	250	160
	35	G 1 1/4 A	30	30	50	45	34.5	68.5	20	56	41	50	50	834	EW35LREDOMD	250	160
	42	G 1 1/2 A	36	36	55	51	40.0	75.0	22	63	50	60	55	1341	EW42LREDOMD	250	160
S <sup>4)</sup>	06	G 1/4 A	4	4	19	23	16.0	40.0	12	31	12	17	19	83	EW06SREDOMD	800	630
	08	G 1/4 A	5	5	19	24	17.0	42.5	12	32	14	19	19	106	EW08SREDOMD	800	630
	10	G 3/8 A	6	7	22	25	17.5	45.0	12	34	17	22	22	148	EW10SREDOMD	800	630
	12	G 3/8 A	8	8	22	29	21.5	48.0	12	38	17	24	22	170	EW12SREDOMD	630	630
	16	G 1/2 A	12	12	27	33	24.5	55.0	14	43	24	30	27	303	EW16SREDOMD	630	400
	20	G 3/4 A	16	16	32	37	26.5	65.0	16	48	27	36	32	458	EW20SREDOMD	420	400
	25	G 1 A	20	20	40	42	30.0	73.0	18	54	36	46	41	813	EW25SREDOMD	420	400
	30	G 1 1/4 A	25	25	50	49	35.5	78.5	20	62	41	50	50	1163	EW30SREDOMD	420	400
38	G 1 1/2 A	32	32	55	57	41.0	89.0	22	72	50	60	55	1784	EW38SREDOMD	420	315	

<sup>1)</sup> Pressure shown = item deliverable

<sup>3)</sup> L = light series; <sup>4)</sup> S = heavy series

$$\frac{PN(\text{bar})}{10} = PN(\text{MPa})$$

Part numbers shown are body only level. To order with a nut and progressive ring (sleeve) included, please see pages D12 and D13 for part number ordering instructions. Instructions for ordering the fitting as EO-2 is also included on these pages.

Order code suffixes			
Material	Suffix surface and material	Example	Standard sealing material (no additional suffix needed)
Steel, zinc plated, Cr(VI)-free	CF	EW16SREDOMDCF	NBR
Stainless Steel	71	EW16SREDOMD71	VIT

**WARNING:** This product can expose you to chemicals including Lead and Lead Compounds which is known to the State of California to cause cancer and birth defects or other reproductive harm. For more information go to [www.p65warnings.ca.gov](http://www.p65warnings.ca.gov).

[Click here for CADs, Support Resources or to Configure Parts Online](#)

# EW-M-ED

Assembled Adjustable Swivel Elbow  
24° Flareless / Metric Parallel with EOlastic Seal

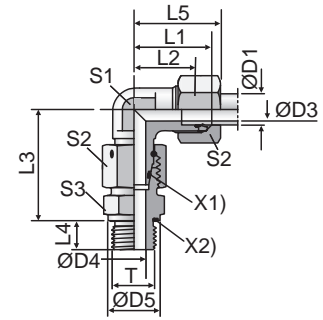

X1) O-ring OR  
X2) Eolastic-sealing ED

TABLE OF CONTENTS

VISUAL INDEX

FAQs

ASSEMBLY

TUBE FAB EQUIP

GEN TECH

Series	D1	T	D3	D4	D5	L1	L2	L3	L4	L5	S1	S2	S3	Weight g/1 piece	Order code*	PN (bar) <sup>1)</sup>	
																CF	71
L <sup>3)</sup>	06	M 10×1.0	4	4	14	19	12.0	34.5	8	27	12	14	14	47	EW06LMEDOMD	500	315
	08	M 12×1.5	6	6	17	21	14.0	37.5	12	29	12	17	17	69	EW08LMEDOMD	500	315
	10	M 14×1.5	8	7	19	22	15.0	40.0	12	30	14	19	19	87	EW10LMEDOMD	500	315
	12	M 16×1.5	10	9	22	24	17.0	42.0	12	32	17	22	22	111	EW12LMEDOMD	400	315
	15	M 18×1.5	12	11	24	28	21.0	46.0	12	36	19	27	24	179	EW15LMEDOMD	400	315
	18	M 22×1.5	15	14	27	31	23.5	50.0	14	40	24	32	27	272	EW18LMEDOMD	400	315
	22	M 26×1.5	19	18	32	35	27.5	55.0	16	44	27	36	32	360	EW22LMEDOMD	250	160
	28	M 33×2.0	24	23	40	38	30.5	59.0	18	47	36	41	41	538	EW28LMEDOMD	250	160
	35	M 42×2.0	30	30	50	45	34.5	68.5	20	56	41	50	50	843	EW35LMEDOMD	250	160
	42	M 48×2.0	36	36	55	51	40.0	75.0	22	63	50	60	55	1353	EW42LMEDOMD	250	160
S <sup>4)</sup>	06	M 12×1.5	4	4	17	23	16.0	40.0	12	31	12	17	17	77	EW06SMEDOMD	800	630
	08	M 14×1.5	5	5	19	24	17.0	42.5	12	32	14	19	19	107	EW08SMEDOMD	800	630
	10	M 16×1.5	6	7	22	25	17.5	45.0	12	34	17	22	22	146	EW10SMEDOMD	800	630
	12	M 18×1.5	8	8	24	29	21.5	48.0	12	38	17	24	24	178	EW12SMEDOMD	630	630
	16	M 22×1.5	12	12	27	33	24.5	55.0	14	43	24	30	27	307	EW16SMEDOMD	630	400
	20	M 27×2.0	16	16	32	37	26.5	65.0	16	48	27	36	32	459	EW20SMEDOMD	420	400
	25	M 33×2.0	20	20	40	42	30.0	73.0	18	54	36	46	41	812	EW25SMEDOMD	420	400
	30	M 42×2.0	25	25	50	49	35.5	78.5	20	62	41	50	50	1167	EW30SMEDOMD	420	400
38	M 48×2.0	32	32	55	57	41.0	89.0	22	72	50	60	55	1790	EW38SMEDOMD	420	315	

<sup>1)</sup> Pressure shown = item deliverable

<sup>3)</sup> L = light series; <sup>4)</sup> S = heavy series

$\frac{PN \text{ (bar)}}{10} = PN \text{ (MPa)}$

Part numbers shown are body only level. To order with a nut and progressive ring (sleeve) included, please see pages D12 and D13 for part number ordering instructions. Instructions for ordering the fitting as EO-2 is also included on these pages.

**WARNING:** This product can expose you to chemicals including Lead and Lead Compounds which is known to the State of California to cause cancer and birth defects or other reproductive harm. For more information go to [www.p65warnings.ca.gov](http://www.p65warnings.ca.gov).

\*Please add the suffixes below according to the material/ surface required.

Order code suffixes			
Material	Suffix surface and material	Example	Standard sealing material (no additional suffix needed)
Steel, zinc plated, Cr(VI)-free	CF	EW16SMEDOMDCF	NBR
Stainless Steel	71	EW16SMEDOMD71	VIT



[Click here for CADs, Support Resources or to Configure Parts Online](#)

# SWVE-R

Banjo Elbow  
24° Flareless / BSPP

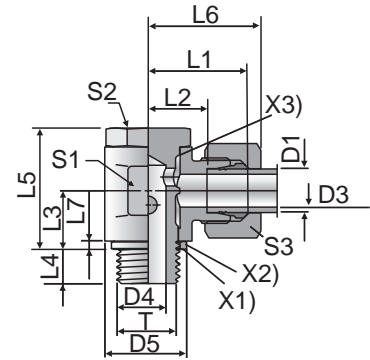

X1) Metal seal ring DKA  
X2) Soft seal ring KDS  
X3) O-ring OR

- TABLE OF CONTENTS
- VISUAL INDEX
- D
- FAQs
- ASSEMBLY
- TUBE FAB EQUIP
- GEN TECH

Series	D1	T	D3	D4	DKA D5	KDS D5	L1	L2	L3	L4	L5	L6	L7	S1	S2	S3	Weight g/1 piece	Type A Order code* metal sealed	Type B Order code* soft sealed	PN (bar) <sup>1)</sup> CF
LL <sup>2)</sup>	04	G 1/8 A	3.0	5.0	14	15	15.5	11.5	10.0	6	21.0	21	2.5	14	14	10	28	SWVE04LLROMD	SWVE04LLRKDSOMD	63
	06	G 1/8 A	4.5	5.0	14	15	15.5	10.0	10.0	6	21.5	22	2.5	14	14	12	28	SWVE06LLROMD	SWVE06LLRKDSOMD	63
	08	G 1/8 A	6.0	5.0	14	15	16.5	11.0	10.0	6	21.0	23	2.5	14	14	14	30	SWVE08LLROMD	SWVE08LLRKDSOMD	63
L <sup>3)</sup>	06	G 1/8 A	4.0	5.0	14	15	17.5	10.5	10.0	6	21.0	25	2.5	14	14	14	31	SWVE06LROMD	SWVE06LRKDSOMD	160
	08	G 1/4 A	6.0	6.5	18	19	20.0	13.0	13.0	9	27.0	28	3.0	19	19	17	65	SWVE08LROMD	SWVE08LRKDSOMD	160
	10	G 1/4 A	8.0	6.5	18	19	21.0	14.0	13.0	9	27.0	29	3.0	19	19	19	66	SWVE10LROMD	SWVE10LRKDSOMD	160
	12	G 3/8 A	10.0	8.5	22	22	22.5	15.5	15.0	9	32.0	30	3.0	22	22	22	102	SWVE12LROMD	SWVE12LRKDSOMD	100
	15	G 1/2 A	12.0	11.0	26	27	26.0	19.0	18.0	11	37.5	34	4.5	27	27	27	171	SWVE15LROMD	SWVE15LRKDSOMD	100
	18	G 1/2 A	15.0	13.0	26	27	28.0	20.5	21.5	11	44.5	37	4.5	30	27	32	249	SWVE18LROMD	SWVE18LRKDSOMD	100
	22	G 3/4 A	19.0	18.0	32	33	33.0	25.5	24.0	13	49.0	42	3.5	36	32	36	349	SWVE22LROMD	SWVE22LRKDSOMD	100
	28	G 1 A	24.0	22.0	39	40	39.5	32.0	30.5	14	66.5	49	3.5	50	46	41		SWVE28LROMD	SWVE28LRKDSOMD	100
	35	G 1 1/4 A	30.0	29.0	49	50	46.5	36.0	35.5	16	76.0	58	3.5	60	55	50		SWVE35LROMD	SWVE35LRKDSOMD	100
	42	G 1 1/2 A	36.0	35.0	55	56	51.5	40.5	40.5	18	86.0	63	3.5	70	60	60		SWVE42LROMD	SWVE42LRKDSOMD	100
S <sup>4)</sup>	06	G 1/4 A	4.0	6.5	18	19	22.0	15.0	13.0	9	27.0	30	3.0	19	19	17	69	SWVE06SROMD	SWVE06SRKDSOMD	160
	08	G 1/4 A	5.0	6.5	18	19	22.0	15.0	13.0	9	27.0	30	3.0	19	19	19	73	SWVE08SROMD	SWVE08SRKDSOMD	160
	10	G 3/8 A	7.0	8.5	22	22	23.5	16.0	15.0	9	32.0	32	3.0	22	22	22	108	SWVE10SROMD	SWVE10SRKDSOMD	100
	12	G 3/8 A	8.0	8.0	22	22	24.5	17.0	18.0	9	37.0	33	3.0	24	24	24	147	SWVE12SROMD	SWVE12SRKDSOMD	100
	16	G 1/2 A	12.0	13.0	26	27	30.0	21.5	21.5	11	44.5	40	4.5	30	27	30	249	SWVE16SROMD	SWVE16SRKDSOMD	100
	20	G 3/4 A	16.0	18.0	32	33	35.0	24.5	24.0	13	49.0	46	3.5	36	32	36	359	SWVE20SROMD	SWVE20SRKDSOMD	100
	25	G 1 A	20.0	22.0	39	40	43.5	31.5	30.5	14	66.5	56	3.5	50	46	46		SWVE25SROMD	SWVE25SRKDSOMD	100
	30	G 1 1/4 A	25.0	29.0	49	50	50.5	37.0	35.5	16	76.0	64	3.5	60	55	50		SWVE30SROMD	SWVE30SRKDSOMD	100
	38	G 1 1/2 A	32.0	35.0	55	56	57.5	41.5	40.5	18	86.0	72	3.5	70	60	60		SWVE38SROMD	SWVE38SRKDSOMD	100

<sup>1)</sup> Pressure shown = item deliverable

<sup>2)</sup> LL = very light series; <sup>3)</sup> L = light series; <sup>4)</sup> S = heavy series

$$\frac{PN \text{ (bar)}}{10} = PN \text{ (MPa)}$$

Part numbers shown are body only level. To order with a nut and progressive ring (sleeve) included, please see pages D12 and D13 for part number ordering instructions. Instructions for ordering the fitting as EO-2 is also included on these pages.

**WARNING:** This product can expose you to chemicals including Lead and Lead Compounds which is known to the State of California to cause cancer and birth defects or other reproductive harm. For more information go to [www.p65warnings.ca.gov](http://www.p65warnings.ca.gov).

\*Please add the suffixes below according to the material/surface required.

Order code suffixes			
Material	Suffix surface and material	Example	Standard sealing material (no additional suffix needed)
Steel, zinc plated, Cr(VI)-free	CF	SWVE16SROMDCF	NBR
Steel, zinc plated, Cr(VI)-free	CF	SWVE16SRKDSOMDCF	NBR

[Click here for CADs, Support Resources or to Configure Parts Online](#)

# SWVE-M

Banjo Elbow  
24° Flareless / Metric Parallel

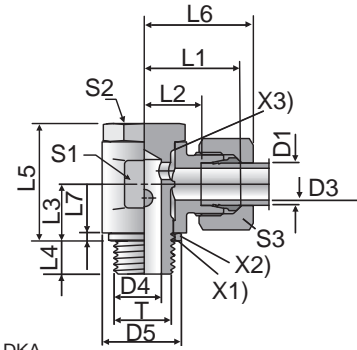

X1) Metal seal ring DKA  
X2) Soft seal ring KDS  
X3) O-ring OR

TABLE OF CONTENTS

VISUAL INDEX

FAQs

ASSEMBLY

TUBE FAB EQUIP

GEN TECH

Series	D1	T	D3	D4	DKA D5	KDS D5	L1	L2	L3	L4	L5	L6	L7	S1	S2	S3	Weight g/1 piece	Type A Order code* metal sealed	Type B Order code* soft sealed	PN (bar) <sup>1)</sup> CF
LL <sup>2)</sup>	04	M 08x1.0	3.0	3.0	12.5		14.5	10.5	8.0	6	17.0	20	2.5	12	12	10	18	SWVE04LLMOMD	—	63
	06	M 10x1.0	4.5	5.0	14.0	15	15.5	10.0	10.0	6	21.0	22	2.5	14	14	12	29	SWVE06LLMOMD	SWVE06LLMKDSOMD	63
	08	M 10x1.0	6.0	5.0	14.0	15	16.5	11.0	10.0	6	21.0	23	2.5	14	14	14	31	SWVE08LLMOMD	SWVE08LLMKDSOMD	63
L <sup>3)</sup>	06	M 10x1.0	4.5	5.0	14.0	15	15.5	10.5	10.0	6	21.5	25	2.5	14	14	14	31	SWVE06LMOMD	SWVE06LMKDSOMD	160
	08	M 12x1.5	6.0	6.0	17.0	17	19.0	12.0	12.0	9	25.0	27	3.0	17	17	17	51	SWVE08LMOMD	SWVE08LMKDSOMD	160
	10	M 14x1.5	8.0	6.5	19.0	19	21.0	14.0	13.0	9	27.0	29	3.0	19	19	19	68	SWVE10LMOMD	SWVE10LMKDSOMD	160
	12	M 16x1.5	10.0	8.5	21.0	22	22.5	15.5	15.0	9	32.0	30	3.0	22	21	22	100	SWVE12LMOMD	SWVE12LMKDSOMD	100
	15	M 18x1.5	12.0	11.0	23.0	24	24.5	17.5	18.0	9	37.5	33	3.0	24	24	27	138	SWVE15LMOMD	SWVE15LMKDSOMD	100
	18	M 22x1.5	15.0	13.0	27.0	27	28.0	20.5	21.5	11	44.5	37	4.5	30	27	32	241	SWVE18LMOMD	SWVE18LMKDSOMD	100
	22	M 26x1.5	19.0	18.0	31.0	32	33.0	25.5	24.0	13	49.0	42	3.5	36	32	36	351	SWVE22LMOMD	SWVE22LMKDSOMD	100
	28	M 33x2.0	24.0	22.0	39.0	40	39.5	32.0	30.5	14	66.5	49	3.5	50	46	41		SWVE28LMOMD	SWVE28LMKDSOMD	100
	35	M 42x2.0	30.0	29.0	49.0	50	46.5	36.0	35.5	16	76.0	58	3.5	60	55	50		SWVE35LMOMD	SWVE35LMKDSOMD	100
	42	M 48x2.0	36.0	35.0	55.0	56	51.5	40.5	40.5	18	86.0	63	3.5	70	60	60		SWVE42LMOMD	SWVE42LMKDSOMD	100
S <sup>4)</sup>	06	M 12x1.5	4.0	6.0	17.0	17	21.0	14.0	12.0	9	25.0	29	3.0	17	17	17	55	SWVE06SMOMD	SWVE06SMKDSOMD	160
	08	M 14x1.5	5.0	6.5	19.0	19	22.0	15.0	13.0	9	27.0	30	3.0	19	19	19	75	SWVE08SMOMD	SWVE08SMKDSOMD	160
	10	M 16x1.5	7.0	8.5	21.0	22	23.5	16.0	15.0	9	32.0	32	3.0	22	22	22	106	SWVE10SMOMD	SWVE10SMKDSOMD	100
	12	M 18x1.5	8.0	11.0	23.0	24	24.5	17.0	18.0	9	37.0	33	3.0	24	24	24	134	SWVE12SMOMD	SWVE12SMKDSOMD	100
	16	M 22x1.5	12.0	13.0	27.0	27	30.0	21.5	21.5	11	44.5	40	4.5	30	27	30	252	SWVE16SMOMD	SWVE16SMKDSOMD	100
	20	M 27x2.0	16.0	18.0	32.0	33	35.0	24.5	24.0	13	49.0	46	3.5	36	32	36	363	SWVE20SMOMD	SWVE20SMKDSOMD	100
	25	M 33x2.0	20.0	22.0	39.0	40	43.5	31.5	30.5	14	66.5	56	3.5	50	46	46		SWVE25SMOMD	SWVE25SMKDSOMD	100
	30	M 42x2.0	25.0	29.0	49.0	50	50.5	37.0	35.5	16	76.0	64	3.5	60	55	50		SWVE30SMOMD	SWVE30SMKDSOMD	100
38	M 48x2.0	32.0	35.0	55.0	56	57.5	41.5	40.5	18	86.0	72	3.5	70	60	60		SWVE38SMOMD	SWVE38SMKDSOMD	100	

<sup>1)</sup> Pressure shown = item deliverable

<sup>2)</sup> LL = very light series; <sup>3)</sup> L = light series; <sup>4)</sup> S = heavy series

$$\frac{PN(\text{bar})}{10} = PN(\text{MPa})$$

Part numbers shown are body only level. To order with a nut and progressive ring (sleeve) included, please see pages D12 and D13 for part number ordering instructions. Instructions for ordering the fitting as EO-2 is also included on these pages.

**WARNING:** This product can expose you to chemicals including Lead and Lead Compounds which is known to the State of California to cause cancer and birth defects or other reproductive harm. For more information go to [www.p65warnings.ca.gov](http://www.p65warnings.ca.gov).

\*Please add the **suffixes** below according to the material/ surface required.

Order code suffixes			
Material	Suffix surface and material	Example	Standard sealing material (no additional suffix needed)
Steel, zinc plated, Cr(VI)-free	CF	SWVE16SMOMDCF	NBR
Steel, zinc plated, Cr(VI)-free	CF	SWVE16SMKDSOMDCF	NBR

[Click here for CADs, Support Resources or to Configure Parts Online](#)

# WH-R

High Pressure Banjo Elbow  
24° Flareless / BSPP

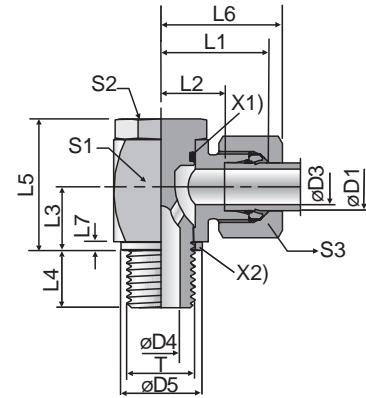

X1) O-ring OR  
X2) Sealing ring DKA

Series	D1	T	D3	D4	D5	L1	L2	L3	L4	L5	L6	L7	S1	S2	S3	Weight g/1 piece	Order code*	CF	71	PN (bar) <sup>1)</sup>
L <sup>3)</sup>	06	G 1/8 A	4	4.5	14	19.0	12.0	10.5	8	24.0	27	2.5	17	17	14	54	WH06LROMD	250	250	
	08	G 1/4 A	6	6.0	17	21.5	14.5	14.0	12	30.0	29	3.0	22	19	17	97	WH08LROMD	250	250	
	10	G 1/4 A	8	6.0	19	22.5	15.5	14.0	12	30.0	30	3.0	22	19	19	104	WH10LROMD	250	250	
	12	G 3/8 A	10	7.5	21	25.0	18.0	16.5	12	36.0	33	3.0	27	24	22	180	WH12LROMD	250	250	
	15	G 1/2 A	11	9.0	23	27.5	21.5	18.5	12	39.5	37	3.0	30	27	27	243	WH15LROMD	250	250	
	18	G 1/2 A	15	12.0	27	28.5	21.0	21.5	14	45.0	37	4.5	32	30	32	326	WH18LROMD	250	250	
	22	G 3/4 A	19	17.0	31	35.0	27.5	24.0	16	53.0	44	3.5	41	36	36	574	WH22LROMD	160	160	
	28	G 1 A	24	21.0	39	39.5	32.0	30.5	18	66.0	49	3.5	50	46	41	1016	WH28LROMD	160	160	
	35	G 1 1/4 A	30	27.0	49	46.5	36.0	35.5	20	76.0	58	3.5	60	55	50	1512	WH35LROMD	160	160	
	42	G 1 1/2 A	36	34.0	55	51.5	40.5	40.5	22	87.0	63	3.5	70	60	60	2216	WH42LROMD	160	160	
S <sup>4)</sup>	06	G 1/4 A	4	6.0	17	23.5	16.5	14.0	12	30.0	31	3.0	22	19	17	104	WH06SROMD	315	315	
	08	G 1/4 A	5	6.0	19	23.5	16.5	14.0	12	30.0	31	3.0	22	19	19	111	WH08SROMD	315	315	
	10	G 3/8 A	7	7.5	21	26.0	18.5	16.5	12	36.0	35	3.0	27	24	22	186	WH10SROMD	315	315	
	12	G 3/8 A	8	9.0	23	27.5	20.0	18.5	12	39.5	36	3.0	27*	27	24	246	WH12SROMD	315	315	
	16	G 1/2 A	12	12.0	27	30.5	22.0	21.5	14	45.0	40	4.5	32	30	30	326	WH16SROMD	315	315	
	20	G 3/4 A	16	16.0	32	37.0	26.5	24.0	16	53.0	48	3.5	41	36	36	596	WH20SROMD	160	160	
	25	G 1 A	20	21.0	39	43.5	31.5	30.5	18	66.0	56	3.5	50	46	46	1055	WH25SROMD	160	160	
	30	G 1 1/4 A	25	27.0	49	50.5	37.0	35.5	20	76.0	64	3.5	60	55	50	1572	WH30SROMD	160	160	
	38	G 1 1/2 A	32	34.0	55	57.5	41.5	40.5	22	87.0	72	3.5	70	60	60	2316	WH38SROMD	160	160	

<sup>1)</sup> Pressure shown = item deliverable

<sup>3)</sup> L = light series; <sup>4)</sup> S = heavy series

$\frac{PN (bar)}{10} = PN (MPa)$

Part numbers shown are body only level. To order with a nut and progressive ring (sleeve) included, please see pages D12 and D13 for part number ordering instructions. Instructions for ordering the fitting as EO-2 is also included on these pages.

\*S1=SW30 in 1.4571



**WARNING:** This product can expose you to chemicals including Lead and Lead Compounds which is known to the State of California to cause cancer and birth defects or other reproductive harm. For more information go to [www.p65warnings.ca.gov](http://www.p65warnings.ca.gov).

Order code suffixes			
Material	Suffix surface and material	Example	Standard sealing material (no additional suffix needed)
Steel, zinc plated, Cr(VI)-free	CF	WH16SMOMDCF	NBR
Stainless Steel	71	WH16SMOMD71	VIT

\*Please add the **suffixes** below according to the material/surface required.

[Click here for CADs, Support Resources or to Configure Parts Online](#)

# WH-M

High Pressure Banjo Elbow  
24° Flareless / Metric Parallel

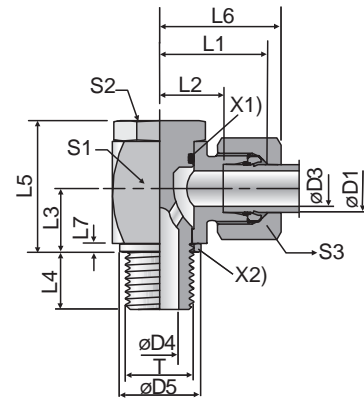

X1) O-ring OR  
X2) Sealing ring DKA

Series	D1	T	D3	D4	D5	L1	L2	L3	L4	L5	L6	L7	S1	S2	S3	Weight g/1 piece	Order code*	CF	PN (bar) <sup>1)</sup>
L <sup>3)</sup>	06	M 10×1.0	4	4.5	14	19.0	12.0	10.5	8	24.0	27	2.5	17	17	14	54	WH06LMOMD	250	250
	08	M 12×1.5	6	6.0	17	21.5	14.5	14.0	12	30.0	29	3.0	22	19	17	97	WH08LMOMD	250	250
	10	M 14×1.5	8	6.0	19	22.5	15.5	14.0	12	30.0	30	3.0	22	19	19	104	WH10LMOMD	250	250
	12	M 16×1.5	10	7.5	21	25.0	18.0	16.5	12	36.0	33	3.0	27	24	22	180	WH12LMOMD	250	250
	15	M 18×1.5	11	9.0	23	27.5	21.5	18.5	12	39.5	37	3.0	30	27	27	243	WH15LMOMD	250	250
	18	M 22×1.5	15	12.0	27	28.5	21.0	21.5	14	45.0	37	4.5	32	30	32	326	WH18LMOMD	250	250
	22	M 26×1.5	19	17.0	31	35.0	27.5	24.0	16	53.0	44	3.5	41	36	36	574	WH22LMOMD	160	160
	28	M 33×2.0	24	21.0	39	39.5	32.0	30.5	18	66.0	49	3.5	50	46	41	1016	WH28LMOMD	160	160
	35	M 42×2.0	30	27.0	49	46.5	36.0	35.5	20	76.0	58	3.5	60	55	50	1512	WH35LMOMD	160	160
	42	M 48×2.0	36	34.0	55	51.5	40.5	40.5	22	87.0	63	3.5	70	60	60	2216	WH42LMOMD	160	160
S <sup>4)</sup>	06	M 12×1.5	4	6.0	17	23.5	16.5	14.0	12	30.0	31	3.0	22	19	17	104	WH06SMOMD	315	315
	08	M 14×1.5	5	6.0	19	23.5	16.5	14.0	12	30.0	31	3.0	22	19	19	111	WH08SMOMD	315	315
	10	M 16×1.5	7	7.5	21	26.0	18.5	16.5	12	36.0	35	3.0	27	24	22	186	WH10SMOMD	315	315
	12	M 18×1.5	8	9.0	23	27.5	20.0	18.5	12	39.5	36	3.0	27*	24	24	246	WH12SMOMD	315	315
	16	M 22×1.5	12	12.0	27	30.5	22.0	21.5	14	45.0	40	4.5	32	30	30	326	WH16SMOMD	315	315
	20	M 27×2.0	16	16.0	32	37.0	26.5	24.0	16	53.0	48	3.5	41	36	36	596	WH20SMOMD	160	160
	25	M 33×2.0	20	21.0	39	43.5	31.5	30.5	18	66.0	56	3.5	50	46	46	1055	WH25SMOMD	160	160
	30	M 42×2.0	25	27.0	49	50.5	37.0	35.5	20	76.0	64	3.5	60	55	50	1572	WH30SMOMD	160	160
	38	M 48×2.0	32	34.0	55	57.5	41.5	40.5	22	87.0	72	3.5	70	60	60	2316	WH38SMOMD	160	160

<sup>1)</sup> Pressure shown = item deliverable

<sup>3)</sup> L = light series; <sup>4)</sup> S = heavy series

$$\frac{PN(\text{bar})}{10} = PN(\text{MPa})$$

Part numbers shown are body only level. To order with a nut and progressive ring (sleeve) included, please see pages D12 and D13 for part number ordering instructions. Instructions for ordering the fitting as EO-2 is also included on these pages.

\*S1=SW30 in 1.4571

**WARNING:** This product can expose you to chemicals including Lead and Lead Compounds which is known to the State of California to cause cancer and birth defects or other reproductive harm. For more information go to [www.p65warnings.ca.gov](http://www.p65warnings.ca.gov).

Stainless Steel only with sealing ring **KD** available!  
Replace KDS by **KD** in the order code.

Order code suffixes			
Material	Suffix surface and material	Example	Standard sealing material (no additional suffix needed)
Steel, zinc plated, Cr(VI)-free	CF	WH16SMOMDCF	NBR
Stainless Steel	71	WH16SMOMD71	VIT

\*Please add the suffixes below according to the material/surface required.

Click here for CADs, Support Resources or to Configure Parts Online

# WH-R-KDS

High Pressure Banjo Elbow  
24° Flareless / BSPP

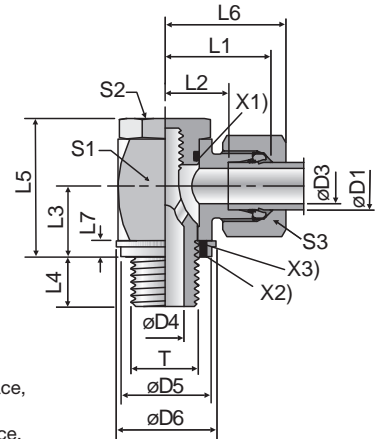

X1) O-ring OR  
X2) Sealing ring KDS (for ports with small spot face, ISO 1179)  
X3) Sealing ring KD (for ports with wide spot face, ISO 1179)

Series	D1	T	D3	D4	D5 KDS	D6 KD	L1	L2	L3	L4	L5	L6	L7	S1	S2	S3	Weight g/1 piece	Order code*	PN (bar) <sup>1)</sup>	
																			CF	71
L <sup>3)</sup>	06	G 1/8 A	4	4.5	14.9	17	19.0	12.0	10.5	8	24	27	2.5	17	17	14	53	WH06LRKDSOMD	315	315
	08	G 1/4 A	6	6.0	18.9	22	21.5	14.5	14.0	12	30	29	3.0	22	19	17	101	WH08LRKDSOMD	315	315
	10	G 1/4 A	8	6.0	18.9	22	22.5	15.5	14.0	12	30	30	3.0	22	19	19	102	WH10LRKDSOMD	315	315
	12	G 3/8 A	10	7.5	21.9	27	25.0	18.0	16.5	12	36	33	3.0	27	24	22	181	WH12LRKDSOMD	315	315
	15	G 1/2 A	12	11.0	26.9	32	28.5	21.5	21.5	14	45	37	4.5	32	30	27	312	WH15LRKDSOMD	315	315
	18	G 1/2 A	15	11.0	26.9	32	28.5	21.0	21.5	14	45	37	4.5	32	30	32	319	WH18LRKDSOMD	315	315
	22	G 3/4 A	19	17.0	32.9	41	35.0	27.5	24.0	16	53	44	3.5	41	36	36	578	WH22LRKDSOMD	160	160
	28	G 1 A	24	21.0	39.9	46	39.5	32.0	30.5	18	66	49	3.5	50	46	41	1035	WH28LRKDSOMD	160	160
	35	G 1 1/4 A	30	27.0	49.9	57	46.5	36.0	35.5	20	76	58	3.5	60	55	50	1499	WH35LRKDSOMD	160	160
	42	G 1 1/2 A	36	34.0	55.9	64	51.5	40.5	40.5	22	87	63	3.5	70	60	60	2196	WH42LRKDSOMD	160	160
S <sup>4)</sup>	06	G 1/4 A	4	6.0	18.9	22	23.5	16.5	14.0	12	30	31	3.0	22	19	17	107	WH06SRKDSOMD	400	400
	08	G 1/4 A	5	6.0	18.9	22	23.5	16.5	14.0	12	30	31	3.0	22	19	19	107	WH08SRKDSOMD	400	400
	10	G 3/8 A	7	7.5	21.9	27	26.0	18.5	16.5	12	36	35	3.0	27	24	22	188	WH10SRKDSOMD	400	400
	12	G 3/8 A	8	7.5	21.9	27	26.0	18.5	16.5	12	36	35	3.0	27*	24	24	190	WH12SRKDSOMD	400	400
	16	G 1/2 A	12	11.0	26.9	32	30.5	22.0	21.5	14	45	40	4.5	32	30	30	324	WH16SRKDSOMD	315	315
	20	G 3/4 A	16	17.0	32.9	41	37.0	26.5	24.0	16	53	48	3.5	41	36	36	588	WH20SRKDSOMD	315	315
	25	G 1 A	20	21.0	39.9	46	43.5	31.5	30.5	18	66	56	3.5	50	46	46	1073	WH25SRKDSOMD	250	250
	30	G 1 1/4 A	25	27.0	49.9	57	50.5	37.0	35.5	20	76	64	3.5	60	55	50	1559	WH30SRKDSOMD	160	160
	38	G 1 1/2 A	32	34.0	55.9	64	57.5	41.5	40.5	22	87	72	3.5	70	60	60	2296	WH38SRKDSOMD	160	160

<sup>1)</sup> Pressure shown = item deliverable

<sup>3)</sup> L = light series; <sup>4)</sup> S = heavy series

$$\frac{PN \text{ (bar)}}{10} = PN \text{ (MPa)}$$

Part numbers shown are body only level. To order with a nut and progressive ring (sleeve) included, please see pages D12 and D13 for part number ordering instructions. Instructions for ordering the fitting as EO-2 is also included on these pages.

**WARNING:** This product can expose you to chemicals including Lead and Lead Compounds which is known to the State of California to cause cancer and birth defects or other reproductive harm. For more information go to [www.p65warnings.ca.gov](http://www.p65warnings.ca.gov).

Order code suffixes			
Material	Suffix surface and material	Example	Standard sealing material (no additional suffix needed)
Steel, zinc plated, Cr(VI)-free	CF	WH16SRKDSOMDCF	NBR
Stainless Steel	71	WH16SRKDOMD71	VIT/PTFE

\*Please add the suffixes below according to the material/surface required.

Stainless Steel only with sealing ring KD available!  
Replace KDS by KD in the order code.

TABLE OF CONTENTS

VISUAL INDEX

D

FAQs

ASSEMBLY

TUBE FAB EQUIP

GEN TECH



[Click here for CADs, Support Resources or to Configure Parts Online](#)

# WH-M-KDS

High Pressure Banjo Elbow  
Banjo Metric / Flareless

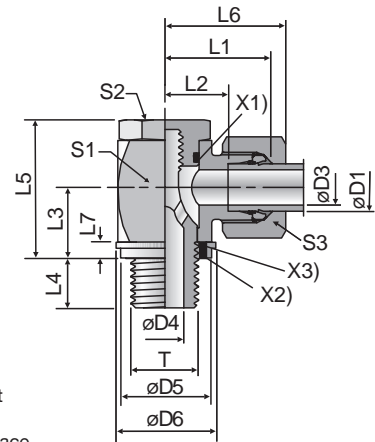

X1) O-ring OR  
X2) Sealing ring KDS (for aperts with small spot face, ISO 9974)  
X3) Sealing ring KD (for ports with wide spot face, ISO 9974)

Series	D1	T	D3	D4	D5 KDS	D6 KD	L1	L2	L3	L4	L5	L6	L7	S1	S2	S3	Weight g/1 piece	Order code*	PN (bar) <sup>1)</sup>	
																			CF	71
L <sup>3)</sup>	06	M 10×1.0	4	4.5	14.9	17.0	19.0	12.0	10.5	8	24.0	27	2.5	17	17	14	54	WH06LMKDSOMD	315	315
	08	M 12×1.5	6	6.0	17.0	22.0	21.5	14.5	14.0	12	30.0	29	3.0	22	19	17	97	WH08LMKDSOMD	315	315
	10	M 14×1.5	8	6.0	18.9	22.5	22.5	15.5	14.0	12	30.0	30	3.0	22	19	19	104	WH10LMKDSOMD	315	315
	12	M 16×1.5	10	7.5	21.9	27.0	25.0	18.0	16.5	12	36.0	33	3.0	27*	24	22	180	WH12LMKDSOMD	315	315
	15	M 18×1.5	11	9.0	23.9	29.0	27.5	21.5	18.5	12	39.5	37	3.0	30	27	27	244	WH15LMKDSOMD	315	315
	18	M 22×1.5	15	12.0	26.9	32.0	28.5	21.0	21.5	14	45.0	37	4.5	32	30	32	327	WH18LMKDSOMD	315	315
	22	M 26×1.5	19	17.0	31.9	41.0	35.0	27.5	24.0	16	53.0	44	3.5	41	36	36	573	WH22LMKDSOMD	160	160
	28	M 33×2.0	24	21.0	39.9	46.0	39.5	32.0	30.5	18	66.0	49	3.5	50	46	41	1017	WH28LMKDSOMD	160	160
	35	M 42×2.0	30	27.0	49.9	57.0	46.5	36.0	35.5	20	76.0	58	3.5	60	55	50	1512	WH35LMKDSOMD	160	160
	42	M 48×2.0	36	34.0	55.9	64.0	51.5	40.5	40.5	22	87.0	63	3.5	70	60	60	2217	WH42LMKDSOMD	160	160
S <sup>4)</sup>	06	M 12×1.5	4	6.0	17.0	22.0	23.5	16.5	14.0	12	30.0	31	3.0	22	19	17	104	WH06SMKDSOMD	400	400
	08	M 14×1.5	5	6.0	18.9	22.5	23.5	16.5	14.0	12	30.0	31	3.0	22	19	19	110	WH08SMKDSOMD	400	400
	10	M 16×1.5	7	7.5	21.9	27.0	26.0	18.5	16.5	12	36.0	35	3.0	27	24	22	186	WH10SMKDSOMD	400	400
	12	M 18×1.5	8	9.0	23.9	29.0	27.5	20.0	18.5	12	39.5	36	3.0	27*	27	24	246	WH12SMKDSOMD	400	400
	16	M 22×1.5	12	12.0	26.9	32.0	30.5	22.0	21.5	14	45.0	40	4.5	32	30	30	327	WH16SMKDSOMD	315	315
	20	M 27×2.0	16	16.0	32.9	41.0	37.0	26.5	24.0	16	53.0	48	3.5	41	36	36	598	WH20SMKDSOMD	315	315
	25	M 33×2.0	20	21.0	39.9	46.0	43.5	31.5	30.5	18	66.0	56	3.5	50	46	46	1055	WH25SMKDSOMD	250	250
	30	M 42×2.0	25	27.0	49.9	57.0	50.5	37.0	35.5	20	76.0	64	3.5	60	55	50	1572	WH30SMKDSOMD	160	160
	38	M 48×2.0	32	34.0	55.9	64.0	57.5	41.5	40.5	22	87.0	72	3.5	70	60	60	2317	WH38SMKDSOMD	160	160

<sup>1)</sup> Pressure shown = item deliverable

<sup>3)</sup> L = light series; <sup>4)</sup> S = heavy series

$$\frac{\text{PN (bar)}}{10} = \text{PN (MPa)}$$

Part numbers shown are body only level. To order with a nut and progressive ring (sleeve) included, please see pages D12 and D13 for part number ordering instructions. Instructions for ordering the fitting as EO-2 is also included on these pages.

\*S1=SW30 in 1.4571

**WARNING:** This product can expose you to chemicals including Lead and Lead Compounds which is known to the State of California to cause cancer and birth defects or other reproductive harm. For more information go to [www.p65warnings.ca.gov](http://www.p65warnings.ca.gov).

\*Please add the **suffixes** below according to the material/ surface required.

Order code suffixes			
Material	Suffix surface and material	Example	Standard sealing material (no additional suffix needed)
Steel, zinc plated, Cr(VI)-free	CF	WH16SMKDSOMDCF	NBR
Stainless Steel	71	WH16SMKDOMD71	VIT/PTFE

TABLE OF CONTENTS

VISUAL INDEX

FAQs

ASSEMBLY

TUBE FAB EQUIP

GEN TECH

[Click here for CADs, Support Resources or to Configure Parts Online](#)

# WAS

Weld Elbow  
24° Flareless / Butt Weld

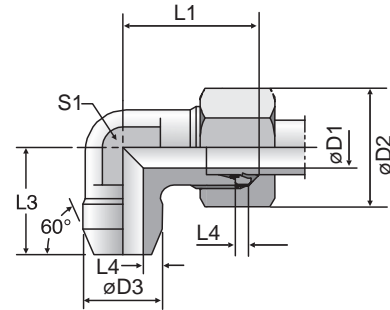

## 3000 PSI Series

Nom. flange size		max.	D1	D2	D3	L1	L2	L3	L4	S1	Weight (steel) kg/piece	Order code*	PN (bar) <sup>1)</sup>	
SAE (in.)	ISO (DN)												S	SS
1/2	13	21.3	13	30.2	21.6	44	6.7	50	4.3	22	0.22	WAS32/21.6	345	345
3/4	19	26.9	19	38.1	27.2	53	6.7	64	4.1	27	0.35	WAS33/27.2	345	345
1	25	33.7	25	44.4	34.5	60	8.0	65	4.7	34	0.52	WAS34/34.5	345	345
1 1/4	32	42.4	30	50.8	42.8	55	8.0	64	6.4	42	0.78	WAS35/42.8	276	276
1 1/2	38	48.3	38	60.3	48.6	66	8.0	78	5.3	50	1.04	WAS36/48.6	207	207

## 6000 PSI Series

1/2	13	21.3	13	31.8	21.6	44	7.7	50	4.3	22	0.35	WAS62/21.6	420	420
3/4	19	26.9	18	41.3	27.2	53	8.7	64	4.6	27	0.41	WAS63/27.2	420	420
1	25	33.7	22	47.6	34.5	60	9.5	62	6.3	34	0.64	WAS64/34.5	420	420
1 1/4	32	42.4	28	54.0	42.8	70	10.3	72	7.4	42	1.05	WAS65/42.8	420	420
1 1/2	38	48.3	32	63.5	48.6	80	12.5	84	8.3	50	1.58	WAS66/48.6	420	420

<sup>1)</sup> Pressure shown = Item deliverable

$$\frac{\text{PN (bar)}}{10} = \text{PN (MPa)}$$

The pressures given here are the maximum allowable for the flange fittings. If the pipe or tube used has a lower pressure rating, then the welded assembly rating will be the lower one, assuming the weld is adequately strong.

Stainless steel parts may have dimensional deviations. Additional information on request.

TABLE OF CONTENTS

VISUAL INDEX

D

FAQs

ASSEMBLY

TUBE FAB EQUIP

GEN TECH

[Click here for CADs, Support Resources or to Configure Parts Online](#)

**T**  
Union Tee  
24° Flareless

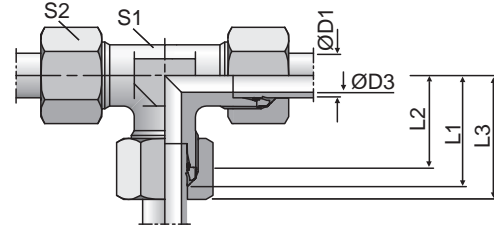

TABLE OF CONTENTS

VISUAL INDEX

FAQs

ASSEMBLY

TUBE FAB EQUIP

GEN TECH

Series	D1	D3	L1	L2	L3	S1	S2	Weight g/1 piece	Order code*	PN (bar) <sup>1)</sup>		
										CF	71	MS
LL <sup>2)</sup>	04	3.0	15	11.0	21	9	10	19	T04LL	100	100	63
	06	4.5	15	9.5	21	9	12	20	T06LL	100	100	63
	08	6.0	17	11.5	23	12	14	27	T08LL	100	100	63
	10	8.0	18	12.5	24	12	17	39	T10LL	100	100	63
	12	10.0	21	15.0	27	14	19	45	T12LL	100	100	63
L <sup>3)</sup>	06	4.0	19	12.0	27	12	14	37	T06L	500	315	200
	08	6.0	21	14.0	29	12	17	53	T08L	500	315	200
	10	8.0	22	15.0	30	14	19	48	T10L	500	315	200
	12	10.0	24	17.0	32	17	22	65	T12L	400	315	200
	15	12.0	28	21.0	36	19	27	106	T15L	400	315	200
	18	15.0	31	23.5	40	24	32	179	T18L	400	315	200
	22	19.0	35	27.5	44	27	36	225	T22L	250	160	100
	28	24.0	38	30.5	47	36	41	396	T28L	250	160	100
	35	30.0	45	34.5	56	41	50	567	T35L	250	160	100
	42	36.0	51	40.0	63	50	60	905	T42L	250	160	100
S <sup>4)</sup>	06	4.0	23	16.0	31	12	17	68	T06S	800	630	400
	08	5.0	24	17.0	32	14	19	70	T08S	800	630	400
	10	7.0	25	17.5	34	17	22	91	T10S	800	630	400
	12	8.0	29	21.5	38	19*	24	117	T12S	630	630	400
	16	12.0	33	24.5	43	24	30	202	T16S	630	400	250
	20	16.0	37	26.5	48	27	36	289	T20S	420	400	250
	25	20.0	42	30.0	54	36	46	545	T25S	420	400	250
	30	25.0	49	35.5	62	41	50	758	T30S	420	400	250
	38	32.0	57	41.0	72	50	60	1264	T38S	420	315	200

1) Pressure shown = item deliverable

2) LL = very light series; 3) L = light series; 4) S = heavy series

\*S1 = 17 in 1.4571

$$\frac{PN \text{ (bar)}}{10} = PN \text{ (MPa)}$$

Part numbers shown are body only level. To order with a nut and progressive ring (sleeve) included, please see pages D12 and D13 for part number ordering instructions. Instructions for ordering the fitting as EO-2 is also included on these pages.

**WARNING:** This product can expose you to chemicals including Lead and Lead Compounds which is known to the State of California to cause cancer and birth defects or other reproductive harm. For more information go to [www.p65warnings.ca.gov](http://www.p65warnings.ca.gov).

Order code suffixes		
Material	Suffix surface and material	Example
Steel, zinc plated, Cr(VI)-free	CFX	T16SCFX
Stainless Steel	71X	T16S71X
Brass	MSX	T16SMSX

\*Please add the suffixes below according to the material/surface required.

[Click here for CADs, Support Resources or to Configure Parts Online](#)

**TR**  
Tee-Reducer  
24° Flareless

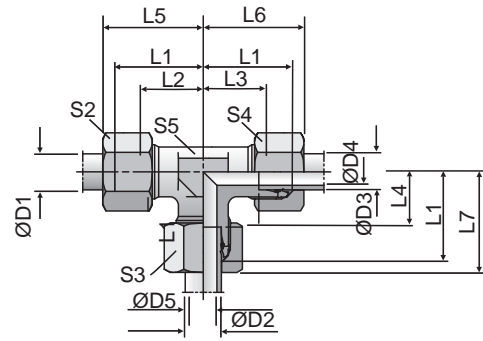

TABLE OF CONTENTS

VISUAL INDEX

D

FAQs

ASSEMBLY

TUBE FAB EQUIP

GEN TECH

Series	D1	D2	D3	D4	D5	L1	L2	L3	L4	L5	L6	L7	S2	S3	S4	S5	Weight g/1 piece	Order code*	PN (bar) <sup>1)</sup>		
																			CF	71	MS
LL <sup>2)</sup>	04	08	04	3.0	6	17	13.0	13.0	11.5	23	23	23	10	14	10	12	27	TR04/08/04LL	100	100	63
	06	04	06	4.5	3	15	9.5	9.5	11.0	21	21	21	12	10	12	9	18	TR06/04/06LL	100	100	63
L <sup>3)</sup>	06	08	06	4.0	6	21	14.0	14.0	14.0	29	29	29	14	17	14	12	54	TR06/08/06L	500	315	200
	08	06	08	6.0	4	21	14.0	14.0	14.0	29	29	29	17	14	17	12	53	TR08/06/08L	500	315	200
	06	10	06	4.0	8	22	15.0	15.0	15.0	30	30	30	14	19	14	14	53	TR06/10/06L	500	315	200
	08	10	08	6.0	8	22	15.0	15.0	15.0	30	30	30	17	19	17	14	50	TR08/10/08L	500	315	200
	10	06	10	8.0	4	22	15.0	15.0	15.0	30	30	30	19	14	19	14	46	TR10/06/10L	500	315	200
	10	08	10	8.0	6	22	15.0	15.0	15.0	30	30	30	19	17	19	14	43	TR10/08/10L	500	315	200
	10	10	06	4.0	8	22	15.0	15.0	15.0	30	30	30	19	19	14	14	49	TR10/10/06L	500	315	200
	08	12	08	6.0	10	24	17.0	17.0	17.0	32	32	32	17	22	17	17	67	TR08/12/08L	400	315	200
	12	06	12	10.0	4	24	17.0	17.0	17.0	32	32	32	22	14	22	17	66	TR12/06/12L	400	315	200
	12	08	08	6.0	6	24	17.0	17.0	17.0	32	32	32	22	17	17	17	66	TR12/08/08L	400	315	200
	12	08	12	10.0	6	24	17.0	17.0	17.0	32	32	32	22	17	22	17	68	TR12/08/12L	400	315	200
	12	10	10	8.0	8	24	17.0	17.0	17.0	32	32	32	22	19	19	17	67	TR12/10/10L	400	315	200
	12	10	12	10.0	8	24	17.0	17.0	17.0	32	32	32	22	19	22	17	67	TR12/10/12L	400	315	200
	12	12	10	8.0	10	24	17.0	17.0	17.0	32	32	32	22	22	19	17	64	TR12/12/10L	400	315	200
	10	15	10	8.0	12	28	21.0	21.0	21.0	36	36	36	19	27	19	19	105	TR10/15/10L	400	315	200
	12	15	12	10.0	12	28	21.0	21.0	21.0	36	36	36	22	27	22	19	102	TR12/15/12L	400	315	200
	15	06	15	12.0	4	28	21.0	21.0	21.0	36	36	36	27	14	27	19	107	TR15/06/15L	400	315	200
	15	10	15	12.0	8	28	21.0	21.0	21.0	36	36	36	27	19	27	19	105	TR15/10/15L	400	315	200
	15	12	12	10.0	10	28	21.0	21.0	21.0	36	36	36	27	22	22	19	101	TR15/12/12L	400	315	200
	15	12	15	12.0	10	28	21.0	21.0	21.0	36	36	36	27	22	22	19	105	TR15/12/15L	400	315	200
15	15	12	10.0	12	28	21.0	21.0	21.0	36	36	36	27	27	22	19	103	TR15/15/12L	400	315	200	
12	18	12	10.0	15	31	24.0	24.0	23.5	39	39	40	22	32	22	24	177	TR12/18/12L	400	315	200	
18	10	10	8.0	8	31	23.5	24.0	24.0	40	39	39	32	19	19	24	173	TR18/10/10L	400	315	200	
18	10	18	15.0	8	31	23.5	23.5	24.0	40	40	39	32	19	32	24	182	TR18/10/18L	400	315	200	
18	12	18	15.0	10	31	23.5	23.5	24.0	40	40	39	32	22	32	24	174	TR18/12/18L	400	315	200	

**WARNING:** This product can expose you to chemicals including Lead and Lead Compounds which is known to the State of California to cause cancer and birth defects or other reproductive harm. For more information go to [www.p65warnings.ca.gov](http://www.p65warnings.ca.gov).

Click here for CADs, Support Resources or to Configure Parts Online

# TR

Tee-Reducer  
24° Flareless

TABLE OF CONTENTS

VISUAL INDEX

FAQs

ASSEMBLY

TUBE FAB EQUIP

GEN TECH

Series	D1	D2	D3	D4	D5	L1	L2	L3	L4	L5	L6	L7	S2	S3	S4	S5	Weight g/1 piece	Order code*	PN (bar) <sup>1)</sup>		
																			CF	71	MS
L <sup>3)</sup>	18	15	18	15.0	12	31	23.5	23.5	24.0	40	40	39	32	27	32	24	179	TR18/15/18L	400	315	200
	18	18	10	8.0	15	31	23.5	24.0	23.5	40	39	40	32	32	19	24	171	TR18/18/10L	400	315	200
	22	10	22	19.0	8	35	27.5	27.5	28.0	44	44	43	36	19	36	27	232	TR22/10/22L	250	160	100
	22	12	22	19.0	10	35	27.5	27.5	28.0	44	44	43	36	22	36	27	229	TR22/12/22L	250	160	100
	22	15	15	12.0	12	35	27.5	28.0	28.0	44	43	43	36	27	27	27	240	TR22/15/15L	250	160	100
	22	15	22	19.0	12	35	27.5	27.5	28.0	44	44	43	36	27	36	27	233	TR22/15/22L	250	160	100
	22	18	18	15.0	15	35	27.5	27.5	27.5	44	44	44	36	32	32	27	236	TR22/18/18L	250	160	100
	22	18	22	19.0	15	35	27.5	27.5	27.5	44	44	44	36	32	36	27	239	TR22/18/22L	250	160	100
	22	22	18	15.0	19	35	27.5	27.5	27.5	44	44	44	36	36	32	27	228	TR22/22/18L	250	160	100
	28	10	28	24.0	8	38	30.5	30.5	31.0	47	47	46	41	19	41	36	412	TR28/10/28L	250	160	100
	28	12	28	24.0	10	38	30.5	30.5	31.0	47	47	46	41	22	41	36	408	TR28/12/28L	250	160	100
	28	15	28	24.0	12	38	30.5	30.5	31.0	47	47	46	41	27	41	36	423	TR28/15/28L	250	160	100
	28	18	28	24.0	15	38	30.5	30.5	30.5	47	47	47	41	32	41	36	421	TR28/18/28L	250	160	100
	28	22	22	19.0	19	38	30.5	30.5	30.5	47	47	47	41	36	36	36	412	TR28/22/22L	250	160	100
	28	22	28	24.0	19	38	30.5	30.5	30.5	47	47	47	41	36	41	36	415	TR28/22/28L	250	160	100
	S <sup>4)</sup>	10	06	10	7.0	4	25	17.5	17.5	18.0	34	34	33	22	17	22	17	103	TR10/06/10S	800	630
12		08	08	5.0	5	29	21.5	22.0	22.0	38	37	37	24	19	19	19*	107	TR12/08/08S	630	630	400
12		08	12	8.0	5	29	21.5	21.5	22.0	38	38	37	24	19	24	19*	105	TR12/08/12S	630	630	400
12		10	12	8.0	7	29	21.5	21.5	21.5	38	38	38	24	22	24	19*	114	TR12/10/12S	630	630	400
12		16	12	8.0	12	33	25.5	25.5	24.5	42	42	43	24	30	24	24	190	TR12/16/12S	630	400	250
16		06	16	12.0	4	33	24.5	24.5	26.0	43	43	41	30	17	30	24	176	TR16/06/16S	630	400	250
16		08	16	12.0	5	33	24.5	24.5	26.0	43	43	41	30	19	30	24	208	TR16/08/16S	630	400	250
16		10	16	12.0	7	33	24.5	24.5	25.5	43	43	42	30	22	30	24	210	TR16/10/16S	630	400	250
16		12	16	12.0	8	33	24.5	24.5	25.5	43	43	42	30	24	30	24	386	TR16/12/16S	630	400	250
16		20	16	12.0	16	37	28.5	28.5	26.5	47	47	48	30	36	30	27	296	TR16/20/16S	420	400	250
20		10	20	16.0	7	37	26.5	26.5	29.5	48	48	46	36	22	36	27	553	TR20/10/20S	420	400	250
20		12	20	16.0	8	37	26.5	26.5	29.5	48	48	46	36	24	36	27	306	TR20/12/20S	420	400	250
20		16	20	16.0	12	37	26.5	26.5	28.5	48	48	47	36	30	36	27	285	TR20/16/20S	420	400	250
20		25	20	16.0	20	42	31.5	31.5	30.0	53	53	54	36	46	36	36	544	TR20/25/20S	420	400	250
25		16	25	20.0	12	42	30.0	30.0	33.5	54	54	52	46	30	46	36	556	TR25/16/25S	420	400	250
25		20	25	20.0	16	42	30.0	30.0	31.5	54	54	53	46	36	46	36	544	TR25/20/25S	420	400	250
25	30	25	20.0	25	49	37.0	37.0	35.5	61	61	62	46	50	46	41	791	TR25/30/25S	420	400	250	

<sup>1)</sup> Pressure shown = item deliverable

<sup>2)</sup> LL = very light series; <sup>3)</sup> L = light series; <sup>4)</sup> S = heavy series

\*S5 = 17 in 1.4571

$$\frac{\text{PN (bar)}}{10} = \text{PN (MPa)}$$

Part numbers shown are body only level. To order with a nut and progressive ring (sleeve) included, please see pages D12 and D13 for part number ordering instructions. Instructions for ordering the fitting as EO-2 is also included on these pages.

**WARNING:** This product can expose you to chemicals including Lead and Lead Compounds which is known to the State of California to cause cancer and birth defects or other reproductive harm. For more information go to [www.p65warnings.ca.gov](http://www.p65warnings.ca.gov).

Order code suffixes		
Material	Suffix surface and material	Example
Steel, zinc plated, Cr(VI)-free	CFX	TR16/12/16SCFX
Stainless Steel	71X	TR16/12/16S71X
Brass	MSX	TR16/12/16SMSX

\*Please add the suffixes below according to the material/surface required.



[Click here for CADs, Support Resources or to Configure Parts Online](#)

# ET

Swivel Nut Branch Tee  
24° Flareless / 24° Flareless /  
Flareless Swivel

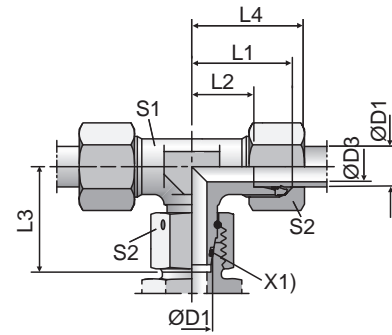

TABLE OF CONTENTS

VISUAL INDEX

D

FAQs

ASSEMBLY

TUBE FAB EQUIP

GEN TECH

Series	D1	D3	L1	L2	L3	L4	S1	S2	Weight g/1 piece	Order code*	PN (bar) <sup>1)</sup>	
											CF	71
L <sup>3)</sup>	06	4	19	12.0	26.0	27	12	14	42	ET06LOMD	500	315
	08	6	21	14.0	27.5	29	12	17	53	ET08LOMD	500	315
	10	8	22	15.0	29.0	30	14	19	71	ET10LOMD	500	315
	12	10	24	17.0	29.5	32	17	22	97	ET12LOMD	400	315
	15	12	28	21.0	32.5	36	19	27	159	ET15LOMD	400	315
	18	15	31	23.5	35.5	40	24	32	239	ET18LOMD	400	315
	22	19	35	27.5	38.5	44	27	36	308	ET22LOMD	250	160
	28	24	38	30.5	41.5	47	36	41	449	ET28LOMD	250	160
	35	30	45	34.5	51.0	56	41	50	679	ET35LOMD	250	160
	42	36	51	40.0	56.0	63	50	60	1131	ET42LOMD	250	160
S <sup>4)</sup>	06	4	23	16.0	27.0	31	12	17	63	ET06SOMD	800	630
	08	5	24	17.0	27.5	32	14	19	79	ET08SOMD	800	630
	10	6	25	17.5	30.0	34	17	22	113	ET10SOMD	800	630
	12	8	29	21.5	31.0	38	17	24	136	ET12SOMD	630	630
	16	12	33	24.5	36.5	43	24	30	239	ET16SOMD	630	400
	20	16	37	26.5	44.5	48	27	36	388	ET20SOMD	420	400
	25	20	42	30.0	50.0	54	36	46	652	ET25SOMD	420	400
	30	25	49	35.5	55.0	62	41	50	905	ET30SOMD	420	400
	38	32	57	41.0	63.0	72	50	60	1462	ET38SOMD	420	315

<sup>1)</sup> Pressure shown = item deliverable

<sup>3)</sup> L = light series; <sup>4)</sup> S = heavy series

$$\frac{PN(\text{bar})}{10} = PN(\text{MPa})$$

Part numbers shown are body only level. To order with a nut and progressive ring (sleeve) included, please see pages D12 and D13 for part number ordering instructions. Instructions for ordering the fitting as EO-2 is also included on these pages.

**WARNING:** This product can expose you to chemicals including Lead and Lead Compounds which is known to the State of California to cause cancer and birth defects or other reproductive harm. For more information go to [www.p65warnings.ca.gov](http://www.p65warnings.ca.gov).

\*Please add the **suffixes** below according to the material/surface required.

Order code suffixes			
Material	Suffix surface and material	Example	Standard sealing material (no additional suffix needed)
Steel, zinc plated, Cr(VI)-free	CF	ET16SOMDCF	NBR
Stainless Steel	71	ET16SOMD71	VIT

[Click here for CADs, Support Resources or to Configure Parts Online](#)

# ET-R-ED

Assembled Adjustable Swivel Branch Tee  
24° Flareless / 24° Flareless /  
BSPB with EOlastic Seal

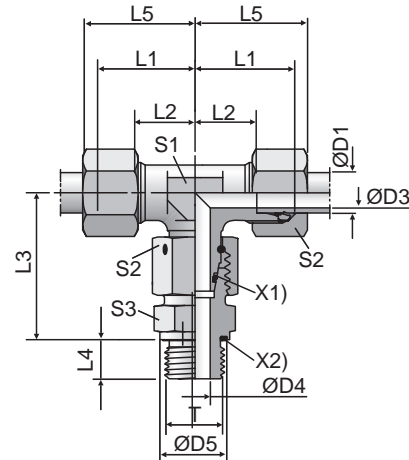

X1) O-ring OR  
X2) Eolastic-sealing ED

TABLE OF CONTENTS

VISUAL INDEX

FAQs

ASSEMBLY

TUBE FAB EQUIP

GEN TECH

Series	D1	T	D3	D4	D5	L1	L2	L3	L4	L5	S1	S2	S3	Weight g/1 piece	Order code*	PN (bar) <sup>1)</sup>	
																CF	71
L <sup>3)</sup>	06	G 1/8 A	4	4	14	19	12.0	34.5	8	27	12	14	14	55	ET06LREDOMD	500	315
	08	G 1/4 A	6	6	19	21	14.0	37.5	12	29	12	17	19	80	ET08LREDOMD	500	315
	10	G 1/4 A	8	6	19	22	15.0	40.0	12	30	14	19	19	98	ET10LREDOMD	500	315
	12	G 3/8 A	10	9	22	24	17.0	42.0	12	32	17	22	22	136	ET12LREDOMD	400	315
	15	G 1/2 A	12	11	27	28	21.0	46.5	14	36	19	27	27	224	ET15LREDOMD	400	315
	18	G 1/2 A	15	14	27	31	23.5	50.0	14	40	24	32	27	306	ET18LREDOMD	400	315
	22	G 3/4 A	19	18	32	35	27.5	55.0	16	44	27	36	32	423	ET22LREDOMD	250	160
	28	G 1 A	24	23	40	38	30.5	59.0	18	47	36	41	41	608	ET28LREDOMD	250	160
	35	G 1 1/4 A	30	30	50	45	34.5	68.5	20	56	41	50	50	920	ET35LREDOMD	250	160
	42	G 1 1/2 A	36	36	55	51	40.0	75.0	22	63	50	60	55	1466	ET42LREDOMD	250	160
S <sup>4)</sup>	06	G 1/4 A	4	4	19	23	16.0	40.0	12	31	12	17	19	98	ET06SREDOMD	800	630
	08	G 1/4 A	5	5	19	24	17.0	42.5	12	32	14	19	19	125	ET08SREDOMD	800	630
	10	G 3/8 A	6	7	22	25	17.5	45.0	12	34	17	22	22	169	ET10SREDOMD	800	630
	12	G 3/8 A	8	8	22	29	21.5	48.0	12	38	17	24	22	198	ET12SREDOMD	630	630
	16	G 1/2 A	12	12	27	33	24.5	55.0	14	43	24	30	27	348	ET16SREDOMD	630	400
	20	G 3/4 A	16	16	32	37	26.5	65.0	16	48	27	36	32	498	ET20SREDOMD	420	400
	25	G 1 A	20	20	40	42	30.0	73.0	18	54	36	46	41	918	ET25SREDOMD	420	400
	30	G 1 1/4 A	25	25	50	49	35.5	78.5	20	62	41	50	50	1324	ET30SREDOMD	420	400
	38	G 1 1/2 A	32	32	55	57	41.0	89.0	22	72	50	60	55	2025	ET38SREDOMD	420	315

<sup>1)</sup> Pressure shown = item deliverable

<sup>3)</sup> L = light series; <sup>4)</sup> S = heavy series

$$\frac{PN \text{ (bar)}}{10} = PN \text{ (MPa)}$$

Part numbers shown are body only level. To order with a nut and progressive ring (sleeve) included, please see pages D12 and D13 for part number ordering instructions. Instructions for ordering the fitting as EO-2 is also included on these pages.

**WARNING:** This product can expose you to chemicals including Lead and Lead Compounds which is known to the State of California to cause cancer and birth defects or other reproductive harm. For more information go to [www.p65warnings.ca.gov](http://www.p65warnings.ca.gov).

Order code suffixes			
Material	Suffix surface and material	Example	Standard sealing material (no additional suffix needed)
Steel, zinc plated, Cr(VI)-free	CF	ET16SREDOMDCF	NBR
Stainless Steel	71	ET16SREDOMD71	VIT

[Click here for CADs, Support Resources or to Configure Parts Online](#)

# ET-M-ED

Assembled Adjustable Swivel Branch Tee  
24° Flareless / 24° Flareless /  
Metric Parallel with EOlastic Seal

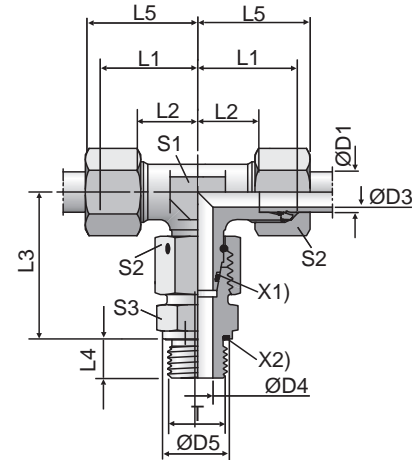

X1) O-ring OR  
X2) Eolastic-sealing ED

TABLE OF CONTENTS

VISUAL INDEX

D

FAQs

ASSEMBLY

TUBE FAB EQUIP

GEN TECH

Series	D1	T	D3	D4	D5	L1	L2	L3	L4	L5	S1	S2	S3	Weight g/1 piece	Order code*	PN (bar) <sup>1)</sup>	
																CF	71
L <sup>3)</sup>	06	M 10×1.0	4	4	14	19	12.0	34.5	8	27	12	14	14	55	ET06LMEDOMD	500	315
	08	M 12×1.5	6	6	17	21	14.0	37.5	12	29	12	17	17	75	ET08LMEDOMD	500	315
	10	M 14×1.5	8	7	19	22	15.0	40.0	12	30	14	19	19	98	ET10LMEDOMD	500	315
	12	M 16×1.5	10	9	22	24	17.0	42.0	12	32	17	22	22	135	ET12LMEDOMD	400	315
	15	M 18×1.5	12	11	24	28	21.0	46.0	12	36	19	27	24	203	ET15LMEDOMD	400	315
	18	M 22×1.5	15	14	27	31	23.5	50.0	14	40	24	32	27	310	ET18LMEDOMD	400	315
	22	M 26×1.5	19	18	32	35	27.5	55.0	16	44	27	36	32	377	ET22LMEDOMD	250	160
	28	M 33×2.0	24	23	40	38	30.5	59.0	18	47	36	41	41	607	ET28LMEDOMD	250	160
	35	M 42×2.0	30	30	50	45	34.5	68.5	20	56	41	50	50	929	ET35LMEDOMD	250	160
	42	M 48×2.0	36	36	55	51	40.0	75.0	22	63	50	60	55	1478	ET42LMEDOMD	250	160
S <sup>4)</sup>	06	M 12×1.5	4	4	17	23	16.0	40.0	12	31	12	17	17	92	ET06SMEDOMD	800	630
	08	M 14×1.5	5	5	19	24	17.0	42.5	12	32	14	19	19	126	ET08SMEDOMD	800	630
	10	M 16×1.5	6	7	22	25	17.5	45.0	12	34	17	22	22	167	ET10SMEDOMD	800	630
	12	M 18×1.5	8	8	24	29	21.5	48.0	12	38	17	24	24	207	ET12SMEDOMD	630	630
	16	M 22×1.5	12	12	27	33	24.5	55.0	14	43	24	30	27	352	ET16SMEDOMD	630	400
	20	M 27×2.0	16	16	32	37	26.5	65.0	16	48	27	36	32	498	ET20SMEDOMD	420	400
	25	M 33×2.0	20	20	40	42	30.0	73.0	18	54	36	46	41	916	ET25SMEDOMD	420	400
	30	M 42×2.0	25	25	50	49	35.5	78.5	20	62	41	50	50	1328	ET30SMEDOMD	420	400
	38	M 48×2.0	32	32	55	57	41.0	89.0	22	72	50	60	55	2031	ET38SMEDOMD	420	315

<sup>1)</sup> Pressure shown = item deliverable

<sup>3)</sup> L = light series; <sup>4)</sup> S = heavy series

$$\frac{PN \text{ (bar)}}{10} = PN \text{ (MPa)}$$

Part numbers shown are body only level. To order with a nut and progressive ring (sleeve) included, please see pages D12 and D13 for part number ordering instructions. Instructions for ordering the fitting as EO-2 is also included on these pages.

**WARNING:** This product can expose you to chemicals including Lead and Lead Compounds which is known to the State of California to cause cancer and birth defects or other reproductive harm. For more information go to [www.p65warnings.ca.gov](http://www.p65warnings.ca.gov).

\*Please add the suffixes below according to the material/surface required.

Order code suffixes			
Material	Suffix surface and material	Example	Standard sealing material (no additional suffix needed)
Steel, zinc plated, Cr(VI)-free	CF	ET16SMEDOMDCF	NBR
Stainless Steel	71	ET16SMEDOMD71	VIT

[Click here for CADs, Support Resources or to Configure Parts Online](#)

# EL

Swivel Nut Run Tee  
24° Flareless / Flareless Swivel

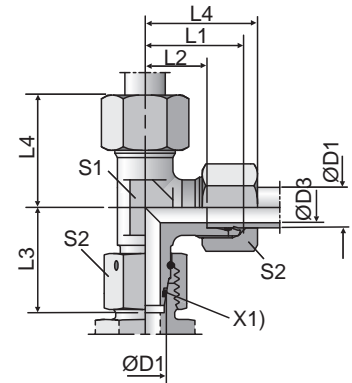

X1) O-ring OR

TABLE OF CONTENTS

VISUAL INDEX

FAQs

ASSEMBLY

TUBE FAB EQUIP

GEN TECH

Series	D1	D3	L1	L2	L3	L4	S1	S2	Weight g/1 piece	Order code*	PN (bar) <sup>1)</sup>	
											CF	71
L <sup>3)</sup>	06	4	19	12.0	26.0	27	12	14	44	EL06LOMD	500	315
	08	6	21	14.0	27.5	29	12	17	53	EL08LOMD	500	315
	10	8	22	15.0	29.0	30	14	19	68	EL10LOMD	500	315
	12	10	24	17.0	29.5	32	17	22	95	EL12LOMD	400	315
	15	12	28	21.0	32.5	36	19	27	151	EL15LOMD	400	315
	18	15	31	23.5	35.5	40	24	32	233	EL18LOMD	400	315
	22	19	35	27.5	38.5	44	27	36	309	EL22LOMD	250	160
	28	24	38	30.5	41.5	47	36	41	436	EL28LOMD	250	160
	35	30	45	34.5	51.0	56	41	50	666	EL35LOMD	250	160
	42	36	51	40.0	56.0	63	50	60	1163	EL42LOMD	250	160
S <sup>4)</sup>	06	4	23	16.0	27.0	31	12	17	65	EL06SOMD	800	630
	08	5	24	17.0	27.5	32	14	19	84	EL08SOMD	800	630
	10	6	25	17.5	30.0	34	17	22	118	EL10SOMD	800	630
	12	8	29	21.5	31.0	38	17	24	136	EL12SOMD	630	630
	16	12	33	24.5	36.5	43	24	30	260	EL16SOMD	630	400
	20	16	37	26.5	44.5	48	27	36	375	EL20SOMD	420	400
	25	20	42	30.0	50.0	54	36	46	655	EL25SOMD	420	400
	30	25	49	35.5	55.0	62	41	50	906	EL30SOMD	420	400
	38	32	57	41.0	63.0	72	50	60	1472	EL38SOMD	420	315

<sup>1)</sup> Pressure shown = item deliverable

<sup>3)</sup> L = light series; <sup>4)</sup> S = heavy series

$$\frac{PN(\text{bar})}{10} = PN(\text{MPa})$$

Part numbers shown are body only level. To order with a nut and progressive ring (sleeve) included, please see pages D12 and D13 for part number ordering instructions. Instructions for ordering the fitting as EO-2 is also included on these pages.

Order code suffixes			
Material	Suffix surface and material	Example	Standard sealing material (no additional suffix needed)
Steel, zinc plated, Cr(VI)-free	CF	EL16SOMDCF	NBR
Stainless Steel	71	EL16SOMD71	VIT

\*Please add the **suffixes** below according to the material/surface required.

[Click here for CADs, Support Resources or to Configure Parts Online](#)

# EL-R-ED

Adjustable Assembled Swivel Run Tee  
24° Flareless / BSPP with EOlastic Seal

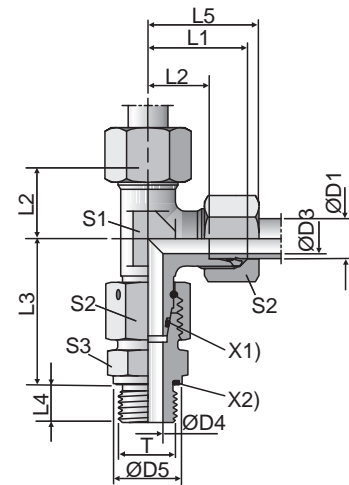

X1) O-ring OR  
X2) Eolastic-sealing ED

- TABLE OF CONTENTS
- VISUAL INDEX
- D
- FAQs
- ASSEMBLY
- TUBE FAB EQUIP
- GEN TECH

Series	D1	T	D3	D4	D5	L1	L2	L3	L4	L5	S1	S2	S3	Weight g/1 piece	Order code*	PN (bar) <sup>1)</sup>	
																CF	71
L <sup>3)</sup>	06	G 1/8 A	4	4	14	19	12.0	34.5	8	27	12	14	14	55	EL06LREDOMD	500	315
	08	G 1/4 A	6	6	19	21	14.0	37.5	12	29	12	17	19	80	EL08LREDOMD	500	315
	10	G 1/4 A	8	6	19	22	15.0	40.0	12	30	14	19	19	97	EL10LREDOMD	500	315
	12	G 3/8 A	10	9	22	24	17.0	42.0	12	32	17	22	22	137	EL12LREDOMD	400	315
	15	G 1/2 A	12	11	27	28	21.0	46.5	14	36	19	27	27	222	EL15LREDOMD	400	315
	18	G 1/2 A	15	14	27	31	23.5	50.0	14	40	24	32	27	304	EL18LREDOMD	400	315
	22	G 3/4 A	19	18	32	35	27.5	55.0	16	44	27	36	32	404	EL22LREDOMD	250	160
	28	G 1 A	24	23	40	38	30.5	59.0	18	47	36	41	41	606	EL28LREDOMD	250	160
	35	G 1 1/4 A	30	30	50	45	34.5	68.5	20	56	41	50	50	938	EL35LREDOMD	250	160
	42	G 1 1/2 A	36	36	55	51	40.0	75.0	22	63	50	60	55	1485	EL42LREDOMD	250	160
S <sup>4)</sup>	06	G 1/4 A	4	4	19	23	16.0	40.0	12	31	12	17	19	97	EL06SREDOMD	800	630
	08	G 1/4 A	5	5	19	24	17.0	42.5	12	32	14	19	19	125	EL08SREDOMD	800	630
	10	G 3/8 A	6	7	22	25	17.5	45.0	12	34	17	22	22	171	EL10SREDOMD	800	630
	12	G 3/8 A	8	8	22	29	21.5	48.0	12	38	17	24	22	198	EL12SREDOMD	630	630
	16	G 1/2 A	12	12	27	33	24.5	55.0	14	43	24	30	27	350	EL16SREDOMD	630	400
	20	G 3/4 A	16	16	32	37	26.5	65.0	16	48	27	36	32	524	EL20SREDOMD	420	400
	25	G 1 A	20	20	40	42	30.0	73.0	18	54	36	46	41	921	EL25SREDOMD	420	400
	30	G 1 1/4 A	25	25	50	49	35.5	78.5	20	62	41	50	50	1324	EL30SREDOMD	420	400
38	G 1 1/2 A	32	32	55	57	41.0	89.0	22	72	50	60	55	2033	EL38SREDOMD	420	315	

<sup>1)</sup> Pressure shown = item deliverable

<sup>3)</sup> L = light series; <sup>4)</sup> S = heavy series

$$\frac{\text{PN (bar)}}{10} = \text{PN (MPa)}$$

Part numbers shown are body only level. To order with a nut and progressive ring (sleeve) included, please see pages D12 and D13 for part number ordering instructions. Instructions for ordering the fitting as EO-2 is also included on these pages.

Order code suffixes			
Material	Suffix surface and material	Example	Standard sealing material (no additional suffix needed)
Steel, zinc plated, Cr(VI)-free	CF	EL16SREDOMDCF	NBR
Stainless Steel	71	EL16SREDOMD71	VIT

\*Please add the suffixes below according to the material/surface required.



[Click here for CADs, Support Resources or to Configure Parts Online](#)

# EL-M-ED

Adjustable Assembled Swivel Run Tee  
24° Flareless / Metric Parallel with EOlastic Seal

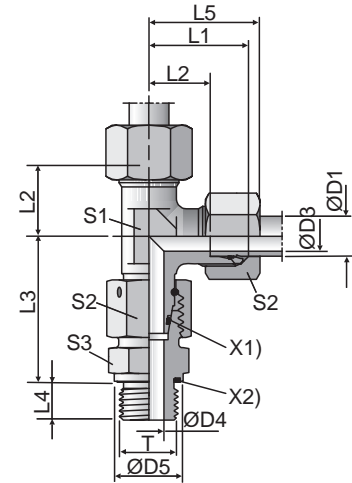

X1) O-ring OR  
X2) Eolastic-sealing ED

Series	D1	T	D3	D4	D5	L1	L2	L3	L4	L5	S1	S2	S3	Weight g/1 piece	Order code*	PN (bar) <sup>1)</sup>	
																CF	71
L <sup>3)</sup>	06	M 10×1.0	4	4	14	19	12.0	34.5	8	27	12	14	14	55	EL06LMEDOMD	500	315
	08	M 12×1.5	6	6	17	21	14.0	37.5	12	29	12	17	17	75	EL08LMEDOMD	500	315
	10	M 14×1.5	8	7	19	22	15.0	40.0	12	30	14	19	19	97	EL10LMEDOMD	500	315
	12	M 16×1.5	10	9	22	24	17.0	42.0	12	32	17	22	22	135	EL12LMEDOMD	400	315
	15	M 18×1.5	12	11	24	28	21.0	46.0	12	36	19	27	24	201	EL15LMEDOMD	400	315
	18	M 22×1.5	15	14	27	31	23.5	50.0	14	40	24	32	27	308	EL18LMEDOMD	400	315
	22	M 26×1.5	19	18	32	35	27.5	55.0	16	44	27	36	32	404	EL22LMEDOMD	250	160
	28	M 33×2.0	24	23	40	38	30.5	59.0	18	47	36	41	41	605	EL28LMEDOMD	250	160
	35	M 42×2.0	30	30	50	45	34.5	68.5	20	56	41	50	50	947	EL35LMEDOMD	250	160
	42	M 48×2.0	36	36	55	51	40.0	75.0	22	63	50	60	55	1497	EL42LMEDOMD	250	160
S <sup>4)</sup>	06	M 12×1.5	4	4	17	23	16.0	40.0	12	31	12	17	17	91	EL06SMEDOMD	800	630
	08	M 14×1.5	5	5	19	24	17.0	42.5	12	32	14	19	19	126	EL08SMEDOMD	800	630
	10	M 16×1.5	6	7	22	25	17.5	45.0	12	34	17	22	22	169	EL10SMEDOMD	800	630
	12	M 18×1.5	8	8	24	29	21.5	48.0	12	38	17	24	24	206	EL12SMEDOMD	630	630
	16	M 22×1.5	12	12	27	33	24.5	55.0	14	43	24	30	27	354	EL16SMEDOMD	630	400
	20	M 27×2.0	16	16	32	37	26.5	65.0	16	48	27	36	32	526	EL20SMEDOMD	420	400
	25	M 33×2.0	20	20	40	42	30.0	73.0	18	54	36	46	41	919	EL25SMEDOMD	420	400
	30	M 42×2.0	25	25	50	49	35.5	78.5	20	62	41	50	50	1328	EL30SMEDOMD	420	400
38	M 48×2.0	32	32	55	57	41.0	89.0	22	72	50	60	55	2039	EL38SMEDOMD	420	315	

<sup>1)</sup> Pressure shown = item deliverable

<sup>3)</sup> L = light series; <sup>4)</sup> S = heavy series

$$\frac{\text{PN (bar)}}{10} = \text{PN (MPa)}$$

Part numbers shown are body only level. To order with a nut and progressive ring (sleeve) included, please see pages D12 and D13 for part number ordering instructions. Instructions for ordering the fitting as EO-2 is also included on these pages.

\*Please add the suffixes below according to the material/surface required.

Order code suffixes			
Material	Suffix surface and material	Example	Standard sealing material (no additional suffix needed)
Steel, zinc plated, Cr(VI)-free	CF	EL16SMEDOMDCF	NBR
Stainless Steel	71	EL16SMEDOMD71	VIT

- TABLE OF CONTENTS
- VISUAL INDEX
- FAQs
- ASSEMBLY
- TUBE FAB EQUIP
- GEN TECH

[Click here for CADs, Support Resources or to Configure Parts Online](#)

# TH-R

High Pressure Banjo Tee  
24° Flareless / 24° Flareless / BSPP

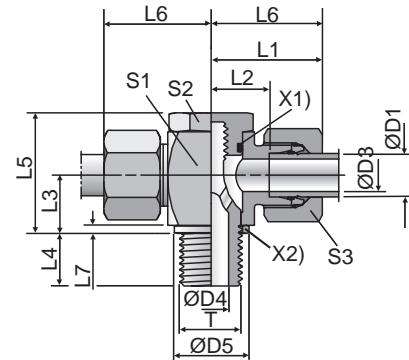

X1) O-ring OR  
X2) Sealing ring DKA

- TABLE OF CONTENTS
- VISUAL INDEX
- D
- FAQs
- ASSEMBLY
- TUBE FAB EQUIP
- GEN TECH

Series	D1	T	D3	D4	D5	L1	L2	L3	L4	L5	L6	L7	S1	S2	S3	Weight g/1 piece	Order code*	PN (bar) <sup>1)</sup>	
																		CF	71
L <sup>3)</sup>	06	G 1/8 A	4	4.5	14	19.0	12.0	10.5	8	24	27	2.5	17	17	14	58	TH06LROMD	250	250
	08	G 1/4 A	6	6.0	18	21.5	14.5	14.0	12	30	29	3.0	22	19	17	108	TH08LROMD	250	250
	10	G 1/4 A	8	6.0	18	22.5	15.5	14.0	12	30	30	3.0	22	19	19	110	TH10LROMD	250	250
	12	G 3/8 A	10	7.5	22	25.0	18.0	16.5	12	36	33	3.0	27	24	22	193	TH12LROMD	250	250
	15	G 1/2 A	12	11.0	26	28.5	21.5	21.5	14	45	37	4.5	32	30	27	321	TH15LROMD	250	250
	18	G 1/2 A	15	11.0	26	28.5	21.0	21.5	14	45	37	4.5	32	30	32	329	TH18LROMD	250	250
	22	G 3/4 A	19	17.0	32	35.0	27.5	24.0	16	53	44	3.5	41	36	36	584	TH22LROMD	160	160
	28	G 1 A	24	21.0	39	39.5	32.0	30.5	18	66	49	3.5	50	46	41	1090	TH28LROMD	160	160
	35	G 1 1/4 A	30	27.0	57	46.5	36.0	35.5	20	76	58	3.5	60	55	50	1766	TH35LROMD	160	160
	42	G 1 1/2 A	36	34.0	55	51.5	40.5	40.5	22	87	63	3.5	70	60	60	2544	TH42LROMD	160	160
S <sup>4)</sup>	06	G 1/4 A	4	6.0	18	23.5	16.5	14.0	12	30	31	3.0	22	19	17	116	TH06SROMD	315	315
	08	G 1/4 A	5	6.0	18	23.5	16.5	14.0	12	30	31	3.0	22	19	19	121	TH08SROMD	315	315
	10	G 3/8 A	7	7.5	22	26.0	18.5	16.5	12	36	35	3.0	27	24	22	201	TH10SROMD	315	315
	12	G 3/8 A	8	7.5	22	26.0	18.5	16.5	12	36	35	3.0	27	24	24	207	TH12SROMD	315	315
	16	G 1/2 A	12	11.0	26	30.5	22.0	21.5	14	45	40	4.5	32	30	30	350	TH16SROMD	315	315
	20	G 3/4 A	16	17.0	32	37.0	26.5	24.0	16	53	48	3.5	41	36	36	618	TH20SROMD	160	160
	25	G 1 A	20	21.0	39	43.5	31.5	30.5	18	66	56	3.5	50	46	46	1124	TH25SROMD	160	160
	30	G 1 1/4 A	25	27.0	49	50.5	37.0	35.5	20	76	64	3.5	60	55	50	1831	TH30SROMD	160	160
38	G 1 1/2 A	32	34.0	55	57.5	41.5	40.5	22	87	72	3.5	70	60	60	2720	TH38SROMD	160	160	

<sup>1)</sup> Pressure shown = item deliverable

<sup>3)</sup> L = light series; <sup>4)</sup> S = heavy series

$$\frac{\text{PN (bar)}}{10} = \text{PN (MPa)}$$

Part numbers shown are body only level. To order with a nut and progressive ring (sleeve) included, please see pages D12 and D13 for part number ordering instructions. Instructions for ordering the fitting as EO-2 is also included on these pages.

**WARNING:** This product can expose you to chemicals including Lead and Lead Compounds which is known to the State of California to cause cancer and birth defects or other reproductive harm. For more information go to [www.p65warnings.ca.gov](http://www.p65warnings.ca.gov).

Order code suffixes			
Material	Suffix surface and material	Example	Standard sealing material (no additional suffix needed)
Steel, zinc plated, Cr(VI)-free	CF	TH16SROMDCF	NBR
Stainless Steel	71	TH16SROMD71	VIT

\*Please add the suffixes below according to the material/surface required.

[Click here for CADs, Support Resources or to Configure Parts Online](#)

# TH-M

High Pressure Banjo Tee  
24° Flareless / 24° Flareless / Metric Parallel

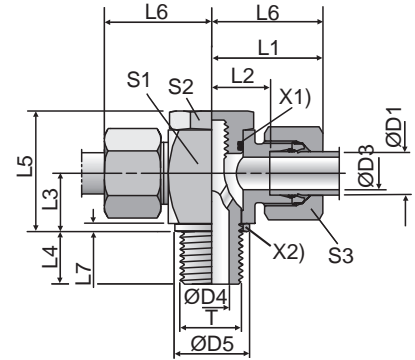

X1) O-ring OR  
X2) Sealing ring DKA

TABLE OF CONTENTS

VISUAL INDEX

FAQs

ASSEMBLY

TUBE FAB EQUIP

GEN TECH

Series	D1	T	D3	D4	D5	L1	L2	L3	L4	L5	L6	L7	S1	S2	S3	Weight g/1 piece	Order code*	PN (bar) <sup>1)</sup>	
																		CF	71
L <sup>3)</sup>	06	M 10×1.0	4	4.5	14	19.0	12.0	10.5	8	24.0	27	2.5	17	17	14	58	TH06LMOMD	250	250
	08	M 12×1.5	6	6.0	17	21.5	14.5	14.0	12	30.0	29	3.0	22	19	17	104	TH08LMOMD	250	250
	10	M 14×1.5	8	6.0	19	22.5	15.5	14.0	12	30.0	30	3.0	22	19	19	112	TH10LMOMD	250	250
	12	M 16×1.5	10	7.5	21	25.0	18.0	16.5	12	36.0	33	3.0	27	24	22	191	TH12LMOMD	250	250
	15	M 18×1.5	11	9.0	23	27.5	21.5	18.5	12	39.5	37	3.0	30	27	27	258	TH15LMOMD	250	250
	18	M 22×1.5	15	12.0	27	28.5	21.0	21.5	14	45.0	37	4.5	32	30	32	337	TH18LMOMD	250	250
	22	M 26×1.5	19	17.0	31	35.0	27.5	24.0	16	53.0	44	3.5	41	36	36	590	TH22LMOMD	160	160
	28	M 33×2.0	24	21.0	39	39.5	32.0	30.5	18	66.0	49	3.5	50	46	41	1072	TH28LMOMD	160	160
	35	M 42×2.0	30	27.0	49	46.5	36.0	35.5	20	76.0	58	3.5	60	55	50	1778	TH35LMOMD	160	160
	42	M 48×2.0	36	34.0	55	51.5	40.5	40.5	22	87.0	63	3.5	70	60	60	2565	TH42LMOMD	160	160
S <sup>4)</sup>	06	M 12×1.5	4	6.0	17	23.5	16.5	14.0	12	30.0	31	3.0	22	19	17	112	TH06SMOMD	315	315
	08	M 14×1.5	5	6.0	19	23.5	16.5	14.0	12	30.0	31	3.0	22	19	19	124	TH08SMOMD	315	315
	10	M 16×1.5	7	7.5	21	26.0	18.5	16.5	12	36.0	35	3.0	27	24	22	200	TH10SMOMD	315	315
	12	M 18×1.5	8	9.0	23	27.5	20.0	18.5	12	39.5	36	3.0	27	27	24	261	TH12SMOMD	315	315
	16	M 22×1.5	12	12.0	27	30.5	22.0	21.5	14	45.0	40	4.5	32	30	30	350	TH16SMOMD	315	315
	20	M 27×2.0	16	16.0	32	37.0	26.5	24.0	16	53.0	48	3.5	41	36	36	628	TH20SMOMD	160	160
	25	M 33×2.0	20	21.0	39	43.5	31.5	30.5	18	66.0	56	3.5	50	46	46	1106	TH25SMOMD	160	160
	30	M 42×2.0	25	27.0	49	50.5	37.0	35.5	20	76.0	64	3.5	60	55	50	1843	TH30SMOMD	160	160
	38	M 48×2.0	32	34.0	55	57.5	41.5	40.5	22	87.0	72	3.5	70	60	60	2741	TH38SMOMD	160	160

<sup>1)</sup> Pressure shown = item deliverable

<sup>3)</sup> L = light series; <sup>4)</sup> S = heavy series

$$\frac{\text{PN (bar)}}{10} = \text{PN (MPa)}$$

Part numbers shown are body only level. To order with a nut and progressive ring (sleeve) included, please see pages D12 and D13 for part number ordering instructions. Instructions for ordering the fitting as EO-2 is also included on these pages.

\*S1=SW30 in 1.4571

\*Please add the **suffixes** below according to the material/surface required.

Order code suffixes			
Material	Suffix surface and material	Example	Standard sealing material (no additional suffix needed)
Steel, zinc plated, Cr(VI)-free	CF	TH16SMOMDCF	NBR
Stainless Steel	71	TH16SMOMD71	VIT

[Click here for CADs, Support Resources or to Configure Parts Online](#)

# TH-R-KDS

High Pressure Banjo Tee

24° Flareless / 24° Flareless / BSPP

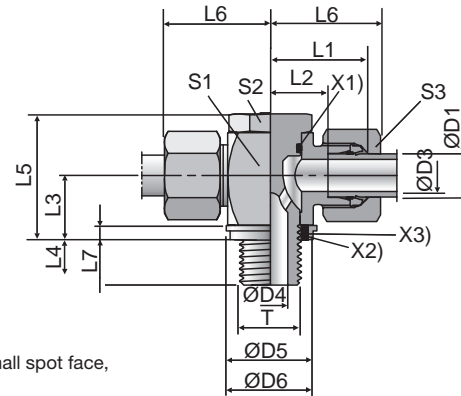

- X1) O-ring OR
- X2) Sealing ring KDS (for ports with small spot face, ISO 1179)
- X3) Sealing ring KD (for ports with wide spot face, ISO 1179)

Series	D1	T	D3	D4	D5 KDS	D6 KD	L1	L2	L3	L4	L5	L6	L7	S1	S2	S3	Weight g/1 piece	Order code*	PN (bar) <sup>1)</sup>	
																			CF	71
L <sup>3)</sup>	06	G 1/8 A	4	4.5	14.9	17	19.0	12.0	10.5	8	24	27	2.5	17	17	14	58	TH06LRKDSOMD	315	315
	08	G 1/4 A	6	6.0	18.9	22	21.5	14.5	14.0	12	30	29	3.0	22	19	17	108	TH08LRKDSOMD	315	315
	10	G 1/4 A	8	6.0	18.9	22	22.5	15.5	14.0	12	30	30	3.0	22	19	19	110	TH10LRKDSOMD	315	315
	12	G 3/8 A	10	7.5	21.9	27	25.0	18.0	16.5	12	36	33	3.0	27	24	22	193	TH12LRKDSOMD	315	315
	15	G 1/2 A	12	11.0	26.9	32	28.5	21.5	21.5	14	45	37	4.5	32	30	27	321	TH15LRKDSOMD	315	315
	18	G 1/2 A	15	11.0	26.9	32	28.5	21.0	21.5	14	45	37	4.5	32	30	32	329	TH18LRKDSOMD	315	315
	22	G 3/4 A	19	17.0	32.9	41	35.0	27.5	24.0	16	53	44	3.5	41	36	36	585	TH22LRKDSOMD	160	160
	28	G 1 A	24	21.0	39.9	46	39.5	32.0	30.5	18	66	49	3.5	50	46	41	1090	TH28LRKDSOMD	160	160
	35	G 1 1/4 A	30	27.0	49.9	57	46.5	36.0	35.5	20	76	58	3.5	60	55	50	1765	TH35LRKDSOMD	160	160
	42	G 1 1/2 A	36	34.0	55.9	64	51.5	40.5	40.5	22	87	63	3.5	70	60	60	2545	TH42LRKDSOMD	160	160
S <sup>4)</sup>	06	G 1/4 A	4	6.0	18.9	22	23.5	16.5	14.0	12	30	31	3.0	22	19	17	116	TH06SRKDSOMD	400	400
	08	G 1/4 A	5	6.0	18.9	22	23.5	16.5	14.0	12	30	31	3.0	22	19	19	121	TH08SRKDSOMD	400	400
	10	G 3/8 A	7	7.5	21.9	27	26.0	18.5	16.5	12	36	35	3.0	27	24	22	201	TH10SRKDSOMD	400	400
	12	G 3/8 A	8	7.5	21.9	27	26.0	18.5	16.5	12	36	35	3.0	27	24	24	207	TH12SRKDSOMD	400	400
	16	G 1/2 A	12	11.0	26.9	32	30.5	22.0	21.5	14	45	40	4.5	32	30	30	350	TH16SRKDSOMD	315	315
	20	G 3/4 A	16	17.0	32.9	41	37.0	26.5	24.0	16	53	48	3.5	41	36	36	620	TH20SRKDSOMD	315	315
	25	G 1 A	20	21.0	39.9	46	43.5	31.5	30.5	18	66	56	3.5	50	46	46	1124	TH25SRKDSOMD	250	250
	30	G 1 1/4 A	25	27.0	49.9	57	50.5	37.0	35.5	20	76	64	3.5	60	55	50	1830	TH30SRKDSOMD	160	160
38	G 1 1/2 A	32	34.0	55.9	64	57.5	41.5	40.5	22	87	72	3.5	70	60	60	2721	TH38SRKDSOMD	160	160	

<sup>1)</sup> Pressure shown = item deliverable

<sup>3)</sup> L = light series; <sup>4)</sup> S = heavy series

$\frac{PN (bar)}{10} = PN (MPa)$

Part numbers shown are body only level. To order with a nut and progressive ring (sleeve) included, please see pages D12 and D13 for part number ordering instructions. Instructions for ordering the fitting as EO-2 is also included on these pages.

**WARNING:** This product can expose you to chemicals including Lead and Lead Compounds which is known to the State of California to cause cancer and birth defects or other reproductive harm. For more information go to [www.p65warnings.ca.gov](http://www.p65warnings.ca.gov).

\*Please add the **suffixes** below according to the material/ surface required.

Order code suffixes			
Material	Suffix surface and material	Example	Standard sealing material (no additional suffix needed)
Steel, zinc plated, Cr(VI)-free	CF	TH16SRKDSOMDCF	NBR
Stainless Steel	71	TH16SRKDOMD71	VIT/PTFE

Stainless Steel only with sealing ring KD available!  
Replace KDS by KD in the order code.

TABLE OF CONTENTS

VISUAL INDEX

D

FAQs

ASSEMBLY

TUBE FAB EQUIP

GEN TECH

[Click here for CADs, Support Resources or to Configure Parts Online](#)

# TH-M-KDS

High Pressure Banjo Tee  
24° Flareless / 24° Flareless / Metric Parallel

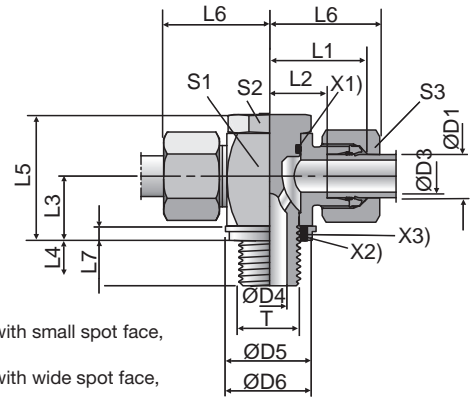

- X1) O-ring OR
- X2) Sealing ring KDS (for ports with small spot face, ISO 9974)
- X3) Sealing ring KD (for ports with wide spot face, ISO 9974)

Series	D1	T	D3	D4	D5 KDS	D6 KD	L1	L2	L3	L4	L5	L6	L7	S1	S2	S3	Weight g/1 piece	Order code*	PN (bar) <sup>1)</sup>	
																		CF	71	
L <sup>3)</sup>	06	M 10×1.0	4	4.5	14.9	17.0	19.0	12.0	10.5	8	24.0	27	2.5	17	17	14	59	TH06LMKDSOMD	315	315
	08	M 12×1.5	6	6.0	17.0	22.0	21.5	14.5	14.0	12	30.0	29	3.0	22	19	17	104	TH08LMKDSOMD	315	315
	10	M 14×1.5	8	6.0	18.9	22.5	22.5	15.5	14.0	12	30.0	30	3.0	22	19	19	112	TH10LMKDSOMD	315	315
	12	M 16×1.5	10	7.5	21.9	27.0	25.0	18.0	16.5	12	36.0	33	3.0	27	24	22	192	TH12LMKDSOMD	315	315
	15	M 18×1.5	11	9.0	23.9	29.0	27.5	21.5	18.5	12	39.5	37	3.0	30	27	27	258	TH15LMKDSOMD	315	315
	18	M 22×1.5	15	12.0	26.9	32.0	28.5	21.0	21.5	14	45.0	37	4.5	32	30	32	337	TH18LMKDSOMD	315	315
	22	M 26×1.5	19	17.0	31.9	41.0	35.0	27.5	24.0	16	53.0	44	3.5	41	36	36	589	TH22LMKDSOMD	160	160
	28	M 33×2.0	24	21.0	39.9	46.0	39.5	32.0	30.5	18	66.0	49	3.5	50	46	41	1072	TH28LMKDSOMD	160	160
	35	M 42×2.0	30	27.0	49.9	57.0	46.5	36.0	35.5	20	76.0	58	3.5	60	55	50	1778	TH35LMKDSOMD	160	160
	42	M 48×2.0	36	34.0	55.9	64.0	51.5	40.5	40.5	22	87.0	63	3.5	70	60	60	2566	TH42LMKDSOMD	160	160
S <sup>4)</sup>	06	M 12×1.5	4	6.0	17.0	22.0	23.5	16.5	14.0	12	30.0	31	3.0	22	19	17	112	TH06SMKDSOMD	400	400
	08	M 14×1.5	5	6.0	18.9	22.5	23.5	16.5	14.0	12	30.0	31	3.0	22	19	19	123	TH08SMKDSOMD	400	400
	10	M 16×1.5	7	7.5	21.9	27.0	26.0	18.5	16.5	12	36.0	35	3.0	27	24	22	200	TH10SMKDSOMD	400	400
	12	M 18×1.5	8	9.0	23.9	29.0	27.5	20.0	18.5	12	39.5	36	3.0	27	27	24	261	TH12SMKDSOMD	400	400
	16	M 22×1.5	12	12.0	26.9	32.0	30.5	22.0	21.5	14	45.0	40	4.5	32	30	30	351	TH16SMKDSOMD	315	315
	20	M 27×2.0	16	16.0	32.9	41.0	37.0	26.5	24.0	16	53.0	48	3.5	41	36	36	629	TH20SMKDSOMD	315	315
	25	M 33×2.0	20	21.0	39.9	46.0	43.5	31.5	30.5	18	66.0	56	3.5	50	46	46	1106	TH25SMKDSOMD	250	250
	30	M 42×2.0	25	27.0	49.9	57.0	50.5	37.0	35.5	20	76.0	64	3.5	60	55	50	1843	TH30SMKDSOMD	160	160
	38	M 48×2.0	32	34.0	55.9	64.0	57.5	41.5	40.5	22	87.0	72	3.5	70	60	60	2744	TH38SMKDSOMD	160	160

<sup>1)</sup> Pressure shown = item deliverable

<sup>3)</sup> L = light series; <sup>4)</sup> S = heavy series

$$\frac{PN(\text{bar})}{10} = PN(\text{MPa})$$

Part numbers shown are body only level. To order with a nut and progressive ring (sleeve) included, please see pages D12 and D13 for part number ordering instructions. Instructions for ordering the fitting as EO-2 is also included on these pages.

\*S1=SW30 in 1.4571

\*Please add the **suffixes** below according to the material/ surface required.

Order code suffixes			
Material	Suffix surface and material	Example	Standard sealing material (no additional suffix needed)
Steel, zinc plated, Cr(VI)-free	CF	TH16SMKDSOMDCF	NBR
Stainless Steel	71	TH16SMKDOMD71	VIT/PTFE

Stainless Steel only with sealing ring **KD** available!  
Replace KDS by **KD** in the order code.

TABLE OF CONTENTS

VISUAL INDEX

FAQs

ASSEMBLY

TUBE FAB EQUIP

GEN TECH



[Click here for CADs, Support Resources or to Configure Parts Online](#)

**K**  
Union Cross  
24° Flareless

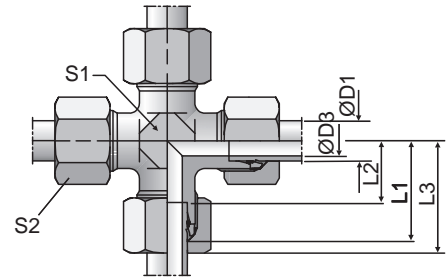

TABLE OF CONTENTS

VISUAL INDEX

D

FAQs

ASSEMBLY

TUBE FAB EQUIP

GEN TECH

Series	D1	D3	L1	L2	L3	S1	S2	Weight g/1 piece	Order code*	PN (bar) <sup>1)</sup>			
										CF	71	MS	
LL <sup>2)</sup>	04	3.0	15	11.0	21	9	10	13	K04LL	100	100	63	
	06	4.5	15	9.5	21	9	12	14	K06LL	100	100	63	
	08	6.0	17	11.5	23	12	14	24	K08LL	100	100	63	
L <sup>3)</sup>	06	4.0	19	12.0	27	12	14	35	K06L	315	315	200	
	08	6.0	21	14.0	29	12	17	40	K08L	315	315	200	
	10	8.0	22	15.0	30	14	19	52	K10L	315	315	200	
	12	10.0	24	17.0	32	17	22	69	K12L	315	315	200	
	15	12.0	28	21.0	36	19	27	130	K15L	315	315	200	
	18	15.0	31	23.5	40	24	32	188	K18L	315	315	200	
	22	19.0	35	27.5	44	27	36	251	K22L	160	160	100	
	28	24.0	38	30.5	47	36	41	392	K28L	160	160	100	
	35	30.0	45	34.5	56	41	50	618	K35L	160	160	100	
	42	36.0	51	40.0	63	50	60	905	K42L	160	160	100	
	S <sup>4)</sup>	06	4.0	23	16.0	31	12	17	58	K06S	630	630	400
		08	5.0	24	17.0	32	14	19	82	K08S	630	630	400
10		7.0	25	17.5	34	17	22	97	K10S	630	630	400	
12		8.0	29	21.5	38	17	24	146	K12S	630	630	400	
16		12.0	33	24.5	43	24	30	220	K16S	400	400	250	
20		16.0	37	26.5	48	27	36	339	K20S	315	315	200	
25		20.0	42	30.0	54	36	46	576	K25S	315	315	200	
30		25.0	49	35.5	62	41	50	843	K30S	315	315	200	
38		32.0	57	41.0	72	50	60	1350	K38S	315	315	200	

<sup>1)</sup> Pressure shown = item deliverable

<sup>2)</sup> LL = very light series; <sup>3)</sup> L = light series; <sup>4)</sup> S = heavy series

$$\frac{\text{PN (bar)}}{10} = \text{PN (MPa)}$$

Part numbers shown are body only level. To order with a nut and progressive ring (sleeve) included, please see pages D12 and D13 for part number ordering instructions. Instructions for ordering the fitting as EO-2 is also included on these pages.

**WARNING:** This product can expose you to chemicals including Lead and Lead Compounds which is known to the State of California to cause cancer and birth defects or other reproductive harm. For more information go to [www.p65warnings.ca.gov](http://www.p65warnings.ca.gov).

Order code suffixes		
Material	Suffix surface and material	Example
Steel, zinc plated, Cr(VI)-free	CFX	K16SCFX
Stainless Steel	71X	K16S71X
Brass	MSX	K16SMSX

[Click here for CADs, Support Resources or to Configure Parts Online](#)

# VKA

Cap

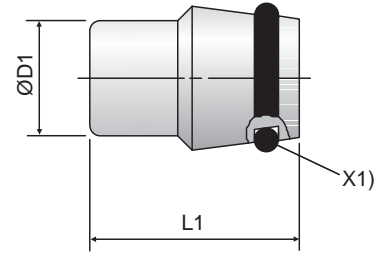

X1) O-ring OR

TABLE OF CONTENTS

VISUAL INDEX

FAQs

ASSEMBLY

TUBE FAB EQUIP

GEN TECH

Series	D1	L1	Weight g/1 piece	Order code*	PN (bar) <sup>1)</sup>		
					CF	71	MS
L <sup>3)</sup>	06	18.5	6	VKA06	500	315	200
	08	18.5	9	VKA08	500	315	200
	10	20.0	15	VKA10	500	315	200
	12	20.5	21	VKA12	400	315	200
	15	20.5	32	VKA15	400	315	200
	18	22.5	49	VKA18	400	315	200
	22	25.0	80	VKA22	250	160	100
	28	25.5	131	VKA28	250	160	100
	35	30.0	240	VKA35	250	160	100
	42	30.0	343	VKA42	250	160	100
S <sup>4)</sup>	06	18.5	6	VKA06	800	630	400
	08	18.5	9	VKA08	800	630	400
	10	20.0	15	VKA10	800	630	400
	12	20.5	21	VKA12	630	630	400
	16	23.5	40	VKA16	630	400	250
	20	28.5	78	VKA20	420	400	250
	25	29.0	120	VKA25	420	400	250
	30	30.5	180	VKA30	420	400	250
	38	33.0	309	VKA38	420	315	200

<sup>1)</sup> Pressure shown = item deliverable

<sup>3)</sup> L = light series; <sup>4)</sup> S = heavy series

$$\frac{\text{PN (bar)}}{10} = \text{PN (MPa)}$$

**WARNING:** This product can expose you to chemicals including Lead and Lead Compounds which is known to the State of California to cause cancer and birth defects or other reproductive harm. For more information go to [www.p65warnings.ca.gov](http://www.p65warnings.ca.gov).

Order code suffixes			
Material	Suffix surface and material	Example	Standard sealing material (no additional suffix needed)
Steel, zinc plated, Cr(VI)-free	CF	VKA16CF	NBR
Stainless Steel	71	VKA1671	VIT
Brass	MS	VKA16MS	NBR

\*Please add the **suffixes** below according to the material/surface required.

[Click here for CADs, Support Resources or to Configure Parts Online](#)

# ROV

Plug  
24° Flareless

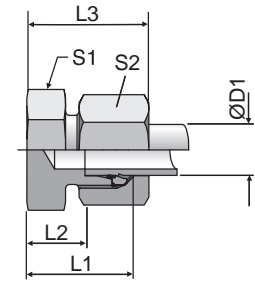

TABLE OF CONTENTS

VISUAL INDEX

D

FAQs

ASSEMBLY

TUBE FAB EQUIP

GEN TECH

Series	D1	L1	L2	L3	S1	S2	Weight g/1 piece	Order code*	PN (bar) <sup>1)</sup>	
									CF	71
L <sup>3)</sup>	06	14	7.0	22	12	14	8	ROV06L	315	315
	08	15	8.0	23	14	17	13	ROV08L	315	315
	10	16	9.0	24	17	19	17	ROV10L	315	315
	12	17	10.0	25	19	22	24	ROV12L	315	315
	15	18	11.0	26	24	27	41	ROV15L	315	315
	18	19	11.5	28	27	32	56	ROV18L	315	315
	22	21	13.5	30	32	36	84	ROV22L	160	160
	28	22	14.5	31	41	41	138	ROV28L	160	160
	35	25	14.5	36	46	50	203	ROV35L	160	160
	42	27	16.0	39	55	60	318	ROV42L	160	160
	S <sup>4)</sup>	06	18	11.0	26	14	17	17	ROV06S	630
08		20	13.0	28	17	19	28	ROV08S	630	630
10		20	12.5	29	19	22	33	ROV10S	630	630
12		22	14.5	31	22	24	50	ROV12S	630	630
16		24	15.5	34	27	30	75	ROV16S	400	400
20		28	17.5	39	32	36	125	ROV20S	400	400
25		32	20.0	44	41	46	229	ROV25S	400	400
30		34	20.5	47	46	50	310	ROV30S	400	400
38		39	23.0	54	55	60	508	ROV38S	315	315

<sup>1)</sup> Pressure shown = item deliverable

<sup>3)</sup> L = light series; <sup>4)</sup> S = heavy series

$$\frac{\text{PN (bar)}}{10} = \text{PN (MPa)}$$

Part numbers shown are body only level. To order with a nut and progressive ring (sleeve) included, please see pages D12 and D13 for part number ordering instructions. Instructions for ordering the fitting as EO-2 is also included on these pages.

**WARNING:** This product can expose you to chemicals including Lead and Lead Compounds which is known to the State of California to cause cancer and birth defects or other reproductive harm. For more information go to [www.p65warnings.ca.gov](http://www.p65warnings.ca.gov).

Order code suffixes		
Material	Suffix surface and material	Example
Steel, zinc plated, Cr(VI)-free	CFX	ROV16SCFX
Stainless Steel	71X	ROV16S71X

\*Please add the suffixes below according to the material/surface required.

[Click here for CADs, Support Resources or to Configure Parts Online](#)

# VKAM

Blanking Plug

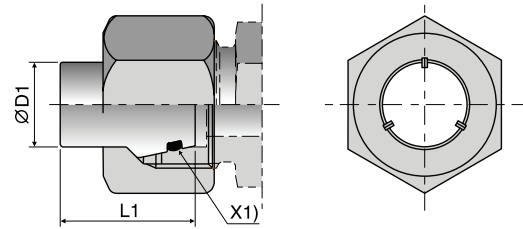

X1) O-ring OR

TABLE OF CONTENTS

VISUAL INDEX

FAQs

ASSEMBLY

TUBE FAB EQUIP

GEN TECH

Series	D1 	L1	Weight g/1 piece	Order code*	PN (bar) <sup>1)</sup>	
					CF	71
L <sup>3)</sup>	06	18.5	15	VKAM06L	500	315
	08	18.5	24	VKAM08L	500	315
	10	20.0	33	VKAM10L	500	315
	12	20.5	46	VKAM12L	400	315
	15	20.5	73	VKAM15L	400	315
	18	22.5	111	VKAM18L	400	315
	22	25.0	162	VKAM22L	250	160
	28	25.5	220	VKAM28L	250	160
	35	30.0	376	VKAM35L	250	160
	42	30.0	558	VKAM42L	250	160
S <sup>4)</sup>	06	18.5	23	VKAM06S	800	630
	08	18.5	29	VKAM08S	800	630
	10	20.0	46	VKAM10S	800	630
	12	20.5	55	VKAM12S	630	630
	16	23.5	106	VKAM16S	630	400
	20	28.5	180	VKAM20S	420	400
	25	29.0	322	VKAM25S	420	400
	30	30.5	398	VKAM30S	420	400
	38	33.0	647	VKAM38S	420	315

<sup>1)</sup> Pressure shown = item deliverable

<sup>3)</sup> L = light series; <sup>4)</sup> S = heavy series

$$\frac{PN \text{ (bar)}}{10} = PN \text{ (MPa)}$$

**WARNING:** This product can expose you to chemicals including Lead and Lead Compounds which is known to the State of California to cause cancer and birth defects or other reproductive harm. For more information go to [www.p65warnings.ca.gov](http://www.p65warnings.ca.gov).

\*Please add the **suffixes** below according to the material/surface required.

Order code suffixes			
Material	Suffix surface and material	Example	Standard sealing material (no additional suffix needed)
Steel, zinc plated, Cr(VI)-free	CF	VKAM16SCF	NBR
Stainless Steel	71	VKAM16S71	VIT

[Click here for CADs, Support Resources or to Configure Parts Online](#)

# DVGE-R

Plain Bearing Rotary Straight  
24° Flareless / BSPP with EOlastic Seal\*

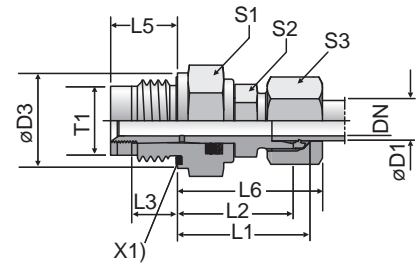

X1) Eolastic-sealing

L8 larger than DIN 3852  
chart page Q22

Series	D1	T1	DN	D3	L1	L2	L3	L5	L6	S1	S2	S3	Weight g/1 piece	Order code*	PN (bar) <sup>1)</sup>	
															CF	VIT
L <sup>3)</sup>	06	G 1/4 A	4.0	19	28.0	21.0	12	18.0	40	19	12	14	43	DVGE06LROMD	40	40
	08	G 1/4 A	5.0	19	28.0	21.0	12	18.0	40	19	14	17	44	DVGE08LROMD	40	40
	10	G 3/8 A	6.0	22	32.0	25.0	12	18.0	40	24	17	19	74	DVGE10LROMD	40	40
	12	G 1/2 A	8.0	27	34.0	27.0	14	21.0	42	27	19	22	116	DVGE12LROMD	40	40
	15	G 3/4 A	10.0	32	39.0	32.0	16	24.0	47	32	24	27	214	DVGE15LROMD	40	40
	18	G 1 A	16.0	40	42.5	35.0	18	27.5	51	41	27	32	337	DVGE18LROMD	40	40
	22	G 1 A	16.0	40	46.5	39.0	18	27.5	55	41	32	36	376	DVGE22LROMD	40	40
	28	G 1 1/4 A	22.0	50	48.0	40.5	20	31.0	57	50	41	41	586	DVGE28LROMD	40	40
	35	G 1 1/2 A	25.0	55	55.0	44.5	22	35.0	66	55	46	50	868	DVGE35LROMD	40	40
S <sup>4)</sup>	06	G 1/4 A	4.0	19	30.0	23.0	12	18.0	38	19	14	17	50	DVGE06SROMD	100	100
	08	G 1/4 A	5.0	19	31.0	24.0	12	18.0	39	19	17	19	55	DVGE08SROMD	100	100
	10	G 3/8 A	6.0	22	34.0	26.5	12	18.0	43	24	19	22	85	DVGE10SROMD	100	100
	12	G 1/2 A	8.0	27	36.0	28.5	14	21.0	45	27	22	24	134	DVGE12SROMD	100	100
	14	G 3/4 A	10.0	32	41.0	33.0	16	24.0	51	32	24	27	220	DVGE14SROMD	100	100
	16	G 3/4 A	10.0	32	42.0	33.5	16	24.0	52	32	27	30	230	DVGE16SROMD	100	100
	20	G 1 A	16.0	40	48.5	38.0	18	27.5	60	41	32	36	385	DVGE20SROMD	100	100
	25	G 1 A	16.0	40	52.5	40.5	18	27.5	65	41	41	46	483	DVGE25SROMD	100	100
	30	G 1 1/4 A	22.0	50	55.0	41.5	20	31.0	68	50	46	50	691	DVGE30SROMD	100	100
38	G 1 1/2 A	25.0	55	63.0	47.0	22	35.0	78	55	55	60	1080	DVGE38SROMD	100	100	

<sup>1)</sup>Pressure shown = item deliverable

<sup>3)</sup>L = light series; <sup>4)</sup>S = heavy series

$$\frac{\text{PN (bar)}}{10} = \text{PN (MPa)}$$

Part numbers shown are body only level. To order with a nut and progressive ring (sleeve) included, please see pages D12 and D13 for part number ordering instructions. Instructions for ordering the fitting as EO-2 is also included on these pages.

**WARNING:** This product can expose you to chemicals including Lead and Lead Compounds which is known to the State of California to cause cancer and birth defects or other reproductive harm. For more information go to [www.p65warnings.ca.gov](http://www.p65warnings.ca.gov).

\*Please add the suffixes below according to the material/surface required.

Order code suffixes			
Material	Suffix surface and material	Example	Standard sealing material (no additional suffix needed)
Steel, zinc plated, Cr(VI)-free	CF	DVGE06LROMDCF	NBR
FKM	VITCF	DVGE06LROMDVITCF	

TABLE OF CONTENTS

VISUAL INDEX

D

FAQs

ASSEMBLY

TUBE FAB EQUIP

GEN TECH



[Click here for CADs, Support Resources or to Configure Parts Online](#)

# DVGE-M

Plain Bearing Rotary Straight  
24° Flareless / Metric Parallel with EOlastic Seal\*

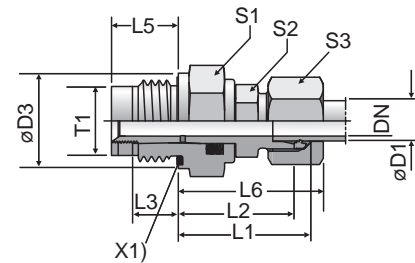

X1) Elastomeric-sealing

L8 larger than DIN 3852  
chart page Q22

Series	D1	T1	DN	D3	L1	L2	L3	L5	L6	S1	S2	S3	Weight g/1 piece	Order code*	PN (bar) <sup>1)</sup>	
															CF	VIT
L <sup>3)</sup>	06	M 14×1.5	4.0	19	27.0	20.0	12	18.0	27	19	12	14	44	DVGE06LMOMD	40	40
	08	M 14×1.5	5.0	19	28.0	21.0	12	18.0	29	19	12	17	45	DVGE08LMOMD	40	40
	10	M 18×1.5	6.0	24	33.0	26.0	12	18.0	30	24	14	19	87	DVGE10LMOMD	40	40
	12	M 22×1.5	8.0	27	34.0	27.0	14	21.0	32	27	17	22	120	DVGE12LMOMD	40	40
	15	M 27×2.0	10.0	32	40.0	33.0	16	24.0	36	32	19	27	215	DVGE15LMOMD	40	40
	18	M 33×2.0	16.0	40	45.0	37.5	18	27.5	40	41	27	32	349	DVGE18LMOMD	40	40
	22	M 33×2.0	16.0	40	47.0	39.5	18	27.5	44	41	27	36	383	DVGE22LMOMD	40	40
	28	M 42×2.0	22.0	50	51.5	44.0	20	31.0	47	50	36	41	590	DVGE28LMOMD	40	40
	35	M 48×2.0	25.0	55	64.5	54.0	22	35.0	56	55	41	50	876	DVGE35LMOMD	40	40
	S <sup>4)</sup>	06	M 14×1.5	4.0	19	28.0	21.0	12	18.0	31	19	12	17	51	DVGE06SMOMD	100
08		M 14×1.5	5.0	19	29.0	22.0	12	18.0	32	19	14	19	56	DVGE08SMOMD	100	100
10		M 18×1.5	6.0	24	34.5	27.0	12	18.0	34	24	17	22	98	DVGE10SMOMD	100	100
12		M 22×1.5	8.0	27	35.5	28.0	14	21.0	38	27	17	24	139	DVGE12SMOMD	100	100
16		M 27×2.0	10.0	32	42.5	34.0	16	24.0	43	32	24	30	239	DVGE16SMOMD	100	100
20		M 33×2.0	16.0	40	50.0	39.5	18	27.5	48	41	27	36	385	DVGE20SMOMD	100	100
25		M 33×2.0	16.0	40	54.5	42.5	18	27.5	54	41	36	46	494	DVGE25SMOMD	100	100
30		M 42×2.0	22.0	50	61.5	48.0	20	31.0	62	50	41	50	695	DVGE30SMOMD	100	100
38	M 48×2.0	25.0	55	71.0	55.0	22	35.0	72	55	50	60	1088	DVGE38SMOMD	100	100	

<sup>1)</sup> Pressure shown = item deliverable

<sup>3)</sup> L = light series; <sup>4)</sup> S = heavy series

$$\frac{PN \text{ (bar)}}{10} = PN \text{ (MPa)}$$

Part numbers shown are body only level. To order with a nut and progressive ring (sleeve) included, please see pages D12 and D13 for part number ordering instructions. Instructions for ordering the fitting as EO-2 is also included on these pages.

\*Please add the suffixes below according to the material/surface required.

Order code suffixes			
Material	Suffix surface and material	Example	Standard sealing material (no additional suffix needed)
Steel, zinc plated, Cr(VI)-free	CF	DVGE06LMOMDCF	NBR
FKM	VITCF	DVGE06LMOMDVITCF	

[Click here for CADs, Support Resources or to Configure Parts Online](#)

# DVWE-R

Plain Bearing Rotary Elbow  
24° Flareless / BSPP with EOlastic Seal\*

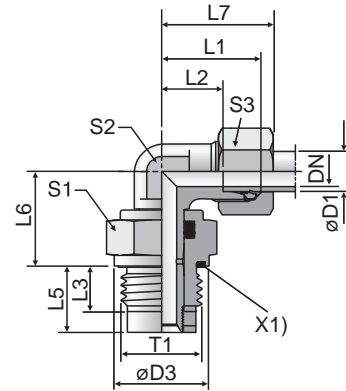

X1) Eolastic-sealing

L8 larger than DIN 3852  
chart page Q22

Series	D1	T1	DN	D3	L1	L2	L3	L5	L6	L7	S1	S2	S3	Weight g/1 piece	Order code*	PN (bar) <sup>1)</sup>	
																CF	VIT
L <sup>3)</sup>	06	G 1/4 A	4	19	19	12.0	12	18.0	20.0	27	19	12	14	50	DVWE06LROMD	40	40
	08	G 1/4 A	5	19	21	14.0	12	18.0	21.0	29	19	12	17	50	DVWE08LROMD	40	40
	10	G 3/8 A	6	22	22	15.0	12	18.0	26.0	30	24	14	19	83	DVWE10LROMD	40	40
	12	G 1/2 A	8	27	24	17.0	14	21.0	27.0	32	27	17	22	129	DVWE12LROMD	40	40
	15	G 3/4 A	10	32	28	21.0	16	24.0	33.0	36	32	19	27	232	DVWE15LROMD	40	40
	18	G 1 A	16	40	31	23.5	18	27.5	37.5	40	41	27	32	393	DVWE18LROMD	40	40
	22	G 1 A	16	40	35	27.5	18	27.5	39.5	44	41	27	36	406	DVWE22LROMD	40	40
	28	G 1 1/4 A	22	50	38	30.5	20	31.0	44.0	47	50	36	41	664	DVWE28LROMD	40	40
	35	G 1 1/2 A	25	55	45	34.5	22	35.0	54.0	56	55	41	50	1005	DVWE35LROMD	40	40
S <sup>4)</sup>	06	G 1/4 A	4	19	23	16.0	12	18.0	21.0	31	19	12	17	58	DVWE06SROMD	100	100
	08	G 1/4 A	5	19	24	17.0	12	18.0	22.0	32	19	14	19	65	DVWE08SROMD	100	100
	10	G 3/8 A	6	22	25	17.5	12	18.0	27.0	34	24	17	22	103	DVWE10SROMD	100	100
	12	G 1/2 A	8	27	29	21.5	14	21.0	28.0	38	27	17	24	152	DVWE12SROMD	100	100
	14	G 3/4 A	10	32	30	22.0	16	24.0	33.0	40	32	19	27	236	DVWE14SROMD	100	100
	16	G 3/4 A	10	32	33	24.5	16	24.0	34.0	43	32	24	30	276	DVWE16SROMD	100	100
	20	G 1 A	16	40	37	26.5	18	27.5	39.5	48	41	27	36	415	DVWE20SROMD	100	100
	25	G 1 A	16	40	42	30.0	18	27.5	42.5	54	41	36	46	569	DVWE25SROMD	100	100
	30	G 1 1/4 A	22	50	49	35.5	20	31.0	48.0	62	50	41	50	886	DVWE30SROMD	100	100
	38	G 1 1/2 A	25	55	57	41.0	22	35.0	55.0	72	55	50	60	1375	DVWE38SROMD	100	100

<sup>1)</sup> Pressure shown = item deliverable

<sup>3)</sup> L = light series; <sup>4)</sup> S = heavy series

$$\frac{\text{PN (bar)}}{10} = \text{PN (MPa)}$$

Part numbers shown are body only level. To order with a nut and progressive ring (sleeve) included, please see pages D12 and D13 for part number ordering instructions. Instructions for ordering the fitting as EO-2 is also included on these pages.

**WARNING:** This product can expose you to chemicals including Lead and Lead Compounds which is known to the State of California to cause cancer and birth defects or other reproductive harm. For more information go to [www.p65warnings.ca.gov](http://www.p65warnings.ca.gov).

Order code suffixes			
Material	Suffix surface and material	Example	Standard sealing material (no additional suffix needed)
Steel, zinc plated, Cr(VI)-free	CF	DVWE06LROMDCF	NBR
FKM	VITCF	DVWE06LROMDVITCF	

\*Please add the suffixes below according to the material/surface required.

TABLE OF CONTENTS

VISUAL INDEX

D

FAQs

ASSEMBLY

TUBE FAB EQUIP

GEN TECH

[Click here for CADs, Support Resources or to Configure Parts Online](#)

# DVWE-M

Plain Bearing Rotary Elbow  
24° Flareless / Metric Parallel with EOlastic Seal\*

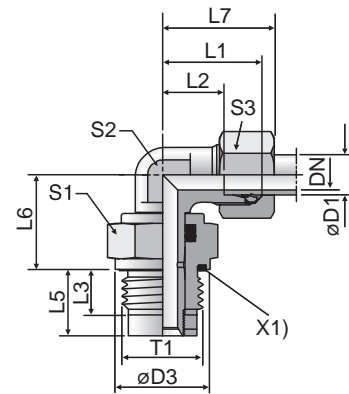

X1) Eolastic-sealing L8 larger than DIN 3852 chart page Q22

- TABLE OF CONTENTS
- VISUAL INDEX
- FAQs
- ASSEMBLY
- TUBE FAB EQUIP
- GEN TECH

Series	D1	T1	DN	D3	L1	L2	L3	L5	L6	L7	S1	S2	S3	Weight g/1 piece	Order code*	PN (bar) <sup>1)</sup>	
																CF	VIT
L <sup>3)</sup>	06	M 14×1.5	4.0	19	19	12.0	12	18.0	20.0	27	19	12	14	51	DVWE06LMOMD	40	40
	08	M 14×1.5	5.0	19	21	14.0	12	18.0	21.0	29	19	12	17	51	DVWE08LMOMD	40	40
	10	M 18×1.5	6.0	24	22	15.0	12	18.0	26.0	30	24	14	19	92	DVWE10LMOMD	40	40
	12	M 22×1.5	8.0	27	24	17.0	14	21.0	27.0	32	27	17	22	160	DVWE12LMOMD	40	40
	15	M 27×2.0	10.0	32	28	21.0	16	24.0	33.0	36	32	19	27	236	DVWE15LMOMD	40	40
	18	M 33×2.0	16.0	40	31	23.5	18	27.5	37.5	40	41	27	32	405	DVWE18LMOMD	40	40
	22	M 33×2.0	16.0	40	35	27.5	18	27.5	39.5	44	41	27	36	409	DVWE22LMOMD	40	40
	28	M 42×2.0	22.0	50	38	30.5	20	31.0	44.0	47	50	36	41	660	DVWE28LMOMD	40	40
	35	M 48×2.0	25.0	55	45	34.5	22	35.0	54.0	56	55	41	50	1012	DVWE35LMOMD	40	40
S <sup>4)</sup>	06	M 14×1.5	4.0	19	23	16.0	12	18.0	21.0	31	19	12	17	59	DVWE06SMOMD	100	100
	08	M 14×1.5	5.0	19	24	17.0	12	18.0	22.0	32	19	14	19	66	DVWE08SMOMD	100	100
	10	M 18×1.5	6.0	24	25	17.5	12	18.0	27.0	34	24	17	22	113	DVWE10SMOMD	100	100
	12	M 22×1.5	8.0	27	29	21.5	14	21.0	28.0	38	27	17	24	153	DVWE12SMOMD	100	100
	16	M 27×2.0	10.0	32	33	24.5	16	24.0	34.0	43	32	24	30	284	DVWE16SMOMD	100	100
	20	M 33×2.0	16.0	40	37	26.5	18	27.5	39.5	48	41	27	36	427	DVWE20SMOMD	100	100
	25	M 33×2.0	16.0	40	42	30.0	18	27.5	42.5	54	41	36	46	581	DVWE25SMOMD	100	100
	30	M 42×2.0	22.0	50	49	35.5	20	31.0	48.0	62	50	41	50	898	DVWE30SMOMD	100	100
	38	M 48×2.0	25.0	55	57	41.0	22	35.0	55.0	72	55	50	60	1373	DVWE38SMOMD	100	100

<sup>1)</sup> Pressure shown = item deliverable

<sup>3)</sup> L = light series; <sup>4)</sup> S = heavy series

$$\frac{\text{PN (bar)}}{10} = \text{PN (MPa)}$$

Part numbers shown are body only level. To order with a nut and progressive ring (sleeve) included, please see pages D12 and D13 for part number ordering instructions. Instructions for ordering the fitting as EO-2 is also included on these pages.

\*Please add the **suffixes** below according to the material/surface required.

Order code suffixes			
Material	Suffix surface and material	Example	Standard sealing material (no additional suffix needed)
Steel, zinc plated, Cr(VI)-free	CF	DVWE06LMOMDCF	NBR
FKM	VITCF	DVWE06LMOMDVITCF	

[Click here for CADs, Support Resources or to Configure Parts Online](#)

# DG101

Ball Bearing Rotary Union  
24° Flareless / 24° Flareless

**Read more about the new generation Heavy Duty 360° Series Ball Bearing Rotary Fittings**

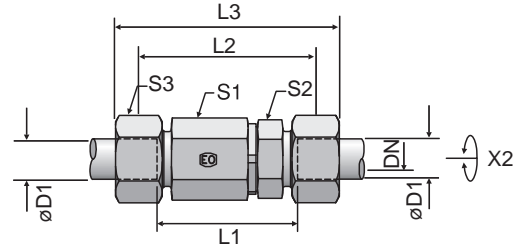

X2) Axis

TABLE OF CONTENTS

VISUAL INDEX

D

FAQs

ASSEMBLY

TUBE FAB EQUIP

GEN TECH

Series	D1	DN	L1	L2	L3	S1	S2	S3	Weight g/1 piece	Order code*	PN Bar <sup>1)</sup>
S <sup>4)</sup>	06	5.0	61	47	76	22.0	17	17.0	113	DG101/06SHDOMDCF	420
	08	5.0	61	47	76	22.0	17	19.0	118	DG101/08SHDOMDCF	420
	12	9.5	72	57	89	30.0	24	24.0	258	DG101/12SHDOMDCF	420
	16	9.5	74	57	93	30.0	27	30.0	264	DG101/16SHDOMDCF	420
	20	16.0	92	71	114	41.0	36	36.0	578	DG101/20SHDOMDCF	420
	25	16.0	96	72	120	41.0	41	46.0	652	DG101/25SHDOMDCF	420
	30	26.0	109	82	135	60.0	46	50.0	1321	DG101/30SHDOMDCF	420
	38	26.0	114	82	143	60.0	55	60.0	1509	DG101/38SHDOMDCF	420

<sup>1)</sup> Pressure shown = item deliverable

<sup>4)</sup> S = heavy series

$$\frac{\text{PN (bar)}}{10} = \text{PN (MPa)}$$

Part numbers shown are body only level. To order with a nut and progressive ring (sleeve) included, please see pages D12 and D13 for part number ordering instructions. Instructions for ordering the fitting as EO-2 is also included on these pages.

**WARNING:** This product can expose you to chemicals including Lead and Lead Compounds which is known to the State of California to cause cancer and birth defects or other reproductive harm. For more information go to [www.p65warnings.ca.gov](http://www.p65warnings.ca.gov).

[Click here for CADs, Support Resources or to Configure Parts Online](#)

# DG103

Ball Bearing Rotary Elbow  
24° Flareless / 24° Flareless

*Read more about the new generation Heavy Duty 360° Series Ball Bearing Rotary Fittings*

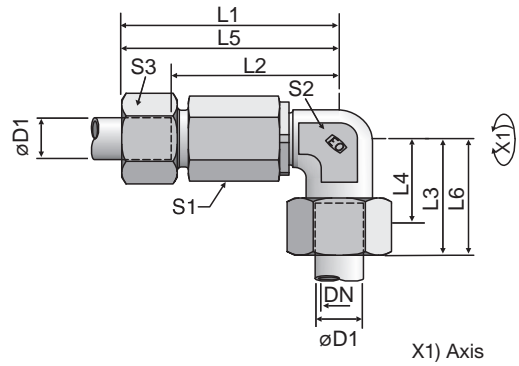

TABLE OF CONTENTS

VISUAL INDEX

FAQs

ASSEMBLY

TUBE FAB EQUIP

GEN TECH

Series	D1	DN	L1	L2	L3	L4	L5	L6	S1	S2	S3	Weight g/1 piece	Order code*	PN Bar <sup>1)</sup>
S <sup>4)</sup>	06	5.0	51.5	59.0	23	16.0	44.5	16.0	22	17	17	134	DG103/06SHDOMDCF	420
	08	5.0	51.5	59.0	24	17.0	44.5	17.0	22	17	19	141	DG103/08SHDOMDCF	420
	12	9.5	63.0	72.0	29	21.5	55.5	21.5	30	22	24	296	DG103/12SHDOMDCF	420
	16	9.5	63.0	73.0	33	24.5	54.5	24.5	30	22	30	298	DG103/16SHDOMDCF	420
	20	16.0	83.0	94.5	37	26.5	72.5	26.5	41	36	36	772	DG103/20SHDOMDCF	420
	25	16.0	83.0	95.5	42	30.0	71.0	30.0	41	36	46	803	DG103/25SHDOMDCF	420
	30	26.0	102.5	116.0	49	35.5	89.0	35.5	60	50	50	1722	DG103/30SHDOMDCF	420
	38	26.0	102.5	117.0	57	41.0	86.5	41.0	60	50	60	1931	DG103/38SHDOMDCF	420

<sup>1)</sup> Pressure shown = item deliverable

<sup>4)</sup> S = heavy series

$$\frac{\text{PN (bar)}}{10} = \text{PN (MPa)}$$

Part numbers shown are body only level. To order with a nut and progressive ring (sleeve) included, please see pages D12 and D13 for part number ordering instructions. Instructions for ordering the fitting as EO-2 is also included on these pages.

**WARNING:** This product can expose you to chemicals including Lead and Lead Compounds which is known to the State of California to cause cancer and birth defects or other reproductive harm. For more information go to [www.p65warnings.ca.gov](http://www.p65warnings.ca.gov).



[Click here for CADs, Support Resources or to Configure Parts Online](#)

# DG105

Ball Bearing Rotary Union  
24° Flareless / 24° Flareless

*Read more about the new generation Heavy Duty 360° Series Ball Bearing Rotary Fittings*

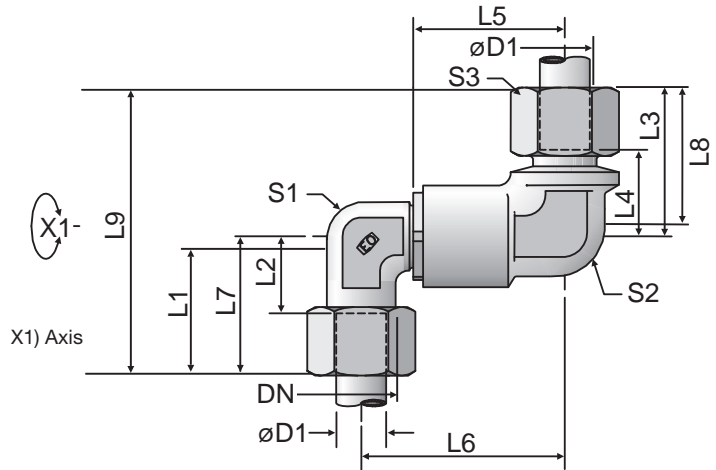

- TABLE OF CONTENTS
- VISUAL INDEX
- D
- FAQs
- ASSEMBLY
- TUBE FAB EQUIP
- GEN TECH

Series	D1	DN	L1	L2	L3	L4	L5	L6	L7	L8	L9	S1	S2	S3	Weight g/1 piece	Order code*	PN Bar <sup>1)</sup>
S <sup>4)</sup>	12	9.5	39.5	26.5	43	21.5	38	81	53.0	24	22	24	29	50.5	384	DG105/12SHDOMDCF	420
	16	9.5	39.5	25.5	44	24.5	43	87	53.0	30	22	24	33	52.5	377	DG105/16SHDOMDCF	420
	20	16.0	56.5	39.5	61	26.5	48	109	76.0	36	36	32	37	71.5	1015	DG105/20SHDOMDCF	420
	25	16.0	56.5	38.0	62	30.0	54	116	76.0	46	36	32	42	74.0	1034	DG105/25SHDOMDCF	420
	30	26.0	65.0	44.5	71	35.5	62	133	92.5	50	50	50	49	84.5	2344	DG105/30SHDOMDCF	420
	38	26.0	65.0	42.0	73	41.0	72	145	92.5	60	50	50	57	89.0	2485	DG105/38SHDOMDCF	420

<sup>1)</sup> Pressure shown = item deliverable

<sup>4)</sup> S = heavy series

$$\frac{PN \text{ (bar)}}{10} = PN \text{ (MPa)}$$

Part numbers shown are body only level. To order with a nut and progressive ring (sleeve) included, please see pages D12 and D13 for part number ordering instructions. Instructions for ordering the fitting as EO-2 is also included on these pages.

**WARNING:** This product can expose you to chemicals including Lead and Lead Compounds which is known to the State of California to cause cancer and birth defects or other reproductive harm. For more information go to [www.p65warnings.ca.gov](http://www.p65warnings.ca.gov).

[Click here for CADs, Support Resources or to Configure Parts Online](#)

# DG107

Ball Bearing Rotary Bulkhead Union  
24° Flareless / 24° Flareless

*Read more about the new generation  
Heavy Duty 360° Series Ball Bearing Rotary Fittings*

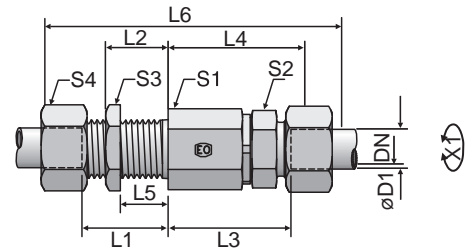

X1) Axis

TABLE OF CONTENTS

VISUAL INDEX

FAQs

ASSEMBLY

TUBE FAB EQUIP

GEN TECH

Series	D1	DN	T1	L1	L2	L3	L4	L5	L6	S1	S2	S3	S4	Weight g/1 piece	Order code*	PN Bar <sup>1)</sup>
S <sup>2)</sup>	06	5.0	M 14×1.5	23	16.0	49	42.0	5	87	22	17	19	17	134	DG107/06SHDOMDCF	420
	08	5.0	M 16×1.5	23	16.0	49	42.0	5	87	22	17	22	19	143	DG107/08SHDOMDCF	420
	12	9.5	M 20×1.5	23	15.5	60	52.5	5	100	30	24	27	24	291	DG107/12SHDOMDCF	420
	16	9.5	M 24×1.5	26	17.5	60	51.5	5	105	30	27	32	30	328	DG107/16SHDOMDCF	420
	20	16.0	M 30×2.0	39	28.5	76	65.5	15	137	41	36	41	36	710	DG107/20SHDOMDCF	420
	25	16.0	M 36×2.0	42	30.0	78	66.0	15	144	41	41	46	46	847	DG107/25SHDOMDCF	420
	30	26.0	M 42×2.0	44	30.5	89	75.5	15	159	60	46	50	50	1533	DG107/30SHDOMDCF	420
	38	26.0	M 52×2.0	47	31.0	92	76.0	15	168	60	55	65	60	1930	DG107/38SHDOMDCF	420

<sup>1)</sup> Pressure shown = item deliverable

<sup>2)</sup> S = heavy series

$$\frac{\text{PN (bar)}}{10} = \text{PN (MPa)}$$

Part numbers shown are body only level. To order with a nut and progressive ring (sleeve) included, please see pages D12 and D13 for part number ordering instructions. Instructions for ordering the fitting as EO-2 is also included on these pages.

**WARNING:** This product can expose you to chemicals including Lead and Lead Compounds which is known to the State of California to cause cancer and birth defects or other reproductive harm. For more information go to [www.p65warnings.ca.gov](http://www.p65warnings.ca.gov).

[Click here for CADs, Support Resources or to Configure Parts Online](#)

# DG108

Ball Bearing Rotary Bulkhead Elbow  
24° Flareless / 24° Flareless

*Read more about the new generation  
Heavy Duty 360° Series Ball Bearing Rotary Fittings*

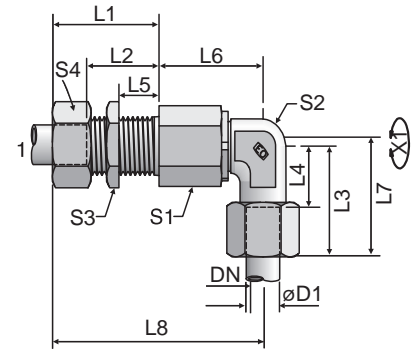

X1) Axis

- TABLE OF CONTENTS
- VISUAL INDEX
- D
- FAQs
- ASSEMBLY
- TUBE FAB EQUIP
- GEN TECH

Series	D1	DN	T1	L1	L2	L3	L4	L5	L6	L7	L8	S1	S2	S3	S4	Weight g/1 piece	Order code*	PN Bar <sup>1)</sup>
S <sup>4)</sup>	06	5.0	M 14×1.5	23	16.0	23	16.0	5	39.5	31	70.0	22	17	19	17	154	DG108/06SHDOMDCF	420
	08	5.0	M 16×1.5	23	16.0	23	17.0	5	39.5	32	70.0	22	17	22	19	166	DG108/08SHDOMDCF	420
	12	9.5	M 20×1.5	23	15.5	29	21.5	5	51.0	38	83.0	30	22	27	24	333	DG108/12SHDOMDCF	420
	16	9.5	M 24×1.5	26	17.5	33	24.5	5	49.0	43	85.0	30	22	32	30	354	DG108/16SHDOMDCF	420
	20	16.0	M 30×2.0	39	28.5	37	26.5	15	67.0	48	117.5	41	36	41	36	904	DG108/20SHDOMDCF	420
	25	16.0	M 36×2.0	42	30.0	42	30.0	15	65.0	54	119.5	41	36	46	46	999	DG108/25SHDOMDCF	420
	30	26.0	M 42×2.0	44	30.5	49	35.5	15	82.5	62	140.0	60	50	50	50	1935	DG108/30SHDOMDCF	420
	38	26.0	M 52×2.0	47	31.0	57	41.0	15	80.5	72	142.0	60	50	65	60	2351	DG108/38SHDOMDCF	420

<sup>1)</sup> Pressure shown = item deliverable

<sup>4)</sup> S = heavy series

$$\frac{\text{PN (bar)}}{10} = \text{PN (MPa)}$$

Part numbers shown are body only level. To order with a nut and progressive ring (sleeve) included, please see pages D12 and D13 for part number ordering instructions. Instructions for ordering the fitting as EO-2 is also included on these pages.

**⚠ WARNING:** This product can expose you to chemicals including Lead and Lead Compounds which is known to the State of California to cause cancer and birth defects or other reproductive harm. For more information go to [www.p65warnings.ca.gov](http://www.p65warnings.ca.gov).

[Click here for CADs, Support Resources or to Configure Parts Online](#)

# DG102-R

Ball Bearing Rotary Straight  
24° Flareless / BSPP

*Read more about the new generation  
Heavy Duty 360° Series Ball Bearing Rotary Fittings*

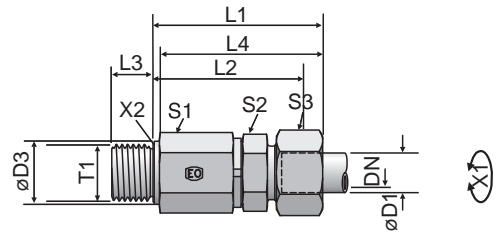

X1) Axis  
X2) Eolastic-sealing

TABLE OF CONTENTS

VISUAL INDEX

FAQs

ASSEMBLY

TUBE FAB EQUIP

GEN TECH

Series	D1	T1	DN	D3	L1	L2	L3	L4	S1	S2	S3	Weight g/1 piece	Order code*	PN Bar <sup>1)</sup>
S <sup>4)</sup>	06	G 1/4 A	5.0	19	49	42.0	12	57.0	22	17	17	110	DG102/06SRHDOMDCF	420
	08	G 1/4 A	5.0	19	49	42.0	12	57.0	22	17	19	116	DG102/08SRHDOMDCF	420
	12	G 3/8 A	9.5	22	60	52.5	12	69.0	30	24	24	243	DG102/12SRHDOMDCF	420
	16	G 1/2 A	9.5	27	60	51.5	14	70.0	30	27	30	256	DG102/16SRHDOMDCF	420
	20	G 3/4 A	16.0	32	76	65.5	16	87.5	41	36	36	558	DG102/20SRHDOMDCF	420
	25	G 1 A	16.0	40	78	66.0	18	90.5	41	41	46	853	DG102/25SRHDOMDCF	420
	30	G 1 1/4 A	26.0	50	89	75.5	20	102.0	60	46	50	1312	DG102/30SRHDOMDCF	420
	38	G 1 1/2 A	26.0	55	92	76.0	22	107.0	60	55	60	1494	DG102/38SRHDOMDCF	420

<sup>1)</sup> Pressure shown = item deliverable

<sup>4)</sup> S = heavy series

$\frac{PN \text{ (bar)}}{10} \rightarrow PN \text{ (MPa)}$

Part numbers shown are body only level. To order with a nut and progressive ring (sleeve) included, please see pages D12 and D13 for part number ordering instructions. Instructions for ordering the fitting as EO-2 is also included on these pages.

**⚠ WARNING:** This product can expose you to chemicals including Lead and Lead Compounds which is known to the State of California to cause cancer and birth defects or other reproductive harm. For more information go to [www.p65warnings.ca.gov](http://www.p65warnings.ca.gov).

[Click here for CADs, Support Resources or to Configure Parts Online](#)

# DG102-M

Ball Bearing Rotary Straight  
24° Flareless / Metric Parallel

*Read more about the new generation  
Heavy Duty 360° Series Ball Bearing Rotary Fittings*

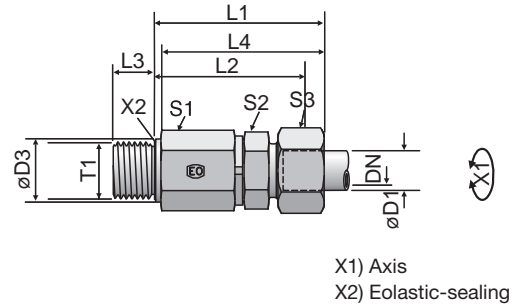

TABLE OF CONTENTS

VISUAL INDEX

D

FAQs

ASSEMBLY

TUBE FAB EQUIP

GEN TECH

Series	D1	T1	DN	D3	L1	L2	L3	L4	S1	S2	S3	Weight g/1 piece	Order code*	PN Bar <sup>1)</sup>
S <sup>4)</sup>	06	M 14×1.5	5.0	19	49	42.0	12	57.0	22	17	17	112	DG102/06SMHDOMDCF	420
	08	M 14×1.5	5.0	19	49	42.0	12	57.0	22	17	19	113	DG102/08SMHDOMDCF	420
	12	M 18×1.5	9.5	24	60	52.5	12	69.0	30	24	24	245	DG102/12SMHDOMDCF	420
	16	M 22×1.5	9.5	27	60	51.5	14	70.0	30	27	30	259	DG102/16SMHDOMDCF	420
	20	M 27×2.0	16.0	32	76	65.5	16	87.5	41	36	36	558	DG102/20SMHDOMDCF	420
	25	M 33×2.0	16.0	40	78	66.0	18	90.5	41	41	46	637	DG102/25SMHDOMDCF	420
	30	M 42×2.0	26.0	50	89	75.5	20	102.0	60	46	50	1316	DG102/30SMHDOMDCF	420
	38	M 48×2.0	26.0	55	92	76.0	22	107.0	60	55	60	1491	DG102/38SMHDOMDCF	420

<sup>1)</sup>Pressure shown = item deliverable

<sup>4)</sup>S = heavy series

$$\frac{PN \text{ (bar)}}{10} = PN \text{ (MPa)}$$

Part numbers shown are body only level. To order with a nut and progressive ring (sleeve) included, please see pages D12 and D13 for part number ordering instructions. Instructions for ordering the fitting as EO-2 is also included on these pages.

**WARNING:** This product can expose you to chemicals including Lead and Lead Compounds which is known to the State of California to cause cancer and birth defects or other reproductive harm. For more information go to [www.p65warnings.ca.gov](http://www.p65warnings.ca.gov).



[Click here for CADs, Support Resources or to Configure Parts Online](#)

## DG104-R

Ball Bearing Rotary Elbow  
24° Flareless / BSPP with  
EOlastic Seal

*Read more about the new generation  
Heavy Duty 360° Series Ball Bearing Rotary Fittings*

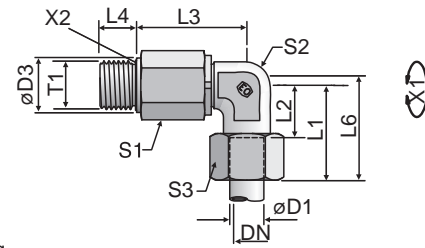

X1) Axis  
X2) Eoelastic-sealing

TABLE  
OF  
CONTENTS

VISUAL  
INDEX

FAQs

ASSEMBLY

TUBE FAB  
EQUIP

GEN TECH

Series	D1	T1	DN	D3	L1	L2	L3	L4	L6	S1	S2	S3	Weight g/1 piece	Order code*	PN Bar <sup>1)</sup>
S <sup>4)</sup>	06	G 1/4 A	05	19	23	16.0	39.5	12	31	22	17	17	131	DG104/06SRHDOMDCF	420
	08	G 1/4 A	05	19	24	17.0	39.5	12	32	22	17	19	135	DG104/08SRHDOMDCF	420
	12	G 3/8 A	10	22	29	21.5	51.0	12	38	30	22	24	284	DG104/12SRHDOMDCF	420
	16	G 1/2 A	10	27	33	24.5	49.0	14	43	30	22	30	284	DG104/16SRHDOMDCF	420
	20	G 3/4 A	16	32	37	26.5	67.0	16	48	41	36	36	752	DG104/20SRHDOMDCF	420
	25	G 1 A	16	40	42	30.0	65.0	18	54	41	36	46	789	DG104/25SRHDOMDCF	420
	30	G 1 1/4 A	26	50	49	35.5	82.5	20	62	60	50	50	1713	DG104/30SRHDOMDCF	420
	38	G 1 1/2 A	26	55	57	41.0	80.5	22	72	60	50	60	1915	DG104/38SRHDOMDCF	420

<sup>1)</sup> Pressure shown = item deliverable

<sup>4)</sup> S = heavy series

$$\frac{\text{PN (bar)}}{10} = \text{PN (MPa)}$$

Part numbers shown are body only level. To order with a nut and progressive ring (sleeve) included, please see pages D12 and D13 for part number ordering instructions. Instructions for ordering the fitting as EO-2 is also included on these pages.

**WARNING:** This product can expose you to chemicals including Lead and Lead Compounds which is known to the State of California to cause cancer and birth defects or other reproductive harm. For more information go to [www.p65warnings.ca.gov](http://www.p65warnings.ca.gov).

[Click here for CADs, Support Resources or to Configure Parts Online](#)

## DG104-M

Ball Bearing Rotary Elbow  
24° Flareless / Metric Parallel

*Read more about the new generation  
Heavy Duty 360° Series Ball Bearing Rotary Fittings*

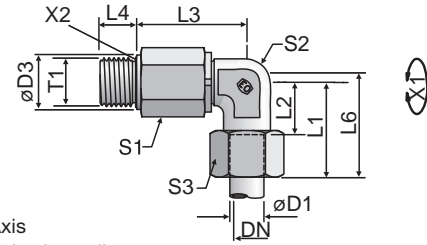

X1) Axis  
X2) Eolastic-sealing

TABLE  
OF  
CONTENTS

VISUAL  
INDEX

D

FAQs

ASSEMBLY

TUBE FAB  
EQUIP

GEN TECH

Series	D1	T1	DN	D3	L1	L2	L3	L4	L6	S1	S2	S3	Weight g/1 piece	Order code*	PN Bar <sup>1)</sup>
S <sup>4)</sup>	06	M 14×1.5	05	19	23	16.0	39.5	12	31	22	17	17	132	DG104/06SMHDOMDCF	420
	08	M 14×1.5	05	19	24	17.0	39.5	12	32	22	17	19	136	DG104/08SMHDOMDCF	420
	12	M 18×1.5	10	22	29	21.5	51.0	12	38	30	22	24	286	DG104/12SMHDOMDCF	420
	16	M 22×1.5	10	27	33	24.5	49.0	14	43	30	22	30	287	DG104/16SMHDOMDCF	420
	20	M 27×2.0	16	32	37	26.5	67.0	16	48	41	36	36	752	DG104/20SMHDOMDCF	420
	25	M 33×2.0	16	40	42	30.0	65.0	18	54	41	36	46	788	DG104/25SMHDOMDCF	420
	30	M 42×2.0	26	50	49	35.5	82.5	20	62	60	50	50	1717	DG104/30SMHDOMDCF	420
	38	M 48×2.0	26	55	57	41.0	80.5	22	72	60	50	60	1913	DG104/38SMHDOMDCF	420

<sup>1)</sup> Pressure shown = item deliverable

<sup>4)</sup> S = heavy series

$$\frac{\text{PN (bar)}}{10} = \text{PN (MPa)}$$

Part numbers shown are body only level. To order with a nut and progressive ring (sleeve) included, please see pages D12 and D13 for part number ordering instructions. Instructions for ordering the fitting as EO-2 is also included on these pages.

[Click here for CADs, Support Resources or to Configure Parts Online](#)

# DG106-R

Ball Bearing Rotary Double Elbow  
24° Flareless / BSPP with EOlastic Seal

*Read more about the new generation  
Heavy Duty 360° Series Ball Bearing Rotary Fittings*

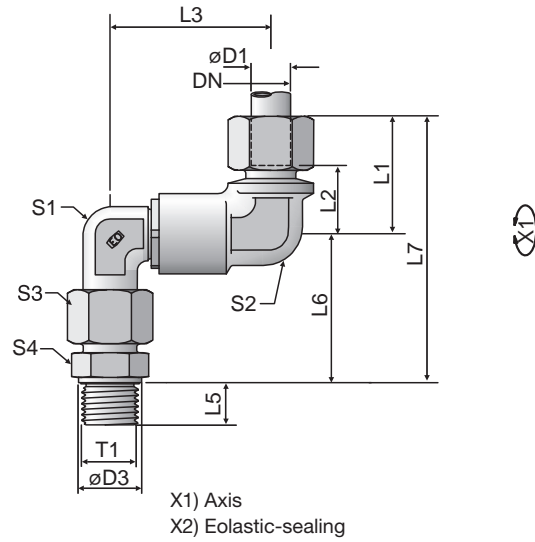

Series	D1	T1	DN	D3	L1	L2	L3	L5	L6	L7	S1	S2	S3	S4	Weight g/1 piece	Order code*	PN Bar <sup>1)</sup>
S <sup>4)</sup>	12	G 3/8 A	9.5	24	34	26.5	53.0	12	55.5	99	24	22	24	22	484	DG106/12SRHDOMDCF	420
	16	G 1/2 A	9.5	27	34	25.5	53.0	14	61.5	105	24	24	30	27	547	DG106/16SRHDOMDCF	420
	20	G 3/4 A	16.0	32	50	39.5	76.0	16	69.5	131	36	32	36	32	1288	DG106/20SRHDOMDCF	420
	25	G 1 A	16.0	40	50	38.0	76.0	18	78.0	140	36	32	46	41	1528	DG106/25SRHDOMDCF	420
	30	G 1 1/4 A	26.0	50	58	44.5	92.5	20	86.5	158	50	50	50	50	3004	DG106/30SRHDOMDCF	420
	38	G 1 1/2 A	26.0	55	58	42.0	92.5	22	101.0	174	50	50	60	55	3419	DG106/38SRHDOMDCF	420

<sup>1)</sup> Pressure shown = item deliverable

<sup>4)</sup> S = heavy series

$$\frac{PN \text{ (bar)}}{10} = PN \text{ (MPa)}$$

Part numbers shown are body only level. To order with a nut and progressive ring (sleeve) included, please see pages D12 and D13 for part number ordering instructions. Instructions for ordering the fitting as EO-2 is also included on these pages.

- TABLE OF CONTENTS
- VISUAL INDEX
- FAQs
- ASSEMBLY
- TUBE FAB EQUIP
- GEN TECH

[Click here for CADs, Support Resources or to Configure Parts Online](#)

## DG106-M

Ball Bearing Rotary Double Elbow  
24° Flareless / Metric Parallel

*Read more about the new generation  
Heavy Duty 360° Series Ball Bearing Rotary Fittings*

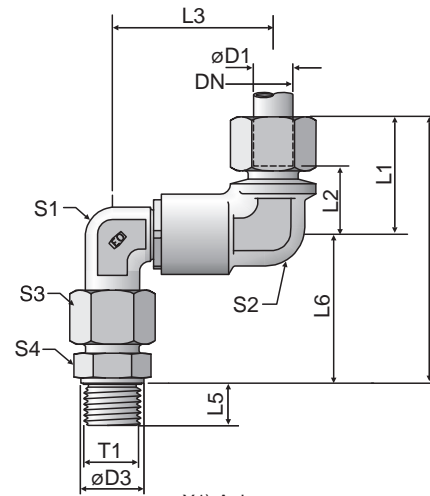

X1) Axis  
X2) Eolastic-sealing

Series	D1	T1	DN	D3	L1	L2	L3	L5	L6	L7	S1	S2	S3	S4	Weight g/1 piece	Order code*	PN Bar <sup>1)</sup>
S <sup>4)</sup>	12	M 18×1.5	5.0	24	34	26.5	53.0	12	55.5	99	24	22	24	24	495	DG106/12SMHDOMDCF	420
	16	M 22×1.5	9.5	27	34	25.5	53.0	14	61.5	105	24	24	30	27	551	DG106/16SMHDOMDCF	420
	20	M 27×2.0	16.0	32	50	39.5	76.0	16	69.5	131	36	32	36	32	1289	DG106/20SMHDOMDCF	420
	25	M 33×2.0	16.0	40	50	38.0	76.0	18	78.0	140	36	32	46	41	1532	DG106/25SMHDOMDCF	420
	30	M 42×2.0	26.0	50	58	44.5	92.5	20	86.5	158	50	50	50	50	3007	DG106/30SMHDOMDCF	420
	38	M 48×2.0	26.0	55	58	42.0	92.5	22	101.0	174	50	50	60	55	3441	DG106/38SMHDOMDCF	420

<sup>1)</sup> Pressure shown = item deliverable

<sup>4)</sup> S = heavy series

$$\frac{PN \text{ (bar)}}{10} = PN \text{ (MPa)}$$

Part numbers shown are body only level. To order with a nut and progressive ring (sleeve) included, please see pages D12 and D13 for part number ordering instructions. Instructions for ordering the fitting as EO-2 is also included on these pages.

TABLE OF CONTENTS

VISUAL INDEX

D

FAQs

ASSEMBLY

TUBE FAB EQUIP

GEN TECH

[Click here for CADs, Support Resources or to Configure Parts Online](#)

# RHD

Non-Return Valve  
24° Flareless / 24° Flareless

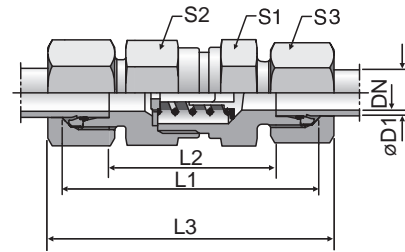

TABLE OF CONTENTS

VISUAL INDEX

FAQs

ASSEMBLY

TUBE FAB EQUIP

GEN TECH

Series	D1 	CF DN	71 DN	L1	L2	L3	S1	CF S2	71 S2	S3	Weight g/1 piece	Order code*	PN (bar) <sup>1)</sup>	
													CF	71
L <sup>3)</sup>	06	3.5	3.5	43.0	29.0	58.0	17	17	17	14	46	RHD06LOMD	400	250
	08	5.5	5.5	44.0	30.0	59.0	19	19	19	17	61	RHD08LOMD	400	250
	10	7.5	7.5	55.0	40.5	69.5	22	24	24	19	104	RHD10LOMD	400	250
	12	9.5	9.5	58.0	43.5	72.5	27	30	30	22	166	RHD12LOMD	400	250
	15	11.0	11.5	62.0	47.5	77.5	27	32	32	27	192	RHD15LOMD	400	250
	18	14.0	14.0	67.0	51.5	83.5	36	41	36	32	292	RHD18LOMD	400	160
	22	18.0	18.0	77.0	61.5	93.5	41	46	46	36	472	RHD22LOMD	250	160
	28	23.0	23.0	85.0	69.5	102.5	50	55	55	41	746	RHD28LOMD	250	100
	35	29.0	29.0	96.0	74.0	117.5	60	65	60	50	1062	RHD35LOMD	250	100
	42	29.0	29.0	96.0	74.0	119.0	65	70	70	60	1518	RHD42LOMD	250	100
S <sup>4)</sup>	06	3.5	3.5	48.5	34.5	63.5	19	19	19	17	70	RHD06SOMD	420	400
	08	3.5	3.5	48.5	34.5	63.5	19	19	19	19	74	RHD08SOMD	420	400
	10	5.5	5.5	55.5	40.5	72.5	22	24	24	22	121	RHD10SOMD	420	400
	12	7.5	7.5	57.5	42.5	74.5	24	27	27	24	148	RHD12SOMD	420	400
	16	11.0	11.5	68.0	50.5	86.5	32	36	36	30	286	RHD16SOMD	420	315
	20	15.0	15.0	76.0	54.5	97.5	41	50	46	36	506	RHD20SOMD	420	250
	25	19.0	19.0	83.0	58.5	106.5	46	55	50	46	639	RHD25SOMD	420	250
	30	24.0	24.0	97.0	69.5	122.5	60	60	60	50	1157	RHD30SOMD	250	250
	38	29.0	29.0	108.0	75.5	136.5	65	70	70	60	1650	RHD38SOMD	250	250

<sup>1)</sup> Pressure shown = item deliverable

<sup>3)</sup> L = light series; <sup>4)</sup> S = heavy series

$$\frac{PN(\text{bar})}{10} = PN(\text{MPa})$$

Part numbers shown are body only level. To order with a nut and progressive ring (sleeve) included, please see pages D12 and D13 for part number ordering instructions. Instructions for ordering the fitting as EO-2 is also included on these pages.

**WARNING:** This product can expose you to chemicals including Lead and Lead Compounds which is known to the State of California to cause cancer and birth defects or other reproductive harm. For more information go to [www.p65warnings.ca.gov](http://www.p65warnings.ca.gov).

\*Please add the suffixes below according to the material/surface required.

Order code suffixes			
Material	Suffix surface and material	Example	Standard sealing material (no additional suffix needed)
Steel, zinc plated, Cr(VI)-free	CF	RHD06LOMDCF	NBR
Stainless steel	71	RHD06LOMD71	VIT



Click here for CADs, Support Resources or to Configure Parts Online

# RHV-R-ED

Non-Return Valve  
24° Flareless / BSPP  
with EOlastic Seal

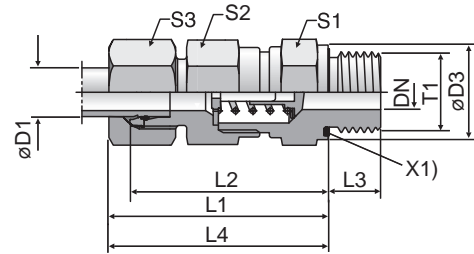

X1) Eolastic sealing

- TABLE OF CONTENTS
- VISUAL INDEX
- D
- FAQs
- ASSEMBLY
- TUBE FAB EQUIP
- GEN TECH

Series	D1	T1	CF DN	71 DN	D3	L1	L2	L3	L4	S1	CF S2	71 S2	S3	Weight g/1 piece	Order code*	PN (bar) <sup>1)</sup>	
																CF	71
L <sup>3)</sup>	06	G 1/8 A	3.5	3.5	14	35.0	28.0	8	42.5	17	17	17	14	47	RHV06LREDOMD	400	250
	08	G 1/4 A	5.5	5.5	19	37.0	30.0	12	44.5	19	19	19	17	62	RHV08LREDOMD	400	250
	10	G 1/4 A	7.5	7.5	19	46.0	38.5	12	53.0	22	24	24	19	105	RHV10LREDOMD	400	250
	12	G 3/8 A	9.5	9.5	22	50.0	42.5	12	57.0	27	30	30	22	175	RHV12LREDOMD	400	250
	15	G 1/2 A	11.0	11.5	27	53.0	45.5	14	60.5	27	32	32	27	205	RHV15LREDOMD	400	250
	18	G 1/2 A	14.0	14.0	27	58.0	50.0	14	66.0	36	41	36	32	294	RHV18LREDOMD	400	160
	22	G 3/4 A	18.0	18.0	32	63.0	55.0	16	71.0	41	46	46	36	450	RHV22LREDOMD	250	160
	28	G 1 A	23.0	23.0	40	71.0	63.0	18	79.5	50	55	55	41	720	RHV28LREDOMD	250	100
	35	G 1 1/4 A	29.0	29.0	50	80.0	69.0	20	90.5	60	65	65	50	1050	RHV35LREDOMD	250	100
42	G 1 1/2 A	29.0	29.0	55	80.0	68.5	22	91.0	65	70	70	60	1560	RHV42LREDOMD	250	100	
S <sup>4)</sup>	06	G 1/4 A	3.5	3.5	19	38.5	31.5	12	46.0	19	19	19	17	73	RHV06SREDOMD	420	400
	08	G 1/4 A	3.5	3.5	19	38.5	31.5	12	46.0	19	19	19	19	79	RHV08SREDOMD	420	400
	10	G 3/8 A	5.5	5.5	22	45.5	38.0	12	54.0	22	24	24	22	132	RHV10SREDOMD	420	400
	12	G 3/8 A	7.5	7.5	22	48.5	41.0	12	57.0	24	27	27	24	153	RHV12SREDOMD	420	400
	16	G 1/2 A	11.0	11.5	27	57.0	48.0	14	66.0	32	36	36	30	293	RHV16SREDOMD	420	315
	20	G 3/4 A	15.0	15.0	32	63.0	52.0	16	73.5	41	50	46	36	511	RHV20SREDOMD	420	250
	25	G 1 A	19.0	19.0	40	67.0	54.5	18	78.5	46	55	50	46	648	RHV25SREDOMD	420	250
	30	G 1 1/4 A	24.0	24.0	50	78.0	64.0	20	90.5	60	60	60	50	1176	RHV30SREDOMD	250	250
38	G 1 1/2 A	29.0	29.0	55	86.0	69.5	22	100.0	65	70	70	60	1624	RHV38SREDOMD	250	250	

<sup>1)</sup> Pressure shown = item deliverable

<sup>3)</sup> L = light series; <sup>4)</sup> S = heavy series

$$\frac{PN \text{ (bar)}}{10} = PN \text{ (MPa)}$$

Part numbers shown are body only level. To order with a nut and progressive ring (sleeve) included, please see pages D12 and D13 for part number ordering instructions. Instructions for ordering the fitting as EO-2 is also included on these pages.

**WARNING:** This product can expose you to chemicals including Lead and Lead Compounds which is known to the State of California to cause cancer and birth defects or other reproductive harm. For more information go to [www.p65warnings.ca.gov](http://www.p65warnings.ca.gov).

\*Please add the suffixes below according to the material/surface required.

Order code suffixes			
Material	Suffix surface and material	Example	Standard sealing material (no additional suffix needed)
Steel, zinc plated, Cr(VI)-free	CF	RHV06LREDOMDCF	NBR
Stainless steel	71	RHV06LREDOMD71	VIT

[Click here for CADs, Support Resources or to Configure Parts Online](#)

# RHV-M-ED

Non-Return Valve  
24° Flareless / Metric Parallel  
with EOlastic Seal

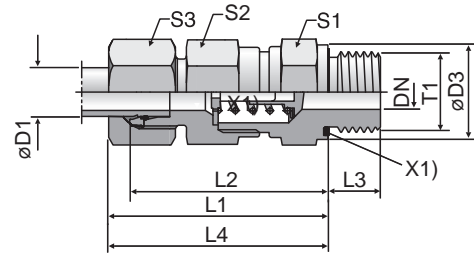

X1) Eolastic sealing

TABLE OF CONTENTS

VISUAL INDEX

FAQs

ASSEMBLY

TUBE FAB EQUIP

GEN TECH

Series	D1	T1	CF DN	71 DN	D3	L1	L2	L3	L4	S1	CF S2	71 S2	S3	Weight g/1 piece	Order code*	PN (bar) <sup>1)</sup>	
																CF	71
L <sup>3)</sup>	06	M 10×1.0	3.5	3.5	14	35.0	28.0	8	42.5	17	17	17	14	46	RHV06LMEDOMD	400	250
	08	M 12×1.5	5.5	5.5	17	37.0	29.5	12	43.5	19	19	19	17	58	RHV08LMEDOMD	400	250
	10	M 14×1.5	7.5	7.5	19	46.0	38.5	12	53.0	22	24	44	19	108	RHV10LMEDOMD	400	250
	12	M 16×1.5	9.5	9.5	22	50.0	42.5	12	57.0	27	30	30	22	173	RHV12LMEDOMD	400	250
	15	M 18×1.5	11.0	11.5	24	53.0	45.5	12	60.5	27	32	32	27	192	RHV15LMEDOMD	400	250
	18	M 22×1.5	14.0	14.0	27	58.0	50.0	14	66.0	36	41	36	32	298	RHV18LMEDOMD	400	160
	22	M 26×1.5	18.0	18.0	32	63.0	55.0	16	71.0	41	46	46	36	446	RHV22LMEDOMD	250	160
	28	M 33×2.0	23.0	23.0	40	71.0	63.0	18	79.5	50	55	55	41	722	RHV28LMEDOMD	250	100
	35	M 42×2.0	29.0	29.0	50	80.0	69.0	20	90.5	60	65	65	50	1053	RHV35LMEDOMD	250	100
	42	M 48×2.0	29.0	29.0	55	80.0	68.5	22	91.0	65	70	70	60	1563	RHV42LMEDOMD	250	100
S <sup>4)</sup>	06	M 12×1.5	3.5	3.5	17	38.5	31.5	12	46.0	19	19	19	17	70	RHV06SMEDOMD	420	400
	08	M 14×1.5	3.5	3.5	19	38.5	31.5	12	46.0	19	19	19	19	76	RHV08SMEDOMD	420	400
	10	M 16×1.5	5.5	5.5	22	45.5	38.0	12	54.0	22	24	24	22	124	RHV10SMEDOMD	420	400
	12	M 18×1.5	7.5	7.5	24	48.5	41.0	12	57.0	24	27	27	24	157	RHV12SMEDOMD	420	400
	16	M 22×1.5	11.0	11.5	27	57.0	48.0	14	66.0	32	36	36	30	296	RHV16SMEDOMD	420	315
	20	M 27×2.0	15.0	15.0	32	63.0	52.0	16	73.5	41	50	46	36	521	RHV20SMEDOMD	420	250
	25	M 33×2.0	19.0	19.0	40	67.0	54.5	18	78.5	46	55	50	46	648	RHV25SMEDOMD	420	250
	30	M 42×2.0	24.0	24.0	50	78.0	64.0	20	90.5	60	60	60	50	1178	RHV30SMEDOMD	250	250
38	M 48×2.0	29.0	29.0	55	86.0	69.5	22	100.0	65	70	70	60	1627	RHV38SMEDOMD	250	250	

<sup>1)</sup> Pressure shown = item deliverable

<sup>3)</sup> L = light series; <sup>4)</sup> S = heavy series

$$\frac{PN \text{ (bar)}}{10} = PN \text{ (MPa)}$$

Part numbers shown are body only level. To order with a nut and progressive ring (sleeve) included, please see pages D12 and D13 for part number ordering instructions. Instructions for ordering the fitting as EO-2 is also included on these pages.

**WARNING:** This product can expose you to chemicals including Lead and Lead Compounds which is known to the State of California to cause cancer and birth defects or other reproductive harm. For more information go to [www.p65warnings.ca.gov](http://www.p65warnings.ca.gov).

\*Please add the **suffixes** below according to the material/surface required.

Order code suffixes			
Material	Suffix surface and material	Example	Standard sealing material (no additional suffix needed)
Steel, zinc plated, Cr(VI)-free	CF	RHV06LMEDOMDCF	NBR
Stainless steel	71	RHV06LMEDOMD71	VIT

[Click here for CADs, Support Resources or to Configure Parts Online](#)

# RHZ-R-ED

Non-Return Valve  
24° Flareless / BSPP

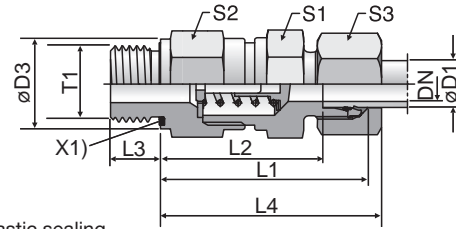

X1) Eolastic sealing

TABLE OF CONTENTS

VISUAL INDEX

D

FAQs

ASSEMBLY

TUBE FAB EQUIP

GEN TECH

Series	D1	T1	CF DN	71 DN	D3	L1	L2	L3	L4	S1	CF S2	71 S2	S3	Weight g/1 piece	Order code*	PN (bar) <sup>1)</sup>	
																CF	71
L <sup>3)</sup>	06	G 1/8 A	3.5	3.5	14	33.5	26.5	8	41.0	17	17	17	14	44	RHZ06LREDOMD	400	250
	08	G 1/4 A	5.5	5.5	19	35.5	28.5	12	43.0	19	19	19	17	59	RHZ08LREDOMD	400	250
	10	G 1/4 A	7.5	7.5	19	46.0	38.5	12	53.0	22	24	24	19	125	RHZ10LREDOMD	400	250
	12	G 3/8 A	9.5	9.5	22	48.0	40.5	12	55.0	27	30	30	22	161	RHZ12LREDOMD	400	250
	15	G 1/2 A	11.0	11.5	27	50.0	42.5	14	57.5	27	32	32	27	186	RHZ15LREDOMD	400	250
	18	G 1/2 A	14.0	14.0	27	56.0	48.0	14	64.0	36	41	36	32	275	RHZ18LREDOMD	400	160
	22	G 3/4 A	18.0	18.0	32	64.0	56.0	16	72.0	41	46	46	36	463	RHZ22LREDOMD	250	160
	28	G 1 A	23.0	23.0	40	72.0	64.0	18	80.5	50	55	55	41	721	RHZ28LREDOMD	250	100
	35	G 1 1/4 A	29.0	29.0	50	81.0	70.0	20	91.5	60	65	65	50	1073	RHZ35LREDOMD	250	100
	42	G 1 1/2 A	29.0	29.0	55	82.0	70.5	22	93.0	65	70	70	60	1602	RHZ42LREDOMD	250	100
S <sup>4)</sup>	06	G 1/4 A	3.5	3.5	19	38.5	31.5	12	46.0	19	19	19	17	71	RHZ06SREDOMD	420	400
	08	G 1/4 A	3.5	3.5	19	38.5	31.5	12	46.0	19	19	19	19	74	RHZ08SREDOMD	420	400
	10	G 3/8 A	5.5	5.5	22	45.5	38.0	12	54.0	22	24	24	22	128	RHZ10SREDOMD	420	400
	12	G 3/8 A	7.5	7.5	22	48.5	41.0	12	57.0	24	27	27	24	152	RHZ12SREDOMD	420	400
	16	G 1/2 A	11.0	11.5	27	55.0	46.0	14	64.0	32	36	36	30	275	RHZ16SREDOMD	420	315
	20	G 3/4 A	15.0	15.0	32	61.0	50.0	16	71.5	41	50	46	36	490	RHZ20SREDOMD	420	250
	25	G 1 A	19.0	19.0	40	67.0	54.5	18	78.5	46	55	50	46	647	RHZ25SREDOMD	420	250
	30	G 1 1/4 A	24.0	24.0	50	78.0	64.0	20	90.5	60	60	60	50	1180	RHZ30SREDOMD	250	250
	38	G 1 1/2 A	29.0	29.0	55	88.0	71.5	22	102.0	65	70	70	60	1670	RHZ38SREDOMD	250	250

<sup>1)</sup> Pressure shown = item deliverable

<sup>3)</sup> L = light series; <sup>4)</sup> S = heavy series

$$\frac{\text{PN (bar)}}{10} = \text{PN (MPa)}$$

Part numbers shown are body only level. To order with a nut and progressive ring (sleeve) included, please see pages D12 and D13 for part number ordering instructions. Instructions for ordering the fitting as EO-2 is also included on these pages.

**WARNING:** This product can expose you to chemicals including Lead and Lead Compounds which is known to the State of California to cause cancer and birth defects or other reproductive harm. For more information go to [www.p65warnings.ca.gov](http://www.p65warnings.ca.gov).

Order code suffixes			
Material	Suffix surface and material	Example	Standard sealing material (no additional suffix needed)
Steel, zinc plated, Cr(VI)-free	CF	RHZ06LREDOMDCF	NBR
Stainless steel	71	RHZ06LREDOMD71	VIT

\*Please add the suffixes below according to the material/surface required.

[Click here for CADs, Support Resources or to Configure Parts Online](#)

# RHZ-M-ED

Non-Return Valve  
24° Flareless / Metric Parallel with  
EOlastic Seal

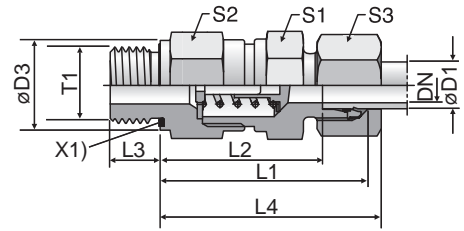

X1) Eolastic sealing

TABLE OF CONTENTS

VISUAL INDEX

FAQs

ASSEMBLY

TUBE FAB EQUIP

GEN TECH

Series	D1	T1	CF DN	71 DN	D3	L1	L2	L3	L4	S1	CF S2	71 S2	S3	Weight g/1 piece	Order code*	PN (bar) <sup>1)</sup>	
																CF	71
L <sup>3)</sup>	06	M 10×1.0	3.5	3.5	14	33.5	26.5	8	41.0	17	17	17	14	44	RHZ06LMEDOMD	400	250
	08	M 12×1.5	5.5	5.5	17	35.5	28.5	12	43.0	19	19	19	17	58	RHZ08LMEDOMD	400	250
	10	M 14×1.5	7.5	7.5	19	46.0	38.5	12	53.0	22	24	24	19	104	RHZ10LMEDOMD	400	250
	12	M 16×1.5	9.5	9.5	22	48.0	40.5	12	55.0	27	30	30	22	169	RHZ12LMEDOMD	400	250
	15	M 18×1.5	11.0	11.5	24	50.0	42.5	12	57.5	27	32	32	27	174	RHZ15LMEDOMD	400	250
	18	M 22×1.5	14.0	14.0	27	56.0	48.0	14	64.0	36	41	36	32	279	RHZ18LMEDOMD	400	160
	22	M 26×1.5	18.0	18.0	32	64.0	56.0	16	72.0	41	46	46	36	459	RHZ22LMEDOMD	250	160
	28	M 33×2.0	23.0	23.0	40	72.0	64.0	18	80.5	50	55	55	41	721	RHZ28LMEDOMD	250	100
	35	M 42×2.0	29.0	29.0	50	81.0	70.0	20	91.5	60	65	65	50	1078	RHZ35LMEDOMD	250	100
	42	M 48×2.0	29.0	29.0	55	82.0	70.5	22	93.0	65	70	70	60	1601	RHZ42LMEDOMD	250	100
S <sup>4)</sup>	06	M 12×1.5	3.5	3.5	17	38.5	31.5	12	46.0	19	19	19	17	70	RHZ06SMEDOMD	420	400
	08	M 14×1.5	3.5	3.5	19	38.5	31.5	12	46.0	19	19	19	19	75	RHZ08SMEDOMD	420	400
	10	M 16×1.5	5.5	5.5	22	45.5	38.0	12	54.0	22	24	24	22	123	RHZ10SMEDOMD	420	400
	12	M 18×1.5	7.5	7.5	24	48.5	41.0	12	57.0	24	27	27	24	157	RHZ12SMEDOMD	420	400
	16	M 22×1.5	11.0	11.5	27	55.0	46.0	14	64.0	32	36	36	30	279	RHZ16SMEDOMD	420	315
	20	M 27×2.0	15.0	15.0	32	61.0	50.0	16	71.5	41	50	46	36	487	RHZ20SMEDOMD	420	250
	25	M 33×2.0	19.0	19.0	40	67.0	54.5	18	78.5	46	55	50	46	647	RHZ25SMEDOMD	420	250
	30	M 42×2.0	24.0	24.0	50	78.0	64.0	20	90.5	60	60	60	50	1180	RHZ30SMEDOMD	250	250
	38	M 48×2.0	29.0	29.0	55	88.0	71.5	22	102.0	65	70	70	60	1669	RHZ38SMEDOMD	250	250

<sup>1)</sup> Pressure shown = item deliverable

<sup>3)</sup> L = light series; <sup>4)</sup> S = heavy series

$$\frac{PN(\text{bar})}{10} = PN(\text{MPa})$$

Part numbers shown are body only level. To order with a nut and progressive ring (sleeve) included, please see pages D12 and D13 for part number ordering instructions. Instructions for ordering the fitting as EO-2 is also included on these pages.

**WARNING:** This product can expose you to chemicals including Lead and Lead Compounds which is known to the State of California to cause cancer and birth defects or other reproductive harm. For more information go to [www.p65warnings.ca.gov](http://www.p65warnings.ca.gov).

\*Please add the suffixes below according to the material/surface required.

Order code suffixes			
Material	Suffix surface and material	Example	Standard sealing material (no additional suffix needed)
Steel, zinc plated, Cr(VI)-free	CF	RHZ06LMEDOMDCF	NBR
Stainless steel	71	RHZ06LMEDOMD71	VIT

[Click here for CADs, Support Resources or to Configure Parts Online](#)

# RHDI

Non-Return Valve  
BSPP Female / BSPP Female

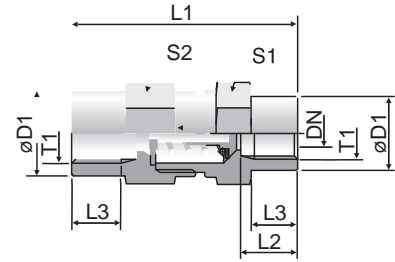

- TABLE OF CONTENTS
- VISUAL INDEX
- D
- FAQs
- ASSEMBLY
- TUBE FAB EQUIP
- GEN TECH

Series	T1	DN	D1	L1	L2	L3	S1	S2	Weight g/1 piece	Order code*	PN (bar) <sup>1)</sup>	
											CF	71
L <sup>3)</sup>	G 1/8	3.5	19	42.5	12.0	8.0	19	19	76	RHD11/8	400	400
	G 1/4	3.5	19	51.0	16.0	12.0	19	19	82	RHD11/4	400	400
	G 3/8	7.5	24	60.0	17.0	12.0	24	27	157	RHD13/8	400	400
	G 1/2	11.5	32	72.0	20.0	15.0	32	36	344	RHD11/2	315	315
	G 3/4	15.0	41	84.0	22.0	16.5	41	46	664	RHD13/4	250	250
	G 1	19.0	46	95.0	25.5	19.0	46	50	821	RHD11	250	250
	G 1 1/4	24.0	60	110.0	28.0	21.5	60	60	1581	RHD111/4	250	250
	G 1 1/2	29.0	65	114.0	28.5	22.0	65	70	1919	RHD111/2	250	250

<sup>1)</sup> Pressure shown = item deliverable

<sup>3)</sup> L = light series

$$\frac{\text{PN (bar)}}{10} = \text{PN (MPa)}$$

**WARNING:** This product can expose you to chemicals including Lead and Lead Compounds which is known to the State of California to cause cancer and birth defects or other reproductive harm. For more information go to [www.p65warnings.ca.gov](http://www.p65warnings.ca.gov).

Order code suffixes			
Material	Suffix surface and material	Example	Standard sealing material (no additional suffix needed)
Steel, zinc plated, Cr(VI)-free	CF	RHD11/8CF	NBR
Stainless steel	71	RHD11/871	VIT

\*Please add the **suffixes** below according to the material/surface required.



[Click here for CADs, Support Resources or to Configure Parts Online](#)

# RVP

Non-Return Valve  
Cartridge

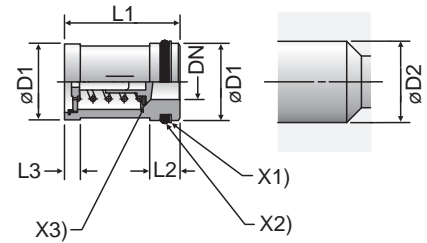

- X1) Supporting ring PTFE
- X2) O-ring NBR
- X3) Sealing disc NBR

TABLE OF CONTENTS

VISUAL INDEX

FAQs

ASSEMBLY

TUBE FAB EQUIP

GEN TECH

Valve ITL	DN	D1	D2	L1 ± 0,15	L2	L3	O-ring	Supporting ring	Weight g/1 piece	Order code*	PN (bar) <sup>1)</sup>	
											CF	71
6-L/6 & 8-S	3.5	12.945 ± 0.055	13 <sup>+0.12 +0.05</sup>	23.15	9.5	6.0	8.3×2.4	SRA 13-2.05-1.0	21	<b>RVP13</b>	420	400
8-L/10-S	5.5	15.945 ± 0.055	16 <sup>+0.12 +0.05</sup>	26.65	9.5	6.5	11.3×2.4	SRA 16-2.05-1.0	32	<b>RVP16</b>	420	400
10-L/12-S	7.5	19.935 ± 0.065	20 <sup>+0.142 +0.065</sup>	30.15	9.5	6.5	15.3×2.4	SRA 20-2.05-1.0	54	<b>RVP20</b>	420	400
12-L/14-S	9.5	23.935 ± 0.065	24 <sup>+0.149 +0.065</sup>	35.15	12.0	7.5	18.2×3	SRA 24-2.6-1.0	80	<b>RVP24</b>	420	315
15-L/16-S	11.5	26.935 ± 0.065	27 <sup>+0.149 +0.065</sup>	38.15	12.0	7.5	21.2×3	SRA 27-2.6-1.0	105	<b>RVP27</b>	420	315
18-L/20-S	15.0	34.92 ± 0.08	35 <sup>+0.18 +0.08</sup>	44.65	12.0	9.5	29.2×3	SRA 35-2.5-1.0	204	<b>RVP35</b>	420	250
22-L/25-S	19.0	39.92 ± 0.08	40 <sup>+0.18 +0.08</sup>	50.65	12.0	11.0	34.2×3	SRA 40-2.5-1.0	275	<b>RVP40</b>	420	250
28-L/30-S	24.0	46.92 ± 0.08	47 <sup>+0.18 +0.08</sup>	60.15	13.0	13.0	41.0×3	SRA 47-2.6-1.5	412	<b>RVP47</b>	250	250
35-L/38-S	29.0	54.905 ± 0.095	55 <sup>+0.22 +0.01</sup>	70.15	16.0	13.0	44.2×5.7	SRA 55-5.1-1.5	607	<b>RVP55</b>	250	250

<sup>1)</sup>Pressure shown = item deliverable

$$\frac{PN \text{ (bar)}}{10} = PN \text{ (MPa)}$$

**WARNING:** This product can expose you to chemicals including Lead and Lead Compounds which is known to the State of California to cause cancer and birth defects or other reproductive harm. For more information go to [www.p65warnings.ca.gov](http://www.p65warnings.ca.gov).

\*Please add the **suffixes** below according to the material/surface required.

Order code suffixes			
Material	Suffix surface and material	Example	Standard sealing material (no additional suffix needed)
Steel, zinc plated, Cr(VI)-free	CF	RVP13CF	NBR
Stainless steel	71	RVP1371	VIT

[Click here for CADs, Support Resources or to Configure Parts Online](#)

# I-TL

## Non-Return Valve Internal Parts

- X1) poppet
- X2) sealing disc (smooth side to the poppet)
- X3) cover disc
- X4) spring
- X5) passage disc

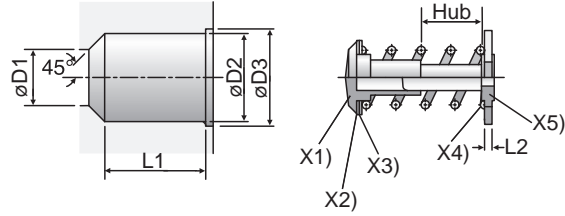

TABLE OF CONTENTS

VISUAL INDEX

D

FAQs

ASSEMBLY

TUBE FAB EQUIP

GEN TECH

Series	Tube O.D.	D1 <sup>+0.1</sup>	D2 <sup>+0.1</sup>	D3 <sup>+0.1</sup>	L1 <sup>+0.1</sup>	L2	Hub	Weight g/1 piece	Order code*	PN (bar) <sup>1)</sup>	
										CF	71
L/S/S	06/06/08	3.5	7.5	8.6	8.2	2.0	1.0	2	ITL06L/06+08S	*	*
L/S	08/10	5.5	10.2	11.6	11.0	2.0	1.7	4	ITL08L/10S	*	*
L/S	10/12	7.5	13.0	14.1	14.0	2.0	2.3	7	ITL10L/12S	*	*
L/S	12/14	9.5	16.7	18.1	16.5	2.5	2.9	13	ITL12L/14S	*	*
L/S	15/16	11.5	19.5	20.6	19.0	2.5	3.5	18	ITL15L/16S	*	*
L/S	18/20	15.0	25.2	27.1	22.5	3.0	4.4	37	ITL18L/20S	*	*
L/S	22/25	19.0	30.8	32.6	27.0	3.0	5.5	54	ITL22L/25S	*	*
L/S	28/30	24.0	38.6	40.6	32.5	3.5	7.3	107	ITL28L/30S	*	*
L/L/S	35/38/42	29.0	45.7	48.1	37.5	3.5	8.9	144	ITL35L+42I/38S	*	*

\* = item deliverable

**WARNING:** This product can expose you to chemicals including Lead and Lead Compounds which is known to the State of California to cause cancer and birth defects or other reproductive harm. For more information go to [www.p65warnings.ca.gov](http://www.p65warnings.ca.gov).

Order code suffixes			
Material	Suffix surface and material	Example	Standard sealing material (no additional suffix needed)
Steel, zinc plated, Cr(VI)-free	CF	ITL06L/06+08S	NBR
Stainless steel	71	ITL06L71/06+08S	VIT

\*Please add the **suffixes** below according to the material/surface required.

[Click here for CADs, Support Resources or to Configure Parts Online](#)

# DV

Shut-Off Valve, PN 10  
24° Flareless / 24° Flareless

(with internal threaded spindle)

For cold and warm water\* up to 80°C, compressed air, mineral oils and fuel oils types EL and L, 6 bar and up to 80°C.

The pressure specification PN for hand-operated shut-off valves applies to the design factor 1,5 (according DIN 3230 T5 and ISO 5208).

### Caution!

Please note the admissible pressure ratings for the EO-tube ends.

### DVAE

EO tube end ⇒ male BSPP

### DVAA

male BSPP ⇐ EO tube end

DV-valves with male BSPP thread on request.

\*Indicate type of water or additive if any

- X1) **Hand wheel:** material: Polyamid
- X2) **Spindle:** material: Brass 2.0401
- X3) **Stuffing boxpacking:** PTFE Compound
- X4) **Head piece:** material: Brass 2.0401
- X5) **Sealing:** O-ring NBR (e.g. Perbunan)
- X6) **Casing:** material: Brass 2.0340.02
- X7) **Valve cone:** material: Brass 2.0401
- X8) **Shut-off sealing:** NBR (e.g. Perbunan)
- X9) **Male stud fitting:** material: Brass 2.0540
- X10) **Sealing:** Eolastic-sealing NBR (e.g. Perbunan)

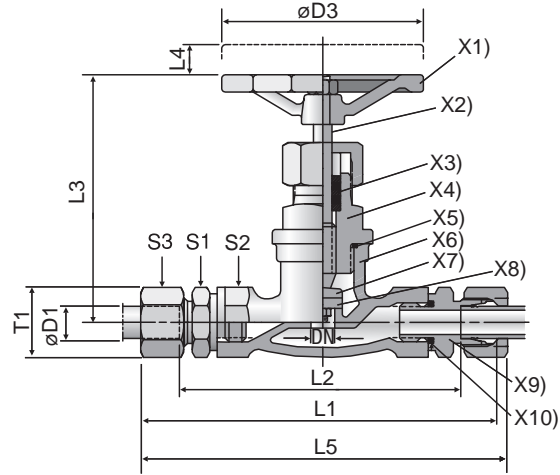

Series	D1	T1	DN	D3	L1	L2	L3	L4	L5	S1	S2	S3	Weight g/1 piece	Order code*	PN (bar) <sup>1)</sup> without surface
L <sup>3)</sup>	06	M 12×1.5	5	50	102	88	63	7	117	22	21	14	313	DV06LX	10
	08	M 14×1.5	6	50	102	88	63	7	117	22	21	17	305	DV08LX	10
	10	M 16×1.5	8	50	104	90	63	7	119	22	21	19	308	DV10LX	10
	12	M 18×1.5	10	50	104	90	63	7	119	22	21	22	304	DV12LX	10
	15	M 22×1.5	12	50	107	93	65	8	123	27	25	27	426	DV15LX	10
	18	M 26×1.5	16	50	109	94	67	8	126	27	25	32	434	DV18LX	10
	22	M 30×2.0	20	60	123	108	67	8	140	32	32	36	670	DV22LX	10
	28	M 36×2.0	25	60	140	125	95	10	158	41	38	41	1030	DV28LX	10
	35	M 45×2.0	32	70	166	145	102	10	188	50	47	50	1640	DV35LX	10

<sup>1)</sup> Pressure shown = item deliverable

<sup>3)</sup> L = light series

$$\frac{PN \text{ (bar)}}{10} = PN \text{ (MPa)}$$

Part numbers shown are body only level. To order with a nut and progressive ring (sleeve) included, please see pages D12 and D13 for part number ordering instructions. Instructions for ordering the fitting as EO-2 is also included on these pages.

\*Please add the **suffixes** below according to the material/surface required.

Order code suffixes			
Material	Suffix surface and material	Example	Standard sealing material (no additional suffix needed)
Brass 2.0340.02	without	DV06LX	PTFE / NBR

- TABLE OF CONTENTS
- VISUAL INDEX
- FAQs
- ASSEMBLY
- TUBE FAB EQUIP
- GEN TECH

[Click here for CADs, Support Resources or to Configure Parts Online](#)

# LD

## Shut-Off Valve, PN 40 24° Flareless / 24° Flareless

(with internal threaded spindle)

For hydraulic oil, mineral, oil, fuel oil, Diesel, water\* etc. Temperature up to 150°C.

For steam up to 10 bar.

For compressed air up to 35 bar on request. CS DIN 86501 Rg.-N.

The pressure specification PN for hand-operated shut-off valves applies to the design factor 1,5 (according DIN 3230 T5 and ISO 5208).

### Caution!

Please note the admissible pressure ratings for the EO-tube ends.

- X1) **Hand wheel:** Plastic material typ 74 according to DIN 388 Form C
- X2) **Spindle:** with internal thread. Material: Cu Zn 35 Ni 2
- X3) **Stuffing box packing:** Graphite
- X4) **Head piece:** material: Cu Zn 39 Pb 3
- X5) **Sealing:** Copper ring
- X6) **Locking plates:** material: St. 37/zinc plated
- X7) **Valve cone:** loose tip material: Cu Zn 35 Ni 2
- X8) **Casing:** material: G-Cu Sn 5Zn Pb (Rg 5 according to DIN 1705)

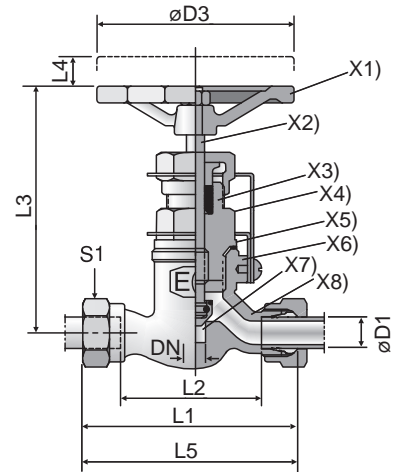

### EO-tube connection:

for **copper** tubes nuts, cutting and locking rings of brass

### Attention:

for **steel** tubes: nuts, progressive rings of steel **specify when ordering**

We recommend pre-installation in hardened pre-installation body (see assembly instructions)

Series	D1	T1	DN	D3	L1	L2	L3	L4	L5	S1	Weight g/1 piece	Order code*	PN (bar) <sup>1)</sup> without surface
S <sup>4)</sup>	10	M 18×1.5	6	63	60	45	98	7	77	22	383	<b>LD10SX</b>	40
	12	M 20×1.5	8	63	64	49	98	7	81	24	401	<b>LD12SX</b>	40
	14	M 22×1,5	10	63	70	54	98	7	89	27	417	<b>LD14SX</b>	40
	16	M 24×1.5	12	80	84	67	110	9	103	30	631	<b>LD16SX</b>	40
	20	M 30×2.0	16	80	90	69	110	9	112	36	688	<b>LD20SX</b>	40
	25	M 36×2.0	20	100	110	86	129	12	134	46	1191	<b>LD25SX</b>	40
	30	M 42×2.0	25	100	120	93	129	12	146	50	1322	<b>LD30SX</b>	40
	38	M 52×2.0	32	100	140	108	158	12	169	60	2268	<b>LD38SX</b>	40

<sup>1)</sup>Pressure shown = item deliverable

<sup>4)</sup>S = heavy series

$\frac{PN (bar)}{10} = PN (MPa)$

Delivery without nut and ring. Information on ordering complete fittings or alternative sealing materials see page D13.

\*Please add the **suffixes** below according to the material/ surface required.

Order code suffixes			
Material	Suffix surface and material	Example	Standard sealing material (no additional suffix needed)
Gunmetal (Rg 5) 2.1096	without	LD10SX	Graphit / Metal

TABLE OF CONTENTS

VISUAL INDEX

D

FAQs

ASSEMBLY

TUBE FAB EQUIP

GEN TECH

[Click here for CADs, Support Resources or to Configure Parts Online](#)

# VDHA

High Pressure Valve  
24° Flareless / 24° Flareless

with internal threaded spindle and body of low grade forged stainless steel  
The pressure specification PN for hand-operated shut-off valves applies to the design factor 1,5 (according DIN 3230 T5 and ISO 5208).

**Caution!**

Please note the admissible pressure ratings for the EO-tube ends.

Temperatures up to 400°C according to tube material (consider pressure drop with temperatures above 50°C)

**Required pressure reductions**

temperature	50°C	100°C	200°C	300°C	400°C
pressure reductions	6%	15%	37%	60%	84%

Intermediate values are to be interpolated.

**Applications:**

For water, steam, hot and cold oils (not for gases, oxygen etc.) on mineral oil based grease.  
For compressed air up to 50°C. For corrosive media, acids, fire resistant fluid etc.

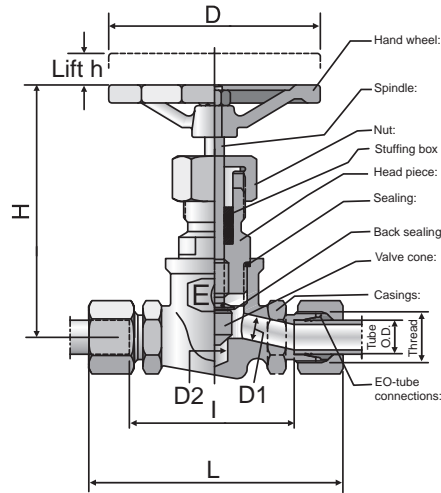

Aluminum die casting  
OD-Al, Si Ou3  
Operating position: completely opened or closed, with internal thread.  
Material 1.4021  
Material 1.0718  
Stuffing box packing: GA 24 (Graph)  
Material 1.0480  
Material 1.0480  
between casing and head piece, material-no. 2.4066  
against head piece  
hardened loose tip material 1.4122. For VDHA 30-PS and 38-PS material 1.0480 forged with Cr 17  
forged. Material No. 1.4104  
Nuts and progressive rings or steel for the assembly of steel tubes.  
For stainless steel tubes material no. 1.4571 or 1.4541 and temperatures above 120 °C progressive rings and nuts of 1.4571 are to be used. (Please specify when ordering)

**Attention:**

For stainless steel tubes always pre-assembly in hardened pre-installation body (see assembly instructions).

**Note:** adjust gland packing prior to initial working period.

**Specification of:**

- material
- pressure
- DN size
- identification mark on hand wheel.

TABLE OF CONTENTS

VISUAL INDEX

FAQs

ASSEMBLY

TUBE FAB EQUIP

GEN TECH

Series	D1	PN (bar)	DN	Thread	D2	H	L	I	h	D	Weight g/1 piece	With Nut and Ring	
												Dry Technology EO-2	PSR steel
S <sup>4)</sup>	06	630	4	M 14×1.5	9.5	120	95	66	6	100	891	VDHA06ZS	VDHA06S
	08	630	5	M 16×1.5	9.5	120	95	66	6	100	917	VDHA08ZS	VDHA08S
	10	630	7	M 18×1.5	9.5	120	97	65	6	100	937	VDHA10ZS	VDHA10S
	12	630	8	M 20×1.5	9.5	120	97	65	6	100	940	VDHA12ZS	VDHA12S
	14	630	10	M 22×1.5	9.5	120	119	84	6	100	1194	VDHA14ZS	VDHA14S
	16	400	11	M 24×1.5	9.5	120	119	83	6	100	1209	VDHA16ZS	VDHA16S
	20	400	13	M 30×2.0	11.0	120	122	79	6	100	1292	VDHA20ZS	VDHA20S
	25	400	17	M 36×2.0	12.0	143	154	106	9	125	2013	VDHA25ZS	VDHA25S
	30	250	19	M 42×2.0	22.5	164	156	103	12	125	2596	VDHA30ZS	VDHA30S
	38	250	25	M 52×2.0	26.5	198	179	118	12	180	4972	VDHA38ZS	VDHA38S

<sup>1)</sup> Pressure shown = item deliverable

<sup>4)</sup> S = heavy series

$\frac{PN \text{ (bar)}}{10} = PN \text{ (MPa)}$



[Click here for CADs, Support Resources or to Configure Parts Online](#)

## VDHB

High Pressure Valve – Panel Mount  
24° Flareless / 24° Flareless

TUBE FITTING PART #	END SIZE (mm)	DN SIZE (mm)	M Metric	d1 (mm)	d2 (mm)	D (mm)	h Lift (mm)	H (mm)	I (mm)	Pressure Rating (bar)	
										EO	EO-2
										71	71
VDHB06S	6	4	14 x 1.5	4	9.5	100	6	124	66	400	400
VDHB08S	8	4	16 x 1.5	5	9.5	100	6	124	66	400	400
VDHB10S	10	6	18 x 1.5	7	9.5	100	6	124	65	400	400
VDHB12S	12	8	20 x 1.5	8	9.5	100	6	124	65	400	400
VDHB14S	14	10	22 x 1.5	10	9.5	100	6	124	84	400	400
VDHB16S	16	12	24 x 1.5	11	9.5	100	6	124	83	400	400
VDHB20S	20	16	30 x 2	13	11.0	100	6	124	79	400	400
VDHB25S	25	20	36 x 2	17	12.0	125	9	153	106	400	400

For EO-2 part number, insert "Z" between size and pressure series.  
Example: VDHB06ZS

**Note:** The pressure specification PN for hand operated shut-off valves applies to the design factor 1.5 (according to DIN 3230 T5 and ISO 5208).

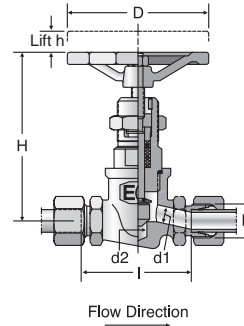

External threaded spindle and body of low grade forged stainless steel

TABLE OF CONTENTS

VISUAL INDEX

D

FAQs

ASSEMBLY

TUBE FAB EQUIP

GEN TECH

[Click here for CADs, Support Resources or to Configure Parts Online](#)

# KH

Two-Way Ball Valve  
24° Flareless / 24° Flareless

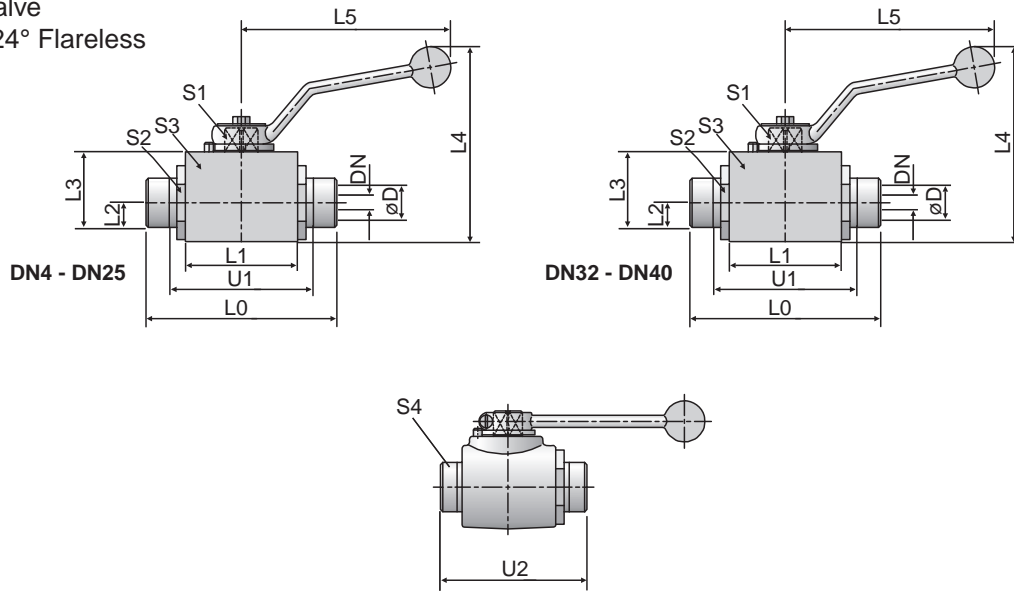

TABLE OF CONTENTS

VISUAL INDEX

FAQs

ASSEMBLY

TUBE FAB EQUIP

GEN TECH

Series	D	DN	L0	L1	L2	L3	L4	L5	U1	U2	S1	S2	S3	S4	Weight g/1 piece	Order code	PN (bar)	
L <sup>1)</sup>	06	4	67	36.0	9.5	25	54.5	76	53	82	7	19	20	14	195	KH06LCFX	500	
	08	6	67	36.0	9.5	25	54.5	76	53	82	7	19	20	17	190	KH08LCFX	500	
	10	8	75	45.0	14.5	35	67.5	100	61	90	8	24	30	19	420	KH10LCFX	500	
	12	10	75	45.0	14.5	35	67.5	100	61	90	8	24	30	22	410	KH12LCFX	500	
	15	13	83	51.0	17.0	40	93.0	113	69	99	10	30	35	27	631	KH15LCFX	500	
	18	16	82	50.0	20.0	45	98.0	113	67	99	10	36	45	32	850	KH18LCFX	420	
	22	20	99	60.0	24.0	55	120.0	171	84	116	14	41	45	36	1210	KH22LCFX	420	
	28	25	108	70.0	26.0	60	125.0	171	93	126	14	50	55	41	1750	KH28LCFX	420	
	35	32/25	116	70.0	26.0	60	125.0	171	95	138	14	50	55	50	1820	KH35LDN25CFX	420	
	35	32	121	79.0	49.5	95	188.0	228	100	143	17	60	Ø99	50	4888	KH35LCFX	420	
	42	40/25	121	70.0	26.0	60	125.0	171	99	144	14	55	55	60	1940	KH42LDN25CFX	420	
	42	40	118	77.5	54.5	105	198.0	228	96	141	17	75	Ø109	60	5590	KH42LCFX	420	
	S <sup>2)</sup>	08	5	73	36.0	9.5	25	54.5	76	59	88	7	19	20	19	214	KH08SCFX	500
		10	6	73	36.0	9.5	25	54.5	76	58	90	7	19	20	22	220	KH10SCFX	500
		12	8	77	45.0	14.5	35	67.5	100	62	94	8	24	30	24	430	KH12SCFX	500
14		10	81	45.0	14.5	35	67.5	100	65	100	8	24	30	27	440	KH14SCFX	500	
16		13	87	51.0	17.0	40	93.0	113	70	106	10	30	35	30	649	KH16SCFX	500	
20		16	90	50.0	20.0	45	98.0	113	69	112	10	36	45	36	900	KH20SCFX	420	
25		20	107	60.0	24.0	55	120.0	171	83	131	14	41	45	46	1290	KH25SCFX	420	
30		25	120	70.0	26.0	60	125.0	171	93	146	14	50	55	50	1880	KH30SCFX	420	
38		32/25	134	70.0	26.0	60	125.0	171	102	163	14	55	55	60	1950	KH38SDN25CFX	420	
38		32	127	73.0	49.5	95	188.0	228	95	156	17	60	Ø99	60	4740	KH38SCFX	420	

<sup>1)</sup>L = light series; <sup>2)</sup>S = heavy series

PN (bar) = PN (MPa) / 10

Delivery without nut and ring.

Order code suffixes			
Material	Suffix surface and material	Example	Standard sealing material (no additional suffix needed)
Steel, zinc plated, Cr(VI)-free	CF	KH06LCFX	POM / NBR

**WARNING:** This product can expose you to chemicals including Lead and Lead Compounds which is known to the State of California to cause cancer and birth defects or other reproductive harm. For more information go to [www.p65warnings.ca.gov](http://www.p65warnings.ca.gov).

[Click here for CADs, Support Resources or to Configure Parts Online](#)

# KH

Two-Way Ball Valve  
24° Flareless / 24° Flareless  
Stainless Steel

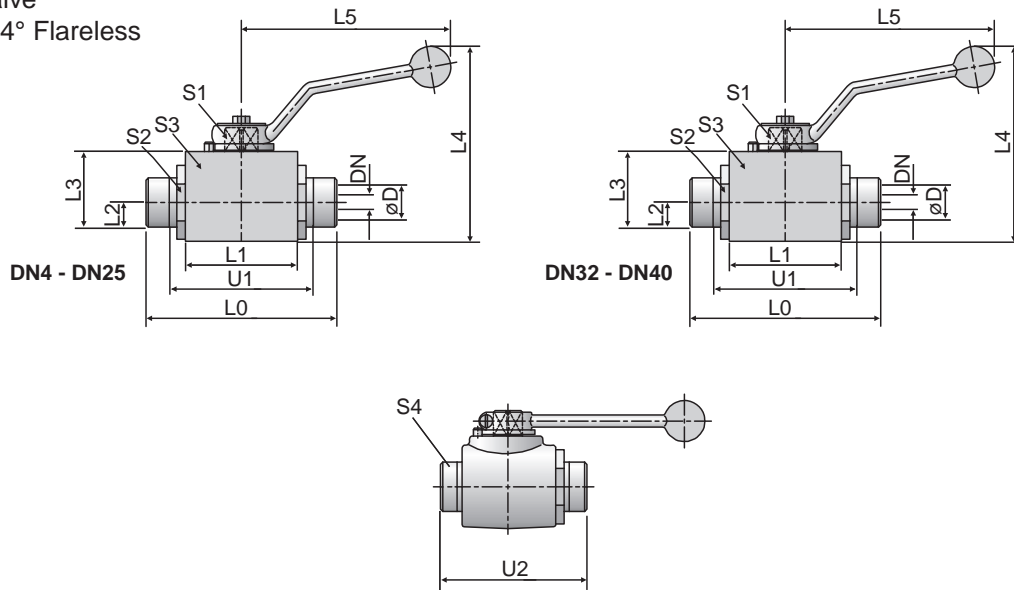

- TABLE OF CONTENTS
- VISUAL INDEX
- D
- FAQs
- ASSEMBLY
- TUBE FAB EQUIP
- GEN TECH

Series	D	DN	L0	L1	L2	L3	L4	L5	U1	U2	S1	S2	S3	S4	Weight g/1 piece	Order code	PN (bar)
L <sup>1)</sup>	06	4	73	41.5	13.5	30.0	54	80.0	58.5	88	7	22	30	14	391	KH06L71X	500
	08	6	73	41.5	13.5	30.0	54	80.0	58.5	88	7	22	30	17	392	KH08L71X	500
	10	8	87	53.0	18.0	40.0	82	132.5	73.0	102	8	30	40	19	833	KH10L71X	500
	12	10	87	53.0	18.0	40.0	82	132.5	73.0	102	8	30	40	22	812	KH12L71X	500
	15	12	91	55.0	21.0	45.0	87	132.5	76.5	107	10	32	45	27	1018	KH15L71X	500
	18	12	91	55.0	21.0	45.0	87	132.5	75.5	108	10	32	45	32	1059	KH18L71X	500
	22	20	105	65.0	31.0	65.0	118	190.0	89.5	122	14	46	65	36	2427	KH22L71X	400
	28	25	112	71.0	38.0	75.0	128	190.0	96.5	130	14	50	75	41	3313	KH28L71X	400
	35	32	145	86.0	45.0	93.0	174	320.0	123.5	167	19	70	Ø100	50	6230	KH35L71X	400
	42	40	150	92.0	52.0	104.5	185	320.0	127.5	173	19	80	Ø110	60	7706	KH42L71X	400
S <sup>2)</sup>	08	4	76	41.5	13.5	30.0	54	80.0	61.5	91	7	22	30	19	390	KH08S71X	500
	10	6	76	41.5	13.5	30.0	54	80.0	60.5	91	7	22	30	22	406	KH10S71X	500
	12	8	89	53.0	18.0	40.0	82	132.5	74.0	106	8	30	40	24	855	KH12S71X	500
	14	10	93	53.0	18.0	40.0	82	132.5	77.0	112	8	30	40	27	850	KH14S71X	500
	16	12	96	55.0	21.0	45.0	87	132.5	78.5	115	10	32	45	30	1050	KH16S71X	500
	20	12	99	55.0	21.0	45.0	87	132.5	77.5	121	10	32	45	36	1090	KH20S71X	500
	25	20	113	65.0	31.0	65.0	118	190.0	88.5	137	14	46	65	46	2490	KH25S71X	400
	30	25	124	71.0	38.0	75.0	128	190.0	96.5	150	14	50	75	50	3430	KH30S71X	400
	38	32	145	86.0	45.0	93.0	174	320.0	112.5	174	19	70	Ø100	60	5881	KH38S71X	400

<sup>1)</sup>L = light series; <sup>2)</sup>S = heavy series

$$\frac{PN \text{ (bar)}}{10} = PN \text{ (MPa)}$$

Delivery without nut and ring.

Order code suffixes			
Material	Suffix surface and material	Example	Standard sealing material (no additional suffix needed)
Stainless Steel	71	KH06L71X	POM / NBR

**WARNING:** This product can expose you to chemicals including Lead and Lead Compounds which is known to the State of California to cause cancer and birth defects or other reproductive harm. For more information go to [www.p65warnings.ca.gov](http://www.p65warnings.ca.gov).

[Click here for CADs, Support Resources or to Configure Parts Online](#)

# KH-BSP

Two-Way Ball Valve  
Female BSP / Female BSP

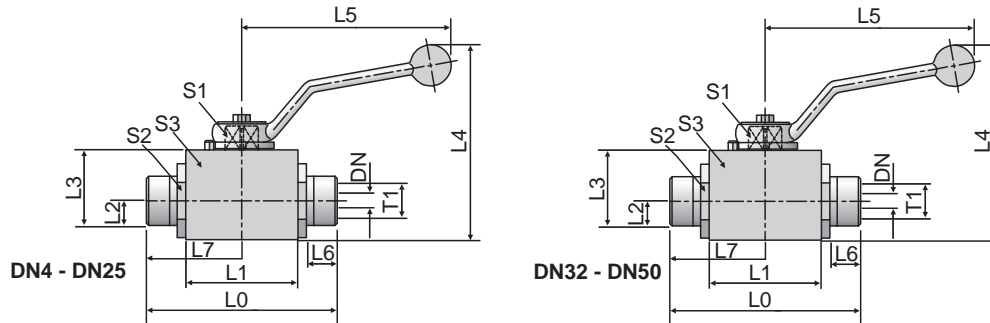

T1	DN	L0	L1	L2	L3	L4	L5	L6	L7	S1	S2	S3	Weight g/1 piece	Order code	PN (bar)
G 1/8	5	69	36	9.5	25	54.5	76	12	-	7	19	20	220	KH1/8CFX	500
G 1/4	6	69	36	9.5	25	54.5	76	12	-	7	19	20	210	KH1/4CFX	500
G 3/8	10	73	45	14.5	35	67.5	100	14	-	8	24	30	430	KH3/8CFX	500
G 1/2	13	82	51	17.0	40	93.0	113	15	-	10	30	35	670	KH1/2CFX	500
G 5/8	16	88	50	20.0	45	98.0	113	18	-	10	36	45	973	KH5/8CFX	420
G 3/4	20	93	60	24.0	55	120.0	171	18	-	14	41	45	1280	KH3/4CFX	420
G 1	25	115	70	26.0	60	125.0	171	20	-	14	50	55	1982	KH1CFX	420
G 1 1/4	32	110	80	49.5	95	188.0	228	22	55	17	60	Ø99	4888	KH11/4CFX	420
G 1 1/4	32/25	134	70	26.0	60	125.0	171	22	-	14	50	55	2066	KH11/4DN25CFX	420
G 1 1/2	40	114	82	54.5	105	198.0	228	24	57	17	75	Ø109	6330	KH11/2CFX	420
G 1 1/2	40/25	139	70	26.0	60	125.0	171	24	-	14	55	55	2200	KH11/2DN25CFX	420
G 2	50	133	100	62.0	120	212.0	306	26	65	17	85	Ø124	9220	KH2CFX	420

$$\frac{\text{PN (bar)}}{10} = \text{PN (MPa)}$$

Order code suffixes			
Material	Suffix surface and material	Example	Standard sealing material (no additional suffix needed)
Steel, zinc plated, Cr(VI)-free	CF	KH1/8CFX	POM / NBR

**WARNING:** This product can expose you to chemicals including Lead and Lead Compounds which is known to the State of California to cause cancer and birth defects or other reproductive harm. For more information go to [www.p65warnings.ca.gov](http://www.p65warnings.ca.gov).

Click here for CADs, Support Resources or to Configure Parts Online

# KH-BSP

Two-Way Ball Valve  
Female BSPP / Female BSPP  
Stainless Steel

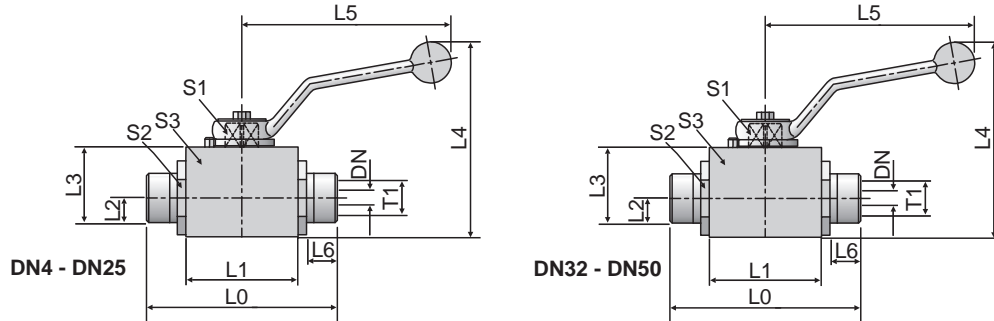

T1	DN	L0	L1	L2	L3	L4	L5	L6	S1	S2	S3	Weight g/1 piece	Order code	PN (bar)
G 1/8	4	69	41.5	13.5	30.0	54	80.0	11.0	7	22	30	420	KH1/871X	500
G 1/4	6	75	41.5	13.5	30.0	54	80.0	14.0	7	22	30	427	KH1/471X	500
G 3/8	10	86	53.0	18.0	40.0	82	132.5	14.0	8	30	40	902	KH3/871X	500
G 1/2	12	92	55.0	21.0	45.0	87	132.5	16.0	10	32	45	1100	KH1/271X	500
G 3/4	20	111	65.0	31.0	65.0	118	190.0	18.0	14	46	65	2699	KH3/471X	400
G 1	25	122	71.0	38.0	75.0	128	190.0	20.0	14	50	75	3620	KH171X	400
G 1 1/4	32	110	86.0	45.0	93.0	174	320.0	24.0	19	70	Ø100	5688	KH11/471X	400
G 1 1/2	40	120	92.0	52.0	104.5	185	320.0	26.0	19	80	Ø110	7379	KH11/271X	400
G 2	50	140	97.0	59.5	119.5	201	320.0	27.5	19	95	Ø125	10086	KH271X	400

$\frac{PN \text{ (bar)}}{10} = PN \text{ (MPa)}$

**WARNING:** This product can expose you to chemicals including Lead and Lead Compounds which is known to the State of California to cause cancer and birth defects or other reproductive harm. For more information go to [www.p65warnings.ca.gov](http://www.p65warnings.ca.gov).

Order code suffixes			
Material	Suffix surface and material	Example	Standard sealing material (no additional suffix needed)
Stainless Steel	71	KH1/871X	POM / NBR

- TABLE OF CONTENTS
- VISUAL INDEX
- D
- FAQs
- ASSEMBLY
- TUBE FAB EQUIP
- GEN TECH



[Click here for CADs, Support Resources or to Configure Parts Online](#)

# KH/NPT

Two-Way Ball Valve  
Female NPT / Female NPT

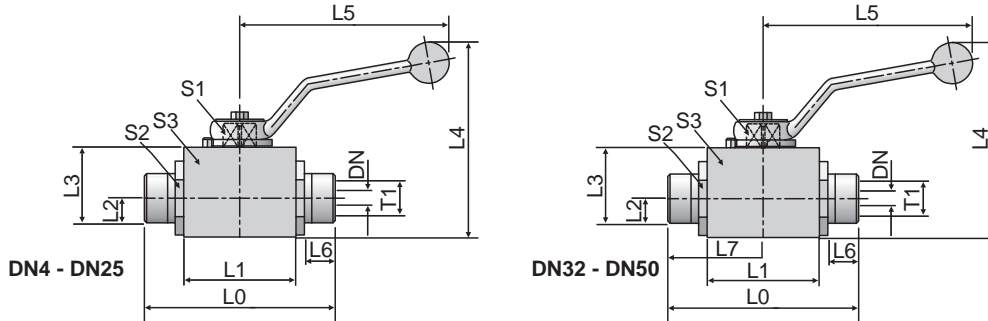

- TABLE OF CONTENTS
- VISUAL INDEX
- FAQs
- ASSEMBLY
- TUBE FAB EQUIP

GEN TECH

T1	DN	L0	L1	L2	L3	L4	L5	L6	L7	S1	S2	S3	Weight g/1 piece	Order code	PN (bar)
1/8-27 NPT	5	69	36	9.5	25	55	76	7.0	-	7	19	20	225	<b>KH1/8NPTCFX</b>	500
1/4-18 NPT	6	69	36	9.5	25	55	76	11.0	-	7	19	20	210	<b>KH1/4NPTCFX</b>	500
3/8-18 NPT	10	73	45	14.5	35	68	100	11.5	-	8	24	30	430	<b>KH3/8NPTCFX</b>	500
1/2-14 NPT	13	82	51	17.0	40	93	113	15.0	-	10	30	35	670	<b>KH1/2NPTCFX</b>	500
3/4-14 NPT	20	93	60	24.0	55	120	171	16.0	-	14	41	45	1300	<b>KH3/4NPTCFX</b>	420
1-11.5 NPT	25	115	70	26.0	60	125	171	19.0	-	14	50	55	2000	<b>KH1NPTCFX</b>	420
1 1/4-11.5 NPT	32	110	80	49.5	95	188	228	19.5	55	17	60	Ø99	4888	<b>KH11/4NPTCFX</b>	420
1 1/2-11.5 NPT	40	114	82	54.5	105	198	228	19.5	57	17	75	Ø109	5590	<b>KH11/2NPTCFX</b>	420
2-11.5 NPT	50	133	100	62.0	120	212	306	22.0	65	17	85	Ø124	9220	<b>KH2NPTCFX</b>	420

$\frac{PN \text{ (bar)}}{10} = PN \text{ (MPa)}$

Order code suffixes			
Material	Suffix surface and material	Example	Standard sealing material (no additional suffix needed)
Steel, zinc plated, Cr(VI)-free	CF	KH1/8NPTCFX	POM / NBR

[Click here for CADs, Support Resources or to Configure Parts Online](#)

# KH/NPT

Two-Way Ball Valve  
Female NPT / Female NPT  
Stainless Steel

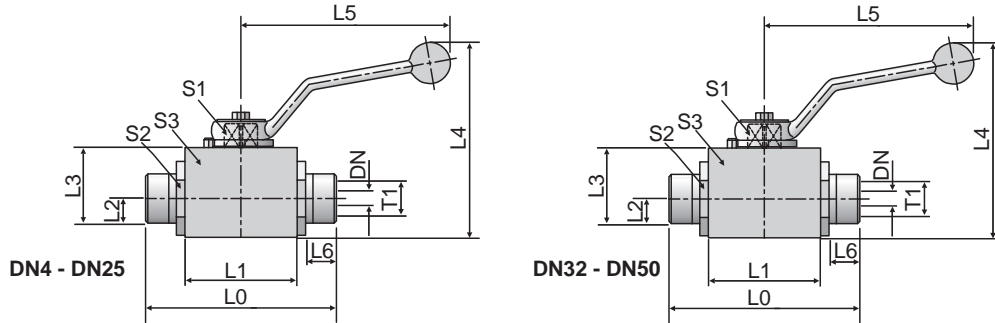

T1	DN	L0	L1	L2	L3	L4	L5	L6	S1	S2	S3	Weight g/1 piece	Order code	PN (bar)
1/8-27 NPT	4	82	41.5	13.5	30.0	54	80.0	8.0	7	22	30	431	<b>KH1/8NPT71X</b>	500
1/4-18 NPT	6	82	41.5	13.5	30.0	54	80.0	11.5	7	22	30	436	<b>KH1/4NPT71X</b>	500
3/8-18 NPT	10	95	53.0	18.0	40.0	82	132.5	11.5	8	30	40	956	<b>KH3/8NPT71X</b>	500
1/2-14 NPT	12	108	55.0	21.0	45.0	87	132.5	15.0	10	32	45	1204	<b>KH1/2NPT71X</b>	500
3/4-14 NPT	20	111	65.0	31.0	65.0	118	190.0	16.0	14	46	65	2723	<b>KH3/4NPT71X</b>	400
1-11.5 NPT	25	122	71.0	38.0	75.0	128	190.0	19.0	14	50	75	3646	<b>KH1NPT71X</b>	400
1 1/4-11.5 NPT	32	110	86.0	45.0	93.0	174	320.0	19.5	19	70	Ø100	5887	<b>KH11/4NPT71X</b>	400
1 1/2-11.5 NPT	40	120	92.0	52.0	104.5	185	320.0	19.5	19	80	Ø110	7430	<b>KH11/2NPT71X</b>	400
2-11.5 NPT	50	140	97.0	59.5	119.5	201	320.0	25.0	19	95	Ø125	10100	<b>KH2NPT71X</b>	400

PN (bar) = PN (MPa)  
10

Order code suffixes			
Material	Suffix surface and material	Example	Standard sealing material (no additional suffix needed)
Stainless steel	71	KH1/8NPT71X	POM / NBR

TABLE OF CONTENTS

VISUAL INDEX

D

FAQs

ASSEMBLY

TUBE FAB EQUIP

GEN TECH

[Click here for CADs, Support Resources or to Configure Parts Online](#)

# WV

## Alternating Valve 24° Flareless

These valves permit the passage of flow from either inlet 1 or 2 to the outlet port whilst shutting of the inlet port not in use. The shutting off, of an inlet is achieved by a floating ball bearing which moves by the pressure of the flow.

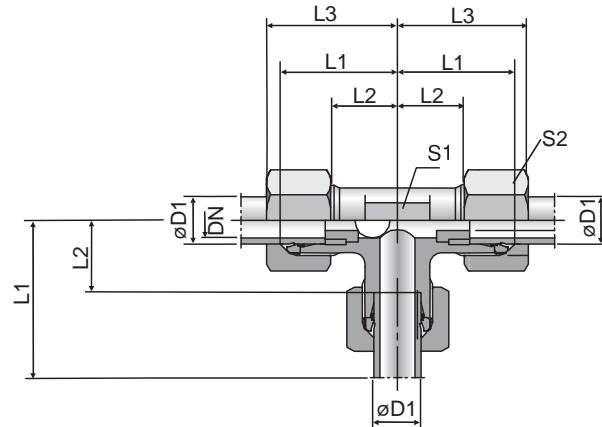

Directions of flow:

$D_1 \rightarrow D_3 = D_2$  closed  
 $D_2 \rightarrow D_3 = D_1$  closed

Material: steel  
Surface finish: Cr(VI)-free.

Valves are not recommended for compressed air and gases. WV-valves are not to be used in connection with weld nipples, swivel nuts etc. where there is no contact with a shoulder stop in the inner cone.

Temperature range without pressure reductions:  $-40^{\circ}\text{C}$  up to  $+120^{\circ}\text{C}$ .

Recommended fitting position as shown in the picture.

Leakage rate for alternating valves hydraulic test with test pressure =  $P_{\text{max}}$ : approx. 20 drops (test period of 1 minute).

Series	D1	T1	DN	L1	L2	L3	S1	S2	Weight g/1 piece	Order code*	PN (bar) <sup>1)</sup> CF
L <sup>3)</sup>	8	M 14x1.5	4.5	21	14	29	14	17	53	WV08LOMD	160
	10	M 16x1.5	6.0	22	15	30	17	19	73	WV10LOMD	160
	12	M 18x1.5	7.5	24	17	32	19	22	96	WV12LOMD	160
	15	M 22x1.5	10.0	28	21	36	19	27	134	WV15LOMD	160

<sup>1)</sup> Pressure shown = item deliverable

<sup>3)</sup> L = light series

$$\frac{\text{PN (bar)}}{10} = \text{PN (MPa)}$$

Delivery without nut and ring. Information on ordering complete fittings or alternative sealing materials see page D13.

**WARNING:** This product can expose you to chemicals including Lead and Lead Compounds which is known to the State of California to cause cancer and birth defects or other reproductive harm. For more information go to [www.p65warnings.ca.gov](http://www.p65warnings.ca.gov).

\*Please add the suffixes below according to the material/surface required.

Order code suffixes			
Material	Suffix surface and material	Example	Standard sealing material (no additional suffix needed)
Steel, zinc plated, Cr(VI)-free	CF	WV08LOMDCF	Steel ball

- TABLE OF CONTENTS
- VISUAL INDEX
- FAQs
- ASSEMBLY
- TUBE FAB EQUIP
- GEN TECH

E

# PIPE FITTINGS & PORT ADAPTERS















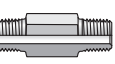



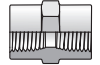







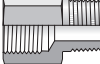



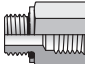





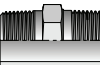

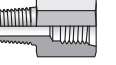



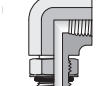
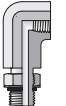

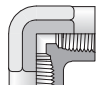
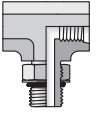
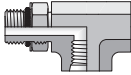
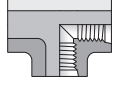
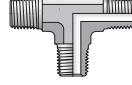
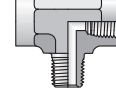
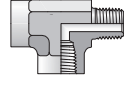

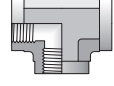

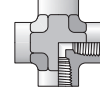



<b>Nipples</b>	<b>F5OHAO</b> SAE-ORB / SAE-ORB  E12	<b>F5OF</b> SAE-ORB / NPTF  E12	<b>FF</b> NPTF / NPTF  E12	<b>FFF</b> NPTF / NPTF Long  E12	<b>F8OHA8O</b> Metric-ORR / Metric-ORR  E13
	<b>FF33M</b> BSPT / BSPT  E13	<b>Couplings</b>	<b>G5HG5</b> SAE-ORB / SAE-ORB  E13	<b>GG</b> NPTF / NPTF  E13	<b>G8HG8</b> Metric-ORR / Metric-ORR  E14
<b>Reducers, Expanders, Conversions</b>	<b>F5OG5</b> SAE-ORB / SAE-ORB  E15		<b>F5OG</b> SAE-ORB / NPTF  E15	<b>F5OHG8</b> SAE-ORB / Metric  E16	<b>F5OHF42</b> SAE-ORB / BSPP-ED  E16
	<b>FHG5</b> NPTF / SAE-ORB  E16	<b>FG</b> NPTF / NPTF  E17	<b>PTR</b> Pipe Thread Reducer  E17	<b>FHG8</b> NPTF / Metric  E17	<b>FHG4</b> NPTF / BSPP  E17
<b>F8OHG5</b> Metric-ORR / SAE-ORB  E18	<b>F8OHG</b> Metric-ORR / NPTF  E18	<b>F82HG8</b> Metric-ED / Metric-ORR  E19	<b>F4OHG5</b> BSPP-ORR / SAE-ORB  E19	<b>F4OHG</b> BSPP-ORR / NPTF  E19	<b>GHG4</b> BSPP / NPTF  E19
<b>PTR34M</b> BSPT / BSPP  E19	<b>RI-ED</b> BSPP-ED / BSPP  E20	<b>RI</b> BSPP-CF / BSPP  E21	<b>FHF3</b> BSPT / NPTF  E22	<b>F3HG</b> BSPT / NPTF  E22	<b>F3HG5</b> BSPT / SAE-ORB  E22
<b>45° Elbows</b>	<b>CD45</b> NPTF / NPTF  E22	<b>DD45</b> NPTF / NPTF  E23	<b>90° Elbows</b>	<b>AOEG5</b> SAE-ORB / SAE-ORB  E23	<b>AOEG</b> SAE-ORB / NPTF  E23
	<b>AOE4G</b> SAE-ORB / NPTF Long  E23	<b>CR</b> NPTF / NPTF  E24		<b>CD</b> NPTF / NPTF  E24	<b>DD</b> NPTF / NPTF  E24

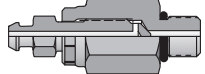



TABLE OF CONTENTS









E

<b>G5G5JAO</b> SAE-ORB Branch Tee  E25	<b>AOG5JG5</b> SAE-ORB Run Tee  E26	<b>G5G5JG5</b> SAE-ORB Tee  E26	<b>RRS</b> NPTF Tee  E26	<b>MMS</b> NPTF Branch Tee  E27	<b>MRO</b> NPTF Run Tee  E27
<b>MMO</b> NPTF Tee  E27	<b>MMO444M</b> BSPP Tee  E27	 Cross	<b>KMMOO</b> NPTF Cross  E28	 Plugs and Caps	<b>P5ON</b> SAE-ORB Hex Head  E28
<b>HP5ON</b> SAE-ORB Hollow Hex  E28	<b>HP</b> NPTF Hex Head  E28	<b>SHP</b> NPTF Square Head  E29	<b>HHP</b> NPTF Hollow Hex Head  E29	<b>HPC</b> NPTF Pipe Cap  E29	<b>P87OMN</b> ISO 6149 Hex Head  E29
<b>VSTI M-OR</b> ISO 6149 Hollow Hex  E30	<b>VSTI M-ED</b> Metric-ED Hollow Hex  E30	<b>VSTI R-ED</b> BSPP-ED Hollow Hex  E30	<b>P47OMN</b> BSPP-ORB Hex Head  E30	<b>HP3M</b> BSPT Hex Head  E31	

**Bleed Adapters (Shown in Section L)**

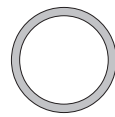
 Bleed Adapters	<b>P5ONBA</b> Bleed Screw / Bleed Adapter  L10	<b>HPBA</b> Bleed Screw / NPT  L10
---	--	--

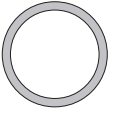
**O-Rings and Seals (Shown in Section M)**

 O-Rings and Seals	<b>SAE O-Ring</b>  M4	<b>ISO 6149 O-Ring</b>  M5	<b>Metric O-Ring</b>  M5	<b>Metric Retaining Ring</b>  M5	<b>BSPP O-Ring</b>  M6
<b>BSPP Retaining Ring</b>  M6	<b>EoElastic Seal Ring</b>  M6				

# Pipe Fittings and Port Adapters

This Section contains adapters with thread types including: NPT, NPTF, BSPT, BSPP, SAE UN/UNF, and Metric. All the threads in this section are made to industry specifications with conformance shown in Table E1.

## Design and Construction

Shaped products (elbows, tees and crosses) are hot forged and machined, while straights are manufactured from cold drawn barstock. Where applicable, these products are made in conformance with the design criteria of the Society of Automotive Engineers Standards, SAE J514, J530.

Imperial tapered pipe products made from steel and brass, for the most part, have NPTF threads. Stainless steel products may have NPT or slightly modified NPT threads to minimize the chance of galling on assembly.

**Standard Material Specifications:** The standard materials used in the manufacture of Industrial Pipe and Adapter fittings are shown in Table S34 on page S46.

**Finish** - Zinc plating with silver chromate (zinc chromium 6 free) is used on all standard steel products. Stainless steel fittings are passivated.

## How Port Connections Work

### Tapered (“Pipe”) Threads

There are three types of tapered threads commonly used in industrial applications.

- NPT/NPTF
- BSPT
- Metric Taper

All three thread styles noted above use the same basic metal-to-metal sealing design for achieving a seal. Although very similar, there are differences in the thread dimensions, pitch, and flank angle that do not allow interchangeability.

#### NPT / NPTF Threads

NPT threads, when assembled without a sealant, leave a spiral leak path at the crest-root junction as shown in Fig. E1. To seal pressurized fluid, NPT threads require a suitable sealant. NPTF threads (Dryseal), on the other hand, when assembled, do not leave the spiral leak path. This is because they have controlled truncation at the crest and root, ensuring metal-to-metal crest-root contact prior to, or just as the male-female thread flanks make contact as seen in Fig. E2. Upon further tightening, the thread crests are flattened out until the flanks also make metal-to-metal contact as seen in Fig. E3. Thus, theoretically at least, there is no passage left for the fluid to leak, provided all surfaces are flawless and dimensions exact. **In reality, this is not the case and a sealant/lubricant is necessary to achieve a leak free joint, even with NPTF threads.** The sealant/lubricant fills all imperfections in the surfaces affecting the seal and also provides lubrication to ease assembly and minimize galling.

Thread	Standard
NPT	ANSI B1.20.1, FED-STD-H28/7
NPTF	SAE J476, ANSI B1.20.3, FED-STD-H28/8
BSPT	BS 21, ISO 7/1
BSPP	BS 2779, ISO 228/1
Metric	ISO 261, ANSI B1.13M, FED-STD-H28/21
UN/UNF*	ANSI B1.1, FED-STD-H28/2

\*Class 2A or 2B

Table E1 — Thread Conformance Standards

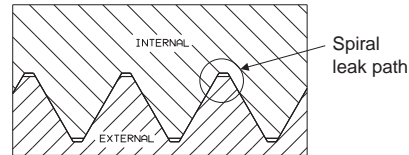

Fig. E1 — NPT: Wrench Tight, No Crest-Root Contact, Flank Contact Only

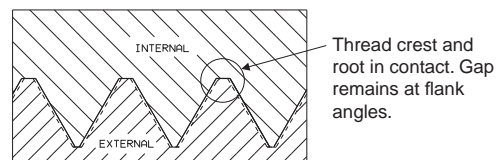

Fig. E2 — NPTF: Hand Tight, Crest to Root Contact

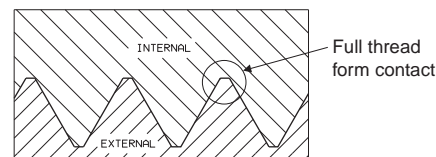

Fig. E3 — NPTF: Wrench Tight, Crest to Root and Flank Contact

**Need help determining which fittings goes with which metric port?  
Read our article for explanation.**

TABLE OF CONTENTS

VISUAL INDEX

## Application Guidelines for Tapered Threads

### Straight Connectors with NPT/NPTF 3/4-14 and Smaller

Straight connectors with 3/4-14 NPT/NPTF and smaller male pipe threads have very high pressure holding capability and seal reliability when used in applications without “make and break” (such as maintenance) requirements.

They are also well suited for low cycle non-pulsating (static) applications with pressures in excess of 6,000 psi.

### Straight Connectors with NPT/NPTF above 3/4 -14 and All Shaped Connectors with NPT/NPTF Threads

It is difficult to always tighten shapes with pipe threads to an optimum tightness level because of orientation requirements. Also, all connectors in this category with pipe threads have low reliability for leak free operation in dynamic applications. Therefore, they are not preferred where a leak free joint is required.

### All NPTF Connectors

While a pipe thread connection can be disassembled and re-assembled in low-pressure systems, it is not intended to be a frequently assembled and disassembled connection.

BSPT and metric taper are designed and perform similarly. Follow the NPT/NPTF guidelines for their application.

For the above applications, a port connection with an elastomeric seal, such as SAE straight thread port (SAE J1926/ISO11926), SAE four bolt split flange (SAE J518/ISO 6162), and ISO 6149 is recommended. For applications where elastomeric seals can't be used, consult the manufacturer.

In general, tapered thread connections have the following limitations which should be considered when specifying port connections:

- Poor dynamic sealing characteristics
- Possible expansion, and even cracking, of the port
- Orientation is a concern in shaped connectors
- Larger threads are more prone to leakage because of more potential leak points
- System contamination due to thread sealant
- Prone to galling, especially in stainless steel
- Limited remakeability

## Parallel Thread Adapters

Straight, or parallel, thread ports in various forms are becoming more popular in hydraulic systems because they are more reliable and easier to service.

Three types of threads are used for parallel thread ports:

- UN/UNF (SAE straight thread)
- BSPP (British Standard Pipe, Parallel)
- Metric parallel

Because parallel threads only serve one function (i.e. holding the fitting in place), some other means of sealing is always present, such as an elastomeric O-ring or a metal seal. There are many variations of sealing methods, and in some cases, they are interchangeable among the different thread forms and may appear to be similar.

## UN / UNF Threads

SAE J1926 uses UN/UNF threads and is often referred to as SAE Straight Thread. The female port is often referred to as ORB or O-ring boss. This port style, shown in Fig. E4, is widely used in North America.

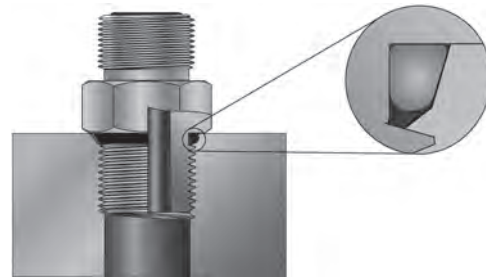

Fig. E4 — Typical O-Ring Boss Port

## BSPP

In Europe, Japan and many other former Commonwealth nations, the British Standard Pipe thread form, BSP, is still used extensively to connect pipes and components in hydraulic systems. The BSP thread is offered in a straight (parallel) form known as BSPP and a tapered form known as BSPT. These threads feature a 55° flank angle. Fittings in this section with male BSPP threads use a primary sealing method of an O-ring and retaining ring, as shown in Fig. E5.

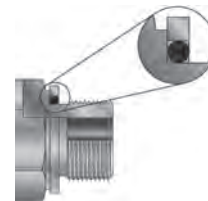

Fig. E5 — O-Ring with Retaining Ring

Additional sealing methods such as a cutting face or an EOlastic seal, as shown in Fig. E6, are also available on other fittings within the catalog. These BSPP fittings are all designed to thread into a female BSPP port (ISO 1179), however, the seal is created with one of the aforementioned sealing methods, not with the threads. It is also important to note that with these BSPP threaded connections, the seal occurs on the port surface, or spotface, not in an O-ring gland or chamfer as SAE and ISO-6149 straight threads do. A detail of the BSPP port is shown on page S37.

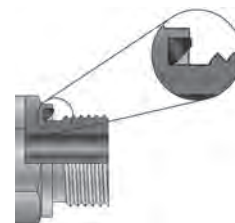

Fig. E6 — O-Ring in Fitting Groove

TABLE  
OF  
CONTENTS

VISUAL  
INDEX

E

### Metric Parallel

In Europe, primarily in Germany, the traditional metric parallel thread form is used extensively to connect components in hydraulic systems. This metric thread is designed to thread into and seal in a female Metric parallel port conforming to ISO-9974-1 (DIN-3852, Part 1). Fittings in this section with male metric threads use a primary sealing method of an O-ring and retaining ring (similar to Fig. E5). Additional sealing methods such as a cutting face or an EOlastic seal (similar to Fig. E6) are also available on other fittings within the catalog. Sealing is accommodated with one of the aforementioned sealing methods, not with the threads. It is also important to note that with these male metric threads, the seal occurs on the top face (spotface) of the port, not in an O-ring gland or chamfer as in SAE and ISO-6149 straight threads. A detail of this metric port is shown on page S34.

To minimize further proliferation of additional port thread styles, the International Standards Organization Technical Committee 131 completed the development of a world standard leak-free

port connection. It is recommended that this port, ISO 6149-1, be specified in all new hydraulic fluid power applications. Parker has expanded the product offering to incorporate the ISO 6149 male studs as a standard on many tube fitting products. Parker offers the ISO 6149 male stud end, shown in Fig. E7, on several tube fitting products including: Seal-Lok, Triple-Lok, EO, EO-2, Conversion Adapters, Plugs and more. This port, utilizes metric parallel threads for mechanical holding power and a sealing method similar to the SAE Straight Thread O-ring port. A detail of this metric port is shown on page S34.

TABLE  
OF  
CONTENTS

VISUAL  
INDEX

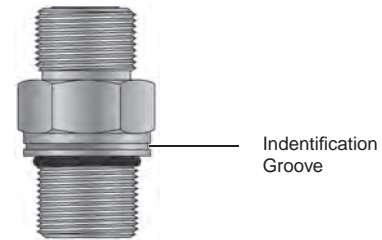

Fig. E7 — ISO 6149 Male

## Reference locations:

**Standard Material Specifications:** Refer to Table S34 in the General Technical Section on page S46.

**Assembly and Installation:** Please refer to Port End Assembly located within the Assembly/Installation section of this catalog.

**Dynamic Pressure Ratings:** Please refer to the last column of the part number tables located on the following pages of this section for the appropriate dynamic pressure ratings.

Dimensions and pressures for reference only, subject to change.

Feature	Advantage	Benefit
<b>Tapered Thread Fittings</b>		
Compact size	Suitable selection for plumbing in limited or tight space in a compact system.	Compact systems are more efficient and reduce the need for excessive routing of hose or tube
Widespread acceptability	Available worldwide for OEM and MRO applications	Eases efforts to find component parts and replacement fittings, reducing unnecessary downtime
High static pressure rating	Allows for use in high pressure applications	Increases versatility of fitting
Offered in three standard materials (Steel, Stainless Steel, and Brass)	Allows customer to match media and temperature applications without special fittings and seals.	Reduces component procurement costs and increases fitting availability
Adaptable to ORFS, Flareless Bite-type, Metric Bite-type, 37° flare, etc.	Versatility for end customer and for customer standardization efforts	Standardization reduces procurement costs
High temperature applications	Is not limited by temperature range of elastomeric seal	Increases versatility of fitting
<b>Straight Thread Fittings</b>		
Reliable sealing in dynamics applications	Ideal in systems with high pressure and cycling	Provides reliable, long-term sealing
Unlimited reusability/ remakeability	Extends the service life of the fitting	Reduces maintenance costs and component replacement costs
No thread sealant needed	Eliminates the potential for contaminating and damaging sensitive hydraulic components due to thread sealant	Reduces maintenance costs and component replacement costs
Infinite positioning of shaped adapters	Eliminates potential of damaging adapter and/or component by incorrectly assembling to accomplish correct orientation	Improves assembly time and reduces maintenance costs
Elastomeric seal	Tolerant of minor surface imperfections to provide leak-free connection	Reduces operational and maintenance costs

TABLE OF CONTENTS

VISUAL INDEX

E



## Port Ends for SAE J1926-1 (ISO 11926-1) Port

TABLE  
OF  
CONTENTS

VISUAL  
INDEX

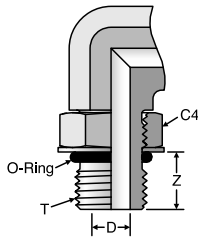

**SAE J1926  
Adjustable**

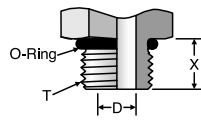

**SAE J1926  
Nonadjustable**

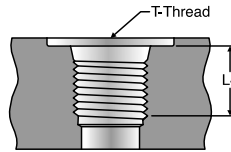

**SAE J1926-1  
Port<sup>2)</sup>**

	Thread	Locknut Hex	Drill	Minimum Thread	Stud Length	
SIZE	T UN/UNF	C4 (inch)	D Ref. (inch)	L4 Min (inch)	X (inch)	Z Max (inch)
<b>LIGHT DUTY (TRIPLE-LOK, FERULOK, ADAPTERS)</b>						
2	5/16-24	7/16	0.063	0.390	0.297	0.36
3	3/8-24	1/2	0.126	0.390	0.297	0.33
4	7/16-20	9/16	0.177	0.454	0.360	0.39
5	1/2-20	5/8	0.236	0.454	0.360	0.43
6	9/16-18	11/16	0.295	0.500	0.391	0.43
8	3/4-16	7/8	0.394	0.562	0.438	0.49
10	7/8-14	1	0.492	0.656	0.500	0.56
12	1 1/16-12	1 1/4	0.610	0.750	0.594	0.65
14	1 3/16-12	1 3/8	0.709	0.750	0.594	0.65
16	1 5/16-12	1 1/2	0.846	0.750	0.594	0.65
20	1 5/8-12	1 7/8	1.083	0.750	0.594	0.65
24	1 7/8-12	2 1/8	1.319	0.750	0.594	0.65
32	2 1/2-12	2 3/4	1.772	0.750	0.594	0.59
<b>HEAVY DUTY (SEAL-LOK)</b>						
2	5/16-24	1/2	0.063	0.390	0.374	0.38
3	3/8-24	9/16	0.118	0.390	0.374	0.39
4	7/16-20	5/8	0.177	0.454	0.433	0.43
5	1/2-20	11/16	0.236	0.454	0.433	0.44
6	9/16-18	3/4	0.264	0.500	0.472	0.47
8	3/4-16	15/16	0.378	0.562	0.551	0.54
10	7/8-14	1 1/16	0.484	0.656	0.630	0.63
12	1 1/16-12	1 3/8	0.610	0.750	0.728	0.73
14	1 3/16-12	1 1/2	0.709	0.750	0.728	0.73
16	1 5/16-12	1 5/8	0.811	0.750	0.728	0.73
20	1 5/8-12	1 7/8	1.024	0.750	0.728	0.73
24	1 7/8-12	2 1/8	1.260	0.750	0.728	0.73
32	2 1/2-12	2 3/4	1.575	0.750	0.728	0.73

1) See page M4 for SAE O-rings.

2) See page S23 for port details.

Dimensions and pressures for reference only, subject to change.

## Port Ends for ISO 6149-1 Port

TABLE  
OF  
CONTENTS

VISUAL  
INDEX

E

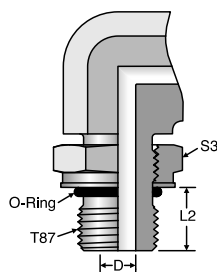

**ISO 6149  
Adjustable**

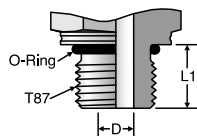

**ISO 6149  
Nonadjustable**

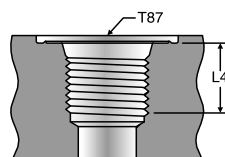

**ISO 6149  
Port<sup>2)</sup>**

	Thread	Drill	Minimum Thread	Stud Length		Lockhead Hex
SIZE	T87 Metric	D Ref. (mm)	L4 Min (mm)	L1 (mm)	L2 Max (mm)	S3 (mm)
<b>LIGHT DUTY (TRIPLE-LOK, FERULOK, ADAPTERS)</b>						
M8	M8X1	3	10.0	8.5	8.7	12
M10	M10X1	4.5	10.0	8.5	8.7	14
M12	M12X1.5	6	11.5	11.0	11.1	17
M14	M14X1.5	7.5	11.5	11.0	11.1	19
M16	M16X1.5	9	13.0	11.5	11.6	22
M18	M18X1.5	11	14.5	12.5	12.6	24
M20	M20X1.5	—	14.5			—
M22	M22X1.5	14	15.5	13.0	13.0	27
M27	M27X2	18	19.0	16.0	16.0	32
M30	M30X2	—	19.0			—
M33	M33X2	23	19.0	16.0	16.0	41
M38	M38X2	—	19.0			—
M42	M42X2	30	19.5	16.0	16.0	50
M48	M48X2	36	22.0	17.5	17.3	55
M60	M60X2	44	24.5	17.5	17.3	65
<b>HEAVY DUTY (SEAL-LOK)</b>						
M8	M8X1	2	10.0	9.5	9.7	12
M10	M10X1	3	10.0	9.5	9.7	14
M12	M12X1.5	4	11.5	11.0	11.1	17
M14	M14X1.5	6	11.5	11.0	11.1	19
M16	M16X1.5	7	13.0	12.5	12.6	22
M18	M18X1.5	9	14.5	14.0	14.1	24
M20	M20X1.5	11	14.5	14.0		—
M22	M22X1.5	12	15.5	15.0	15.0	27
M27	M27X2	15	19.0	18.5	18.0	32
M30	M30X2	18	19.0	18.5	18.5	36
M33	M33X2	20	19.0	18.5	18.5	41
M38	M38X2	26	19.0	18.5	19.0	46
M42	M42X2	26	19.5	19.0	19.0	50
M48	M48X2	32	22.0	21.5	21.5	55
M60	M60X2	40	24.5	24.0	24.0	65

1) See page M5 for ISO 6149 O-rings.

2) See page S22 for port details.

# NPTF and BSPT Port Ends

TABLE  
 OF  
 CONTENTS

VISUAL  
 INDEX

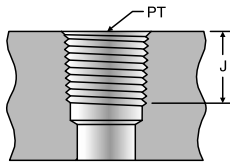

**NPTF and BSPT  
 Port**

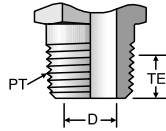

**NPTF and BSPT  
 Stud**

	Thread	Drill	Minimum Thread	Thread Engagement
SIZE	PT	D Ref. (inch)	J (inch)	TE (inch)
<b>NPTF</b>				
2	1/8-27	0.188	0.31	0.24
4	1/4-18	0.281	0.44	0.34
6	3/8-18	0.406	0.47	0.34
8	1/2-14	0.531	0.59	0.46
12	3/4-14	0.719	0.63	0.46
16	1-11 1/2	0.938	0.75	0.59
20	1 1/4-11 1/2	1.250	0.78	0.59
24	1 1/2-11 1/2	1.500	0.81	0.59
32	2-11 1/2	1.938	0.81	0.59
<b>BSPT</b>				
2	1/8-28	0.188	0.31	0.24
4	1/4-19	0.281	0.44	0.34
6	3/8-19	0.406	0.47	0.34
8	1/2-14	0.531	0.59	0.46
12	3/4-14	0.719	0.63	0.46
16	1-11	0.938	0.75	0.59
20	1 1/4-11	1.250	0.78	0.59
24	1 1/2-11	1.438	0.81	0.59
32	2-11	1.938	0.81	0.59

Dimensions and pressures for reference only, subject to change.

# Port Ends for ISO 9974-1 and 1179-1 Ports

TABLE  
OF  
CONTENTS

VISUAL  
INDEX

E

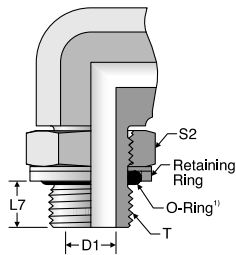

**ISO 9974 and 1179  
Adjustable O-Ring  
with Retaining Ring<sup>2)</sup>**

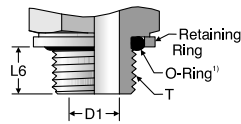

**ISO 9974 and 1179  
Non-Adjustable O-Ring  
with Retaining Ring<sup>2)</sup>**

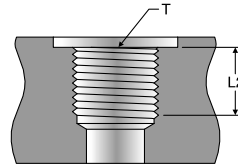

**ISO 9974<sup>3)</sup> and 1179<sup>4)</sup>  
Port**

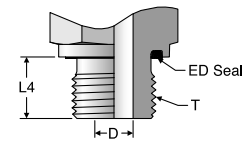

**ISO 9974 and 1179  
ED Seal**

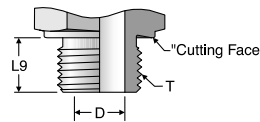

**ISO 9974 and 1179  
Cutting Face Seal**

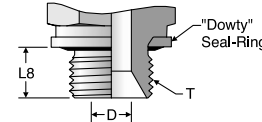

**Dowty<sup>®</sup> Seal Stud End for  
ISO 9974-1 and ISO 1179-1 Ports**

## ISO 9974

SIZE	Thread T Metric	D1 (mm)	Drill Ref.		Port Min Depth L2 (mm)	ED Stud L4 (mm)	O-Ring, RR Non- Adj Stud L6 (mm)	O-Ring, RR Adj- Stud L7 (mm)	O-Ring, RR Adj-Stud, Locknut Hex S2 (mm)	Dowty Seal Stud L8 (mm)	Cutting Face Stud L9 (mm)
			O-Ring, RR Stud	Light Duty (L Series)							
M8	M8X1	2	—	—	8	—	8.0	8.6	11	—	8
M10	M10X1	4	4	—	8	8	8.0	8.7	14	—	8
M12	M12X1.5	5	6	4	12	12	8.7	10.0	17	—	12
M14	M14X1.5	7	7	5	12	12	8.7	10.0	19	—	12
M16	M16X1.5	9	9	7	12	12	9.0	11.3	21	—	12
M18	M18X1.5	11	11	8	12	12	11.0	12.2	22	—	12
M20	M20X1.5	11	-	10	14	14	12.7	—	—	—	14
M22	M22X1.5	13	14	12	14	14	12.7	13.7	27	—	14
M26	M26X1.5	13	18	—	16	16	14.0	—	—	—	16
M27	M27X2	16	—	16	16	16	15.0	16.8	32	—	16
M33	M33X2	22	23	20	18	18	15.0	16.8	38	—	18
M42	M42X2	28	30	25	20	20	15.5	17.3	48	—	20
M48	M48X2	36	36	32	22	22	19.5	19.3	55	—	22
M60	M60X2	44	—	—	24.5	—	20.5	22.3	65	—	—

## ISO 1179

SIZE	Thread T BSP	D1 (mm)	Drill Ref.		Port Min Depth L2 (mm)	ED Stud L4 (mm)	O-Ring, RR Non- Adj Stud L6 (mm)	O-Ring, RR Adj- Stud L7 (mm)	O-Ring, RR Adj-Stud, Locknut Hex S2 (mm)	Dowty Seal Stud L8 (mm)	Cutting Face Stud L9 (mm)
			O-Ring, RR Stud	Light Duty (L Series)							
2	1/8-28	4.4	4	—	8	8	6.3	7.2	14	8	8
4	1/4-19	7.5	7	5	12	12	9.4	9.4	19	11	12
6	3/8-19	9.9	9	8	12	12	9.4	9.3	22	12	12
8	1/2-14	12.3	14	12	14	14	12.6	13.1	30	14	14
12	3/4-14	15.5	18	16	16	16	12.6	13.1	36	16	16
16	1-11	21.5	23	20	18	18	16.0	14.7	46	16	18
20	1-1/4-11	27.5	30	25	20	20	16.0	14.7	50	19	20
24	1-1/2-11	33.0	36	32	22	22	16.0	14.7	55	22	22
32	2-11	—	—	—	26	—	16.0	14.7	75	25	—

- 1) See Section M for O-rings and seals.
- 2) O-ring with retaining ring stud ends are not shown in ISO 9974.
- 3) See page S26 for ISO 9974-1 port details.
- 4) See page S25 for ISO 1179-1 port details.

Click here for CADs, Support Resources or to Configure Parts Online

## F50HAO

Straight Thread Union  
SAE-ORB / SAE-ORB

HPD Base # 0505

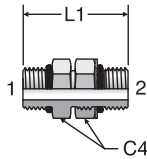

TUBE FITTING PART #	END SIZE		C4 HEX (in.)	L1 (in.)	Dynamic Pressure (x 1,000 PSI)		
	1	2			-S	-SS	-B
	UN/UNF-2A	UN/UNF-2A					
4 F50HAO	7/16 - 20	7/16 - 20	9/16	1.27	6.0	6.0	3.3
6 F50HAO	9/16 - 18	9/16 - 18	11/16	1.41	6.0	6.0	3.3
8 F50HAO	3/4 - 16	3/4 - 16	7/8	1.64	6.0	6.0	3.3
10 F50HAO	7/8 - 14	7/8 - 14	1	1.81	5.0	5.0	3.3
12 F50HAO	1 1/16 - 12	1 1/16 - 12	1 1/4	2.13	5.0	5.0	3.3
16 F50HAO	1 5/16 - 12	1 5/16 - 12	1 1/2	2.44	4.0	4.0	2.6
20 F50HAO	1 5/8 - 12	1 5/8 - 12	1 7/8	2.44	4.0	4.0	2.6
24 F50HAO	1 7/8 - 12	1 7/8 - 12	2 1/8	2.44	3.0	3.0	1.9
32 F50HAO	2 1/2 - 12	2 1/2 - 12	2 3/4	2.44	2.0	2.0	1.3

**WARNING:** This product can expose you to chemicals including Lead and Lead Compounds which is known to the State of California to cause cancer and birth defects or other reproductive harm. For more information go to [www.p65warnings.ca.gov](http://www.p65warnings.ca.gov).

## FF

Pipe Nipple  
NPTF / NPTF

HPD Base # 0101 SAE 140137

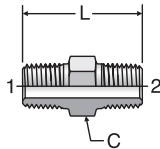

TUBE FITTING PART #	END SIZE		C HEX (in.)	L (in.)	Dynamic Pressure (x 1,000 PSI)		
	1	2			-S	-SS	-B
	NPTF	NPTF					
1/8 FF	1/8 - 27	1/8 - 27	7/16	1.06	6.0	7.2	3.9
1/4 x 1/8 FF	1/4 - 18	1/8 - 27	5/8	1.25	6.0	7.2	3.9
1/4 FF	1/4 - 18	1/4 - 18	5/8	1.45	6.0	7.2	3.9
3/8 x 1/8 FF	3/8 - 18	1/8 - 27	3/4	1.27	6.0	7.2	3.9
3/8 x 1/4 FF	3/8 - 18	1/4 - 18	3/4	1.45	6.0	7.2	3.9
3/8 FF	3/8 - 18	3/8 - 18	3/4	1.45	6.0	7.2	3.9
1/2 x 1/8 FF	1/2 - 14	1/8 - 27	7/8	1.52	6.0	7.2	3.3
1/2 x 3/8 FF	1/2 - 14	3/8 - 18	7/8	1.70	6.0	7.2	3.9
1/2 x 1/4 FF	1/2 - 14	1/4 - 18	7/8	1.70	6.0	7.2	3.9
1/2 FF	1/2 - 14	1/2 - 14	7/8	1.89	6.0	7.2	3.9
3/4 x 1/4 FF	3/4 - 14	1/4 - 18	1 1/8	1.78	5.5	6.6	3.5
3/4 x 3/8 FF	3/4 - 14	3/8 - 18	1 1/8	1.78	5.5	6.6	3.3
3/4 x 1/2 FF	3/4 - 14	1/2 - 14	1 1/8	1.96	5.5	6.6	3.5
3/4 FF	3/4 - 14	3/4 - 14	1 1/8	1.96	5.5	6.6	3.5
1 x 1/4 FF	1 - 11 1/2	1/4 - 18	1 3/8	1.96	4.5	5.4	3.3
1 x 3/8 FF	1 - 11 1/2	3/8 - 18	1 3/8	1.96	4.5	5.4	3.3
1 x 1/2 FF	1 - 11 1/2	1/2 - 14	1 3/8	2.09	4.5	5.4	3.3
1 x 3/4 FF	1 - 11 1/2	3/4 - 14	1 3/8	2.09	4.5	5.4	3.3
1 FF	1 - 11 1/2	1 - 11 1/2	1 3/8	2.34	4.5	5.4	3.0
1 1/4 x 1 FF	1 1/4 - 11 1/2	1 - 11 1/2	1 3/4	2.45	3.0	3.6	2.3
1 1/4 FF	1 1/4 - 11 1/2	1 1/4 - 11 1/2	1 3/4	2.48	3.0	3.6	2.3
1 1/2 x 1 FF	1 1/2 - 11 1/2	1 - 11 1/2	2	2.55	3.0	3.6	2.3
1 1/2 FF	1 1/2 - 11 1/2	1 1/2 - 11 1/2	2	2.61	3.0	3.6	2.3
2 x 1 1/2 FF	2 - 11 1/2	1 1/2 - 11 1/2	2 1/2	2.79	2.0	2.4	1.5
2 FF	2 - 11 1/2	2 - 11 1/2	2 1/2	2.83	2.0	2.4	1.5

**Note:** All steel "FF" fittings have a 30° chamfer for sealing with NPSM swivel type fittings.

**WARNING:** This product can expose you to chemicals including Lead and Lead Compounds which is known to the State of California to cause cancer and birth defects or other reproductive harm. For more information go to [www.p65warnings.ca.gov](http://www.p65warnings.ca.gov).

## F50F

Male Pipe Adapter  
SAE-ORB / NPTF

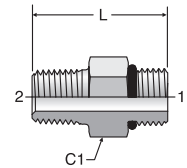

TUBE FITTING PART #	END SIZE		C1 HEX (in.)	L (in.)	Dynamic Pressure (x 1,000 PSI)		
	1	2			-S	-SS	-B
	UN/UNF-2A	NPTF					
4-1/8 F50F	7/16 - 20	1/8 - 27	9/16	1.00	6.0	6.0	3.3
4-1/4 F50F	7/16 - 20	1/4 - 18	9/16	1.20	6.0	6.0	3.3
5-1/4 F50F	1/2 - 20	1/4 - 18	5/8	1.20	6.0	6.0	3.3
6-1/4 F50F	9/16 - 18	1/4 - 18	11/16	1.25	6.0	6.0	3.3
6-3/8 F50F	9/16 - 18	3/8 - 18	11/16	1.34	6.0	6.0	3.3
8-1/4 F50F	3/4 - 16	1/4 - 18	7/8	1.36	6.0	6.0	3.3
8-3/8 F50F	3/4 - 16	3/8 - 18	7/8	1.36	6.0	6.0	3.3
8-1/2 F50F	3/4 - 16	1/2 - 14	7/8	1.53	6.0	6.0	3.3
10-1/2 F50F	7/8 - 14	1/2 - 14	1	1.59	6.0	6.0	3.3
12-1/2 F50F	1 1/16 - 12	1/2 - 14	1 1/4	1.80	5.0	6.0	3.3
12-3/4 F50F	1 1/16 - 12	3/4 - 14	1 1/4	1.80	5.0	6.0	3.3
16-3/4 F50F	1 5/16 - 12	3/4 - 14	1 1/2	1.78	4.5	5.4	2.9
16-1 F50F	1 5/16 - 12	1 - 11 1/2	1 1/2	1.98	4.5	5.4	2.9
20-1 1/4 F50F	1 5/8 - 12	1 1/4 - 11 1/2	1 7/8	2.02	3.0	3.6	1.9
24-1 1/2 F50F	1 7/8 - 12	1 1/2 - 11 1/2	2 1/8	2.25	3.0	3.0	1.9

**WARNING:** This product can expose you to chemicals including Lead and Lead Compounds which is known to the State of California to cause cancer and birth defects or other reproductive harm. For more information go to [www.p65warnings.ca.gov](http://www.p65warnings.ca.gov).

## FFF

Long Pipe Nipple  
NPTF / NPTF

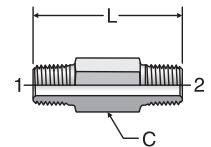

TUBE FITTING PART #	END SIZE		C HEX (in.)	L (in.)	Dynamic Pressure (x 1,000 PSI)		
	1	2			-S	-SS	-B
	NPTF	NPTF					
1/8 x 1.5 FFF	1/8 - 27	1/8 - 27	7/16	1.5	6.0	7.2	3.9
1/8 x 2.0 FFF	1/8 - 27	1/8 - 27	7/16	2.0	6.0	7.2	3.9
1/8 x 2.5 FFF	1/8 - 27	1/8 - 27	7/16	2.5	6.0	7.2	3.9
1/8 x 3.0 FFF	1/8 - 27	1/8 - 27	7/16	3.0	6.0	7.2	3.9
1/4 x 1.5 FFF	1/4 - 18	1/4 - 18	5/8	1.5	6.0	7.2	3.9
1/4 x 2.0 FFF	1/4 - 18	1/4 - 18	5/8	2.0	6.0	7.2	3.9
1/4 x 2.5 FFF	1/4 - 18	1/4 - 18	5/8	2.5	6.0	7.2	3.9
1/4 x 3.0 FFF	1/4 - 18	1/4 - 18	5/8	3.0	6.0	7.2	3.9
3/8 x 2.0 FFF	3/8 - 18	3/8 - 18	3/4	2.0	6.0	7.2	3.3
3/8 x 3.0 FFF	3/8 - 18	3/8 - 18	3/4	3.0	6.0	7.2	3.3
3/8 x 3.5 FFF	3/8 - 18	3/8 - 18	3/4	3.5	6.0	7.2	3.3
3/8 x 4.0 FFF	3/8 - 18	3/8 - 18	3/4	4.0	6.0	7.2	3.3
1/2 x 2.0 FFF	1/2 - 14	1/2 - 14	7/8	2.0	6.0	7.2	3.3
1/2 x 2.5 FFF	1/2 - 14	1/2 - 14	7/8	2.5	6.0	7.2	3.3
1/2 x 3.0 FFF	1/2 - 14	1/2 - 14	7/8	3.0	6.0	7.2	3.9
1/2 x 4.0 FFF	1/2 - 14	1/2 - 14	7/8	4.0	6.0	7.2	3.3
1/2 x 6.0 FFF	1/2 - 14	1/2 - 14	7/8	6.0	6.0	7.2	3.3
3/4 x 3.0 FFF	3/4 - 14	3/4 - 14	1 1/8	3.0	5.5	6.6	3.3
1 x 3.0 FFF	1 - 11 1/2	1 - 11 1/2	1 3/8	3.0	4.5	5.4	3.3

**WARNING:** This product can expose you to chemicals including Lead and Lead Compounds which is known to the State of California to cause cancer and birth defects or other reproductive harm. For more information go to [www.p65warnings.ca.gov](http://www.p65warnings.ca.gov).

Dimensions and pressures for reference only, subject to change.

TABLE OF CONTENTS

VISUAL INDEX

FAQs

ASSEMBLY

GEN TECH



Click here for CADs, Support Resources or to Configure Parts Online

## F80HA80

Metric Union  
Metric-ORR / Metric-ORR  
(for ISO 9974 / DIN 3852-1 Port)

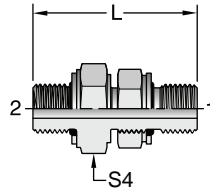

TUBE FITTING PART #	End Size		S4 Hex (mm)	L (mm)	Dynamic Pressure (x 1,000 PSI)		
	1 Metric Str	2 Metric Str			S	SS	B
M10F80HA80	M10X1	M10X1	16	33.8	6.0		
M12F80HA80	M12X1.5	M12X1.5	19	36.8	6.0		
M14F80HA80	M14X1.5	M14X1.5	22	37.3	6.0		
M16F80HA80	M16X1.5	M16X1.5	22	46.0	5.0		
M18F80HA80	M18X1.5	M18X1.5	27	48.8	5.0		
M20M18F80HA80	M20X1.5	M18X1.5	27	49.8	4.0		
M22F80HA80	M22X1.5	M22X1.5	27	52.6	4.0		
M27F80HA80	M27X2	M27X2	32	62.0	4.0		
M33F80HA80	M33X2	M33X2	41	62.0	3.0		

**WARNING:** This product can expose you to chemicals including Lead and Lead Compounds which is known to the State of California to cause cancer and birth defects or other reproductive harm. For more information go to [www.p65warnings.ca.gov](http://www.p65warnings.ca.gov).

## FF33M

BSPT Pipe Nipple  
BSPT / BSPT

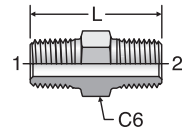

TUBE FITTING PART #	END SIZE		C6 HEX (mm)	L (mm)	Dynamic Pressure (x 1,000 PSI)		
	1 BSPT	2 BSPT			S	SS	B
1/8FF33M	1/8 - 28	1/8 - 28	11	27	6.0	6.0	3.3
1/4x1/8FF33M	1/4 - 19	1/8 - 28	14	32	6.0	6.0	3.3
1/4FF33M	1/4 - 19	1/4 - 19	14	37	6.0	6.0	3.3
3/8x1/4FF33M	3/8 - 19	1/4 - 19	17	37	6.0	6.0	3.3
3/8FF33M	3/8 - 19	3/8 - 19	17	37	6.0	6.0	3.3
1/2FF33M	1/2 - 14	1/2 - 14	22	48	6.0	6.0	3.3
1/2x3/8FF33M	1/2 - 14	3/8 - 19	22	43	6.0	6.0	3.3
3/4FF33M	3/4 - 14	3/4 - 14	27	50	5.5	5.5	3.3
3/4x1/2FF33M	3/4 - 14	1/2 - 14	27	50	5.5	5.5	3.3
1X3/4FF33M	1 - 11	3/4 - 14	36	55	4.5	4.5	2.9
1FF33M	1 - 11	1 - 11	36	59	4.5	4.5	2.9

**WARNING:** This product can expose you to chemicals including Lead and Lead Compounds which is known to the State of California to cause cancer and birth defects or other reproductive harm. For more information go to [www.p65warnings.ca.gov](http://www.p65warnings.ca.gov).

## G5HG5

Straight Thread Coupling  
Female SAE / Female SAE

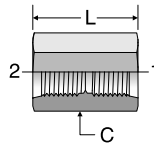

TUBE FITTING PART #	END SIZE		C HEX (in.)	L (in.)	Dynamic Pressure (x 1,000 PSI)		
	1 UN/UNF-2B	2 UN/UNF-2B			-S	-SS	-B
4 G5HG5	7/16 - 20	7/16 - 20	11/16	1.13	7.0	6.0	3.3
6 G5HG5	9/16 - 18	9/16 - 18	13/16	1.26	6.0	6.0	3.3
8 G5HG5	3/4 - 16	3/4 - 16	1	1.42	5.0	5.0	3.3
10 G5HG5	7/8 - 14	7/8 - 14	1 3/16	1.60	4.5	4.5	2.9
12 G5HG5	1 1/16 - 12	1 1/16 - 12	1 3/8	1.85	4.5	4.5	2.9
16 G5HG5	1 5/16 - 12	1 5/16 - 12	1 5/8	1.85	3.5	3.5	2.2

**WARNING:** This product can expose you to chemicals including Lead and Lead Compounds which is known to the State of California to cause cancer and birth defects or other reproductive harm. For more information go to [www.p65warnings.ca.gov](http://www.p65warnings.ca.gov).

## GG

Pipe Coupling  
NPTF / NPTF

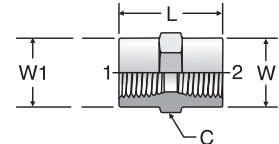

SAE 140138  
HPD Base # 0202

TUBE FITTING PART #	END SIZE		C HEX (in.)	L (in.)	W1 (in.)	W (in.)	Dynamic Pressure (x 1,000 PSI)		
	1 NPTF	2 NPTF					-S	-SS	-B
1/8 GG	1/8 - 27	1/8 - 27	5/8	0.75	0.63	0.63	6.0	6.0	3.9
1/4 x 1/8 GG	1/4 - 18	1/8 - 27	3/4	0.94	0.75	0.63	6.0	6.0	3.9
1/4 GG	1/4 - 18	1/4 - 18	3/4	1.13	0.75	0.75	6.0	6.0	3.9
3/8 x 1/8 GG	3/8 - 18	1/8 - 27	7/8	1.03	0.88	0.63	6.0	6.0	3.9
3/8 x 1/4 GG	3/8 - 18	1/4 - 18	7/8	1.13	0.88	0.75	6.0	6.0	3.9
3/8 GG	3/8 - 18	3/8 - 18	7/8	1.13	0.88	0.88	6.0	6.0	3.9
1/2 x 1/8 GG	1/2 - 14	1/8 - 27	1 1/8	1.06	1.13	0.63	6.0	6.0	3.2
1/2 x 1/4 GG	1/2 - 14	1/4 - 18	1 1/8	1.38	1.13	0.75	5.0	6.0	3.2
1/2 x 3/8 GG	1/2 - 14	3/8 - 18	1 1/8	1.50	1.13	0.88	5.0	6.0	3.2
1/2 GG	1/2 - 14	1/2 - 14	1 1/8	1.50	1.13	1.13	5.0	6.0	3.2
3/4 x 1/4 GG	3/4 - 14	1/4 - 18	1 3/8	1.55	1.36	0.75	4.0	4.8	3.1
3/4 x 1/2 GG	3/4 - 14	1/2 - 14	1 3/8	1.88	1.36	1.13	4.0	4.8	3.1
3/4 GG	3/4 - 14	3/4 - 14	1 3/8	1.53	1.38	1.38	4.0	4.8	2.6
1 GG	1 - 11 1/2	1 - 11 1/2	1 5/8	1.89	1.63	1.63	3.0	3.6	1.9
1 x 1/2 GG	1 - 11 1/2	1/2 - 14	1 5/8	1.77	1.63	1.13	3.0	3.6	1.9
1 x 3/4 GG	1 - 11 1/2	3/4 - 14	1 5/8	1.77	1.63	1.38	3.0	3.6	1.9
1 1/4 GG	1 1/4 - 11 1/2	1 1/4 - 11 1/2	2	1.93	2.00	2.00	2.5	3.0	1.9
1 1/4 x 1 GG	1 1/4 - 11 1/2	1 - 11 1/2	2	1.93	2.00	1.63	2.5	3.0	1.9
1 1/2 GG	1 1/2 - 11 1/2	1 1/2 - 11 1/2	2 3/8	1.93	2.38	2.38	2.0	2.4	1.5
1 1/2 x 1 1/4 GG	1 1/2 - 11 1/2	1 1/4 - 11 1/2	2 3/8	1.93	2.37	2.37	2.0	2.4	1.5
2 GG	2 - 11 1/2	2 - 11 1/2	2 7/8	1.97	2.88	2.88	2.0	2.4	1.5

**WARNING:** This product can expose you to chemicals including Lead and Lead Compounds which is known to the State of California to cause cancer and birth defects or other reproductive harm. For more information go to [www.p65warnings.ca.gov](http://www.p65warnings.ca.gov).

TABLE OF CONTENTS

VISUAL INDEX

E

FAQs

ASSEMBLY

GEN TECH

[Click here for CADs, Support Resources or to Configure Parts Online](#)

## G8HG8

Metric Female Union  
Metric-ORR / Metric-ORR  
(for ISO 9974 / DIN 3852-1 Port)

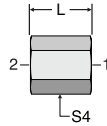

## GG44M

BSPP Female Union  
BSPP / BSPP

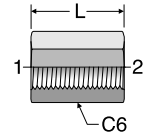

TUBE FITTING PART #	End Size		S4 Hex (mm)	L (mm)	Dynamic Pressure (x 1,000 PSI)	
	1	2			S	
	Metric Str	Metric Str				
M10G8HG8	M10X1	M10X1	17	19	6.0	
M14G8HG8	M14X1.5	M14X1.5	22	28	6.0	
M16G8HG8	M16X1.5	M16X1.5	24	29	6.0	
M18G8HG8	M18X1.5	M18X1.5	27	29	6.0	
M20G8HG8	M20X1.5	M20X1.5	32	32	5.0	
M27G8HG8	M27X2	M27X2	38	38	5.0	
M33G8HG8	M33X2	M33X2	46	44	5.0	

**WARNING:** This product can expose you to chemicals including Lead and Lead Compounds which is known to the State of California to cause cancer and birth defects or other reproductive harm. For more information go to [www.p65warnings.ca.gov](http://www.p65warnings.ca.gov).

TUBE FITTING PART #	END SIZE		C6 HEX (mm)	L (mm)	Dynamic Pressure (x 1,000 PSI)		
	1	2			S SS B		
	BSPP	BSPP					
1/8GG44M	1/8 - 28	1/8 - 28	14	19.0	6.0	6.0	3.3
1/4X1/8GG44M	1/4 - 19	1/8 - 28	17	24.0	6.0	6.0	3.3
1/4GG44M	1/4 - 19	1/4 - 19	17	28.0	6.0	6.0	3.3
3/8GG44M	3/8 - 19	3/8 - 19	22	28.0	6.0	6.0	3.3
3/8x1/4GG44M	3/8 - 19	1/4 - 19	22	28.0	6.0	6.0	3.3
1/2x3/8GG44M	1/2 - 14	3/8 - 19	27	31.0	5.0	5.0	3.3
1/2GG44M	1/2 - 14	1/2 - 14	27	32.5	5.0	5.0	3.3
1GG44M	1 - 11	1 - 11	46	42.0	3.0	3.0	1.9

**WARNING:** This product can expose you to chemicals including Lead and Lead Compounds which is known to the State of California to cause cancer and birth defects or other reproductive harm. For more information go to [www.p65warnings.ca.gov](http://www.p65warnings.ca.gov).

TABLE OF CONTENTS

VISUAL INDEX

FAQs

ASSEMBLY

GEN TECH

Dimensions and pressures for reference only, subject to change.

Click here for CADs, Support Resources or to Configure Parts Online

## F50G5

Straight Thread Reducer / Expander  
SAE-ORB / SAE-ORB

SAE 090136  
HPD Base # 0510

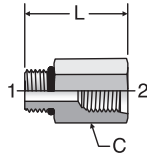

TUBE FITTING PART #	END SIZE		C HEX (in.)	L (in.)	Dynamic Pressure (x 1,000 PSI)		
	1 UN/UNF-2A	2 UN/UNF-2B			-S	-SS	-B
2-4 F50G5	5/16 - 24	7/16 - 20	11/16	1.03	7.5	7.5	3.3
4-4 F50G5	7/16 - 20	7/16 - 20	11/16	1.08	7.5	7.5	3.3
4-6 F50G5	7/16 - 20	9/16 - 18	13/16	1.16	6.0	6.0	3.3
6-4 F50G5	9/16 - 18	7/16 - 20	11/16	1.03	6.0	6.0	3.3
6-6 F50G5	9/16 - 18	9/16 - 18	13/16	1.16	6.0	6.0	3.3
6-8 F50G5	9/16 - 18	3/4 - 16	1 1/16	1.38	6.0	6.0	3.3
8-4 F50G5	3/4 - 16	7/16 - 20	7/8	1.13	6.0	6.0	3.3
8-6 F50G5	3/4 - 16	9/16 - 18	7/8	1.13	6.0	6.0	3.3
8-10 F50G5	3/4 - 16	7/8 - 14	1 1/8	1.56	4.5	4.5	2.9
10-4 F50G5	7/8 - 14	7/16 - 20	1	0.81	5.0	5.0	3.3
10-6 F50G5	7/8 - 14	9/16 - 18	1	1.26	5.0	5.0	3.3
10-8 F50G5	7/8 - 14	3/4 - 16	1	1.31	5.0	5.0	3.3
10-12 F50G5	7/8 - 14	1 1/16 - 12	1 3/8	1.69	4.5	4.5	2.9
12-4 F50G5	1 1/16 - 12	7/16 - 20	1 1/4	1.00	5.0	5.0	3.3
12-6 F50G5	1 1/16 - 12	9/16 - 18	1 1/4	1.00	5.0	5.0	3.3
12-8 F50G5	1 1/16 - 12	3/4 - 16	1 1/4	1.45	5.0	5.0	3.3
12-10 F50G5	1 1/16 - 12	7/8 - 14	1 1/4	1.53	5.0	5.0	3.3
12-16 F50G5	1 1/16 - 12	1 5/16 - 12	1 5/8	1.88	3.5	3.5	2.2
16-6 F50G5	1 5/16 - 12	9/16 - 18	1 1/2	1.00	4.5	4.5	2.9
16-8 F50G5	1 5/16 - 12	3/4 - 16	1 1/2	1.00	4.5	4.5	2.9
16-10 F50G5	1 5/16 - 12	7/8 - 14	1 1/2	1.00	4.5	4.5	2.9
16-12 F50G5	1 5/16 - 12	1 1/16 - 12	1 1/2	1.75	4.5	4.5	2.9
16-20 F50G5	1 5/16 - 12	1 5/8 - 12	2 1/8	1.97	3.0	3.0	1.9
20-6 F50G5	1 5/8 - 12	9/16 - 18	1 7/8	1.00	4.0	4.0	2.6
20-8 F50G5	1 5/8 - 12	3/4 - 16	1 7/8	1.00	4.0	4.0	2.6
20-10 F50G5	1 5/8 - 12	7/8 - 14	1 7/8	1.00	4.0	4.0	2.6
20-12 F50G5	1 5/8 - 12	1 1/16 - 12	1 7/8	1.00	4.0	4.0	2.6
20-16 F50G5	1 5/8 - 12	1 5/16 - 12	1 7/8	1.72	4.0	4.0	2.6
20-24 F50G5	1 5/8 - 12	1 7/8 - 12	2 1/2	1.88	3.0	3.0	1.9
24-6 F50G5	1 7/8 - 12	9/16 - 18	2 1/8	1.00	3.0	3.0	1.9
24-12 F50G5	1 7/8 - 12	1 1/16 - 12	2 1/8	1.00	3.0	3.0	1.9
24-16 F50G5	1 7/8 - 12	1 5/16 - 12	2 1/8	1.00	3.0	3.0	1.9
24-20 F50G5	1 7/8 - 12	1 5/8 - 12	2 1/8	1.75	3.0	3.0	1.9
32-20 F50G5	2 1/2 - 12	1 5/8 - 12	2 3/4	1.00	2.0	2.0	1.3
32-24 F50G5	2 1/2 - 12	1 7/8 - 12	2 3/4	1.80	2.0	2.0	1.3

**WARNING:** This product can expose you to chemicals including Lead and Lead Compounds which is known to the State of California to cause cancer and birth defects or other reproductive harm. For more information go to [www.p65warnings.ca.gov](http://www.p65warnings.ca.gov).

## F50G

Female Pipe Adapter  
SAE-ORB / NPTF

SAE 090156

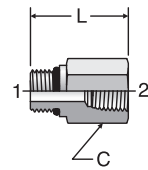

TUBE FITTING PART #	END SIZE		C HEX (in.)	L (in.)	Dynamic Pressure (x 1,000 PSI)		
	1 UN/UNF-2A	2 NPTF			-S	-SS	-B
2-1/8 F50G	5/16 - 24	1/8 - 27	9/16	0.91	6.0	6.0	3.3
4-1/8 F50G	7/16 - 20	1/8 - 27	9/16	1.00	6.0	6.0	3.3
4-1/4 F50G	7/16 - 20	1/4 - 18	3/4	1.16	6.0	6.0	3.3
5-1/8 F50G	1/2 - 20	1/8 - 27	5/8	1.06	6.0	6.0	3.3
5-1/4 F50G	1/2 - 20	1/4 - 18	3/4	1.19	6.0	6.0	3.3
6-1/8 F50G	9/16 - 18	1/8 - 27	11/16	1.00	6.0	6.0	3.3
6-1/4 F50G	9/16 - 18	1/4 - 18	3/4	1.16	6.0	6.0	3.3
6-3/8 F50G	9/16 - 18	3/8 - 18	7/8	1.28	6.0	6.0	3.3
6-1/2 F50G	9/16 - 18	1/2 - 14	1 1/8	1.53	5.0	6.0	3.3
8-1/8 F50G	3/4 - 16	1/8 - 27	7/8	0.80	6.0	6.0	3.3
8-1/4 F50G	3/4 - 16	1/4 - 18	7/8	1.13	6.0	6.0	3.3
8-3/8 F50G	3/4 - 16	3/8 - 18	7/8	1.28	6.0	6.0	3.3
8-1/2 F50G	3/4 - 16	1/2 - 14	1 1/8	1.50	5.0	6.0	3.3
10-1/4 F50G	7/8 - 14	1/4 - 18	1	0.81	5.0	6.0	3.3
10-3/8 F50G	7/8 - 14	3/8 - 18	1	1.31	5.0	6.0	3.3
10-1/2 F50G	7/8 - 14	1/2 - 14	1 1/8	1.53	5.0	6.0	3.3
10-3/4 F50G	7/8 - 14	3/4 - 14	1 3/8	1.63	4.0	4.0	2.6
12-1/4 F50G	1 1/16 - 12	1/4 - 18	1 1/4	1.00	6.0	6.0	3.3
12-3/8 F50G	1 1/16 - 12	3/8 - 18	1 1/4	1.34	5.0	6.0	3.3
12-1/2 F50G	1 1/16 - 12	1/2 - 14	1 1/4	1.41	5.0	6.0	3.3
12-3/4 F50G	1 1/16 - 12	3/4 - 14	1 3/8	1.72	4.0	4.8	3.1
14-1/2 F50G	1 3/16 - 12	1/2 - 14	1 3/8	1.06	5.0	5.0	3.3
14-3/4 F50G	1 3/16 - 12	3/4 - 14	1 3/8	1.69	4.0	4.0	2.6
16-1/2 F50G	1 5/16 - 12	1/2 - 14	1 1/2	1.00	5.0	6.0	3.3
16-3/4 F50G	1 5/16 - 12	3/4 - 14	1 1/2	1.50	4.0	4.8	2.6
16-1 F50G	1 5/16 - 12	1 - 11 1/2	1 5/8	1.88	3.0	3.6	1.9
20-1 F50G	1 5/8 - 12	1 - 11 1/2	1 7/8	1.00	3.0	3.6	1.9
20-1 1/2 F50G	1 5/8 - 12	1 1/2 - 11 1/2	2 1/4	2.16	2.5	3.0	1.6
20-1 1/4 F50G	1 5/8 - 12	1 1/4 - 11 1/2	2	1.97	3.0	3.0	1.9
24-1 F50G	1 7/8 - 12	1 - 11 1/2	2 1/8	1.00	3.0	3.6	1.9
24-1 1/4 F50G	1 7/8 - 12	1 1/4 - 11 1/2	2 1/8	1.94	2.5	2.5	1.6
24-1 1/2 F50G	1 7/8 - 12	1 1/2 - 11 1/2	2 1/4	2.00	2.0	2.4	1.3
32-2 F50G	2 1/2 - 12	2 - 11 1/2	2 7/8	2.06	2.0	2.4	1.3

**WARNING:** This product can expose you to chemicals including Lead and Lead Compounds which is known to the State of California to cause cancer and birth defects or other reproductive harm. For more information go to [www.p65warnings.ca.gov](http://www.p65warnings.ca.gov).

TABLE OF CONTENTS

VISUAL INDEX

E

FAQs

ASSEMBLY

GEN TECH

Click here for CADs, Support Resources or to Configure Parts Online

## F50HG8

Conversion Adapter  
SAE-ORB / Metric

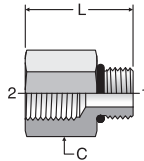

TUBE FITTING PART #	END SIZE		C HEX (in.)	L (in.)	Dynamic Pressure (x 1,000 PSI)		
	1 UN/UNF-2A	2 METRIC STR			S	SS	B
	4M10F5OHG8	7/16 - 20					
4M12F5OHG8	7/16 - 20	M12X1.5	3/4	1.14	6.0	6.0	3.3
6M14F5OHG8	9/16 - 18	M14X1.5	13/16	1.17	6.0	6.0	3.3
6M16F5OHG8	9/16 - 18	M16X1.5	15/16	1.17	6.0	6.0	3.3
8M16F5OHG8	3/4 - 16	M16X1.5	15/16	1.30	6.0	6.0	3.3
8M18F5OHG8	3/4 - 16	M18X1.5	1	1.30	6.0	6.0	3.3
10M22F5OHG8	7/8 - 14	M22X1.5	1 3/16	1.46	5.0	5.0	3.3
12M27F5OHG8	1 1/16 - 12	M27X2	1 1/2	1.72	5.0	5.0	3.3
16M33F5OHG8	1 5/16 - 12	M33X2	1 3/4	1.81	5.0	5.0	3.3

**WARNING:** This product can expose you to chemicals including Lead and Lead Compounds which is known to the State of California to cause cancer and birth defects or other reproductive harm. For more information go to [www.p65warnings.ca.gov](http://www.p65warnings.ca.gov).

## F50HF42

Conversion Adapter  
SAE-ORB / BSPP-ED

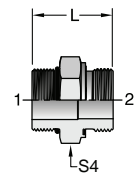

TUBE FITTING PART #	End Size		S4 Hex (mm)	L (mm)	Dynamic Pressure (x 1,000 PSI)		
	1 UN/UNF-2A	2 BSPP			S	SS	B
	4-1/8F5OHF42ED	7/16-20					
4-1/4F5OHF42ED	7/16-20	1/4-19	19	31.8	9.2		
5-1/4F5OHF42ED	1/2-20	1/4-19	19	31.4	9.2		
6-1/4F5OHF42ED	9/16-18	1/4-19	19	32.0	9.2		
6-3/8F5OHF42ED	9/16-18	3/8-19	22	32.5	9.2		
8-1/4F5OHF42ED	3/4-16	1/4-19	22	34.9	9.2		
8-3/8F5OHF42ED	3/4-16	3/8-19	22	36.5	9.2		
8-1/2F5OHF42ED	3/4-16	1/2-14	27	40.0	6.0		
10-1/2F5OHF42ED	7/8-14	1/2-14	27	42.0	6.0		
12-1/2F5OHF42ED	1 1/16-12	1/2-14	32	45.0	6.0		
12-3/4F5OHF42ED	1 1/16-12	3/4-14	32	47.0	6.0		
16-3/4F5OHF42ED	1 5/16-12	3/4-14	38	48.0	6.0		
16-1F5OHF42ED	1 5/16-12	1-11	41	51.0	6.0		
20-11/4F5OHF42ED	1 5/8-12	1 1/4-11	50	54.0	6.0		
24-11/2F5OHF42ED	1 7/8-12	1 1/2-11	55	56.0	5.0		

**WARNING:** This product can expose you to chemicals including Lead and Lead Compounds which is known to the State of California to cause cancer and birth defects or other reproductive harm. For more information go to [www.p65warnings.ca.gov](http://www.p65warnings.ca.gov).

## F50HG4

Conversion Adapter  
SAE-ORB / BSPP

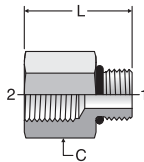

TUBE FITTING PART #	END SIZE		C HEX (in.)	L (in.)	Dynamic Pressure (x 1,000 PSI)		
	1 UN/UNF-2A	2 BSPP			S	SS	B
	4-1/8F5OHG4	7/16 - 20					
4-1/4F5OHG4	7/16 - 20	1/4 - 19	3/4	1.16	6.0	6.0	3.3
6-1/4F5OHG4	9/16 - 18	1/4 - 19	3/4	1.19	6.0	6.0	3.3
6-3/8F5OHG4	9/16 - 18	3/8 - 19	7/8	1.19	6.0	6.0	3.3
8-1/4F5OHG4	3/4 - 16	1/4 - 19	7/8	1.32	6.0	6.0	3.3
8-3/8F5OHG4	3/4 - 16	3/8 - 19	15/16	1.32	6.0	6.0	3.3
10-1/2F5OHG4	7/8 - 14	1/2 - 14	1 1/8	1.52	5.0	5.0	3.3
12-3/4F5OHG4	1 1/16 - 12	3/4 - 14	1 7/16	1.74	4.0	4.0	2.6
16-1F5OHG4	1 5/16 - 12	1 - 11	1 7/8	1.87	3.0	3.0	1.9

**WARNING:** This product can expose you to chemicals including Lead and Lead Compounds which is known to the State of California to cause cancer and birth defects or other reproductive harm. For more information go to [www.p65warnings.ca.gov](http://www.p65warnings.ca.gov).

## FHG5

Female Straight Thread Adapter  
NPTF / SAE-ORB

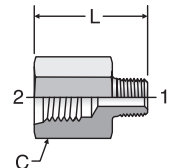

HPD Base # 0110

TUBE FITTING PART #	END SIZE		C HEX (in.)	L (in.)	Dynamic Pressure (x 1,000 PSI)		
	1 NPTF	2 UN/UNF-2B			-S	-SS	-B
	1/8-4 FHG5	1/8 - 27					
1/8-5 FHG5	1/8 - 27	1/2 - 20	3/4	1.09	6.0	6.0	3.3
1/4-6 FHG5	1/4 - 18	9/16 - 18	3/4	1.36	6.0	6.0	3.3
3/8-6 FHG5	3/8 - 18	9/16 - 18	3/4	1.42	6.0	6.0	3.3
3/8-8 FHG5	3/8 - 18	3/4 - 16	1	1.50	5.0	5.0	3.3
1/2-6 FHG5	1/2 - 14	9/16 - 18	7/8	1.58	6.0	6.0	3.3
1/2-8 FHG5	1/2 - 14	3/4 - 16	1	1.66	5.0	5.0	3.3
1/2-10 FHG5	1/2 - 14	7/8 - 14	1 1/4	1.75	4.5	4.5	2.9
3/4-8 FHG5	3/4 - 14	3/4 - 16	1 1/8	1.13	4.5	4.5	2.9
3/4-12 FHG5	3/4 - 14	1 1/16 - 12	1 3/8	1.97	4.5	4.5	2.9
1-16 FHG5	1 - 11 1/2	1 5/16 - 12	1 5/8	2.13	3.5	3.5	2.2

**WARNING:** This product can expose you to chemicals including Lead and Lead Compounds which is known to the State of California to cause cancer and birth defects or other reproductive harm. For more information go to [www.p65warnings.ca.gov](http://www.p65warnings.ca.gov).

TABLE OF CONTENTS

VISUAL INDEX

FAQs

ASSEMBLY

GEN TECH

Dimensions and pressures for reference only, subject to change.

Click here for CADs, Support Resources or to Configure Parts Online

# FG

Expander / Adapter  
NPTF / NPTF

SAE 140139  
HPD Base # 0201

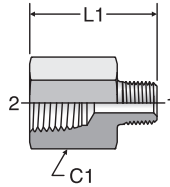

TUBE FITTING PART #	END SIZE		C1 HEX (in.)	L1 (in.)	Dynamic Pressure (x 1,000 PSI)		
	1 NPTF	2 NPTF			-S	-SS	-B
	1/8 x 1/16 FG	1/16 - 27			1/8 - 27	5/8	1.03
1/8 FG	1/8 - 27	1/8 - 27	5/8	1.03	6.0	6.0	3.3
1/4 x 1/8 FG	1/8 - 27	1/4 - 18	3/4	1.21	6.0	6.0	3.9
1/4 FG	1/4 - 18	1/4 - 18	3/4	1.39	6.0	6.0	3.9
3/8 x 1/8 FG	1/8 - 27	3/8 - 18	7/8	1.25	6.0	6.0	3.3
3/8 x 1/4 FG	1/4 - 18	3/8 - 18	7/8	1.44	6.0	6.0	3.9
3/8 FG	3/8 - 18	3/8 - 18	7/8	1.44	6.0	6.0	3.9
1/2 x 1/8 FG	1/8 - 27	1/2 - 14	1 1/8	1.50	5.0	6.0	3.2
1/2 x 1/4 FG	1/4 - 18	1/2 - 14	1 1/8	1.69	5.0	6.0	3.2
1/2 x 3/8 FG	3/8 - 18	1/2 - 14	1 1/8	1.69	5.0	6.0	3.2
1/2 FG	1/2 - 14	1/2 - 14	1 1/8	1.87	5.0	6.0	3.2
3/4 FG	3/4 - 14	3/4 - 14	1 3/8	1.93	4.0	4.8	2.6
3/4 x 1/4 FG	1/4 - 18	3/4 - 14	1 3/8	1.75	4.0	4.8	2.6
3/4 x 3/8 FG	3/8 - 18	3/4 - 14	1 3/8	1.75	4.0	4.8	2.6
3/4 x 1/2 FG	1/2 - 14	3/4 - 14	1 3/8	1.93	4.0	4.8	2.6
1 FG	1 - 11 1/2	1 - 11 1/2	1 5/8	2.37	3.0	3.6	2.3
1 x 1/4 FG	1/4 - 18	1 - 11 1/2	1 5/8	2.01	3.0	3.6	2.3
1 x 1/2 FG	1/2 - 14	1 - 11 1/2	1 5/8	2.19	3.0	3.6	2.3
1 x 3/4 FG	3/4 - 14	1 - 11 1/2	1 5/8	2.19	3.0	3.6	2.3
1 1/4 FG	1 1/4 - 11 1/2	1 1/4 - 11 1/2	2	2.50	2.5	3.0	1.9
1 1/4 x 1 FG	1 - 11 1/2	1 1/4 - 11 1/2	2	2.47	2.5	3.0	1.9
1 1/2 x 1 FG	1 - 11 1/2	1 1/2 - 11 1/2	2 3/8	2.47	2.0	2.4	1.5
1 1/2 x 1 1/4 FG	1 1/4 - 11 1/2	1 1/2 - 11 1/2	2 3/8	2.50	2.0	2.4	1.5
2 FG	2 - 11 1/2	2 - 11 1/2	2 7/8	2.66	2.0	2.4	1.5

**WARNING:** This product can expose you to chemicals including Lead and Lead Compounds which is known to the State of California to cause cancer and birth defects or other reproductive harm. For more information go to [www.p65warnings.ca.gov](http://www.p65warnings.ca.gov).

# FHG8

Conversion Adapter  
NPTF / Metric

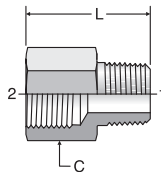

TUBE FITTING PART #	END SIZE		C HEX (in.)	L (in.)	Dynamic Pressure (x 1,000 PSI)		
	1 NPTF	2 METRIC STR			S	SS	B
	1/8M10FHG8	1/8 - 27			M10X1	5/8	0.95
1/8M12FHG8	1/8 - 27	M12X1.5	3/4	1.16	6.0	6.0	3.3
1/4M14FHG8	1/4 - 18	M14X1.5	13/16	1.35	6.0	6.0	3.3
1/4M16FHG8	1/4 - 18	M16X1.5	15/16	1.37	6.0	6.0	3.3
3/8M18FHG8	3/8 - 18	M18X1.5	1	1.36	6.0	6.0	3.3
1/2M22FHG8	1/2 - 14	M22X1.5	1 3/16	1.65	6.0	5.0	3.3
3/4M27FHG8	3/4 - 14	M27X2	1 1/2	1.77	5.5	4.5	2.9

**WARNING:** This product can expose you to chemicals including Lead and Lead Compounds which is known to the State of California to cause cancer and birth defects or other reproductive harm. For more information go to [www.p65warnings.ca.gov](http://www.p65warnings.ca.gov).

# PTR

Pipe Thread Reducer  
NPTF / NPTF

SAE 140140  
HPD Base # 0102

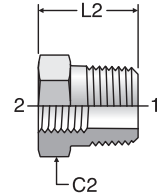

TUBE FITTING PART #	END SIZE		C2 HEX (in.)	L2 (in.)	Dynamic Pressure (x 1,000 PSI)		
	1 NPTF	2 NPTF			-S	-SS	-B
	1/4 x 1/8 PTR	1/4 - 18			1/8 - 27	5/8	0.86
3/8 x 1/8 PTR	3/8 - 18	1/8 - 27	3/4	0.86	6.0	6.0	3.9
3/8 x 1/4 PTR	3/8 - 18	1/4 - 18	3/4	0.86	6.0	6.0	3.9
1/2 x 1/8 PTR	1/2 - 14	1/8 - 27	7/8	1.11	6.0	6.0	3.2
1/2 x 1/4 PTR	1/2 - 14	1/4 - 18	7/8	1.11	6.0	6.0	3.2
1/2 x 3/8 PTR	1/2 - 14	3/8 - 18	7/8	1.11	6.0	6.0	3.2
3/4 x 1/8 PTR	3/4 - 14	1/8 - 27	1 1/8	1.17	5.5	6.0	3.3
3/4 x 1/4 PTR	3/4 - 14	1/4 - 18	1 1/8	1.17	5.5	6.0	3.7
3/4 x 3/8 PTR	3/4 - 14	3/8 - 18	1 1/8	1.17	5.5	6.0	3.7
3/4 x 1/2 PTR	3/4 - 14	1/2 - 14	1 1/8	1.17	5.0	6.0	3.3
1 x 1/8 PTR	1 - 11 1/2	1/8 - 27	1 3/8	1.36	4.5	5.4	3.3
1 x 1/4 PTR	1 - 11 1/2	1/4 - 18	1 3/8	1.36	4.5	5.4	3.3
1 x 3/8 PTR	1 - 11 1/2	3/8 - 18	1 3/8	1.36	4.5	5.4	3.0
1 x 1/2 PTR	1 - 11 1/2	1/2 - 14	1 3/8	1.36	4.5	5.4	3.0
1 x 3/4 PTR	1 - 11 1/2	3/4 - 14	1 3/8	1.36	4.0	4.8	2.7
1 1/4 x 1/4 PTR	1 1/4 - 11 1/2	1/4 - 18	1 3/4	1.47	3.0	3.6	2.3
1 1/4 x 3/8 PTR	1 1/4 - 11 1/2	3/8 - 18	1 3/4	1.47	3.0	3.6	2.3
1 1/4 x 1/2 PTR	1 1/4 - 11 1/2	1/2 - 14	1 3/4	1.47	3.0	3.6	2.3
1 1/4 x 3/4 PTR	1 1/4 - 11 1/2	3/4 - 14	1 3/4	1.47	3.0	3.6	2.3
1 1/4 x 1 PTR	1 1/4 - 11 1/2	1 - 11 1/2	1 3/4	1.47	3.0	3.6	2.3
1 1/2 x 1/4 PTR	1 1/2 - 11 1/2	1/4 - 18	2	1.52	3.0	3.6	2.3
1 1/2 x 3/8 PTR	1 1/2 - 11 1/2	3/8 - 18	2	1.58	3.0	3.6	2.3
1 1/2 x 1/2 PTR	1 1/2 - 11 1/2	1/2 - 14	2	1.58	3.0	3.6	2.3
1 1/2 x 3/4 PTR	1 1/2 - 11 1/2	3/4 - 14	2	1.58	3.0	3.6	2.3
1 1/2 x 1 PTR	1 1/2 - 11 1/2	1 - 11 1/2	2	1.58	3.0	3.6	2.3
1 1/2 x 1 1/4 PTR	1 1/2 - 11 1/2	1 1/4 - 11 1/2	2	1.58	2.5	3.0	1.9
2 x 1/2 PTR	2 - 11 1/2	1/2 - 14	2 1/2	1.75	2.0	2.4	1.5
2 x 3/4 PTR	2 - 11 1/2	3/4 - 14	2 1/2	1.75	2.0	2.4	1.5
2 x 1 PTR	2 - 11 1/2	1 - 11 1/2	2 1/2	1.75	2.0	2.4	1.5
2 x 1 1/4 PTR	2 - 11 1/2	1 1/4 - 11 1/2	2 1/2	1.75	2.0	2.4	1.5
2 x 1 1/2 PTR	2 - 11 1/2	1 1/2 - 11 1/2	2 1/2	1.75	2.0	2.4	1.5

**WARNING:** This product can expose you to chemicals including Lead and Lead Compounds which is known to the State of California to cause cancer and birth defects or other reproductive harm. For more information go to [www.p65warnings.ca.gov](http://www.p65warnings.ca.gov).

# FHG4

Conversion Adapter  
NPTF / BSPP

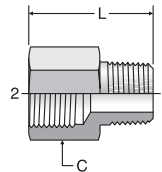

TUBE FITTING PART #	END SIZE		C HEX (in.)	L (in.)	Dynamic Pressure (x 1,000 PSI)		
	1 NPTF	2 BSPP			S	SS	B
	1/4X1/4FHG4	1/4 - 18			1/4 - 19	3/4	1.33
1/4X3/8FHG4	1/4 - 18	3/8 - 19	13/16	1.40	6.0	6.0	3.3
3/8X1/4FHG4	3/8 - 18	1/4 - 19	3/4	1.31	6.0	6.0	3.3
3/8X3/8FHG4	3/8 - 18	3/8 - 19	1	1.34	6.0	6.0	3.3
1/2X3/8FHG4	1/2 - 14	3/8 - 19	15/16	1.50	6.0	6.0	3.3
1/2X1/2FHG4	1/2 - 14	1/2 - 14	1 1/8	1.66	5.0	5.0	3.3
3/4X3/4FHG4	3/4 - 14	3/4 - 14	1 7/16	1.75	4.0	4.0	2.6

**WARNING:** This product can expose you to chemicals including Lead and Lead Compounds which is known to the State of California to cause cancer and birth defects or other reproductive harm. For more information go to [www.p65warnings.ca.gov](http://www.p65warnings.ca.gov).

TABLE OF CONTENTS

VISUAL INDEX

E

FAQs

ASSEMBLY

GEN TECH



Click here for CADs, Support Resources or to Configure Parts Online

# F87OHG87M

Reducer / Expander  
ISO 6149 / ISO 6149

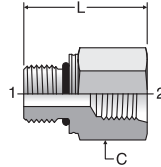

TUBE FITTING PART #	END SIZE		C HEX (mm)	L (mm)	Dynamic Pressure (x 1,000 PSI)		
	1 METRIC STR	2 METRIC STR			S	SS	B
	M8M10F87OHG87M	M8X1					
M10M8F87OHG87M	M10X1	M8X1	14	27.5	10.0	7.5	3.3
M10M12F87OHG87M	M10X1	M12X1.5	19	30.0	8.0	6.0	3.3
M12M10F87OHG87M	M12X1.5	M10X1	17	29.5	10.0	6.0	3.3
M12M14F87OHG87M	M12X1.5	M14X1.5	22	32.0	7.0	6.0	3.3
M12M16F87OHG87M	M12X1.5	M16X1.5	24	33.5	6.0	6.0	3.3
M14M12F87OHG87M	M14X1.5	M12X1.5	19	32.0	8.0	6.0	3.3
M14M16F87OHG87M	M14X1.5	M16X1.5	24	33.5	6.0	6.0	3.3
M16M14F87OHG87M	M16X1.5	M14X1.5	22	34.0	7.0	6.0	3.3
M16M18F87OHG87M	M16X1.5	M18X1.5	27	37.0	6.0	6.0	3.3
M18M16F87OHG87M	M18X1.5	M16X1.5	24	37.0	6.0	6.0	3.3
M18M20F87OHG87M	M18X1.5	M20X1.5	30	39.5	6.0	6.0	3.3
M20M18F87OHG87M	M20X1.5	M18X1.5	27	38.5	6.0	6.0	3.3
M20M22F87OHG87M	M20X1.5	M22X1.5	30	39.5	5.0	5.0	3.3
M22M20F87OHG87M	M22X1.5	M20X1.5	27	41.5	5.0	5.0	3.3
M27M22F87OHG87M	M27X2.0	M22X1.5	32	46.0	5.0	5.0	3.3
M27M33F87OHG87M	M27X2.0	M33X2.0	46	52.0	5.0	5.0	3.3
M33M27F87OHG87M	M33X2.0	M27X2.0	41	48.0	5.0	5.0	3.3
M33M42F87OHG87M	M33X2.0	M42X2.0	55	54.0	4.0	4.0	2.6
M42M27F87OHG87M	M42X2.0	M27X2.0	50	54.0	3.0	3.0	1.9
M42M33F87OHG87M	M42X2.0	M33X2.0	50	46.0	3.0	3.0	1.9
M42M48F87OHG87M	M42X2.0	M48X2.0	65	57.0	2.0	2.0	1.3

**WARNING:** This product can expose you to chemicals including Lead and Lead Compounds which is known to the State of California to cause cancer and birth defects or other reproductive harm. For more information go to [www.p65warnings.ca.gov](http://www.p65warnings.ca.gov).

# F80HG5

Conversion Adapter  
Metric-ORR / SAE-ORB  
(for ISO 9974 / DIN 3852-1 Port)

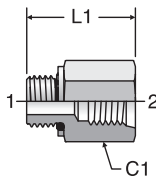

TUBE FITTING PART #	END SIZE		C1 HEX (in.)	L1 (in.)	Dynamic Pressure (x 1,000 PSI)		
	1 METRIC STR	2 UN/UNF-2B			S	SS	B
	M10-4F80HG5	M10x1					
M10-6F80HG5	M10X1	9/16 - 18	7/8	1.15	5.0	5.0	3.3
M14-6F80HG5	M14x1.5	9/16 - 18	13/16	1.19	5.0	5.0	3.3
M16-8F80HG5	M16x1.5	3/4 - 16	1	1.31	5.0	5.0	3.3
M18-8F80HG5	M18X1.5	3/4 - 16	1	1.38	3.5	3.5	2.2
M22-10F80HG5	M22x1.5	7/8 - 14	1 1/8	1.50	3.5	3.5	2.2
M27-12F80HG5	M27x2	1 1/16 - 12	1 1/4	1.88	3.5	3.5	2.2
M33-16F80HG5	M33x2	1 5/16 - 12	1 5/8	1.91	3.0	3.0	1.9
M42-20F80HG5	M42x2	1 5/8 - 12	2	1.91	2.0	2.0	1.3

**WARNING:** This product can expose you to chemicals including Lead and Lead Compounds which is known to the State of California to cause cancer and birth defects or other reproductive harm. For more information go to [www.p65warnings.ca.gov](http://www.p65warnings.ca.gov).

# F80HG

Conversion Adapter  
Metric-ORR / NPTF  
(for ISO 9974 / DIN 3852-1 Port)

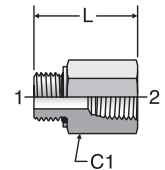

TUBE FITTING PART #	END SIZE		C1 HEX (in.)	L (in.)	Dynamic Pressure (x 1,000 PSI)		
	1 METRIC STR	2 NPTF			S	SS	B
	M10-1/8F80HG	M10X1.0					
M12-1/4F80HG	M12X1.5	1/4 - 18	3/4	1.24	5.0	5.0	3.3
M14-1/4F80HG	M14X1.5	1/4 - 18	3/4	1.24	5.0	5.0	3.3
M16-3/8F80HG	M16X1.5	3/8 - 18	7/8	1.36	5.0	5.0	3.3
M16-1/2F80HG	M16X1.5	1/2 - 14	1 1/8	1.58	5.0	5.0	3.3
M18-3/8F80HG	M18X1.5	3/8 - 18	15/16	1.42	5.0	5.0	3.3
M18-1/2F80HG	M18X1.5	1/2 - 14	1 1/8	1.67	5.0	5.0	3.3
M22-1/2F80HG	M22X1.5	1/2 - 14	1 1/8	1.68	3.5	3.5	2.2
M27-3/4F80HG	M27X2.0	3/4 - 14	1 3/8	1.87	3.5	3.5	2.2
M33-1F80HG	M33X2.0	1 - 11 1/2	1 5/8	2.11	3.0	3.0	1.9

**WARNING:** This product can expose you to chemicals including Lead and Lead Compounds which is known to the State of California to cause cancer and birth defects or other reproductive harm. For more information go to [www.p65warnings.ca.gov](http://www.p65warnings.ca.gov).

Dimensions and pressures for reference only, subject to change.

Click here for CADs, Support Resources or to Configure Parts Online

## F82HG8

Conversion Adapter  
Metric-ED / Metric-ORR  
(for ISO 9974 / DIN 3852-1 Port)

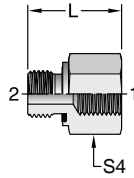

TUBE FITTING PART #	End Size		S4 Hex (mm)	L (mm)	Dynamic Pressure (x 1,000 PSI)		
	1 Metric Str	2 Metric Str			S		
M10-M8F82EDHG8	M10X1	M8X1	17	21.3	5.0		
M10-M12F82EDHG8	M10X1	M12X1.5	17	27.4	5.0		
M12-M10F82EDHG8	M12X1.5	M10X1	19	31.8	5.0		
M12-M14F82EDHG8	M12X1.5	M15X1.5	19	32.8	5.0		
M12-M16F82EDHG8	M12X1.5	M16X1.5	22	33.5	5.0		
M14-M12F82EDHG8	M14X1.5	M12X1.5	22	32.3	5.0		
M14-M16F82EDHG8	M14X1.5	M16X1.5	22	33.3	5.0		
M16-M14F82EDHG8	M16X1.5	M14X1.5	24	32.3	5.0		
M16-M18F82EDHG8	M16X1.5	M18X1.5	24	33.5	5.0		
M18-M16F82EDHG8	M18X1.5	M16X1.5	27	32.8	3.4		
M18-M20F82EDHG8	M18X1.5	M20X1.5	27	36.1	3.4		
M22-M20F82EDHG8	M22X1.5	M20X1.5	30	36.8	3.4		

**WARNING:** This product can expose you to chemicals including Lead and Lead Compounds which is known to the State of California to cause cancer and birth defects or other reproductive harm. For more information go to [www.p65warnings.ca.gov](http://www.p65warnings.ca.gov).

## F4OHG

Conversion Adapter  
BSPP-ORR / NPTF  
(for ISO 1179-1 / DIN 3852-2 Port)

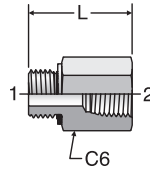

TUBE FITTING PART #	END SIZE		C6 HEX (in.)	L (in.)	Dynamic Pressure (x 1,000 PSI)		
	1 BSPP	2 NPTF			-S	-SS	-B
1/8x1/8F4OHG	1/8 - 28	1/8 - 27	5/8	0.97	5.0	5.0	3.3
1/4x1/4F4OHG	1/4 - 19	1/4 - 18	3/4	1.28	5.0	5.0	3.3
3/8x3/8F4OHG	3/8 - 19	3/8 - 18	7/8	1.33	5.0	5.0	3.3
1/2x1/2F4OHG	1/2 - 14	1/2 - 14	1 1/8	1.73	3.5	3.5	2.2
3/4x3/4F4OHG	3/4 - 14	3/4 - 14	1 3/8	1.77	3.5	3.5	2.2
1x1F4OHG	1 - 11	1 - 11 1/2	1 3/4	2.17	3.0	3.0	1.9

**WARNING:** This product can expose you to chemicals including Lead and Lead Compounds which is known to the State of California to cause cancer and birth defects or other reproductive harm. For more information go to [www.p65warnings.ca.gov](http://www.p65warnings.ca.gov).

## F4OHG5

Conversion Adapter  
BSPP-ORR / SAE-ORB  
(for ISO 1179-1 / DIN 3852-2 Port)

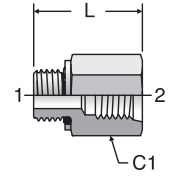

TUBE FITTING PART #	END SIZE		C1 HEX (in.)	L (in.)	Dynamic Pressure (x 1,000 PSI)		
	1 BSPP	2 UN/UNF-2B			-S	-SS	-B
1/8-4F4OHG5	1/8 - 28	7/16 - 20	11/16	1.00	5.0	5.0	3.3
1/4-4F4OHG5	1/4 - 19	7/16 - 20	3/4	1.11	5.0	5.0	3.3
1/4-6F4OHG5	1/4 - 19	9/16 - 18	13/16	1.25	5.0	5.0	3.3
3/8-4F4OHG5	3/8 - 19	7/16 - 20	7/8	1.19	5.0	5.0	3.3
3/8-5F4OHG5	3/8 - 19	1/2 - 20	7/8	1.19	5.0	5.0	3.3
3/8-6F4OHG5	3/8 - 19	9/16 - 18	7/8	1.25	5.0	5.0	3.3
3/8-8F4OHG5	3/8 - 19	3/4 - 16	1	1.33	5.0	5.0	3.3
1/2-10F4OHG5	1/2 - 14	7/8 - 14	1 1/8	1.60	3.5	3.5	2.2
3/4-12F4OHG5	3/4 - 14	1 1/16 - 12	1 3/8	1.74	3.5	3.5	2.2
1-16F4OHG5	1 - 11	1 5/16 - 12	1 3/4	1.92	3.5	3.5	2.2
1 1/4-16F4OHG5	1 1/4 - 11	1 5/16 - 12	2	1.95	2.0	2.0	1.3
1 1/4-20F4OHG5	1 1/4 - 11	1 5/8 - 12	2	1.95	2.0	2.0	1.3

**WARNING:** This product can expose you to chemicals including Lead and Lead Compounds which is known to the State of California to cause cancer and birth defects or other reproductive harm. For more information go to [www.p65warnings.ca.gov](http://www.p65warnings.ca.gov).

## GHG4

Female Pipe Adapter  
BSPP / NPTF

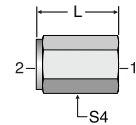

TUBE FITTING PART #	End Size		S4 Hex (in.)	L (in.)	Dynamic Pressure (x 1,000 PSI)		
	1 NPTF	2 BSPP			-S		
1/4 GHG4	1/4-18	1/4-19	3/4	1.23	6.0		
3/8 GHG4	3/8-18	3/8-19	7/8	1.26	6.0		
1/2 GHG4	1/2-14	1/2-14	1 1/8	1.50	5.0		
3/4 GHG4	3/4-14	3/4-14	1 3/8	1.87	4.0		
1 GHG4	1-11 1/2	1-11	1 5/8	2.17	3.0		

**WARNING:** This product can expose you to chemicals including Lead and Lead Compounds which is known to the State of California to cause cancer and birth defects or other reproductive harm. For more information go to [www.p65warnings.ca.gov](http://www.p65warnings.ca.gov).

## PTR34M

BSPT Reducing Adapter  
BSPT / BSPP

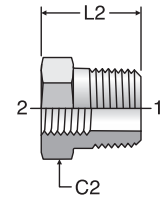

TUBE FITTING PART #	END SIZE		C2 (mm)	L2 (mm)	Dynamic Pressure (x 1,000 PSI)		
	1 BSPT	2 BSPP			S	SS	B
1/4X1/8PTR34M	1/4-19	1/8-28	17	28	6.0	6.0	3.3
3/8X1/4PTR34M	3/8-19	1/4-19	19	33	6.0	6.0	3.3
1/2X1/4PTR34M	1/2-14	1/4-19	22	39	5.0	5.0	3.3
1/2X3/8PTR34M	1/2-14	3/8-19	22	39	5.0	5.0	3.3

**WARNING:** This product can expose you to chemicals including Lead and Lead Compounds which is known to the State of California to cause cancer and birth defects or other reproductive harm. For more information go to [www.p65warnings.ca.gov](http://www.p65warnings.ca.gov).

TABLE OF CONTENTS

VISUAL INDEX

E

FAQs

ASSEMBLY

GEN TECH

[Click here for CADs, Support Resources or to Configure Parts Online](#)

## RI-ED

BSPP Reducing Adapter / Expander  
BSPP / BSPP-ED  
(for ISO 1179-1 / DIN 3852-2 Port)

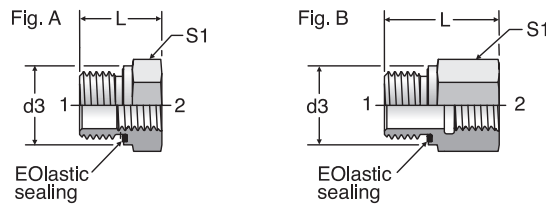

TUBE FITTING PART #	END SIZE		d3 (mm)	L (mm)	S1 (mm)	Fig.	Dynamic Pressure (x 1,000 PSI)		
	1 BSPP	2 BSPP					CF	71	MS
RI1/8EDX1/4	1/8 - 28	1/4 - 19	14	31.0	19	B	5.8	5.8	3.3
RI1/8EDX3/8	1/8 - 28	3/8 - 19	14	32.0	24	B	5.8	5.8	3.3
RI1/4EDX1/8	1/4 - 19	1/8 - 28	19	29.0	19	B	5.8	5.8	3.3
RI1/4EDX3/8	1/4 - 19	3/8 - 19	19	36.0	24	B	5.8	5.8	3.3
RI1/4EDX1/2	1/4 - 19	1/2 - 14	19	40.0	30	B	5.8	5.8	3.3
RI1/4EDX3/4	1/4 - 19	3/4 - 14	19	43.0	36	B	5.8	5.8	3.3
RI3/8EDX1/8	3/8 - 19	1/8 - 28	22	22.5	22	A	5.8	5.8	3.3
RI3/8EDX1/4	3/8 - 19	1/4 - 19	22	36.0	22	B	5.8	5.8	3.3
RI3/8EDX1/2	3/8 - 19	1/2 - 14	22	41.0	30	B	5.8	5.8	3.3
RI3/8EDX3/4	3/8 - 19	3/4 - 14	22	44.0	36	B	4.5	4.5	3.0
RI1/2EDX1/8	1/2 - 14	1/8 - 28	27	24.0	27	A	5.8	5.8	3.3
RI1/2EDX1/4	1/2 - 14	1/4 - 19	27	24.0	27	A	5.8	5.8	3.3
RI1/2EDX3/8	1/2 - 14	3/8 - 19	27	37.0	27	B	5.8	5.8	3.3
RI1/2EDX3/4	1/2 - 14	3/4 - 14	27	46.0	36	B	4.5	4.5	3.0
RI1/2EDX1	1/2 - 14	1 - 11	27	49.0	41	B	4.5	4.5	3.0
RI1/2EDX11/4	1/2 - 14	1 1/4 - 11	27	53.0	55	B	4.5	4.5	3.0
RI3/4EDX1/4	3/4 - 14	1/4 - 19	32	26.0	32	A	4.5	4.5	3.0
RI3/4EDX3/8	3/4 - 14	3/8 - 19	32	26.0	32	A	4.5	4.5	3.0
RI3/4EDX1/2	3/4 - 14	1/2 - 14	32	43.0	32	B	4.5	4.5	3.0
RI3/4EDX1	3/4 - 14	1 - 11	32	51.0	41	B	4.5	4.5	3.0
RI3/4EDX11/4	3/4 - 14	1 1/4 - 11	32	55.0	55	B	4.5	4.5	3.0
RI3/4EDX11/2	3/4 - 14	1 1/2 - 11	32	57.0	60	B	3.6	3.6	2.3
RI1EDX1/4	1 - 11	1/4 - 19	40	29.0	41	A	4.5	4.5	3.0
RI1EDX3/8	1 - 11	3/8 - 19	40	29.0	41	A	4.5	4.5	3.0
RI1EDX1/2	1 - 11	1/2 - 14	40	29.0	41	A	4.5	4.5	3.0
RI1EDX3/4	1 - 11	3/4 - 14	40	49.0	41	B	4.5	4.5	3.0
RI1EDX11/4	1 - 11	1 1/4 - 11	40	57.0	55	B	4.5	4.5	3.0
RI1EDX11/2	1 - 11	1 1/2 - 11	40	59.0	60	B	3.6	3.6	2.3
RI11/4EDX1/2	1 1/4 - 11	1/2 - 14	50	32.0	50	A	4.5	4.5	3.0
RI11/4EDX3/4	1 1/4 - 11	3/4 - 14	50	32.0	50	A	4.5	4.5	3.0
RI11/4EDX1	1 1/4 - 11	1 - 11	50	53.0	50	B	4.5	4.5	3.0
RI11/4EDX11/2	1 1/4 - 11	1 1/2 - 11	50	60.0	60	B	3.6	3.6	2.3
RI11/2EDX1/2	1 1/2 - 11	1/2 - 14	55	36.0	55	A	3.6	3.6	2.3
RI11/2EDX3/4	1 1/2 - 11	3/4 - 14	55	36.0	55	A	3.6	3.6	2.3
RI11/2EDX1	1 1/2 - 11	1 - 11	55	36.0	55	A	3.6	3.6	2.3
RI11/2EDX11/4	1 1/2 - 11	1 1/4 - 11	55	58.0	55	B	3.6	3.6	2.3
RI2EDX11/2	2 - 11	1 1/2 - 11	72	65.0	75	B	2.3	2.3	1.5

**WARNING:** This product can expose you to chemicals including Lead and Lead Compounds which is known to the State of California to cause cancer and birth defects or other reproductive harm. For more information go to [www.p65warnings.ca.gov](http://www.p65warnings.ca.gov).

- TABLE OF CONTENTS
- VISUAL INDEX
- FAQs
- ASSEMBLY
- GEN TECH

Dimensions and pressures for reference only, subject to change.

[Click here for CADs, Support Resources or to Configure Parts Online](#)

**RI**

**BSPP Reducing Adatper / Expander**  
**BSPP / BSPP-CF**  
(for ISO 1179-1 / DIN 3852-2 Port)

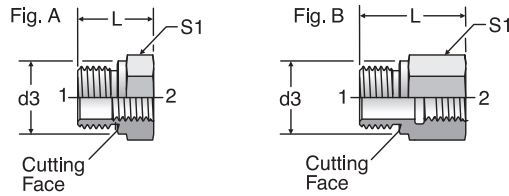

TUBE FITTING PART #	END SIZE		d3 (mm)	L (mm)	S1 (mm)	Fig.	Dynamic Pressure (x 1,000 PSI)		
	1 BSPP	2 BSPP					CF	71	MS
RI1/8X1/4	1/8 - 28	1/4 - 19	14	31.0	19	B	5.8	5.8	3.3
RI1/8X3/8	1/8 - 28	3/8 - 19	14	32.0	24	B	5.8	5.8	3.3
RI1/4X1/8	1/4 - 19	1/8 - 28	18	28.0	19	B	5.8	5.8	3.3
RI1/4X3/8	1/4 - 19	3/8 - 19	18	36.0	24	B	5.8	5.8	3.3
RI1/4X1/2	1/4 - 19	1/2 - 14	18	40.0	30	B	5.8	5.8	3.3
RI1/4X3/4	1/4 - 19	3/4 - 14	18	43.0	36	B	4.5	4.5	3.0
RI3/8X1/8	3/8 - 19	1/8 - 28	22	22.5	22	A	5.8	5.8	3.3
RI3/8X1/4	3/8 - 19	1/4 - 19	22	36.0	22	B	5.8	5.8	3.3
RI3/8X1/2	3/8 - 19	1/2 - 14	22	41.0	30	B	5.8	5.8	3.3
RI3/8X3/4	3/8 - 19	3/4 - 14	22	44.0	36	B	4.5	4.5	3.0
RI1/2X1/8	1/2 - 14	1/8 - 28	26	24.0	27	A	5.8	5.8	3.3
RI1/2X1/4	1/2 - 14	1/4 - 19	26	24.0	27	A	4.5	4.5	3.0
RI1/2X3/8	1/2 - 14	3/8 - 19	26	36.0	27	B	4.5	4.5	3.0
RI1/2X3/4	1/2 - 14	3/4 - 14	26	46.0	36	B	4.5	4.5	3.0
RI1/2X1	1/2 - 14	1 - 11	26	49.0	41	B	2.3	2.3	1.5
RI1/2X11/4	1/2 - 14	1 1/4 - 11	26	53.0	55	B	4.5	4.5	3.0
RI3/4X1/4	3/4 - 14	1/4 - 19	32	26.0	32	A	4.5	4.5	3.0
RI3/4X3/8	3/4 - 14	3/8 - 19	32	26.0	32	A	4.5	4.5	3.0
RI3/4X1/2	3/4 - 14	1/2 - 14	32	41.0	32	B	4.5	4.5	3.0
RI3/4X1	3/4 - 14	1 - 11	32	51.0	41	B	2.3	2.3	1.5
RI3/4X11/4	3/4 - 14	1 1/4 - 11	32	55.0	55	B	2.3	2.3	1.5
RI3/4X11/2	3/4 - 14	1 1/2 - 11	32	57.0	60	B	4.5	4.5	3.0
RI1X1/4	1 - 11	1/4 - 19	39	29.0	41	A	4.5	4.5	3.0
RI1X3/8	1 - 11	3/8 - 19	39	29.0	41	A	4.5	4.5	3.0
RI1X1/2	1 - 11	1/2 - 14	39	29.0	41	A	4.5	4.5	3.0
RI1X3/4	1 - 11	3/4 - 14	39	47.0	41	B	2.3	2.3	1.5
RI1X11/4	1 - 11	1 1/4 - 11	39	57.0	55	B	2.3	2.3	1.5
RI1X11/2	1 - 11	1 1/2 - 11	39	59.0	60	B	2.3	2.3	1.5
RI11/4X1/2	1 1/4 - 11	1/2 - 14	49	32.0	50	A	2.3	2.3	1.5
RI11/4X3/4	1 1/4 - 11	3/4 - 14	49	32.0	50	A	2.3	2.3	1.5
RI11/4X1	1 1/4 - 11	1 - 11	49	52.0	50	B	2.3	2.3	1.5
RI11/4X11/2	1 1/4 - 11	1 1/2 - 11	49	60.0	60	B	2.3	2.3	1.5
RI11/2X1/2	1 1/2 - 11	1/2 - 14	55	36.0	55	A	2.3	2.3	1.5
RI11/2X3/4	1 1/2 - 11	3/4 - 14	55	36.0	55	A	2.3	2.3	1.5
RI11/2X1	1 1/2 - 11	1 - 11	55	36.0	55	A	2.3	2.3	1.5
RI11/2X11/4	1 1/2 - 11	1 1/4 - 11	55	58.0	55	B	2.3	2.3	1.5
RI2X11/2	2 - 11	1 1/2 - 11	68	62.0	70	B	2.3	2.3	1.5

**WARNING:** This product can expose you to chemicals including Lead and Lead Compounds which is known to the State of California to cause cancer and birth defects or other reproductive harm. For more information go to [www.p65warnings.ca.gov](http://www.p65warnings.ca.gov).

TABLE OF CONTENTS

VISUAL INDEX

E

FAQs

ASSEMBLY

GEN TECH

Click here for CADs, Support Resources or to Configure Parts Online

### FHF3

Male Pipe Adapter  
BSPT / NPTF

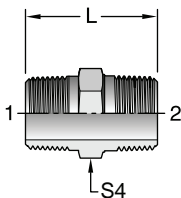

TUBE FITTING PART #	End Size		S4 Hex (in.)	L (in.)	Dynamic Pressure (x 1,000 PSI)		
	1 NPTF	2 BSPT			-S	-SS	-B
1/8 FHF3	1/8-27	1/8-28	7/16	1.09	6.0		
1/4 FHF3	1/4-18	1/4-19	5/8	1.45	6.0		
3/8 x 1/4 FHF3	3/8-18	1/4-19	3/4	1.45	6.0		
1/4 x 3/8 FHF3	1/4-18	1/8-28	3/4	1.45	6.0		
3/8 FHF3	3/8-18	3/8-19	3/4	1.45	6.0		
1/2 FHF3	1/2-14	1/2-14	7/8	1.89	6.0		
3/4 FHF3	3/4-14	3/4-14	1 1/8	1.96	5.5		
1 FHF3	1-11	1-11	1 3/8	2.34	4.5		

Note: The BSPT thread end has an identification collar.

**WARNING:** This product can expose you to chemicals including Lead and Lead Compounds which is known to the State of California to cause cancer and birth defects or other reproductive harm. For more information go to [www.p65warnings.ca.gov](http://www.p65warnings.ca.gov).

### F3HG

Conversion Adapter  
NPTF / BSPT

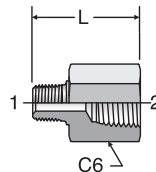

TUBE FITTING PART #	END SIZE		C6 HEX (in.)	L (mm)	Dynamic Pressure (x 1,000 PSI)		
	1 BSPT	2 NPTF			-S	-SS	-B
1/8x1/8F3HG	1/8 - 28	1/8 - 27	9/16	1.08	6.0	6.0	3.3
1/4x1/4F3HG	1/4 - 19	1/4 - 18	3/4	1.37	6.0	6.0	3.3
3/8x3/8F3HG	3/8 - 19	3/8 - 19	7/8	1.38	6.0	6.0	3.3
1/2x1/2F3HG	1/2 - 14	1/2 - 14	1 1/8	1.88	5.0	5.0	3.3
3/4x3/4F3HG	3/4 - 14	3/4 - 14	1 3/8	1.95	4.0	4.0	2.6
1x1F3HG	1 - 11	1 - 11	1 5/8	2.38	3.0	3.0	1.9
1 1/2 x1 1/2F3HG	1 1/2 - 11	1 1/2 - 11 1/2	2 3/8	2.53	2.0	2.0	1.3

**WARNING:** This product can expose you to chemicals including Lead and Lead Compounds which is known to the State of California to cause cancer and birth defects or other reproductive harm. For more information go to [www.p65warnings.ca.gov](http://www.p65warnings.ca.gov).

### F3HG5

Conversion Adapter  
BSPT / SAE-ORB

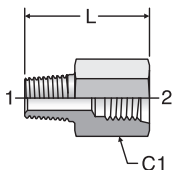

TUBE FITTING PART #	END SIZE		C1 HEX (in.)	L (in.)	Dynamic Pressure (x 1,000 PSI)		
	1 BSPT	2 UN/UNF-2B			-S	-SS	-B
1/8-4F3HG5	1/8 - 28	7/16 - 20	11/16	1.09	6.0	6.0	3.3
1/8-5F3HG5	1/8 - 28	1/2 - 20	3/4	1.09	6.0	6.0	3.3
1/4-6F3HG5	1/4 - 19	9/16 - 18	13/16	1.36	6.0	6.0	3.3
3/8-8F3HG5	3/8 - 19	3/4 - 16	1	1.45	5.0	5.0	3.3
1/2-10F3HG5	1/2 - 14	7/8 - 14	1 1/8	1.78	4.5	4.5	2.9
3/4-12F3HG5	3/4 - 14	1 1/16 - 12	1 3/8	1.92	4.5	4.5	2.9
1-16F3HG5	1 - 11	1 5/16 - 12	1 5/8	2.13	3.5	3.5	2.2

**WARNING:** This product can expose you to chemicals including Lead and Lead Compounds which is known to the State of California to cause cancer and birth defects or other reproductive harm. For more information go to [www.p65warnings.ca.gov](http://www.p65warnings.ca.gov).

### CD45

45° Pipe Elbow  
NPTF / NPTF

SAE 140339  
HPD Base # 3102

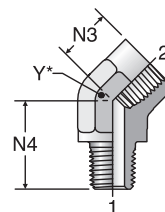

TUBE FITTING PART #	END SIZE		N3 (in.)	N4 (in.)	Y (in.)	Dynamic Pressure (x 1,000 PSI)		
	1 NPTF	2 NPTF				-S	-SS	-B
1/8 CD45	1/8 - 27	1/8 - 27	0.47	0.72	9/16	5.0	5.0	3.2
1/4 CD45	1/4 - 18	1/4 - 18	0.63	1.05	3/4	5.0	5.0	3.2
3/8 CD45	3/8 - 18	3/8 - 18	0.72	1.06	7/8	4.5	4.5	2.9
1/2 CD45	1/2 - 14	1/2 - 14	0.91	1.34	1 1/16	3.0	3.0	1.9
3/4 CD45	3/4 - 14	3/4 - 14	0.97	1.38	1 5/16	3.0	3.0	1.9
1 CD45	1 - 11 1/2	1 - 11 1/2	1.13	1.72	1 5/8	1.8	1.8	1.1
1 1/4 CD45	1 1/4 - 11 1/2	1 1/4 - 11 1/2	1.63	1.80	1 7/8	1.5	1.5	1.0

**WARNING:** This product can expose you to chemicals including Lead and Lead Compounds which is known to the State of California to cause cancer and birth defects or other reproductive harm. For more information go to [www.p65warnings.ca.gov](http://www.p65warnings.ca.gov).

TABLE OF CONTENTS

VISUAL INDEX

FAQs

ASSEMBLY

GEN TECH

Dimensions and pressures for reference only, subject to change.



Click here for CADs, Support Resources or to Configure Parts Online

## DD45

45° Female Pipe Elbow  
NPTF / NPTF

SAE 140338  
HPD Base # 4202

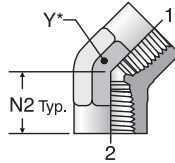

## AOEG5

Straight Thread Elbow  
SAE-ORB / SAE-ORB

HPD Base # 2510

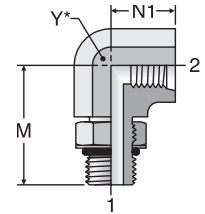

\* Y – Across Wrench Flats

TUBE FITTING PART #	END SIZE		N2 (in.)	Y (in.)	Dynamic Pressure (x 1,000 PSI)		
	1 NPTF	2 NPTF			-S	-SS	-B
1/4 DD45	1/4 - 18	1/4 - 18	0.69	3/4	5.0	5.0	3.3
3/8 DD45	3/8 - 18	3/8 - 18	0.75	7/8	4.5	4.5	2.9
1/2 DD45	1/2 - 14	1/2 - 14	0.94	1 1/16	3.0	3.0	1.9
3/4 DD45	3/4 - 14	3/4 - 14	1.00	1 5/16	3.0	3.0	1.9
1 DD45	1 - 11 1/2	1 - 11 1/2	1.19	1 5/8	1.8	1.8	1.1

**WARNING:** This product can expose you to chemicals including Lead and Lead Compounds which is known to the State of California to cause cancer and birth defects or other reproductive harm. For more information go to [www.p65warnings.ca.gov](http://www.p65warnings.ca.gov).

TUBE FITTING PART #	END SIZE		M (in.)	N1 (in.)	Y (in.)	Dynamic Pressure (x 1,000 PSI)		
	1 UN/UNF-2A	2 UN/UNF-2B				-S	-SS	-B
4 AOE5	7/16 - 20	7/16 - 20	1.23	0.63	3/4	6.0	6.0	3.3
6 AOE5	9/16 - 18	9/16 - 18	1.38	0.75	7/8	5.0	5.0	3.3
8 AOE5	3/4 - 16	3/4 - 16	1.59	0.88	1 1/16	4.0	4.0	2.6
10 AOE5	7/8 - 14	7/8 - 14	1.81	1.02	1 1/16	2.5	2.5	1.6
12 AOE5	1 1/16 - 12	1 1/16 - 12	2.00	1.21	1 5/16	2.5	2.5	1.6
16 AOE5	1 5/16 - 12	1 5/16 - 12	2.26	1.33	1 5/8	2.5	2.5	1.6

**WARNING:** This product can expose you to chemicals including Lead and Lead Compounds which is known to the State of California to cause cancer and birth defects or other reproductive harm. For more information go to [www.p65warnings.ca.gov](http://www.p65warnings.ca.gov).

## AOEG

Female Pipe Elbow  
NPT / SAE-ORB

HPD Base # 2502

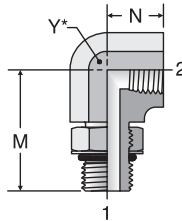

## AOE4G

Extra Long Female Pipe Elbow  
NPTF / SAE-ORB

HPD Base # 5502

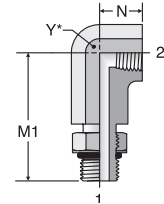

TUBE FITTING PART #	END SIZE		M (in.)	N (in.)	Y (in.)	Dynamic Pressure (x 1,000 PSI)		
	1 UN/UNF-2A	2 NPTF				-S	-SS	-B
6-1/4 AOEG	9/16 - 18	1/4 - 18	1.34	0.63	3/4	5.0	5.0	3.3
8-3/8 AOEG	3/4 - 16	3/8 - 18	1.47	0.63	7/8	4.5	4.5	2.9
10-1/2 AOEG	7/8 - 14	1/2 - 14	1.81	0.75	1 1/16	3.0	3.0	1.9
12-3/4 AOEG	1 1/16 - 12	3/4 - 14	2.00	0.81	1 5/16	3.0	3.0	1.9
16-1 AOEG	1 5/16 - 12	1 - 11 1/2	2.25	1.00	1 5/8	1.8	1.8	1.1

**WARNING:** This product can expose you to chemicals including Lead and Lead Compounds which is known to the State of California to cause cancer and birth defects or other reproductive harm. For more information go to [www.p65warnings.ca.gov](http://www.p65warnings.ca.gov).

TUBE FITTING PART #	END SIZE		M1 (in.)	N (in.)	Y (in.)	Dynamic Pressure (x 1,000 PSI)		
	1 UN/UNF-2A	2 NPTF				-S	-SS	-B
8-3/8 AOE4G	3/4 - 16	3/8 - 18	2.94	0.63	7/8	4.5	4.5	2.9
10-1/2 AOE4G	7/8 - 14	1/2 - 14	3.56	0.75	1 1/16	3.0	3.0	1.9
12-3/4 AOE4G	1 1/16 - 12	3/4 - 14	4.06	0.81	1 5/16	3.0	3.0	1.9
16-1 AOE4G	1 5/16 - 12	1 - 11 1/2	4.63	1.00	1 5/8	1.8	1.8	1.1

TABLE OF CONTENTS

VISUAL INDEX

E

FAQs

ASSEMBLY

GEN TECH

Click here for CADs, Support Resources or to Configure Parts Online

# CR

## Male Pipe Elbow NPTF / NPTF

SAE 140237\*

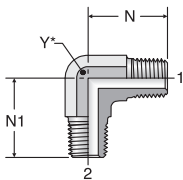

\* Y – Across  
Wrench Flats

TUBE FITTING PART #	END SIZE		N (in.)	N1 (in.)	Y (in.)	Dynamic Pressure (x 1,000 PSI)		
	1 NPTF	2 NPTF				-S	-SS	-B
1/8 CR	1/8 - 27	1/8 - 27	0.78	0.78	7/16	6.0	6.0	3.9
1/4 CR	1/4 - 18	1/4 - 18	1.09	1.09	9/16	6.0	6.0	3.9
3/8 CR	3/8 - 18	3/8 - 18	1.22	1.22	3/4	6.0	6.0	3.9
3/8 x 1/4 CR	3/8 - 18	1/4 - 18	1.22	1.22	3/4	6.0	6.0	3.3
1/2 CR	1/2 - 14	1/2 - 14	1.47	1.47	7/8	6.0	6.0	3.9
1/2 x 3/8 CR	1/2 - 14	3/8 - 18	1.47	1.28	7/8	6.0	6.0	3.3
3/4 CR	3/4 - 14	3/4 - 14	1.59	1.59	1 1/16	4.0	4.0	2.6
3/4 x 1/2 CR	3/4 - 14	1/2 - 14	1.59	1.47	1 1/16	4.0	4.0	2.6
1 CR	1 - 11 1/2	1 - 11 1/2	1.97	1.97	1 5/16	3.0	3.0	1.9
1 x 3/4 CR	1 - 11 1/2	3/4 - 14	1.97	1.78	1 5/16	3.0	3.0	1.9
1 1/4 CR	1 1/4 - 11 1/2	1 1/4 - 11 1/2	2.22	2.22	1 7/8	2.5	2.5	1.6
1 1/2 CR	1 1/2 - 11 1/2	1 1/2 - 11 1/2	2.34	2.34	1 7/8	2.5	2.5	1.6

\* Not shown in SAE J514, but coded per SAE J846.

**WARNING:** This product can expose you to chemicals including Lead and Lead Compounds which is known to the State of California to cause cancer and birth defects or other reproductive harm. For more information go to [www.p65warnings.ca.gov](http://www.p65warnings.ca.gov).

# CD

## Street Elbow NPTF / NPT

SAE 140239  
HPD Base # 2102

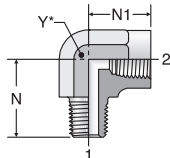

TUBE FITTING PART #	END SIZE		N (in.)	N1 (in.)	Y (in.)	Dynamic Pressure (x 1,000 PSI)		
	1 NPTF	2 NPT				-S	-SS	-B
1/8 CD	1/8 - 27	1/8 - 27	0.78	0.66	9/16	5.0	5.0	3.2
1/8 x 1/4 CD	1/8 - 27	1/4 - 18	0.90	0.88	3/4	5.0	5.0	3.2
1/4 CD	1/4 - 18	1/4 - 18	1.09	0.88	3/4	5.0	5.0	3.2
1/4 x 1/8 CD	1/4 - 18	1/8 - 27	1.09	0.66	9/16	5.0	5.0	3.2
1/4 x 1/2 CD	1/4 - 18	1/2 - 14	1.28	1.23	1 1/16	3.0	3.0	1.9
1/4 x 3/8 CD	1/4 - 18	3/8 - 18	1.22	1.01	7/8	4.5	4.5	2.9
3/8 CD	3/8 - 18	3/8 - 18	1.22	1.02	7/8	4.5	4.5	3.0
3/8 x 1/4 CD	3/8 - 18	1/4 - 18	1.22	0.88	3/4	5.0	5.0	3.2
3/8 x 1/2 CD	3/8 - 18	1/2 - 14	1.28	1.23	1 1/16	3.0	3.0	1.9
1/2 CD	1/2 - 14	1/2 - 14	1.47	1.23	1 1/16	3.0	3.0	1.9
1/2 x 3/8 CD	1/2 - 14	3/8 - 18	1.48	1.25	7/8	4.5	4.5	2.9
1/2 x 3/4 CD	1/2 - 14	3/4 - 14	1.58	1.36	1 5/16	3.0	3.0	1.9
3/4 CD	3/4 - 14	3/4 - 14	1.59	1.36	1 5/16	3.0	3.0	1.9
3/4 x 1/2 CD	3/4 - 14	1/2 - 14	1.59	1.23	1 1/16	3.0	3.0	1.9
1 CD	1 - 11 1/2	1 - 11 1/2	1.97	1.63	1 5/8	1.8	1.8	1.2
1 1/4 CD	1 1/4 - 11 1/2	1 1/4 - 11 1/2	2.38	1.70	1 7/8	1.5	1.5	1.0
1 1/4 x 1 1/2 CD	1 1/4 - 11 1/2	1 1/2 - 11 1/2	2.61	2.08	2 1/2	1.5	1.5	1.0
1 1/2 CD	1 1/2 - 11 1/2	1 1/2 - 11 1/2	2.64	2.08	2 1/2	1.5	1.5	1.0

**WARNING:** This product can expose you to chemicals including Lead and Lead Compounds which is known to the State of California to cause cancer and birth defects or other reproductive harm. For more information go to [www.p65warnings.ca.gov](http://www.p65warnings.ca.gov).

# DD

## Female Pipe Elbow NPT / NPT

SAE 140238  
HPD Base # 2202

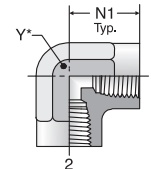

TUBE FITTING PART #	END SIZE		N1 (in.)	Y (in.)	Dynamic Pressure (x 1,000 PSI)		
	1 NPT	2 NPT			-S	-SS	-B
1/8 DD	1/8 - 27	1/8 - 27	0.66	9/16	5.0	5.0	3.2
1/4 DD	1/4 - 18	1/4 - 18	0.88	3/4	5.0	5.0	3.2
3/8 DD	3/8 - 18	3/8 - 18	1.02	7/8	4.5	4.5	3.0
1/2 DD	1/2 - 14	1/2 - 14	1.23	1 1/16	3.0	3.0	1.9
1/2 x 3/8 DD	1/2 - 14	3/8 - 18	1.23	1 1/16	3.0	3.0	1.9
3/4 DD	3/4 - 14	3/4 - 14	1.36	1 3/8	3.0	3.0	1.9
1 DD	1 - 11 1/2	1 - 11 1/2	1.63	1 5/8	1.8	1.8	1.2
1 1/4 DD	1 1/4 - 11 1/2	1 1/4 - 11 1/2	1.70	1 7/8	1.5	1.5	1.5
1 1/2 DD	1 1/2 - 11 1/2	1 1/2 - 11 1/2	2.08	2 1/2	1.5	1.5	1.5

**WARNING:** This product can expose you to chemicals including Lead and Lead Compounds which is known to the State of California to cause cancer and birth defects or other reproductive harm. For more information go to [www.p65warnings.ca.gov](http://www.p65warnings.ca.gov).

Dimensions and pressures for reference only, subject to change.

TABLE OF CONTENTS

VISUAL INDEX

FAQs

ASSEMBLY

GEN TECH

[Click here for CADs, Support Resources or to Configure Parts Online](#)

# A87LPOEG87LPM

ISO 6149\* Female Elbow  
SHORT ISO 6149 / SHORT ISO 6149

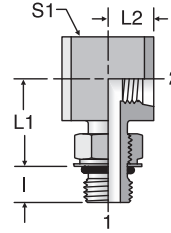

TUBE FITTING PART #	END SIZE		I (mm)	L1 (mm)	L2 (mm)	S1 (mm)	Dynamic Pressure (x 1,000 PSI)		
	1 Metric	2 Metric					S	SS	B
	M08A87LPOEG87LPM	M8X1					M8X1	8.5	13.5
M10A87LPOEG87LPM	M10X1	M10X1	8.5	14.5	7.5	15	4.0	4.0	2.6
M12A87LPOEG87LPM	M12X1.5	M12X1.5	11.0	17.0	10.0	20	3.6	3.6	2.3
M14A87LPOEG87LPM	M14X1.5	M14X1.5	11.0	18.0	10.0	20	3.6	3.6	2.3

\* Male and female thread lengths have been shortened for compact design. The lengths do not conform to ISO 6149.

# G5G5JAO

Straight Thread Branch Tee  
SAE-ORB (all three ends)

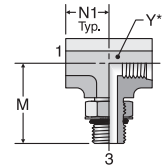

\* Y – Across Wrench Flats

TUBE FITTING PART #	END SIZE			M (in.)	N1 (in.)	Y (in.)	Dynamic Pressure (x 1,000 PSI)		
	1 UN/UNF-2B	2 UN/UNF-2B	3 UN/UNF-2A				-S	-SS	-B
	4 G5G5JAO	7/16 - 20	7/16 - 20				7/16 - 20	1.23	0.63
6 G5G5JAO	9/16 - 18	9/16 - 18	9/16 - 18	1.38	0.75	7/8	5.0	5.0	3.3
8 G5G5JAO	3/4 - 16	3/4 - 16	3/4 - 16	1.59	0.88	1 1/16	4.0	4.0	2.6
10 G5G5JAO	7/8 - 14	7/8 - 14	7/8 - 14	1.81	1.02	1 1/16	2.5	2.5	1.6
12 G5G5JAO	1 1/16 - 12	1 1/16 - 12	1 1/16 - 12	2.00	1.21	1 5/16	2.5	2.5	1.6
16 G5G5JAO	1 5/16 - 12	1 5/16 - 12	1 5/16 - 12	2.25	1.33	1 5/8	2.5	2.5	1.6

TABLE OF CONTENTS

VISUAL INDEX

E

FAQs

ASSEMBLY

GEN TECH

[Click here for CADs, Support Resources or to Configure Parts Online](#)

## AOG5JG5

Straight Thread Run Tee  
SAE-ORB (all three ends)

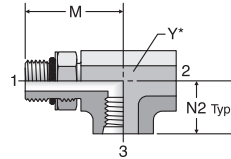

\* Y – Across Wrench Flats

TUBE FITTING PART #	END SIZE			M (in.)	N2 (in.)	Y (in.)	Dynamic Pressure (x 1,000 PSI)		
	1 UN/UNF-2A	2 UN/UNF-2B	3 UN/UNF-2B				-S	-SS	-B
	4 AOG5JG5	7/16 - 20	7/16 - 20						
6 AOG5JG5	9/16 - 18	9/16 - 18	9/16 - 18	1.38	0.86	7/8	5.0	5.0	3.3
8 AOG5JG5	3/4 - 16	3/4 - 16	3/4 - 16	1.59	1.03	1 1/16	4.0	4.0	2.6
10 AOG5JG5	7/8 - 14	7/8 - 14	7/8 - 14	1.81	1.18	1 1/16	2.5	2.5	1.6
12 AOG5JG5	1 1/16 - 12	1 1/16 - 12	1 1/16 - 12	2.00	1.39	1 5/16	2.5	2.5	1.6
16 AOG5JG5	1 5/16 - 12	1 5/16 - 12	1 5/16 - 12	2.25	1.52	1 5/8	2.5	2.5	1.6

TABLE OF CONTENTS

VISUAL INDEX

FAQs

ASSEMBLY

GEN TECH

## G5G5JG5

Female Straight Thread Tee  
SAE-ORB (all three ends)

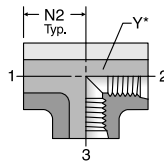

\* Y – Across Wrench Flats

TUBE FITTING PART #	END SIZE			Dynamic Pressure (x 1,000 PSI)		
	1-3 UN/UNF-2B	N2 (in.)	Y (in.)	-S	-SS	-B
	4 G5G5JG5	7/16 - 20	0.74			
6 G5G5JG5	9/16 - 18	0.86	7/8	5.0	5.0	3.3
8 G5G5JG5	3/4 - 16	1.03	1 1/16	4.0	4.0	2.6
10 G5G5JG5	7/8 - 14	1.18	1 1/16	2.5	2.5	1.6
12 G5G5JG5	1 1/16 - 12	1.39	1 5/16	2.5	2.5	1.6
16 G5G5JG5	1 5/16 - 12	1.52	1 5/8	2.5	2.5	1.6

## RRS

Male Pipe Tee  
NPTF (all three ends)

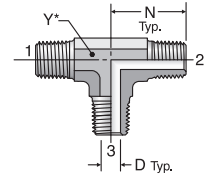

SAE 140437

TUBE FITTING PART #	END SIZE			Dynamic Pressure (x 1,000 PSI)		
	1-3 NPTF	N (in.)	Y (in.)	-S	-SS	-B
	1/8 RRS	1/8 - 27	0.78			
1/4 RRS	1/4 - 18	1.09	9/16	6.0	6.0	3.9
3/8 RRS	3/8 - 18	1.22	3/4	6.0	6.0	3.9
1/2 RRS	1/2 - 14	1.47	7/8	6.0	6.0	3.9
3/4 RRS	3/4 - 14	1.59	1 1/16	4.0	4.0	2.6

**WARNING:** This product can expose you to chemicals including Lead and Lead Compounds which is known to the State of California to cause cancer and birth defects or other reproductive harm. For more information go to [www.p65warnings.ca.gov](http://www.p65warnings.ca.gov).

Dimensions and pressures for reference only, subject to change.

Click here for CADs, Support Resources or to Configure Parts Online

## MMS

Male Branch Tee  
NPTF (all three ends)

SAE 140425  
HPD Base # 212T

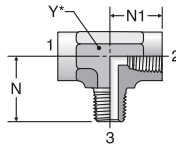

TUBE FITTING PART #	END SIZE 1-3 NPTF	N (in.)	N1 (in.)	Y (in.)	Dynamic Pressure (x 1,000 PSI)		
					-S	-SS	-B
1/8 MMS	1/8 - 27	0.78	0.66	9/16	5.0	5.0	3.2
1/4 MMS	1/4 - 18	1.09	0.88	3/4	5.0	5.0	3.2
3/8 MMS	3/8 - 18	1.22	1.02	7/8	4.5	4.5	3.0
1/2 MMS	1/2 - 14	1.47	1.23	1 1/16	3.0	3.0	1.9
3/4 MMS	3/4 - 14	1.59	1.36	1 5/16	3.0	3.0	1.9
1 MMS	1 - 11 1/2	1.97	1.62	1 5/8	1.8	1.8	1.1

**WARNING:** This product can expose you to chemicals including Lead and Lead Compounds which is known to the State of California to cause cancer and birth defects or other reproductive harm. For more information go to [www.p65warnings.ca.gov](http://www.p65warnings.ca.gov).

## MRO

Male Run Tee  
NPTF (all three ends)

SAE 140424  
HPD Base # 012T

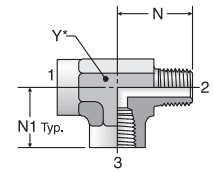

TUBE FITTING PART #	END SIZE 1-3 NPTF	N (in.)	N1 (in.)	Y (in.)	Dynamic Pressure (x 1,000 PSI)		
					-S	-SS	-B
1/8 MRO	1/8 - 27	0.78	0.66	9/16	5.0	5.0	3.2
1/4 MRO	1/4 - 18	1.09	0.88	3/4	5.0	5.0	3.2
3/8 MRO	3/8 - 18	1.22	1.02	7/8	4.5	4.5	3.0
1/2 MRO	1/2 - 14	1.47	1.23	1 1/16	3.0	3.0	1.9
3/4 MRO	3/4 - 14	1.59	1.36	1 5/16	3.0	3.0	1.9
1 MRO	1 - 11 1/2	1.97	1.63	1 5/8	1.8	1.8	1.1
1 1/4 MRO	1 1/4 - 11 1/2	2.38	1.70	1 7/8	1.5	1.5	1.0
1 1/2 MRO	1 1/2 - 11 1/2	2.64	2.08	2 1/2	1.5	1.5	1.0

**WARNING:** This product can expose you to chemicals including Lead and Lead Compounds which is known to the State of California to cause cancer and birth defects or other reproductive harm. For more information go to [www.p65warnings.ca.gov](http://www.p65warnings.ca.gov).

## MMO

Female Pipe Tee  
NPTF (all three ends)

SAE 140438  
HPD Base # 022T

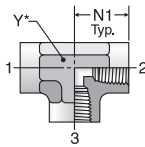

TUBE FITTING PART #	END SIZE 1-3 NPTF	N1 (in.)	Y (in.)	Dynamic Pressure (x 1,000 PSI)		
				-S	-SS	-B
1/8 MMO	1/8 - 27	0.66	9/16	5.0	5.0	3.2
1/4 MMO	1/4 - 18	0.88	3/4	5.0	5.0	3.2
3/8 MMO	3/8 - 18	1.02	7/8	4.5	4.5	3.0
1/2 MMO	1/2 - 14	1.23	1 1/16	3.0	3.0	1.9
3/4 MMO	3/4 - 14	1.36	1 5/16	3.0	3.0	1.9
1 MMO	1 - 11 1/2	1.63	1 5/8	1.8	1.8	1.2
1 1/4 MMO	1 1/4 - 11 1/2	1.70	1 7/8	1.5	1.5	1.0
1 1/2 MMO	1 1/2 - 11 1/2	2.08	2 1/2	1.5	1.5	1.0

**WARNING:** This product can expose you to chemicals including Lead and Lead Compounds which is known to the State of California to cause cancer and birth defects or other reproductive harm. For more information go to [www.p65warnings.ca.gov](http://www.p65warnings.ca.gov).

## MMO444M

Female BSPP Tee  
BSPP (all three ends)

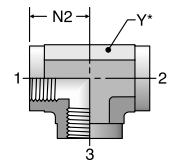

TUBE FITTING PART #	END SIZE 1-3 BSPP	N2 (mm)	Y (mm)	Dynamic Pressure (x 1,000 PSI)		
				S	SS	B
1/4MMO444M	1/4 - 19	22	19	5.0	5.0	3.3
3/8MMO444M	3/8 - 19	26	22	4.5	4.5	2.9
1/2MMO444M	1/2 - 14	31	27	3.0	3.0	1.9
3/4MMO444M	3/4 - 14	40	33	3.0	3.0	1.9
1MMO444M	1 - 11	46	41	1.8	1.8	1.1

**WARNING:** This product can expose you to chemicals including Lead and Lead Compounds which is known to the State of California to cause cancer and birth defects or other reproductive harm. For more information go to [www.p65warnings.ca.gov](http://www.p65warnings.ca.gov).

TABLE OF CONTENTS

VISUAL INDEX

E

FAQs

ASSEMBLY

GEN TECH



Click here for CADs, Support Resources or to Configure Parts Online

# KMMOO

Female Pipe Cross  
NPTF (all four ends)

SAE 140538  
HPD Base # 022X

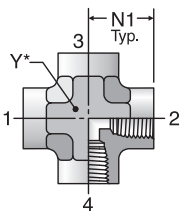

TUBE FITTING PART #	END SIZE	N1 (in.)	Y (in.)	Dynamic Pressure (x 1,000 PSI)		
				1-4 NPTF		
	-S			-SS	-B	
1/8 KMMOO	1/8 - 27	0.66	9/16	5.0	5.0	3.2
1/4 KMMOO	1/4 - 18	0.88	3/4	5.0	5.0	3.2
3/8 KMMOO	3/8 - 18	1.02	7/8	4.5	4.5	2.9
1/2 KMMOO	1/2 - 14	1.23	1 1/16	3.0	3.0	1.9
3/4 KMMOO	3/4 - 14	1.36	1 5/16	3.0	3.0	1.9
1 KMMOO	1 - 11 1/2	1.63	1 5/8	1.8	1.8	1.1

**WARNING:** This product can expose you to chemicals including Lead and Lead Compounds which is known to the State of California to cause cancer and birth defects or other reproductive harm. For more information go to [www.p65warnings.ca.gov](http://www.p65warnings.ca.gov).

# P50N

Hex Head Plug  
SAE-ORB

SAE 090109A  
HPD Base # 05CP

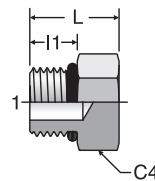

TUBE FITTING PART #	END SIZE	C4 HEX (in.)	I1 (in.)	L (in.)	Dynamic Pressure (x 1,000 PSI)		
					1 UN/UNF-2A		
	-S				-SS	-B	
2 P50N	5/16 - 24	7/16	0.30	0.60	7.5	9.0	3.3
3 P50N	3/8 - 24	1/2	0.30	0.60	7.5	9.0	3.3
4 P50N	7/16 - 20	9/16	0.36	0.67	7.5	9.0	3.3
5 P50N	1/2 - 20	5/8	0.36	0.67	6.0	7.2	3.3
6 P50N	9/16 - 18	11/16	0.39	0.73	6.0	7.2	3.3
8 P50N	3/4 - 16	7/8	0.44	0.80	6.0	7.2	3.3
10 P50N	7/8 - 14	1	0.50	0.94	6.0	7.2	3.3
12 P50N	1 1/16 - 12	1 1/4	0.59	1.09	6.0	7.2	3.3
14 P50N	1 3/16 - 12	1 3/8	0.59	1.09	5.5	6.6	3.3
16 P50N	1 5/16 - 12	1 1/2	0.59	1.13	5.5	6.6	3.3
20 P50N	1 5/8 - 12	1 7/8	0.59	1.20	4.0	4.8	2.6
24 P50N	1 7/8 - 12	2 1/8	0.59	1.27	3.0	3.6	1.9
32 P50N	2 1/2 - 12	2 3/4	0.59	1.44	2.0	2.4	1.3

**WARNING:** This product can expose you to chemicals including Lead and Lead Compounds which is known to the State of California to cause cancer and birth defects or other reproductive harm. For more information go to [www.p65warnings.ca.gov](http://www.p65warnings.ca.gov).

# HP50N

Hollow Hex Plug  
SAE-ORB

SAE 090109B  
HPD Base # 05HP

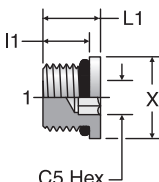

TUBE FITTING PART #	END SIZE	C5 HEX (in.)	I1 (in.)	L1 (in.)	X DIA (in.)	Dynamic Pressure (x 1,000 PSI)		
						1 UN/UNF-2A		
	-S					-SS	-B	
2 HP50N	5/16 - 24	1/8	0.30	0.40	0.44	6.0	6.0	3.3
3 HP50N	3/8 - 24	5/32	0.30	0.40	0.50	6.0	6.0	3.3
4 HP50N	7/16 - 20	3/16	0.36	0.47	0.56	6.0	6.0	3.3
5 HP50N	1/2 - 20	7/32	0.36	0.47	0.63	6.0	6.0	3.3
6 HP50N	9/16 - 18	1/4	0.40	0.50	0.69	6.0	6.0	3.3
8 HP50N	3/4 - 16	5/16	0.44	0.58	0.88	6.0	6.0	3.3
10 HP50N	7/8 - 14	3/8	0.50	0.65	1.00	6.0	6.0	3.3
12 HP50N	1 1/16 - 12	9/16	0.59	0.77	1.25	6.0	6.0	3.3
14 HP50N	1 3/16 - 12	9/16	0.59	0.77	1.38	5.5	5.5	3.3
16 HP50N	1 5/16 - 12	5/8	0.59	0.77	1.50	5.5	5.5	3.3
20 HP50N	1 5/8 - 12	3/4	0.59	0.77	1.88	4.0	4.0	2.6
24 HP50N	1 7/8 - 12	3/4	0.59	0.77	2.13	3.0	3.0	1.9

**WARNING:** This product can expose you to chemicals including Lead and Lead Compounds which is known to the State of California to cause cancer and birth defects or other reproductive harm. For more information go to [www.p65warnings.ca.gov](http://www.p65warnings.ca.gov).

# HP

Hex Head Pipe Plug  
NPTF

SAE 130109E  
HPD Base # 01CP

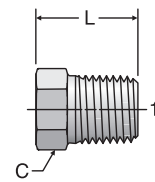

TUBE FITTING PART #	END SIZE	C HEX (in.)	L (in.)	Dynamic Pressure (x 1,000 PSI)		
				1 NPTF		
	-S			-SS	-B	
1/8 HP	1/8 - 27	7/16	0.56	6.0	7.2	3.9
1/4 HP	1/4 - 18	9/16	0.75	6.0	7.2	3.9
3/8 HP	3/8 - 18	11/16	0.78	6.0	7.2	3.9
1/2 HP	1/2 - 14	7/8	0.97	6.0	7.2	3.9
3/4 HP	3/4 - 14	1 1/16	1.06	5.5	6.6	3.5
1 HP*	1 - 11 1/2	1 5/16	1.25	4.5	5.4	3.0
1 1/4 HP	1 1/4 - 11 1/2	1 3/4	1.41	3.0	3.6	1.9
1 1/2 HP	1 1/2 - 11 1/2	2	1.50	3.0	3.6	1.9
2 HP	2 - 11 1/2	2 1/2	1.69	2.0	3.0	1.3

\* 1 HP-SS Hex is 1 3/8

**WARNING:** This product can expose you to chemicals including Lead and Lead Compounds which is known to the State of California to cause cancer and birth defects or other reproductive harm. For more information go to [www.p65warnings.ca.gov](http://www.p65warnings.ca.gov).

TABLE OF CONTENTS

VISUAL INDEX

FAQs

ASSEMBLY

GEN TECH

Dimensions and pressures for reference only, subject to change.

[Click here for CADs, Support Resources or to Configure Parts Online](#)

## SHP

Square Head Plug  
NPTF

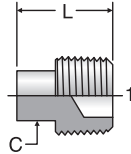

TUBE FITTING PART #	END SIZE 1 NPTF	C SQUARE (in.)	L (in.)	Dynamic Pressure (x 1,000 PSI)		
				-S	-SS	-B
	1/8 SHP	1/8 - 27	9/32	0.51	6.0	7.2
1/4 SHP	1/4 - 18	3/8	0.75	6.0	6.0	3.3
3/8 SHP	3/8 - 18	7/16	0.83	6.0	6.0	3.3
1/2 SHP	1/2 - 14	9/16	1.08	6.0	6.0	3.3
3/4 SHP	3/4 - 14	5/8	1.14	6.0	6.0	3.3
1 SHP	1 - 11 1/2	13/16	1.38	5.5	5.5	3.3

**WARNING:** This product can expose you to chemicals including Lead and Lead Compounds which is known to the State of California to cause cancer and birth defects or other reproductive harm. For more information go to [www.p65warnings.ca.gov](http://www.p65warnings.ca.gov).

## HHP

Hollow Hex Pipe Plug  
NPTF

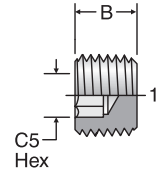

SAE 130109N  
HPD Base # 01HP

TUBE FITTING PART #	END SIZE 1 NPTF	B (in.)	C5 INTERNAL HEX (in.)	Dynamic Pressure (x 1,000 PSI)		
				-S	-SS	-B
	1/16 HHP	1/16 - 27	0.30	5/32	6.0	7.2
1/8 HHP	1/8 - 27	0.30	3/16	6.0	7.2	3.9
1/4 HHP	1/4 - 18	0.46	1/4	6.0	7.2	3.9
3/8 HHP	3/8 - 18	0.46	5/16	6.0	7.2	3.3
1/2 HHP	1/2 - 14	0.61	3/8	6.0	7.2	3.3
3/4 HHP	3/4 - 14	0.62	9/16	5.5	6.6	3.3
1 HHP	1 - 11 1/2	0.77	5/8	4.5	5.4	3.3
1 1/4 HHP	1 1/4 - 11 1/2	0.77	3/4	3.0	5.0	3.3
1 1/2 HHP	1 1/2 - 11 1/2	0.83	1	3.0	3.0	1.9
2 HHP	2 - 11 1/2	0.86	3/4	2.0	2.5	1.6

**WARNING:** This product can expose you to chemicals including Lead and Lead Compounds which is known to the State of California to cause cancer and birth defects or other reproductive harm. For more information go to [www.p65warnings.ca.gov](http://www.p65warnings.ca.gov).

## HPC

Hex Pipe Cap  
NPTF

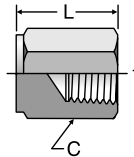

TUBE FITTING PART #	END SIZE 1 NPTF	C HEX (in.)	L (in.)	Dynamic Pressure (x 1,000 PSI)		
				-S	-SS	-B
	1/8 HPC	1/8 - 27	9/16	.75	6.0	6.0
1/4 HPC	1/4 - 18	3/4	.91	6.0	6.0	3.3
3/8 HPC	3/8 - 18	7/8	1.03	6.0	6.0	3.3
1/2 HPC	1/2 - 14	1 1/16	1.34	6.0	6.0	3.3
3/4 HPC	3/4 - 14	1 1/4	1.44	4.8	4.8	3.1
1 HPC	1 - 11 1/2	1 5/8	1.68	3.6	3.6	2.3
1 1/2 HPC	1 1/2 - 1 1/2	2 3/8	1.92	2.4	2.4	1.5

**WARNING:** This product can expose you to chemicals including Lead and Lead Compounds which is known to the State of California to cause cancer and birth defects or other reproductive harm. For more information go to [www.p65warnings.ca.gov](http://www.p65warnings.ca.gov).

## P87OMN

ISO 6149 Hex Head Plug  
ISO 6149  
(for ISO 6149-1 Port)

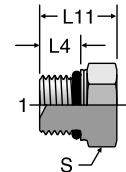

SAE J2244-4\* 62M0109A

TUBE FITTING PART #	END SIZE 1 THREAD	L4 (mm)	L11 (mm)	S HEX (mm)	Dynamic Pressure (x 1,000 PSI)		
					S	SS	B
	M8P87OMN	M8X1	8.5	16.2	12	9.0	9.0
M10P87OMN	M10X1	8.5	16.2	14	8.0	8.0	3.3
M12P87OMN	M12X1.5	11.0	18.5	17	9.0	9.0	3.3
M14P87OMN	M14X1.5	11.0	19.5	19	9.0	9.0	3.3
M16P87OMN	M16X1.5	11.5	21.5	22	9.0	9.0	3.3
M18P87OMN	M18X1.5	12.5	23.5	24	9.0	9.0	3.3
M20P87OMN	M20X1.5	12.5	24.0	27	6.0	6.0	3.3
M22P87OMN	M22X1.5	13.0	25.5	27	6.0	6.0	3.3
M27P87OMN	M27X2	16.0	32.0	32	6.0	6.0	3.3
M30P87OMN	M30X2	16.0	32.0	36	6.0	6.0	3.3
M33P87OMN	M33X2	16.0	32.0	41	6.0	6.0	3.3
M42P87OMN	M42X2	16.0	34.0	50	4.0	4.0	2.6
M48P87OMN	M48X2	17.5	35.5	55	2.0	2.0	1.3
M60P87OMN	M60X2	17.5	42.0	65	1.0	1.0	0.6

\* SAE J2244-4 and ISO 6149-4 are draft standards.

**WARNING:** This product can expose you to chemicals including Lead and Lead Compounds which is known to the State of California to cause cancer and birth defects or other reproductive harm. For more information go to [www.p65warnings.ca.gov](http://www.p65warnings.ca.gov).

TABLE OF CONTENTS

VISUAL INDEX

E

FAQs

ASSEMBLY

GEN TECH

[Click here for CADs, Support Resources or to Configure Parts Online](#)

## VSTI M-OR

ISO 6149 Hollow Hex Plug  
ISO 6149  
(for ISO 6149-1 Port)

SAE J2244-4\* 62M0109B

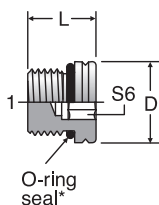

TUBE FITTING PART #	END SIZE			Dynamic Pressure (x 1,000 PSI)			
	1 METRIC	D (mm)	L (mm)	S6 (mm)	CF	71	MS
VSTI10X1OR	M10 x 1	13	13.5	5	9.1	9.1	3.3
VSTI12X1.5OR	M12 x 1.5	17	15.1	6	9.1	9.1	3.3
VSTI14X1.5OR	M14 x 1.5	19	16.0	6	9.1	9.1	3.3
VSTI16X1.5OR	M16 x 1.5	21	17.5	8	9.1	9.1	3.3
VSTI18X1.5OR	M18 x 1.5	23	19.0	8	9.1	9.1	3.3
VSTI22X1.5OR	M22 x 1.5	27	20.0	10	9.1	9.1	3.3
VSTI27X2OR	M27 x 2	32	23.5	12	5.8	5.8	3.3
VSTI33X2OR	M33 x 2	38	25.0	14	5.8	5.8	3.3
VSTI42X2OR	M42 x 2	48	25.5	22	5.8	5.8	3.3

\* SAE J2244-4 is a draft standard

**WARNING:** This product can expose you to chemicals including Lead and Lead Compounds which is known to the State of California to cause cancer and birth defects or other reproductive harm. For more information go to [www.p65warnings.ca.gov](http://www.p65warnings.ca.gov).

## VSTI M-ED

Metric Hollow Hex Plug  
Metric-ED  
(for ISO 9974-1 / DIN 3852-1 Port)

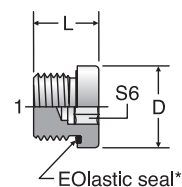

TUBE FITTING PART #	END SIZE			Dynamic Pressure (x 1,000 PSI)			
	1 THREAD	D (mm)	L (mm)	S6 (mm)	CF	71	MS
VSTI10X1ED	M10 x 1	14	12.0	5	5.8	5.8	3.3
VSTI12X1.5ED	M12 x 1.5	17	17.0	6	5.8	5.8	3.3
VSTI14X1.5ED	M14 x 1.5	19	17.0	6	5.8	5.8	3.3
VSTI16X1.5ED	M16 x 1.5	22	17.0	8	5.8	5.8	3.3
VSTI18X1.5ED	M18 x 1.5	24	17.0	8	5.8	5.8	3.3
VSTI20X1.5ED	M20 x 1.5	26	19.0	10	5.8	5.8	3.3
VSTI22X1.5ED	M22 x 1.5	27	19.0	10	5.8	5.8	3.3
VSTI26X1.5ED	M26 x 1.5	32	21.0	12	5.8	5.8	3.3
VSTI27X2ED	M27 x 2	32	21	12	5.8	5.8	3.3
VSTI33X2ED	M33 x 2	40	22.5	17	5.8	5.8	3.3
VSTI42X2ED	M42 x 2	50	22.5	22	4.5	4.5	2.9
VSTI48X2ED	M48 x 2	55	22.5	24	4.5	4.5	2.9

**WARNING:** This product can expose you to chemicals including Lead and Lead Compounds which is known to the State of California to cause cancer and birth defects or other reproductive harm. For more information go to [www.p65warnings.ca.gov](http://www.p65warnings.ca.gov).

## VSTI R-ED

BSPP Hollow Hex Plug  
BSPP-ED  
(for ISO 1179-1 / DIN 3852-2 Port)

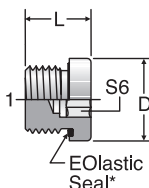

TUBE FITTING PART #	END SIZE			Dynamic Pressure (x 1,000 PSI)			
	1 BSPP	D (mm)	L (mm)	S6 (mm)	CF	71	MS
VSTI1/8ED	1/8 - 28	14	12.0	5	5.8	5.8	3.3
VSTI1/4ED	1/4 - 19	19	17.0	6	5.8	5.8	3.3
VSTI3/8ED	3/8 - 19	22	17.0	8	5.8	5.8	3.3
VSTI1/2ED	1/2 - 14	27	19.0	10	5.8	5.8	3.3
VSTI3/4ED	3/4 - 14	32	21.0	12	5.8	5.8	3.3
VSTI1ED	1 - 11	40	22.5	17	5.8	5.8	3.3
VSTI1 1/4ED	1 1/4 - 11	50	22.5	22	4.5	4.5	2.9
VSTI1 1/2ED	1 1/2 - 11	55	22.5	24	4.5	4.5	2.9

**WARNING:** This product can expose you to chemicals including Lead and Lead Compounds which is known to the State of California to cause cancer and birth defects or other reproductive harm. For more information go to [www.p65warnings.ca.gov](http://www.p65warnings.ca.gov).

## P470MN

Hex Head Plug  
BSPP-ORB  
(for JIS B2351)

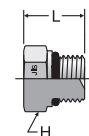

TUBE FITTING PART #	END SIZE		L (mm)	Dynamic Pressure (x 1,000 PSI)		
	1 BSPP	H HEX (mm)		S	SS	B
4P470MN	1/4-19	19	19.1	5.0		
6P470MN	3/8-19	22	20.0	5.0		
8P470MN	1/2-14	27	24.1	5.0		
12P470MN	3/4-14	36	26.9	4.0		
16P470MN	1-11	41	31.0	3.0		

**WARNING:** This product can expose you to chemicals including Lead and Lead Compounds which is known to the State of California to cause cancer and birth defects or other reproductive harm. For more information go to [www.p65warnings.ca.gov](http://www.p65warnings.ca.gov).

TABLE OF CONTENTS

VISUAL INDEX

FAQs

ASSEMBLY

GEN TECH

Dimensions and pressures for reference only, subject to change.

[Click here for CADs, Support Resources or to Configure Parts Online](#)

# HP3M

Hex Head Pipe Plug  
BSPT

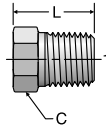

TUBE FITTING PART #	END SIZE	C HEX (mm)	L (mm)	Dynamic Pressure (x 1,000 PSI)		
				1 BSPT		
	S			SS	B	
1/8HP3M	1/8 - 28	10	14.2	6.0	6.0	3.3
1/4HP3M	1/4 - 19	14	19.1	6.0	6.0	3.3
3/8HP3M	3/8 - 19	17	19.8	6.0	6.0	3.3
1/2HP3M	1/2 - 14	22	24.6	6.0	6.0	3.3
3/4HP3M	3/4 - 14	27	26.9	5.5	5.5	3.3
1HP3M	1 - 11	36	31.8	4.5	4.5	2.9

**WARNING:** This product can expose you to chemicals including Lead and Lead Compounds which is known to the State of California to cause cancer and birth defects or other reproductive harm. For more information go to [www.p65warnings.ca.gov](http://www.p65warnings.ca.gov).

TABLE OF CONTENTS

VISUAL INDEX

E

FAQs

ASSEMBLY

GEN TECH









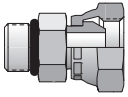
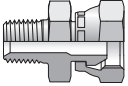
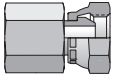

# F PIPE SWIVELS

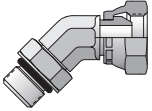
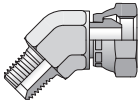
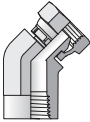

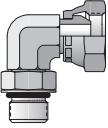
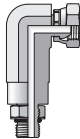
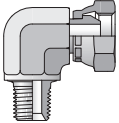
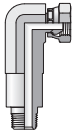
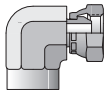
**TABLE  
 OF  
 CONTENTS**

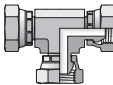
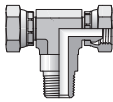
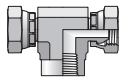
 <p><b>Straights</b></p>	<p><b>0507</b>                  SAE-ORB / NPSM Swivel</p>  <p>F5</p>	<p><b>0107</b>                  NPTF / NPSM Swivel</p>  <p>F5</p>	<p><b>0207</b>                  NPTF / NPSM Swivel</p>  <p>F6</p>	 <p><b>45° Elbows</b></p>	<p><b>3507</b>                  SAE-ORB / NPSM Swivel</p>  <p>F6</p>
<p><b>3107</b>                  NPTF / NPSM Swivel</p>  <p>F6</p>	<p><b>3207</b>                  NPTF / NPSM Swivel</p>  <p>F6</p>	 <p><b>90° Elbows</b></p>	<p><b>2507</b>                  SAE-ORB / NPSM Swivel</p>  <p>F7</p>	<p><b>5507</b>                  SAE-ORB / NPSM Swivel</p>  <p>F7</p>	<p><b>2107</b>                  NPTF / NPSM Swivel</p>  <p>F7</p>
<p><b>5607</b>                  NPTF / NPSM Swivel                  Long Drop</p>  <p>F7</p>	<p><b>2207</b>                  NPTF / NPSM Swivel</p>  <p>F8</p>	 <p><b>Tees</b></p>	<p><b>077T</b>                  NPSM Swivel / NPSM Swivel / NPSM Swivel</p>  <p>F8</p>	<p><b>217T</b>                  NPSM Swivel / NPSM Swivel / NPTF</p>  <p>F8</p>	<p><b>227T</b>                  NPSM Swivel / NPSM Swivel / NPTF</p>  <p>F8</p>

## Pipe Swivels

Pipe (NPSM) swivel connections are one of the most traditional types of hydraulic connections. NPSM swivel adapters add versatility to male NPT hose and adapter connections. This versatility allows equipment manufacturers to simplify their hose assembly requirements by specifying NPSM adapters. See Fig. G1 for an illustration of the various connection configurations allowing product flexibility.

Parker offers a full line of NPSM pipe swivel adapters. Fourteen configurations are available as standard, many of which are available in steel and stainless steel. Parker's pipe swivels are designed for use with male NPT/NPTF hose fittings and adapters with a 30° machined seat.

## How Pipe Swivel Fittings Work

Pipe swivel adapters are manufactured in accordance to SAE J514 specifications, and thus are designed to work in conjunction with several manufacturers' hose and adapter products. Unlike most pipe thread connections, NPSM swivel adapters do not seal on the threads. NPSM swivel connections incorporate parallel threads, as opposed to tapered. Sealing is accomplished between the nose of the swivel and the mating seat of the NPT pipe thread. This creates a metal-to-metal seal as shown in Fig. G2. Thus, a mating NPT male connector must have this 30° seat to ensure proper sealing. A full internal 30° seat with surface finish requirements of 125 Ra or better is required. See SAE J516 for specific requirements of the 30° seat.

**Not all male NPT ends have the 30° seat. Parts that have this seat will include a note in the catalog.**

### Threads:

NPTF:	ANSI B1.20.1, FED-STD-H28/7
NPT:	SAEJ476, ANSI B1.20.3, FED-STD-H28/8
NPSM:	ANSI B1.20.1, FED-STD-H28/7
*UN/UNF:	ANSI B1.1, FED-STD-H28/2 (*Class 2A or 2B)

## Reference Locations

**Assembly and Installation:** Please refer to Section R for the assembly and installation instructions for Pipe Swivels.

**Standard material specifications:** Please refer to Table S34 located in the General Technical Section.

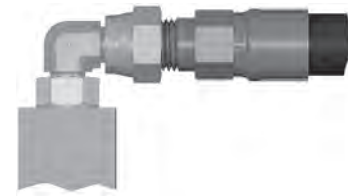

Adapter Port Connection



NPSM / NPT Union

**Fig. G1 — Illustration of the flexibility of the NPT Port and Hose Adapter system**

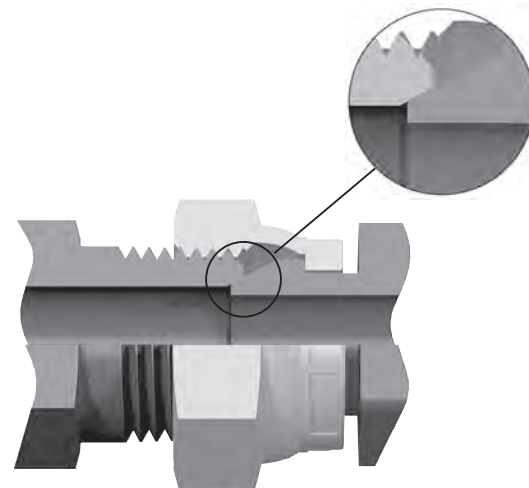

**Fig. G2 — Illustration showing how NPSM swivel adapters seal on mating chamfer in male pipe thread**

TABLE  
OF  
CONTENTS

VISUAL  
INDEX

F

[Click here for CADs, Support Resources or to Configure Parts Online](#)

## Pipe Swivel (NPSM) Ends

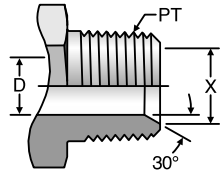

Male Pipe End

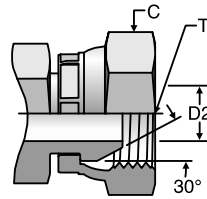

NPSM Pipe Swivel

	NPT/NPTF Thread	NPSM Thread	Hex - Swivel	Drill - Male	Drill - Swivel	Chamfer Dia.	Thread Length
Size	PT NPT/NPTF	T NPSM	C (in.)	D (in.)	D2 (in.)	X (in.)	L (in.)
<b>2</b>	1/8-27	1/8-27	9/16	0.188	0.156	0.281	0.38
<b>4</b>	1/4-18	1/4-18	11/16	0.281	0.219	0.344	0.56
<b>6</b>	3/8-18	3/8-18	7/8	0.406	0.344	0.469	0.56
<b>8</b>	1/2-14	1/2-14	1	0.531	0.469	0.625	0.75
<b>12</b>	3/4-14	3/4-14	1 1/4	0.719	0.641	0.813	0.75
<b>16</b>	1-11 1/2	1-11 1/2	1 1/2	0.938	0.844	1.031	0.94
<b>20</b>	1 1/4-11 1/2	1 1/4-11 1/2	1 7/8	1.250	1.141	1.344	0.97
<b>24</b>	1 1/2-11 1/2	1 1/2-11 1/2	2 1/8	1.500	1.359	1.625	1.00
<b>32</b>	2-11 1/2	2-11 1/2	2 5/8	1.938	1.813	2.063	1.03

TABLE  
OF  
CONTENTS

VISUAL  
INDEX

FAQs

ASSEMBLY

GEN TECH

Click here for CADs, Support Resources or to Configure Parts Online

# 0507

Straight Thread Adapter  
SAE-ORB / NPSM Swivel

SAE 140157

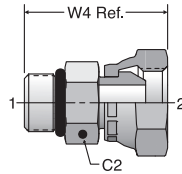

# 0107

Male Pipe Adapter  
NPTF / NPSM Swivel

SAE 140130

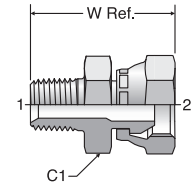

TUBE FITTING PART #	END SIZE		C2 HEX BODY (in.)	W4 (in.)	Dynamic Pressure (x 1,000 PSI)		
	1	2			-S	-SS	-B
	UN/UNF-2A	NPSM					
0507-4-2	7/16 - 20	1/8 - 27	9/16	1.21	6.0	6.0	3.3
0507-4-4	7/16 - 20	1/4 - 18	9/16	1.32	6.0	6.0	3.3
0507-5-4	1/2 - 20	1/4 - 18	5/8	1.32	6.0	6.0	3.3
0507-6-4	9/16 - 18	1/4 - 18	11/16	1.35	6.0	6.0	3.3
0507-6-6	9/16 - 18	3/8 - 18	11/16	1.37	6.0	6.0	3.3
0507-6-8	9/16 - 18	1/2 - 14	3/4	1.57	5.0	5.0	3.3
0507-8-4	3/4 - 16	1/4 - 18	7/8	1.43	6.0	6.0	3.3
0507-8-6	3/4 - 16	3/8 - 18	7/8	1.45	6.0	6.0	3.3
0507-8-8	3/4 - 16	1/2 - 14	7/8	1.56	5.0	5.0	3.3
0507-8-12	3/4 - 16	3/4 - 14	1	1.79	4.0	4.0	2.6
0507-10-6	7/8 - 14	3/8 - 18	1	1.59	5.0	5.0	3.3
0507-10-8	7/8 - 14	1/2 - 14	1	1.73	5.0	5.0	3.3
0507-10-12	7/8 - 14	3/4 - 14	1 1/4	1.88	4.0	4.0	2.6
0507-12-8	1 1/16 - 12	1/2 - 14	1 1/4	1.88	5.0	5.0	3.3
0507-12-12	1 1/16 - 12	3/4 - 14	1 1/4	1.97	4.0	4.0	2.6
0507-12-16	1 1/16 - 12	1 - 11 1/2	1 1/2	2.12	3.0	3.0	1.9
0507-14-12	1 3/16 - 12	3/4 - 14	1 3/8	1.97	4.0	4.0	2.6
0507-16-12	1 5/16 - 12	3/4 - 14	1 1/2	1.90	4.0	4.0	2.6
0507-16-16	1 5/16 - 12	1 - 11 1/2	1 1/2	2.12	3.0	3.0	1.9
0507-20-16	1 5/8 - 12	1 - 11 1/2	1 7/8	2.20	3.0	3.0	1.9
0507-20-20	1 5/8 - 12	1 1/4 - 11 1/2	1 7/8	2.21	2.5	2.5	1.6
0507-24-24	1 7/8 - 12	1 1/2 - 11 1/2	2 1/8	2.39	2.0	2.0	1.3
0507-32-32	2 1/2 - 12	2 - 11 1/2	2 3/4	2.49	1.5	1.5	1.0

**WARNING:** This product can expose you to chemicals including Lead and Lead Compounds which is known to the State of California to cause cancer and birth defects or other reproductive harm. For more information go to [www.p65warnings.ca.gov](http://www.p65warnings.ca.gov).

TUBE FITTING PART #	END SIZE		C1 HEX (in.)	W (in.)	Dynamic Pressure (x 1,000 PSI)		
	1	2			-S	-SS	-B
	NPTF	NPSM					
0107-2-2	1/8 - 27	1/8 - 27	9/16	1.09	6.0	6.0	3.3
0107-2-4	1/8 - 27	1/4 - 18	5/8	1.24	6.0	6.0	3.3
0107-4-2	1/4 - 18	1/8 - 27	11/16	1.39	6.0	6.0	3.3
0107-4-4	1/4 - 18	1/4 - 18	11/16	1.43	6.0	6.0	3.3
0107-4-6	1/4 - 18	3/8 - 18	13/16	1.45	6.0	6.0	3.3
0107-4-8	1/4 - 18	1/2 - 14	15/16	1.44	5.0	5.0	3.3
0107-6-4	3/8 - 18	1/4 - 18	11/16	1.49	6.0	6.0	3.3
0107-6-6	3/8 - 18	3/8 - 18	7/8	1.51	6.0	6.0	3.3
0107-6-8	3/8 - 18	1/2 - 14	15/16	1.73	5.0	5.0	3.3
0107-8-4	1/2 - 14	1/4 - 18	1	1.75	6.0	6.0	3.3
0107-8-6	1/2 - 14	3/8 - 18	7/8	1.70	6.0	6.0	3.3
0107-8-8	1/2 - 14	1/2 - 14	1	1.91	5.0	5.0	3.3
0107-8-12	1/2 - 14	3/4 - 14	1 1/4	2.04	4.0	4.0	2.6
0107-12-8	3/4 - 14	1/2 - 14	1 1/8	1.91	5.0	5.0	2.6
0107-12-12	3/4 - 14	3/4 - 14	1 1/4	2.04	4.0	4.0	2.6
0107-12-16	3/4 - 14	1 - 11 1/2	1 1/2	2.17	3.0	3.0	1.9
0107-16-12	1 - 11 1/2	3/4 - 14	1 3/8	2.29	4.0	4.0	1.9
0107-16-16	1 - 11 1/2	1 - 11 1/2	1 1/2	2.37	3.0	3.0	1.9
0107-16-20	1 - 11 1/2	1 1/4 - 11 1/2	1 3/4	2.38	2.5	2.5	1.6
0107-20-16	1 1/4 - 11 1/2	1 - 11 1/2	1 7/8	2.46	3.0	3.0	1.6
0107-20-20	1 1/4 - 11 1/2	1 1/4 - 11 1/2	1 7/8	2.47	2.5	2.5	1.6
0107-20-24	1 1/4 - 11 1/2	1 1/2 - 11 1/2	2 1/8	2.58	2.0	2.0	1.3
0107-24-20	1 1/2 - 11 1/2	1 1/4 - 11 1/2	2 1/8	2.51	2.5	2.5	1.3
0107-24-24	1 1/2 - 11 1/2	1 1/2 - 11 1/2	2 1/8	2.61	2.0	2.0	1.3
0107-32-32	2 - 11 1/2	2 - 11 1/2	2 5/8	2.80	1.5	1.5	1.0

**WARNING:** This product can expose you to chemicals including Lead and Lead Compounds which is known to the State of California to cause cancer and birth defects or other reproductive harm. For more information go to [www.p65warnings.ca.gov](http://www.p65warnings.ca.gov).

TABLE OF CONTENTS

VISUAL INDEX

FAQs

F

ASSEMBLY

GEN TECH



Click here for CADs, Support Resources or to Configure Parts Online

# 0207

Female Pipe Adapter  
NPTF / NPSM Swivel

SAE 140131

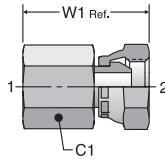

TUBE FITTING PART #	END SIZE		C1 HEX (in.)	W1 (in.)	Dynamic Pressure (x 1,000 PSI)		
	1 NPTF	2 NPSM			-S	-SS	-B
	0207-2-2	1/8 - 27			1/8 - 27	9/16	1.02
0207-2-4	1/8 - 27	1/4 - 18	11/16	1.33	6.0	6.0	3.3
0207-4-2	1/4 - 18	1/8 - 27	9/16	1.32	6.0	6.0	3.3
0207-4-4	1/4 - 18	1/4 - 18	11/16	1.43	6.0	6.0	3.3
0207-6-4	3/8 - 18	1/4 - 18	7/8	1.49	6.0	6.0	3.3
0207-6-6	3/8 - 18	3/8 - 18	7/8	1.51	6.0	6.0	3.3
0207-6-8	3/8 - 18	1/2 - 14	1	1.64	5.0	5.0	3.3
0207-8-4	1/2 - 14	1/4 - 18	1	1.70	5.0	5.0	3.3
0207-8-6	1/2 - 14	3/8 - 18	1	1.73	5.0	5.0	3.3
0207-8-8	1/2 - 14	1/2 - 14	1	1.79	5.0	5.0	3.3
0207-12-8	3/4 - 14	1/2 - 14	1 1/4	1.85	4.0	4.0	2.6
0207-12-12	3/4 - 14	3/4 - 14	1 1/4	1.97	4.0	4.0	2.6
0207-16-12	1 - 11 1/2	3/4 - 14	1 1/2	2.28	3.0	3.0	1.9
0207-16-16	1 - 11 1/2	1 - 11 1/2	1 1/2	2.37	3.0	3.0	1.9
0207-20-20	1 1/4 - 11 1/2	1 1/4 - 11 1/2	1 7/8	2.38	2.5	2.5	1.6
0207-24-24	1 1/2 - 11 1/2	1 1/2 - 11 1/2	2 1/8	2.42	2.0	2.0	1.3
0207-32-32	2 - 11 1/2	2 - 11 1/2	2 5/8	2.55	1.5	1.5	1.0

**WARNING:** This product can expose you to chemicals including Lead and Lead Compounds which is known to the State of California to cause cancer and birth defects or other reproductive harm. For more information go to [www.p65warnings.ca.gov](http://www.p65warnings.ca.gov).

# 3107

45° Male Pipe Elbow  
NPTF / NPSM Swivel

SAE 140330

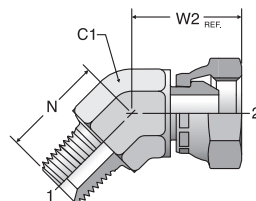

TUBE FITTING PART #	END SIZE		C1 HEX (in.)	N (in.)	W2 (in.)	Dynamic Pressure (x 1,000 PSI)		
	1 NPTF	2 NPSM				-S	-SS	-B
	3107-2-2	1/8 - 27				1/8 - 27	7/16	0.52
3107-4-4	1/4 - 18	1/4 - 18	9/16	0.86	0.91	6.0	6.0	3.3
3107-6-6	3/8 - 18	3/8 - 18	3/4	0.95	1.10	6.0	6.0	3.3
3107-6-8	3/8 - 18	1/2 - 14	1 1/16	1.09	1.16	5.0	5.0	3.3
3107-8-4	1/2 - 14	1/4 - 18	1 1/16	1.34	0.96	5.0	5.0	3.3
3107-8-6	1/2 - 14	3/8 - 18	7/8	1.17	1.10	6.0	6.0	3.3
3107-8-8	1/2 - 14	1/2 - 14	7/8	1.17	1.17	5.0	5.0	3.3
3107-8-12	1/2 - 14	3/4 - 14	1 1/16	1.50	1.24	3.0	3.0	1.9
3107-12-8	3/4 - 14	1/2 - 14	1 1/16	1.20	1.23	4.0	4.0	1.9
3107-12-12	3/4 - 14	3/4 - 14	1 1/16	1.20	1.37	3.0	3.0	1.9
3107-12-16	3/4 - 14	1 - 11 1/2	1 5/16	1.50	1.32	2.5	2.5	1.6
3107-16-12	1 - 11 1/2	3/4 - 14	1 5/16	1.48	1.47	3.0	3.0	1.6
3107-16-16	1 - 11 1/2	1 - 11 1/2	1 5/16	1.48	1.52	2.5	2.5	1.6
3107-20-16	1 1/4 - 11 1/2	1 - 11 1/2	1 5/8	1.75	1.55	2.5	2.5	1.3
3107-20-20	1 1/4 - 11 1/2	1 1/4 - 11 1/2	1 5/8	1.67	1.61	2.0	2.0	1.3
3107-24-24	1 1/2 - 11 1/2	1 1/2 - 11 1/2	1 7/8	1.77	1.77	2.0	2.0	1.3
3107-32-32	2 - 11 1/2	2 - 11 1/2	2 1/2	2.11	1.89	1.1	1.1	0.7

# 3507

45° Straight Thread Elbow  
SAE-ORB / NPSM Swivel

SAE 140357

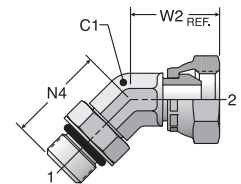

TUBE FITTING PART #	END SIZE		C1 HEX (in.)	N4 (in.)	W2 (in.)	Dynamic Pressure (x 1,000 PSI)		
	1 UN/UNF-2A	2 NPSM				-S	-SS	-B
	3507-4-4	7/16 - 20				1/4 - 18	7/16	1.05
3507-6-4	9/16 - 18	1/4 - 18	9/16	1.11	0.94	6.0	6.0	3.3
3507-6-6	9/16 - 18	3/8 - 18	9/16	1.14	1.03	6.0	6.0	3.3
3507-6-8	9/16 - 18	1/2 - 14	3/4	1.08	1.16	5.0	5.0	3.3
3507-8-6	3/4 - 16	3/8 - 18	3/4	1.30	1.02	6.0	6.0	3.3
3507-8-8	3/4 - 16	1/2 - 14	3/4	1.30	1.18	5.0	5.0	3.3
3507-8-12	3/4 - 16	3/4 - 14	3/4	1.41	1.37	3.0	3.0	1.9
3507-10-6	7/8 - 14	3/8 - 18	1 1/16	1.35	0.98	5.0	5.0	3.3
3507-10-8	7/8 - 14	1/2 - 14	7/8	1.52	1.17	5.0	5.0	3.3
3507-10-12	7/8 - 14	3/4 - 14	1 1/16	1.36	1.40	3.0	3.0	1.9
3507-12-8	1 1/16 - 12	1/2 - 14	1 1/16	1.73	1.12	5.0	5.0	3.3
3507-12-12	1 1/16 - 12	3/4 - 14	1 1/16	1.73	1.37	3.0	3.0	1.9
3507-16-16	1 5/16 - 12	1 - 11 1/2	1 5/16	1.86	1.52	2.5	2.5	1.6

# 3207

45° Female Pipe Elbow  
NPTF / NPSM Swivel

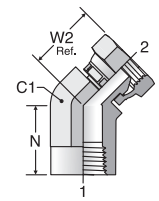

TUBE FITTING PART #	END SIZE		C1 HEX (in.)	N (in.)	W2 (in.)	Dynamic Pressure (x 1,000 PSI)		
	1 NPTF	2 NPSM				-S	-SS	-B
	3207-4-4	1/4 - 18				1/4 - 18	3/4	0.91
3207-6-6	3/8 - 18	3/8 - 18	7/8	1.00	0.97	4.5	4.5	2.9
3207-8-8	1/2 - 14	1/2 - 14	1 1/16	1.01	1.12	3.0	3.0	1.9
3207-12-12	3/4 - 14	3/4 - 14	1 5/16	1.25	1.31	3.0	3.0	1.9
3207-16-16	1 - 11 1/2	1 - 11 1/2	1 5/8	1.44	1.55	1.8	1.8	1.1

TABLE OF CONTENTS

VISUAL INDEX

FAQs

ASSEMBLY

GEN TECH

[Click here for CADs, Support Resources or to Configure Parts Online](#)

## 2507

Straight Thread Elbow  
SAE-ORB / NPSM Swivel

SAE 140257

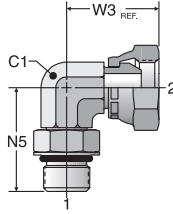

TUBE FITTING PART #	END SIZE		C1 HEX (in.)	N5 (in.)	W3 (in.)	Dynamic Pressure (x 1,000 PSI)		
	1	2				-S	-SS	-B
	UN/UNF-2A	NPSM						
2507-4-4	7/16 - 20	1/4 - 18	7/16	1.03	0.97	6.0	6.0	3.3
2507-4-6	7/16 - 20	3/8 - 18	9/16	1.28	1.23	6.0	6.0	3.3
2507-6-4	9/16 - 18	1/4 - 18	9/16	1.25	1.06	6.0	6.0	3.3
2507-6-6	9/16 - 18	3/8 - 18	9/16	1.25	1.10	6.0	6.0	3.3
2507-6-8	9/16 - 18	1/2 - 14	3/4	1.41	1.29	5.0	5.0	3.3
2507-8-4	3/4 - 16	1/4 - 18	3/4	1.30	1.09	6.0	6.0	3.3
2507-8-6	3/4 - 16	3/8 - 18	3/4	1.45	1.19	6.0	6.0	3.3
2507-8-8	3/4 - 16	1/2 - 14	3/4	1.45	1.33	5.0	5.0	3.3
2507-8-12	3/4 - 16	3/4 - 14	3/4	1.62	1.65	3.0	3.0	1.9
2507-10-6	7/8 - 14	3/8 - 18	7/8	1.70	1.26	5.0	5.0	3.3
2507-10-8	7/8 - 14	1/2 - 14	7/8	1.70	1.40	5.0	5.0	3.3
2507-10-12	7/8 - 14	3/4 - 14	7/8	1.78	1.62	3.0	3.0	1.9
2507-12-8	1 1/16 - 12	1/2 - 14	1 1/16	1.94	1.50	5.0	5.0	3.3
2507-12-12	1 1/16 - 12	3/4 - 14	1 1/16	1.94	1.65	3.0	3.0	1.9
2507-12-16	1 1/16 - 12	1 - 11 1/2	1 3/16	2.08	1.91	2.5	2.5	1.6
2507-16-12	1 5/16 - 12	3/4 - 14	1 3/16	2.08	1.89	3.0	3.0	1.9
2507-16-16	1 5/16 - 12	1 - 11 1/2	1 5/16	2.05	1.91	2.5	2.5	1.6
2507-20-20	1 5/8 - 12	1 1/4 - 11 1/2	1 5/8	2.25	2.16	2.0	2.0	1.3
2507-24-24	1 7/8 - 12	1 1/2 - 11 1/2	1 7/8	2.39	2.31	1.1	1.1	0.7

## 5507

Long Straight Thread Elbow  
SAE-ORB / NPSM Swivel

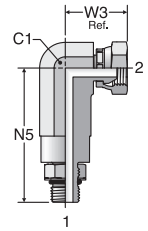

TUBE FITTING PART #	END SIZE		C1 HEX (in.)	N5 (in.)	W3 (in.)	Dynamic Pressure (x 1,000 PSI)		
	1	2				-S	-SS	-B
	UN/UNF-2A	NPSM						
5507-4-4	7/16 - 20	1/4 - 18	3/4	2.19	1.13	6.0	6.0	3.3
5507-6-6	9/16 - 18	3/8 - 18	7/8	2.59	1.20	6.0	6.0	3.3
5507-8-6	3/4 - 16	3/8 - 18	7/8	2.47	1.20	6.0	6.0	3.3

## 2107

Male Pipe Elbow  
NPTF / NPSM Swivel

SAE 140230

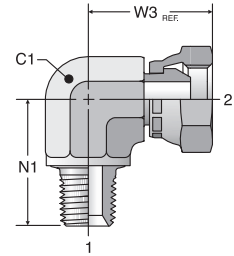

TUBE FITTING PART #	END SIZE		C1 HEX (in.)	N1 (in.)	W3 (in.)	Dynamic Pressure (x 1,000 PSI)		
	1	2				-S	-SS	-B
	NPTF	NPSM						
2107-2-2	1/8 - 27	1/8 - 27	7/16	0.72	0.85	6.0	6.0	3.3
2107-2-4	1/8 - 27	1/4 - 18	7/16	1.00	0.97	6.0	6.0	3.3
2107-4-2	1/4 - 18	1/8 - 27	9/16	1.02	1.05	6.0	6.0	3.3
2107-4-4	1/4 - 18	1/4 - 18	9/16	1.09	1.06	6.0	6.0	3.3
2107-4-6	1/4 - 18	3/8 - 18	3/4	1.09	1.28	6.0	6.0	3.3
2107-6-4	3/8 - 18	1/4 - 18	3/4	1.22	1.17	6.0	6.0	3.3
2107-6-6	3/8 - 18	3/8 - 18	3/4	1.22	1.28	6.0	6.0	3.3
2107-6-8	3/8 - 18	1/2 - 14	3/4	1.22	1.33	5.0	5.0	3.3
2107-8-4	1/2 - 14	1/4 - 18	7/8	1.69	1.18	6.0	6.0	3.3
2107-8-6	1/2 - 14	3/8 - 18	7/8	1.47	1.35	6.0	6.0	3.3
2107-8-8	1/2 - 14	1/2 - 14	7/8	1.47	1.40	5.0	5.0	3.3
2107-8-12	1/2 - 14	3/4 - 14	1 1/16	1.47	1.65	3.0	3.0	1.9
2107-12-6	3/4 - 14	3/8 - 18	1 1/16	1.59	1.48	4.0	4.0	2.6
2107-12-8	3/4 - 14	1/2 - 14	1 1/16	1.59	1.53	4.0	4.0	2.6
2107-12-12	3/4 - 14	3/4 - 14	1 1/16	1.59	1.65	3.0	3.0	1.9
2107-12-16	3/4 - 14	1 - 11 1/2	1 3/16	2.19	1.72	2.5	2.5	1.6
2107-16-12	1 - 11 1/2	3/4 - 14	1 5/16	1.97	1.82	3.0	3.0	1.9
2107-16-16	1 - 11 1/2	1 - 11 1/2	1 5/16	1.97	1.91	2.5	2.5	1.6
2107-16-20	1 - 11 1/2	1 1/4 - 11 1/2	1 7/16	2.41	1.87	2.0	2.0	1.3
2107-20-16	1 1/4 - 11 1/2	1 - 11 1/2	1 5/8	2.62	1.98	2.5	2.5	1.6
2107-20-20	1 1/4 - 11 1/2	1 1/4 - 11 1/2	1 5/8	2.38	2.11	2.0	2.0	1.3
2107-24-24	1 1/2 - 11 1/2	1 1/2 - 11 1/2	1 7/8	2.64	2.31	2.0	2.0	1.0
2107-32-32	2 - 11 1/2	2 - 11 1/2	2 1/2	3.00	2.70	1.1	1.1	0.7

## 5607

Long Male Pipe Elbow  
NPTF / NPSM Swivel

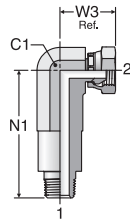

TUBE FITTING PART #	END SIZE		C1 HEX (in.)	N1 (in.)	W3 (in.)	Dynamic Pressure (x 1,000 PSI)		
	1	2				-S	-SS	-B
	NPTF	NPSM						
5607-2-2	1/8 - 27	1/8 - 27	9/16	1.64	0.92	6.0	6.0	3.3
5607-4-4	1/4 - 18	1/4 - 18	3/4	2.25	1.16	6.0	6.0	3.3
5607-6-6	3/8 - 18	3/8 - 18	7/8	2.76	1.20	6.0	6.0	3.3
5607-8-8	1/2 - 14	1/2 - 14	1 1/16	3.19	1.48	5.0	5.0	3.3
5607-12-12	3/4 - 14	3/4 - 14	1 5/16	3.66	1.69	3.0	3.0	1.9
5607-16-16	1 - 11 1/2	1 - 11 1/2	1 7/8	4.31	2.15	2.5	2.5	1.6

TABLE OF CONTENTS

VISUAL INDEX

FAQs

F

ASSEMBLY

GEN TECH

[Click here for CADs, Support Resources or to Configure Parts Online](#)

## 2207

Female Pipe Elbow  
NPTF / NPSM Swivel

SAE 140231

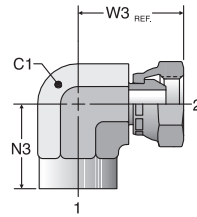

TUBE FITTING PART #	END SIZE		C1 HEX (in.)	N3 (in.)	W3 (in.)	Dynamic Pressure (x 1,000 PSI)		
	1 NPTF	2 NPSM				-S	-SS	-B
2207-2-2	1/8 - 27	1/8 - 27	9/16	0.66	0.95	5.0	5.0	3.3
2207-4-4	1/4 - 18	1/4 - 18	3/4	0.88	1.17	5.0	5.0	3.3
2207-4-6	1/4 - 18	3/8 - 18	7/8	0.88	1.26	4.5	4.5	2.9
2207-6-6	3/8 - 18	3/8 - 18	7/8	1.02	1.26	4.5	4.5	2.9
2207-8-6	1/2 - 14	3/8 - 18	1 1/16	1.37	1.34	3.0	3.0	1.9
2207-8-8	1/2 - 14	1/2 - 14	1 1/16	1.23	1.53	3.0	3.0	1.9
2207-12-12	3/4 - 14	3/4 - 14	1 5/16	1.36	1.82	3.0	3.0	1.9
2207-16-16	1 - 11 1/2	1 - 11 1/2	1 5/8	1.62	2.10	1.8	1.8	1.1
2207-20-20	1 1/4 - 11 1/2	1 1/4 - 11 1/2	1 7/8	1.70	2.21	1.5	1.5	1.0
2207-24-24	1 1/2 - 11 1/2	1 1/2 - 11 1/2	2 1/2	2.08	2.83	1.5	1.5	1.0
2207-32-32	2 - 11 1/2	2 - 11 1/2	2 13/16	2.39	3.00	1.1	1.1	0.7

## 077T

NPSM Union Tee  
NPSM Swivel (all three ends)

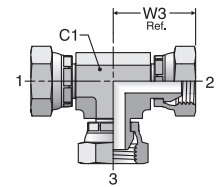

TUBE FITTING PART #	END SIZE			C1 HEX (in.)	W3 (in.)	Dynamic Pressure (x 1,000 PSI)		
	1 NPSM	2 NPSM	3 NPSM			-S	-SS	-B
077T-2	1/8 - 27	1/8 - 27	1/8 - 27	7/16	0.89	6.0	7.2	3.3
077T-4	1/4 - 18	1/4 - 18	1/4 - 18	9/16	1.06	6.0	7.2	3.3
077T-6	3/8 - 18	3/8 - 18	3/8 - 18	3/4	1.15	6.0	7.2	3.3
077T-8	1/2 - 14	1/2 - 14	1/2 - 14	3/4	1.29	5.0	6.0	3.3
077T-12	3/4 - 14	3/4 - 14	3/4 - 14	1 1/16	1.65	3.0	3.6	1.9

TABLE OF CONTENTS

VISUAL INDEX

FAQs

ASSEMBLY

GEN TECH

## 217T

Male Pipe Branch Tee  
NPTF / NPSM Swivel /  
NPSM Swivel

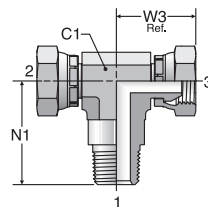

TUBE FITTING PART #	END SIZE			C1 HEX (in.)	N1 (in.)	W3 (in.)	Dynamic Pressure (x 1,000 PSI)		
	1 NPTF	2 NPSM	3 NPSM				-S	-SS	-B
217T-2-2	1/8 - 27	1/8 - 27	1/8 - 27	9/16	0.97	0.92	6.0	6.0	3.3
217T-4-4	1/4 - 18	1/4 - 18	1/4 - 18	9/16	1.19	1.03	6.0	6.0	3.3
217T-6-6	3/8 - 18	3/8 - 18	3/8 - 18	3/4	1.50	1.15	6.0	6.0	3.3
217T-8-6	1/2 - 14	3/8 - 18	3/8 - 18	3/4	1.69	1.21	6.0	6.0	3.3
217T-8-8	1/2 - 14	1/2 - 14	1/2 - 14	3/4	1.81	1.35	5.0	5.0	3.3
217T-12-12	3/4 - 14	3/4 - 14	3/4 - 14	1 1/16	2.00	1.60	3.0	3.0	1.9
217T-16-16	1 - 11 1/2	1 - 11 1/2	1 - 11 1/2	1 1/16	2.37	1.86	2.5	2.5	1.6

## 227T

Female Pipe Branch Tee  
NPTF / NPSM Swivel /  
NPSM Swivel

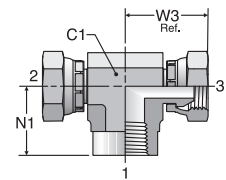





TUBE FITTING PART #	END SIZE			C1 HEX (in.)	N1 (in.)	W3 (in.)	Dynamic Pressure (x 1,000 PSI)		
	1 NPTF	2 NPSM	3 NPSM				-S	-SS	-B
227T-4-4	1/4 - 18	1/4 - 18	1/4 - 18	3/4	0.94	1.13	5.0	5.0	3.2
227T-6-6	3/8 - 18	3/8 - 18	3/8 - 18	7/8	1.00	1.20	4.5	4.5	2.9
227T-8-8	1/2 - 14	1/2 - 14	1/2 - 14	1 1/16	1.17	1.46	3.0	3.0	1.9
227T-12-12	3/4 - 14	3/4 - 14	3/4 - 14	1 3/16	1.44	1.60	3.0	3.0	1.9

# G

# JIS FITTINGS

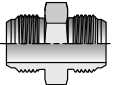
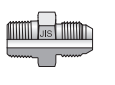
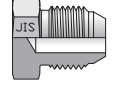
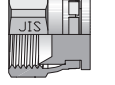
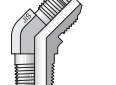

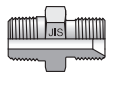
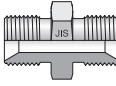
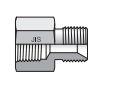
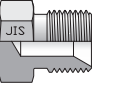
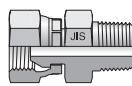
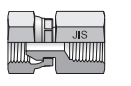
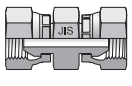
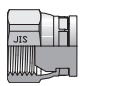
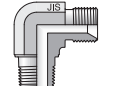
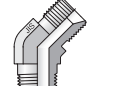
TABLE  
OF  
CONTENTS

 <p><b>30° Flare</b></p>	<p><b>HT4</b> JIS Union / 30° Flare</p>  <p>G5</p>	<p><b>F3T4</b> BSPT / 30° Flare</p>  <p>G5</p>	<p><b>PNMT4</b> Plug</p>  <p>G5</p>	<p><b>FNMT4</b> Cap</p>  <p>G5</p>	<p><b>V3T4</b> BSPT / 30° Flare</p>  <p>G6</p>
<p><b>C3T4</b> BSPT / 30° Flare</p>  <p>G6</p>	 <p><b>60° Cone</b></p>	<p><b>F3P4</b> BSPT / 60° Cone</p>  <p>G6</p>	<p><b>HP4</b> Union</p>  <p>G6</p>	<p><b>G3P4</b> BSPT / 60° Cone</p>  <p>G7</p>	<p><b>PNMP4</b> Plug</p>  <p>G7</p>
<p><b>F63P4</b> 60° Swivel / BSPT</p>  <p>G7</p>	<p><b>G63P4</b> 60° Swivel / BSPT</p>  <p>G7</p>	<p><b>HP46</b> Union Swivel</p>  <p>G8</p>	<p><b>FNMP4</b> Cap</p>  <p>G8</p>	<p><b>C3P4</b> BSPT / 60° Cone</p>  <p>G8</p>	<p><b>V3P4</b> BSPT / 60° Cone</p>  <p>G8</p>
 <p><b>B2351 Port</b></p>	<p><b>P47OMN</b> Hex Head Plug</p>  <p>G8</p>				

**O-Rings and Seals** (Shown in Section M)

 <p><b>JIS O-Rings and Seals</b></p>	<p><b>JIS B2351 O-Ring</b></p>  <p>M7</p>
---	--

Dimensions and pressures for reference only, subject to change.



## JIS Fittings

Parker introduced Japanese Industrial Standard (JIS) adapters in the early 1990s to address market requirements for OEM and replacement fittings. These fittings are typically used as hose adapters on equipment designed and/or manufactured in Japan and Korea. Parker's JIS adapters are designed with 30° flare and 60° cone connections and typically incorporate BSP threads.

Parker JIS adapters are designed with BSPP and BSPT port ends and two styles of hose ends: T4 (30° flare, BSPP threads) and P4 (60° cone, BSPP threads). Two additional Parker series of fittings, KA (Komatsu flare) and K4 (BS B5200) adapters, are similar to JIS style fittings and appear in sections H and I of this catalog.

The T4 and P4 interfaces, as shown in Fig. G1, provide end user flexibility of connecting to the most common Parker hose ends available as listed in Table G1.

Parker's JIS adapter offering that uses the BSPP port connection are manufactured in accordance with the JIS B2351 type "O" port connection which is commonly used for higher pressure systems. Fig. G2 illustrates this port connection and Table G2 shows appropriate JIS B2351 O-rings and dash sizes.

It should be noted that Parker offers two very similar cone style BSPP adapters — P4 and K4. Parker's K4 (60 cone, BSPP) fittings conform to BS5200, while Parker's JIS cone adapters meet JIS B8363 specifications. **These fittings, while very similar, are not interchangeable.** See the H section of this catalog for more specific information on their differences. **Or, read our article *BSPP 60-degree Cone Fittings: Looks Can be Deceiving.***

## Design and Construction

**Construction:** Shaped JIS adapters are manufactured from a hot forged construction. Straight adapters are manufactured from cold drawn barstock.

**Threads:** The standard JIS products are manufactured with the thread forms listed below:

BSPP Threads: ISO 228-1 G, JIS B 0202,  
BSPT Threads: ISO 7/1, JIS B 0203

**Identification:** All Parker JIS fittings are stamped with "JIS" for positive identification and differentiation from similar style fittings.

## Reference Locations

**Dynamic Pressure Ratings:** Please refer to the last column of part number tables located on the following pages of this section for the appropriate dynamic pressure ratings.

**Standard Material Specifications:** Please refer to Table S34 located in the General Technical section.

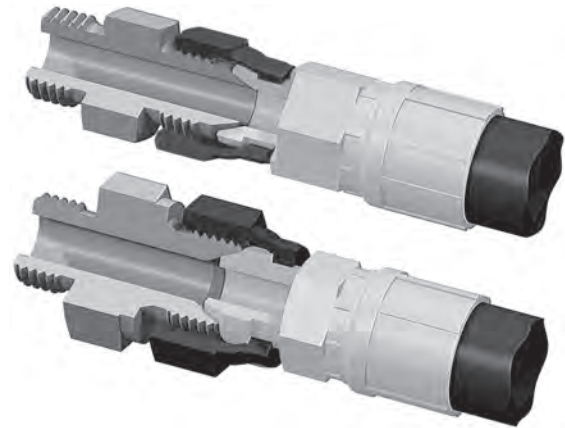

Fig. G1 – JIS T4 and P4 Interfaces

Adapter Connection End	Mating Parker Hose Fitting Series
P4 / P46	UT, GU, G1, G2
T4 / T46	FU

Table G1 – Parker JIS Fittings Hose Adaptability

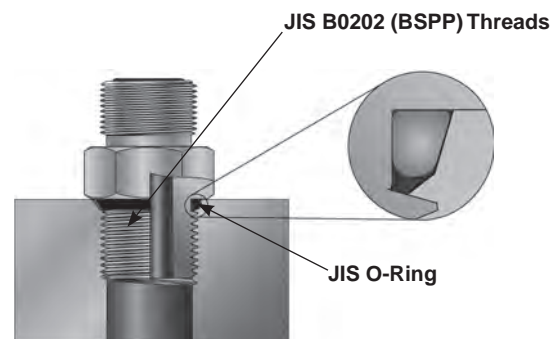

Fig. G2 – JIS B2351 Type "O" Port Connection

"G" Thread BSPP per ISO 228-1 JIS B 0202	Dash Size	Port O-Ring (See Pg. N6)
1/8-28	2	P8
1/4-19	4	P11
3/8-19	6	P14
1/2-14	8	P18
3/4-14	12	P24
1-11	16	P29

Table G2 – JIS B2351 Port Threads and O-Rings as shown in Fig. G2

TABLE OF CONTENTS

VISUAL INDEX

G

## JIS Ends

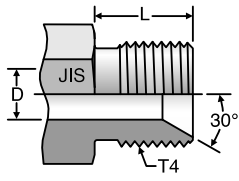

JIS Male, 60° Seat

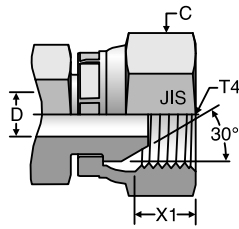

JIS Swivel  
for 60° Seat

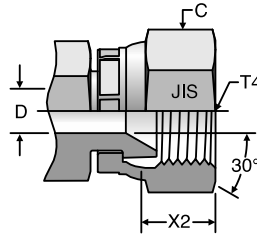

JIS Swivel  
for 30° Flare

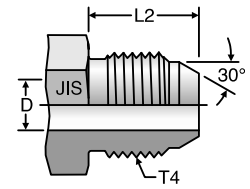

JIS Male, 30° Flare

	BSPP Thread	Swivel Hex	Drill	Male Turn Back		Assembly Allowance	
Dash Size	T4 BSPP	C (in)	D (in)	L (in)	L2 (in)	X1 (in)	X2 (in)
4	1/4-19	.75	0.177	.570	.606	0.35	0.36
6	3/8-19	.88	0.275	.609	.684	0.29	0.38
8	1/2-14	1.06	0.433	.726	.763	0.46	0.53
12	3/4-14	1.44	0.625	.805	.842	0.55	0.56
16	1-11	1.63	0.828	.883	.881	0.53	0.58

Dimensions and pressures for reference only, subject to change.

Click here for CADs, Support Resources or to Configure Parts Online

## HT4

JIS Union Flare  
30° Flare / 30° Flare

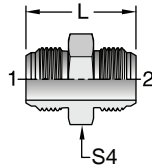

TUBE FITTING PART #	End Size		S4 Hex (in.)	L (in.)	Dynamic Pressure (x 1,000 PSI)	
	1 BSPP	2 BSPP			-S	S
4 HT4	1/4-19	1/4-19	3/4	1.45	5.0	
6 HT4	3/8-19	3/8-19	7/8	1.68	5.0	
8 HT4	1/2-14	1/2-14	1 1/16	1.88	5.0	
12 HT4	3/4-14	3/4-14	1 7/16	2.12	4.0	
16 HT4	1-11	1-11	1 5/8	2.28	3.0	

**WARNING:** This product can expose you to chemicals including Lead and Lead Compounds which is known to the State of California to cause cancer and birth defects or other reproductive harm. For more information go to [www.p65warnings.ca.gov](http://www.p65warnings.ca.gov).

## F3T4

Male Connector  
30° Flare / BSPT

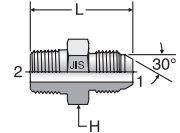

Mates with FU Style hose fittings

TUBE FITTING PART #	END SIZE		H HEX (in.)	L (in.)	Dynamic Pressure (x 1,000 PSI)	
	1 BSPP	2 BSPT			-S	S
4F3T4	1/4 - 19	1/4 - 19	0.75	1.46	5.0	
4-6F3T4	1/4 - 19	3/8 - 19	0.88	1.51	5.0	
6-4F3T4	3/8 - 19	1/4 - 19	0.88	1.59	5.0	
6F3T4	3/8 - 19	3/8 - 19	0.88	1.59	5.0	
8-6F3T4	1/2 - 14	3/8 - 19	1.06	1.70	5.0	
8F3T4	1/2 - 14	1/2 - 14	1.06	1.89	5.0	
12F3T4	3/4 - 14	3/4 - 14	1.44	2.10	4.0	
16F3T4	1-11	1-11	1.63	2.30	3.0	

**WARNING:** This product can expose you to chemicals including Lead and Lead Compounds which is known to the State of California to cause cancer and birth defects or other reproductive harm. For more information go to [www.p65warnings.ca.gov](http://www.p65warnings.ca.gov).

## PNMT4

Plug  
30° Flare

Mates with FU Style hose fittings

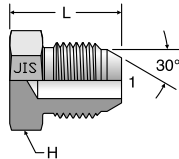

TUBE FITTING PART #	END SIZE	H HEX (mm)	L (in.)	Dynamic Pressure (x 1,000 PSI)	
	1 BSPP			-S	S
4PNMT4	1/4 - 19	17	0.89	5.0	
6PNMT4	3/8 - 19	19	0.97	5.0	
8PNMT4	1/2 - 14	22	1.11	5.0	
12PNMT4	3/4 - 14	30	1.26	4.0	
16PNMT4	1-11	36	1.30	3.0	

**WARNING:** This product can expose you to chemicals including Lead and Lead Compounds which is known to the State of California to cause cancer and birth defects or other reproductive harm. For more information go to [www.p65warnings.ca.gov](http://www.p65warnings.ca.gov).

## FNMT4

Cap  
30° Flare

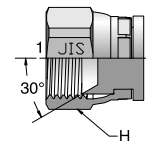

TUBE FITTING PART #	END SIZE	H HEX (in.)	Dynamic Pressure (x 1,000 PSI)	
	1 BSPP		-S	S
4FNMT4	1/4 - 19	0.75	5.0	
6FNMT4	3/8 - 19	0.88	5.0	
8FNMT4	1/2 - 14	1.06	5.0	
12FNMT4	3/4 - 14	1.44	4.0	
16FNMT4	1-11	1.63	3.0	

**WARNING:** This product can expose you to chemicals including Lead and Lead Compounds which is known to the State of California to cause cancer and birth defects or other reproductive harm. For more information go to [www.p65warnings.ca.gov](http://www.p65warnings.ca.gov).

TABLE OF CONTENTS

VISUAL INDEX

FAQs

G

GEN TECH

Dimensions and pressures for reference only, subject to change

Click here for CADs, Support Resources or to Configure Parts Online

## V3T4

45° Male Elbow  
30° Flare / BSPT

Mates with FU Style hose fittings

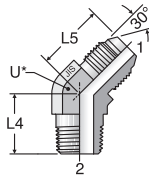

\* Across wrench flats

TUBE FITTING PART #	END SIZE		L4 (in.)	L5 (in.)	U (in.)	Dynamic Pressure (x 1,000 PSI)
	1 BSPP	2 BSPT				S
	4V3T4	1/4 - 19				1/4 - 19
6V3T4	3/8 - 19	3/8 - 19	0.87	0.97	0.75	5.0
8V3T4	1/2 - 14	1/2 - 14	1.06	1.10	0.88	5.0
12V3T4	3/4 - 14	3/4 - 14	1.18	1.24	1.06	4.0
16V3T4	1-11	1-11	1.37	1.26	1.31	3.0

## C3T4

Male Elbow  
30° Flare / BSPT

Mates with FU Style hose fittings

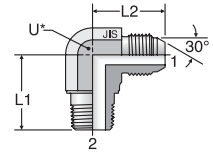

\* Across wrench flats

TUBE FITTING PART #	END SIZE		L1 (in.)	L2 (in.)	U (in.)	Dynamic Pressure (x 1,000 PSI)
	1 BSPP	2 BSPT				S
	4C3T4	1/4 - 19				1/4 - 19
6C3T4	3/8 - 19	3/8 - 19	1.18	1.14	0.75	5.0
8C3T4	1/2 - 14	1/2 - 14	1.42	1.33	0.88	5.0
12C3T4	3/4 - 14	3/4 - 14	1.69	1.50	1.06	4.0
16C3T4	1-11	1-11	1.97	1.74	1.31	3.0

## F3P4

Male Connector  
60° Cone / BSPT

Mates with GU, G1 and G2 Style hose fittings

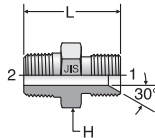

TUBE FITTING PART #	END SIZE		H HEX (in.)	L (in.)	Dynamic Pressure (x 1,000 PSI)
	1 BSPP	2 BSPT			S
	4F3P4	1/4 - 19			1/4 - 19
6F3P4	3/8 - 19	3/8 - 19	0.88	1.50	5.0
8F3P4	1/2 - 14	1/2 - 14	1.06	1.81	5.0
12F3P4	3/4 - 14	3/4 - 14	1.44	2.05	4.0
16F3P4	1-11	1-11	1.63	2.28	3.0

**WARNING:** This product can expose you to chemicals including Lead and Lead Compounds which is known to the State of California to cause cancer and birth defects or other reproductive harm. For more information go to [www.p65warnings.ca.gov](http://www.p65warnings.ca.gov).

## HP4

Union  
60° Cone

Mates with GU, G1 and G2 Style hose fittings

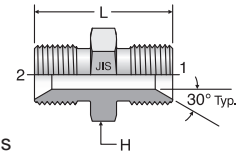

TUBE FITTING PART #	END SIZE		H HEX (in.)	L (in.)	Dynamic Pressure (x 1,000 PSI)
	1 & 2 BSPP				S
	4HP4	1/4 - 19			0.75
6HP4	3/8 - 19		0.88	1.50	5.0
8HP4	1/2 - 14		1.06	1.81	5.0
12HP4	3/4 - 14		1.44	2.05	4.0
16HP4	1-11		1.63	2.28	3.0

**WARNING:** This product can expose you to chemicals including Lead and Lead Compounds which is known to the State of California to cause cancer and birth defects or other reproductive harm. For more information go to [www.p65warnings.ca.gov](http://www.p65warnings.ca.gov).

TABLE OF CONTENTS

VISUAL INDEX

FAQs

GEN TECH

Dimensions and pressures for reference only, subject to change.

Click here for CADs, Support Resources or to Configure Parts Online

## G3P4

Female Connector  
60° Cone / BSPT

Mates with GU, G1 and G2 Style hose fittings

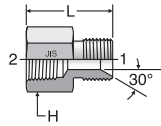

TUBE FITTING PART #	END SIZE		H HEX (in.)	L (in.)	Dynamic Pressure (x 1,000 PSI)
	1 BSPP	2 BSPT			S
					4G3P4
6G3P4	3/8 - 19	3/8 - 19	0.88	1.34	5.0
8G3P4	1/2 - 14	1/2 - 14	1.06	1.58	5.0
12G3P4	3/4 - 14	3/4 - 14	1.44	1.73	4.0
16G3P4	1-11	1-11	1.63	1.93	3.0

**WARNING:** This product can expose you to chemicals including Lead and Lead Compounds which is known to the State of California to cause cancer and birth defects or other reproductive harm. For more information go to [www.p65warnings.ca.gov](http://www.p65warnings.ca.gov).

## PNMP4

Plug  
60° Cone

Mates with GU, G1 and G2 Style hose fittings

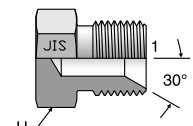

TUBE FITTING PART #	END SIZE		H HEX (mm)	Dynamic Pressure (x 1,000 PSI)
	1 BSPP	S		
				4PNMP4
6PNMP4	3/8 - 19	19	5.0	
8PNMP4	1/2 - 14	22	5.0	
12PNMP4	3/4 - 14	30	4.0	
16PNMP4	1-11	36	3.0	

**WARNING:** This product can expose you to chemicals including Lead and Lead Compounds which is known to the State of California to cause cancer and birth defects or other reproductive harm. For more information go to [www.p65warnings.ca.gov](http://www.p65warnings.ca.gov).

## F63P4

Swivel Male Connector  
60° Swivel / BSPT

Mates with UT Style hose fittings

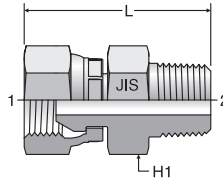

TUBE FITTING PART #	END SIZE		H1 HEX (in.)	L (in.)	Dynamic Pressure (x 1,000 PSI)
	1 BSPP	2 BSPT			S
					4F63P4
6F63P4	3/8 - 19	3/8 - 19	0.88	1.94	5.0
8F63P4	1/2 - 14	1/2 - 14	1.06	2.25	5.0
12F63P4	3/4 - 14	3/4 - 14	1.44	2.55	4.0
16F63P4	1-11	1-11	1.63	2.77	3.0

**WARNING:** This product can expose you to chemicals including Lead and Lead Compounds which is known to the State of California to cause cancer and birth defects or other reproductive harm. For more information go to [www.p65warnings.ca.gov](http://www.p65warnings.ca.gov).

## G63P4

Swivel Female Connector  
60° Swivel / BSPT

Mates with UT Style hose fittings

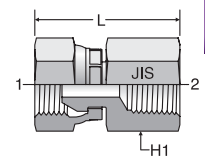

TUBE FITTING PART #	END SIZE		H1 HEX (in.)	L (in.)	Dynamic Pressure (x 1,000 PSI)
	1 BSPP	2 BSPT			S
					4G63P4
6G63P4	3/8 - 19	3/8 - 19	0.88	1.78	5.0
8G63P4	1/2 - 14	1/2 - 14	1.06	2.02	5.0
12G63P4	3/4 - 14	3/4 - 14	1.44	2.20	4.0
16G63P4	1-11	1-11	1.63	2.52	3.0

**WARNING:** This product can expose you to chemicals including Lead and Lead Compounds which is known to the State of California to cause cancer and birth defects or other reproductive harm. For more information go to [www.p65warnings.ca.gov](http://www.p65warnings.ca.gov).

TABLE OF CONTENTS

VISUAL INDEX

FAQs

G

GEN TECH

Dimensions and pressures for reference only, subject to change.



Click here for CADs, Support Resources or to Configure Parts Online

## HP46

Swivel Union Connector  
60° Swivel

Mates with UT Style hose fittings

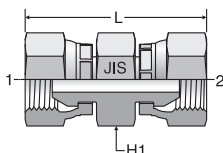

TUBE FITTING PART #	END SIZE		H1 HEX (in.)	L (in.)	Dynamic Pressure (x 1,000 PSI)	
	1 & 2 BSPP				S	
4HP46	1/4 - 19		0.75	2.12	5.0	
6HP46	3/8 - 19		0.88	2.37	5.0	
8HP46	1/2 - 14		1.06	2.73	5.0	
12HP46	3/4 - 14		1.44	2.96	4.0	
16HP46	1-11		1.63	3.24	3.0	

**WARNING:** This product can expose you to chemicals including Lead and Lead Compounds which is known to the State of California to cause cancer and birth defects or other reproductive harm. For more information go to [www.p65warnings.ca.gov](http://www.p65warnings.ca.gov).

## FNMP4

Cap  
60° Cone

Mates with UT Style hose fittings

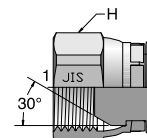

TUBE FITTING PART #	END SIZE		H HEX (in.)	Dynamic Pressure (x 1,000 PSI)	
	1 BSPP			S	
4FNMP4	1/4 - 19		0.75	5.0	
6FNMP4	3/8 - 19		0.88	5.0	
8FNMP4	1/2 - 14		1.06	5.0	
12FNMP4	3/4 - 14		1.44	4.0	
16FNMP4	1-11		1.63	3.0	

**WARNING:** This product can expose you to chemicals including Lead and Lead Compounds which is known to the State of California to cause cancer and birth defects or other reproductive harm. For more information go to [www.p65warnings.ca.gov](http://www.p65warnings.ca.gov).

## C3P4

90° Male Elbow  
60° Cone / BSPT

Mates with GU, G1 and G2 Style hose fittings

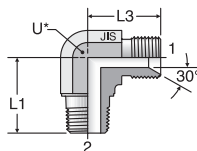

\* Across wrench flats

TUBE FITTING PART #	END SIZE		L1 (in.)	L3 (in.)	U (in.)	Dynamic Pressure (x 1,000 PSI)	
	1 BSPP	2 BSPT				S	
4C3P4	1/4 - 19	1/4 - 19	1.00	0.96	0.56	5.0	
6C3P4	3/8 - 19	3/8 - 19	1.18	1.14	0.75	5.0	
8C3P4	1/2 - 14	1/2 - 14	1.42	1.28	0.88	5.0	
12C3P4	3/4 - 14	3/4 - 14	1.69	1.56	1.06	4.0	
16C3P4	1-11	1-11	1.97	1.74	1.31	3.0	

## V3P4

45° Male Elbow  
60° Cone / BSPT

Mates with GU, G1 and G2 Style hose fittings

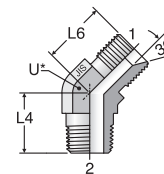

TUBE FITTING PART #	END SIZE		L4 (in.)	L6 (in.)	U (in.)	Dynamic Pressure (x 1,000 PSI)	
	1 BSPP	2 BSPT				S	
4V3P4	1/4 - 19	1/4 - 19	0.75	0.81	0.56	5.0	
6V3P4	3/8 - 19	3/8 - 19	0.87	0.91	0.75	5.0	
8V3P4	1/2 - 14	1/2 - 14	1.06	1.05	0.88	5.0	
12V3P4	3/4 - 14	3/4 - 14	1.18	1.18	1.06	4.0	
16V3P4	1-11	1-11	1.37	1.30	1.31	3.0	

## P47OMN

Plug

Hex head plug for JIS B2351

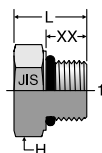

TUBE FITTING PART #	END SIZE		H HEX (mm)	L (mm)	XX (mm)	Dynamic Pressure (x 1,000 PSI)	
	1 BSPP					S	
4P47OMN	1/4 - 19		19	19.1	11.2	5.0	
6P47OMN	3/8 - 19		22	20.0	11.2	5.0	
8P47OMN	1/2 - 14		27	24.1	14.5	5.0	
12P47OMN	3/4 - 14		36	26.9	14.5	4.0	
16P47OMN	1-11		41	31.0	18.5	3.0	

**WARNING:** This product can expose you to chemicals including Lead and Lead Compounds which is known to the State of California to cause cancer and birth defects or other reproductive harm. For more information go to [www.p65warnings.ca.gov](http://www.p65warnings.ca.gov).

Dimensions and pressures for reference only, subject to change

TABLE OF CONTENTS

VISUAL INDEX

FAQs











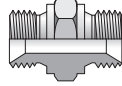
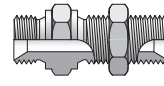

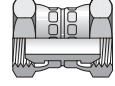
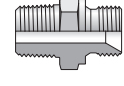
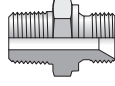
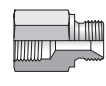
GEN TECH

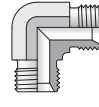
# H

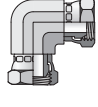
## K4 BSP ADAPTERS

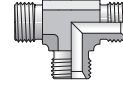
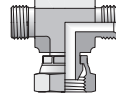
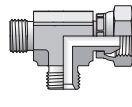



TABLE  
OF  
CONTENTS

 <p><b>Straights</b></p>	<p><b>HMK4</b> Union</p>  <p>H6</p>	<p><b>WMK4WL4NM</b> Bulkhead Union</p>  <p>H6</p>	<p><b>F6MK4</b> 60° Swivel / 60° Cone</p>  <p>H7</p>	<p><b>H6MK4</b> Swivel Union</p>  <p>H7</p>	<p><b>FMK4</b> 60° Cone / NPTF</p>  <p>H7</p>	
	<p><b>F3MK4</b> 60° Cone / BSPT</p>  <p>H7</p>	<p><b>G4MK4</b> 60° Cone / BSPP</p>  <p>H8</p>	<p><b>K4HF80</b> 60° Cone / BSPP</p>  <p>H8</p>	 <p><b>Elbows</b></p>	<p><b>EMK4</b> Union Elbow</p>  <p>H9</p>	<p><b>C6MK4</b> 60° Swivel / 60° Cone</p>  <p>H9</p>
	<p><b>E6MK4</b> Swivel Union</p>  <p>H9</p>	 <p><b>Tees</b></p>	<p><b>JMK4</b> Union Tee</p>  <p>H9</p>		<p><b>S6MK4</b> 60° Swivel Branch Tee</p>  <p>H10</p>	<p><b>R6MK4</b> 60° Swivel Run Tee</p>  <p>H10</p>
	 <p><b>Plug and Cap</b></p>		<p><b>PNMK4</b> Hex Head Plug</p>  <p>H8</p>	<p><b>FNMK4</b> Cap</p>  <p>H8</p>		

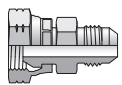
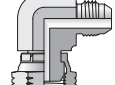
**Conversion Adapters (Shown in Section J)**

 <p><b>K4 BSP Conversion Adapters</b></p>	<p><b>XHMK46</b> 37° Flare / BSPP Swivel</p>  <p>J5</p>	<p><b>XEMK46</b> 37° Flare / BSPP Swivel</p>  <p>J6</p>
--	--	--

**O-Rings and Seals (Shown in Section M)**

 <p><b>K4 BSP O-Rings and Seals</b></p>	<p><b>D9DT</b> BSPP Bonded Seal</p>  <p>M7</p>
--	---

Dimensions and pressures for reference only, subject to change.

## K4 BSP Adapters

Parker K4 (BSP) and K46 (swivel) adapters are typically used as hose adapters on equipment designed and/or manufactured throughout Europe, especially equipment with ties to the UK, Scandinavia, the Netherlands, Spain and Italy. BSP cone adapters are similar in function to NPSM pipe swivel fittings (also called O7 Adapters) but with BSPP threads.

The metal-to-metal sealing is achieved by a single line of contact between the conical surface of the 60° cone seat and the corresponding surface of the ballnose or cone swivel, as shown in Fig. H1.

K4 adapters are manufactured in accordance with BS5200 standards. The 60° internal seat is designed for sealing with BSP hose swivel connections offered by many manufacturers. K4 adapters mate with the Parker hose fitting series shown in Table H1.

Further enhancing the flexibility of the K4 adapter product line is the ability for the male BSP cone end of the straight fittings to also be used as a port adapter in ISO 1179-1 / DIN 3852 ports. This is accomplished with the addition of a bonded seal (often referred to as a Dowty® seal). This product feature is illustrated in Fig. H2.

## Design and Construction

**Construction:** Shaped K4 adapters are manufactured from a hot forged construction. Straight adapters are manufactured from cold drawn barstock.

**Threads:** The standard K4 products are manufactured with the thread forms listed below:

- BSPP Threads: ISO 228-1 G
- BSPT Threads: ISO 7/1, JIS B 0203
- NPTF Threads: SAE J476, ANSI B1.20.3, FED-STD-H28/8

## Reference Locations

**Dynamic Pressure Ratings:** Please refer to the last column of the part number tables located on the following pages of this section for appropriate dynamic pressure ratings.

**Standard Material Specifications:** Please refer to Table S34 located in the General Technical section.

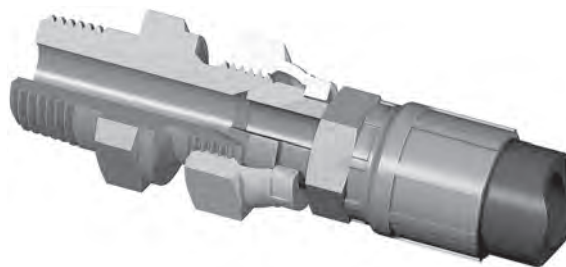

Fig. H1 – K4 Interface

Adapter Connection End	Mating Parker Hose Fitting Series
K4 / K46	D9/92, B1, B2, B4

Table H1 – Parker K4 Fittings Hose Adaptability

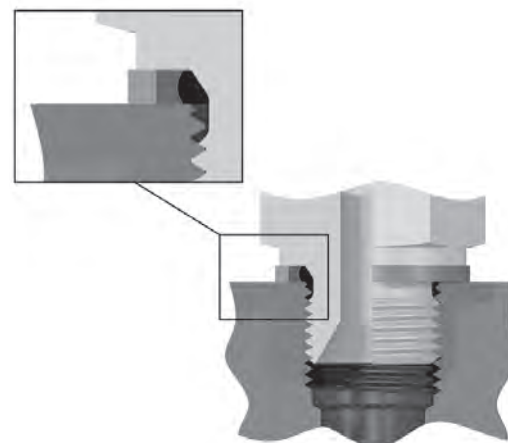

Fig. H2 – K4 End Used as a BSPP Port Adapter (in ISO 1179/ DIN 3852, Part 2 Port)

TABLE OF CONTENTS

VISUAL INDEX

H

Dimensions and pressures for reference only, subject to change.

## 60° Cone Adapters: JIS vs. K4

K4 Adapters, while very similar to JIS P4 cones (shown in previous section), are not interchangeable.

Parker's P4 JIS 60° cone adapters are manufactured in accordance to JIS B8363 while Parker's K4 BSP adapters are manufactured in accordance to BS5200. The following are some pronounced differences that may help in distinguishing between the K4 and P4 fittings:

1. Thread length ("A" dimensions)
2. 60° angle diameter ("B" dimensions)
3. The undercut area (area between threads and hex body) on the straight K4 fittings incorporates a bonded seal "locating pilot" for bonded seal
4. Parker's JIS fittings are stamped with "JIS" on the forging body or hex of fitting

See Figs. H3 and H4 for details and see Tables H2 and H3 below for specific dimensional differences.

Size	BSPP Thread	M	A	B
2	1/8-28	0.38	0.418	0.276
4	1/4-19	0.51	0.570	0.394
6	3/8-19	0.65	0.609	0.531
8	1/2-14	0.82	0.726	0.650
12	3/4-14	1.04	0.805	0.866
16	1-11	1.30	0.883	1.102
20	1 1/4-11	1.64	0.945	1.417
24	1 1/2-11	1.87	0.962	1.654
32	2-11	2.34	1.102	2.126

Table H2 – Dimensions of JIS B8363 60° Cone Connection (JIS P4)

Size	BSPP Thread	M	A	B
2	1/8-28	0.38	0.315	0.295
4	1/4-19	0.51	0.433	0.409
6	3/8-19	0.65	0.472	0.551
8	1/2-14	0.82	0.551	0.689
10	5/8-14	0.90	0.630	0.760
12	3/4-14	1.04	0.630	0.902
16	1-11	1.30	0.748	1.130
20	1 1/4-11	1.64	0.787	1.449
24	1 1/2-11	1.87	0.866	1.681
32	2-11	2.34	0.984	2.150

Table H3 – Dimensions of BS B5200 60° Cone Connection (K4)

While the 60° cone versions of JIS and K4 fittings utilize the same BSPP threads and seat angle, not all dimensions are consistent. Therefore, they cannot be interchanged because the differences can cause leakage problems. An example of this is illustrated in Fig. H5, where a gap exists between sealing surfaces. The combination of matching proper components will create an effective seal as illustrated in Fig H6.

For more information, see "BSPP 60° Cone Fittings: Looks can be deceiving" article at [TFDTechConnect.com](http://TFDTechConnect.com).

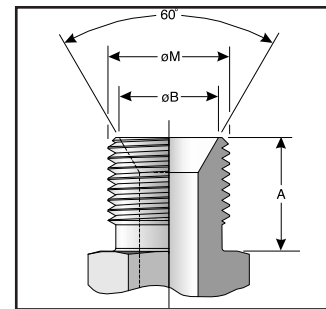

Fig. H3 – JIS B8363 60° Cone Connection (P4)

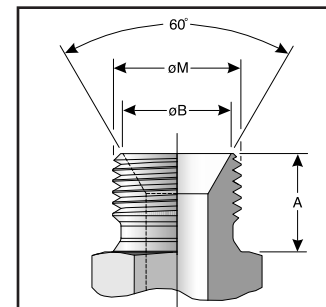

Fig. H4 – BS B5200 60° Cone Connection (K4)

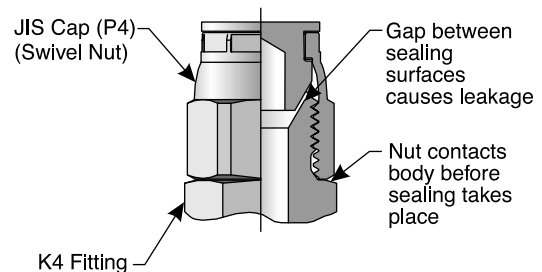

Fig. H5 – Illustration Showing Potential Leakage Problem When Mixing JIS and K4 Components

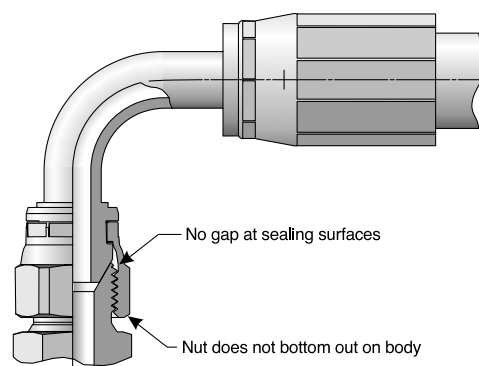

Fig. H6 – An Effective Seal Created with the Proper Combination of Components

TABLE  
OF  
CONTENTS

VISUAL  
INDEX



## K4 BSP Ends

TABLE  
OF  
CONTENTS

VISUAL  
INDEX

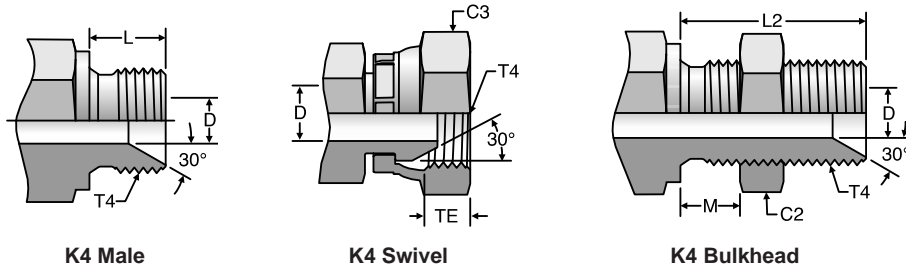

K4 Male

K4 Swivel

K4 Bulkhead

	BSPB Thread	Bulkhead Nut Hex	Swivel Hex	Drill	Male Turn Back	Bulkhead Length	Max Bulkhead Thickness	Assembly Allowance
Dash Size	T4 BSPP	C2 (mm)	C3 (mm)	D (mm)	L (mm)	L2 (mm)	M (mm)	TE (mm)
2	1/8-28	—	14	3.5	8	—	—	—
4	1/4-19	19	19	4.7	11	28	9.5	7.3
6	3/8-19	22	22	7.9	12	32	12.5	8.4
8	1/2-14	27	27	11.1	14	35	12.3	9.3
10	5/8-14	30	30	14.3	16	35	10.7	—
12	3/4-14	36	32	16.7	16	38	13.3	11.3
16	1-11	41	41	22.2	19	41	10.0	13.6
20	1 1/4-11	50	50	28.6	20	44	12.0	—
24	1 1/2-11	55	60	33.3	22	48	14.0	—
32	2-11	—	—	46.0	25	—	—	—

H

Dimensions and pressures for reference only, subject to change.

# HMK4

Union  
60° Cone / 60° Cone

Mates with 92, B1, B2 and B4 style hose fitting

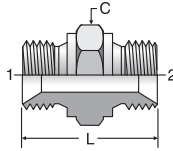

# WMK4WL4NM

Bulkhead Union  
60° Cone / 60° Cone

Mates with 92, B1, B2 and B4 style hose fitting

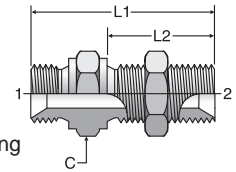

TUBE FITTING PART #	END SIZE		C HEX (mm)	L (mm)	Dynamic Pressure (x 1,000 PSI)
	1 BSPP	2 BSPP			S
					2HMK4
4-2HMK4	1/4 - 19	1/8 - 28	19	28.0	5.1
4HMK4	1/4 - 19	1/4 - 19	19	31.5	5.1
6-4HMK4	3/8 - 19	1/4 - 19	22	33.2	5.1
6HMK4	3/8 - 19	3/8 - 19	22	34.7	5.1
8-4HMK4	1/2 - 14	1/4 - 19	27	36.7	2.9
8-6HMK4	1/2 - 14	3/8 - 19	27	38.2	2.9
8HMK4	1/2 - 14	1/2 - 14	27	40.7	2.9
10-8HMK4	5/8 - 14	1/2 - 14	30	43.2	2.9
10HMK4	5/8 - 14	5/8 - 14	30	45.2	2.9
12-4HMK4	3/4 - 14	1/4 - 19	32	39.2	2.9
12-6HMK4	3/4 - 14	3/8 - 19	32	40.7	2.9
12-8HMK4	3/4 - 14	1/2 - 14	32	43.2	2.9
12-10HMK4	3/4 - 14	5/8 - 14	32	45.2	2.9
12HMK4	3/4 - 14	3/4 - 14	32	45.2	2.9
16-8HMK4	1 - 11	1/2 - 14	41	46.9	1.7
16-10HMK4	1 - 11	5/8 - 14	41	48.9	1.7
16-12HMK4	1 - 11	3/4 - 14	41	48.9	1.7
16HMK4	1 - 11	1 - 11	41	51.9	1.7
20-12HMK4	1 1/4 - 11	3/4 - 14	50	57.4	1.5
20-16HMK4	1 1/4 - 11	1 - 11	50	60.4	1.5
20HMK4	1 1/4 - 11	1 1/4 - 11	50	61.4	1.5
24-16HMK4	1 1/2 - 11	1 - 11	55	64.4	1.5
24-20HMK4	1 1/2 - 11	1 1/4 - 11	55	65.4	1.5
24HMK4	1 1/2 - 11	1 1/2 - 11	55	67.4	1.5
32-24HMK4	2 - 11	1 1/2 - 11	70	72.9	1.0
32HMK4	2 - 11	2 - 11	70	76.4	1.0

TUBE FITTING PART #	END SIZE		C HEX (mm)	L1 (mm)	L2 (mm)	Dynamic Pressure (x 1,000 PSI)
	1 & 2 BSPP	S				
		4WMK4WL4NM				1/4 - 19
6WMK4WL4NM	3/8 - 19	22	55	32	5.1	
8WMK4WL4NM	1/2 - 14	27	62	35	2.9	
10WMK4WL4NM	5/8 - 14	30	64	35	2.9	
12WMK4WL4NM	3/4 - 14	32	67	38	2.9	
16WMK4WL4NM	1 - 11	41	74	41	1.7	
20WMK4WL4NM	1 1/4 - 11	50	85	44	1.5	
24WMK4WL4NM	1 1/2 - 11	55	93	48	1.5	

Includes Bulkhead nut.

**WARNING:** This product can expose you to chemicals including Lead and Lead Compounds which is known to the State of California to cause cancer and birth defects or other reproductive harm. For more information go to [www.p65warnings.ca.gov](http://www.p65warnings.ca.gov).

**WARNING:** This product can expose you to chemicals including Lead and Lead Compounds which is known to the State of California to cause cancer and birth defects or other reproductive harm. For more information go to [www.p65warnings.ca.gov](http://www.p65warnings.ca.gov).

TABLE OF CONTENTS

VISUAL INDEX

FAQs

Dimensions and pressures for reference only, subject to change.

## F6MK4

Swivel Nut Connector  
60° Swivel / 60° Cone

Mates with D9/92, B1, B2 and B4 style hose fitting

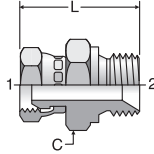

TUBE FITTING PART #	END SIZE		C HEX (mm)	L (mm)	Dynamic Pressure (x 1,000 PSI)
	1 BSPP	2 BSPP			S
4-4F6MK4	1/4 - 19	1/4 - 19	19	36.6	5.1
4-6F6MK4	1/4 - 19	3/8 - 19	22	38.5	5.1
4-8F6MK4	1/4 - 19	1/2 - 14	27	42.0	2.9
6-4F6MK4	3/8 - 19	1/4 - 19	22	38.3	5.1
6-6F6MK4	3/8 - 19	3/8 - 19	22	40.0	5.1
6-8F6MK4	3/8 - 19	1/2 - 14	27	43.6	2.9
8-6F6MK4	1/2 - 14	3/8 - 19	27	43.5	2.9
8-8F6MK4	1/2 - 14	1/2 - 14	27	46.1	2.9
8-12F6MK4	1/2 - 14	3/4 - 14	32	48.0	2.9
12-8F6MK4	3/4 - 14	1/2 - 14	32	48.6	2.9
12-12F6MK4	3/4 - 14	3/4 - 14	32	50.0	2.9
12-16F6MK4	3/4 - 14	1 - 11	41	54.3	1.7
16-16F6MK4	1 - 11	1 - 11	41	57.3	1.7

**WARNING:** This product can expose you to chemicals including Lead and Lead Compounds which is known to the State of California to cause cancer and birth defects or other reproductive harm. For more information go to [www.p65warnings.ca.gov](http://www.p65warnings.ca.gov).

## H6MK4

Swivel Nut Union  
60° Swivel / 60° Swivel

Mates with D9 style hose fitting

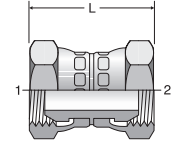

TUBE FITTING PART #	END SIZE		L (mm)	Dynamic Pressure (x 1,000 PSI)
	1 BSPP	2 BSPP		S
4H6MK4	1/4 - 19	1/4 - 19	37.0	5.1
6-4H6MK4	3/8 - 19	1/4 - 19	38.6	5.1
6H6MK4	3/8 - 19	3/8 - 19	40.5	5.1
8-4H6MK4	1/2 - 14	1/4 - 19	41.5	2.9
8-6H6MK4	1/2 - 14	3/8 - 19	42.9	2.9
8H6MK4	1/2 - 14	1/2 - 14	45.8	2.9
10H6MK4	5/8 - 14	5/8 - 14	47.5	2.9
12-8H6MK4	3/4 - 14	1/2 - 14	48.2	2.9
12H6MK4	3/4 - 14	3/4 - 14	49.5	2.9
16H6MK4	1 - 11	1 - 11	57.5	1.7
20H6MK4	1 1/4 - 11	1 1/4 - 11	66.0	1.5
24H6MK4	1 1/2 - 11	1 1/2 - 11	70.0	1.5

**WARNING:** This product can expose you to chemicals including Lead and Lead Compounds which is known to the State of California to cause cancer and birth defects or other reproductive harm. For more information go to [www.p65warnings.ca.gov](http://www.p65warnings.ca.gov).

## FMK4

NPTF Male Connector  
60° Cone / NPTF

Mates with 92, B1, B2 and B4 style hose fitting

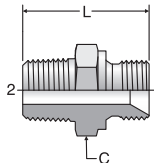

TUBE FITTING PART #	END SIZE		C HEX (mm)	L (mm)	Dynamic Pressure (x 1,000 PSI)
	1 BSPP	2 NPTF			S
2FMK4	1/8 - 28	1/8 - 27	14	24.4	5.1
2-4FMK4	1/8 - 28	1/4 - 18	19	28.9	5.1
4FMK4	1/4 - 19	1/8 - 18	19	28.9	5.1
4-4FMK4	1/4 - 19	1/4 - 18	19	33.4	5.1
4-6FMK4	1/4 - 19	3/8 - 18	19	33.6	5.1
6FMK4	3/8 - 19	1/4 - 18	22	35.1	5.1
6-6FMK4	3/8 - 19	3/8 - 18	22	35.1	5.1
6-8FMK4	3/8 - 19	1/2 - 14	22	39.9	5.1
8FMK4	1/2 - 14	3/8 - 18	27	38.6	2.9
8-8FMK4	1/2 - 14	1/2 - 14	27	43.4	2.9
8-12FMK4	1/2 - 14	3/4 - 14	27	43.9	2.9
12-8FMK4	3/4 - 14	1/2 - 14	32	45.9	2.9
12FMK4	3/4 - 14	3/4 - 14	32	45.9	2.9
12-16FMK4	3/4 - 14	1 - 11 1/2	36	50.8	2.9
16-12FMK4	1 - 11	3/4 - 14	41	49.6	1.7
16FMK4	1 - 11	1 - 11 1/2	41	54.5	1.7

**WARNING:** This product can expose you to chemicals including Lead and Lead Compounds which is known to the State of California to cause cancer and birth defects or other reproductive harm. For more information go to [www.p65warnings.ca.gov](http://www.p65warnings.ca.gov).

## F3MK4

BSPT Male Connector  
60° Cone / BSPT

Mates with 92, B1, B2 and B4 style hose fitting

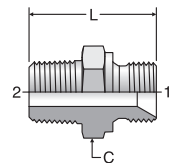

TUBE FITTING PART #	END SIZE		C HEX (mm)	L (mm)	Dynamic Pressure (x 1,000 PSI)
	1 BSPP	2 BSPT			S
2F3MK4	1/8 - 28	1/8 - 28	14	24.4	5.1
2-4F3MK4	1/8 - 28	1/4 - 19	14	28.9	5.1
4F3MK4	1/4 - 19	1/8 - 28	19	28.9	5.1
4-4F3MK4	1/4 - 19	1/4 - 19	19	33.4	5.1
4-6F3MK4	1/4 - 19	3/8 - 19	19	33.4	5.1
6F3MK4	3/8 - 19	1/4 - 19	22	35.1	5.1
6-6F3MK4	3/8 - 19	3/8 - 19	22	35.1	5.1
6-8F3MK4	3/8 - 19	1/2 - 14	22	39.9	2.9
8F3MK4	1/2 - 14	3/8 - 19	27	38.6	5.1
8-8F3MK4	1/2 - 14	1/2 - 14	22	43.4	2.9
10F3MK4	5/8 - 14	1/2 - 14	27	45.9	2.9
10-12F3MK4	5/8 - 14	3/4 - 14	30	45.9	2.9
12F3MK4	3/4 - 14	3/4 - 14	30	45.9	2.9
12-8F3MK4	3/4 - 14	1/2 - 14	32	46.0	1.7
12-16F3MK4	3/4 - 14	1 - 11	36	50.8	1.7
16F3MK4	1 - 11	1 - 11	41	54.5	1.7
16-12F3MK4	1 - 11	3/4 - 14	41	49.6	1.7
20F3MK4	1 1/4 - 11	1 1/4 - 11	50	63.7	1.5
24F3MK4	1 1/2 - 11	1 1/2 - 11	55	68.5	1.5

**WARNING:** This product can expose you to chemicals including Lead and Lead Compounds which is known to the State of California to cause cancer and birth defects or other reproductive harm. For more information go to [www.p65warnings.ca.gov](http://www.p65warnings.ca.gov).

TABLE OF CONTENTS

VISUAL INDEX

FAQs

H

Dimensions and pressures for reference only, subject to change.

## G4MK4

BSPF Female Connector  
60° Cone / BSPF

Mates with 92, B1, B2 and B4 style hose fitting

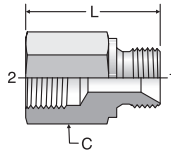

TUBE FITTING PART #	END SIZE		C HEX (mm)	L (mm)	Dynamic Pressure (x 1,000 PSI) S
	1 BSPP	2 BSPP			
6G4MK4	3/8 - 19	1/4 - 19	22	37.1	5.1
6-6G4MK4	3/8 - 19	3/8 - 19	23	36.9	2.9
8-4G4MK4	1/2 - 14	1/4 - 19	27	38.0	2.9
8G4MK4	1/2 - 14	3/8 - 19	30	45.3	2.9
12-4G4MK4	3/4 - 14	1/4 - 19	32	40.0	2.9
12-6G4MK4	3/4 - 14	3/8 - 19	32	41.6	2.9
12-8G4MK4	3/4 - 14	1/2 - 14	32	47.3	2.9
16-4G4MK4	1 - 11	1/4 - 19	41	43.0	1.7
16-6G4MK4	1 - 11	3/8 - 19	41	44.6	1.7
16-8G4MK4	1 - 11	1/2 - 14	41	50.3	1.7
16-12G4MK4	1 - 11	3/4 - 14	41	52.2	1.7

**WARNING:** This product can expose you to chemicals including Lead and Lead Compounds which is known to the State of California to cause cancer and birth defects or other reproductive harm. For more information go to [www.p65warnings.ca.gov](http://www.p65warnings.ca.gov).

## PNMK4

Hex Plug  
60° Cone

Mates with 92, B1, B2 and B4 style hose fitting

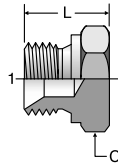

TUBE FITTING PART #	END SIZE	C HEX (mm)	L (mm)	Dynamic Pressure (x 1,000 PSI) S
	1 BSPP			
2PNMK4	1/8 - 28	14	14.3	5.1
4PNMK4	1/4 - 19	19	18.8	5.1
6PNMK4	3/8 - 19	22	20.5	5.1
8PNMK4	1/2 - 14	27	24.0	2.9
10PNMK4	5/8 - 14	30	24.0	2.9
12PNMK4	3/4 - 14	32	26.5	2.9
16PNMK4	1 - 11	41	30.2	1.7
20PNMK4	1 1/4 - 11	50	38.7	1.5
24PNMK4	1 1/2 - 11	55	42.7	1.5
32PNMK4	2 - 11	70	48.2	1.0

**WARNING:** This product can expose you to chemicals including Lead and Lead Compounds which is known to the State of California to cause cancer and birth defects or other reproductive harm. For more information go to [www.p65warnings.ca.gov](http://www.p65warnings.ca.gov).

## K4HF80

Metric Male Connector  
BSP 60° Cone / Metric-ORR  
(for ISO 9974 / DIN 3852-1 Port)

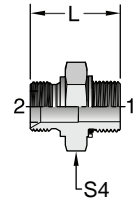

TUBE FITTING PART #	End Size		S4 Hex (mm)	L (mm)	Dynamic Pressure (x 1,000 PSI) S
	1 BSPP	2 Metric Str			
2M10K4HF80	1/8-28	M10X1	17	25.7	5.1
4M12K4HF80	1/4-19	M12X1.5	19	30.1	5.1
4M14K4HF80	1/4-19	M14X1.5	19	30.1	5.1
6M16K4HF80	3/8-19	M16X1.5	22	32.6	5.1
8M16K4HF80	1/2-14	M16X1.5	27	34.6	2.9
6M18K4HF80	3/8-19	M18X1.5	27	34.1	2.9
8M18K4HF80	1/2-14	M18X1.5	27	33.1	2.9
8M22K4HF80	1/2-14	M22X1.5	32	40.4	2.9
12M27K4HF80	3/4-14	M27X2	41	47.9	2.9
16M33K4HF80	1-11	M33X2	41	56.7	1.7

**WARNING:** This product can expose you to chemicals including Lead and Lead Compounds which is known to the State of California to cause cancer and birth defects or other reproductive harm. For more information go to [www.p65warnings.ca.gov](http://www.p65warnings.ca.gov).

## FNMK4

Cap  
60° Cone

Mates with D9 style hose fitting

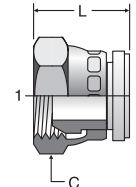

TUBE FITTING PART #	END SIZE	C HEX (mm)	L (mm)	Dynamic Pressure (x 1,000 PSI) S
	1 BSPP			
2FNMK4	1/8 - 28	14	16.0	5.1
4FNMK4	1/4 - 19	19	20.6	5.1
6FNMK4	3/8 - 19	22	22.3	5.1
8FNMK4	1/2 - 14	27	22.7	2.9
10FNMK4	5/8 - 14	30	26.6	2.9
12FNMK4	3/4 - 14	32	28.0	2.9
16FNMK4	1 - 11	41	31.6	1.7
20FNMK4	1 1/4 - 11	50	35.9	1.5
24FNMK4	1 1/2 - 11	60	37.9	1.5

**WARNING:** This product can expose you to chemicals including Lead and Lead Compounds which is known to the State of California to cause cancer and birth defects or other reproductive harm. For more information go to [www.p65warnings.ca.gov](http://www.p65warnings.ca.gov).

TABLE OF CONTENTS

VISUAL INDEX

FAQs

Dimensions and pressures for reference only, subject to change

## EMK4

Union Elbow  
60° Cone / 60° Cone

Mates with D9/92, B1, B2 and B4 style hose fitting

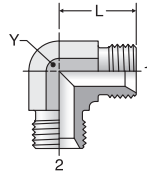

TUBE FITTING PART #	END SIZE		L (mm)	Y (mm)	Dynamic Pressure (x 1,000 PSI)
	1 BSPP	2 BSPP			S
	2EMK4	1/8 - 28			1/8 - 28
4EMK4	1/4 - 19	1/4 - 19	24	14	5.1
6EMK4	3/8 - 19	3/8 - 19	27	19	5.1
8EMK4	1/2 - 14	1/2 - 14	32	22	2.9
10EMK4	5/8 - 14	5/8 - 14	34	22	2.9
12EMK4	3/4 - 14	3/4 - 14	36	27	2.9
16EMK4	1 - 11	1 - 11	42	33	1.7
20EMK4	1 1/4 - 11	1 1/4 - 11	48	41	1.5
24EMK4	1 1/2 - 11	1 1/2 - 11	54	48	1.5

## C6MK4

Swivel Nut Elbow  
60° Cone / 60° Swivel

Mates with D9/92, B1, B2 and B4 style hose fitting

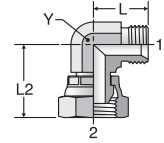

TUBE FITTING PART #	END SIZE		L (mm)	L2 (mm)	Y (mm)	Dynamic Pressure (x 1,000 PSI)
	1 BSPP	2 BSPP				S
	2C6MK4	1/8 - 28				1/8 - 28
4C6MK4	1/4 - 19	1/4 - 19	24	25	19	5.1
6C6MK4	3/8 - 19	3/8 - 19	27	26	22	5.1
8C6MK4	1/2 - 14	1/2 - 14	32	32	27	2.9
10C6MK4	5/8 - 14	5/8 - 14	34	30	27	2.9
12C6MK4	3/4 - 14	3/4 - 14	36	33	33	2.9
16C6MK4	1 - 11	1 - 11	42	38	41	1.7
20C6MK4	1 1/4 - 11	1 1/4 - 11	48	48	48	1.5
24C6MK4	1 1/2 - 11	1 1/2 - 11	54	50	48	1.5

TABLE OF CONTENTS

VISUAL INDEX

FAQs

H

## E6MK4

Swivel Nut Union Elbow  
60° Swivel / 60° Swivel

Mates with D9 style hose fitting

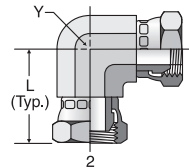

TUBE FITTING PART #	END SIZE		L (mm)	Y (mm)	Dynamic Pressure (x 1,000 PSI)
	1 BSPP	2 BSPP			S
	4E6MK4	1/4 - 19			1/4 - 19
6E6MK4	3/8 - 19	3/8 - 19	33.0	19	5.1
8E6MK4	1/2 - 14	1/2 - 14	38.8	22	2.9
10E6MK4	5/8 - 14	5/8 - 14	39.4	22	2.9
12E6MK4	3/4 - 14	3/4 - 14	42.3	27	2.9
16E6MK4	1 - 11	1 - 11	49.0	33	1.7
20E6MK4	1 1/4 - 11	1 1/4 - 11	58.2	41	1.5
24E6MK4	1 1/2 - 11	1 1/2 - 11	63.3	48	1.5

## JMK4

Union Tee  
60° Cone (all three ends)

Mates with 92, B1, B2 and B4 style hose fitting

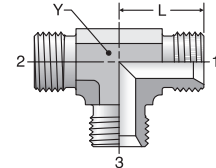

TUBE FITTING PART #	END SIZE			L (mm)	Y (mm)	Dynamic Pressure (x 1,000 PSI)
	1 BSPP	2 BSPP	3 BSPP			S
	2JMK4	1/8 - 28	1/8 - 28			1/8 - 28
4JMK4	1/4 - 19	1/4 - 19	1/4 - 19	24	19	5.1
6JMK4	3/8 - 19	3/8 - 19	3/8 - 19	27	22	5.1
8JMK4	1/2 - 14	1/2 - 14	1/2 - 14	32	27	2.9
10JMK4	5/8 - 14	5/8 - 14	5/8 - 14	34	27	2.9
12JMK4	3/4 - 14	3/4 - 14	3/4 - 14	36	33	2.9
16JMK4	1 - 11	1 - 11	1 - 11	42	41	1.7
20JMK4	1 1/4 - 11	1 1/4 - 11	1 1/4 - 11	48	48	1.5
24JMK4	1 1/2 - 11	1 1/2 - 11	1 1/2 - 11	54	48	1.5

Dimensions and pressures for reference only, subject to change.



## S6MK4

Swivel Nut Branch Tee  
60° Cone / 60° Cone / 60° Swivel

Mates with D9/92, B1, B2 and B4 style hose fitting

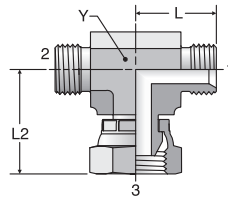

## R6MK4

Swivel Nut Run Tee  
60° Swivel / 60° Cone / 60° Cone

Mates with D9/92, B1, B2 and B4 style hose fitting

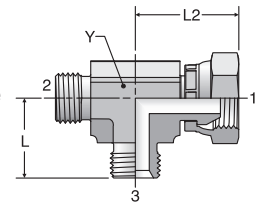

TUBE FITTING PART #	END SIZE			L (mm)	L2 (mm)	Y (mm)	Dynamic Pressure (x 1,000 PSI) S
	1 BSPP	2 BSPP	3 BSPP				
2S6MK4	1/8 - 28	1/8 - 28	1/8 - 28	17	22.0	11	5.1
4S6MK4	1/4 - 19	1/4 - 19	1/4 - 19	24	31.2	19	5.1
6S6MK4	3/8 - 19	3/8 - 19	3/8 - 19	27	36.2	27	5.1
8S6MK4	1/2 - 14	1/2 - 14	1/2 - 14	32	41.0	27	2.9
10S6MK4	5/8 - 14	5/8 - 14	5/8 - 14	34	41.6	27	2.9
12S6MK4	3/4 - 14	3/4 - 14	3/4 - 14	36	45.3	33	2.9
16S6MK4	1 - 11	1 - 11	1 - 11	42	53.9	41	1.8
20S6MK4	1 1/4 - 11	1 1/4 - 11	1 1/4 - 11	48	60.0	48	1.5

TUBE FITTING PART #	END SIZE			L (mm)	L2 (mm)	Y (mm)	Dynamic Pressure (x 1,000 PSI) S
	1 BSPP	2 BSPP	3 BSPP				
2R6MK4	1/8 - 28	1/8 - 28	1/8 - 28	17	22.0	11	5.1
4R6MK4	1/4 - 19	1/4 - 19	1/4 - 19	24	31.2	19	5.1
6R6MK4	3/8 - 19	3/8 - 19	3/8 - 19	27	36.2	27	5.1
8R6MK4	1/2 - 14	1/2 - 14	1/2 - 14	32	41.0	27	2.9
10R6MK4	5/8 - 14	5/8 - 14	5/8 - 14	34	41.6	27	2.9
12R6MK4	3/4 - 14	3/4 - 14	3/4 - 14	36	45.3	33	2.9
16R6MK4	1 - 11	1 - 11	1 - 11	42	53.9	41	1.8
20R6MK4	1 1/4 - 11	1 1/4 - 11	1 1/4 - 11	48	60.0	48	1.5

## J6MK4

Swivel Nut Union Tee  
60° Swivel (all three ends)

Mates with D9 style hose fitting

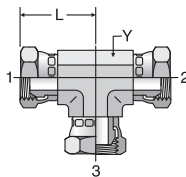

TUBE FITTING PART #	END SIZE			L (TYP.) (mm)	Y (mm)	Dynamic Pressure (x 1,000 PSI) S
	1 BSPP	2 BSPP	3 BSPP			
4J6MK4	1/4 - 19	1/4 - 19	1/4 - 19	30.5	14	5.1
6J6MK4	3/8 - 19	3/8 - 19	3/8 - 19	33.0	19	5.1
8J6MK4	1/2 - 14	1/2 - 14	1/2 - 14	38.8	22	2.9
10J6MK4	5/8 - 14	5/8 - 14	5/8 - 14	39.4	22	2.9
12J6MK4	3/4 - 14	3/4 - 14	3/4 - 14	42.3	27	2.9
16J6MK4	1 - 11	1 - 11	1 - 11	49.0	33	1.7
20J6MK4	1 1/4 - 11	1 1/4 - 11	1 1/4 - 11	58.2	41	1.5

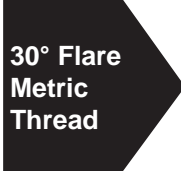

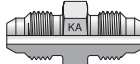

TABLE OF CONTENTS

VISUAL INDEX

FAQs

# I KOMATSU® STYLE ADAPTERS



	<b>PNMKA</b> Plug	<b>FNMKA</b> Cap	<b>HMKA</b> Union	<b>XHMKA</b> 37° Flare / 30° Flare	<b>XHMKA6</b> 37° Flare / 30° Swivel
					
	15	15	15	15	16

**TABLE  
OF  
CONTENTS**

## Komatsu Style Adapters

The 30° flare, metric thread interface, also known as the Komatsu style flare fitting, is one of the most common specialized OEM mobile equipment fittings in the marketplace. Parker offers a line of caps, plugs and conversion adapters to mate with this specialty connection. Parker's line of products is designated as "KA" adapters.

The Komatsu style connection is generally rated at 4000 psi (280 kg/cm<sup>2</sup> or 27.5 Mpa). Parker's caps, plugs and conversion adapters are rated at the full pressure rating in sizes -4 to -16, with slight pressure reductions in the less common sizes of -20 and -24.

Parker's offering of Komatsu style adapters allow for more after-market flexibility. Parker's caps and plugs enable technicians to protect critical sealing surfaces of hoses and adapters from damage and contamination. This protection is important during testing, repair and/or implement installation and removal.

Parker's line of Komatsu style conversion adapters are ideal for plumbing in hydraulic systems and field repair. Parker's exclusive swivel nut design minimizes the sealing surface damage to mating components.

## Design and Construction

Parker's line of Komatsu style fitting is sold only as a hose adapter and thus tube nuts and sleeves are not available. The adapter consists of a single body. The mating hose swivel connects directly to the 30° nose of the adapter, as shown in Fig. I1. This simple, metal-to-metal connection provides a very effective seal between the fitting nose and the hose swivel seat.

The Komatsu style adapter offers the traditional advantages of the 37° flare fitting but incorporates the following differences:

- 1) 30° nose flare
- 2) Metric threads with 1.5 mm pitch
- 3) Used only as a hose adapter
- 4) Heavy duty crimp nut for higher assembly torques



Fig. I1 – Cutaway of Komatsu Style Adapter

## Product Specifications

Komatsu style fittings are offered in eight common sizes. See Table I1 below, which shows the Komatsu nominal size and the equivalent Dash Size. The table also shows the equivalent Parker Hose Products / Parflex Division mating hose series.

Komatsu Nominal Size	Parker TFD Equivalent Dash Size	Komatsu Thread	Parker Hose Fitting Mating Series
02	-4	M14 x 1.5	MU
03	-6	M18 x 1.5	MU
04	-8	M22 x 1.5	MU
05	-10	M24 x 1.5	XU
06	-12	M30 x 1.5	XU
10	-16	M33 x 1.5	XU
12	-20	M36 x 1.5	XU
14	-24	M42 x 1.5	XU

Table I1 – Parker equivalent dash sizes and mating hose series for Komatsu Style Fittings

## Reference Locations

**Dynamic Pressure Ratings:** Please refer to the last column of the part number tables located on the following pages of this section for the appropriate dynamic pressure ratings.

**Standard Material Specifications:** Please refer to Table S34 located in the General Technical section.

TABLE OF CONTENTS

VISUAL INDEX

I

# Komatsu Ends

TABLE  
 OF  
 CONTENTS

VISUAL  
 INDEX

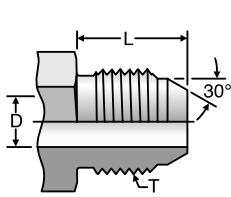

**Komatsu Male,  
 30° Flare**

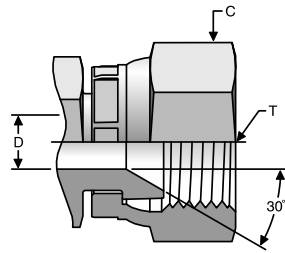

**Komatsu Swivel**

	Metric Thread	Hex	Drill	Male Turn Back
<b>Dash Size</b>	<b>T Metric</b>	<b>C (mm)</b>	<b>D (mm)</b>	<b>L (mm)</b>
<b>4</b>	M14x1.5	19	5	17.0
<b>6</b>	M18x1.5	24	8	18.0
<b>8</b>	M22x1.5	27	10	20.0
<b>10</b>	M24x1.5	32	13	33.0
<b>12</b>	M30x1.5	36	14	26.0
<b>16</b>	M33x1.5	41	19	30.0



[Click here for CADs, Support Resources or to Configure Parts Online](#)

## PNMKA

Plug  
30° Flare

Mates with XU and MU series hose fittings

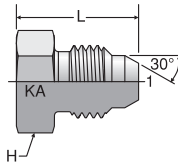

TUBE FITTING PART #	END SIZE		L (mm)	Dynamic Pressure (x 1,000 PSI)
	1 Metric Thread	H HEX (mm)		
4PNMKA	M14 X 1.5	17	23.4	4.0
6PNMKA	M18 X 1.5	22	25.1	4.0
8PNMKA	M22 X 1.5	24	28.7	4.0
10PNMKA	M24 X 1.5	27	32.0	4.0
12PNMKA	M30 X 1.5	32	36.6	4.0
16PNMKA	M33 X 1.5	38	40.6	4.0

**WARNING:** This product can expose you to chemicals including Lead and Lead Compounds which is known to the State of California to cause cancer and birth defects or other reproductive harm. For more information go to [www.p65warnings.ca.gov](http://www.p65warnings.ca.gov).

## FNMKA

Cap  
30° Flare

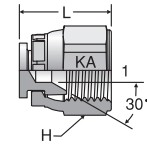

TUBE FITTING PART #	END SIZE		L (mm)	Dynamic Pressure (x 1,000 PSI)
	1 Metric Thread	H HEX (mm)		
4FNMKA	M14 X 1.5	19	21.4	4.0
6FNMKA	M18 X 1.5	24	23.1	4.0
8FNMKA	M22 X 1.5	27	27.1	4.0
10FNMKA	M24 X 1.5	32	31.8	4.0
12FNMKA	M30 X 1.5	36	35.5	4.0
16FNMKA	M33 X 1.5	41	40.9	4.0

**WARNING:** This product can expose you to chemicals including Lead and Lead Compounds which is known to the State of California to cause cancer and birth defects or other reproductive harm. For more information go to [www.p65warnings.ca.gov](http://www.p65warnings.ca.gov).

## HMKA

Male Union  
30° Flare

Mates with XU and MU series hose fittings

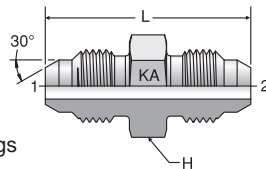

TUBE FITTING PART #	END SIZE		L (mm)	Dynamic Pressure (x 1,000 PSI)
	1&2 Metric Thread	H HEX (mm)		
4-4HMKA	M14 X 1.5	17	39.4	4.0
6-6HMKA	M18 X 1.5	22	43.4	4.0
8-8HMKA	M22 X 1.5	24	47.5	4.0
10-10HMKA	M24 X 1.5	27	52.1	4.0
12-12HMKA	M30 X 1.5	32	63.2	4.0
16-16HMKA	M33 X 1.5	38	72.1	4.0

**WARNING:** This product can expose you to chemicals including Lead and Lead Compounds which is known to the State of California to cause cancer and birth defects or other reproductive harm. For more information go to [www.p65warnings.ca.gov](http://www.p65warnings.ca.gov).

## XHMKA

37° Conversion Adapter  
30° Flare / 37° Flare

End 2 mates with XU and MU series hose fittings

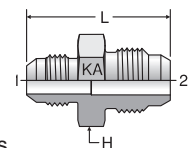

TUBE FITTING PART #	END SIZE		L (mm)	Dynamic Pressure (x 1,000 PSI)
	1 (in.)	2 Metric Thread		
4-4XHMKA	1/4	M14 X 1.5	17	37.1
6-6XHMKA	3/8	M18 X 1.5	22	39.6
8-8XHMKA	1/2	M22 X 1.5	24	44.2
10-10XHMKA	5/8	M24 X 1.5	27	49.8
12-12XHMKA	3/4	M30 X 1.5	32	59.2
16-16XHMKA	1	M33 X 1.5	38	65.3

**WARNING:** This product can expose you to chemicals including Lead and Lead Compounds which is known to the State of California to cause cancer and birth defects or other reproductive harm. For more information go to [www.p65warnings.ca.gov](http://www.p65warnings.ca.gov).

- TABLE OF CONTENTS
- VISUAL INDEX
- FAQs

[Click here for CADs, Support Resources or to Configure Parts Online](#)

# XHMKA6

37° Swivel Conversion Adapter  
37° Flare / 30° Swivel

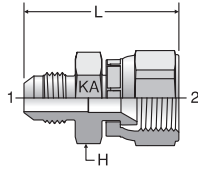

TUBE FITTING PART #	END SIZE		H HEX (mm)	L (mm)	Dynamic Pressure (x 1,000 PSI)
	1 (in.)	2 Metric Thread			S
4-4XHMKA6	1/4	M14 X 1.5	17	40.6	4.0
6-6XHMKA6	3/8	M18 X 1.5	22	42.7	4.0
8-8XHMKA6	1/2	M22 X 1.5	24	49.0	4.0
10-10XHMKA6	5/8	M24 X 1.5	27	57.4	4.0
12-12XHMKA6	3/4	M30 X 1.5	32	65.8	4.0
16-16XHMKA6	1	M33 X 1.5	38	73.9	4.0

**WARNING:** This product can expose you to chemicals including Lead and Lead Compounds which is known to the State of California to cause cancer and birth defects or other reproductive harm. For more information go to [www.p65warnings.ca.gov](http://www.p65warnings.ca.gov).

TABLE OF CONTENTS

VISUAL INDEX

FAQs

# J



# CONVERSION ADAPTERS

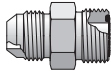
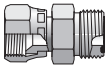
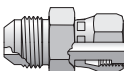
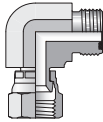
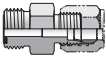
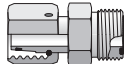
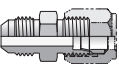
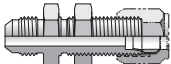
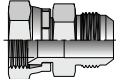
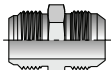
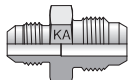
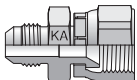
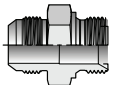
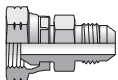
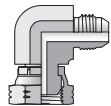
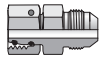

TABLE  
OF  
CONTENTS

<p><b>ORFS to 37° Flare</b></p>	<p><b>XHLO</b> 37° Flare / ORFS</p>  <p>J3</p>	<p><b>LOHX6</b> 37° Swivel / ORFS</p>  <p>J3</p>	<p><b>XHL6</b> 37° Flare / ORFS Swivel</p>  <p>J3</p>	<p><b>LOEX6</b> ORFS / 37° Flare Swivel</p>  <p>J3</p>	
<p><b>ORFS to 24° Flareless</b></p>	<p><b>BUHLO</b> ORFS / 24° Flareless</p>  <p>J4</p>	<p><b>ORFS to Metric 24° Flareless</b></p>	<p><b>LOHU86</b> Metric 24° Flareless/ORFS</p>  <p>J4</p>		
<p><b>37° Flare to 24° Flareless</b></p>	<p><b>XHBU</b> 37° Flare / Flareless</p>  <p>J4</p>	<p><b>XHBU2</b> 37° / Flareless Bulkhead</p>  <p>J4</p>	<p><b>37° Flare to JIS 30° Flare</b></p>	<p><b>XHT46</b> 37° Flare / 30° Flare</p>  <p>J5</p>	<p><b>XHT4</b> 37° Flare / JIS 30° Flare</p>  <p>J5</p>
<p><b>37° Flare to Komatsu Style 30° Flare</b></p>	<p><b>XHMKA</b> 37° Flare / 30° Flare</p>  <p>I5</p>	<p><b>XHMKA6</b> 37° Flare / 30° Swivel</p>  <p>I6</p>			
<p><b>37° Flare to 60° Cone (K4)</b></p>	<p><b>XHK4</b> 37° Flare / 60° Cone</p>  <p>J5</p>	<p><b>XHMK46</b> 37° Flare / BSPP Swivel</p>  <p>J5</p>	<p><b>XEMK46</b> 37° Flare / BSPP Swivel</p>  <p>J6</p>	<p><b>37° Flare to Metric 24° Flareless</b></p>	<p><b>XHU86</b> 37° / Metric 24° Flareless</p>  <p>J6</p>

**O-Rings and Seals (Shown in Section M)**

<p><b>O-Rings</b></p>	<p><b>ORFS O-Ring</b></p>  <p>M4</p>	<p><b>EO O-Ring</b></p>  <p>M10</p>
-----------------------	---	--

[Click here for CADs, Support Resources or to Configure Parts Online](#)

## XHLO

Male Adapter  
37° Flare / ORFS

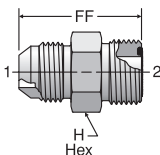

## LOHX6

Swivel Adapter  
37° Flare Swivel / ORFS

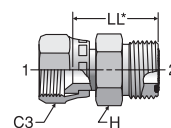

\*LL – End to base of flare

TUBE FITTING PART #	END SIZE		FF (in.)	H HEX (in.)	Dynamic Pressure (x 1,000 PSI)	
	1 (in.)	2 (in.)			-S	-SS
	4 XHLO	1/4			1/4	1.25
6 XHLO	3/8	3/8	1.34	3/4	6.0	7.2
8 XHLO	1/2	1/2	1.55	7/8	6.0	7.2
10 XHLO	5/8	5/8	1.83	1 1/16	5.0	6.0
12 XHLO	3/4	3/4	2.05	1 1/4	5.0	6.0
16 XHLO	1	1	2.16	1 1/2	4.5	5.4
20 XHLO	1 1/4	1 1/4	2.29	1 3/4	4.0	4.8
24 XHLO	1 1/2	1 1/2	2.48	2 1/8	3.0	3.6

**WARNING:** This product can expose you to chemicals including Lead and Lead Compounds which is known to the State of California to cause cancer and birth defects or other reproductive harm. For more information go to [www.p65warnings.ca.gov](http://www.p65warnings.ca.gov).

TUBE FITTING PART #	END SIZE		C3 HEX (in.)	H HEX (in.)	LL Ref. (in.)	Dynamic Pressure (x 1,000 PSI)	
	1 (in.)	2 (in.)				-S	-SS
	4 LOHX6	1/4				1/4	9/16
6 LOHX6	3/8	3/8	11/16	3/4	1.06	5.0	6.0
8 LOHX6	1/2	1/2	7/8	7/8	1.21	5.0	6.0
10 LOHX6	5/8	5/8	1	1 1/16	1.40	5.0	6.0
12 LOHX6	3/4	3/4	1 1/4	1 1/4	1.48	5.0	6.0
16 LOHX6	1	1	1 1/2	1 1/2	1.64	3.6	4.3
20 LOHX6	1 1/4	1 1/4	2	1 3/4	1.77	3.6	4.3

**WARNING:** This product can expose you to chemicals including Lead and Lead Compounds which is known to the State of California to cause cancer and birth defects or other reproductive harm. For more information go to [www.p65warnings.ca.gov](http://www.p65warnings.ca.gov).

## XHL6

Male Swivel Adapter  
ORFS Swivel / 37° Flare

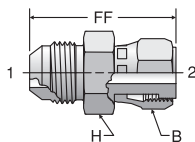

## LOEX6

Swivel Elbow  
ORFS / 37° Flare Swivel

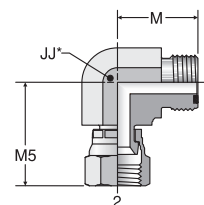

\* JJ – Across wrench flats

TUBE FITTING PART #	END SIZE		B HEX (in.)	FF (in.)	H HEX (inch) (in.)	Dynamic Pressure (x 1,000 PSI)	
	1 (in.)	2 (in.)				-S	-SS
	4 XHL6	1/4				1/4	11/16
6 XHL6	3/8	3/8	13/16	1.61	3/4	6.0	7.2
8 XHL6	1/2	1/2	15/16	1.90	7/8	6.0	7.2
10 XHL6	5/8	5/8	1 1/8	2.20	1 1/16	5.0	6.0
12 XHL6	3/4	3/4	1 3/8	2.50	1 1/4	5.0	6.0
16 XHL6	1	1	1 5/8	2.66	1 1/2	4.5	5.4
20 XHL6	1 1/4	1 1/4	1 7/8	2.80	1 11/16	4.0	4.8

**WARNING:** This product can expose you to chemicals including Lead and Lead Compounds which is known to the State of California to cause cancer and birth defects or other reproductive harm. For more information go to [www.p65warnings.ca.gov](http://www.p65warnings.ca.gov).

TUBE FITTING PART #	END SIZE		JJ (in.)	M (in.)	M5 (in.)	Dynamic Pressure (x 1,000 PSI)	
	1 (in.)	2 UN/UNF-2B				-S	-SS
	4 LOEX6	1/4				1/4	9/16
6 LOEX6	3/8	3/8	3/4	0.98	1.25	5.0	5.0
8 LOEX6	1/2	1/2	3/4	1.10	1.38	5.0	5.0
10 LOEX6	5/8	5/8	1 1/16	1.31	1.63	5.0	5.0
12 LOEX6	3/4	3/4	1 3/16	1.47	1.80	5.0	5.0
16 LOEX6	1	1	1 7/16	1.64	2.00	4.0	4.0
20 LOEX6	1 1/4	1 1/4	1 5/8	1.76	2.31	3.6	3.6
24 LOEX6	1 1/2	1 1/2	1 7/8	1.92	2.59	3.0	3.0



Click here for CADs, Support Resources or to Configure Parts Online

# BUHLO

Ferulok Male Adapter  
ORFS / SAE Flareless

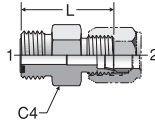

TUBE FITTING PART #	END SIZE		C4 HEX (in.)	L (in.)	Dynamic Pressure (x 1,000 PSI)	
	1 (in.)	2 (in.)			-S	-SS
	6 BUHLO	3/8			3/8	3/4
8 BUHLO	1/2	1/2	7/8	1.45	5.0	6.0
10 BUHLO	5/8	5/8	1 1/16	1.70	5.0	6.0
12 BUHLO	3/4	3/4	1 1/4	1.88	4.5	5.4
16 BUHLO	1	1	1 1/2	1.94	4.0	4.8

**WARNING:** This product can expose you to chemicals including Lead and Lead Compounds which is known to the State of California to cause cancer and birth defects or other reproductive harm. For more information go to [www.p65warnings.ca.gov](http://www.p65warnings.ca.gov).

# LOHU86

EO Swivel Adapter  
24° Flareless Metric Swivel (EO) / ORFS

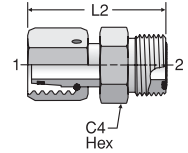

TUBE FITTING PART #	END SIZE		C4 HEX (in.)	L2 (in.)	Dynamic Pressure (x 1,000 PSI)	
	1 EO Swivel	2 (in.)			-S	-SS
	<b>L Series</b>					
4-6L LOHU86	6L	1/4	5/8	1.32	4.5	5.4
4-8L LOHU86	8L	1/4	5/8	1.32	4.5	5.4
6-10L LOHU86	10L	3/8	3/4	1.44	4.5	5.4
8-12L LOHU86	12L	1/2	7/8	1.53	4.5	5.4
10-15L LOHU86	15L	5/8	1 1/16	1.82	4.5	5.4
12-18L LOHU86	18L	3/4	1 1/4	1.89	4.5	5.4
16-22L LOHU86	22L	1	1 1/2	2.08	2.5	3.0
<b>S Series</b>						
4-6S LOHU86	6S	1/4	5/8	1.32	9.2	9.2
4-8S LOHU86	8S	1/4	5/8	1.34	9.2	9.2
6-10S LOHU86	10S	3/8	3/4	1.44	9.2	9.2
8-12S LOHU86	12S	1/2	7/8	1.59	9.2	9.2
10-14S LOHU86	14S	5/8	1 1/16	1.84	9.2	9.2
10-16S LOHU86	16S	5/8	1 1/16	1.84	5.8	5.8
12-20S LOHU86	20S	3/4	1 1/4	2.05	5.8	5.8
16-25S LOHU86	25S	1	1 1/2	2.15	5.8	5.8

**WARNING:** This product can expose you to chemicals including Lead and Lead Compounds which is known to the State of California to cause cancer and birth defects or other reproductive harm. For more information go to [www.p65warnings.ca.gov](http://www.p65warnings.ca.gov).

# XHBU

Union Adapter  
SAE Flareless / 37° Flare

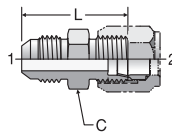

TUBE FITTING PART #	END SIZE		C HEX (in.)	L (in.)	Dynamic Pressure (x 1,000 PSI)	
	1 (in.)	2 (in.)			-S	-SS
	4 XHBU	1/4			1/4	1/2
6 XHBU	3/8	3/8	5/8	1.28	5.0	7.7
8 XHBU	1/2	1/2	13/16	1.47	5.0	7.7
10 XHBU	5/8	5/8	15/16	1.69	5.0	6.0
12 XHBU	3/4	3/4	1 1/8	1.94	4.5	6.0
16 XHBU	1	1	1 5/8	1.97	4.0	4.8
20 XHBU	1 1/4	1 1/4	1 3/4	2.00	3.0	3.6
24 XHBU	1 1/2	1 1/2	2 1/8	2.16	2.0	2.4

**WARNING:** This product can expose you to chemicals including Lead and Lead Compounds which is known to the State of California to cause cancer and birth defects or other reproductive harm. For more information go to [www.p65warnings.ca.gov](http://www.p65warnings.ca.gov).

# XHBU2

Bulkhead Union Adapter  
SAE Flareless Bulkhead / 37° Flare

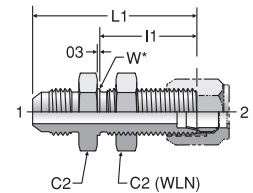

\*W – Bulkhead pilot dia. recommended clearance hole is +.015 over W dia.

TUBE FITTING PART #	END SIZE		C2 HEX (in.)	I1 (in.)	L1 (in.)	W (in.)	Max. Bulkhead Thickness	Dynamic Pressure (x 1,000 PSI)	
	1 (in.)	2 (in.)						-S	-SS
	4 XHBU2	1/4						1/4	11/16
6 XHBU2	3/8	3/8	13/16	1.17	2.08	0.56	0.40	5.0	7.7
8 XHBU2	1/2	1/2	1	1.31	2.31	0.75	0.40	5.0	7.7
10 XHBU2	5/8	5/8	1 1/8	1.45	2.56	0.88	0.37	5.0	7.7
12 XHBU2	3/4	3/4	1 3/8	1.56	2.94	1.06	0.43	4.5	5.4
16 XHBU2	1	1	1 5/8	1.56	2.95	1.31	0.43	4.0	4.8

**WARNING:** This product can expose you to chemicals including Lead and Lead Compounds which is known to the State of California to cause cancer and birth defects or other reproductive harm. For more information go to [www.p65warnings.ca.gov](http://www.p65warnings.ca.gov).

TABLE OF CONTENTS

VISUAL INDEX

FAQs

ASSEMBLY

TUBE FAB EQUIP

Dimensions and pressures for reference only, subject to change

[Click here for CADs, Support Resources or to Configure Parts Online](#)

## XHT46

BSPP Swivel Adapter  
37° Flare / 30° Flare Swivel

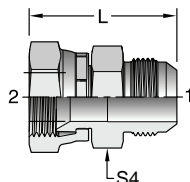

TUBE FITTING PART #	End Size		S4 Hex (in.)	L (in.)	Dynamic Pressure (x 1,000 PSI)
	1 (in.)	2 BSPP			-S
4 XHT46	1/4	1/4-19	9/16	1.22	5.0
6 XHT46	3/8	3/8-19	11/16	1.32	5.0
8 XHT46	1/2	1/2-14	7/8	1.46	5.0
12 XHT46	3/4	3/4-14	1 1/4	1.92	4.0
16 XHT46	1	1-11	1 1/2	2.05	3.0

**WARNING:** This product can expose you to chemicals including Lead and Lead Compounds which is known to the State of California to cause cancer and birth defects or other reproductive harm. For more information go to [www.p65warnings.ca.gov](http://www.p65warnings.ca.gov).

## XHT4

Union Adapter  
37° Flare / JIS 30° Flare

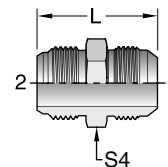

TUBE FITTING PART #	End Size		S4 Hex (in.)	L (in.)	Dynamic Pressure (x 1,000 PSI)
	1 (in.)	2 BSPP			-S
4-4 XHT4	1/4	1/4-19	3/4	1.42	5.0
6 XHT4	3/8	3/8-19	3/4	1.55	5.0
8 XHT4	1/2	1/2-14	7/8	1.75	5.0
12 XHT4	3/4	3/4-14	1 1/8	2.06	4.0
16 XHT4	1	1-11	1 3/8	2.17	3.0

**WARNING:** This product can expose you to chemicals including Lead and Lead Compounds which is known to the State of California to cause cancer and birth defects or other reproductive harm. For more information go to [www.p65warnings.ca.gov](http://www.p65warnings.ca.gov).

## XHK4

BSPP Swivel Adapter  
37° Flare / 60° Cone

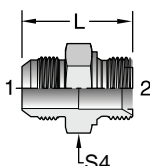

TUBE FITTING PART #	End Size		S4 Hex (in.)	L (in.)	Dynamic Pressure (x 1,000 PSI)
	1 (in.)	2 BSPP			-S
4-4 XHK4	1/4	1/4-19	3/4	1.25	5.1
6-4 XHK4	3/8	1/4-19	7/8	1.42	2.9
6-6 XHK4	3/8	3/8-19	7/8	1.46	2.9
8-6 XHK4	1/2	3/8-19	1 1/16	1.61	2.9
8-8 XHK4	1/2	1/2-14	1 1/16	1.69	2.9
10-8 XHK4	5/8	1/2-14	1 1/8	1.89	2.9
12-12 XHK4	3/4	3/4-14	1 5/16	2.13	2.9
12-16XHK4	3/4	1-11	1 5/8	2.27	1.7
16-16 XHK4	1	1-11	1 5/8	2.32	1.7

**WARNING:** This product can expose you to chemicals including Lead and Lead Compounds which is known to the State of California to cause cancer and birth defects or other reproductive harm. For more information go to [www.p65warnings.ca.gov](http://www.p65warnings.ca.gov).

## XHMK46

BSPP Swivel Adapter  
37° Flare / BSPP 60° Cone Swivel

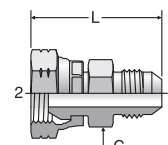

TUBE FITTING PART #	END SIZE		C HEX (mm)	L (mm)	Dynamic Pressure (x 1,000 PSI)
	1 (in.)	2 BSPP			S
6-4XHMK46	3/8	1/4-19	17	40.0	5.0
6XHMK46	3/8	3/8-19	17	39.2	4.0
8-6XHMK46	1/2	3/8-19	19	42.3	4.0
8XHMK46	1/2	1/2-14	19	45.0	4.0
10-8XHMK46	5/8	1/2-14	24	48.6	4.0
12XHMK46	3/4	3/4-14	30	50.0	4.0
12-16XHMK46	3/4	1-11	36	56.8	3.0
16XHMK46	1	1-11	36	58.0	3.0

**WARNING:** This product can expose you to chemicals including Lead and Lead Compounds which is known to the State of California to cause cancer and birth defects or other reproductive harm. For more information go to [www.p65warnings.ca.gov](http://www.p65warnings.ca.gov).

Swivel end mates with BS5200 (Parker K4) adapters and Parker D9 hose fittings.

TABLE OF CONTENTS

VISUAL INDEX

FAQs

ASSEMBLY

TUBE FAB EQUIP

J

Dimensions and pressures for reference only, subject to change.

[Click here for CADs, Support Resources or to Configure Parts Online](#)

## XEMK46

90° BSP Swivel Adapter  
37° Flare / BSPP 60° Cone  
Swivel

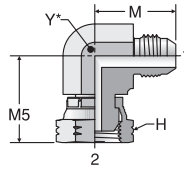

\* Y – Across wrench flats

Swivel end mates with BS5200 (Parker K4) adapters and Parker D9 hose fittings.

TUBE FITTING PART #	END SIZE		M (mm)	M5 (mm)	Y (mm)	Dynamic Pressure (x 1,000 PSI) S
	1 (in.)	2 BSPP				
6-4XEMK46	3/8	1/4-19	26.9	33.2	19	4.0
6XEMK46	3/8	3/8-19	26.9	32.6	19	4.0
8-6XEMK46	1/2	3/8-19	31.8	32.6	19	4.0
8XEMK46	1/2	1/2-14	31.8	38.8	22	4.0
10-8XEMK46	5/8	1/2-14	36.8	38.8	22	4.0
12XEMK46	3/4	3/4-14	42.2	40.3	27	4.0
12-16XEMK46	3/4	1-11	42.2	48.8	33	3.0
16XEMK46	1	1-11	46.0	48.8	33	3.0

## XHU86

EO Swivel Adapter  
Metric Swivel (EO) / 37° Flare

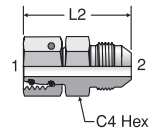

TUBE FITTING PART #	END SIZE		C4 HEX (in.)	L2 (in.)	Dynamic Pressure (x 1,000 PSI)		
	1 EO Swivel	2 (in.)			S	SS	B
<b>L Series</b>							
4-6L XHU86	6L	1/4	1/2	1.47	4.5	4.5	2.9
6-8L XHU86	8L	3/8	5/8	1.52	4.5	4.5	2.9
6-10L XHU86	10L	3/8	5/8	1.57	4.5	4.5	2.9
8-12L XHU86	12L	1/2	13/16	1.69	4.5	4.5	2.9
10-15L XHU86	15L	5/8	15/16	1.98	4.5	4.5	2.9
12-18L XHU86	18L	3/4	1 1/8	2.11	4.5	4.5	2.9
16-22L XHU86	22L	1	1 3/8	2.36	2.3	2.3	1.5
16-28L XHU86	28L	1	1 3/8	2.45	2.3	2.3	1.5
<b>S Series</b>							
4-6S XHU86	6S	1/4	1/2	1.49	7.5	7.5	4.9
6-8S XHU86	8S	3/8	5/8	1.57	7.5	7.5	4.9
6-10S XHU86	10S	3/8	11/16	1.57	7.5	7.5	4.9
8-12S XHU86	12S	1/2	13/16	1.75	6.0	6.0	3.9
10-16S XHU86	16S	5/8	15/16	2.04	5.0	5.0	3.3
12-20S XHU86	20S	3/4	1 1/8	2.29	5.0	5.0	3.3
16-25S XHU86	25S	1	1 3/8	2.45	4.5	4.5	2.9

**WARNING:** This product can expose you to chemicals including Lead and Lead Compounds which is known to the State of California to cause cancer and birth defects or other reproductive harm. For more information go to [www.p65warnings.ca.gov](http://www.p65warnings.ca.gov).

TABLE OF CONTENTS

VISUAL INDEX

FAQs

ASSEMBLY

TUBE FAB EQUIP







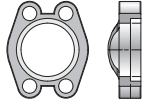
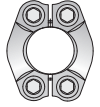

Dimensions and pressures for reference only, subject to change.

# K

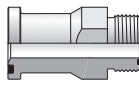
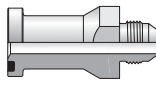
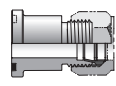
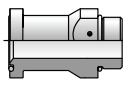
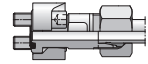
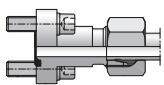



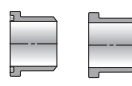
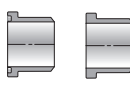
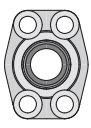
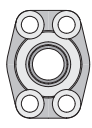
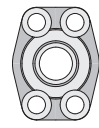
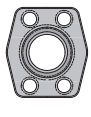
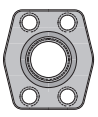
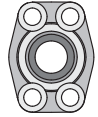
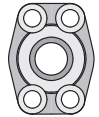
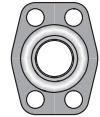
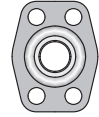
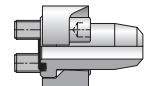
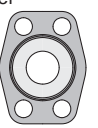
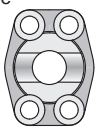
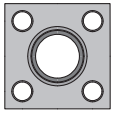
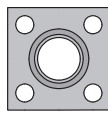
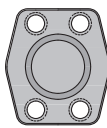
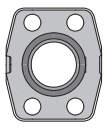
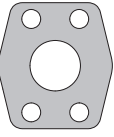
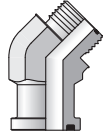
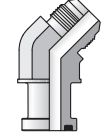
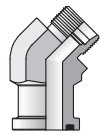
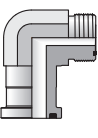
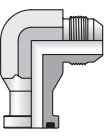
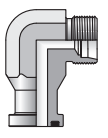
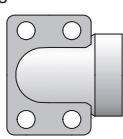
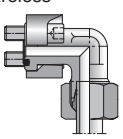

## HYDRAULIC FLANGES & COMPONENTS & DUAL SEAL FLANGES



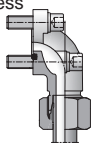

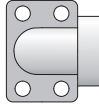
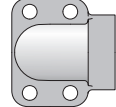
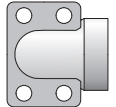
# Hydraulic Flanges and Components

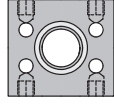
<p><b>Flange Clamps</b></p>	<p><b>FCS</b> Flange Clamps – Split</p>  <p>K9</p>	<p><b>FCC</b> Flange Clamp – Captive</p>  <p>K9</p>	<p><b>FHS3</b> Code 61 Flange Clamps – Metric</p>  <p>K10</p>	<p><b>FHS6</b> Code 62 Flange Clamps – Metric</p>  <p>K11</p>	
<p><b>Straight Flange Adapters / Flanges</b></p>	<p><b>LOHQ</b> Code 61, 62 / ORFS</p>  <p>K12</p>	<p><b>XHQ</b> Code 61, 62 / 37° Flare</p>  <p>K12</p>	<p><b>BUHQ1</b> Code 61 / Flareless</p>  <p>K12</p>	<p><b>F5OHQ</b> Code 61, 62 / SAE-ORB</p>  <p>K13</p>	<p><b>GFS</b> Code 61, 62 / Metric Flareless</p>  <p>K14</p>
<p><b>BFG</b> DIN Flange / Metric Flareless</p>  <p>K15</p>	<p><b>B3HQ</b> Code 61, 62 / Flareless</p>  <p>K13</p>	<p><b>P</b> Flange Head Plug</p>  <p>K15</p>	<p><b>W7HQ</b> Flange Head / Pipe Socket</p>  <p>K16</p>	<p><b>G5HQ</b> Flange Head / SAE-ORB</p>  <p>K16</p>	<p><b>GHQ</b> Flange Head / NPT</p>  <p>K16</p>
<p><b>WB1/3/5HQ1</b> Code 61 / Weld Butt – Pipe</p>  <p>K17</p>	<p><b>WB3/5/7HQ2</b> Code 62 / Weld Butt – Pipe</p>  <p>K18</p>	<p><b>G5Q</b> Code 61, 62 / SAE-ORB</p>  <p>K19</p>	<p><b>GQ</b> Code 61, 62 / NPT</p>  <p>K20</p>	<p><b>G4Q</b> Code 61, 62 / BSPP</p>  <p>K21</p>	<p><b>W5Q</b> Code 61, 62 / Socket – Pipe</p>  <p>K22</p>
<p><b>W4Q</b> Code 61, 62 / Socket – Tube</p>  <p>K23</p>	<p><b>W7Q</b> Code 61, 62 / Ext Socket – Pipe</p>  <p>K24</p>	<p><b>W6Q</b> Code 61, 62 / Ext Socket – Tube</p>  <p>K25</p>	<p><b>WB1/3/5Q1</b> Code 61 / Weld Butt – Pipe</p>  <p>K26</p>	<p><b>WB3/5/7Q2</b> Code 62 / Weld Butt – Pipe</p>  <p>K27</p>	<p><b>AS</b> Code 61, 62 / Weld Butt – Tube Metric</p>  <p>K28</p>
<p><b>WBT</b> Code 61 / Weld Tank Adapter</p>  <p>K28</p>	<p><b>WSD</b> Code 61, 62 / Weld Saddle</p>  <p>K29</p>	<p><b>GQS</b> Square Flange / NPT</p>  <p>K29</p>	<p><b>W5SQS</b> Square Flange / Weld Socket – Pipe</p>  <p>K30</p>	<p><b>PQ</b> Code 61, 62 / Blank</p>  <p>K30</p>	<p><b>SPGG5</b> Flange Spacer w/Gage Ports</p>  <p>K31</p>
<p><b>CP</b> Flange Connector Plate</p>  <p>K31</p>	<p><b>45° Flange Adapters</b></p>	<p><b>LOVQ</b> Code 61, 62 / ORFS</p>  <p>K32</p>	<p><b>XVQ</b> Code 61, 62 / 37° Flare</p>  <p>K32</p>	<p><b>BUVQ1</b> Code 61 / Flareless</p>  <p>K32</p>	
<p><b>90° Flange Adapters</b></p>	<p><b>LOEQ</b> Code 61, 62 / ORFS</p>  <p>K33</p>	<p><b>XEQ</b> Code 61, 62 / 37° Flare</p>  <p>K33</p>	<p><b>BUEQ1</b> Code 61 / Flareless</p>  <p>K33</p>	<p><b>W7EQ</b> Code 61, 62 / Weld Socket – Pipe</p>  <p>K34</p>	<p><b>WFS</b> Code 61, 62 / Metric Flareless</p>  <p>K35</p>

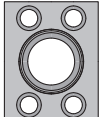
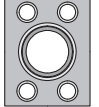
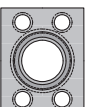
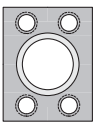









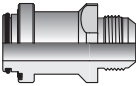

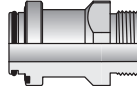

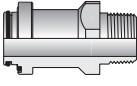
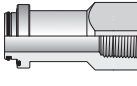

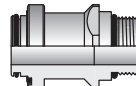
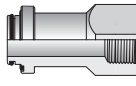
<p><b>BFW</b>                  DIN Flange / Metric                  Flareless</p>  <p>K36</p>	<p><b>90° Elbows</b></p> 	<p><b>G5EQ</b>                  Code 61, 62 / SAE-ORB</p>  <p>K37</p>	<p><b>GEQ</b>                  Code 61, 62 / NPT</p>  <p>K38</p>	<p><b>W6EQ</b>                  Code 61, 62 / Weld                  Socket – Tube</p>  <p>K39</p>	
<p><b>Tee</b></p> 	<p><b>QPQPJQ</b>                  Code 61, 62 Junction Tee</p>  <p>K37</p>	<p><b>Stainless                  Steel                  Flanges</b></p> 	<p><b>G5Q</b>                  Code 61, 62 / SAE-ORB</p>  <p>K40</p>	<p><b>GQ</b>                  Code 61, 62 / NPT</p>  <p>K40</p>	<p><b>W5Q</b>                  Code 61, 62 / Weld                  Socket – Pipe</p>  <p>K41</p>
<p><b>PQ</b>                  Code 61, 62 / Blank</p>  <p>K42</p>					

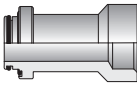
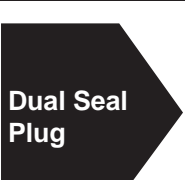
**O-rings and Seals (Shown in Section M)**

<p><b>O-rings                  and Seals</b></p> 	<p><b>ORFS O-ring</b></p>  <p>M4</p>	<p><b>SAE 4-Bolt Flange                  O-ring</b></p>  <p>M10</p>
---	---	--

## Dual Seal Flanges

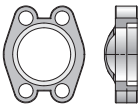
 <p><b>37° Flare</b></p>	<p><b>XHQ40</b> 37° Flare</p>  <p>K43</p>	 <p><b>ORFS</b></p>	<p><b>LOHQ40</b> ORFS</p>  <p>K43</p>	 <p><b>NPTF</b></p>	<p><b>FHQ40</b> Male NPTF</p>  <p>K43</p>
<p><b>GHQ40</b> Female NPTF</p>  <p>K44</p>	 <p><b>SAE-ORB</b></p>	<p><b>F5OHQ40</b> Male SAE-ORB</p>  <p>K44</p>	<p><b>G5HQ40</b> Female SAE-ORB</p>  <p>K44</p>	 <p><b>Socket Weld Pipe</b></p>	<p><b>W7HQ40</b> Socket Weld Pipe</p>  <p>K45</p>
 <p><b>Dual Seal Plug</b></p>	<p><b>PQ40</b> Dual Seal Plug</p>  <p>K45</p>	 <p><b>Q4 Insert</b></p>	<p><b>Q4 Insert</b> Flange Insert</p>  <p>K45</p>		
 <p><b>Flange Clamps</b></p>	<p><b>FCS</b> Flange Clamps – Split</p>  <p>K9</p>	<p><b>FCC</b> Flange Clamp – Captive</p>  <p>K9</p>			

## O-rings and Seals (Shown in Section M)

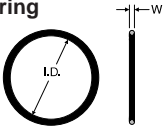
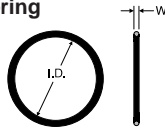
 <p><b>O-rings and Seals</b></p>	<p><b>Radial Seal O-ring</b></p>  <p>M10</p>	<p><b>Flange Seal O-ring</b></p>  <p>M10</p>
---	---	---

## Hydraulic Flanges and Components

The 4-bolt flange connections conforming to SAE J518 and ISO 6162-1 and -2 are proven, leak-free connections, especially suited for larger sizes, higher pressures and assembly in tight quarters. Threaded port connections such as SAE straight thread and ISO 6149 are reasonably easy to assemble and provide 6000 psi and higher pressure capability up to size 12 (M27). Beyond this size, the pressure rating starts to decrease and assembly torques increase rapidly.

The 4-bolt flange port connections provide the ability to connect larger sizes and achieve higher-pressures at reasonable assembly torque. Because of the lower assembly torque required compared to equivalent size threaded port, these connections are well suited for tight quarters where wrench clearance is limited.

### Design and Construction

Parker's 4-bolt flange products are designed to provide different methods of connecting a tube, hose, pipe or another fitting to the SAE standard 4-bolt flange port.

**Flange Fittings** — All Parker flange fittings, except for those with square mounting hole patterns (nomenclature code QS), are designed to conform to O-ring groove, bolt holes and bolt pattern dimensions of either Code 61 or Code 62 of SAE J518 and ISO 6162-1 (Code 61) or -2 (Code 62).

The flange adapters (Code Q1 and Q2), and flange block fittings (Codes Q1B, Q2B and QSB) have O-ring grooves conforming to SAE J518 dimensions. The flange block fittings (Codes Q1B and Q2B) have through holes for the mounting bolts, again conforming to SAE J518. There is no industry standard for the bolt pattern of the square pattern block flanges with codes QSP and QSB.

The flange pad fittings (Codes Q1P, Q2P, and QSP) have a flat face (no O-ring groove) and the mounting holes are tapped. Where these fittings are used, the seal is in the mating part (flange adapter, flange hose fitting, flange block fitting, etc.) as shown in Fig. K1.

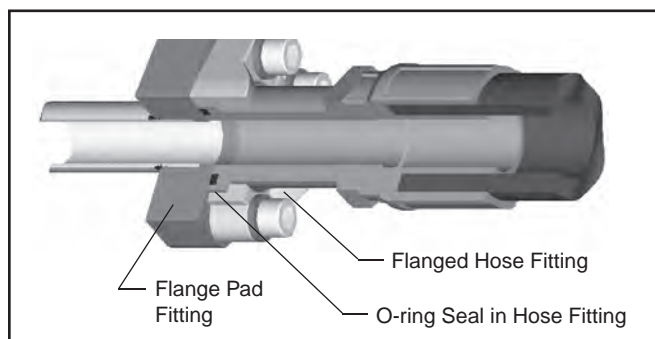

Fig. K1 – Flange Pad Fitting

Dimensions other than the O-ring groove, bolt holes, bolt pattern, and the flange foot print (for codes Q1B and Q2B only) are not governed by any industry standard. However, Parker's product design follows common industry practice and sound engineering.

**Flange Clamps** — Clamps are used for providing the holding power to the 4-bolt flange connection. They are offered in split and captive (one-piece) versions. The captive version is also offered with either drilled or tapped bolt holes which is used for connecting a tube to another tube or hose.

Parker flange clamps are forged for higher strength and durability and meet all requirements of SAE J518. The split clamps make it easy to assemble the connection in close quarters. They also make removal of the flange head component, such as a hose assembly, easy by loosening all four bolts and removing one clamp half, as shown in Fig. K2.

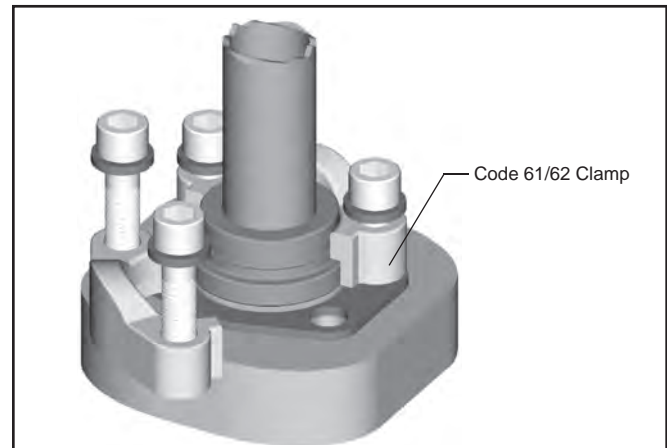

Fig. K2 – Assembly / Removal SAE J518 Connection

### How Flange Connections Work

The connection's success is in its simplicity. It is a static face seal using a high durometer O-ring for the seal and clamps and bolts for holding power as shown in Fig. K3.

The (O-ring) seal is compressed between the bottom of the groove in the flange head and the flat surface of the port or flange pad, providing a reliable soft seal. The alternate seal plate has a high durometer bonded rubber seal on the inside edge, which compresses between the two flat surfaces, providing a soft seal with the same reliability. A metal-to-metal contact at the outer face of the flange with the port face keeps the seal from extruding under pressure. This metal-to-metal contact is maintained by the clamping force provided by tightening the bolts via the clamps.



This simple design provides several advantages over threaded port connections, such as NPTF, SAE, BSPP, ISO 6149, etc., in larger sizes:

- Ability to connect up to 5 inch O.D tube (Code 61 only)
- Much lower tightening torque required for the four bolts compared to that required for equivalent size threaded port
- Less tightening torque means smaller wrenches and wrench swing clearances — providing ease of assembly in tight quarters
- Up to 6000 psi capability through 2" size (Code 62 only)
- Single seal point between tube/pipe/hose assembly and the port
- Ease of disassembly through the use of split clamps

This connection requires a larger area (foot print) on the component than an equivalent threaded port.

## Reference Locations:

**Standard Material Specifications:** Please refer to Table S34 located in the General Technical section.

**Assembly and Installation:** Please refer to Hydraulic Flanges Assembly located within the Assembly/Installation section of this catalog

**Dynamic Pressure Ratings:** Please refer to the last column of the part number tables located on the following pages of this section for the appropriate dynamic pressure ratings.

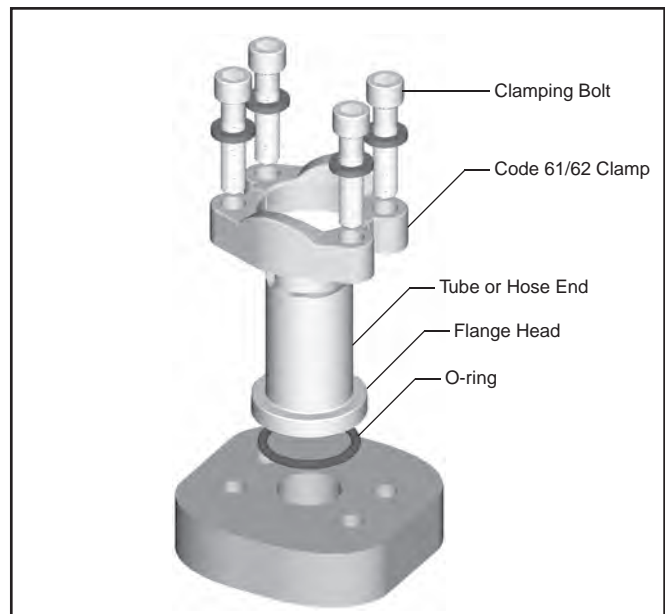

Fig. K3 – Four-Bolt Flange Connection (SAE J518)

TABLE  
OF  
CONTENTS

VISUAL  
INDEX

Feature	Advantage	Benefit
Conforms to SAE J518 and ISO 6162	Controls dimensions and tolerances of code 61 and 62 port connections	Insures interchangeability and consistency
Forged Construction	Reliable, long life performance	No downtime, reduced costs
	Compact envelope size, no sharp edges	Reduced weight
Over 60 Configurations	Flexibility in plumbing, match system needs	Best solution and best value
Parflange Technology	Designed to be used with Code 61/62 fittings	Eliminates messy and time consuming brazing process
Mounting Hardware	Grade 8 bolts standard	Performs in rigorous applications for the life of the flange
Flange Kits	Flange with hardware for mounting (O-ring, bolts and lockwashers)	Reduces order and assembly error

## Dual Seal Flange Adapters

Parker's Dual Seal Flange Adapter product line provides a solution for high vibration, high shock hydraulic four bolt connection styles used in various applications. This Parker innovation is offered as an alternative to traditional ISO 6162-2 (SAE J518) Code 62 Flange connections providing improved port retention, increased sealing capability and elimination of costly field replacement due to failure. Dual Seal Flange Adapters incorporate both radial and face seal technologies, reducing the potential for system leakage and ingress of air or water caused by side loading of traditional flange face seal connections.

Dual Seal Flange Adapters have a system working pressure rating of 7500 PSI with a 4:1 design factor. The face seal system incorporates Parker's Captive O-ring Groove technology to prevent O-ring fall out during installation, minimizing connection failures seen with traditional flange connections.

## Design and Construction

The Dual Seal Flange adapter consists of three components: a body, a face sealing O-ring and a radial sealing O-ring. The body is manufactured from Heat Code Traceable 316 stainless steel and the O-rings are manufactured from 90 durometer Nitrile. Additional components used for assembly of the Dual Seal Flange adapters include four bolts, flange clamps and lock washers. Flange clamps are available from Parker Tube Fittings Division, with standard sizes listed on Page K9 of this catalog section.

### The Dual Seal Flange Adapter Body

Dual Seal Flange Adapters bodies are manufactured in ½", 1" and 1 ½" sizes with ten different cold drawn tube, pipe or hose end configurations available as standard. Straight bodies are machined from 316/316L bar stock.

### Dual Seal Flange Clamps

Flange clamps are offered in both split and captive (one-piece) versions depending on the adapter configuration being used. Flange clamps are machined from 316/316L materials. For all straight Dual Seal Flange Adapter bodies split flange clamp are required. The 90° and 45° cast shaped versions can be installed with either split or captive flange clamps.

## Industry Acceptance

Dual Seal Flange Adapters are designed to conform to bolt thread and bolt pattern dimensions of ISO 6162-2 or SAE J518 Code 62.

Materials used to manufacture Parker Dual Seal Flange Adapters are compliant to NACE MR0175. All products are Heat Code Traceable and have been tested to SAE requirements.

## How Dual Seal Flange Adapters Work

As shown below, Dual Seal Flange connections use both a radial seal and face seal to achieve a superior leak free port connection. The primary radial seal (A) improves the pressure capabilities of this adapter to 7500 PSI while offering additional system integrity. The face seal (B) provides resistance of external pressures introduced by the application environment. The flange clamps (C) and bolts (D) are used to compress the O-rings into the port and provide the clamping force necessary. Reference Fig. K4 below.

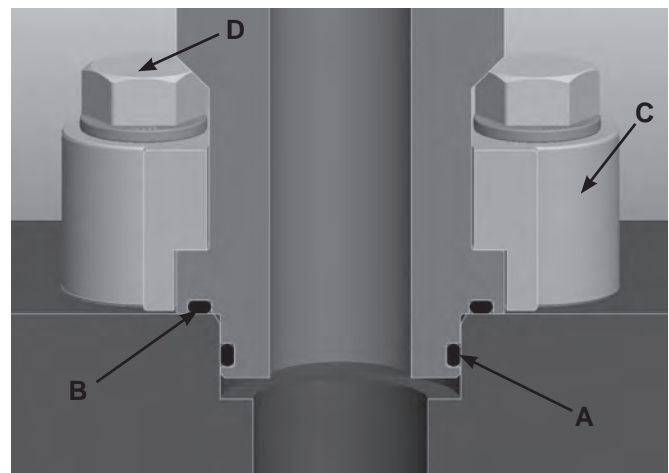

Fig. K4

K



## The Parker Advantage

**Improved Pressure Rating:** Parker's new Dual Seal design is rated for up to 7500 PSI to meet current and future hydraulic design needs. This design has also been tested to meet standard SAE J1644 parameters.

**Captive O-ring Groove:** The design of Parker's Dual Seal Flange Adapters incorporates a captive O-ring groove (CORG) which prevents O-ring fall out during installation further preventing the possibility of leaks.

**Radial Seal:** The primary radial seal (A) improves the pressure capabilities of the Dual Seal system to 7500 PSI while offering additional system integrity.

**Ingression Seal:** Reduces the potential for side loading and ultimately connection failure in high impulse and high vibration applications.

**Multiple Standard Configurations:** Parker's Dual Seal Flange Adapter product line includes a variety of tube, pipe, and hose connection styles to meet hydraulic system design needs. Included are Parker's Seal-Lok (SAE J1453), Triple-Lok (SAE J514), SAE ORB (SAE J1926) and NPTF for traditional hydraulic connections. In addition, to offer a solution for schedule pipe assemblies, Parker offers socket weld configurations.

## Code 61 and Code 62 Port Ends

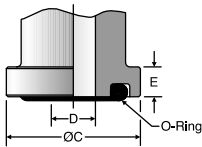

	Flange O.D. C	Drill D Max	Flange Height E
SIZE	(inch)	(inch)	(inch)
<b>CODE 61</b>			
8	1.19	0.50	0.265
12	1.50	0.75	0.265
16	1.75	1.00	0.315
20	2.00	1.25	0.315
24	2.38	1.50	0.315
32	2.81	2.00	0.375
<b>CODE 62</b>			
8	1.25	0.50	0.305
12	1.63	0.75	0.345
16	1.88	1.00	0.375
20	2.13	1.25	0.405
24	2.50	1.50	0.495
32	3.13	2.00	0.495

## Port Ends for Dual Seal Flange Port

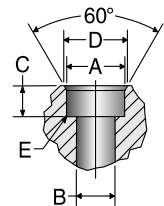

SIZE	A (in.)	B (in.)	C (in.)	D (CSK)	E (R)
8	0.750 - 0.752	0.500	0.400	.82 X 60°	0.02
16	1.375 - 1.377	0.938	0.400	1.445 X 60°	0.02
24	1.750 - 1.752	1.312	0.530	1.82 X 60°	0.02

[Click here for CADs, Support Resources or to Configure Parts Online](#)

# FCS

Code 61/62 Flange Clamps, Split

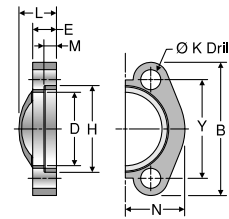

**TABLE OF CONTENTS**

**VISUAL INDEX**

**FAQs**

**GEN TECH**

TUBE FITTING PART #	HOSE PRODUCTS PART #	HOSE PRODUCTS PART #	FLANGE SIZE (in.)	B (in.)	D (in.)	E (in.)	H (in.)	K DRILL DIA. (in.)	L (in.)	M (in.)	N (in.)	Y (in.)	MOUNTING HARDWARE HHCS	Dynamic Pressure (x 1,000 PSI)		
FLANGE HALF	FLANGE HALF	KIT												-S	-SS	
<b>CODE 61 FLANGE CLAMPS, SPLIT</b>																
8FCS1	51H-8	5151HK-8	0.50	2.12	0.955	0.50	1.22	0.344	0.75	0.245	0.86	1.50	5/16-18 x 1.25	5.0	5.0	
12FCS1	51H-12	5151HK-12	0.75	2.56	1.265	0.56	1.53	0.406	0.88	0.245	0.98	1.88	3/8-16 x 1.25	5.0	5.0	
16FCS1	51H-16	5151HK-16	1.00	2.75	1.515	0.62	1.78	0.406	0.94	0.295	1.11	2.06	3/8-16 x 1.25	5.0	5.0	
20FCS1	51H-20	5151HK-20	1.25	3.12	1.720	0.56	2.03	0.469	0.88	0.295	1.39	2.31	7/16-14 x 1.50	4.0	4.0	
24FCS1	51H-24	5151HK-24	1.50	3.69	2.000	0.62	2.41	0.531	1.00	0.295	1.58	2.75	1/2-13 x 1.50	3.0	3.0	
32FCS1	51H-32	5151HK-32	2.00	4.00	2.470	0.62	2.84	0.531	1.03	0.355	1.86	3.06	1/2-13 x 1.50	3.0	3.0	
40FCS1	51H-40	5151HK-40	2.50	4.50	2.950	0.75	3.34	0.531	1.50	0.355	2.09	3.50	1/2-13 x 1.75	2.5	2.5	
48FCS1	51H-48	5151HK-48	3.00	5.31	3.580	0.88	4.03	0.656	1.62	0.355	2.53	4.19	5/8-11 x 1.75	2.0	2.0	
56FCS1	51H-56	5151HK-56	3.50	6.00	4.030	0.88	4.53	0.656	1.12	0.422	2.70	4.75	5/8-11 x 1.75	0.5	0.5	
64FCS1	51H-64	5151HK-64	4.00	6.38	4.530	1.00	5.03	0.656	1.38	0.422	2.95	5.13	5/8-11 x 2.00	0.5	0.5	
<b>CODE 62 FLANGE CLAMPS, SPLIT</b>																
12FCS2	HFH-12	HFHFHK-12	0.75	2.81	1.280	0.75	1.66	0.406	1.12	0.325	1.14	2.00	3/8-16 x 1.50	6.0	6.0	
16FCS2	HFH-16	HFHFHK-16	1.00	3.19	1.530	0.94	1.91	0.469	1.31	0.355	1.33	2.25	7/16-14 x 1.75	6.0	6.0	
20FCS2	HFH-20	HFHFHK-20	1.25	3.75	1.750	1.06	2.16	0.531	1.50	0.385	1.48	2.63	1/2-13 x 1.75	6.0	6.0	
24FCS2	HFH-24	HFHFHK-24	1.50	4.44	2.030	1.19	2.53	0.656	1.69	0.475	1.83	3.13	5/8-11 x 2.25	6.0	6.0	
32FCS2	HFH-32	HFHFHK-32	2.00	5.25	2.660	1.44	3.16	0.781	2.06	0.475	2.20	3.81	3/4-10 x 2.75	6.0	6.0	

To order a flange clamp split kit, insert a "K" after the material designator in the Tube Fitting part number. The Kit includes two flange clamp halves, 4 HHCS bolts, 4 lock washers and an O-ring.

**K**

# FCC

Code 61/62 Flange Clamp, Captive

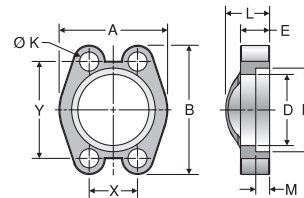

TUBE FITTING PART #	FLANGE SIZE (in.)	A (in.)	B (in.)	D (in.)	E (in.)	H (in.)	K DRILL DIA. (in.)	L (in.)	M (in.)	T TAP UN-2B (in.)	X (in.)	Y (in.)	MOUNTING HARDWARE HHCS	Dynamic Pressure (x 1,000 PSI)		
DRILLED HOLES	TAPPED HOLES													-SX	-SS	
<b>CODE 61 FLANGE CLAMP, CAPTIVE</b>																
8FCC1	8FCCT1	0.50	1.81	2.125	0.955	0.50	1.219	0.344	0.75	0.245	5/16-18	0.688	1.500	5/16-18 x 1.25	5.0	
12FCC1	12FCCT1	0.75	2.06	2.560	1.265	0.56	1.531	0.406	0.88	0.245	3/8-16	0.875	1.875	3/8-16 x 1.25	5.0	
16FCC1	16FCCT1	1.00	2.31	2.750	1.515	0.62	1.781	0.406	0.94	0.295	3/8-16	1.031	2.062	3/8-16 x 1.25	5.0	
20FCC1	20FCCT1	1.25	2.88	3.125	1.720	0.56	2.031	0.469	0.88	0.295	7/16-14	1.188	2.312	7/16-14 x 1.50	4.0	
24FCC1	24FCCT1	1.50	3.25	3.690	2.000	0.62	2.406	0.531	1.00	0.295	1/2-13	1.406	2.750	1/2-13 x 1.50	3.0	
32FCC1	32FCCT1	2.00	3.81	4.000	2.470	0.62	2.844	0.531	1.03	0.355	1/2-13	1.688	3.062	1/2-13 x 1.50	3.0	
40FCC1	40FCCT1	2.50	4.28	4.500	2.950	0.75	3.344	0.531	1.50	0.355	1/2-13	2.000	3.500	1/2-13 x 1.75	2.5	
48FCC1	48FCCT1	3.00	5.16	5.315	3.580	0.88	4.031	0.656	1.62	0.355	5/8-11	2.438	4.188	5/8-11 x 1.75	2.0	
56FCC1	56FCCT1	3.50	5.50	6.000	4.030	0.88	4.531	0.656	1.12	0.422	5/8-11	2.750	4.750	5/8-11 x 1.75	0.5	
64FCC1	64FCCT1	4.00	6.00	6.375	4.530	1.00	5.031	0.656	1.38	0.422	5/8-11	3.062	5.125	5/8-11 x 2.00	0.5	
<b>CODE 62 FLANGE CLAMP, CAPTIVE</b>																
12FCC2	12FCCT2	0.75	2.38	2.810	1.280	0.75	1.656	0.406	1.12	0.325	3/8-16	0.938	2.000	3/8-16 x 1.50	6.0	
16FCC2	16FCCT2	1.00	2.75	3.190	1.530	0.94	1.906	0.469	1.31	0.355	7/16-14	1.093	2.250	7/16-14 x 1.75	6.0	
20FCC2	20FCCT2	1.25	3.06	3.750	1.750	1.06	2.156	0.531	1.50	0.385	1/2-13	1.250	2.625	1/2-13 x 1.75	6.0	
24FCC2	24FCCT2	1.50	3.75	4.440	2.030	1.19	2.531	0.656	1.69	0.475	5/8-11	1.437	3.125	5/8-11 x 2.25	6.0	
32FCC2	32FCCT2	2.00	4.50	5.250	2.660	1.44	3.156	0.781	2.06	0.475	3/4-10	1.750	3.812	3/4-10 x 2.75	6.0	

[Click here for CADs, Support Resources or to Configure Parts Online](#)

# FHS3

## Flange Components

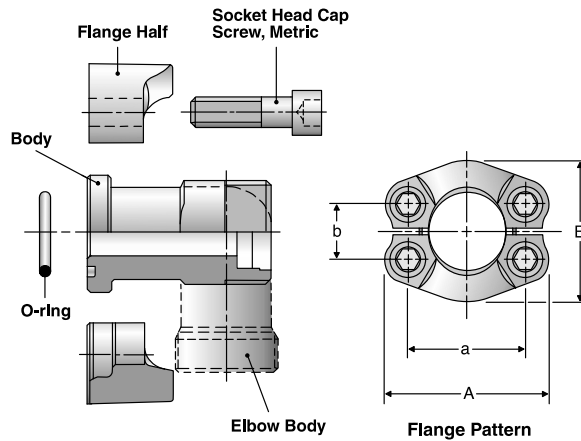

### Code 61

For Straights and Elbows  
(ISO 6162-1, Type 1)

Size	For Tube O.D. Series	Working Pressure (bar)	SAE Flange Halves	4 Socket Head Cap Screws DIN 912-8.8	O-ring
1/2	15L	315	FHS 32CFX	M8X30	OR18.64 x 3.53X
1/2	16S	350			
3/4	18L	315	FHS 33CFX	M10X35	OR25.00 x 3.53X
3/4	22L	160			
3/4	20S	350			
3/4	25S	350			
1	28L	160	FHS 34CFX	M10X35	OR32.92 x 3.53X
1	30S	350			
1 1/4	35L	160	FHS 35CFX	M12X40*	OR37.70 x 3.53X
1 1/4	25S	280			
1 1/4	30S	280			
1 1/4	38S	280			
1 1/2	42L	160	FHS 36CFX	M12X40	OR47.22 x 3.53X
1 1/2	38S	210			

Size	For Tube O.D. Series	A ≈	B ≈	a	b
1/2	15L	54	46	38.1	17.5
1/2	16S	54	46	38.1	17.5
3/4	18L	65	52	47.6	22.2
3/4	22L	65	52	47.6	22.2
3/4	20S	65	52	47.6	22.2
3/4	25S	65	52	47.6	22.2
1	28L	70	59	52.4	26.2
1	30S	70	59	52.4	26.2
1 1/4	35L	79	73	58.7	30.2
1 1/4	25S	79	73	58.7	30.2
1 1/4	30S	79	73	58.7	30.2
1 1/4	38S	79	73	58.7	30.2
1 1/2	42L	94	83	69.9	35.7
1 1/2	38S	94	83	69.9	35.7

Tightening torques for socket head cap screws see Table R6.

\* Does not meet ISO 6162 specification.

Note: Clamp halves are sold separately, not as a set.

- TABLE OF CONTENTS
- VISUAL INDEX
- FAQs
- GEN TECH

[Click here for CADs, Support Resources or to Configure Parts Online](#)

# FHS6

## Flange Components

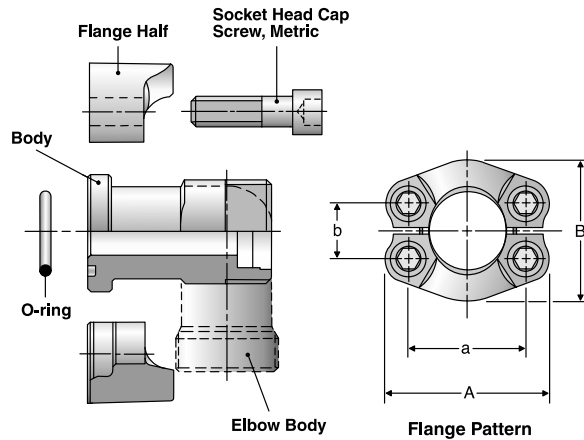

### Code 62

For Straights and Elbows  
(ISO 6162-2, Type 1)

Size	For Tube O.D. Series	Working Pressure (bar)	SAE Flange Halves	4 Socket Head Cap Screws DIN 912-8.8	O-ring
1/2	16S	400	FHS 62CFX	M8X35	OR18.64 x 3.53X
3/4	16S	400	FHS 63CFX	M10X35	OR25.00 x 3.53X
3/4	20S	400	FHS 63CFX	M10X35	OR25.00 x 3.53X
3/4	25S	400	FHS 63CFX	M10X35	OR25.00 x 3.53X
1	25S	400	FHS 64CFX	M12X45	OR32.92 x 3.53X
1	30S	400	FHS 64CFX	M12X45	OR32.92 x 3.53X
1 1/4	30S	400	FHS 65CFX	M14X50*	OR37.70 x 3.53X
1 1/4	38S	315	FHS 65CFX	M14X50*	OR37.70 x 3.53X
1 1/2	38S	315	FHS 66CFX	M16X55	OR47.22 x 3.53X

Size	For Tube O.D. Series	A ≈	a	B ≈	b
1/2	16S	56	40.5	47	18.2
3/4	16S	71	50.8	60	23.8
3/4	20S	71	50.8	60	23.8
3/4	25S	71	50.8	60	23.8
1	25S	81	57.2	70	27.8
1	30S	81	57.2	70	27.8
1 1/4	30S	95	66.7	77	31.8
1 1/4	38S	95	66.7	77	31.8
1 1/2	38S	113	79.4	95	36.5

Tightening torques for socket head cap screws see Table R7.

\* Does not meet ISO 6162 specification.

Note: Clamp halves are sold separately, not as a set.

TABLE OF CONTENTS

VISUAL INDEX

FAQs

GEN TECH

K

Click here for CADs, Support Resources or to Configure Parts Online

## LOHQ1

Code 61 Flange Connector  
Code 61 / ORFS

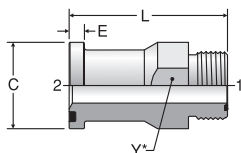

\* Y – Across Wrench Flats

TUBE FITTING PART #	END SIZE		C (in.)	E (in.)	L (in.)	Y (in.)	Dynamic Pressure (x 1,000 PSI) -S
	1 (in.)	2 Code 61					
12 LOHQ1	3/4	3/4	1.500	0.265	2.79	1 3/8	5.0
16 LOHQ1	1	1	1.750	0.315	2.81	1 5/8	5.0
20 LOHQ1	1 1/4	1 1/4	2.000	0.315	3.21	1 7/8	4.0
24 LOHQ1	1 1/2	1 1/2	2.375	0.315	3.29	2 1/8	3.0

**WARNING:** This product can expose you to chemicals including Lead and Lead Compounds which is known to the State of California to cause cancer and birth defects or other reproductive harm. For more information go to [www.p65warnings.ca.gov](http://www.p65warnings.ca.gov).

## LOHQ2

Code 62 Flange Connector  
Code 62 / ORFS

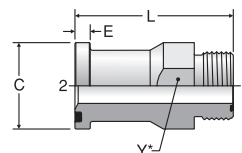

\* Y – Across Wrench Flats

TUBE FITTING PART #	END SIZE		C (in.)	E (in.)	L (in.)	Y (in.)	Dynamic Pressure (x 1,000 PSI) -S
	1 (in.)	2 Code 62					
12 LOHQ2	3/4	3/4	1.625	0.345	3.02	1 3/8	6.0
12-16 LOHQ2	3/4	1	1.875	0.375	3.34	1 5/8	6.0
16 LOHQ2	1	1	1.875	0.375	3.36	1 5/8	6.0
20 LOHQ2	1 1/4	1 1/4	2.125	0.405	3.48	1 7/8	6.0
24 LOHQ2	1 1/2	1 1/2	2.500	0.495	4.14	2 1/8	5.0

**WARNING:** This product can expose you to chemicals including Lead and Lead Compounds which is known to the State of California to cause cancer and birth defects or other reproductive harm. For more information go to [www.p65warnings.ca.gov](http://www.p65warnings.ca.gov).

## XHQ1

Code 61 Flange Connector  
Code 61 / 37° Flare

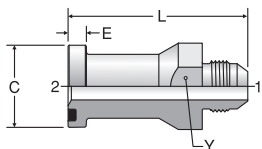

\* Y – Across Wrench Flats

TUBE FITTING PART #	END SIZE		C (in.)	E (in.)	L (in.)	Y (in.)	Dynamic Pressure (x 1,000 PSI) -S
	1 (in.)	2 Code 61					
12 XHQ1	3/4	3/4	1.500	0.265	2.77	1 3/8	5.0
16 XHQ1	1	1	1.750	0.315	2.91	1 5/8	5.0
20 XHQ1	1 1/4	1 1/4	2.000	0.315	3.36	1 7/8	4.0
24 XHQ1	1 1/2	1 1/2	2.375	0.315	3.57	2 1/8	3.0
32 XHQ1	2	2	2.812	0.375	4.04	2 5/8	2.0

**WARNING:** This product can expose you to chemicals including Lead and Lead Compounds which is known to the State of California to cause cancer and birth defects or other reproductive harm. For more information go to [www.p65warnings.ca.gov](http://www.p65warnings.ca.gov).

## XHQ2

Code 62 Flange Connector  
Code 62 / 37° Flare

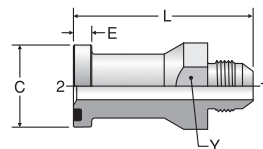

\* Y – Across Wrench Flats

TUBE FITTING PART #	END SIZE		C (in.)	E (in.)	L (in.)	Y (in.)	Dynamic Pressure (x 1,000 PSI) -S
	1 (in.)	2 Code 62					
12 XHQ2	3/4	3/4	1.625	0.345	3.08	1 3/8	5.0
16 XHQ2	1	1	1.875	0.375	3.43	1 5/8	5.0
20 XHQ2	1 1/4	1 1/4	2.125	0.405	3.60	1 7/8	4.0
24 XHQ2	1 1/2	1 1/2	2.500	0.495	4.34	2 1/8	3.0

**WARNING:** This product can expose you to chemicals including Lead and Lead Compounds which is known to the State of California to cause cancer and birth defects or other reproductive harm. For more information go to [www.p65warnings.ca.gov](http://www.p65warnings.ca.gov).

## BUHQ1

Code 61 Connector  
Code 61 / Flareless

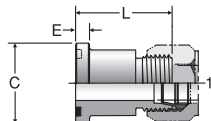

TUBE FITTING PART #	END SIZE		C (in.)	E (in.)	L (in.)	Dynamic Pressure (x 1,000 PSI) -S
	1 (in.)	2 Code 61				
12 BUHQ1	3/4	3/4	1.500	0.265	1.82	
16 BUHQ1	1	1	1.750	0.315	1.88	
20 BUHQ1	1 1/4	1 1/4	2.000	0.315	1.82	
24 BUHQ1	1 1/2	1 1/2	2.375	0.315	1.94	
32 BUHQ1	2	2	2.812	0.375	1.97	

**WARNING:** This product can expose you to chemicals including Lead and Lead Compounds which is known to the State of California to cause cancer and birth defects or other reproductive harm. For more information go to [www.p65warnings.ca.gov](http://www.p65warnings.ca.gov).

TABLE OF CONTENTS

VISUAL INDEX

FAQs

GEN TECH



Click here for CADs, Support Resources or to Configure Parts Online

## F50HQ1

Code 61 Connector  
Code 61 / SAE-ORB

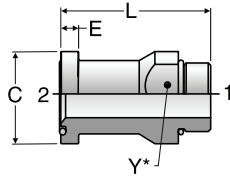

Y\* - Across Wrench Flats

## F50HQ2

Code 62 Connector  
Code 62 / SAE-ORB

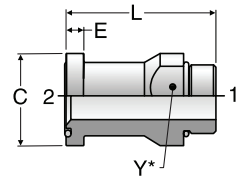

Y\* - Across Wrench Flats

TUBE FITTING PART #	END SIZE		C (in.)	E (in.)	L (in.)	Y (in.)	Dynamic Pressure (x 1,000 PSI) -S
	1 (in.)	2 Code 61					
12 F50HQ1	3/4	3/4	1.500	0.265	2.63	1 3/8	5.0
16 F50HQ1	1	1	1.750	0.315	2.73	1 5/8	4.5
20 F50HQ1	1 1/4	1 1/4	2.000	0.315	3.13	1 7/8	4.0
24 F50HQ1	1 1/2	1 1/2	2.375	0.315	3.22	2 1/8	3.0
32 F50HQ1	2	2	2.812	0.375	3.49	2 3/4	3.0

TUBE FITTING PART #	END SIZE		C (in.)	E (in.)	L (in.)	Y (in.)	Dynamic Pressure (x 1,000 PSI) -S
	1 (in.)	2 Code 62					
12 F50HQ2	3/4	3/4	1.625	0.345	3.08	1 3/8	6.0
16 F50HQ2	1	1	1.875	0.375	3.25	1 5/8	6.0
20 F50HQ2	1 1/4	1 1/4	2.125	0.405	3.37	1 7/8	6.0
24 F50HQ2	1 1/2	1 1/2	2.500	0.495	3.99	2 1/8	5.0
32 F50HQ2	2	2	3.125	0.495	4.86	2 3/4	3.0

**WARNING:** This product can expose you to chemicals including Lead and Lead Compounds which is known to the State of California to cause cancer and birth defects or other reproductive harm. For more information go to [www.p65warnings.ca.gov](http://www.p65warnings.ca.gov).

**WARNING:** This product can expose you to chemicals including Lead and Lead Compounds which is known to the State of California to cause cancer and birth defects or other reproductive harm. For more information go to [www.p65warnings.ca.gov](http://www.p65warnings.ca.gov).

## B3HQ

Braze Flange Head Connector, Tube  
Tube Braze Socket\* / Code 61/62 Flange Head

\* For clearance brazing

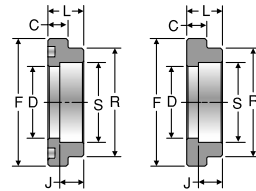

O-ring Face      Flat Face

TUBE FITTING PART #	FLANGE SIZE (in.)	TUBE O.D. (in.)	C (in.)	D (in.)	F (in.)	J (in.)	L (in.)	R (in.)	S (in.)	Dynamic Pressure (x 1,000 PSI)		
										-SX	-SS	
<b>TUBE BRAZE SOCKET / CODE 61 FLANGE HEAD</b>												
8B3HQ1	8B3HQ1N	0.50	1/2	0.265	0.406	1.188	0.312	0.50	0.940	0.502	5.0	
10-8B3HQ1	10-8B3HQ1N	0.50	5/8	0.265	0.500	1.188	0.312	0.50	0.940	0.625	5.0	
12B3HQ1	12B3HQ1N	0.75	3/4	0.265	0.656	1.500	0.375	0.56	1.250	0.752	4.5	
16-12B3HQ1	16-12B3HQ1N	0.75	1	0.315	0.750	1.500	0.375	0.56	1.250	1.002	4.5	
16B3HQ1	16B3HQ1N	1.00	1	0.315	0.906	1.750	0.375	0.56	1.500	1.002	4.5	
20-16B3HQ1	20-16B3HQ1N	1.00	1 1/4	0.315	1.000	1.750	0.375	0.56	1.500	1.252	4.0	
20B3HQ1	20B3HQ1N	1.25	1 1/4	0.315	1.125	2.000	0.375	0.56	1.700	1.252	3.5	
24-20B3HQ1	24-20B3HQ1N	1.25	1 1/2	0.315	1.250	2.000	0.375	0.56	1.700	1.502	3.5	
24B3HQ1	24B3HQ1N	1.50	1 1/2	0.315	1.375	2.380	0.438	0.62	1.980	1.502	3.0	
28-24B3HQ1	28-24B3HQ1N	1.50	1 3/4	0.315	1.500	2.380	0.438	0.62	1.980	1.752	2.7	
32B3HQ1	32B3HQ1N	2.00	2	0.375	1.875	2.810	0.500	0.62	2.450	2.002	3.0	
36-32B3HQ1	36-32B3HQ1N	2.00	2 1/4	0.375	2.000	2.810	0.500	0.62	2.450	2.252	3.0	
40B3HQ1	40B3HQ1N	2.50	2 1/2	0.375	2.375	3.312	0.562	0.68	2.921	2.502	2.2	
44-40B3HQ1	44-40B3HQ1N	2.50	2 3/4	0.375	2.500	3.312	0.500	0.68	2.921	2.752	2.2	
48B3HQ1	48B3HQ1N	3.00	3	0.375	2.875	4.000	0.562	0.75	3.546	3.002	1.7	
<b>TUBE BRAZE SOCKET / CODE 62 FLANGE HEAD</b>												
12B3HQ2	12B3HQ2N	0.75	3/4	0.345	0.656	1.625	0.500	0.69	1.250	0.752	6.0	
16-12B3HQ2	16-12B3HQ2N	0.75	1	0.345	0.750	1.625	0.500	0.69	1.250	1.002	6.0	
16B3HQ2	16B3HQ2N	1.00	1	0.375	0.810	1.875	0.625	0.81	1.500	1.002	6.0	
20-16B3HQ2	20-16B3HQ2N	1.00	1 1/4	0.375	1.000	1.875	0.625	0.81	1.500	1.252	6.0	
20B3HQ2	20B3HQ2N	1.25	1 1/4	0.405	1.010	2.125	0.812	1.00	1.718	1.252	6.0	
24-20B3HQ2	24-20B3HQ2N	1.25	1 1/2	0.405	1.250	2.125	0.812	1.00	1.718	1.502	5.5	
24B3HQ2	24B3HQ2N	1.50	1 1/2	0.495	1.250	2.500	1.000	1.19	2.000	1.502	6.0	
28-24B3HQ2	28-24B3HQ2N	1.50	1 3/4	0.495	1.500	2.500	1.000	1.19	2.000	1.752	4.5	
32B3HQ2	32B3HQ2N	2.00	2	0.495	1.750	3.125	1.375	1.50	2.620	2.002	5.5	
36-32B3HQ2	36-32B3HQ2N	2.00	2 1/4	0.495	2.000	3.125	1.312	1.50	2.620	2.252	4.0	

**WARNING:** This product can expose you to chemicals including Lead and Lead Compounds which is known to the State of California to cause cancer and birth defects or other reproductive harm. For more information go to [www.p65warnings.ca.gov](http://www.p65warnings.ca.gov).

TABLE OF CONTENTS

VISUAL INDEX

FAQs

GEN TECH

K

[Click here for CADs, Support Resources or to Configure Parts Online](#)

# GFS

SAE Flange Connector – Standard Series  
Code 61 & 62 / Metric Flareless

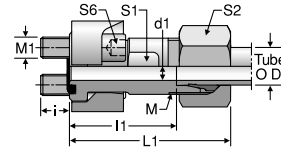

TABLE  
OF  
CONTENTS

VISUAL  
INDEX

FAQs

GEN TECH

TUBE FITTING PART #	SIZE (in.)	TUBE O.D. (mm)	WORKING PRESSURE (bar)	M THREAD	d1 (mm)	i (mm)	L1 (mm)	L1 ≈ (mm)	S1 (mm)	S2 (mm)	S6 (mm)	MATERIAL FROM STOCK		EO-2 FROM STOCK	
												CF	71	CF	71
<b>SAE FLANGE CONNECTIONS – CODE 61 – STANDARD SERIES</b>															
GFS32/15LCF	1/2	15L	200	M22 x 1.5	12	11.5	41	56	24	27	6	•		•	
GFS32/16SCF	1/2	16S	220	M24 x 1.5	12	11.5	41.5	60	24	30	6	•		•	
GFS33/18LCF	3/4	18L	200	M26 x 1.5	15	15.5	45.5	62	30	32	8	•		•	
GFS33/22LCF	3/4	22L	100	M30 x 2	19	15.5	45.5	62	30	36	8	•		•	
GFS33/20SCF	3/4	20S	220	M30 x 2	16	15.5	46.5	68	30	36	8	•		•	
GFS33/25SCF	3/4	25S	220	M36 x 2	17	15.5	45	69	30	46	8	•		•	
GFS34/28LCF	1	28L	100	M36 x 2	24	13.5	46.5	63	36	41	8	•		•	
GFS34/30SCF	1	30S	220	M42 x 2	24	13.5	49.5	76	36	50	8	•		•	
GFS35/35LCF	1 1/4	35L	100	M45 x 2	30	18.5	47.5	69	41	50	8	•		•	
GFS35/25SCF	1 1/4	25S	175	M36 x 2	20	18.5	48	72	41	46	8	•		•	
GFS35/30SCF	1 1/4	30S	175	M42 x 2	25	18.5	48.5	75	41	50	8	•		•	
GFS35/38SCF	1 1/4	38S	175	M52 x 2	28	18.5	50	81	46	60	8	•		•	
GFS36/42LCF	1 1/2	42L	100	M52 x 2	36	18.5	53	76	46	60	10	•		•	
GFS36/38SCF	1 1/2	38S	130	M52 x 2	32	18.5	54	85	46	60	10	•		•	
<b>SAE FLANGE CONNECTIONS – CODE 62 – HIGH PRESSURE SERIES</b>															
GFS62/16SCF	1/2	16S	250	M24 x 1.5	12	13.5	44.5	63	24	30	6	•		•	
GFS63/16SCF	3/4	16S	250	M24 x 1.5	12	15.5	50.5	69	30	30	8	•		•	
GFS63/20SCF	3/4	20S	250	M30 x 2	16	15.5	50.5	72	30	36	8	•		•	
GFS63/25SCF	3/4	25S	250	M36 x 2	17	15.5	51	75	30	46	8	•		•	
GFS64/25SCF	1	25S	250	M36 x 2	20	20.5	60	84	36	46	10	•		•	
GFS64/30SCF	1	30S	250	M42 x 2	24	20.5	60.5	87	36	50	10	•		•	
GFS65/30SCF	1 1/4	30S	250	M42 x 2	25	22.5	65.5	92	41	50	10	•		•	
GFS65/38SCF	1 1/4	38S	200	M52 x 2	30	22.5	67	98	46	60	10	•		•	
GFS66/38SCF	1 1/2	38S	200	M52 x 2	30	24.5	73	104	46	60	14	•		•	

EO-2 Part Number example: GFS33/18ZLCF

Tightening torques for socket head cap screws see Tables R6 and R7.

[Click here for CADs, Support Resources or to Configure Parts Online](#)

# BFG

DIN Flange / Metric Flareless

Tube connection according to DIN 2353

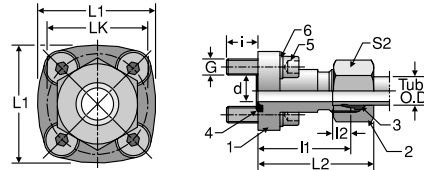

TUBE FITTING PART #	WORKING PRESSURE (bar)	TUBE O.D. (mm)	d (mm)	G	i (mm)	I1 (mm)	I2 (mm)	L1 (mm)	L2 (mm)	LK (mm)	S2 (mm)	MATERIAL FROM STOCK		EO-2 FROM STOCK	
												CF	71	CF	71
BFG15L/LK40CF	65	15	12	M 6	12.5	35	7	42	43	40	27	•		•	
BFG18L/LK40CF	65	18	15	M 6	12.5	35	7.5	42	44	40	32	•		•	
BFG22L/LK40CF	65	22	19	M 6	12.5	35	7.5	42	44.5	40	36	•		•	
BFG15L/LK35CF	155	15	12	M 6	12.5	30	7	39	38	35	27	•		•	
BFG10L/LK35CF	200	10	8	M 6	12.5	30	7	39	39	35	19	•		•	
BFG12L/LK35CF	200	12	10	M 6	12.5	30	7	39	39	35	22	•		•	

## Unassembled BFG Fitting Components

1 Straight Body	2 Nut	3 Progressive Ring	4 O-ring	5 Cap Screws DIN 912-8.8 (4 pcs.)	6 Spring Washer DIN 127 (4 pcs.)
BFG15L/LK40CFX	M15LCFX	DPR15LCFX	OR26X2.5X	M6X22	A6
BFG15L/LK40CFX	M18LCFX	DPR18LCFX	OR26X2.5X	M6X22	A6
BFG22L/LK40CFX	M22LCFX	DPR22LCFX	OR26X2.5X	M6X22	A6
BFG15L/LK35CFX	M15LCFX	DPR15LCFX	OR20X2.5X	M6X22	A6
BFG10L/LK35CFX	M10LCFX	DPR10LCFX	OR20X2.5X	M6X22	A6
BFG12L/LK35CFX	M12LCFX	DPR12LCFX	OR20X2.5X	M6X22	A6

EO-2 Part Number example: BFG15ZL/LK40CF

Tightening torques for socket head cap screws see Table R6.

**WARNING:** This product can expose you to chemicals including Lead and Lead Compounds which is known to the State of California to cause cancer and birth defects or other reproductive harm. For more information go to [www.p65warnings.ca.gov](http://www.p65warnings.ca.gov).

# P

Flange Head Plug  
Code 61/62 Flange Head Plug

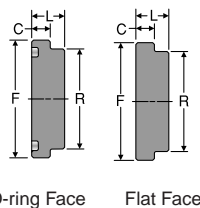

O-ring Face      Flat Face

TUBE FITTING PART #		FLANGE SIZE (in.)	C (in.)	F (in.)	L (in.)	R (in.)	Dynamic Pressure (x 1,000 PSI)	
O-ring FACE	FLAT FACE						-SX	-SS
<b>CODE 61 FLANGE HEAD PLUG</b>								
8PQ1	8PQ1N	0.50	0.265	1.188	0.500	0.940	5.0	
12PQ1	12PQ1N	0.75	0.265	1.500	0.560	1.250	5.0	
16PQ1	16PQ1N	1.00	0.315	1.750	0.560	1.500	5.0	
20PQ1	20PQ1N	1.25	0.315	2.000	0.560	1.700	4.0	
24PQ1	24PQ1N	1.50	0.315	2.380	0.620	1.980	3.0	
32PQ1	32PQ1N	2.00	0.375	2.810	0.620	2.450	3.0	
40PQ1	40PQ1N	2.50	0.375	3.312	0.680	2.921	2.5	
48PQ1	48PQ1N	3.00	0.375	4.000	0.750	3.546	2.0	
<b>CODE 62 FLANGE HEAD PLUG</b>								
12PQ2	12PQ2N	0.75	0.345	1.625	0.687	1.250	6.0	
16PQ2	16PQ2N	1.00	0.375	1.875	0.812	1.500	6.0	
20PQ2	20PQ2N	1.25	0.405	2.125	1.000	1.718	6.0	
24PQ2	24PQ2N	1.50	0.495	2.500	1.187	2.000	6.0	
32PQ2	32PQ2N	2.00	0.495	3.125	1.500	2.625	6.0	

- TABLE OF CONTENTS
- VISUAL INDEX
- FAQs
- GEN TECH



[Click here for CADs, Support Resources or to Configure Parts Online](#)

## W7HQ

Weld Socket Flange Connector, Pipe  
Extended Weld Socket, Pipe / Code 61 or 62 Flange Head

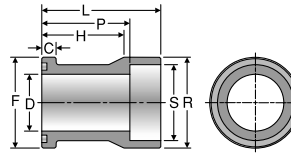

TUBE FITTING PART #	PIPE SIZE (in.)	FLANGE SIZE (in.)	C (in.)	D (in.)	F (in.)	H (in.)	L (in.)	P (in.)	R (in.)	S (in.)	Dynamic Pressure (x 1,000 PSI)	
											SX	SS
<b>EXTENDED WELD SOCKET, PIPE / CODE 61 FLANGE HEAD</b>												
12W7HQ1	3/4	0.75	0.265	0.750	1.500	1.62	2.34	1.78	1.500	1.062	3.5	
16W7HQ1	1	1.00	0.315	1.000	1.750	1.62	2.38	1.75	1.750	1.328	3.5	
20W7HQ1	1 1/4	1.25	0.315	1.250	2.000	1.81	2.62	1.94	2.000	1.672	3.5	
24W7HQ1	1 1/2	1.50	0.315	1.500	2.375	2.00	2.88	2.12	2.375	1.922	2.7	
32W7HQ1	2	2.00	0.375	2.000	2.812	2.00	3.00	2.12	2.812	2.406	2.5	
<b>EXTENDED WELD SOCKET, PIPE / CODE 62 FLANGE HEAD</b>												
16W7HQ2	1	1.00	0.375	1.000	1.875	2.34	3.06	2.43	2.000	1.328	5.5	
20W7HQ2	1 1/4	1.25	0.405	1.125	2.125	2.50	3.31	2.62	2.312	1.672	5.5	
24W7HQ2	1 1/2	1.50	0.495	1.375	2.500	3.06	3.93	3.18	2.750	1.922	5.5	
32W7HQ2	2	2.00	0.495	1.875	3.125	3.18	4.06	3.18	3.250	2.406	5.0	

TABLE OF CONTENTS

VISUAL INDEX

FAQs

GEN TECH

## GHQ / G5HQ

Threaded Port Flange Adapter  
NPTF or SAE Port / Code 61 Flange Head

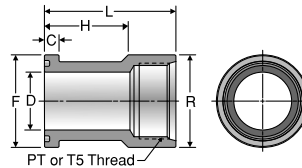

### GHQ

TUBE FITTING PART #	PT PORT THREAD NPTF	FLANGE SIZE (in.)	C (in.)	D (in.)	F (in.)	H (in.)	L (in.)	R (in.)	Dynamic Pressure (x 1,000 PSI)	
									-SX	-SS
<b>NPTF PORT / CODE 61 FLANGE HEAD</b>										
12GHQ1	3/4-14	0.75	0.265	0.75	1.500	1.62	2.47	1.50	4.0	
16GHQ1	1-11 1/2	1.00	0.315	1.00	1.750	1.62	2.66	1.75	4.0	
20GHQ1	1 1/4-11 1/2	1.25	0.315	1.25	2.000	1.81	2.84	2.00	3.0	
24GHQ1	1 1/2-11 1/2	1.50	0.315	1.50	2.375	2.00	3.00	2.38	2.0	
32GHQ1	2-11 1/2	2.00	0.375	2.00	2.812	2.00	3.00	2.81	2.0	

**WARNING:** This product can expose you to chemicals including Lead and Lead Compounds which is known to the State of California to cause cancer and birth defects or other reproductive harm. For more information go to [www.p65warnings.ca.gov](http://www.p65warnings.ca.gov).

### G5HQ

TUBE FITTING PART #	T5 PORT THREAD UN-2B	SAE PORT DASH SIZE	FLANGE SIZE (in.)	C (in.)	D (in.)	F (in.)	H (in.)	L (in.)	R (in.)	Dynamic Pressure (x 1,000 PSI)	
										-SX	-SS
<b>SAE PORT / CODE 61 FLANGE HEAD</b>											
12G5HQ1	1 1/6-12	12	0.75	0.265	0.75	1.500	1.62	2.47	1.50	4.0	
16G5HQ1	1 5/16-12	15	1.00	0.315	1.00	1.750	1.62	2.66	1.75	3.0	
20G5HQ1	1 5/8-12	20	1.25	0.315	1.25	2.000	1.81	2.84	2.00	2.2	
24G5HQ1	1 7/8-12	24	1.50	0.315	1.50	2.375	2.00	3.00	2.38	2.5	
32G5HQ1	2 1/2-12	32	2.00	0.375	2.00	2.812	2.00	3.00	2.81	1.2	

**WARNING:** This product can expose you to chemicals including Lead and Lead Compounds which is known to the State of California to cause cancer and birth defects or other reproductive harm. For more information go to [www.p65warnings.ca.gov](http://www.p65warnings.ca.gov).

[Click here for CADs, Support Resources or to Configure Parts Online](#)

# WB1HQ1 / WB3HQ1 / WB5HQ1

Code 61 Weld Butt Flange  
Connector, Pipe  
Schedule 40, 80 or 160 Weld Butt /  
Code 61 Flange Head

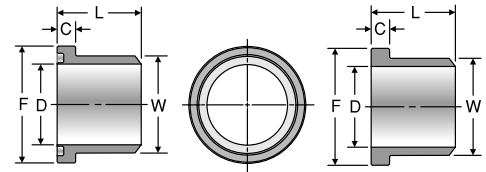

O-ring Face

Flat Face

TABLE  
OF  
CONTENTS

VISUAL  
INDEX

FAQs

GEN TECH

K

WELD BUTT FLANGE CONNECTION TYPE	TUBE FITTING PART #		PIPE SIZE (in.)	FLANGE SIZE (in.)	C (in.)	D (in.)	F (in.)	L (in.)	W (in.)	Dynamic Pressure (x 1,000 PSI)	
	O-ring FACE	FLAT FACE								-SX	-SS
<b>SCHEDULE 40 WELD BUTT / CODE 61 FLANGE HEAD</b>											
WB1HQ1 For Schedule 40 pipe	8WB1HQ1	8WB1HQ1N	1/2	0.50	0.265	0.622	1.188	1.06	0.840	5.3	
	12WB1HQ1	12WB1HQ1N	3/4	0.75	0.265	0.824	1.500	1.06	1.050	4.6	
	16WB1HQ1	16WB1HQ1N	1	1.00	0.315	1.049	1.750	1.25	1.315	4.0	
	20WB1HQ1	20WB1HQ1N	1 1/4	1.25	0.315	1.380	2.000	1.44	1.660	3.6	
	24WB1HQ1	24WB1HQ1N	1 1/2	1.50	0.315	1.610	2.375	1.75	1.900	3.0	
	32WB1HQ1	32WB1HQ1N	2	2.00	0.375	2.067	2.812	2.00	2.375	2.6	
	40WB1HQ1	40WB1HQ1N	2 1/2	2.50	0.375	2.469	3.312	2.31	2.875	2.6	
48WB1HQ1	48WB1HQ1N	3	3.00	0.375	3.068	4.000	2.32	3.500	2.3		
<b>SCHEDULE 80 WELD BUTT / CODE 61 FLANGE HEAD</b>											
WB3HQ1 For Schedule 80 pipe	8WB3HQ1	8WB3HQ1N	1/2	0.50	0.265	0.548	1.188	1.06	0.840	5.0	
	12WB3HQ1	12WB3HQ1N	3/4	0.75	0.265	0.744	1.500	1.06	1.050	3.5	
	16WB3HQ1	16WB3HQ1N	1	1.00	0.315	0.959	1.750	1.25	1.315	4.0	
	20WB3HQ1	20WB3HQ1N	1 1/4	1.25	0.315	1.280	2.000	1.44	1.660	3.5	
	24WB3HQ1	24WB3HQ1N	1 1/2	1.50	0.315	1.502	2.375	1.75	1.900	3.0	
	32WB3HQ1	32WB3HQ1N	2	2.00	0.375	1.941	2.812	2.00	2.375	3.0	
	40WB3HQ1	40WB3HQ1N	2 1/2	2.50	0.375	2.325	3.312	2.31	2.875	2.7	
48WB3HQ1	48WB3HQ1N	3	3.00	0.375	2.902	4.000	2.32	3.500	2.2		
<b>SCHEDULE 160 WELD BUTT / CODE 61 FLANGE HEAD</b>											
WB5HQ1 For Schedule 160 pipe	8WB5HQ1	8WB5HQ1N	1/2	0.50	0.265	0.464	1.188	1.06	0.840	5.0	
	12WB5HQ1	12WB5HQ1N	3/4	0.75	0.265	0.612	1.500	1.06	1.050	4.0	
	16WB5HQ1	16WB5HQ1N	1	1.00	0.315	0.815	1.750	1.25	1.315	4.5	
	20WB5HQ1	20WB5HQ1N	1 1/4	1.25	0.315	1.160	2.000	1.44	1.660	4.0	
	24WB5HQ1	24WB5HQ1N	1 1/2	1.50	0.315	1.338	2.375	1.75	1.900	3.0	
	32WB5HQ1	32WB5HQ1N	2	2.00	0.375	1.687	2.812	2.00	2.375	3.0	
	40WB5HQ1	40WB5HQ1N	2 1/2	2.50	0.375	2.125	3.312	2.31	2.875	2.5	
48WB5HQ1	48WB5HQ1N	3	3.00	0.375	2.624	4.000	2.32	3.500	2.0		

**WARNING:** This product can expose you to chemicals including Lead and Lead Compounds which is known to the State of California to cause cancer and birth defects or other reproductive harm. For more information go to [www.p65warnings.ca.gov](http://www.p65warnings.ca.gov).



[Click here for CADs, Support Resources or to Configure Parts Online](#)

## WB3HQ2 / WB5HQ2 / WB7HQ2

Code 62 Weld Butt Flange  
Connector, Pipe  
Schedule 80, 160 or  
XXS Weld Butt / Code 62  
Flange Head

TABLE  
OF  
CONTENTS

VISUAL  
INDEX

FAQs

GEN TECH

WELD BUTT FLANGE CONNECTION TYPE	TUBE FITTING PART #		PIPE SIZE (in.)	FLANGE SIZE (in.)	C (in.)	D (in.)	F (in.)	L (in.)	W (in.)	Dynamic Pressure (x 1,000 PSI)	
	O-ring FACE	FLAT FACE								-SX	-SS
<b>SCHEDULE 80 WELD BUTT / CODE 62 FLANGE HEAD</b>											
WB3HQ2 For Schedule 80 pipe	12WB3HQ2	12WB3HQ2N	3/4	0.75	0.345	0.742	1.625	1.42	1.050	5.0	
	16WB3HQ2	16WB3HQ2N	1	1.00	0.375	0.957	1.875	1.61	1.315	4.5	
	20WB3HQ2	20WB3HQ2N	1 1/4	1.25	0.405	1.278	2.125	1.73	1.660	3.5	
	24WB3HQ2	24WB3HQ2N	1 1/2	1.50	0.495	1.500	2.500	2.17	1.900	3.0	
	32WB3HQ2	32WB3HQ2N	2	2.00	0.495	1.939	3.125	2.48	2.375	3.0	
<b>SCHEDULE 160 WELD BUTT / CODE 62 FLANGE HEAD</b>											
WB5HQ2 For Schedule 160 pipe	12WB5HQ2	12WB5HQ2N	3/4	0.75	0.345	0.614	1.625	1.42	1.050	6.0	
	16WB5HQ2	16WB5HQ2N	1	1.00	0.375	0.815	1.875	1.61	1.315	5.5	
	20WB5HQ2	20WB5HQ2N	1 1/4	1.25	0.405	1.160	2.125	1.73	1.660	5.0	
	24WB5HQ2	24WB5HQ2N	1 1/2	1.50	0.495	1.337	2.500	2.17	1.900	5.0	
	32WB5HQ2	32WB5HQ2N	2	2.00	0.495	1.689	3.125	2.48	2.375	4.5	
<b>SCHEDULE XXS WELD BUTT / CODE 62 FLANGE HEAD</b>											
WB7HQ2 For Schedule XXS pipe	12WB7HQ2	12WB7HQ2N	3/4	0.75	0.345	0.434	1.625	1.42	1.050	6.0	
	16WB7HQ2	16WB7HQ2N	1	1.00	0.375	0.599	1.875	1.61	1.315	6.0	
	20WB7HQ2	20WB7HQ2N	1 1/4	1.25	0.405	0.896	2.125	1.73	1.660	6.0	
	24WB7HQ2	24WB7HQ2N	1 1/2	1.50	0.495	1.100	2.500	2.17	1.900	6.0	
	32WB7HQ2	32WB7HQ2N	2	2.00	0.495	1.503	3.125	2.48	2.375	6.0	

**WARNING:** This product can expose you to chemicals including Lead and Lead Compounds which is known to the State of California to cause cancer and birth defects or other reproductive harm. For more information go to [www.p65warnings.ca.gov](http://www.p65warnings.ca.gov).

[Click here for CADs, Support Resources or to Configure Parts Online](#)

# G5Q

SAE Port Block Adapter  
SAE Port / Code 61 or 62 Block Flange or Pad

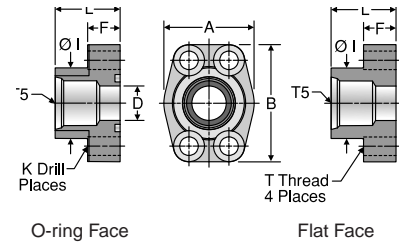

TABLE OF CONTENTS

VISUAL INDEX

FAQs

GEN TECH

TUBE FITTING PART #		SAE PORT DASH SIZE	T5 STRAIGHT THREAD UN-2B	FLANGE SIZE (in.)	A (in.)	B (in.)	D (in.)	F (in.)	I (in.)	K DRILL DIA. (in.)	L (in.)	T THREAD UNC-2B	MOUNTING HARDWARE		Dynamic Pressure (x 1,000 PSI)	
O-ring FACE	FLAT FACE												-SHCS	-SX	-SS <sup>1</sup>	
<b>SAE PORT / CODE 61 BLOCK FLANGE OR PAD</b>																
8G5Q1B	8G5Q1P	8	3/4-16	0.50	1.81	2.13	0.50	0.63	1.25	0.344	1.42	5/16-18	5/16-18 x 1.25	5.0		
12G5Q1B	12G5Q1P	12	1 1/16-12	0.75	1.97	2.56	0.75	0.71	1.54	0.406	1.42	3/8-16	3/8-16 x 1.50	4.0		
16G5Q1B	16G5Q1P	16	1 5/16-12	1.00	2.17	2.75	1.00	0.71	1.81	0.406	1.50	3/8-16	3/8-16 x 1.50	3.5		
20G5Q1B	20G5Q1P	20	1 5/8-12	1.25	2.68	3.12	1.25	0.83	2.22	0.469	1.61	7/16-14	7/16-14 x 1.75	3.0		
24G5Q1B	24G5Q1P	24	1 7/8-12	1.50	3.07	3.66	1.50	0.98	2.50	0.531	1.77	1/2-13	1/2-13 x 1.75	2.5		
<b>SAE PORT / CODE 62 BLOCK FLANGE OR PAD</b>																
8G5Q2B	8G5Q2P	8	3/4-16	0.50	1.81	2.21	0.50	0.63	1.33	0.344	1.42	5/16-18	5/16-18 x 1.25	6.0		
12G5Q2B	12G5Q2P	12	1 1/16-12	0.75	2.17	2.80	0.75	0.83	1.65	0.406	1.38	3/8-16	3/8-16 x 1.50	5.5		
16G5Q2B	16G5Q2P	16	1 5/16-12	1.00	2.56	3.19	1.00	0.98	1.98	0.409	1.65	7/16-14	7/16-14 x 1.75	4.5		
20G5Q2B	20G5Q2P	20	1 5/8-12	1.25	3.07	3.75	1.25	1.06	2.36	0.531	1.77	1/2-13	1/2-13 x 1.75	3.0		
24G5Q2B	24G5Q2P	24	1 7/8-12	1.50	3.70	4.41	1.50	1.18	2.68	0.656	1.97	5/8-11	5/8-11 x 2.25	2.7		
32G5Q2B	32G5Q2P	32	2 1/2-12	2.00	4.50	5.28	2.00	1.46	3.38	0.781	2.56	3/4-10	3/4-10 x 2.75	2.0		

1) See page K40 for standard stainless steel sizes and dimensions.

To receive mounting hardware with flange, insert a "K" after the material designator. Mounting hardware kits are available for O-ring Face part numbers and include 4 bolts, 4 lock washers and an O-ring.

**WARNING:** This product can expose you to chemicals including Lead and Lead Compounds which is known to the State of California to cause cancer and birth defects or other reproductive harm. For more information go to [www.p65warnings.ca.gov](http://www.p65warnings.ca.gov).

K

[Click here for CADs, Support Resources or to Configure Parts Online](#)

**GQ**

NPTF Port Block Adapter  
NPTF Port / Code 61 or 62 Block Flange or Pad

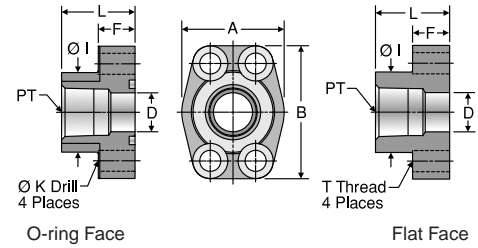

TABLE OF CONTENTS

VISUAL INDEX

FAQs

GEN TECH

TUBE FITTING PART #		PT PORT THREAD NPTF	FLANGE SIZE (in.)	A (in.)	B (in.)	D (in.)	F (in.)	I (in.)	K DRILL DIA. (in.)	L (in.)	T THREAD UNC-2B	MOUNTING HARDWARE SHCS		Dynamic Pressure (x 1,000 PSI)	
O-ring FACE	FLAT FACE											-SX	-SS'	-SX	-SS'
<b>NPTF PORT / CODE 61 BLOCK FLANGE OR PAD</b>															
8GQ1B	8GQ1P	1/2 - 14	0.50	1.81	2.13	0.50	0.63	1.25	0.344	1.42	5/16-18	5/16-18 x 1.25	5.0		
12GQ1B	12GQ1P	3/4 - 14	0.75	1.97	2.56	0.75	0.71	1.54	0.406	1.42	3/8-16	3/8-16 x 1.50	4.5		
16GQ1B	16GQ1P	1 - 11 1/2	1.00	2.17	2.75	1.00	0.71	1.81	0.406	1.50	3/8-16	3/8-16 x 1.50	4.0		
20GQ1B	20GQ1P	1 1/4 - 11 1/2	1.25	2.68	3.12	1.25	0.83	2.22	0.469	1.61	7/16-14	7/16-14 x 1.75	3.5		
24GQ1B	24GQ1P	1 1/2 - 11 1/2	1.50	3.07	3.66	1.50	0.98	2.50	0.531	1.77	1/2-13	1/2-13 x 1.75	2.7		
32GQ1B	32GQ1P	2 - 11 1/2	2.00	3.54	4.00	2.00	0.98	3.12	0.531	1.77	1/2-13	1/2-13 x 1.75	2.2		
40GQ1B	40GQ1P	2 1/2 - 8	2.50	4.09	4.49	2.50	0.98	3.62	0.531	1.97	1/2-13	1/2-13 x 1.75	2.0		
48GQ1B	48GQ1P	3 1/2 - 8	3.00	4.88	5.28	3.00	1.06	4.47	0.656	1.97	5/8-11	5/8-11 x 2.00	1.1		
<b>NPTF PORT / CODE 62 BLOCK FLANGE OR PAD</b>															
8GQ2B	8GQ2P	1/2 - 14	0.50	1.81	2.21	0.50	0.63	1.33	0.344	1.42	5/16-18	5/16-18 x 1.25	6.0		
12GQ2B	12GQ2P	3/4 - 14	0.75	2.17	2.80	0.75	0.83	1.65	0.406	1.38	3/8-16	3/8-16 x 1.50	5.0		
16GQ2B	16GQ2P	1 - 11 1/2	1.00	2.56	3.19	1.00	0.98	1.98	0.469	1.65	7/16-14	7/16-14 x 1.75	4.0		
20GQ2B	20Q2P	1 1/4 - 11 1/2	1.25	3.07	3.75	1.25	1.06	2.36	0.531	1.77	1/2-13	1/2-13 x 1.75	3.5		
24GQ2B	24GQ2P	1 1/2 - 11 1/2	1.50	3.70	4.41	1.50	1.18	2.68	0.656	1.97	5/8-11	5/8-11 x 2.25	3.0		
32GQ2B	32GQ2P	2 - 11 1/2	2.00	4.50	5.28	2.00	1.46	3.38	0.781	2.56	3/4-10	3/4-10 x 2.75	2.5		

1) See page K40 for standard stainless steel sizes and dimensions.

To receive mounting hardware with flange, insert a "K" after the material designator. Mounting hardware kits are available for O-ring Face part numbers and include 4 bolts, 4 lock washers and an O-ring.

[Click here for CADs, Support Resources or to Configure Parts Online](#)

# G4Q

BSPP Port Block Adapter  
BSPP Port / Code 61 or 62  
Block Flange or Pad

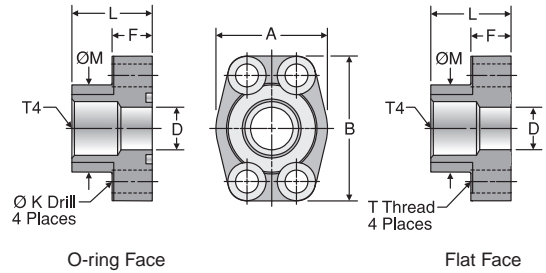

TABLE  
OF  
CONTENTS

VISUAL  
INDEX

FAQs

GEN TECH

TUBE FITTING PART #		T4 THREAD BSPP	FLANGE SIZE (in.)	A (in.)	B (in.)	D (in.)	F (in.)	K DRILL DIA. (in.)	L (in.)	M (in.)	T THREAD UNC-2B	MOUNTING HARDWARE SHCS	Dynamic Pressure (x 1,000 PSI)	
O-ring FACE	FLAT FACE												SX	SS
<b>BSPP PORT / CODE 61 BLOCK FLANGE OR PAD</b>														
8G4Q1B	8G4Q1P	1/2-14	0.50	1.81	2.13	0.502	0.63	0.344	1.42	1.25	5/16-18	5/16-18 x 1.25	5.0	
12G4Q1B	12G4Q1P	3/4-14	0.75	1.97	2.56	0.752	0.71	0.406	1.42	1.54	3/8-16	3/8-16 x 1.50	4.0	
16G4Q1B	16G4Q1P	1-11	1.00	2.17	2.75	1.002	0.71	0.406	1.50	1.81	3/8-16	3/8-16 x 1.50	3.0	
20G4Q1B	20G4Q1P	1 1/4-11	1.25	2.68	3.12	1.252	0.83	0.469	1.61	2.22	7/16-14	7/16-14 x 1.75	2.5	
24G4Q1B	24G4Q1P	1 1/2-11	1.50	3.07	3.66	1.502	0.98	0.531	1.77	2.50	1/2-13	1/2-13 x 1.75	2.2	
32G4Q1B	32G4Q1P	2-11	2.00	3.54	4.00	2.002	0.98	0.531	1.77	3.12	1/2-13	1/2-13 x 1.75	1.7	
<b>BSPP PORT / CODE 62 BLOCK FLANGE OR PAD</b>														
8G4Q2B	8G4Q2P	1/2-14	0.50	1.81	2.21	0.502	0.63	0.344	1.42	1.33	5/16-18	5/16-18 x 1.25	6.0	
12G4Q2B	12G4Q2P	3/4-14	0.75	2.17	2.80	0.752	0.83	0.406	1.38	1.65	3/8-16	3/8-16 x 1.50	5.0	
16G4Q2B	16G4Q2P	1-11	1.00	2.56	3.19	1.002	0.98	0.492	1.65	1.98	7/16-14	7/16-14 x 1.75	4.0	
20G4Q2B	20G4Q2P	1 1/4-11	1.25	3.07	3.75	1.252	1.06	0.531	1.77	2.36	1/2-13	1/2-13 x 1.75	3.0	
24G4Q2B	24G4Q2P	1 1/2-11	1.50	3.70	4.41	1.502	1.18	0.656	1.97	2.68	5/8-11	5/8-11 x 2.25	2.5	
32G4Q2B	32G4Q2P	2-11	2.00	4.50	5.28	2.002	1.46	0.781	2.56	3.35	3/4-10	3/4-10 x 2.75	2.0	

To receive mounting hardware with flange, insert a "K" after the material designator. Mounting hardware kits are available for O-ring Face part numbers and include 4 bolts, 4 lock washers and an O-ring.

**WARNING:** This product can expose you to chemicals including Lead and Lead Compounds which is known to the State of California to cause cancer and birth defects or other reproductive harm. For more information go to [www.p65warnings.ca.gov](http://www.p65warnings.ca.gov).

**K**

[Click here for CADs, Support Resources or to Configure Parts Online](#)

# W5Q

Flat Weld Socket Block Connector, Pipe  
Flat Weld Socket, Pipe / Code 61 or 62  
Block Flange or Pad

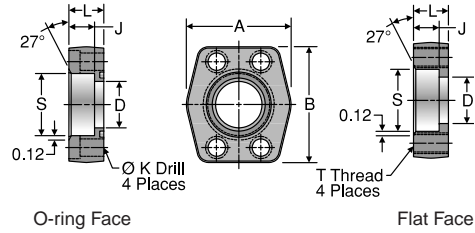

TABLE  
OF  
CONTENTS

VISUAL  
INDEX

FAQs

GEN TECH

TUBE FITTING PART #		PIPE SIZE (in.)	FLANGE SIZE (in.)	A (in.)	B (in.)	D (in.)	J (in.)	K DRILL DIA. (in.)	L (in.)	S (in.)	T THREAD UNC-2B	MOUNTING HARDWARE SHCS	Dynamic Pressure (x 1,000 PSI)	
O-ring FACE	FLAT FACE												-SX	-SS'
<b>FLAT WELD SOCKET, PIPE / CODE 61 BLOCK FLANGE OR PAD</b>														
8W5Q1B	8W5Q1P	1/2	0.50	1.813	2.125	0.502	0.560	0.344	0.750	0.855	5/16-18	5/16-18 x 1.50	5.0	
12W5Q1B	12W5Q1P	3/4	0.75	2.063	2.563	0.752	0.560	0.406	0.750	1.062	3/8-16	3/8-16 x 1.50	5.0	
16W5Q1B	16W5Q1P	1	1.00	2.313	2.750	1.002	0.630	0.406	0.880	1.328	3/8-16	3/8-16 x 1.75	5.0	
20W5Q1B	20W5Q1P	1 1/4	1.25	2.875	3.125	1.252	0.690	0.469	0.940	1.672	7/16-14	7/16-14 x 1.75	4.0	
24W5Q1B	24W5Q1P	1 1/2	1.50	3.250	3.688	1.502	0.750	0.531	1.190	1.922	1/2-13	1/2-13 x 2.25	3.0	
32W5Q1B	32W5Q1P	2	2.00	3.813	4.000	2.002	0.875	0.531	1.380	2.406	1/2-13	1/2-13 x 2.50	3.0	
40W5Q1B	40W5Q1P	2 1/2	2.50	4.281	4.500	2.502	1.000	0.531	1.750	2.906	1/2-13	1/2-13 x 2.75	2.5	
48W5Q1B	48W5Q1P	3	3.00	5.156	5.313	3.000	1.250	0.656	2.120	3.547	5/8-11	5/8-11 x 3.50	2.0	
56W5Q1B	56W5Q1P	3 1/2	3.50	5.500	6.000	3.500	1.190	0.656	1.440	4.047	5/8-11	5/8-11 x 2.75	0.5	
64W5Q1B	64W5Q1P	4	4.00	6.000	6.380	4.000	1.250	0.656	1.500	4.578	5/8-11	5/8-11 x 2.75	0.5	
80W5Q1B	80W5Q1P	5	5.00	7.120	7.250	4.500	1.380	0.656	1.750	5.641	5/8-11	5/8-11 x 3.00	0.5	
<b>FLAT WELD SOCKET, PIPE / CODE 62 BLOCK FLANGE OR PAD</b>														
8W5Q2B	8W5Q2P	1/2	0.50	1.940	2.300	0.502	0.560	0.344	1.250	0.855	5/16-18	5/16-18 x 2.00	6.0	
12W5Q2B	12W5Q2P	3/4	0.75	2.500	2.950	0.752	0.560	0.406	1.250	1.062	3/8-16	3/8-16 x 2.00	6.0	
16W5Q2B	16W5Q2P	1	1.00	2.750	3.190	1.002	0.630	0.469	1.500	1.328	7/16-14	7/16-14 x 2.50	6.0	
20W5Q2B	20W5Q2P	1 1/4	1.25	3.060	3.750	1.252	0.690	0.531	1.500	1.672	1/2-13	1/2-13 x 2.50	6.0	
24W5Q2B	24W5Q2P	1 1/2	1.50	3.750	4.440	1.502	0.750	0.656	1.750	1.922	5/8-11	5/8-11 x 3.00	6.0	
32W5Q2B	32W5Q2P	2	2.00	4.500	5.250	2.002	0.875	0.781	1.750	2.406	3/4-10	3/4-10 x 3.00	6.0	
40W5Q2B <sup>2</sup>	40W5Q2P <sup>2</sup>	2 1/2	2.50	5.870	6.870	2.502	1.000	0.906	2.060	2.906	7/8-9	7/8-9 x 3.50	3.0	
48W5Q2B <sup>2</sup>	48W5Q2P <sup>2</sup>	3	3.00	7.000	8.500	3.002	1.250	1.156	2.620	3.547	1 1/8-7	1 1/8-7 x 4.50	3.0	

- 1) See page K41 for standard stainless steel sizes and dimensions.
- 2) Not covered in SAE J518. Bolt hole centerline dimensions are: 2.312" x 4.875" for 40W5Q2 and 2.812" x 6.000" for 48W5Q2.

To receive mounting hardware with flange, insert a "K" after the material designator. Mounting hardware kits are available for O-ring Face part numbers and include 4 bolts, 4 lock washers and an O-ring.



[Click here for CADs, Support Resources or to Configure Parts Online](#)

# W4Q

Flat Weld Socket Block Connector, Tube  
Flat Weld Socket, Tube / Code 61 or 62  
Block Flange or Pad

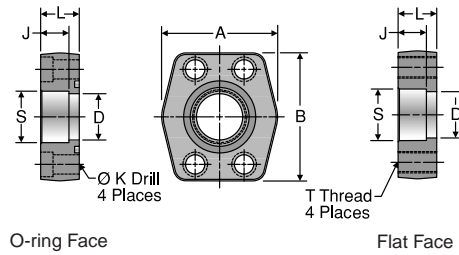

TABLE OF CONTENTS

VISUAL INDEX

FAQs

GEN TECH

K

TUBE FITTING PART #		TUBE O.D. (in.)	FLANGE SIZE (in.)	A (in.)	B (in.)	D (in.)	J (in.)	K DRILL DIA. (in.)	L (in.)	S (in.)	T THREAD UNC-2B	MOUNTING HARDWARE SHCS	Dynamic Pressure (x 1,000 PSI)	
O-ring FACE	FLAT FACE												-SX	-SS
<b>FLAT WELD SOCKET, TUBE / CODE 61 BLOCK FLANGE OR PAD</b>														
12W4Q1B	12W4Q1P	3/4	0.75	2.06	2.56	0.625	0.560	0.406	0.750	0.752	3/8-16	3/8-16 x 1.50	5.0	
16-12W4Q1B	16-12W4Q1P	1	0.75	2.06	2.56	0.750	0.560	0.406	0.750	1.002	3/8-16	3/8-16 x 1.50	5.0	
16W4Q1B	16W4Q1P	1	1.00	2.31	2.75	0.875	0.630	0.406	0.880	1.002	3/8-16	3/8-16 x 1.75	5.0	
20-16W4Q1B	20-16W4Q1P	1 1/4	1.00	2.31	2.75	1.000	0.630	0.406	0.880	1.252	3/8-16	3/8-16 x 1.75	5.0	
20W4Q1B	20W4Q1P	1 1/4	1.25	2.88	3.12	1.125	0.690	0.469	0.940	1.252	7/16-14	7/16-14 x 1.75	4.0	
24-20W4Q1B	24-20W4Q1P	1 1/2	1.25	2.88	3.12	1.250	0.690	0.469	0.940	1.502	7/16-14	7/16-14 x 1.75	4.0	
24W4Q1B	24W4Q1P	1 1/2	1.50	3.25	3.69	1.375	0.750	0.531	1.190	1.502	1/2-13	1/2-13 x 2.25	3.0	
28-24W4Q1B	28-24W4Q1P	1 3/4	1.50	3.25	3.69	1.500	0.750	0.531	1.190	1.752	1/2-13	1/2-13 x 2.25	3.0	
32W4Q1B	32W4Q1P	2	2.00	3.81	4.00	1.875	0.875	0.531	1.375	2.002	1/2-13	1/2-13 x 2.50	3.0	
36-32W4Q1B	36-32W4Q1P	2 1/4	2.00	3.81	4.00	2.000	0.875	0.531	1.375	2.252	1/2-13	1/2-13 x 2.50	3.0	
<b>FLAT WELD SOCKET, TUBE / CODE 62 BLOCK FLANGE OR PAD</b>														
12W4Q2B	12W4Q2P	3/4	0.75	2.38	2.81	0.625	0.560	0.406	1.250	0.752	3/8-16	3/8-16 x 2.00	6.0	
16-12W4Q2B	16-12W4Q2P	1	0.75	2.38	2.81	0.750	0.560	0.406	1.250	1.002	3/8-16	3/8-16 x 2.00	6.0	
16W4Q2B	16W4Q2P	1	1.00	2.75	3.19	0.875	0.630	0.469	1.500	1.002	7/16-14	7/16-14 x 2.25	6.0	
20-16W4Q2B	20-16W4Q2P	1 1/4	1.00	2.75	3.19	1.000	0.630	0.469	1.500	1.252	7/16-14	7/16-14 x 2.25	6.0	
20W4Q2B	20W4Q2P	1 1/4	1.25	3.06	3.75	1.125	0.690	0.531	1.500	1.252	1/2-13	1/2-13 x 2.50	6.0	
24-20W4Q2B	24-20W4Q2P	1 1/5	1.25	3.06	3.75	1.250	0.690	0.531	1.500	1.502	1/2-13	1/2-13 x 2.50	6.0	
24W4Q2B	24W4Q2P	1 1/2	1.50	3.75	4.44	1.375	0.750	0.656	1.750	1.502	5/8-11	5/8-11 x 2.75	6.0	
28-24W4Q2B	28-24W4Q2P	1 3/4	1.50	3.75	4.44	1.500	0.750	0.656	1.750	1.752	5/8-11	5/8-11 x 2.75	6.0	
32W4Q2B1 <sup>1</sup>	32W4Q2P1 <sup>1</sup>	2	2.00	4.50	5.25	1.875	0.875	0.781	1.750	2.002	3/4-10	3/4-10 x 3.00	6.0	
36-32W4Q2B1 <sup>1</sup>	36-32W4Q2P1 <sup>1</sup>	2 1/4	2.00	4.50	5.25	2.000	0.875	0.781	1.750	2.252	3/4-10	3/4-10 x 3.00	6.0	

1) Not covered in SAE J518.

To receive mounting hardware with flange, insert a "K" after the material designator. Mounting hardware kits are available for O-ring Face part numbers and include 4 bolts, 4 lock washers and an O-ring.

[Click here for CADs, Support Resources or to Configure Parts Online](#)

# W7Q

Extended Weld Socket Block Connector, Pipe  
Deep Weld Socket, Pipe / Code 61 or 62  
Block Flange or Pad

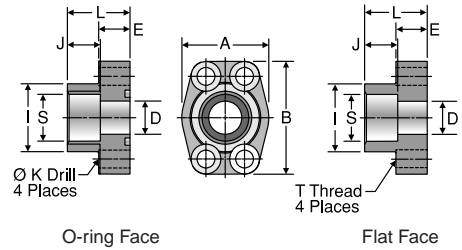

TABLE OF CONTENTS

VISUAL INDEX

FAQs

GEN TECH

TUBE FITTING PART #		PIPE SIZE (in.)	FLANGE SIZE (in.)	A (in.)	B (in.)	D (in.)	E (in.)	I (in.)	J (in.)	K DRILL DIA. (in.)	L (in.)	S (in.)	T THREAD UNC-2B	MOUNTING HARDWARE SHCS	Dynamic Pressure (x 1,000 PSI)	
O-ring FACE	FLAT FACE														-SX	-SS
<b>EXTENDED WELD SOCKET, PIPE / CODE 61 BLOCK FLANGE OR PAD</b>																
12W7Q1B	12W7Q1P	3/4	0.75	1.97	2.56	0.75	0.710	1.54	0.750	0.406	1.420	1.062	3/8-16	3/8-16 x 1.50	5.0	
16W7Q1B	16W7Q1P	1	1.00	2.17	2.75	1.00	0.710	1.81	0.750	0.406	1.500	1.328	3/8-16	3/8-16 x 1.50	4.5	
20W7Q1B	20W7Q1P	1 1/4	1.25	2.68	3.12	1.25	0.830	2.22	0.870	0.469	1.610	1.672	7/16-14	7/16-14 x 1.75	2.7	
24W7Q1B	24W7Q1P	1 1/2	1.50	3.07	3.66	1.50	0.980	2.50	0.940	0.531	1.770	1.922	1/2-13	1/2-13 x 1.75	3.0	
32W7Q1B	32W7Q1P	2	2.00	3.54	4.00	2.00	0.980	3.12	1.020	0.531	1.770	2.406	1/2-13	1/2-13 x 1.75	2.5	
40W7Q1B	40W7Q1P	2 1/2	2.50	4.09	4.49	2.50	0.980	3.62	1.180	0.531	1.970	2.908	1/2-13	1/2-13 x 1.75	2.2	
<b>EXTENDED WELD SOCKET, PIPE / C ODE 62 BLOCK FLANGE OR PAD</b>																
12W7Q2B	12W7Q2P	3/4	0.75	2.17	2.80	0.75	0.830	1.65	0.870	0.406	1.380	1.062	3/8-16	3/8-16 x 1.50	6.0	
16W7Q2B	16W7Q2P	1	1.00	2.56	3.19	1.00	0.980	1.98	0.870	0.469	1.650	1.328	7/16-14	7/16-14 x 1.75	6.0	
20W7Q2B	20W7Q2P	1 1/4	1.25	3.07	3.75	1.25	1.060	2.36	0.980	0.531	1.770	1.672	1/2-13	1/2-13 x 1.75	5.5	
24W7Q2B	24W7Q2P	1 1/2	1.50	3.7	4.41	1.50	1.180	2.68	1.100	0.656	1.970	1.922	5/8-11	5/8-11 x 2.25	5.5	
32W7Q2B	32W7Q2P	2	2.00	4.5	5.28	2.00	1.460	3.35	0.940	0.781	2.560	2.406	3/4-10	3/4-10 x 2.75	5.0	

To receive mounting hardware with flange, insert a "K" after the material designator. Mounting hardware kits are available for O-ring Face part numbers and include 4 bolts, 4 lock washers and an O-ring.

[Click here for CADs, Support Resources or to Configure Parts Online](#)

# W6Q

Extended Weld Socket Block Connector, Tube  
Deep Weld Socket, Tube / Code 61 or 62  
Block Flange or Pad

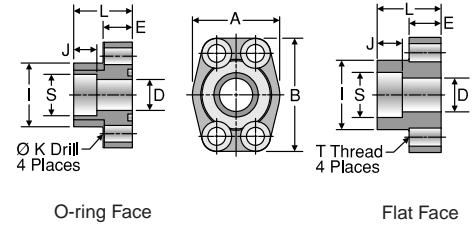

TABLE  
OF  
CONTENTS

VISUAL  
INDEX

FAQs

GEN TECH

K

TUBE FITTING PART #		TUBE O.D.	FLANGE SIZE	A	B	D	E	I	J	K DRILL DIA.	L	S	T THREAD	MOUNTING HARDWARE	Dynamic Pressure (x 1,000 PSI)	
O-ring FACE	FLAT FACE	(in.)	(in.)	(in.)	(in.)	(in.)	(in.)	(in.)	(in.)	(in.)	(in.)	(in.)	UNC-2B	SHCS	-SX	-SS
<b>EXTENDED WELD SOCKET, TUBE / CODE 61 BLOCK FLANGE OR PAD</b>																
12W6Q1B	12W6Q1P	3/4	0.75	1.97	2.56	0.625	0.71	1.54	0.560	0.406	1.420	0.752	3/8-16	3/8-16 x 1.50	5.0	
16-12W6Q1B	16-12W6Q1P	1	0.75	1.97	2.56	0.750	0.71	1.54	0.560	0.406	1.420	1.002	3/8-16	3/8-16 x 1.50	5.0	
16W6Q1B	16W6Q1P	1	1.00	2.17	2.75	0.875	0.71	1.81	0.630	0.406	1.500	1.002	3/8-16	3/8-16 x 1.50	5.0	
20-16W6Q1B	20-16W6Q1P	1 1/4	1.00	2.17	2.75	1.000	0.71	1.81	0.630	0.406	1.500	1.252	3/8-16	3/8-16 x 1.50	5.0	
20W6Q1B	20W6Q1P	1 1/4	1.25	2.68	3.12	1.125	0.83	2.22	0.690	0.469	1.610	1.252	7/16-14	7/16-14 x 1.75	4.0	
24-20W6Q1B	24-20W6Q1P	1 1/2	1.25	2.68	3.12	1.250	0.83	2.22	0.690	0.469	1.610	1.502	7/16-14	7/16-14 x 1.75	4.0	
24W6Q1B	24W6Q1P	1 1/2	1.50	3.07	3.66	1.375	0.98	2.50	0.750	0.531	1.770	1.502	1/2-13	1/2-13 x 1.75	3.0	
28-24W6Q1B	28-24W6Q1P	1 3/4	1.50	3.07	3.66	1.500	0.98	2.50	0.750	0.531	1.770	1.752	1/2-13	1/2-13 x 1.75	3.0	
32W6Q1B	32W6Q1P	2	2.00	3.54	4.00	1.875	0.98	3.12	0.870	0.531	1.770	2.002	1/2-13	1/2-13 x 1.75	3.0	
36-32W6Q1B	36-32W6Q1P	2 1/4	2.00	3.54	4.00	2.000	0.98	3.12	0.870	0.531	1.770	2.252	1/2-13	1/2-13 x 1.75	3.0	
40W6Q1B	40W6Q1P	2 1/2	2.50	4.09	4.49	2.375	0.98	3.62	1.000	0.531	1.970	2.502	1/2-13	1/2-13 x 1.75	2.5	
44-40W6Q1B	44-40W6Q1P	2 3/4	2.50	4.09	4.49	2.500	0.98	3.62	1.000	0.531	1.970	2.752	1/2-13	1/2-13 x 1.75	2.2	
<b>EXTENDED WELD SOCKET, TUBE / CODE 62 BLOCK FLANGE OR PAD</b>																
12W6Q2B	12W6Q2P	3/4	0.75	2.17	2.80	0.625	0.83	1.65	0.560	0.406	1.380	0.752	3/8-16	3/8-16 x 1.50	6.0	
16-12W6Q2B	16-12W6Q2P	1	0.75	2.17	2.80	0.750	0.83	1.65	0.560	0.406	1.380	1.002	3/8-16	3/8-16 x 1.50	6.0	
16W6Q2B	16W6Q2P	1	1.00	2.56	3.19	0.875	0.98	1.98	0.630	0.469	1.650	1.002	7/16-14	7/16-14 x 1.75	6.0	
20-16W6Q2B	20-16W6Q2P	1 1/4	1.00	2.56	3.19	1.000	0.98	1.98	0.630	0.469	1.650	1.252	7/16-14	7/16-14 x 1.75	6.0	
20W6Q2B	20W6Q2P	1 1/4	1.25	3.07	3.75	1.125	1.06	2.36	0.690	0.531	1.770	1.252	1/2-13	1/2-13 x 1.75	6.0	
24-20W6Q2B	24-20W6Q2P	1 1/2	1.25	3.07	3.75	1.250	1.06	2.36	0.690	0.531	1.770	1.502	1/2-13	1/2-13 x 1.75	6.0	
24W6Q2B	24W6Q2P	1 1/2	1.50	3.70	4.41	1.375	1.18	2.68	0.750	0.656	1.970	1.502	5/8-11	5/8-11 x 2.25	6.0	
28-24W6Q2B	28-24W6Q2P	1 3/4	1.50	3.70	4.41	1.500	1.18	2.68	0.750	0.656	1.970	1.752	5/8-11	5/8-11 x 2.25	6.0	
32W6Q2B	32W6Q2P	2	2.00	4.50	5.28	1.875	1.46	3.35	0.870	0.781	2.560	2.002	3/4-10	3/4-10 x 2.75	6.0	
36-32W6Q2B	36-32W6Q2P	2 1/4	2.00	4.50	5.28	2.000	1.46	3.35	0.870	0.781	2.560	2.252	3/4-10	3/4-10 x 2.75	5.5	

To receive mounting hardware with flange, insert a "K" after the material designator. Mounting hardware kits are available for O-ring Face part numbers and include 4 bolts, 4 lock washers and an O-ring.

[Click here for CADs, Support Resources or to Configure Parts Online](#)

# WB1Q1 / WB3Q1 / WB5Q1

Code 61 Weld Butt Block Connector, Pipe  
Schedule 40, 80 or 160 Weld Butt /  
Code 61 Block Flange or Pad

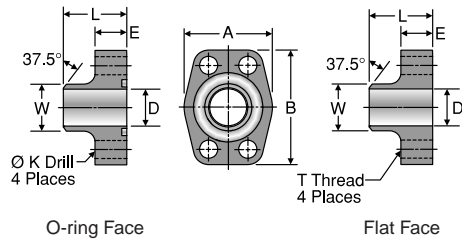

TABLE  
OF  
CONTENTS

VISUAL  
INDEX

FAQs

GEN TECH

WELD BUTT BLOCK CONNECTION TYPE	TUBE FITTING PART #		PIPE SIZE (in.)	FLANGE SIZE (in.)	A (in.)	B (in.)	D PIPE I.D. (in.)	E (in.)	K DRILL DIA. (in.)	L (in.)	T THREAD UNC-2B	W PIPE O.D. (in.)	MOUNTING HARDWARE		Dynamic Pressure (x 1,000 PSI)	
	O-ring FACE	FLAT FACE											SHCS	-SX	-SS	
<b>SCHEDULE 40 WELD BUTT / CODE 61 BLOCK FLANGE OR PAD</b>																
WB1Q1 For Schedule 40 pipe	12WB1Q1B	12WB1Q1P	3/4	0.75	1.97	2.56	0.846	0.710	0.406	1.420	3/8-16	1.050	3/8-16 x 1.50	3.5		
	16WB1Q1B	16WB1Q1P	1	1.00	2.17	2.75	1.051	0.710	0.406	1.500	3/8-16	1.315	3/8-16 x 1.50	3.0		
	20WB1Q1B	20WB1Q1P	1 1/4	1.25	2.68	3.12	1.382	0.830	0.469	1.610	7/16-14	1.660	7/16-14 x 1.75	2.7		
	24WB1Q1B	24WB1Q1P	1 1/2	1.50	3.07	3.66	1.612	0.980	0.531	1.730	1/2-13	1.900	1/2-13 x 1.75	2.2		
	32WB1Q1B	32WB1Q1P	2	2.00	3.54	4.00	2.069	0.980	0.531	1.770	1/2-13	2.375	1/2-13 x 1.75	2.0		
	40WB1Q1B	40WB1Q1P	2 1/2	2.50	4.09	4.49	2.471	0.980	0.531	1.970	1/2-13	2.875	1/2-13 x 1.75	2.0		
	48WB1Q1B	48WB1Q1P	3	3.00	4.88	5.28	3.070	1.060	0.656	1.970	5/8-11	3.500	5/8-11 x 2.00	1.7		
<b>SCHEDULE 80 WELD BUTT / CODE 61 BLOCK FLANGE OR PAD</b>																
WB3Q1 For Schedule 80 pipe	12WB3Q1B	12WB3Q1P	3/4	0.75	1.97	2.56	0.744	0.710	0.406	1.420	3/8-16	1.050	3/8-16 x 1.50	5.0		
	16WB3Q1B	16WB3Q1P	1	1.00	2.17	2.75	0.959	0.710	0.406	1.500	3/8-16	1.315	3/8-16 x 1.50	4.5		
	20WB3Q1B	20WB3Q1P	1 1/4	1.25	2.68	3.12	1.280	0.830	0.469	1.610	7/16-14	1.660	7/16-14 x 1.75	4.0		
	24WB3Q1B	24WB3Q1P	1 1/2	1.50	3.07	3.66	1.502	0.980	0.531	1.730	1/2-13	1.900	1/2-13 x 1.75	3.0		
	32WB3Q1B	32WB3Q1P	2	2.00	3.54	4.00	1.941	0.980	0.531	1.770	1/2-13	2.375	1/2-13 x 1.75	3.0		
	40WB3Q1B	40WB3Q1P	2 1/2	2.50	4.09	4.49	2.325	0.980	0.531	1.970	1/2-13	2.875	1/2-13 x 1.75	2.5		
	48WB3Q1B	48WB3Q1P	3	3.00	4.88	5.28	2.902	1.060	0.656	1.970	5/8-11	3.500	5/8-11 x 2.00	2.0		
<b>SCHEDULE 160 WELD BUTT / CODE 61 BLOCK FLANGE OR PAD</b>																
WB5Q1 For Schedule 160 pipe	12WB5Q1B	12WB5Q1P	3/4	0.75	1.97	2.56	0.614	0.710	0.406	1.420	3/8-16	1.050	3/8-16 x 1.50	5.0		
	16WB5Q1B	16WB5Q1P	1	1.00	2.17	2.75	0.817	0.710	0.406	1.500	3/8-16	1.315	3/8-16 x 1.50	5.0		
	20WB5Q1B	20WB5Q1P	1 1/4	1.25	2.68	3.12	1.162	0.830	0.469	1.610	7/16-14	1.660	7/16-14 x 1.75	4.0		
	24WB5Q1B	24WB5Q1P	1 1/2	1.50	3.07	3.66	1.340	0.980	0.531	1.730	1/2-13	1.900	1/2-13 x 1.75	3.0		
	32WB5Q1B	32WB5Q1P	2	2.00	3.54	4.00	1.689	0.980	0.531	1.770	1/2-13	2.375	1/2-13 x 1.75	3.0		
	40WB5Q1B	40WB5Q1P	2 1/2	2.50	4.09	4.49	2.127	0.980	0.531	1.970	1/2-13	2.875	1/2-13 x 1.75	2.5		
	48WB5Q1B	48WB5Q1P	3	3.00	4.88	5.28	2.626	1.060	0.656	1.970	5/8-11	3.500	5/8-11 x 2.00	2.0		

To receive mounting hardware with flange, insert a "K" after the material designator. Mounting hardware kits are available for O-ring Face part numbers and include 4 bolts, 4 lock washers and an O-ring.

[Click here for CADs, Support Resources or to Configure Parts Online](#)

## WB3Q2 / WB5Q2 / WB7Q2

Code 62 Weld Butt Block Connector, Pipe  
Schedule 80, 160 or XXS Weld Butt /  
Code 62 Block Flange or Pad

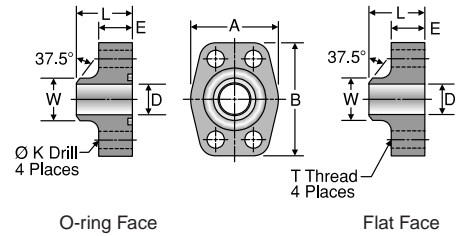

TABLE  
OF  
CONTENTS

VISUAL  
INDEX

FAQs

GEN TECH

WELD BUTT BLOCK CONNECTION TYPE	TUBE FITTING PART #		PIPE SIZE (in.)	FLANGE SIZE (in.)	A (in.)	B (in.)	D PIPE I.D. (in.)	E (in.)	K DRILL DIA. (in.)	L (in.)	T THREAD UNC-2B	W PIPE O.D. (in.)	MOUNTING HARDWARE SHCS	Dynamic Pressure (x 1,000 PSI)	
	O-ring FACE	FLAT FACE												-SX	-SS
<b>SCHEDULE 80 WELD BUTT / CODE 62 BLOCK FLANGE OR PAD</b>															
WB3Q2 For Schedule 80 pipe	12WB3Q2B	12WB3Q2P	3/4	0.75	2.17	2.80	0.744	0.83	0.406	1.38	3/8-16	1.050	3/8-16 x 1.50	5.0	
	16WB3Q2B	16WB3Q2P	1	1.00	2.56	3.19	0.959	0.83	0.469	1.61	7/16-14	1.315	7/16-14 x 1.75	4.5	
	20WB3Q2B	20WB3Q2P	1 1/4	1.25	3.07	3.75	1.280	0.98	0.531	1.73	1/2-13	1.660	1/2-13 x 1.75	3.5	
	24WB3Q2B	24WB3Q2P	1 1/2	1.50	3.70	4.41	1.502	1.18	0.656	2.17	5/8-11	1.900	5/8-11 x 2.25	3.0	
	32WB3Q2B	32WB3Q2P	2	2.00	4.50	5.28	1.941	1.46	0.781	2.56	3/4-10	2.375	3/4-10 x 2.75	3.0	
<b>SCHEDULE 160 WELD BUTT / CODE 62 BLOCK FLANGE OR PAD</b>															
WB5Q2 For Schedule 160 pipe	12WB5Q2B	12WB5Q2P	3/4	0.75	2.17	2.80	0.614	0.83	0.406	1.38	3/8-16	1.050	3/8-16 x 1.50	6.0	
	16WB5Q2B	16WB5Q2P	1	1.00	2.56	3.19	0.817	0.83	0.469	1.61	7/16-14	1.315	7/16-14 x 1.75	6.0	
	20WB5Q2B	20WB5Q2P	1 1/4	1.25	3.07	3.75	1.162	0.98	0.531	1.73	1/2-13	1.660	1/2-13 x 1.75	5.0	
	24WB5Q2B	24WB5Q2P	1 1/2	1.50	3.70	4.41	1.340	1.18	0.656	2.17	5/8-11	1.900	5/8-11 x 2.25	5.0	
	32WB5Q2B	32WB5Q2P	2	2.00	4.50	5.28	1.689	1.46	0.781	2.56	3/4-10	2.375	3/4-10 x 2.75	6.0	
<b>SCHEDULE XXS WELD BUTT / CODE 62 BLOCK FLANGE OR PAD</b>															
WB7Q2 For Schedule XXS pipe	12WB7Q2B	12WB7Q2P	3/4	0.75	2.17	2.80	0.436	0.83	0.406	1.38	3/8-16	1.050	3/8-16 x 1.50	6.0	
	16WB7Q2B	16WB7Q2P	1	1.00	2.56	3.19	0.601	0.83	0.469	1.61	7/16-14	1.315	7/16-14 x 1.75	6.0	
	20WB7Q2B	20WB7Q2P	1 1/4	1.25	3.07	3.75	0.898	0.98	0.531	1.73	1/2-13	1.660	1/2-13 x 1.75	6.0	
	24WB7Q2B	24WB7Q2P	1 1/2	1.50	3.70	4.41	1.102	1.18	0.656	2.17	5/8-11	1.900	5/8-11 x 2.25	6.0	
	32WB7Q2B	32WB7Q2P	2	2.00	4.50	5.28	1.505	1.46	0.781	2.56	3/4-10	2.375	3/4-10 x 2.75	6.0	

1) SAE J518 does not cover these sizes in Code 62.

To receive mounting hardware with flange, insert a "K" after the material designator. Mounting hardware kits are available for O-ring Face part numbers and include 4 bolts, 4 lock washers and an O-ring.

K



[Click here for CADs, Support Resources or to Configure Parts Online](#)

# AS3 / AS6

SAE-Flange / Weld Butt

For metric tube welded connection

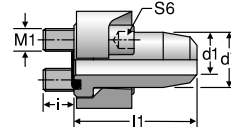

TABLE OF CONTENTS

VISUAL INDEX

FAQs

GEN TECH

TUBE FITTING PART #	SIZE (in.)	TUBE O.D. x WALL THICKNESS (mm)	WORKING PRESSURE (bar)	d1 (mm)	d7 (mm)	l (mm)	l1 (mm)	S6 (mm)	WELD NIPPLE BODY	FROM STOCK CF	71
<b>SAE FLANGE CONNECTION – CODE 61 – STANDARD SERIES</b>											
AS32/15X2	1/2	15 x 2	200	11	23.9	11.5	38	6	AS32/15X2X		
AS32/16X3	1/2	16 x 3	220	10	23.9	11.5	38	6	AS32/16X3X		
AS33/18X1.5	3/4	18 x 1.5	130	15	31.8	15.5	50	8	AS33/18X1.5X		
AS33/22X2	3/4	22 x 2	140	18	31.8	15.5	50	8	AS33/22X2X		
AS33/20X3	3/4	20 x 3	220	14	31.8	15.5	50	8	AS33/20X3X		
AS33/25X4	3/4	25 x 4	220	17	31.8	15.5	50	8	AS33/25X4X		
AS34/28X2	1	28 x 2	115	24	38	13.5	50	8	AS34/28X2X		
AS34/30X4.5	1	30 x 4.5	220	21	38	13.5	50	8	AS34/30X4.5X		
AS35/35X2	1 1/4	35 x 2	90	31	43	18.5	55	8	AS35/35X2X		
AS35/25X3	1 1/4	25 x 3	175	19	43	18.5	55	8	AS35/25X3X		
AS35/30X4	1 1/4	30 x 4	175	22	43	18.5	55	8	AS35/30X4X		
AS35/38X5	1 1/4	38 x 5	175	28	43	18.5	55	8	AS35/38X5X		
AS36/42X3	1 1/2	42 x 3	115	36	50	18.5	57	10	AS36/42X3X		
AS36/38X4	1 1/2	38 x 4	130	30	50	18.5	57	10	AS36/38X4X		
AS38/50X6	2	50 x 6	130	38	62	24	62	12	AS38/50X6X		
AS38/65X8	2	65 x 8	130	49	65	24	62	12	AS38/65X8X		
<b>SAE FLANGE CONNECTION – CODE 62 – HIGH PRESSURE SERIES</b>											
AS62/16X3	1/2	16 x 3	260	10	23.9	13.5	41	6	AS62/16X3X		
AS63/25X5	3/4	25 x 5	260	15	31.8	15.5	55	8	AS63/25X5X		
AS64/25X5	1	25 x 5	260	15	38	20.5	67	10	AS64/25X5X		
AS64/30X4	1	30 x 4	200	22	38	20.5	67	10	AS64/30X4X		
AS65/30X4*	1 1/4	30 x 4	200	22	43.7	17.5	78	10	AS65/30X4X		
AS65/38X5	1 1/4	38 x 5	200	28	43.7	17.5	78	10	AS65/38X5X		
AS65/38X8*	1 1/4	38 x 8	260	22	43.7	17.5	78	10	AS65/38X8X		
AS66/38X5	1 1/2	38 x 5	200	28	50.8	24.5	85	14	AS66/38X5X		
AS66/38X8	1 1/2	38 x 8	260	22	50.8	24.5	85	14	AS66/38X8X		
AS68/50X9	2	50 x 9	260	32	66.6	32.5	116	17	AS68/50X9X		
AS68/65X9	2	65 x 9	190	49	66.6	32.5	116	17	AS68/65X8X		

\* Identical types.

Tightening torques for socket head cap screws see Tables R6 and R7.

**WARNING:** This product can expose you to chemicals including Lead and Lead Compounds which is known to the State of California to cause cancer and birth defects or other reproductive harm. For more information go to [www.p65warnings.ca.gov](http://www.p65warnings.ca.gov).

## WBT

Code 61 Weld Butt Tank Adapter

Weld Butt with Pilot / Code 61 Block Flange Pad

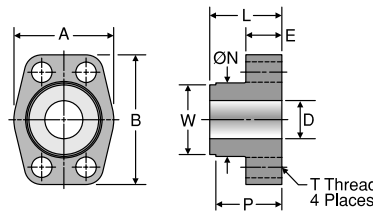

TUBE FITTING PART #	FLANGE SIZE (in.)	A (in.)	B (in.)	D (in.)	E (in.)	L (in.)	P (in.)	ØN (in.)	T THREAD UNC-2B	W (in.)	Dynamic Pressure (x 1,000 PSI)	
											-S	-SS
12WBTQ1P	0.75	1.97	2.56	0.75	0.71	1.42	1.30	1.45	3/8-16	1.375	0.5	
16WBTQ1P	1.00	2.17	2.75	1.00	0.71	1.50	1.37	1.81	3/8-16	1.500	0.5	
20WBTQ1P	1.25	2.68	3.12	1.25	0.83	1.61	1.49	2.22	7/16-14	1.750	0.5	
24WBTQ1P	1.50	3.07	3.66	1.50	0.98	1.77	1.64	2.50	1/2-13	2.125	0.5	
32WBTQ1P	2.00	3.54	4.00	2.00	0.98	1.77	1.65	3.12	1/2-13	2.500	0.5	
40WBTQ1P	2.50	4.09	4.50	2.50	0.98	1.97	1.85	3.62	1/2-13	3.250	0.5	

[Click here for CADs, Support Resources or to Configure Parts Online](#)

## WSD

Code 61 Weld Saddle Block Connector  
Pipe or Tube Weld Saddle /  
Code 61 Block Flange or Pad

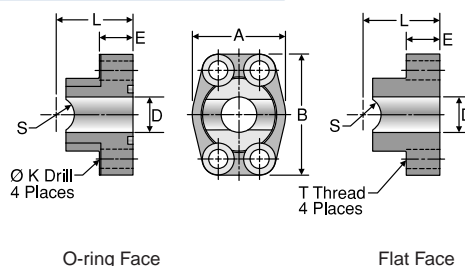

TABLE  
OF  
CONTENTS

VISUAL  
INDEX

FAQs

GEN TECH

TUBE FITTING PART #		PIPE OR TUBE SIZE (in.)	FLANGE SIZE (in.)	A (in.)	B (in.)	D (in.)	E (in.)	K DRILL DIA. (in.)	L (in.)	S (in.)	T THREAD UNC-2B	MOUNTING HARDWARE SHCS	Dynamic Pressure (x 1,000 PSI)	
O-ring FACE	FLAT FACE												-SX	-SS
<b>PIPE WELD SADDLE / CODE 61 BLOCK FLANGE OR PAD</b>														
12WSD1Q1B	12WSD1Q1P	3/4	0.75	1.97	2.56	0.75	0.710	0.406	1.775	0.532	3/8-16	3/8-16 x 1.50	5.0	
16WSD1Q1B	16WSD1Q1P	1	1.00	2.17	2.75	1.00	0.710	0.406	1.912	0.665	3/8-16	3/8-16 x 1.50	5.0	
20WSD1Q1B	20WSD1Q1P	1 1/4	1.25	2.68	3.12	1.25	0.830	0.469	2.146	0.837	7/16-14	7/16-14 x 1.75	4.0	
24WSD1Q1B	24WSD1Q1P	1 1/2	1.50	3.07	3.66	1.50	0.980	0.531	2.290	0.957	1/2-13	1/2-13 x 1.75	3.0	
32WSD1Q1B	32WSD1Q1P	2	2.00	3.54	4.00	2.00	0.980	0.531	2.340	1.200	1/2-13	1/2-13 x 1.75	3.0	
<b>TUBE WELD SADDLE / CODE 61 BLOCK FLANGE OR PAD</b>														
12WSD2Q1B	12WSD2Q1P	3/4	0.75	1.97	2.56	0.75	0.710	0.406	1.420	0.382	3/8-16	3/8-16 x 1.50	5.0	
16-12WSD2Q1B	16-12WSD2Q1P	1	0.75	1.97	2.56	0.75	0.710	0.406	1.420	0.507	3/8-16	3/8-16 x 1.50	5.0	
16WSD2Q1B	16WSD2Q1P	1	1.00	2.17	2.75	1.00	0.710	0.406	1.737	0.507	3/8-16	3/8-16 x 1.50	5.0	
20-16WSD2Q1B	20-16WSD2Q1P	1 1/4	1.00	2.17	2.75	1.00	0.710	0.406	1.500	0.632	3/8-16	3/8-16 x 1.50	5.0	
20WSD2Q1B	20WSD2Q1P	1 1/4	1.25	2.68	3.12	1.25	0.830	0.469	1.858	0.632	7/16-14	7/16-14 x 1.75	4.0	
24-20WSD2Q1B	24-20WSD2Q1P	1 1/2	1.25	2.68	3.12	1.25	0.830	0.469	1.665	0.757	7/16-14	7/16-14 x 1.75	4.0	
24WSD2Q1B	24WSD2Q1P	1 1/2	1.50	3.07	3.66	1.50	0.980	0.531	2.022	0.757	1/2-13	1/2-13 x 1.75	3.0	
28-24WSD2Q1B	28-24WSD2Q1P	1 3/4	1.50	3.07	3.66	1.50	0.980	0.531	2.198	0.882	1/2-13	1/2-13 x 1.75	3.0	
32WSD2Q1B	32WSD2Q1P	2	2.00	3.54	4.00	2.00	0.980	0.531	2.262	1.007	1/2-13	1/2-13 x 1.75	3.0	
36-32WSD2Q1B	36-32WSD2Q1P	2 1/4	2.00	3.54	4.00	2.00	0.980	0.531	2.247	1.132	1/2-13	1/2-13 x 1.75	3.0	

To receive mounting hardware with flange, insert a "K" after the material designator. Mounting hardware kits are available for O-ring Face part numbers and include 4 bolts, 4 lock washers and an O-ring.

K

## GQS

NPTF Port Square Block Flange Adapter  
NPTF Port / Square Block Flange or Pad

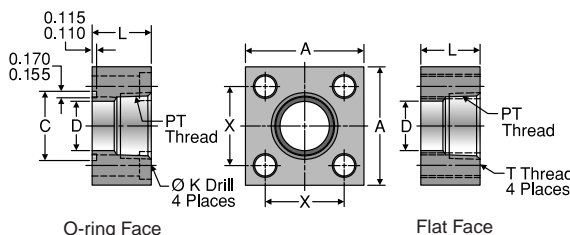

TUBE FITTING PART #		PT THREAD NPTF	FLANGE SIZE (in.)	A (in.)	B (in.)	C MIN. (in.)	D (in.)	K DRILL DIA. (in.)	L (in.)	T THREAD UNC-2B	X (in.)	O-ring	MOUNTING HARDWARE SHCS	Dynamic Pressure (x 1,000 PSI)	
O-ring FACE	FLAT FACE													-SX	-SS
12GQSB	12GQSP	3/4-14	0.75	2.25	1.12	1.250	0.75	0.406	1.25	3/8-16	1.438	2-214	3/8-16 x 2.00	5.0	
16GQSB	16GQSP	1-11 1/2	1.00	3.00	1.50	1.560	1.00	0.531	1.50	1/2-13	2.000	2-219	1/2-13 x 2.25	5.0	
20GQSB	20GQSP	1 1/4-11 1/2	1.25	3.00	1.50	1.750	1.25	0.531	1.50	1/2-13	2.000	2-222	1/2-13 x 2.25	4.0	
24GQSB	24GQSP	1 1/2-11 1/2	1.50	4.00	2.00	2.115	1.50	0.656	1.75	5/8-11	2.750	2-225	5/8-11 x 2.75	3.0	
32GQSB	32GQSP	2-11 1/2	2.00	4.00	2.00	2.490	2.00	0.656	1.75	5/8-11	2.750	2-228	5/8-11 x 2.75	2.7	
40GQSB	40GQSP	2 1/2-8	2.50	5.50	2.75	2.995	2.50	0.906	2.25	7/8-9	3.750	2-232	7/8-9 x 3.50	2.5	
48GQSB	48GQSP	3-8	3.00	5.50	2.75	3.615	3.00	0.906	2.25	7/8-9	3.750	2-237	7/8-9 x 3.50	1.2	

To receive mounting hardware with flange, insert a "K" after the material designator. Mounting hardware kits are available for O-ring Face part numbers and include 4 bolts, 4 lock washers and an O-ring.

[Click here for CADs, Support Resources or to Configure Parts Online](#)

# W5SQS

Weld Socket Square Block Connector, Pipe  
Pipe Weld Socket / Square Block Flange or Pad

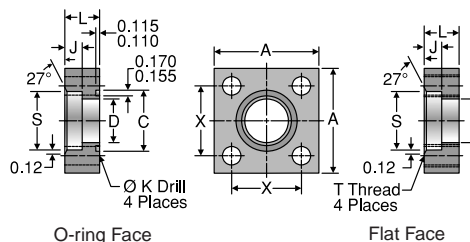

TABLE OF CONTENTS

VISUAL INDEX

FAQs

GEN TECH

TUBE FITTING PART #		PIPE SIZE	FLANGE SIZE	A	B	C MIN.	D	J	K DRILL DIA.	L	S	T THREAD	X	MOUNTING HARDWARE	Dynamic Pressure (x 1,000 PSI)		
O-ring FACE	FLAT FACE	(in.)	(in.)	(in.)	(in.)	(in.)	(in.)	(in.)	(in.)	(in.)	(in.)	UNC-2B	(in.)	O-ring	-SX	-SS	
12W5SQSB	12W5SQSP	3/4	0.75	2.25	1.12	1.250	0.75	0.50	0.406	1.00	1.062	3/8-16	1.438	2-214	3/8-16 x 1.75	5.0	
16W5SQSB	16W5SQSP	1	1.00	3.00	1.50	1.560	1.00	0.50	0.531	1.00	1.328	1/2-13	2.000	2-219	1/2-13 x 1.75	5.0	
20W5SQSB	20W5SQSP	1 1/4	1.25	3.00	1.50	1.750	1.25	0.50	0.531	1.00	1.672	1/2-13	2.000	2-222	1/2-13 x 1.75	4.0	
24W5SQSB	24W5SQSP	1 1/2	1.50	4.00	2.00	2.115	1.50	0.62	0.656	1.25	1.922	5/8-11	2.750	2-225	5/8-11 x 2.25	3.0	
32W5SQSB	32W5SQSP	2	2.00	4.00	2.00	2.490	2.00	0.62	0.656	1.25	2.406	5/8-11	2.750	2-228	5/8-11 x 2.25	3.0	
40W5SQSB	40W5SQSP	2 1/2	2.50	5.50	2.75	2.995	2.50	0.75	0.906	1.50	2.906	7/8-9	3.750	2-232	7/8-9 x 2.75	2.5	
48W5SQSB	48W5SQSP	3	3.00	5.50	2.75	3.615	3.00	0.75	0.906	1.50	3.547	7/8-9	3.750	2-237	7/8-9 x 2.75	2.0	

To receive mounting hardware with flange, insert a "K" after the material designator. Mounting hardware kits are available for O-ring Face part numbers and include 4 bolts, 4 lock washers and an O-ring.

# PQ

Block Plug  
Code 61/62 Block Flange or Pad Plug

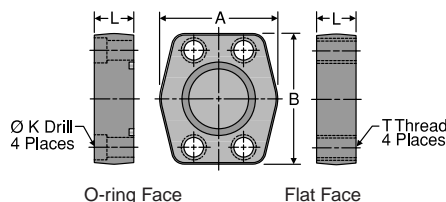

TUBE FITTING PART #		FLANGE SIZE	A	B	K DRILL DIA.	L	T THREAD	MOUNTING HARDWARE	Dynamic Pressure (x 1,000 PSI)	
O-ring FACE	FLAT FACE	(in.)	(in.)	(in.)	(in.)	(in.)	UNC-2B	SHCS	-SX	-SS <sup>1</sup>
<b>CODE 61 BLOCK FLANGE OR PAD PLUG</b>										
8PQ1B	8PQ1P	0.50	1.813	2.125	0.344	0.750	5/16-18	5/16-18 x 1.50	5.0	
12PQ1B	12PQ1P	0.75	2.063	2.563	0.406	0.750	3/8-16	3/8-16 x 1.50	5.0	
16PQ1B	16PQ1P	1.00	2.313	2.750	0.406	0.880	3/8-16	3/8-16 x 1.75	5.0	
20PQ1B	20PQ1P	1.25	2.875	3.125	0.469	0.940	7/16-14	7/16-14 x 1.75	4.0	
24PQ1B	24PQ1P	1.50	3.250	3.688	0.531	1.190	1/2-13	1/2-13 x 2.25	3.0	
32PQ1B	32PQ1P	2.00	3.813	4.000	0.531	1.440	1/2-13	1/2-13 x 2.50	3.0	
40PQ1B	40PQ1P	2.50	4.281	4.500	0.531	1.815	1/2-13	1/2-13 x 2.75	2.5	
48PQ1B	48PQ1P	3.00	5.156	5.313	0.656	2.190	5/8-11	5/8-11 x 3.50	2.0	
56PQ1B	56PQ1P	3.50	5.500	6.000	0.656	1.440	5/8-11	5/8-11 x 2.75	0.5	
64PQ1B	64PQ1P	4.00	6.000	6.380	0.656	1.440	5/8-11	5/8-11 x 2.75	0.5	
<b>CODE 62 BLOCK FLANGE OR PAD PLUG</b>										
8PQ2B	8PQ2P	0.50	1.940	2.300	0.344	1.250	5/16-18	5/16-18 x 2.00	6.0	
12PQ2B	12PQ2P	0.75	2.500	2.950	0.406	1.250	3/8-16	3/8-16 x 2.00	6.0	
16PQ2B	16PQ2P	1.00	2.750	3.190	0.469	1.500	7/16-14	7/16-14 x 2.50	6.0	
20PQ2B	20PQ2P	1.25	3.060	3.750	0.531	1.430	1/2-13	1/2-13 x 2.50	6.0	
24PQ2B	24PQ2P	1.50	3.750	4.440	0.656	1.815	5/8-11	5/8-11 x 3.00	6.0	
32PQ2B	32PQ2P	2.00	4.500	5.250	0.781	1.815	3/4-10	3/4-10 x 3.00	6.0	
40PQ2B <sup>2</sup>	40PQ2P <sup>2</sup>	2.50	5.870	6.870	0.940	1.930	7/8-9	7/8-9 x 3.50	6.0	
48PQ2B <sup>2</sup>	48PQ2P <sup>2</sup>	3.00	7.000	8.500	1.190	2.690	1 1/8-7	1 1/8-7 x 4.50	6.0	

1) See page K42 for standard stainless steel sizes and dimensions.

2) SAE J518 does not cover these sizes in Code 62. Bolt hole centerline dimensions are: 2.312" x 4.875" for 20PQ2 and 2.812" x 6.000" for 48PQ2.

To receive mounting hardware with flange, insert a "K" after the material designator. Mounting hardware kits are available for O-ring Face part numbers and include 4 bolts, 4 lock washers and an O-ring.

[Click here for CADs, Support Resources or to Configure Parts Online](#)

# SPGG5

Flange Spacer with Gage Ports  
Code 61/62 Spacer with Side Gage Ports

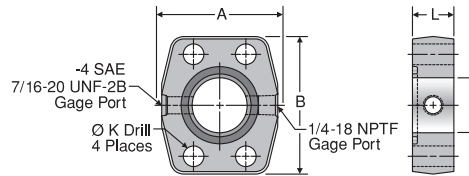

TUBE FITTING PART #	FLANGE SIZE (in.)	A (in.)	B (in.)	D (in.)	K DRILL DIA. (in.)	L (in.)	Dynamic Pressure (x 1,000 PSI)	
							-SX	-SS
<b>CODE 61 O-ring SPACER</b>								
8SPGG5Q1B	0.50	1.813	2.125	0.500	0.344	1.25	5.0	
12SPGG5Q1B	0.75	2.063	2.563	0.750	0.406	1.25	5.0	
16SPGG5Q1B	1.00	2.313	2.750	1.000	0.406	0.88	5.0	
20SPGG5Q1B	1.25	2.875	3.125	1.250	0.469	0.94	4.0	
24SPGG5Q1B	1.50	3.250	3.688	1.500	0.531	1.19	3.0	
32SPGG5Q1B	2.00	3.813	4.000	2.000	0.531	1.38	3.0	
40SPGG5Q1B	2.50	4.281	4.500	2.500	0.531	1.75	2.5	
48SPGG5Q1B	3.00	5.156	5.313	3.000	0.656	2.12	2.0	
<b>CODE 62 O-ring SPACER</b>								
8SPGG5Q2B	0.50	1.940	2.300	0.500	0.344	1.25	6.0	
12SPGG5Q2B	0.75	2.500	2.950	0.750	0.406	1.25	6.0	
16SPGG5Q2B	1.00	2.750	3.190	1.000	0.469	1.50	6.0	
20SPGG5Q2B	1.25	3.060	3.750	1.250	0.531	1.50	6.0	
24SPGG5Q2B	1.50	3.750	4.440	1.500	0.656	1.75	6.0	
32SPGG5Q2B	2.00	4.500	5.250	2.000	0.781	1.75	6.0	

# CP

Flange Connector Plate  
Code 61/62 Flange Connector Plate

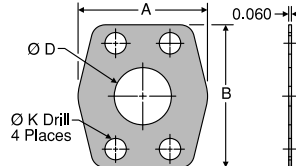

TUBE FITTING PART #	FLANGE SIZE (in.)	A (in.)	B (in.)	D (in.)	K DRILL DIA. (in.)	Dynamic Pressure (x 1,000 PSI)	
						-SX	-SS
<b>CODE 61 FLANGE CONNECTOR PLATE</b>							
8CP1	0.50	1.81	2.12	0.50	0.344	5.0	
12CP1	0.75	2.06	2.56	0.75	0.406	5.0	
16CP1	1.00	2.31	2.75	1.00	0.406	5.0	
20CP1	1.25	2.88	3.12	1.25	0.469	4.0	
24CP1	1.50	3.25	3.69	1.50	0.531	3.0	
32CP1	2.00	3.81	4.00	2.00	0.531	3.0	
40CP1	2.50	4.12	4.44	2.50	0.531	2.5	
48CP1	3.00	5.16	5.31	3.00	0.656	2.5	
<b>CODE 62 FLANGE CONNECTOR PLATE</b>							
12CP2	0.75	2.38	2.81	0.75	0.406	6.0	
16CP2	1.00	2.75	3.19	1.00	0.469	6.0	
20CP2	1.25	3.06	3.75	1.25	0.531	6.0	
24CP2	1.50	3.75	4.44	1.50	0.656	6.0	
32CP2	2.00	4.50	5.25	2.00	0.781	6.0	

TABLE OF CONTENTS

VISUAL INDEX

FAQs

GEN TECH

K

[Click here for CADs, Support Resources or to Configure Parts Online](#)

## LOVQ1

Code 61 Flange 45° Elbow  
Code 61 / ORFS

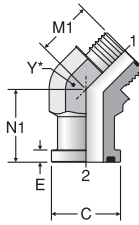

\*Y – Across Wrench Flats

TUBE FITTING PART #	END SIZE		C (in.)	E (in.)	M1 (in.)	N1 (in.)	Y (in.)	Dynamic Pressure (x 1,000 PSI)
	1 (in.)	2 (in.)						-S
12 LOVQ1	3/4	3/4	1.500	0.265	1.28	1.58	1 7/16	5.0
16 LOVQ1	1	1	1.750	0.315	1.47	1.85	1 5/8	5.0
20 LOVQ1	1 1/4	1 1/4	2.000	0.315	1.59	2.04	1 7/8	4.0
24 LOVQ1	1 1/2	1 1/2	2.375	0.315	1.78	2.38	2 1/2	3.0

## LOVQ2

Code 62 Flange 45° Elbow  
Code 62 / ORFS

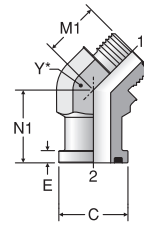

\*Y – Across Wrench Flats

TUBE FITTING PART #	END SIZE		C (in.)	E (in.)	M1 (in.)	N1 (in.)	Y (in.)	Dynamic Pressure (x 1,000 PSI)
	1 (in.)	2 (in.)						-S
12 LOVQ2	3/4	3/4	1.625	0.345	1.28	1.58	1 7/16	6.0
16 LOVQ2	1	1	1.875	0.375	1.47	1.85	1 5/8	6.0
20 LOVQ2	1 1/4	1 1/4	2.125	0.405	1.59	2.04	1 7/8	5.0
24 LOVQ2	1 1/2	1 1/2	2.500	0.495	1.78	2.38	2 1/2	4.5

**WARNING:** This product can expose you to chemicals including Diisononyl Phthalate which is known to the State of California to cause cancer. For more information go to [www.p65warnings.ca.gov](http://www.p65warnings.ca.gov).

## XVQ1

Code 61 Flange 45° Elbow  
Code 61 / 37° Flare

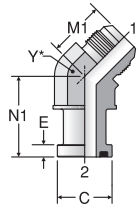

\*Y – Across Wrench Flats

TUBE FITTING PART #	END SIZE		C (in.)	E (in.)	M1 (in.)	N1 (in.)	Y (in.)	Dynamic Pressure (x 1,000 PSI)
	1 (in.)	2 (in.)						-S
12 XVQ1	3/4	3/4	1.500	0.265	1.28	1.58	1 7/16	5.0
16 XVQ1	1	1	1.750	0.315	1.47	1.85	1 5/8	5.0
20 XVQ1	1 1/4	1 1/4	2.000	0.315	1.59	2.04	1 7/8	4.0
24 XVQ1	1 1/2	1 1/2	2.375	0.315	1.78	2.38	2 1/2	3.0
32 XVQ1	2	2	2.812	0.375	2.22	3.00	2 1/2	2.0

**WARNING:** This product can expose you to chemicals including Diisononyl Phthalate which is known to the State of California to cause cancer. For more information go to [www.p65warnings.ca.gov](http://www.p65warnings.ca.gov).

## XVQ2

Code 62 Flange 45° Elbow  
Code 62 / 37° Flare

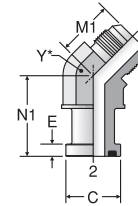

\*Y – Across Wrench Flats

TUBE FITTING PART #	END SIZE		C (in.)	E (in.)	M1 (in.)	N1 (in.)	Y (in.)	Dynamic Pressure (x 1,000 PSI)
	1 (in.)	2 (in.)						-S
12 XVQ2	3/4	3/4	1.625	0.345	1.28	1.58	1 7/16	5.0
16 XVQ2	1	1	1.875	0.375	1.47	1.85	1 5/8	5.0
20 XVQ2	1 1/4	1 1/4	2.125	0.405	1.59	2.04	1 7/8	4.0
24 XVQ2	1 1/2	1 1/2	2.500	0.495	1.78	2.38	2 1/2	3.0

## BUVQ1

Code 61 45° Elbow  
Code 61 / Flareless

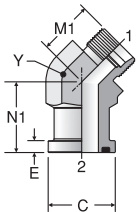

\*Y – Across Wrench Flats

TUBE FITTING PART #	END SIZE		C (in.)	E (in.)	M1 (in.)	N1 (in.)	Y (in.)	Dynamic Pressure (x 1,000 PSI)
	1 (in.)	2 (in.)						-S
12 BUVQ1	3/4	3/4	1.500	0.265	1.27	1.58	1 7/16	
16 BUVQ1	1	1	1.750	0.315	1.36	1.85	1 5/8	
20 BUVQ1	1 1/4	1 1/4	2.000	0.315	1.45	2.40	1 7/8	
24 BUVQ1	1 1/2	1 1/2	2.375	0.315	1.52	2.90	2 1/2	
32 BUVQ1	2	2	2.812	0.375	1.83	3.00	2 1/2	

TABLE OF CONTENTS

VISUAL INDEX

FAQs

GEN TECH



Click here for CADs, Support Resources or to Configure Parts Online

## LOEQ1

Code 61 Flange 90° Elbow  
Code 61 / ORFS

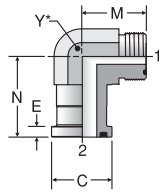

\*Y – Across Wrench Flats

TUBE FITTING PART #	END SIZE		C	E	M	N	Y	Dynamic Pressure (x 1,000 PSI)		
	1 (in.)	2 (in.)						-S	-SS	-B
12 LOEQ1	3/4	3/4	1.500	0.265	1.66	2.13	1 3/16	5.0		
16 LOEQ1	1	1	1.750	0.315	1.81	2.37	1 7/16	5.0		
20 LOEQ1	1 1/4	1 1/4	2.000	0.315	2.06	2.62	1 5/8	4.0		
24 LOEQ1	1 1/2	1 1/2	2.375	0.315	2.33	3.15	2	3.0		

## LOEQ2

Code 62 Flange 90° Elbow  
Code 62 / ORFS

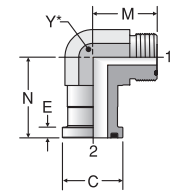

\*Y – Across Wrench Flats

TUBE FITTING PART #	END SIZE		C	E	M	N	Y	Dynamic Pressure (x 1,000 PSI)		
	1 (in.)	2 (in.)						-S	-SS	-B
12 LOEQ2	3/4	3/4	1.625	0.345	1.66	2.13	1 3/16	6.0		
16 LOEQ2	1	1	1.875	0.375	1.81	2.37	1 7/16	6.0		
20 LOEQ2	1 1/4	1 1/4	2.125	0.405	2.06	2.76	1 5/8	5.0		
24 LOEQ2	1 1/2	1 1/2	2.500	0.495	2.33	3.15	2	4.5		

TABLE OF CONTENTS

VISUAL INDEX

FAQs

GEN TECH

## XEQ1

Code 61 Flange 90° Elbow  
Code 61 / 37° Flare

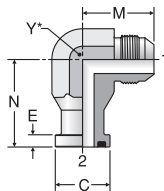

\*Y – Across Wrench Flats

TUBE FITTING PART #	END SIZE		C	E	M	N	Y	Dynamic Pressure (x 1,000 PSI)		
	1 (in.)	2 (in.)						-S	-SS	-B
12 XEQ1	3/4	3/4	1.500	0.265	1.66	2.13	1 3/16	5.0		
16 XEQ1	1	1	1.750	0.315	1.81	2.37	1 7/16	5.0		
20 XEQ1	1 1/4	1 1/4	2.000	0.315	2.06	2.62	1 5/8	4.0		
24 XEQ1	1 1/2	1 1/2	2.375	0.315	2.33	3.15	2	3.0		
32 XEQ1	2	2	2.812	0.375	3.06	4.25	2 1/2	2.0		

## XEQ2

Code 62 Flange 90° Elbow  
Code 62 / 37° Flare

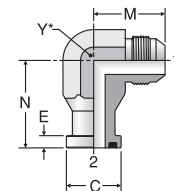

\*Y – Across Wrench Flats

TUBE FITTING PART #	END SIZE		C	E	M	N	Y	Dynamic Pressure (x 1,000 PSI)		
	1 (in.)	2 (in.)						-S	-SS	-B
12 XEQ2	3/4	3/4	1.625	0.345	1.66	2.13	1 3/16	5.0		
16 XEQ2	1	1	1.875	0.375	1.81	2.57	1 7/16	5.0		
20 XEQ2	1 1/4	1 1/4	2.125	0.405	2.06	2.76	1 5/8	4.0		
24 XEQ2	1 1/2	1 1/2	2.500	0.495	2.33	3.15	2	3.0		

K

## BUEQ1

Code 61 90° Elbow  
Code 61 / Flareless

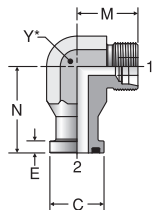

\*Y – Across Wrench Flats

TUBE FITTING PART #	END SIZE		C	E	M	N	Y	Dynamic Pressure (x 1,000 PSI)		
	1 (in.)	2 (in.)						-S	-SS	-B
12 BUEQ1	3/4	3/4	1.500	0.265	1.73	1.81	1 3/16			
16 BUEQ1	1	1	1.750	0.315	1.99	2.13	1 7/16			
20 BUEQ1	1 1/4	1 1/4	2.000	0.315	1.99	2.26	1 5/8			
24 BUEQ1	1 1/2	1 1/2	2.375	0.315	2.33	2.64	2			
32 BUEQ1	2	2	2.812	0.375	2.45	4.25	2 1/2			

**WARNING:** This product can expose you to chemicals including Diisononyl Phthalate which is known to the State of California to cause cancer. For more information go to [www.p65warnings.ca.gov](http://www.p65warnings.ca.gov).

[Click here for CADs, Support Resources or to Configure Parts Online](#)

# W7EQ

Weld Socket Block Elbow Connector, Pipe  
Weld Socket, Pipe / Code 61 or 62  
Block Flange or Pad

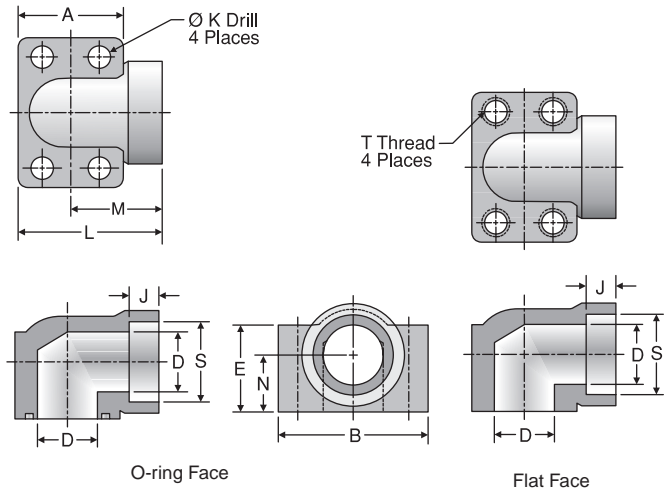

**TABLE OF CONTENTS**

**VISUAL INDEX**

**FAQs**

**GEN TECH**

TUBE FITTING PART #		PIPE SIZE (in.)	FLANGE SIZE (in.)	A (in.)	B (in.)	D (in.)	E (in.)	J (in.)	K DRILL DIA. (in.)	L (in.)	M (in.)	N (in.)	S (in.)	T THREAD UNC-2B	MOUNTING HARDWARE SHCS	Dynamic Pressure (x 1,000 PSI)	
O-ring FACE	FLAT FACE															-SX	-SS
<b>WELD SOCKET, PIPE / CODE 61 BLOCK FLANGE OR PAD</b>																	
12W7EQ1B	12W7EQ1P	3/4	0.75	1.69	2.56	0.75	1.25	0.56	0.406	2.28	1.44	0.875	1.062	3/8-16	3/8-16 x 2.00	5.0	
16W7EQ1B	16W7EQ1P	1	1.00	1.94	2.75	1.00	1.50	0.56	0.406	2.62	1.66	1.062	1.328	3/8-16	3/8-16 x 2.25	4.5	
20W7EQ1B	20W7EQ1P	1 1/4	1.25	2.19	3.12	1.25	1.81	0.62	0.469	3.00	1.91	1.188	1.672	7/16-14	7/16-14 x 2.75	3.5	
24W7EQ1B	24W7EQ1P	1 1/2	1.50	2.56	3.69	1.50	2.00	0.69	0.531	3.33	2.05	1.312	1.922	1/2-13	1/2-13 x 3.00	3.0	
32W7EQ1B	32W7EQ1P	2	2.00	3.06	4.33	2.00	2.50	0.75	0.531	3.81	2.28	1.656	2.406	1/2-13	1/2-13 x 3.50	3.0	
<b>WELD SOCKET, PIPE / CODE 62 BLOCK FLANGE OR PAD</b>																	
12W7EQ2B	12W7EQ2P	3/4	0.75	1.94	2.75	0.75	1.50	0.56	0.406	2.62	1.66	1.062	1.062	3/8-16	3/8-16 x 2.25	6.0	
16W7EQ2B	16W7EQ2P	1	1.00	2.19	3.12	1.00	1.81	0.62	0.469	3.00	1.91	1.188	1.328	7/16-14	7/16-14 x 2.50	6.0	
20W7EQ2B	20W7EQ2P	1 1/4	1.25	2.56	3.69	1.25	2.00	0.69	0.531	3.32	2.05	1.312	1.672	1/2-13	1/2-13 x 3.00	5.0	
24W7EQ2B	24W7EQ2P	1 1/2	1.50	3.06	4.33	1.50	2.50	0.75	0.656	3.81	2.28	1.656	1.922	5/8-11	5/8-11 x 3.50	5.0	

To receive mounting hardware with flange, insert a "K" after the material designator. Mounting hardware kits are available for O-ring Face part numbers and include 4 bolts, 4 lock washers and an O-ring.

[Click here for CADs, Support Resources or to Configure Parts Online](#)

# WFS

SAE Flange Connection  
Code 61 & 62 / Metric Flareless

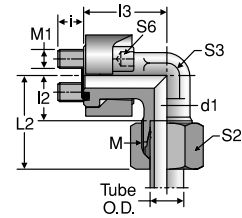

TABLE OF CONTENTS

VISUAL INDEX

FAQs

GEN TECH

K

TUBE FITTING PART #	SIZE (in.)	END SIZE (mm)	WORKING PRESSURE (bar)	M THREAD	d1 (mm)	I (mm)	I1 (mm)	I2 (mm)	I3 (mm)	L1 ≈ (mm)	L2 ≈ (mm)	S1 (mm)	S2 (mm)	S3 (mm)	S6 (mm)	FROM STOCK		FROM STOCK	
																CF	71	CF	71
<b>SAE FLANGE CONNECTIONS – CODE 61 – STANDARD SERIES</b>																			
WFS32/15LCF	1/2	15L	200	M22 x 1.5	12	11.5	41	29	36	56	44	24	27	24	6	•		•	
WFS32/16SCF	1/2	16S	220	M24 x 1.5	12	11.5	41.5	29.5	36	60	48	24	30	24	6	•		•	
WFS33/18LCF	3/4	18L	200	M26 x 1.5	15	15.5	45.5	31.5	42	62	48	30	32	30	8	•		•	
WFS33/22LCF	3/4	22L	100	M30 x 2	19	15.5	45.5	33.5	42	62	50	30	36	30	8	•		•	
WFS33/20SCF	3/4	20S	220	M30 x 2	16	15.5	46.5	32.5	42	68	54	30	36	30	8	•		•	
WFS33/25SCF	3/4	25S	220	M36 x 2	17	15.5	45	33	42	69	57	30	46	30	8	•		•	
WFS34/28LCF	1	28L	100	M36 x 2	24	13.5	46.5	36.5	45	63	53	36	41	36	8	•		•	
WFS34/30SCF	1	30S	220	M42 x 2	24	13.5	49.5	36.5	45	76	63	36	50	36	8	•		•	
WFS35/35LCF	1 1/4	35L	100	M45 x 2	30	18.5	47.5	46.5	50	69	68	41	50	41	8	•		•	
WFS35/25SCF	1 1/4	25S	175	M36 x 2	20	18.5	48	43	50	72	67	41	46	41	8	•		•	
WFS35/30SCF	1 1/4	30S	175	M42 x 2	25	18.5	48.5	43.5	50	75	70	41	50	41	8	•		•	
WFS35/38SCF	1 1/4	38S	175	M52 x 2	28	18.5	50	43	50	81	74	46	60	41	8	•		•	
WFS36/42LCF	1 1/2	42L	100	M52 x 2	36	18.5	53	47	55	76	70	46	60	50	10	•		•	
WFS36/38SCF	1 1/2	38S	130	M52 x 2	32	18.5	54	48	55	85	79	46	60	50	10	•		•	
<b>SAE FLANGE CONNECTIONS – CODE 62 – HIGH PRESSURE SERIES</b>																			
WFS62/16SCF	1/2	16S	250	M24 x 1.5	12	13.5	44.5	29.5	39	63	48	24	30	24	6	•		•	
WFS63/16SCF	3/4	16S	250	M24 x 1.5	12	15.5	50.5	36.5	48	69	55	30	30	32	8	•		•	
WFS63/20SCF	3/4	20S	250	M30 x 2	16	15.5	50.5	35.5	48	72	57	30	36	32	8	•		•	
WFS63/25SCF	3/4	25S	250	M36 x 2	17	15.5	51	36	48	75	60	30	46	32	8	•		•	
WFS64/25SCF	1	25S	250	M36 x 2	20	20.5	60	44	60	84	65	36	46	41	10	•		•	
WFS64/30SCF	1	30S	250	M42 x 2	24	20.5	60.5	41.5	60	87	68	36	50	41	10	•		•	
WFS65/30SCF	1 1/4	30S	250	M42 x 2	25	22.5	65.5	44.5	68	92	71	41	50	46	10	•		•	
WFS65/38SCF	1 1/4	38S	200	M52 x 2	30	22.5	67	45	68	98	76	46	60	46	10	•		•	
WFS66/38SCF	1 1/2	38S	200	M52 x 2	30	24.5	73	56	76	104	87	46	60	50	14	•		•	

EO-2 Part Number example: WFS33/18ZLCF

Tightening torques for socket head cap screws see Tables R6 and R7.

[Click here for CADs, Support Resources or to Configure Parts Online](#)

# BFW

Hydraulic Flange Elbow  
DIN Flange / Metric Flareless

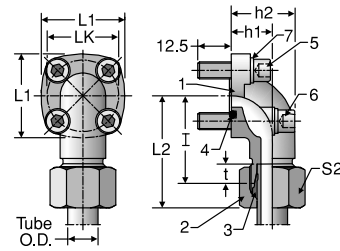

TABLE OF CONTENTS

VISUAL INDEX

FAQs

GEN TECH

TUBE FITTING PART #	WORKING PRESSURE (bar)	END SIZE (mm)	h1 (mm)	h1 (mm)	l (mm)	L1 (mm)	L2 (mm)	LK (mm)	S2 (mm)	t (mm)	MATERIAL FROM STOCK		EO-2 FROM STOCK	
											CF	71	CF	71
BFW15L/LK40CF	65	15	22.5	36.5	38	42	46	40	27	7	•		•	
BFW18L/LK40CF	65	18	22.5	36.5	38	42	47	40	32	7.5	•		•	
BFW22L/LK40CF	65	22	22.5	36.5	38	42	47.5	40	36	7.5	•		•	
BFW28L/LK40CF	65	28	28	43	40	42	49	40	41	7.5	•		•	
BFW35L/LK40CF	65	35	32	55	41	42	52	40	50	10.5	•		•	
BFW35L/LK55CF	65	35	32	51.5	49	58	62	55	50	10.5	•		•	
BFW42L/LK55CF	65	42	40	64.5	49	58	61	55	60	11	•		•	
BFW15L/LK35CF	155	15	16.5	26.5	38	39	46	35	27	7	•		•	
BFW20S/LK55CF	155	20	24	38	45	58	56	55	36	10.5	•		•	
BFW20S/LK40CF	155	20	22.5	35.5	40	42	50	40	36	10.5	•		•	
BFW25S/LK55CF	155	25	30	46	49	58	61	55	46	12	•		•	
BFW30S/LK55CF	155	30	32	50	49	58	62	55	50	13.5	•		•	
BFW10L/LK35CF	200	10	16.5	26.5	38	39	47	35	19	7	•		•	
BFW12L/LK35CF	200	12	16.5	26.5	38	39	47	35	22	7	•		•	
BFW16S/LK35CF	200	16	20	31	38	39	48	35	30	8.5	•		•	

## Unassembled BFW Fitting Components

1 Elbow Body	2 Nut	3 Progressive Ring	4 O-ring	5 2 Cap Screws DIN 912-8.8	6 2 Cap Screws DIN 912-8.8	7 4 Spr. Washers DIN 127
BFW15L/LK40CFX	M15LCFX	DPR15LCFX	OR26X2.5X	M6X22	M6X22	A6
BFW18L/LK40CFX	M18LCFX	DPR18LCFX	OR26X2.5X	M6X22	M6X22	A6
BFW22L/LK40CFX	M22LCFX	DPR22LCFX	OR26X2.5X	M6X22	M6X22	A6
BFW28L/LK40CFX	M28LCFX	DPR28LCFX	OR26X2.5X	M6X20	M6X50	A6
BFW35L/LK40CFX	M35LCFX	DPR35LCFX	OR26X2.5X	M6X22	M6X60	A6
BFW35L/LK55CFX	M35LCFX	DPR35LCFX	OR33X2.5X	M8X25	M8X60	A8
BFW42L/LK55CFX	M42LCFX	DPR42LCFX	OR33X2.5X	M8X25	M8X70	A8
BFW15L/LK35CFX	M15LCFX	DPR15LCFX	OR20X2.5X	M6X22	M6X35	A6
BFW20S/LK55CFX	M20SCFX	DPR20SCFX	OR33X2.5X	M8X25	M8X50	A8
BFW20S/LK40CFX	M20SCFX	DPR20SCFX	OR26X2.5X	M6X22	M6X45	A6
BFW25S/LK55CFX	M25SCFX	DPR25SCFX	OR33X2.5X	M8X25	M8X55	A8
BFW30S/LK55CFX	M30SCFX	DPR20SCFX	OR33X2.5X	M8X25	M8X55	A8
BFW10L/LK35CFX	M10LCFX	DRP10LCFX	OR20X2.5X	M6X22	M6X35	A6
BFW12L/LK35CFX	M12LCFX	DPR12LCFX	OR20X2.5X	M6X22	M6X35	A6
BFW16S/LK35CFX	M16SCFX	DPR16SCFX	OR20X2.5X	M6X22	M6X40	A6
BFW20S/LK35CFX	M20SCFX	DPR20SCFX	OR20X2.5X	M6X22	M6X45	A6

EO-2 Part Number example: BFW15ZL/LK40CF

Tightening torques for socket head cap screws see Table R6.

[Click here for CADs, Support Resources or to Configure Parts Online](#)

# QPQPJQ

Block Junction Tee

Code 61 or 62 Block Pads / Block Flange or Pad

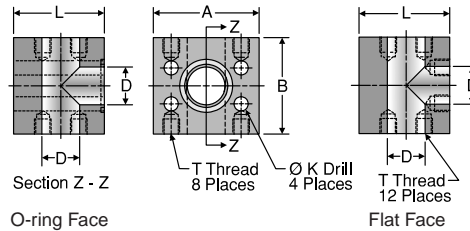

TABLE OF CONTENTS

VISUAL INDEX

FAQs

GEN TECH

TUBE FITTING PART #		FLANGE SIZE (in.)	A (in.)	B (in.)	D (in.)	K DRILL DIA. (in.)	L (in.)	T THREAD UNC-2B	Dynamic Pressure (x 1,000 PSI)	
O-ring FACE	FLAT FACE								-SX	-SS
<b>CODE 61 BLOCK PADS / BLOCK FLANGE OR PAD</b>										
12Q1PQ1PJQ1B	12Q1PQ1PJQ1P	0.75	2.62	2.75	0.75	0.406	2.25	3/8-16	5.0	
16Q1PQ1PJQ1B	16Q1PQ1PJQ1P	1.00	2.82	2.97	1.00	0.406	2.50	3/8-16	5.0	
20Q1PQ1PJQ1B	20Q1PQ1PJQ1P	1.25	3.19	3.47	1.25	0.469	3.00	7/16-14	4.0	
24Q1PQ1PJQ1B	24Q1PQ1PJQ1P	1.50	3.75	3.97	1.50	0.531	3.50	1/2-13	3.0	
32Q1PQ1PJQ1B	32Q1PQ1PJQ1P	2.00	4.00	4.25	2.00	0.531	3.97	1/2-13	3.0	
<b>CODE 62 BLOCK PADS / BLOCK FLANGE OR PAD</b>										
12Q2PQ2PJQ2B	12Q2PQ2PJQ2P	0.75	2.81	2.97	0.75	0.406	2.50	3/8-16	6.0	
16Q2PQ2PJQ2B	16Q2PQ2PJQ2P	1.00	3.19	3.47	1.00	0.469	3.00	7/16-14	6.0	
20Q2PQ2PJQ2B	20Q2PQ2PJQ2P	1.25	3.75	3.97	1.25	0.531	3.50	1/2-13	6.0	
24Q2PQ2PJQ2B	24Q2PQ2PJQ2P	1.50	4.50	4.47	1.50	0.656	4.00	5/8-11	6.0	
32Q2PQ2PJQ2B	32Q2PQ2PJQ2P	2.00	5.25	4.97	1.94	0.781	5.00	3/4-10	6.0	

# G5EQ

SAE Port Block Elbow

SAE Port / Code 61 or 62 Block Flange or Pad

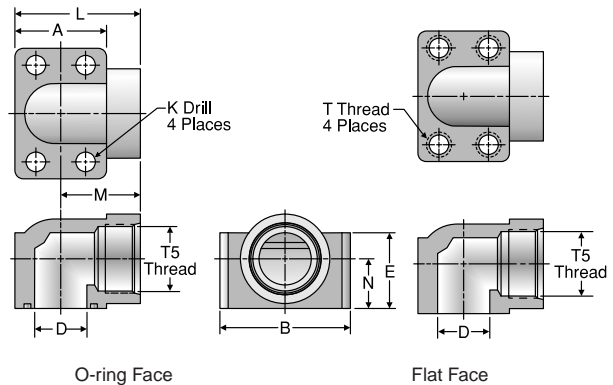

K

TUBE FITTING PART #		T5 STRAIGHT THREAD UN-2B	SAE PORT DASH SIZE	FLANGE SIZE (in.)	A (in.)	B (in.)	D (in.)	E (in.)	K DRILL DIA. (in.)	L (in.)	M (in.)	N (in.)	T THREAD UNC-2B	MOUNTING HARDWARE SHCS		Dynamic Pressure (x 1,000 PSI)	
O-ring FACE	FLAT FACE													-SX	-SS		
<b>SAE PORT / CODE 61 BLOCK FLANGE OR PAD</b>																	
12G5EQ1B	12G5EQ1P	1-1/16-12	12	0.75	1.69	2.56	0.75	1.25	0.406	2.28	1.440	0.875	3/8-16	3/8-16 x 2.00	4.0		
16G5EQ1B	16G5EQ1P	1-5/16-12	16	1.00	1.94	2.75	1.00	1.50	0.406	2.62	1.660	1.062	3/8-16	3/8-16 x 2.25	3.0		
20G5EQ1B	20G5EQ1P	1-5/8-12	20	1.25	2.19	3.12	1.25	1.81	0.469	3.00	1.910	1.188	7/16-14	7/16-14 x 2.75	2.5		
24G5EQ1B	24G5EQ1P	1-7/8-12	24	1.50	2.56	3.69	1.50	2.00	0.531	3.32	2.050	1.312	1/2-13	1/2-13 x 3.00	2.0		
32G5EQ1B	32G5EQ1P	2-1/2-12	32	2.00	3.06	4.33	2.00	2.50	0.531	3.81	2.280	1.656	1/2-13	1/2-13 x 3.50	1.5		
<b>SAE PORT / CODE 62 BLOCK FLANGE OR PAD</b>																	
12G5EQ2B	12G5EQ2P	1-1/16-12	12	0.75	1.94	2.75	0.75	1.50	0.406	2.62	1.660	1.062	3/8-16	3/8-16 x 2.25	5.0		
16G5EQ2B	16G5EQ2P	1-5/16-12	16	1.00	2.19	3.12	1.00	1.81	0.469	3.00	1.910	1.188	7/16-14	7/16-14 x 2.50	4.0		
20G5EQ2B	20G5EQ2P	1-5/8-12	20	1.25	2.56	3.69	1.25	2.00	0.531	3.32	2.050	1.312	1/2-13	1/2-13 x 3.00	3.5		
24G5EQ2B	24G5EQ2P	1-7/8-12	24	1.50	3.06	4.33	1.50	2.50	0.656	3.81	2.280	1.656	5/8-11	5/8-11 x 3.50	3.5		

To receive mounting hardware with flange, insert a "K" after the material designator. Mounting hardware kits are available for O-ring Face part numbers and include 4 bolts, 4 lock washers and an O-ring.



[Click here for CADs, Support Resources or to Configure Parts Online](#)

# GEQ

NPTF Port Block Elbow Adapter  
NPTF / Code 61 or 62 Block Flange or Pad

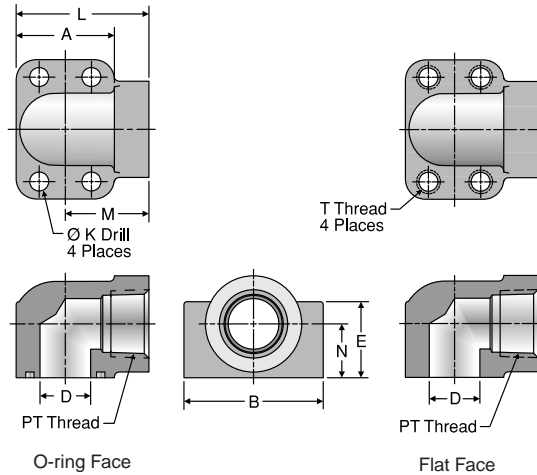

**TABLE OF CONTENTS**

**VISUAL INDEX**

**FAQs**

**GEN TECH**

TUBE FITTING PART #		PT THREAD NPTF	FLANGE SIZE (in.)	A (in.)	B (in.)	D (in.)	E (in.)	K DRILL DIA. (in.)	L (in.)	M (in.)	N (in.)	T THREAD UNC-2B	MOUNTING HARDWARE SHCS	Dynamic Pressure (x 1,000 PSI)	
O-ring FACE	FLAT FACE													-SX	-SS
<b>NPTF PORT / CODE 61 BLOCK FLANGE OR PAD</b>															
12GEQ1B	12GEQ1P	3/4 - 14	0.75	1.69	2.56	0.75	1.25	0.406	2.28	1.440	0.875	3/8-16	3/8-16 x 2.00	4.0	
16GEQ1B	16GEQ1P	1 - 11 1/2	1.00	1.94	2.75	1.00	1.50	0.406	2.62	1.660	1.062	3/8-16	3/8-16 x 2.25	4.0	
20GEQ1B	20GEQ1P	1 1/4 - 11 1/2	1.25	2.19	3.12	1.25	1.81	0.469	3.00	1.910	1.188	7/16-14	7/16-14 x 2.75	2.7	
24GEQ1B	24GEQ1P	1 1/2 - 11 1/2	1.50	2.56	3.69	1.50	2.00	0.531	3.33	2.050	1.312	1/2-13	1/2-13 x 3.00	2.5	
32GEQ1B	32GEQ1P	2 - 11 1/2	2.00	3.06	4.33	2.00	2.50	0.531	3.81	2.280	1.656	1/2-13	1/2-13 x 3.50	1.7	
<b>NPTF PORT / CODE 62 BLOCK FLANGE OR PAD</b>															
12GEQ2B	12GEQ2P	3/4 - 14	0.75	1.94	2.75	0.75	1.50	0.406	2.62	1.660	1.062	3/8-16	3/8-16 x 2.25	5.5	
16GEQ2B	16GEQ2P	1 - 11 1/2	1.00	2.19	3.12	1.00	1.81	0.469	3.00	1.910	1.188	7/16-14	7/16-14 x 2.50	5.0	
20GEQ2B	20GEQ2P	1 1/4 - 11 1/2	1.25	2.56	3.69	1.25	2.00	0.531	3.32	2.050	1.312	1/2-13	1/2-13 x 3.00	3.5	
24GEQ2B	24GEQ2P	1 1/2 - 11 1/2	1.50	3.06	4.33	1.50	2.50	0.656	3.81	2.280	1.656	5/8-11	5/8-11 x 3.50	3.0	

To receive mounting hardware with flange, insert a "K" after the material designator. Mounting hardware kits are available for O-ring Face part numbers and include 4 bolts, 4 lock washers and an O-ring.

[Click here for CADs, Support Resources or to Configure Parts Online](#)

## W6EQ

Weld Socket Block Elbow Connector, Tube  
Weld Socket, Tube / Code 61 or 62 Block Flange or Pad

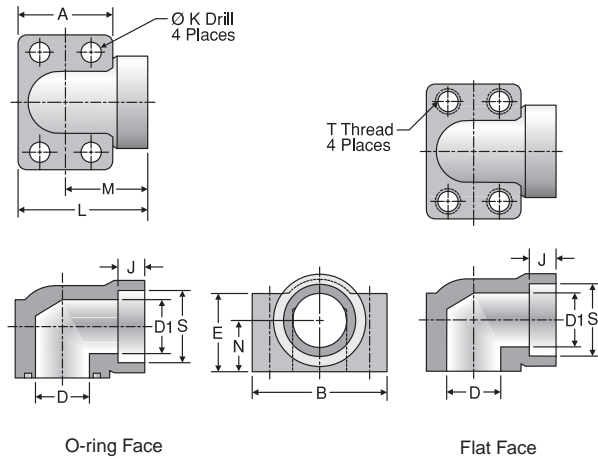

TABLE  
OF  
CONTENTS

VISUAL  
INDEX

FAQs

GEN TECH

K

TUBE FITTING PART #		TUBE O.D.	FLANGE SIZE	A	B	D	D1	E	J	K DRILL DIA.	L	M	N	S	T THREAD UNC-2B	MOUNTING HARDWARE SHCS	Dynamic Pressure (x 1,000 PSI)	
O-ring FACE	FLAT FACE	(in.)	(in.)	(in.)	(in.)	(in.)	(in.)	(in.)	(in.)	(in.)	(in.)	(in.)	(in.)	(in.)		-SX	-SS	
<b>WELD SOCKET, TUBE / CODE 61 BLOCK FLANGE OR PAD</b>																		
12W6EQ1B	12W6EQ1P	3/4	0.75	1.69	2.56	0.75	0.63	1.25	0.312	0.406	2.280	1.44	0.875	0.752	3/8-16	3/8-16 x 2.00	5.0	
16-12W6EQ1B	16-12W6EQ1P	1	0.75	1.69	2.56	0.75	0.75	1.25	0.438	0.406	2.280	1.44	0.875	1.002	3/8-16	3/8-16 x 2.00	5.0	
16W6EQ1B	16W6EQ1P	1	1.00	1.94	2.75	1.00	0.88	1.50	0.438	0.406	2.620	1.66	1.062	1.002	3/8-16	3/8-16 x 2.25	5.0	
20-16W6EQ1B	20-16W6EQ1P	1 1/4	1.00	1.94	2.75	1.00	1.00	1.50	0.500	0.406	2.620	1.66	1.062	1.252	3/8-16	3/8-16 x 2.25	5.0	
20W6EQ1B	20W6EQ1P	1 1/4	1.25	2.19	3.12	1.25	1.13	1.81	0.500	0.469	3.000	1.91	1.188	1.252	7/16-14	7/16-14 x 2.75	4.0	
24-20W6EQ1B	24-20W6EQ1P	1 1/2	1.25	2.19	3.12	1.25	1.25	1.81	0.562	0.469	3.000	1.91	1.188	1.502	7/16-14	7/16-14 x 2.75	4.0	
24W6EQ1B	24W6EQ1P	1 1/2	1.50	2.56	3.69	1.50	1.38	2.00	0.562	0.531	3.328	2.05	1.312	1.502	1/2-13	1/2-13 x 3.00	3.0	
28-24W6EQ1B	28-24W6EQ1P	1 3/4	1.50	2.56	3.69	1.50	1.50	2.00	0.562	0.531	3.328	2.05	1.312	1.752	1/2-13	1/2-13 x 3.00	3.0	
32W6EQ1B	32W6EQ1P	2	2.00	3.06	4.33	2.00	1.88	2.50	0.625	0.531	3.812	2.28	1.656	2.002	1/2-13	1/2-13 x 3.50	3.0	
36-32W6EQ1B	36-32W6EQ1P	2 1/4	2.00	3.06	4.33	2.00	2.00	2.50	0.625	0.531	3.812	2.28	1.656	2.252	1/2-13	1/2-13 x 3.50	3.0	
<b>WELD SOCKET, TUBE / CODE 62 BLOCK FLANGE OR PAD</b>																		
12W6EQ2B	12W6EQ2P	3/4	0.75	1.94	2.75	0.75	0.63	1.50	0.560	0.406	2.620	1.66	1.062	0.752	3/8-16	3/8-16 x 2.25	6.0	
16-12W6EQ2B	16-12W6EQ2P	1	0.75	1.94	2.75	0.75	0.75	1.50	0.620	0.406	2.620	1.66	1.062	1.002	3/8-16	3/8-16 x 2.25	6.0	
16W6EQ2B	16W6EQ2P	1	1.00	2.19	3.12	1.00	0.88	1.81	0.620	0.469	3.000	1.91	1.188	1.002	7/16-14	7/16-14 x 2.50	6.0	
20-16W6EQ2B	20-16W6EQ2P	1 1/4	1.00	2.19	3.12	1.00	1.00	1.81	0.690	0.469	3.000	1.91	1.188	1.252	7/16-14	7/16-14 x 2.50	6.0	
20W6EQ2B	20W6EQ2P	1 1/4	1.25	2.56	3.69	1.25	1.13	2.00	0.690	0.531	3.320	2.05	1.312	1.252	1/2-13	1/2-13 x 3.00	6.0	
24-20W6EQ2B	24-20W6EQ2P	1 1/2	1.25	2.56	3.69	1.25	1.25	2.00	0.750	0.531	3.320	2.05	1.312	1.502	1/2-13	1/2-13 x 3.00	6.0	
24W6EQ2B	24W6EQ2P	1 1/2	1.50	3.06	4.33	1.50	1.38	2.50	0.750	0.656	3.810	2.28	1.656	1.502	5/8-11	5/8-11 x 3.50	6.0	
28-24W6EQ2B	28-24W6EQ2P	1 3/4	1.50	3.06	4.33	1.50	1.50	2.50	0.750	0.656	3.810	2.28	1.656	1.752	5/8-11	5/8-11 x 3.50	6.0	

To receive mounting hardware with flange, insert a "K" after the material designator. Mounting hardware kits are available for O-ring Face part numbers and include 4 bolts, 4 lock washers and an O-ring.

[Click here for CADs, Support Resources or to Configure Parts Online](#)

## G5Q – Stainless Steel

SAE Port Block Flange Adapter  
SAE Port / Code 61 or 62 Block Flange

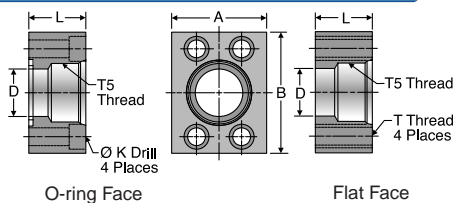

TABLE  
OF  
CONTENTS

VISUAL  
INDEX

FAQs

GEN TECH

TUBE FITTING PART #		SAE PORT DASH SIZE	FLANGE SIZE (in.)	A (in.)	B (in.)	D (in.)	K DRILL DIA. (in.)	L (in.)	T5 STRAIGHT THREAD	MOUNTING HARDWARE	Dynamic Pressure (x 1,000 PSI)
O-ring FACE	FLAT FACE	SIZE							UN-2B	SHCS	-SS
<b>SAE PORT / CODE 61 FLANGE BLOCK</b>											
8G5Q1B	*	8	0.50	1.50	2.12	0.50	0.344	1.20	3/4-16	5/16-18 x 1.25	5.0
12G5Q1B	*	12	0.75	1.75	2.62	0.75	0.406	1.20	1 1/16-12	3/8-16 x 1.50	5.0
16G5Q1B	*	16	1.00	2.00	2.82	1.00	0.406	1.45	1 5/16-12	3/8-16 x 1.50	5.0
20G5Q1B	*	20	1.25	2.50	3.19	1.25	0.469	1.45	1 5/8-12	7/16-14 x 1.75	4.0
24G5Q1B	*	24	1.50	2.75	3.75	1.50	0.531	1.70	1 7/8-12	1/2-13 x 2.00	3.0
32G5Q1B	*	32	2.00	3.25	4.00	2.00	0.531	1.70	2 1/2-12	1/2-13 x 2.00	
<b>SAE PORT / CODE 62 FLANGE BLOCK</b>											
8G5Q2B	*	8	0.50	1.75	2.22	0.50	0.344	0.95	3/4-16	5/16-18 x 1.25	6.0
12G5Q2B	*	12	0.75	2.00	2.81	0.75	0.406	1.20	1 1/16-12	3/8-16 x 1.50	6.0
16G5Q2B	*	16	1.00	2.25	3.19	1.00	0.469	1.45	1 5/16-12	7/16-14 x 1.75	6.0
20G5Q2B	*	20	1.25	2.75	3.75	1.25	0.531	1.45	1 5/8-12	1/2-13 x 1.75	6.0
24G5Q2B	*	24	1.50	3.25	4.50	1.50	0.656	1.70	1 7/8-12	5/8-11 x 2.00	5.0
32G5Q2B	*	32	2.00	4.00	5.25	2.00	0.781	1.70	2 1/2-12	3/4-10 x 2.25	3.0

\* Consult factory.

To receive mounting hardware with flange, insert a "K" after the material designator. Mounting hardware kits are available for O-ring Face part numbers and include 4 bolts, 4 lock washers and an O-ring.

**WARNING:** This product can expose you to chemicals including Lead and Lead Compounds which is known to the State of California to cause cancer and birth defects or other reproductive harm. For more information go to [www.p65warnings.ca.gov](http://www.p65warnings.ca.gov).

## GQ – Stainless Steel

NPTF Port Block Flange Adapter  
NPTF Port / Code 61 or 62 Block Flange

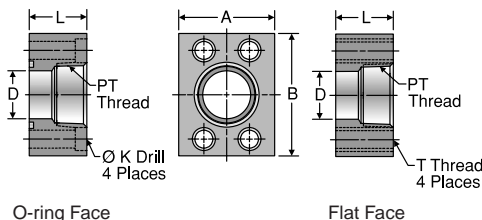

TUBE FITTING PART #		PT THREAD NPTF	FLANGE SIZE (in.)	A (in.)	B (in.)	D (in.)	K DRILL DIA. (in.)	L (in.)	MOUNTING HARDWARE	Dynamic Pressure (x 1,000 PSI)
O-ring FACE	FLAT FACE								SHCS	-SS
<b>NPTF PORT / CODE 61 BLOCK FLANGE</b>										
8GQ1B	*	1/2-14	0.50	1.50	2.12	0.50	0.344	1.20	5/16-18 x 1.75	5.0
12GQ1B	*	3/4-14	0.75	1.75	2.62	0.75	0.406	1.20	3/8-16 x 2.00	5.0
16GQ1B	*	1-11 1/2	1.00	2.00	2.82	1.00	0.406	1.45	3/8-16 x 2.25	5.0
20GQ1B	*	1 1/4-11 1/2	1.25	2.50	3.19	1.25	0.469	1.45	7/16-14 x 2.25	4.0
24GQ1B	*	1 1/2-11 1/2	1.50	2.75	3.75	1.50	0.531	1.70	1/2-13 x 2.50	3.0
32GQ1B	*	2-11 1/2	2.00	3.25	4.00	2.00	0.531	1.70	1/2-13 x 2.50	2.7
40GQ1B	*	2 1/2-8	2.50	4.00	4.50	2.50	0.531	1.95	1/2-13 x 2.75	2.5
48GQ1B	*	3-8	3.00	4.50	5.31	3.00	0.656	2.20	5/8-11 x 3.00	1.2
<b>NPTF PORT / CODE 62 BLOCK FLANGE</b>										
12GQ2B	*	3/4-14	0.75	2.00	2.81	0.75	0.406	1.20	3/8-16 x 2.00	6.0
16GQ2B	*	1-11 1/2	1.00	2.25	3.19	1.00	0.469	1.45	7/16-14 x 2.50	5.0
20GQ2B	*	1 1/4-11 1/2	1.25	2.75	3.75	1.25	0.531	1.45	1/2-13 x 2.50	4.0
24GQ2B	*	1 1/2-11 1/2	1.50	3.25	4.50	1.50	0.656	1.70	5/8-11 x 2.75	3.5
32GQ2B	*	2-11 1/2	2.00	4.00	5.25	2.00	0.781	1.70	3/4-10 x 3.00	3.0

\* Consult factory.

To receive mounting hardware with flange, insert a "K" after the material designator. Mounting hardware kits are available for O-ring Face part numbers and include 4 bolts, 4 lock washers and an O-ring.

[Click here for CADs, Support Resources or to Configure Parts Online](#)

## W5Q – Stainless Steel

Flat Weld Socket Block Flange Connector, Pipe  
Flat Weld Socket, Pipe / Code 61 or 62  
Block Flange or Pad

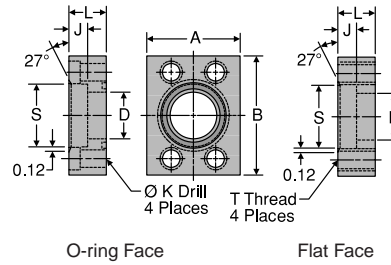

TABLE  
OF  
CONTENTS

VISUAL  
INDEX

FAQs

GEN TECH

TUBE FITTING PART #		PIPE SIZE (in.)	FLANGE SIZE (in.)	A (in.)	B (in.)	D (in.)	J (in.)	K DRILL DIA. (in.)	L (in.)	S (in.)	T THREAD UNC-2B	MOUNTING HARDWARE SHCS	Dynamic Pressure (x 1,000 PSI) -SS
O-ring FACE	FLAT FACE												
<b>FLAT WELD SOCKET, PIPE / CODE 61 BLOCK FLANGE OR PAD</b>													
8W5Q1B	8W5Q1P	1/2	0.50	1.50	2.12	0.500	0.380	0.344	0.69	0.860	5/16-18	5/16-18 x 1.25	5.0
12W5Q1B	12W5Q1P	3/4	0.75	1.75	2.62	0.750	0.500	0.406	0.94	1.070	3/8-16	3/8-16 x 1.75	5.0
16W5Q1B	16W5Q1P	1	1.00	2.00	2.82	1.000	0.500	0.406	0.94	1.335	3/8-16	3/8-16 x 1.75	5.0
20W5Q1B	20W5Q1P	1 1/4	1.25	2.50	3.19	1.250	0.500	0.469	0.94	1.680	7/16-14	7/16-14 x 1.75	4.0
24W5Q1B	24W5Q1P	1 1/2	1.50	2.75	3.75	1.500	0.500	0.531	1.19	1.920	1/2-13	1/2-13 x 2.25	3.0
32W5Q1B	32W5Q1P	2	2.00	3.25	4.00	2.000	0.620	0.531	1.44	2.411	1/2-13	1/2-13 x 2.50	3.0
40W5Q1B	40W5Q1P	2 1/2	2.50	4.00	4.50	2.500	0.750	0.531	1.69	2.911	1/2-13	1/2-13 x 2.75	2.5
48W5Q1B	48W5Q1P	3	3.00	4.50	5.31	3.000	1.240	0.656	2.12	3.540	5/8-11	5/8-11 x 3.50	2.0
<b>FLAT WELD SOCKET, PIPE / CODE 62 BLOCK FLANGE OR PAD</b>													
8W5Q2B	8W5Q2P	1/2	0.50	1.75	2.22	0.500	0.500	0.344	0.94	0.860	5/16-18	5/16-18 x 1.50	6.0
12W5Q2B	12W5Q2P	3/4	0.75	2.00	2.81	0.750	0.500	0.406	0.94	1.070	3/8-16	3/8-16 x 1.75	6.0
16W5Q2B	16W5Q2P	1	1.00	2.25	3.19	1.000	0.500	0.469	0.94	1.335	7/16-14	7/16-14 x 1.75	6.0
20W5Q2B	20W5Q2P	1 1/4	1.25	2.75	3.75	1.250	0.500	0.531	1.19	1.672	1/2-13	1/2-13 x 2.25	6.0
24W5Q2B	24W5Q2P	1 1/2	1.50	3.25	4.50	1.500	0.500	0.656	1.44	1.920	5/8-11	5/8-11 x 2.75	6.0
32W5Q2B	32W5Q2P	2	2.00	4.00	5.25	2.000	0.620	0.781	1.69	2.411	3/4-10	3/4-10 x 3.00	6.0
40W5Q2B	40W5Q2P	2 1/2	2.50	5.00	6.88	2.500	0.620	0.906	1.94	2.911	7/8-9	7/8-9 x 3.50	6.0
48W5Q2B	48W5Q2P	3	3.00	6.00	8.50	3.000	0.620	1.156	2.44	3.540	1 1/8-7	1 1/8-7 x 4.50	6.0

To receive mounting hardware with flange, insert a "K" after the material designator. Mounting hardware kits are available for O-ring Face part numbers and include 4 bolts, 4 lock washers and an O-ring.

K

[Click here for CADs, Support Resources or to Configure Parts Online](#)

## PQ – Stainless Steel

Block Plug

Code 61/62 Block Flange or Pad Plug

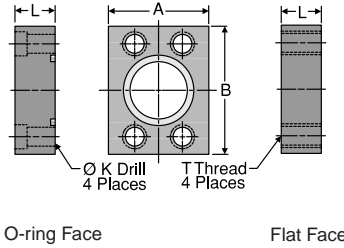

TABLE  
OF  
CONTENTS

VISUAL  
INDEX

FAQs

GEN TECH

TUBE FITTING PART #		FLANGE SIZE (in.)	A (in.)	B (in.)	K DRILL DIA. (in.)	L (in.)	T THREAD UNC-2B	MOUNTING HARDWARE SHCS	Dynamic Pressure (x 1,000 PSI) -SS
O-ring FACE	FLAT FACE								
<b>CODE 61 BLOCK FLANGE OR PAD PLUG</b>									
8PQ1B	8PQ1P	0.50	1.500	2.120	0.344	1.20	5/16-18	5/16-18 x 2.00	5.0
12PQ1B	12PQ1P	0.75	1.750	2.620	0.406	1.20	3/8-16	3/8-16 x 2.00	5.0
16PQ1B	16PQ1P	1.00	2.000	2.820	0.406	1.45	3/8-16	3/8-16 x 2.25	5.0
20PQ1B	20PQ1P	1.25	2.500	3.190	0.469	1.45	7/16-14	7/16-14 x 2.25	4.0
24PQ1B	24PQ1P	1.50	2.750	3.750	0.531	1.70	1/2-13	1/2-13 x 2.50	3.0
32PQ1B	32PQ1P	2.00	3.250	4.000	0.531	1.70	1/2-13	1/2-13 x 2.50	3.0
40PQ1B	40PQ1P	2.50	4.000	4.500	0.531	1.95	1/2-13	1/2-13 x 2.75	2.5
48PQ1B	48PQ1P	3.00	4.500	5.310	0.656	2.20	5/8-11	5/8-11 x 3.00	2.0
<b>CODE 62 BLOCK FLANGE OR PAD PLUG</b>									
8PQ2B	8PQ2P	0.50	1.750	2.220	0.344	0.94	5/16-18	5/16-18 x 1.50	6.0
12PQ2B	12PQ2P	0.75	2.000	2.810	0.406	1.19	3/8-16	3/8-16 x 2.00	6.0
16PQ2B	16PQ2P	1.00	2.250	3.190	0.492	1.44	7/16-14	7/16-14 x 2.25	6.0
20PQ2B	20PQ2P	1.25	2.750	3.750	0.531	1.44	1/2-13	1/2-13 x 2.50	6.0
24PQ2B	24PQ2P	1.50	3.250	4.500	0.656	1.69	5/8-11	5/8-11 x 2.75	6.0
32PQ2B	32PQ2P	2.00	4.000	5.250	0.781	1.69	3/4-10	3/4-10 x 3.00	6.0
40PQ2B	40PQ2P	2.50	5.000	6.880	0.906	1.94	7/8-9	7/8-9 x 3.50	6.0
48PQ2B	48PQ2P	3.00	6.000	8.500	1.190	2.44	1 1/8-7	1 1/8-7 x 3.75	6.0

To receive mounting hardware with flange, insert a "K" after the material designator. Mounting hardware kits are available for O-ring Face part numbers and include 4 bolts, 4 lock washers and an O-ring.



[Click here for CADs, Support Resources or to Configure Parts Online](#)

## XHQ40

Dual Seal Flange Connector  
Dual Seal / 37° Flare

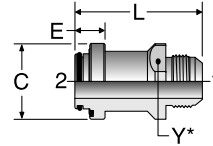

TUBE FITTING PART #	END SIZE		C (in.)	D1 DRILL (in.)	D2 DRILL (in.)	E (in.)	L (in.)	Y (in.)	Dynamic Pressure (x 1,000 PSI)
	1 (in.)	2 DUAL SEAL							-SS
8 XHQ40	1/2	1/2	1.25	0.391	0.391	0.69	2.98	1.00	7.2
16 XHQ40	1	1	1.88	0.844	0.844	0.75	3.18	1.63	4.8
24 XHQ40	1 1/2	1 1/2	2.50	1.310	1.310	1.00	4.00	2.13	3.6

## LOHQ40

Dual Seal Flange Connector  
Dual Seal / ORFS

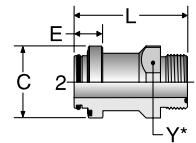

TUBE FITTING PART #	END SIZE		C (in.)	D1 DRILL (in.)	D2 DRILL (in.)	E (in.)	L (in.)	Y (in.)	Dynamic Pressure (x 1,000 PSI)
	1 (in.)	2 DUAL SEAL							-SS
8 LOHQ40	1/2	1/2	1.25	0.374	0.374	0.69	2.83	1.00	7.5
16 LOHQ40	1	1	1.88	0.807	0.807	0.75	2.96	1.63	6.0
24 LOXHQ40	1 1/2	1 1/2	2.50	1.260	1.260	1.00	3.61	2.13	5.0

## FHQ40

Dual Seal Flange Connector  
Dual Seal / Male NPTF

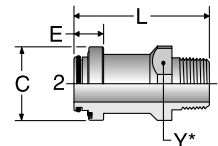

TUBE FITTING PART #	END SIZE		C (in.)	D1 DRILL (in.)	D2 DRILL (in.)	E (in.)	L (in.)	Y (in.)	Dynamic Pressure (x 1,000 PSI)
	1 (in.)	2 DUAL SEAL							-SS
8 FHQ40	1/2	1/2	1.25	0.500	0.500	0.69	3.18	1.00	7.2
16 FHQ40	1	1	1.88	0.938	0.938	0.75	3.45	1.63	5.4
24 FHQ40	1 1/2	1 1/2	2.50	1.312	1.312	1.00	4.10	2.13	3.6

TABLE OF CONTENTS

VISUAL INDEX

FAQs

GEN TECH

K

[Click here for CADs, Support Resources or to Configure Parts Online](#)

## GHQ40

Dual Seal Flange Connector  
Dual Seal / Female NPTF

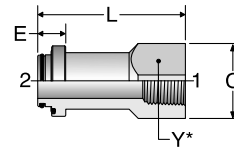

TUBE FITTING PART #	END SIZE		C (in.)	D1 DRILL (in.)	D2 DRILL (in.)	E (in.)	L (in.)	Y (in.)	Dynamic Pressure (x 1,000 PSI)
	1 (in.)	2 DUAL SEAL							-SS
8 GHQ40	1/2	1/2	1.25	0.500	0.500	0.69	2.96	1.00	6.0
16 GHQ40	1	1	1.88	0.938	0.938	0.75	3.94	1.63	3.6
24 GHQ40	1 1/2	1 1/2	2.50	1.312	1.312	1.00	4.81	2.25	3.0

TABLE OF CONTENTS

VISUAL INDEX

FAQs

GEN TECH

## F5OHQ40

Dual Seal Flange Connector  
Dual Seal / Male SAE-ORB

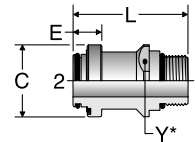

TUBE FITTING PART #	END SIZE		C (in.)	D1 DRILL (in.)	D2 DRILL (in.)	E (in.)	L (in.)	Y (in.)	Dynamic Pressure (x 1,000 PSI)
	1 (in.)	2 DUAL SEAL							-SS
8 F5OHQ40	1/2	1/2	1.25	0.394	0.394	0.69	2.87	1.00	6.0
16 F5OHQ40	1	1	1.88	0.844	0.844	0.75	3.00	1.63	6.0
24 F5OHQ40	1 1/2	1 1/2	2.50	1.312	1.312	1.00	3.65	2.17	5.0

## G5HQ40

Dual Seal Flange Connector  
Dual Seal / Female SAE-ORB

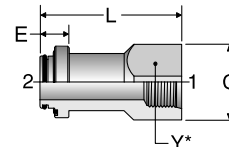

TUBE FITTING PART #	END SIZE		C (in.)	D1 DRILL (in.)	D2 DRILL (in.)	E (in.)	L (in.)	Y (in.)	Dynamic Pressure (x 1,000 PSI)
	1 (in.)	2 DUAL SEAL							-SS
8 G5HQ40	1/2	1/2	1.25	0.406	0.406	0.69	2.77	1.00	5.0
16 G5HQ40	1	1	1.88	0.938	0.938	0.75	3.72	1.63	3.5
24 G5HQ40	1 1/2	1 1/2	2.50	1.312	1.312	1.00	4.59	2.25	2.5

[Click here for CADs, Support Resources or to Configure Parts Online](#)

## W7HQ40

Dual Seal Flange Connector  
Dual Seal / Socket Weld Pipe

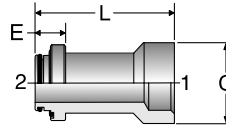

TUBE FITTING PART #	END SIZE		C (in.)	D1 DRILL (in.)	D2 DRILL (in.)	E (in.)	L (in.)	Dynamic Pressure (x 1,000 PSI)
	1 PIPE	2 DUAL SEAL						-SS
	8 W7HQ40	1/2						1/2
16 W7HQ40	1	1	1.88	0.938	0.938	0.75	3.44	7.5
24 W7HQ40	1 1/2	1 1/2	2.50	1.312	1.312	1.00	4.43	7.5

TABLE OF CONTENTS

VISUAL INDEX

FAQs

GEN TECH

## PQ40

Dual Seal Flange Connector  
Dual Seal Plug

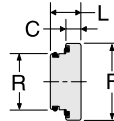

TUBE FITTING PART #	END SIZE		F (in.)	C (in.)	L (in.)	R (in.)	Dynamic Pressure (x 1,000 PSI)
	2 DUAL SEAL	-SS					
	8 PQ40	1/2					1.25
16 PQ40	1	1.88	0.38	0.75	1.37	7.5	
24 PQ40	1 1/2	2.50	0.50	1.00	1.75	7.5	

K

## Q4 Insert

Dual Seal Flange Insert



TUBE FITTING PART #	END SIZE		L (in.)	C (in.)	Dynamic Pressure (x 1,000 PSI)
	2 DUAL SEAL	-SS			
	8 Q4 INSERT	1/2			1.00
16 Q4 INSERT	1	1.00	1.37	7.5	
24 Q4 INSERT	1 1/2	1.00	1.74	7.5	

[Click here for CADs, Support Resources or to Configure Parts Online](#)

TABLE  
OF  
CONTENTS

VISUAL  
INDEX

FAQs











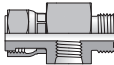
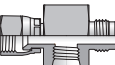
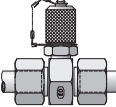



GEN TECH

L

# DIAGNOSTIC, ORIFICE, BLEED ADAPTERS & SPECIALTY FITTINGS

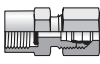

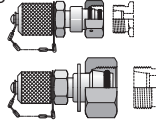
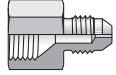
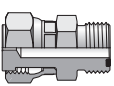
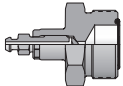
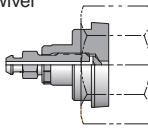
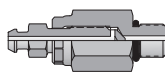
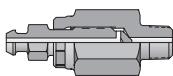

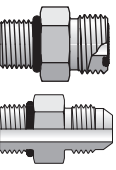
<b>Diagnostic Tees</b>	<b>LOHL6G5TP</b> ORFS Swivel / ORFS / SAE-ORB  L5	<b>XHX6G5TP</b> 37° Swivel / 37° Flare / SAE-ORB  L5	<b>GMA3</b> EO Tube / EO Tube / EMA-3 Diagnostic Tip  L5	<b>Diagnostic Tee Port Adapters and Plugs</b>	<b>F50G</b> SAE-ORB / NPTF  E15
<b>P50N</b> Hex Head Plug  E28	<b>HP50N</b> Hollow Hex Plug  E28	<b>NPT / SAE-ORB Pressure Gauge Adapters</b>	<b>G5L</b> SAE-ORB Gauge / ORFS  L7	<b>G65L</b> SAE-ORB Gauge / ORFS Swivel  L7	<b>GLO</b> NPT Gauge / ORFS  L7
<b>G6L</b> NPT Gauge / ORFS Swivel  L7	<b>GTX</b> NPT Gauge / 37° Flare  L7	<b>G6X</b> NPT Gauge / 37° Swivel  L7	<b>BSP Pressure Gauge Adapters</b>	<b>MAVE</b> BSPP Gauge / EO Swivel  L6	<b>MAV</b> BSPP Gauge / EO  L6
<b>G4MXSMO</b> BSPP Gauge / 37° Flare  L6	<b>G4MLOSMO</b> BSPP Gauge / ORFS  L6	<b>Swivel Tube Adapters</b>	<b>VKA3</b> EO Swivel / Diagnostic Tip  L8	<b>Orifice Fittings</b>	<b>XHX7</b> 37° Seat / 37° Flare with Orifice  L9
<b>LOHL6</b> ORFS Swivel with Orifice / ORFS  L9	<b>ORFS / Port Bleed Adapters</b>	<b>PNLOBA</b> Bleed Screw / ORFS  L10	<b>FNLBA</b> Bleed Screw / ORFS Swivel  L10	<b>P50NBA</b> Bleed Screw / SAE-ORB  L10	<b>HPBA</b> Bleed Screw / NPT  L10
<b>Parker Triple Thread Fitting</b>	<b>0109</b> NPTF / PTT 30° Flare  L11	<b>Screen Fittings</b>	<b>Screen Fittings</b>  L12		

## Introduction

Parker offers a line of specialty-type adapters specifically designed for diagnostic, fixed flow control and bleeding applications.

Diagnostic products consist of a line of in-line diagnostic tees, pressure gauge connectors and diagnostic tips. These products have been developed to work in conjunction with electronic diagnostic products available from Parker's Quick Coupling Division and other mechanical pressure and temperature sensing equipment. Some products can be used for fluid sampling and bleeding purposes as well.

Parker offers a standard and custom line of fixed flow control orifice fittings. These products are available as standard in two Parker product series — ORFS and 37° flare, and as a custom option in virtually any orifice size, fitting series, size, material and configuration.

Parker's bleed adapters provide a quick, clean, and simple method of bleeding entrapped air from hydraulic systems. A common problem in hydraulic systems is trapped air and the subsequent spillage of hydraulic oil while removing components to bleed air from lines under pressure.

Parker offers a limited line of PTT (Parker Triple Thread) 30° flare adapters for transportation markets. Lastly, Parker offers a line of screen fittings as a final measure of protection.



Fig. L1 — Parker offers a full line of diagnostic, orifice, bleed adapters and specialty fittings

## Diagnostic Fittings and Adapters

### In-Line Diagnostic Tees

#### Features

- Designed around the two most common hydraulic tube/hose interfaces: O-ring face seal (Parker Seal-Lok) and 37° flare (JIC / Parker Triple-Lok) (see A)
- ORFS and 37° flare swivel feature offers unlimited positioning without displacing port adapter (see B)
- Uses elastomeric sealing: SAE -4 (7/16-20 UNF) port as universal diagnostic port per SAE J1926-1 / ISO 11926 (see C)
- Enlarged and lengthened body hex ensures that diagnostic port offers full thread engagement and pressure capability (see D)
- Adaptable to Parker's line of diagnostic and fluid sampling tips including: EMA3, PD and PDFS, as well as various direct connecting electronic/mechanical pressure gauges\*
- Designed to complement Parker's line of Senso-Control® and Senso-Node diagnostic equipment

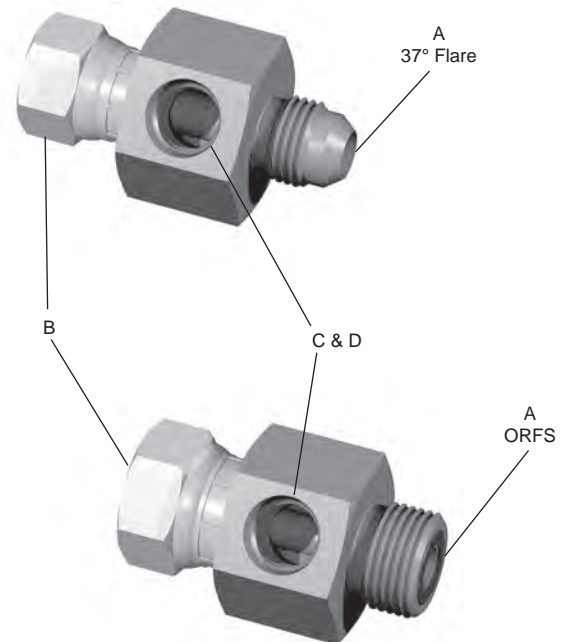

Fig. L2 — Parker's XHX6G5TP (top) and LOHL6G5TP (bottom) in-line diagnostic tees

\*Diagnostic and sampling tips EMA3, PD and PDFS series are available from Parker's Quick Coupling Division (tel. 763-544-7781 and/or [www.parker.com/quickcouplings](http://www.parker.com/quickcouplings))

[Click here for CADs, Support Resources or to Configure Parts Online](#)

### Applications

- In-line pressure and temperature measurements
- In-line oil sampling to evaluate hydraulic contamination, caused by problems with filtration or internal components
- In-field diagnostics without removal of port adapters. Simply remove hose swivel and insert in-line tee.
- Permanent or temporary OEM and MRO diagnostic applications:
  - Where traditional in-port diagnostic tips cannot be located or easily accessed
  - Where OEM diagnostic tips have not been installed
  - Non-traditional diagnostic locations (portable)
  - Where port threads are not compatible with standard diagnostic tips
- To eliminate reducer bushings and couplings typically required to neck down from larger size connections to smaller connections; e.g. reductions required for a gauge, diagnostic tip, bleed adapter, or tube/hose connection.

### Assembly Instructions

The body of the diagnostic tee can be used repeatedly for 10-20 remakes at full rated pressure and assembly torque. See Tables L1 and L2 for recommended swivel nut assembly torques.

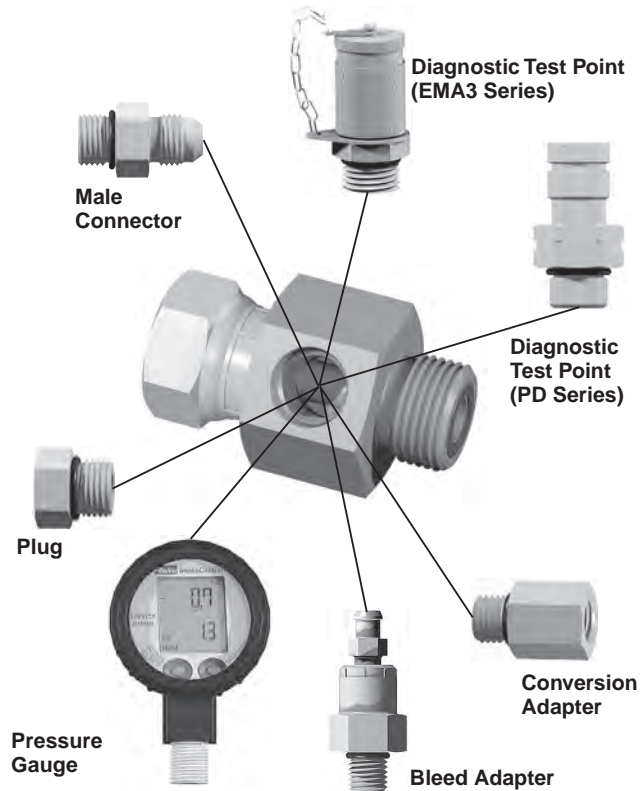

Fig. L3 — Illustration showing the versatility of Parker's diagnostic tee product line

TABLE OF CONTENTS

VISUAL INDEX

FAQs

Part Number	Assembly Torque (+10%-0)	
	in.-lb.	ft.-lb.
4-4 XHX6G5TP	130	11
6-4 XHX6G5TP	235	20
8-4 XHX6G5TP	525	43
10-4 XHX6G5TP	—	55
12-4 XHX6G5TP	—	80
16-4 XHX6G5TP	—	115
20-4 XHX6G5TP	—	160
24-4 XHX6G5TP	—	185

Note: Assembly values are for dry, unlubricated swivel nut connections

Table L1 — Assembly Torques (Swivel nut) for Diagnostic Tees

Part Number	Assembly Torque (+10%-0)	
	in.-lb.	ft.-lb.
4-4 LHL6G5TP	220	18
6-4 LHL6G5TP	360	30
8-4 LHL6G5TP	480	40
10-4 LHL6G5TP	—	60
12-4 LHL6G5TP	—	85
14-4 LHL6G5TP	—	100
16-4 LHL6G5TP	—	110
20-4 LHL6G5TP	—	150
24-4 LHL6G5TP	—	230
32-4 LHL6G5TP	—	360

Table L2 — Assembly Torques (Swivel nut) for Diagnostic Tees

Click here for CADs, Support Resources or to Configure Parts Online

## LOHL6G5TP

Gauge Port Tee  
ORFS / ORFS Swivel /  
SAE-ORB

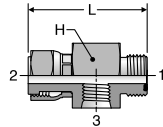

TUBE FITTING PART #	END SIZE			H (in.)	L (in.)	Pressure (x 1,000 PSI) Dynamic -S
	1 (in.)	2 (in.)	3 UN/UNF			
4-4 LOHL6G5TP	1/4	1/4	7/16-20	1-1/16	1.83	6.0
6-4 LOHL6G5TP	3/8	3/8	7/16-20	1-1/16	1.95	6.0
8-4 LOHL6G5TP	1/2	1/2	7/16-20	1-1/16	2.18	6.0
10-4 LOHL6G5TP	5/8	5/8	7/16-20	1-1/8	2.40	6.0
12-4 LOHL6G5TP	3/4	3/4	7/16-20	1-1/4	2.59	6.0
16-4 LOHL6G5TP	1	1	7/16-20	1-1/2	2.85	6.0
20-4 LOHL6G5TP	1 1/4	1 1/4	7/16-20	1-3/4	3.07	5.0
24-4 LOHL6G5TP	1 1/2	1 1/2	7/16-20	2-1/8	3.22	4.0

**WARNING:** This product can expose you to chemicals including Lead and Lead Compounds which is known to the State of California to cause cancer and birth defects or other reproductive harm. For more information go to [www.p65warnings.ca.gov](http://www.p65warnings.ca.gov).

## XHX6G5TP

Gauge Port Tee  
37° Flare / 37° Swivel /  
SAE-ORB

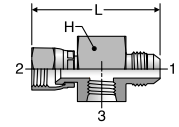

TUBE FITTING PART #	END SIZE			H (in.)	L (in.)	Pressure (x 1,000 PSI) Dynamic -S
	1 (in.)	2 (in.)	3 UN/UNF			
4-4 XHX6G5TP	1/4	1/4	7/16-20	1-1/16	1.99	6.0
6-4 XHX6G5TP	3/8	3/8	7/16-20	1-1/16	2.08	5.0
8-4 XHX6G5TP	1/2	1/2	7/16-20	1-1/16	2.30	5.0
10-4 XHX6G5TP	5/8	5/8	7/16-20	1-1/8	2.49	5.0
12-4 XHX6G5TP	3/4	3/4	7/16-20	1-1/4	2.66	5.0
16-4 XHX6G5TP	1	1	7/16-20	1-1/2	2.99	4.0
20-4 XHX6G5TP	1 1/4	1 1/4	7/16-20	1-3/4	3.33	4.0
24-4 XHX6G5TP	1 1/2	1 1/2	7/16-20	2	3.71	2.5

**WARNING:** This product can expose you to chemicals including Lead and Lead Compounds which is known to the State of California to cause cancer and birth defects or other reproductive harm. For more information go to [www.p65warnings.ca.gov](http://www.p65warnings.ca.gov).

## GMA3

Diagnostic Tip  
EO Tube / EO Tube /  
M16 x 2.0 Integrated Tip

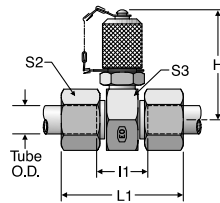

TUBE FITTING PART #	END SIZE (mm)	H (mm)	I1 (mm)	L1 (mm)	S2 (mm)	S3 (mm)	Pressure (x 1,000 PSI)
							Dynamic CF
GMA3/06L	6	49	21	51	14	24	4.5
GMA3/08L	8	49	21	51	17	24	4.5
GMA3/10L	10	49	23	53	19	24	4.5
GMA3/12L	12	50	23	53	22	27	4.5
GMA3/15L	15	52	25	55	27	30	4.5
GMA3/18L	18	53	24	57	32	32	4.5
GMA3/22L	22	55	28	61	36	36	2.3
GMA3/28L	28	57	28	61	41	41	2.3
GMA3/35L	35	60	26	69	50	46	2.3
GMA3/42L	42	64	25	71	60	55	2.3
GMA3/06S	6	49	25	55	17	24	9.1
GMA3/08S	8	49	25	55	19	24	9.1
GMA3/10S	10	49	24	57	22	24	9.1
GMA3/12S	12	49	24	57	24	24	9.1
GMA3/14S	14	50	27	63	27	27	9.1
GMA3/16S	16	52	26	63	30	30	5.8
GMA3/20S	20	55	26	69	36	36	5.8
GMA3/25S	25	57	27	75	46	41	5.8
GMA3/30S	30	60	28	81	50	46	5.8
GMA3/38S	38	64	29	91	60	55	4.5

To specify EO-2, add "Z" between tube size and series.  
Example: GMA3/28ZLA3C

**WARNING:** This product can expose you to chemicals including Lead and Lead Compounds which is known to the State of California to cause cancer and birth defects or other reproductive harm. For more information go to [www.p65warnings.ca.gov](http://www.p65warnings.ca.gov).

TABLE OF CONTENTS

VISUAL INDEX

FAQs

GEN TECH

L

[Click here for CADs, Support Resources or to Configure Parts Online](#)

## BSPP Diagnostic Pressure Gauge Adapters

Parker's BSPP direct-connect pressure gauge adapters are available in the most common tube/hose connections — O-ring face seal, 37° Flare (JIC) and 24° Metric Flareless (DIN 2353). European pressure gauges often utilize BSPP threads on the pressure gauges (manometers). Sealing is achieved at the bottom of the port with a sealing washer as shown in Fig. L4.

### BSPP Pressure Gauge Adapters

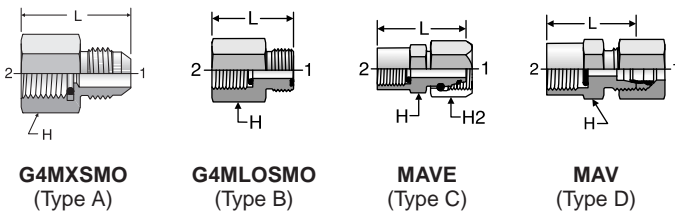

**G4MXSMO**  
(Type A)

**G4MLOSMO**  
(Type B)

**MAVE**  
(Type C)

**MAV**  
(Type D)

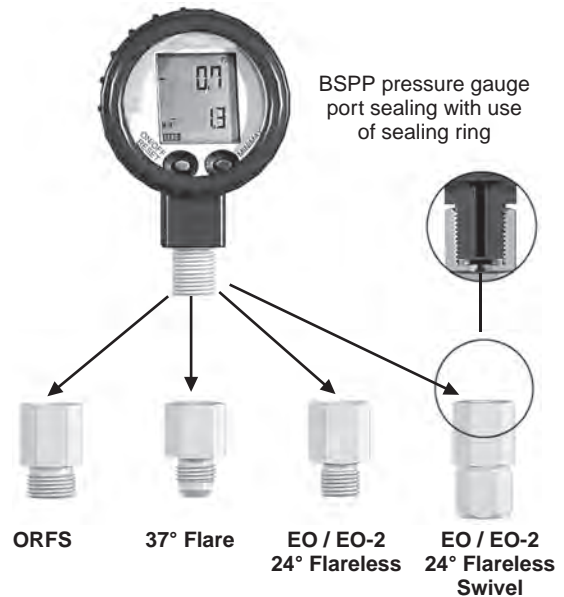

Fig. L4 — BSPP pressure gauge connections

TUBE FITTING PART #	TYPE	END SIZE		L (mm)	H BODY HEX (mm)	H2 NUT HEX (mm)	Pressure (x 1,000 PSI) Dynamic S
		1 (in.)	2 BSPP				
4-4G4MXSMO	A	1/4	1/4-19	31.0	17	—	5.0
6G4MXSMO	A	3/8	1/4-19	28.0	17	—	5.0
8-4G4MXSMO	A	1/2	1/4-19	31.0	19	—	5.0
4-4G4MLOSMO	B	1/4	1/4-19	26.8	17	—	5.0
6G4MLOSMO	B	3/8	1/4-19	28.2	19	—	5.0
8-4G4MLOSMO	B	1/2	1/4-19	29.8	22	—	5.0
		1 (mm)	2 BSPP				Dynamic CF
MAVE06LR	C	6	1/4-19	35.5	19	14	4.6
MAVE08LR	C	8	1/4-19	35.5	19	17	4.6
MAVE10LR	C	10	1/4-19	36.0	19	19	4.6
MAVE06SR	C	6	1/2-14	42.5	27	17	9.1
MAVE08SR	C	8	1/2-14	43.0	27	19	9.1
MAVE10SR	C	10	1/2-14	43.5	27	22	9.1
MAVE12SR	C	12	1/2-14	45.0	27	24	9.1
MAVE06SR1/4	C	6	1/4-19	35.5	19	17	9.1
MAVE08SR1/4	C	8	1/4-19	35.5	19	19	9.1
MAVE10SR1/4	C	10	1/4-19	39.0	19	22	9.1
MAVE12SR1/4	C	12	1/4-19	39.0	19	24	9.1
MAV04LLR	D	4	1/4-19	33.0	19	10	1.4
MAV06LR	D	6	1/4-19	37.0	19	14	4.5
MAV08LR	D	8	1/4-19	37.0	19	17	4.5
MAV10LR	D	10	1/4-19	38.0	19	19	4.5
MAV12LR	D	12	1/4-19	38.0	19	22	4.5
MAV06SR	D	6	1/2-14	46.0	27	17	9.1
MAV08SR	D	8	1/2-14	46.0	27	19	9.1
MAV10SR	D	10	1/2-14	47.0	27	22	9.1
MAV12SR	D	12	1/2-14	47.0	27	24	9.1

**Note:** MAV supplied as standard with PSR +M nut (EO assembled)

\* BSPP Pressure Gauge Connection requires seal. 1/4" replacement seal P/N: M25180.

\*\* BSPP Pressure Gauge Connection requires seal. 1/4" replacement seal P/N: DK11/4CFX, 1/2" replacement seal P/N: DK11/2CFX.

**WARNING:** This product can expose you to chemicals including Lead and Lead Compounds which is known to the State of California to cause cancer and birth defects or other reproductive harm. For more information go to [www.p65warnings.ca.gov](http://www.p65warnings.ca.gov).

TABLE  
OF  
CONTENTS

VISUAL  
INDEX

FAQs

GEN TECH



[Click here for CADs, Support Resources or to Configure Parts Online](#)

## NPT and SAE-ORB Diagnostic Pressure Gauge Adapters

Parker's NPT and SAE-ORB direct-connect pressure gauge adapters are available in the most common North American tube/hose connections — O-ring face seal and 37° Flare (JIC). North American pressure gauge manufacturers offer gauges primarily with NPT and some with SAE-ORB port stud options. These 37° flare and ORFS connectors are designed to attach pressure gauges to hose swivel ends or directly to run / branch tees for in-line diagnostic applications as shown on the right.

### NPT / SAE Pressure Gauge Adapters

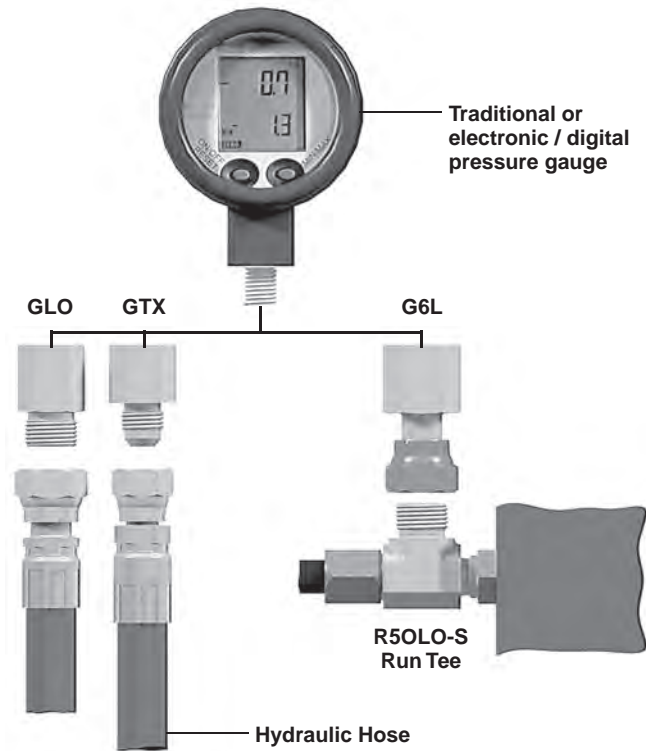
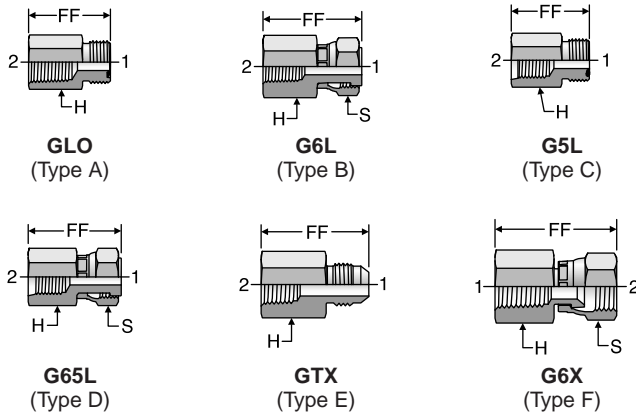

Fig. L5 — Typical applications for NPT pressure gauge adapters. Illustrations show direct hose connections and Run Tee connection.

TUBE FITTING PART #	TYPE	END SIZE		FF (in.)	H BODY HEX (in.)	S SWIVEL NUT HEX (in.)	Pressure (x 1,000 PSI) Dynamic -S
		1 (in.)	2 NPT				
4-4 GLO	A	1/4	1/4-18	1.25	3/4	—	6.0
6 GLO	A	3/8	1/4-18	1.30	3/4	—	6.0
8-4 GLO	A	1/2	1/4-18	1.20	7/8	—	6.0
4-4 G6L	B	1/4	1/4-18	1.48	3/4	11/16	6.0
6 G6L	B	3/8	1/4-18	1.60	7/8	13/16	6.0
8-4 G6L	B	1/2	1/4-18	1.75	7/8	15/16	6.0
		UN/UNF					
4 G5LO	C	1/4	7/16-20	1.10	3/4	—	6.0
6-4 G5LO	C	3/8	7/16-20	1.08	3/4	—	6.0
8-4 G5LO	C	1/2	7/16-20	0.78	7/8	—	6.0
4 G65L	D	1/4	7/16-20	1.38	11/16	11/16	6.0
6-4 G65L	D	3/8	7/16-20	1.51	3/4	13/16	6.0
8-4 G65L	D	1/2	7/16-20	1.57	7/8	15/16	6.0
		NPT					
2 GTX	E	1/8	1/8-27	1.13	9/16	—	6.0
3 GTX	E	3/16	1/8-27	1.13	9/16	—	6.0
4-4 GTX	E	1/4	1/4-18	1.39	3/4	—	6.0
4 GTX	E	1/4	1/8-27	1.19	9/16	—	6.0
6-2 GTX	E	3/8	1/8-27	1.13	5/8	—	6.0
6 GTX	E	3/8	1/4-18	1.41	3/4	—	6.0
8-4 GTX	E	1/2	1/4-18	1.41	13/16	—	6.0
4-4 G6X	F	1/4	1/4-18	9/16	3/4	9/16	6.0
4 G6X	F	1/4	1/8-27	9/16	9/16	9/16	6.0
6 G6X	F	3/8	1/4-18	11/16	3/4	11/16	5.0

**WARNING:** This product can expose you to chemicals including Lead and Lead Compounds which is known to the State of California to cause cancer and birth defects or other reproductive harm. For more information go to [www.p65warnings.ca.gov](http://www.p65warnings.ca.gov).

- TABLE OF CONTENTS
- VISUAL INDEX
- FAQs
- GEN TECH

L

[Click here for CADs, Support Resources or to Configure Parts Online](#)

## EO Diagnostic Swivels

EO Diagnostic Swivels are commonly used on EO tees (24° flareless - DIN 2353) where periodic pressure and temperature checks are required. The M16 x 2 diagnostic tip mates with the SMA3 diagnostic nose offered by Parker's Quick Coupling Division.

### VKA3

M16 x 2.0 Diagnostic  
Tip / EO Swivel

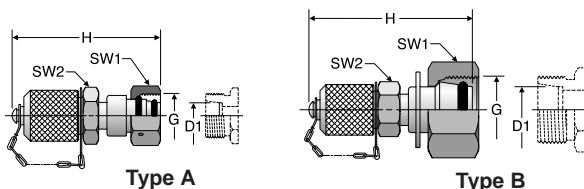

TUBE FITTING PART # STEEL	TYPE	D1 TUBE O.D. (mm)	G Metric	H REF. (mm)	SW1 (mm)	SW2 (mm)	Pressure (x 1,000 PSI)
							Dynamic CF
VKA3/06L	A	6	M12 x 1.5	55	17	17	4.5
VKA3/08L	A	8	M14 x 1.5	51	17	17	4.5
VKA3/10L	A	10	M16 x 1.5	53	17	19	4.5
VKA3/12L	A	12	M18 x 1.5	53	17	22	4.5
VKA3/15L	B	15	M22 x 1.5	59	17	27	4.5
VKA3/18L	B	18	M26 x 1.5	59	17	32	4.5
VKA3/22L	B	22	M30 x 2	60	17	39	2.3
VKA3/28L	B	28	M36 x 2	64	17	41	2.3
VKA3/35L	B	35	M45 x 2	71	17	50	2.3
VKA3/42L	B	42	M52 x 2	72	17	60	2.3
VKA3/06S	A	6	M14 x 1.5	50	17	17	9.1
VKA3/08S	A	8	M16 x 1.5	52	17	19	9.1
VKA3/10S	A	10	M18 x 1.5	53	17	22	9.1
VKA3/12S	A	12	M20 x 1.5	54	19	24	9.1
VKA3/14S	B	14	M22 x 1.5	59	17	27	9.1
VKA3/16S	B	16	M24 x 1.5	58	17	30	5.8
VKA3/20S	B	20	M30 x 2	65	17	36	5.8
VKA3/25S	B	25	M36 x 2	68	17	46	5.8
VKA3/30S	B	30	M42 x 2	74	17	50	5.8
VKA3/38S	B	38	M52 x 2	81	17	60	4.5

**WARNING:** This product can expose you to chemicals including Lead and Lead Compounds which is known to the State of California to cause cancer and birth defects or other reproductive harm. For more information go to [www.p65warnings.ca.gov](http://www.p65warnings.ca.gov).

TABLE OF CONTENTS

VISUAL INDEX

FAQs

GEN TECH

Click here for CADs, Support Resources or to Configure Parts Online

## Orifice Fittings

These compact and cost effective orifice adapters allow OEMs to pre-set, at the factory, a specified orifice in specific hydraulic tube or hose lines. Costly flow control valves can be eliminated or minimized in a system by selecting the proper orifice sizes at the factory. OEMs can also be assured that end users are not adjusting the factory established flow and speed characteristics of the hydraulic system.

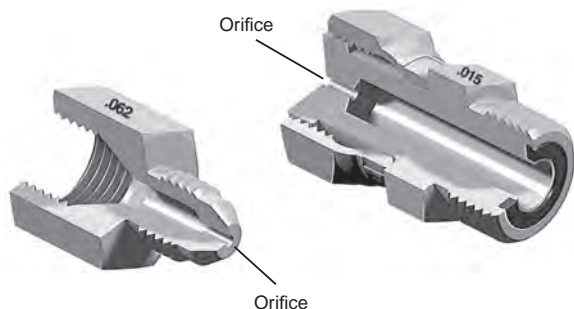

### The Parker Advantage

- 37° flare and O-ring face seal configurations as standard
- Three standard body sizes available: 1/4" 3/8", and 1/2"
- Available in commonly accepted pre-set orifice sizes as shown on accompanying tables
- Designed for permanent or temporary installation
- Can be installed in-line into hydraulic system by simply connecting between hose swivel and adapter
- Orifice size is permanently stamped on body
- Can eliminate costly flow control valves

#### Applications:

- Fixed rotation speed for hydraulic motors
- Fixed speed on cylinder extend or retract

#### Direct Port Orifice Fittings:

Available as a custom product, Parker also offers a line of orifice adapters that will replace a traditional port adapter.

## XHX7 Orifice

In-Line Orifice Connector  
37° Flare / Female 37° Seat

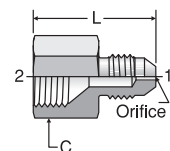

TUBE FITTING PART #	END SIZE	C HEX (in.)	ORIFICE (in.)	L (in.)	Pressure (x 1,000 PSI)
	1 & 2 (in.)				Dynamic -S
4 XHX7-S .015 Orifice	1/4	9/16	.015	1.10	5.0
4 XHX7-S .031 Orifice	1/4	9/16	.031	1.10	5.0
4 XHX7-S .047 Orifice	1/4	9/16	.047	1.10	5.0
4 XHX7-S .062 Orifice	1/4	9/16	.062	1.10	5.0
4 XHX7-S .078 Orifice	1/4	9/16	.078	1.10	5.0
4 XHX7-S .094 Orifice	1/4	9/16	.094	1.10	5.0
6 XHX7-S .015 Orifice	3/8	11/16	.015	1.18	5.0
6 XHX7-S .031 Orifice	3/8	11/16	.031	1.18	5.0
6 XHX7-S .047 Orifice	3/8	11/16	.047	1.18	5.0
6 XHX7-S .062 Orifice	3/8	11/16	.062	1.18	5.0
6 XHX7-S .078 Orifice	3/8	11/16	.078	1.18	5.0
6 XHX7-S .094 Orifice	3/8	11/16	.094	1.18	5.0
8 XHX7-S .015 Orifice	1/2	7/8	.015	1.32	5.0
8 XHX7-S .031 Orifice	1/2	7/8	.031	1.32	5.0
8 XHX7-S .047 Orifice	1/2	7/8	.047	1.32	5.0
8 XHX7-S .062 Orifice	1/2	7/8	.062	1.32	5.0
8 XHX7-S .078 Orifice	1/2	7/8	.078	1.32	5.0
8 XHX7-S .094 Orifice	1/2	7/8	.094	1.32	5.0

**WARNING:** This product can expose you to chemicals including Lead and Lead Compounds which is known to the State of California to cause cancer and birth defects or other reproductive harm. For more information go to [www.p65warnings.ca.gov](http://www.p65warnings.ca.gov).

## LOHL6 Orifice

In-Line Orifice Connector  
ORFS Swivel / ORFS

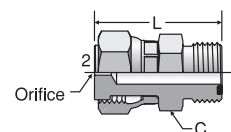

TUBE FITTING PART #	END SIZE	C HEX (in.)	ORIFICE (in.)	L (in.)	Pressure (x 1,000 PSI)
	1 & 2 (in.)				Dynamic -S
4 LOHL6-S .015 Orifice	1/4	5/8	.015	1.33	9.2
4 LOHL6-S .031 Orifice	1/4	5/8	.031	1.33	9.2
4 LOHL6-S .047 Orifice	1/4	5/8	.047	1.33	9.2
4 LOHL6-S .062 Orifice	1/4	5/8	.062	1.33	9.2
4 LOHL6-S .078 Orifice	1/4	5/8	.078	1.33	9.2
4 LOHL6-S .094 Orifice	1/4	5/8	.094	1.33	9.2
6 LOHL6-S .015 Orifice	3/8	3/4	.015	1.44	9.2
6 LOHL6-S .031 Orifice	3/8	3/4	.031	1.44	9.2
6 LOHL6-S .047 Orifice	3/8	3/4	.047	1.44	9.2
6 LOHL6-S .062 Orifice	3/8	3/4	.062	1.44	9.2
6 LOHL6-S .078 Orifice	3/8	3/4	.078	1.44	9.2
6 LOHL6-S .094 Orifice	3/8	3/4	.094	1.44	9.2
8 LOHL6-S .015 Orifice	1/2	7/8	.015	1.67	9.2
8 LOHL6-S .031 Orifice	1/2	7/8	.031	1.67	9.2
8 LOHL6-S .047 Orifice	1/2	7/8	.047	1.67	9.2
8 LOHL6-S .062 Orifice	1/2	7/8	.062	1.67	9.2
8 LOHL6-S .078 Orifice	1/2	7/8	.078	1.67	9.2
8 LOHL6-S .094 Orifice	1/2	7/8	.094	1.67	9.2

**WARNING:** This product can expose you to chemicals including Lead and Lead Compounds which is known to the State of California to cause cancer and birth defects or other reproductive harm. For more information go to [www.p65warnings.ca.gov](http://www.p65warnings.ca.gov).

TABLE  
OF  
CONTENTS

VISUAL  
INDEX

FAQs

GEN TECH

L

## Bleed Adapters

Entrapped air is a major contributor to inefficient operation. Typically, bleeding hydraulic systems is done by cracking a connection to “bleed off” the entrapped air. This practice is not recommended, especially in larger size fittings where high forces can exist. Parker’s bleed adapters are especially beneficial in applications where elastomeric seals (O-rings) can be extruded and/or damaged during bleeding such as with O-ring face seal fittings.

Parker’s bleed adapters are designed specifically for installation directly to ORFS (O-ring Face Seal) type fittings or into SAE/NPT manifolds and valves where bleeding is often required.

### Product Characteristics

- Bleed hydraulic systems without “cracking” hydraulic connections
- Uses standard automotive bleed screw design
- Bleed screw is permanently crimped into body housing for blowout prevention
- In-port options with SAE and NPT male studs
- Tube/hose connection options to male and female ORFS

## ORFS Bleed Adapters

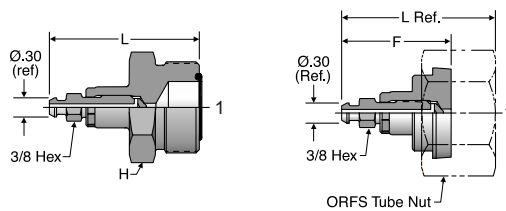

PNLOBA

FNLBA

ORFS Tube Nut sold separately

TUBE FITTING PART #	END SIZE 1 (in.)	F (in.)	H (in.)	L (in.)	Pressure (x 1,000 PSI)	
					Dynamic -S	-S
4 PNLOBA	1/4	-	11/16	1.90	9.2	
6 PNLOBA	3/8	-	3/4	1.97	9.2	
8 PNLOBA	1/2	-	7/8	2.07	9.2	
10 PNLOBA	5/8	-	1 1/16	2.19	6.0	
12 PNLOBA	3/4	-	1 1/4	2.27	6.0	
16 PNLOBA	1	-	1 1/2	2.35	6.0	
20 PNLOBA	1 1/4	-	1 3/4	2.41	6.0	
24 PNLOBA	1 1/2	-	2 1/8	2.48	5.0	
8 FNLBA	1/2	1.63	15/16	2.07	9.2	
10 FNLBA	5/8	1.63	1 1/8	2.17	6.0	
12 FNLBA	3/4	1.63	1 3/8	2.21	6.0	
16 FNLBA	1	1.63	1 5/8	2.21	6.0	
20 FNLBA	1 1/4	1.63	1 7/8	2.21	6.0	
24 FNLBA	1 1/2	1.63	2 1/4	2.21	5.0	

**WARNING:** This product can expose you to chemicals including Lead and Lead Compounds which is known to the State of California to cause cancer and birth defects or other reproductive harm. For more information go to [www.p65warnings.ca.gov](http://www.p65warnings.ca.gov).

## Bleeding Hydraulic Systems with Parker Bleed Adapters

Whenever possible, the bleed adapter should be mounted at the highest point within the hydraulic system. The trapped air can be relieved while the system is running at low pressure. To bleed, loosen the bleed screw 1/2 turn counterclockwise. After the hydraulic fluid begins to run freely from the bleed screw, the bleed screw should be re-tightened.

**Bleed Screw Tightening Torque:** 35-40 in.-lbs.

**Warning:** When bleeding hydraulic fluid, operate the system below 500 psi. To avoid injury, ensure that all persons are clear of the path of discharge. Another recommended practice is to attach a section of hose over the bleed screw/adapter to direct oil away from the area and to reduce oil spillage.

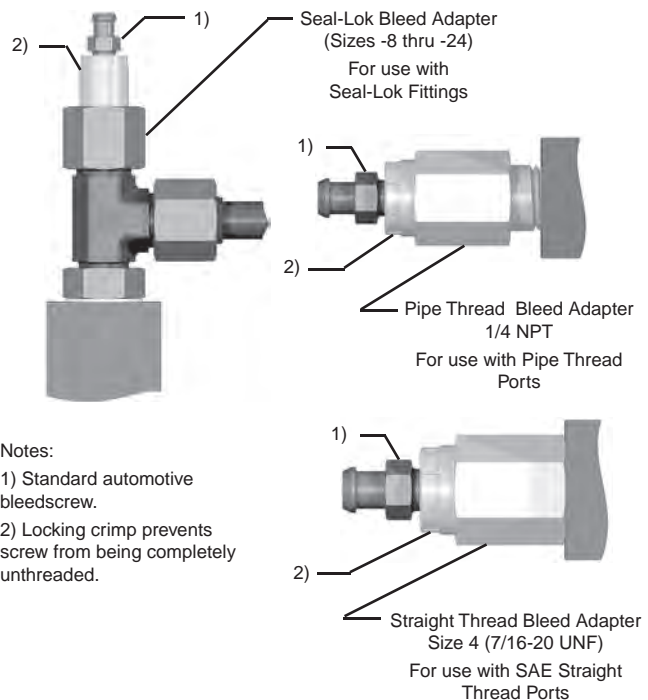

- Notes:
- 1) Standard automotive bleedscrew.
  - 2) Locking crimp prevents screw from being completely unthreaded.

## Port Bleed Adapters

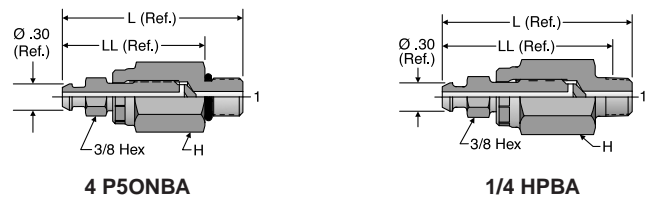

TUBE FITTING PART #	END SIZE 1	BODY HEX (in.)	H (in.)	L REF. (in.)	LL REF. (in.)	Pressure (x 1,000 PSI)	
						Static -S	Dynamic -S
4 P5ONBA	7/16-20 UN/UNF-2A	11/16	11/16	2.05	1.62	10.0	6.0
1/4 HPBA	1/4-18 NPTF	11/16	11/16	2.20	1.86	10.0	6.0

**WARNING:** This product can expose you to chemicals including Lead and Lead Compounds which is known to the State of California to cause cancer and birth defects or other reproductive harm. For more information go to [www.p65warnings.ca.gov](http://www.p65warnings.ca.gov).

TABLE OF CONTENTS

VISUAL INDEX

FAQs

GEN TECH

[Click here for CADs, Support Resources or to Configure Parts Online](#)

## Parker Triple Thread (PTT) Adapters

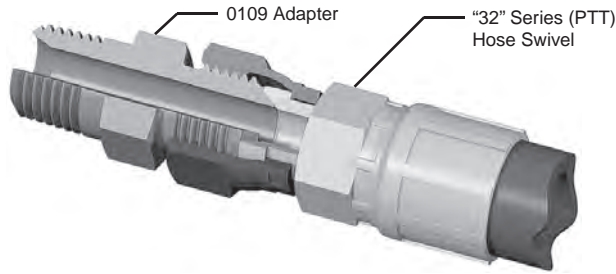

### 0109

Parker Triple Thread Fitting  
NPTF / PTT

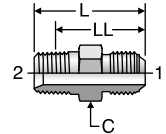

Mates with 32 style hose fittings.

TUBE FITTING PART #	END SIZE		C HEX (in.)	L (in.)	LL AFTER ASSY (in.)	Dynamic Pressure (x 1,000 PSI)		
	1 (in.)	2 NPTF				-S	-SS	-B
0109-12-16	1 (1 5/16-14)	3/4-14	1 3/8	1.84	1.36	3.0		
0109-16-16	1 (1 5/16-14)	1-11 1/2	1 3/8	2.03	1.46	3.0		
0109-20-20	1 1/4 (1 5/8-14)	1 1/4-11 1/2	1 3/4	2.22	1.63	3.0		
0109-24-24	1 1/2 (1 7/8-14)	1 1/2-11 1/2	2	2.50	1.91	3.0		

Parker Triple Thread (PTT) adapters are considered the original three-piece hydraulic flared fittings. As an improved fitting design over traditional two-piece flared fittings. Its use was widespread as a primary hydraulic connection for various aircraft, industrial and mobile applications. The PTT 30° flare three-piece design paved the progress towards the standardized 37° connection (through the Joint Industrial Council – JIC) and later to current standardization initiatives of SAE and ISO. Though popularity has diminished since the standardization of the 37° flare connection, the PTT hose adapters are utilized by certain transportation customers for OEM & MRO applications.

#### Applications:

- Diesel engine manufacturers
- Transportation air conditioning lines

**WARNING:** This product can expose you to chemicals including Lead and Lead Compounds which is known to the State of California to cause cancer and birth defects or other reproductive harm. For more information go to [www.p65warnings.ca.gov](http://www.p65warnings.ca.gov).

TABLE OF CONTENTS

VISUAL INDEX

FAQs

GEN TECH

L



## Screen Fittings

### Introduction

Parker screen fittings ensure the final measure of protection against particles that find their way into a system (even a properly filtered one) during installation, maintenance, failure of components, or by other means. Screen fittings provide a vital safeguard for critical components against damage due to contamination. They are intended to work in conjunction with a good filtration system and are available with screens that retain particle sizes from 480 to 65 micron.

Parker screen fittings are ideal for protecting:

- Gauges and instrumentation
- Critical hydraulic components such as pump compensator load sensing controls, proportional valves, relief valves, etc.
- Precision orifices from clogging
- Expensive components in test bench circuits (against particle contamination created by failed components)

### Design and Construction

**Fitting Body.** Parker screen fittings utilize standard Seal-Lok O-ring face seal and Triple-Lok 37° flare fitting bodies located in Section A and B respectively in this catalog. All screen fittings are manufactured with the micron rating stamped on the fitting body.

**Screen.** Screen fittings are constructed with stainless-steel screen elements. Sizes -6 through -12 fittings are manufactured with a dome-style screen, while size -4 fittings are made with a basket-style screen (see Fig. L7 and L8). Table L3 displays the various micron ratings for available screens. Additionally, Parker screen fittings have bi-directional flow capacity and can be installed in either the tube or port end of the fitting. Screens are not sold separately.

Screen fittings are for last measurement of protection, not for filtration. A filter is recommended for hydraulic systems. To prevent build up of debris, screens must be replaced or cleaned when filters are replaced or during flushing of hydraulic system.

Square Mesh Number	Nominal Micron Rating
40	480*
60	320*
80	230
100	165*
150	125
200	100
325	65

Table L3 — Micron Ratings for available screens

\*These micron ratings are not available as standard from stock

### Pressure Ratings

Parker screen fittings have the same dynamic pressure ratings as the equivalent fitting body (without the screen). Refer to sections A and B for the pressure ratings for Seal-Lok O-ring face seal and Triple-Lok 37° flare fittings.

### How to Order:

Please call the Tube Fittings Division for part number and ordering - 614-279-7070.



Fig. L6 — Screen Fittings.



Fig. L7 — Six dome-style screens and one basket-style screen.



Fig. L8 — Fitting cutaway with dome-style screen.

TABLE OF CONTENTS

VISUAL INDEX

FAQs

GEN TECH

**Pressure Drop**

All screen fittings have been tested to determine the maximum pressure drop and screen retention. The following "Pressure Drop vs. Flow" charts were derived from actual test data and may be used as a guide in determining pressure drop at various flow rates through screen fittings for the fluid indicated.

**4 F50X Screen Adapter Pressure Drop vs. Flow**

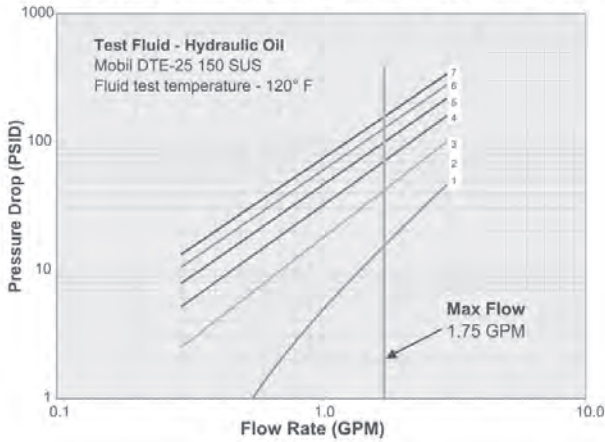

**6 F50X Screen Adapter Pressure Drop vs. Flow**

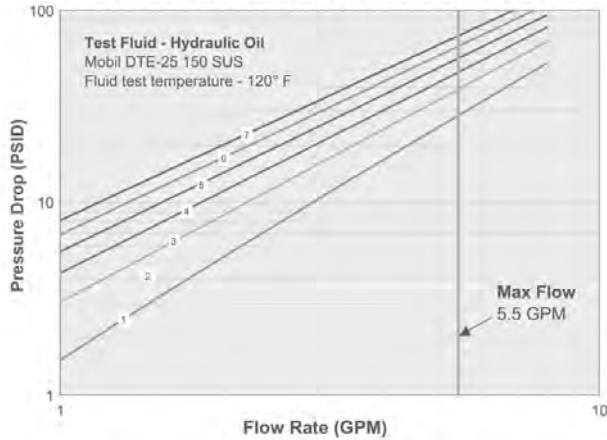

**8 F50X Screen Adapter Pressure Drop vs. Flow**

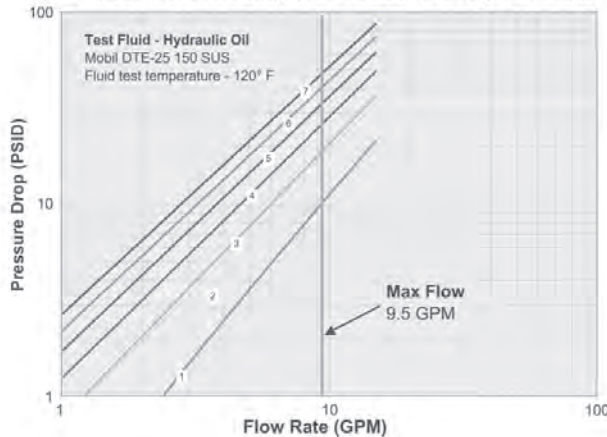

**10 F50X Screen Adapter Pressure Drop vs. Flow**

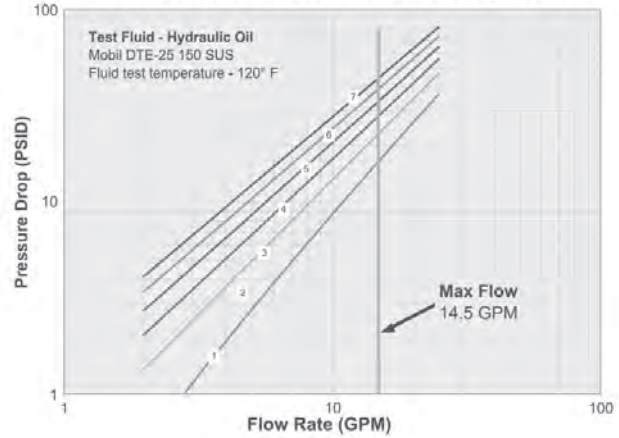

**12 F50X Screen Adapter Pressure Drop vs. Flow**

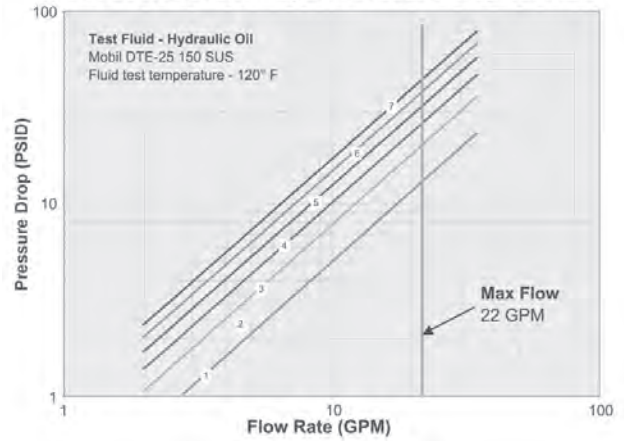

- 480MICRON (1)
- 320MICRON (2)
- 230MICRON (3)
- 165MICRON (4)
- 125MICRON (5)
- 100MICRON (6)
- 065MICRON (7)
- Max Flow

Refer to the General Technical Section for pressure drop data through standard fitting without screen.

- TABLE OF CONTENTS
- VISUAL INDEX
- FAQs
- GEN TECH



[Click here for CADs, Support Resources or to Configure Parts Online](#)

TABLE  
OF  
CONTENTS

VISUAL  
INDEX

FAQs













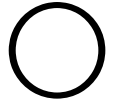



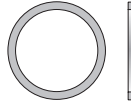

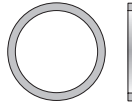

GEN TECH

# M

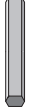
# O-RINGS & SEALS



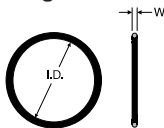
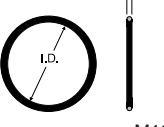

 <p><b>O-Ring Face Seal</b></p>	<p><b>ORFS O-Ring</b></p>  <p>M4</p>	<p><b>XO O-Ring</b></p>  <p>M4</p>	 <p><b>Port Ends</b> – SAE, Metric, BSPP, JIS, K4</p>	<p><b>SAE O-Ring</b></p>  <p>M4</p>	<p><b>ISO 6149 O-Ring</b></p>  <p>M5</p>
<p><b>Metric O-Ring</b></p>  <p>M5</p>	<p><b>Metric Retaining Ring</b></p>  <p>M5</p>	<p><b>BSPP O-Ring</b></p>  <p>M6</p>	<p><b>BSPP Retaining Ring</b></p>  <p>M6</p>	<p><b>EOlastic Seal Ring</b></p>  <p>M6</p>	<p><b>JIS B2351 O-Ring</b></p>  <p>M7</p>
<p><b>BSPP Bonded Seal</b></p>  <p>M7</p>	 <p><b>EO/EO-2</b></p>	<p><b>EO-2 Sealing Ring</b></p>  <p>M7</p>	<p><b>Bonded Seal for Banjo Fittings</b></p>  <p>M8</p>	<p><b>Metal Seal for Banjo Fittings</b></p>  <p>M8</p>	<p><b>Pressure Gauge Sealing Ring</b></p>  <p>M9</p>
<p><b>EO Swivel O-Ring</b></p>  <p>M9</p>	<p><b>EO O-Ring</b></p>  <p>M10</p>	 <p><b>4-Bolt Flanges</b></p>	<p><b>SAE 4-Bolt Flange O-Ring</b></p>  <p>M10</p>	 <p><b>Dual Seal Flanges</b></p>	<p><b>Radial Seal O-Ring</b></p>  <p>M10</p>
<p><b>Flange Seal O-Ring</b></p>  <p>M10</p>					



## O-Ring Material Selection

Standard O-rings supplied with Parker tube fittings and adapters are 90 durometer hard nitrile (Buna-N). These O-rings are well suited for most industrial hydraulic and pneumatic systems. They have high extrusion resistance making them suitable for very high pressure static applications. Optional high temperature fluorocarbon, Parker compound #V0894, is also available for higher temperature specifications.

O-rings for other media or higher temperature applications can be selected from the following chart. The chart should be used

only as a general guide. Before making final selection for a given application, it is recommended that appropriate tests be conducted to assure compatibility with the fluid, temperature, pressure and other environmental conditions.

For fluids not shown in the chart, please contact the Tube Fittings Division.

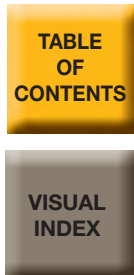

Polymer (Abbreviation)	Recommended for	Not Recommended for	Parker Compound No.	Color	SAE J515 Type	Hardness Shore "A"	Temperature Range (°F)	Comments
Nitrile-Butadiene (NBR)  HNBR	Petroleum base oils and fluids, mineral oils, ethylene glycol base fluids, silicone and di-ester base lubricants, air, water under 150°F, and natural gas.	Phosphate ester base hydraulic fluids, automotive brake fluids, strong acids, ozone, freons, ketones, halogenated hydrocarbons, and methanol.	NBR	Black	CH <sup>2)</sup>	90	-30° to 250° F	Standard from stock
			N0674	Black	—	70	-30° to 250° F	Low compression set Orange identification dot
			N0103	Black	—	70	-65° to 225° F	
			N1059	Black	CH <sup>2)</sup>	90	-30° to 275° F	
			N0507	Black	—	90	-65° to 180° F	Meets FDA requirements for food products CNG applications. Standard from stock
			N0304	Black	—	75	-65° to 225° F	
N0508	Black	—	75	-35° to 250° F				
Fluorocarbon (FKM <sup>5</sup> or FPM)	Petroleum base oils and fluids, some phosphate ester base fluids, silicone and silicate ester base lubricants, di-ester base lubricants, acids and halogenated hydrocarbons.	Ketones, skydrol fluids, amines (VDMH), anhydrous ammonia, low molecular weight esters and ethers, and hot hydrofluoric or chlorosulfonic acids.	V0747	Black	—	75	-15° to 400° F	Standard from stock
			V0884	Brown <sup>1)</sup>	—	75	-15° to 400° F	
			V0894	Brown <sup>1)</sup>	HK <sup>4)</sup>	90	-15° to 400° F	
			FKM	Brown	—	90	-15° to 400° F	
Ethylene-Propylene (EPDM)	Phosphate ester base hydraulic fluids, hot water, steam to 400°F, silicone oils and greases, dilute acids and alkalis, ketones, alcohols and automotive brake fluids.	Petroleum base oils and di-ester base lubricants.	E0540	Black	CA <sup>3)</sup>	80	-65° to 275° F	CO2 climate control systems. H2 fuel cells.
			E0893	Purple <sup>1)</sup>	CA <sup>3)</sup>	80	-65° to 275° F	
			E0962	Black	—	90	-65° to 275° F	
Neoprene (CR)	Refrigerants (freons, ammonia), high aniline point petroleum oils, mild acids, and silicate ester lubricants.	Phosphate ester fluids and ketones.	C0873	Black	—	70	-45° to 250° F	
			C0944	Red <sup>1)</sup>	—	70	-45° to 250° F	
Silicone (Si)	Dry heat (air to 400°F) and high aniline point oils.	Most petroleum fluids, ketones, water and steam.	S0604	Rust <sup>1)</sup>	—	70	-65° to 450° F	

Table M1 — O-Ring Selection

- 1) These Parker "Chromasure" color assurance O-rings are available from the Parker Hannifin O-Ring Division. They help eliminate assembly errors, reduce warranty costs and liability risks, and assure safety in aftermarket business.
- 2) Formerly SAE Type I.
- 3) Formerly SAE Type II.
- 4) Formerly SAE Type III.
- 5) "FKM" is the ASTM designation for fluorocarbon. Its ISO designation is "FPM".

Note: Use 90 durometer hard O-rings for applications with 1500 psi or higher pressures.



[Click here for Support Resources or to Configure Parts Online](#)

## ORFS O-Ring

ORFS Tube End O-Ring

Specify size and compound

Example: 2-018 NBR (standard NBR)

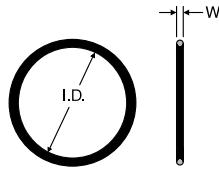

## XO O-Ring

Triple-Lok 2 O-Ring

Specify size and compound

Example: 2-019 NBR (standard NBR)

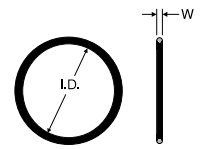

TUBE FITTING PART #	FITTING DASH SIZE	END SIZE		I.D.		W		Material		
		(in.)	(mm)	(in.)	(mm)	(in.)	(mm)	NBR*	FKM**	CNG***
2-011	4	1/4	6	0.30	7.7	0.07	1.78	•	•	•
2-012	6	3/8	8, 10	0.36	9.3	0.07	1.78	•	•	•
2-014	8	1/2	12	0.49	12.4	0.07	1.78	•	•	•
2-016	10	5/8	14, 15, 16	0.61	15.6	0.07	1.78	•	•	•
2-018	12	3/4	18, 20	0.74	18.8	0.07	1.78	•	•	•
2-020	14	7/8	22	0.86	21.8	0.07	1.78	•	•	•
2-021	16	1	25	0.93	23.5	0.07	1.78	•	•	•
2-025	20	1 1/4	28, 30, 32	1.18	29.9	0.07	1.78	•	•	•
2-029	24	1 1/2	35, 38	1.49	37.8	0.07	1.78	•	•	•
2-135	32	2	50	1.93	49.0	0.10	2.54	•	•	•

TUBE FITTING PART #	TUBE O.D. (in.)	I.D. (in.)	W (in.)	Material
				NBR
5-193	1/4	0.18	0.04	•
5-179	5/16	0.24	0.04	•
5-056	3/8	0.30	0.04	•
5-058	1/2	0.43	0.05	•
2-013	5/8	0.43	0.07	•
2-016	3/4	0.61	0.07	•
2-017	7/8	0.68	0.07	•
2-019	1	0.80	0.07	•
2-023	1 1/4	1.05	0.07	•
2-026	1 1/2	1.24	0.07	•
2-133	2	1.80	0.10	•

\* NBR is the standard compound — 90-durometer Nitrile.

\*\* FKM is an optional 90-durometer fluorocarbon compound.

\*\*\* CNG is an optional 85 durometer HNBR compound for CNG applications

See page M3 for O-ring Material Selection and data.

## SAE O-Ring

SAE Straight Thread Port O-Ring

Specify size and compound

Example: 3-906 NBR (standard NBR)

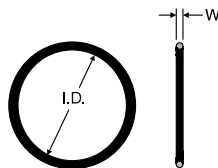

TUBE FITTING PART #	FITTING DASH SIZE	I.D. (in.)	W (in.)	Material		
				NBR*	FKM**	CNG***
3-902	2	0.24	0.06	•	•	
3-903	3	0.30	0.06	•	•	
3-904	4	0.35	0.07	•	•	•
3-905	5	0.41	0.07	•	•	
3-906	6	0.47	0.08	•	•	•
3-908	8	0.64	0.09	•	•	•
3-910	10	0.76	0.10	•	•	
3-912	12	0.92	0.12	•	•	
3-914	14	1.05	0.12	•	•	
3-916	16	1.17	0.12	•	•	
3-920	20	1.48	0.12	•	•	
3-924	24	1.72	0.12	•	•	
3-932	32	2.34	0.12	•	•	

\* NBR is the standard compound — 90-durometer Nitrile.

\*\* FKM is an optional 90-durometer fluorocarbon compound.

\*\*\* CNG is an optional 85 durometer HNBR compound for CNG applications

See page M3 for O-ring Material Selection and data.

TABLE OF CONTENTS

VISUAL INDEX

FAQs

[Click here for Support Resources or to Configure Parts Online](#)

## ISO 6149 O-Ring

Metric Straight Thread  
Port O-Ring

Specify size and compound (for option compound only)  
Example: M-12 ISO O-RING (standard NBR)  
M-12 ISO VITON O-RING (optional FKM)

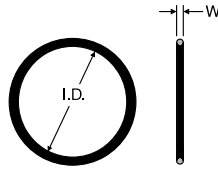

TUBE FITTING PART #	PORT THREAD	I.D. (mm)	W (mm)	Material	
				NBR**	FKM***
M-8 ISO O-Ring	M8 x 1	6.1	1.6	•	
M-10 ISO O-Ring	M10 x 1	8.1	1.6	•	
M-12 ISO O-Ring	M12 x 1.5	9.3	2.2	•	•
M-14 ISO O-Ring	M14 x 1.5	11.3	2.2	•	•
M-16 ISO O-Ring	M16 x 1.5	13.3	2.2	•	•
M-18 ISO O-Ring	M18 x 1.5	15.3	2.2	•	•
M-22 ISO O-Ring	M22 x 1.5	19.3	2.2	•	•
M-27 ISO O-Ring	M27 x 2	23.6	2.9	•	•
*M-30 ISO O-Ring	M30 x 2	26.6	2.9	•	
M-33 ISO O-Ring	M33 x 2	29.6	2.9	•	•
M-38 ISO O-Ring	M38 x 2	34.6	2.9	•	
M-42 ISO O-Ring	M42 x 2	38.6	2.9	•	•
M-48 ISO O-Ring	M48 x 2	44.6	2.9	•	•
M-60 ISO O-Ring	M60 x 2	56.6	2.9	•	

\* M30X2 is not a standard ISO 6149 size.

\*\* NBR is the standard compound — 90-durometer peroxide-cured Nitrile.

\*\*\* FKM is an optional 90-durometer fluorocarbon compound (for part number, VITON is used eg. M-8 ISO VITON O-RING ).

See page M3 for O-ring Material Selection and data.

## Metric O-Ring & Retaining Ring

For ISO 9974-1 / DIN 3852-1Port

Specify size, compound and material  
Example: 2-012 NBR (standard NBR O-ring)  
M12RRCF (standard steel retaining ring)

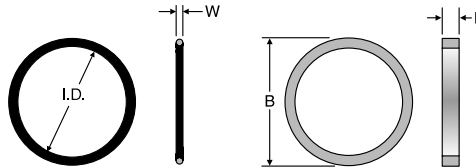

TUBE FITTING PART #	METRIC THREAD SIZE	I.D. (mm)	W (mm)	From Stock		TUBE FITTING PART #	B (mm)	L (mm)	Material	
				NBR*	FKM**				CF (S)	71 (SS)
3-902	M8 x 1	6.07	1.63	•		M8RR	13.15	1.00	•	
6-074	M10 x 1	8.00	1.50	•	•	M10RR	14.75	1.00	•	
2-012	M12 x 1.5	9.25	1.78	•	•	M12RR	17.75	1.30	•	
2-013	M14 x 1.5	10.82	1.78	•	•	M14RR	19.75	1.30	•	
3-907	M16 x 1.5	13.46	2.08	•	•	M16RR	21.75	1.50	•	
2-114	M18 x 1.5	15.54	2.62	•	•	M18RR	23.75	2.00	•	
2-017	M20 x 1.5	17.17	1.78	•		M20RR	25.75	1.30	•	
2-018	M22 x 1.5	18.77	1.78	•	•	M22RR	27.75	1.30	•	
2-019	M24 x 1.5	20.35	1.78	•		M24RR	29.75	1.30	•	
2-118	M26 x 1.5	21.89	2.62	•		M26RR	31.75	2.00	•	
2-119	M27 x 2	23.47	2.62	•	•	M27RR	32.75	2.00	•	
2-121	M30 x 2	26.64	2.62	•		M30RR	36.32	2.00	•	
2-122	M33 x 2	28.24	2.62	•		M33RR	39.75	2.00	•	
2-124	M36 x 2	31.42	2.62	•		M36RR	42.75	2.00	•	
2-128	M42 x 2	37.77	2.62	•		M42RR	49.75	2.00	•	
2-130	M45 x 2	40.94	2.62	•		M45RR	52.75	2.00	•	
2-132	M48 x 2	44.12	2.62	•		M48RR	54.95	2.00	•	
2-133	M50 x 2	45.69	2.62	•		M50RR	56.31	2.00	•	

\* NBR is the standard compound — 90-durometer Nitrile.

\*\* FKM is an optional 90-durometer fluorocarbon compound.

See page M3 for O-ring Material Selection and data.

TABLE  
OF  
CONTENTS

VISUAL  
INDEX

FAQs

M

[Click here for Support Resources or to Configure Parts Online](#)

# BSPP O-Ring & Retaining Ring

For ISO 1179-1 / DIN 3852-2 Port

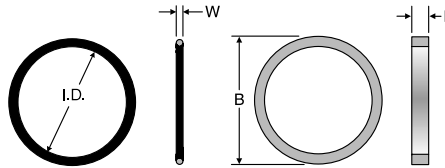

Specify size and compound (for O-ring only)  
 Example: 2-113 NBR (standard NBR O-ring)  
 3/8 RETAINING RING (standard steel retaining ring)

TUBE FITTING PART #	BSPP THREAD SIZE	I.D. (mm)	W (mm)	Material		TUBE FITTING PART #	B (mm)	L (mm)	Material	
				NBR*	FKM**				S	SS
OR8X2X	1/8-28	8	2	•	•	1/8 Retaining Ring	15.0	1.4	•	
2-111	1/4-19	10.77	2.62	•	•	1/4 Retaining Ring	19.5	1.9	•	
2-113	3/8-19	13.94	2.62	•	•	3/8 Retaining Ring	23.5	1.9	•	
5-256	1/2-14	17.96	2.62	•	•	1/2 Retaining Ring	28.5	1.9	•	
2-119	3/4-14	23.47	2.62	•	•	3/4 Retaining Ring	34.5	2.6	•	
2-217	1-11	29.74	3.53	•	•	1 Retaining Ring	43.5	2.6	•	
2-222	1 1/4-11	37.69	3.53	•		1 1/4 Retaining Ring	52.5	2.6	•	
2-224	1 1/2-11	44.04	3.53	•		1 1/2 Retaining Ring	60.0	2.6	•	
2-227	2-11	53.57	3.53			2 Retaining Ring	75.0	2.6		

\* NBR is the standard compound — 90-durometer Nitrile.  
 \*\* FKM is an optional 90-durometer fluorocarbon compound.  
 See page M3 for O-ring Material Selection and data.

# EOlastic Seal Ring

EOlastic Soft Seal for  
 BSPP & Metric Threads (“ED Seal”)  
 DIN 3869

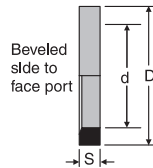

Specify size and compound  
 (for optional compound only)  
 Example: ED8X1X (standard NBR)  
 ED8X1VITX (optional FPM)

TUBE FITTING PART #	For Male Metric Thread	For Male Thread BSPP	D (mm)	d (mm)	S (mm)	Material	
						NBR*	FKM**
ED8X1X	M8 x 1		9.9	6.5	1.0	•	•
ED10X1X	M10 x 1	G 1/8 A	11.9	8.4	1.0	•	•
ED12X1.5X	M12 x 1.5		14.4	9.8	1.5	•	•
ED14X1.5X	M14 x 1.5	G 1/4 A	16.5	11.6	1.5	•	•
ED16X1.5X	M16 x 1.5		18.9	13.8	1.5	•	•
ED3/8X		G 3/8 A	18.9	14.7	1.5	•	•
ED18X1.5X	M18 x 1.5		20.9	15.7	1.5	•	•
ED20X1.5X	M20 x 1.5		22.9	17.8	1.5	•	•
ED1/2X		G 1/2 A	23.9	18.5	1.5	•	•
ED22X1.5X	M22 x 1.5		24.3	19.6	1.5	•	•
ED26X1.5X	M26 x 1.5	G 3/4 A	29.2	23.9	1.5	•	•
ED26X1.5X	M27 x 2	G 3/4 A	29.2	23.9	1.5	•	•
ED33X2X	M33 x 2	G 1 A	35.7	29.7	2.0	•	•
ED42X2X	M42 x 2	G 1 1/4 A	45.8	38.8	2.0	•	•
ED48X2X	M48 x 2	G 1 1/2 A	50.7	44.7	2.0	•	•

\* NBR is the standard compound — 90-durometer Nitrile.  
 \*\* FKM is an optional 85-durometer fluorocarbon compound (for part number VIT is used as suffix). Example: ED8X1VITX

**TABLE OF CONTENTS**

**VISUAL INDEX**

**FAQs**

[Click here for Support Resources or to Configure Parts Online](#)

# JIS B2351 O-Ring

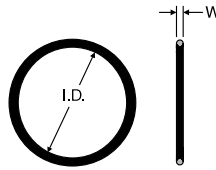

TUBE FITTING PART #	JIS DASH SIZE	T4 THREAD BSPP	I.D. (mm)	W (mm)	JIS B 2401 Description
<b>P8 O-RING</b>	2	1/8-28	7.8	1.9	O-RING CLASS 1 B P 8
<b>P11 O-RING</b>	4	1/4-19	10.8	2.4	O-RING CLASS 1 B P 11
<b>P14 O-RING</b>	6	3/8-19	13.8	2.4	O-RING CLASS 1 B P 14
<b>P18 O-RING</b>	8	1/2-14	17.8	2.4	O-RING CLASS 1 B P 18
<b>P24 O-RING</b>	12	3/4-14	23.7	3.5	O-RING CLASS 1 B P 24
<b>P29 O-RING</b>	16	1-11	28.7	3.5	O-RING CLASS 1 B P 29

\* NBR is the standard compound — 90-durometer Nitrile.

TABLE OF CONTENTS

VISUAL INDEX

FAQs

## BSPP Bonded Seal

Used on K4 Style Straight Fittings as a Port Seal  
For use with ISO 1179 / DIN 3852-2 port

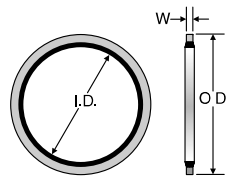

TUBE FITTING PART #	BSPP THREAD SIZE	O.D. (mm)	I.D. (mm)	W (mm)	Material		
					S*	SS	B
<b>D9DT-2</b>	1/8-28	15.9	10.4	2.0	•		
<b>D9DT-4</b>	1/4-19	20.6	13.7	2.0	•		
<b>D9DT-6</b>	3/8-19	23.8	17.3	2.0	•		
<b>D9DT-8</b>	1/2-14	28.6	21.5	2.3	•		
<b>D9DT-10</b>	5/8-14	31.8	23.5	2.3	•		
<b>D9DT-12</b>	3/4-14	34.9	27.1	2.3	•		
<b>D9DT-16</b>	1-11	42.8	33.9	2.3	•		
<b>D9DT-20</b>	1 1/4-11	52.4	42.9	3.3	•		
<b>D9DT-24</b>	1 1/2-11	58.6	48.4	3.3	•		

\* NBR is the standard elastomer compound — 90-durometer Nitrile  
Zinc plated steel ring

## EO-2 Sealing Ring

Specify size and material

Examples:

- DOZ10S (standard steel with NBR)
- DOZ10SVIT (standard steel with FKM)
- DOZ10S71 (standard stainless steel with FKM)

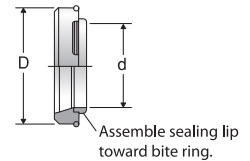

TUBE FITTING PART #	SERIES	TUBE O.D. (mm)	D (mm)	d (mm)	Material		
					Material		
					S	SS	
<b>DOZ04LL</b>	LL	4	6.8	4	•		
<b>DOZ06LL</b>	very light	6	8.8	6	•		
<b>DOZ06L</b>	L	6	10.3	6	•	•	•
<b>DOZ08L</b>	light	8	12.3	8	•	•	•
<b>DOZ10L</b>		10	14.3	10	•	•	•
<b>DOZ12L</b>		12	16.3	12	•	•	•
<b>DOZ15L</b>		15	20.3	15	•	•	•
<b>DOZ18L</b>		18	24.3	18	•	•	•
<b>DOZ22L</b>		22	27.7	22	•	•	•
<b>DOZ28L</b>		28	33.7	28	•	•	•
<b>DOZ35L</b>		35	42.7	35	•	•	•
<b>DOZ42L</b>		42	49.7	42	•	•	•
<b>DOZ06S</b>	S	6	12.3	6	•	•	•
<b>DOZ08S</b>	heavy	8	14.3	8	•	•	•
<b>DOZ10S</b>		10	16.3	10	•	•	•
<b>DOZ12S</b>		12	18.3	12	•	•	•
<b>DOZ14S</b>		14	20.3	14	•	•	•
<b>DOZ16S</b>		16	22.3	16	•	•	•
<b>DOZ20S</b>		20	27.7	20	•	•	•
<b>DOZ25S</b>		25	33.7	25	•	•	•
<b>DOZ30S</b>		30	39.7	30	•	•	•
<b>DOZ38S</b>		38	49.7	38	•	•	•

\* Steel black zinc plated with NBR 90-durometer Nitrile compound.

\*\* Steel black zinc plated with FKM 90-durometer fluorocarbon compound.

\*\*\* Stainless steel with FKM 90-durometer fluorocarbon compound.



[Click here for Support Resources or to Configure Parts Online](#)

# Bonded Seal for Banjo Fittings

Specify size and material

- Examples: KDS 12X (standard steel with NBR)
- KDS 12VITX (standard steel with FKM)
- KDS 1271 (standard stainless steel with PTFE)

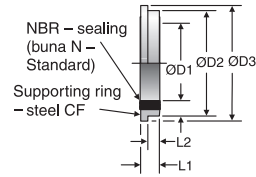

TUBE FITTING PART #	FOR USE WITH WH & TH BANJOS	THREAD	D1 (mm)	D2 (mm)	D3 (mm)	L1 (mm)	L2 (mm)	Material	
								CF (S)	71 (SS)
KDS10	6-LM/LR	M10 x 1/G1/8A	10.3	14.9	16.0	2.5	1.1	•	
KDS12	6-SM/8-LM	M12 x 1.5	12.3	17.0	18.0	3.0	1.6	•	
KDS14	6-SR, 8-LR/SM/SR, 10-LM/LR	M14 x 1.5/G1/4A	14.3	18.9	20.0	3.0	1.6	•	
KDS16	10-SM/SR, 12-LM/LR/SR	M16 x 1.5/G3/8A	17	21.9	24.0	3.0	2.1	•	
KDS18	12-SM/15-LM	M18 x 1.5	18.3	23.9	23.9	3.0	—	•	
KDS22	15-LR, 16-SM/SR, 18-LM/LR	M22 x 1.5/G1/2A	22.3	26.9	30.0	4.5	2.6	•	
KDS26	22-LM	M26 x 1.5	26.3	31.9	35.0	3.5	2.6	•	
KDS27	20-SM/SR, 22-LR	M27 x 2/G3/4A	27.3	32.9	38.0	3.5	2.6	•	
KDS33	25-SM/SR, 28-LM/LR	M33 x 2/G1A	33.6	39.9	42.0	3.5	2.6	•	
KDS42	30-SM/SR, 35-LM/LR	M42 x 2/G1 1/4A	42.4	49.9	49.9	3.5	—	•	
KDS48	38-SM/SR, 42-LM/LR	M48 x 2/G1 1/2A	48.4	55.9	60.0	3.5	2.6	•	

**WARNING:** This product can expose you to chemicals including Lead and Lead Compounds which is known to the State of California to cause cancer and birth defects or other reproductive harm. For more information go to [www.p65warnings.ca.gov](http://www.p65warnings.ca.gov).

# Metal Seal for Banjo Fittings

Specify size and material

- Examples: DKA1/8CFX (steel)
- DKA1/871X (stainless steel)

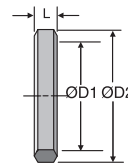

TUBE FITTING PART #	FOR APPLICATION IN BANJOS:				THREAD	D1 (mm)	D2 (mm)	L (mm)	Material	
	WH / TH	SWVE		CFX (S)					71X (SS)	
<b>BSP</b>										
DKA1/8	6LR		4/6/8 LLR	6LR	G 1/8 A	9.8	14	2.5	•	•
DKA1/4	8LR	6SR	8LR	6SR	G 1/4 A	13.3	18	3.0	•	•
DKA1/4	10LR	8SR	10LR	8SR	G 1/4 A	13.3	18	3.0	•	•
DKA3/8	12LR	10SR	12LR	10SR	G 3/8 A	16.8	22	3.0	•	•
DKA3/8		12SR		12SR	G 3/8 A	16.8	22	3.0	•	•
DKA1/2			15/18LR	14/16SR	G 1/2 A	21.1	26	3.0	•	•
DKA1/2X4.5	15LR	14SR			G 1/2 A	21.1	26	4.5	•	•
DKA1/2X4.5	18LR	16SR			G 1/2 A	21.1	26	4.5	•	•
DKA3/4	22LR	20SR	22LR	20SR	G 3/4 A	26.6	32	3.5	•	•
DKA1	28LR	25SR			G 1 A	33.4	39	3.5	•	•
DKA11/4	35LR	30SR			G 1 1/4 A	42.1	49	3.5	•	•
DKA11/2	42LR	38SR			G 1 1/2 A	48.1	55	3.5	•	•
<b>Metric</b>										
DKA10	6LM		6/8LLM	6LM	M10 x 1	10.1	14	2.5	•	•
DKA12	8LM	6SM	8LM	6SM	M12 x 1.5	12.1	17	3.0	•	•
DKA14	10LM	8SM	10LM	8SM	M14 x 1.5	14.1	19	3.0	•	•
DKA16	12LM	10SM	12LM	10SM	M16 x 1.5	16.1	21	3.0	•	•
DKA18	15LM	12SM	15LM	12SM	M18 x 1.5	18.1	23	3.0	•	•
DKA20		14SM		14SM	M20 x 1.5	20.1	25	3.0	•	•
DKA22			18LM	16SM	M22 x 1.5	22.1	27	3.0	•	•
DKA22X4.5	18LM	16SM			M22 x 1.5	22.1	27	4.5	•	•
DKA26			22LM		M26 x 1.5	26.1	31	3.0	•	•
DKA26X3.5	22LM				M26 x 1.5	26.1	31	3.5	•	•
DKA27		20SM		20SM	M27 x 2	27.1	32	3.5	•	•
DKA33	28LM	25SM			M33 x 2	33.1	39	3.5	•	•
DKA11/4	35LM	30SM			M42 x 2	42.1	49	3.5	•	•
DKA11/2	42LM	38SM			M48 x 2	48.1	55	3.5	•	•

**WARNING:** This product can expose you to chemicals including Lead and Lead Compounds which is known to the State of California to cause cancer and birth defects or other reproductive harm. For more information go to [www.p65warnings.ca.gov](http://www.p65warnings.ca.gov).

**TABLE OF CONTENTS**

**VISUAL INDEX**

**FAQs**

[Click here for Support Resources or to Configure Parts Online](#)

## Pressure Gauge Sealing Ring

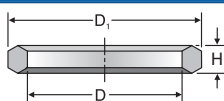

Specify size and material

Examples: DK11/2CFX (steel)

DK11/271X (stainless steel)

TUBE FITTING PART #	FOR INTERNAL BSPP THREAD	D (mm)	D1 (mm)	H (mm)	Material		
					CFX (S)	71 (SS)	COPPER
DK11/4	G 1/4 - 19	6.0	11.3	4.5	•		
DK11/2	G 1/2 - 19	12.0	18.5	5.0	•	•	
M25180	G 1/4	6.4	11.0	1.6			•

**WARNING:** This product can expose you to chemicals including Lead and Lead Compounds which is known to the State of California to cause cancer and birth defects or other reproductive harm. For more information go to [www.p65warnings.ca.gov](http://www.p65warnings.ca.gov).

## EO Swivel O-Ring

O-ring for EO Swivel Nuts, Weld Nipples, and Caps

Part Numbers: RED, DA, GZ, GZR, EGE, EGEO, SKA, EW, ET, EL, VKA, MAVÉ



TABLE OF CONTENTS

VISUAL INDEX

FAQs

EO SIZE/SERIES	O-RING NBR*	D	H	O-RING FKM <sup>2</sup>	D	H
6L	OR4.5X1.5X	4.5	1.5	OR4.5X1.5VITX	4.5	1.5
8L	OR6.5X1.5X	6.5	1.5	OR6.5X1.5VITX	6.5	1.5
10L	OR8.5X1.5X	8.5	1.5	OR8X1.5VITX	8.0	1.5
12L	OR10.5X1.5X	10.5	1.5	OR10X1.5VITX	10.0	1.5
15L	OR12.5X2X	12.5	2.0	OR12X2VITX	12.0	2.0
18L	OR16X2X	16.0	2.0	OR15X2VITX	15.0	2.0
22L	OR20X2X	20.0	2.0	OR20X2VITX	20.0	2.0
28L	OR26X2X	26.0	2.0	OR26X2VITX	26.0	2.0
35L	OR32X2.5X	32.0	2.5	OR32X2.5VITX	32.0	2.5
42L	OR39X2.5X	39.0	2.5	OR38X2.5VITX	38.0	2.5
6S	OR4.5X1.5X	4.5	1.5	OR4.5X1.5VITX	4.5	1.5
8S	OR6.5X1.5X	6.5	1.5	OR6.5X1.5VITX	6.5	1.5
10S	OR8.5X1.5X	8.5	1.5	OR8X1.5VITX	8.0	1.5
12S	OR10.5X1.5X	10.5	1.5	OR10X1.5VITX	10.0	1.5
14S	OR12X2X	12.0	2.0	OR12X2VITX	12.0	2.0
16S	OR14X2X	14.0	2.0	OR13X2VITX	13.0	2.0
20S	OR17X2.5X	17.0	2.5	OR16.3X2.4VITX	16.3	2.4
25S	OR22X2.5X	22.0	2.5	OR20.3X2.4VITX	20.3	2.4
30S	OR27X2.5X	27.0	2.5	OR25.3X2.4VITX	25.3	2.4
38S	OR35X2.5X	35.0	2.5	OR33.3X2.4VITX	33.3	2.4

\*NBR is standard compound — 90-durometer Nitrile.

<sup>2</sup>FKM is optional 85-durometer Fluorocarbon compound.

M

[Click here for Support Resources or to Configure Parts Online](#)

## EO O-Ring

O-ring for EO Banjo Fitting Bolts  
Part Numbers: WH/TH

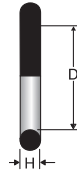

## SAE 4-Bolt Flange O-Ring

Code 61 and Code 62 Flanges

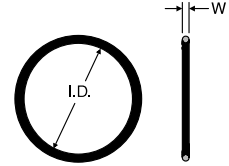

Specify size and compound  
Example: 2-210 NBR

BANJO BOLT METRIC THREAD	BANJO BOLT BSPP THREAD	D	H	O-RING NBR*	O-RING FKM**
M10	G 1/8	9.3	1.5	OR9.3X1.5X	OR9.3X1.5VITX
M12, M14	G 1/4	12.5	1.5	OR12.5X1.5X	OR12.5X1.5VITX
M16	G 3/8	16.0	1.5	OR16X1.5X	OR16X1.5VITX
M18		18.0	1.5	OR18X1.5X	OR18X1.5VITX
M20, M22	G 1/2	20.0	1.5	OR20X1.5X	OR20X1.5VITX
M26, M27	G 3/4	25.0	2.0	OR25X2X	OR25X2VITX
M33	G 1	33.0	2.5	OR33X2.5X	OR33X2.5VITX
M42	G 1 1/4	41.0	2.5	OR41X2.5X	OR41X2.5VITX
M48	G 1 1/2	46.0	3.0	OR46X3X	OR46X3VITX

\*NBR is standard compound — 90-durometer Nitrile.

\*\*FKM is optional 85-durometer Fluorocarbon compound.

TUBE FITTING PART #	HOSE PRODUCTS DIVISION PART # <sup>1)</sup>	FITTING DASH SIZE	W (in.)	I.D. (in.)	Material NBR*
2-210	711510-6	8	0.139	0.734	•
2-214	711510-5	12	0.139	0.984	•
2-219	711510-4	16	0.139	1.296	•
2-222	711510-3	20	0.139	1.484	•
2-225	711510-2	24	0.139	1.859	•
2-228	711510-1	32	0.139	2.234	•
2-232	711510-7	40	0.139	2.734	•
2-237	711510-8	48	0.139	3.359	•
2-241		56	0.139	3.859	•
2-245		64	0.139	4.359	•
2-253		80	0.139	5.359	•

\*NBR is the standard compound — 90-durometer Nitrile.

O-ring for DIN 2353 EO Gear Pump Flange Adapters  
Part Numbers: BFG/BFW

FLANGE SERIES "LK"	D	H	O-RING NBR*
LK35	20.0	2.5	OR20X2.5X
LK40	26.0	2.5	OR26X2.5X
LK55	33.0	2.5	OR33X2.5X

\*NBR is standard compound — 90-durometer Nitrile.

## Radial Seal O-Ring

Dual Seal Port O-Ring

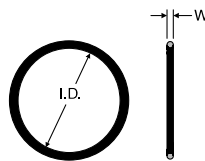

## Flange Seal O-Ring

Dual Seal Flange Head O-Ring

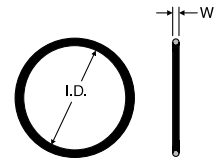

TUBE FITTING PART #	END SIZE	W (in.)	I.D. (in.)
	2 DUAL SEAL		
2-113	1/2	0.103	0.549
2-123	1	0.103	1.174
2-129	1 1/2	0.103	1.549

Standard O-ring compound - 90 durometer NBR. Ordering example with material: 2-113 NBR.

TUBE FITTING PART #	END SIZE	W (in.)	I.D. (in.)
	2 DUAL SEAL		
2-022	1/2	0.070	0.989
2-129	1	0.103	1.549
2-136	1 1/2	0.103	1.987

Standard O-ring compound - 90 durometer NBR.

TABLE OF CONTENTS

VISUAL INDEX

FAQs

N

# PARKLAMP

Inch Tube Clamps













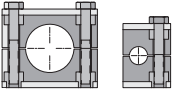

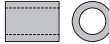



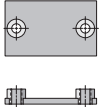
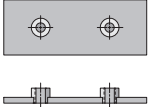

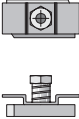

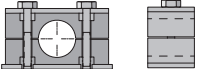



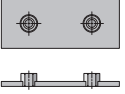
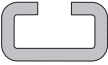
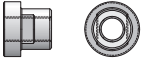
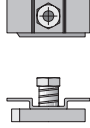

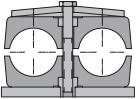



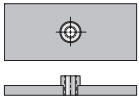

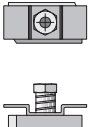

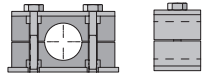
 <p><b>Standard Series</b></p>	<p><b>Clamp Halves</b></p>  <p>N7</p>	<p><b>CP</b> Cover Plate</p>  <p>N8</p>	<p><b>BCP</b> Hexagon Head Bolt for Cover Plate</p>  <p>N8</p>	<p><b>IPS</b> Insert</p>  <p>N8</p>	<p><b>BIP</b> Hexagon Head Bolt for Insert</p>  <p>N8</p>
<p><b>LP</b> Locking Plate</p>  <p>N8</p>	<p><b>SB</b> Stacking Bolt</p>  <p>N8</p>	<p><b>WP</b> Weld Plate</p>  <p>N9</p>	<p><b>WPE</b> Weld Plate Elongated</p>  <p>N9</p>	<p><b>R</b> Mounting Rail</p>  <p>N9</p>	<p><b>HRN</b> Hexagon Rail Nut</p>  <p>N9</p>
<p><b>CRA</b> Channel Rail Adapter</p>  <p>N9</p>	 <p><b>Heavy Series</b></p>	<p><b>Clamp Halves Heavy</b></p>  <p>N10</p>	<p><b>CPH</b> Cover Plate Heavy</p>  <p>N11</p>	<p><b>BCPH</b> Hexagon Head Bolt for Cover Plate</p>  <p>N11</p>	<p><b>LPH</b> Locking Plate Heavy</p>  <p>N11</p>
<p><b>SBH</b> Stacking Bolt Heavy</p>  <p>N11</p>	<p><b>WPH</b> Weld Plate Heavy</p>  <p>N11</p>	<p><b>RH</b> Mounting Rail Heavy</p>  <p>N12</p>	<p><b>RNH</b> Mounting Rail Nut Heavy</p>  <p>N12</p>	<p><b>CRA</b> Channel Rail Adapter</p>  <p>N12</p>	
 <p><b>Twin Series</b></p>	<p><b>Clamp Halves</b></p>  <p>N13</p>	<p><b>CPT</b> Cover Plate</p>  <p>N14</p>	<p><b>BCPT</b> Hexagon Head Bolt for Cover Plate</p>  <p>N14</p>	<p><b>LPT</b> Locking Plate</p>  <p>N14</p>	<p><b>SBT</b> Stacking Bolt</p>  <p>N14</p>
<p><b>WPT</b> Weld Plate Twin</p>  <p>N15</p>	<p><b>R</b> Mounting Rail</p>  <p>N15</p>	<p><b>RNT</b> Mounting Rail Nut Twin</p>  <p>N15</p>	<p><b>CRA</b> Channel Rail Adapter</p>  <p>N15</p>		

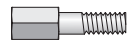
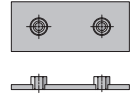
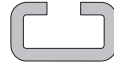

TABLE  
OF  
CONTENTS

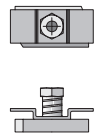
 <p><b>Compact Spiral Hose Heavy Series</b></p>	<p><b>Clamp Halves Heavy</b></p>  <p>N16</p>	<p><b>CPH Cover Plate Heavy</b></p>  <p>N17</p>	<p><b>BCPH Hexagon Head Bolt for Cover Plate</b></p>  <p>N17</p>	<p><b>LPH Locking Plate Heavy</b></p>  <p>N17</p>	<p><b>SBH Stacking Bolt Heavy</b></p>  <p>N17</p>
<p><b>WPH Weld Plate Heavy</b></p>  <p>N17</p>	<p><b>RH Mounting Rail Heavy</b></p>  <p>N18</p>	<p><b>RNH Mounting Rail Nut Heavy</b></p>  <p>N18</p>	<p><b>CRA Channel Rail Adatper</b></p>  <p>N18</p>	 <p><b>Compact Spiral Hose Heavy Twin</b></p>	<p><b>Clamp Halves Heavy Twin</b></p>  <p>N19</p>
<p><b>CPHT Cover Plate</b></p>  <p>N20</p>	<p><b>BCPH Hexagon Head Bolt for Cover Plate</b></p>  <p>N20</p>	<p><b>WPHT Weld Plate</b></p>  <p>N20</p>	<p><b>RH Mounting Rail Heavy</b></p>  <p>N20</p>	<p><b>RNH Mounting Rail Nut Heavy</b></p>  <p>N20</p>	<p><b>CRA Channel Rail Adatper</b></p>  <p>N20</p>

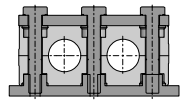
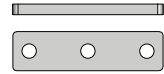
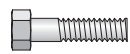
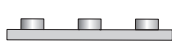
N

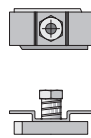
## Introduction

The ParKlump system is designed for restraining tube, pipe and hose assemblies against unwanted and potentially harmful effects of mechanical shock and vibration forces that are common in fluid power systems.

The clamping system is the most commonly overlooked aspect of fluid power system design. Failure to properly restrain the fluid conductors can result in leakage, downtime and system malfunction, as well as significantly reduce the life of tube, pipe and hose assemblies. With the ParKlump system, the risk of problems resulting from mechanical shock and vibration can be significantly reduced.

## Design and Construction

Designed to meet the basic envelope dimensions of DIN 3015, Part 1, the ParKlump plastic clamp halves are interchangeable with the Parker metric clamp system. The primary difference between these two clamping systems is the utilization of inch, as opposed to metric, thread hardware in the ParKlump system. All plastic clamp halves in the ParKlump system are manufactured from Polypropylene material. The hardware portion of the ParKlump system is available in plated steel and stainless steel.

For convenience, the ParKlump system is divided into three different series: Standard, Heavy and Twin. Each series has corresponding components, physical dimensions and mechanical properties. Within each series, there are a number of groups, each with specific envelope dimensions. Reference the "Group#" column in each table to match clamps with appropriate components. Components from different series and/or groups can not be intermixed. However, the standard and twin series can be mounted on the same mounting rail.

## How It Works

The ParKlump system has two primary methods for mounting: weld plates and mounting rails.

**Clamps should be mounted to a rigid structure for optimum performance. Clamping tube, pipe or hose assemblies together without mounting them to a rigid structure, often called "floating clamps," does not provide adequate support.**

**Proper design of a clamping system requires that the clamps be positioned appropriately on the tube, pipe or hose assemblies. See the Assembly and Installation section of this catalog for more information on clamp location and spacing.**

### Weld Plate Mounting (Fig. N1)

The weld plate mounting system allows the user to attach a single clamp assembly to a structure of similar material (steel to steel, etc) by welding the components together. Once the weld plate is attached to a structure, one clamp half can be placed onto the weld plate, followed by the tube, pipe or hose assembly. Next, the second plastic clamp half can be placed on the tube, pipe or hose assembly, followed by the cover plate (or Insert). To complete the assembly, the Hex Head attachment bolts are inserted into the assembly and tightened to the torque shown in the Assembly section of this catalog.



Fig. N1 – Weld Plate Assembly



Fig. N2 – Mounting Rail Assembly

TABLE  
OF  
CONTENTS

VISUAL  
INDEX

## Assembly and Installation

Please refer to Section R for the assembly and installation instructions for ParKlump Inch Tube Clamps.

### Mounting Rail Mounting (Fig. N2)

Use of a mounting rail is another way to assemble the clamping system components onto a support structure. Using a mounting rail allows multiple clamps to be mounted side-by-side for restraining a group of tube, pipe, or hose assemblies. The mounting rail also provides the ability to move the location of the clamps in one direction for easier alignment. The rail can be attached to a support structure by welding or bolting. Once the mounting rail is in place, rail nuts can be slid into the rail. The first clamp half, followed by the tube, pipe or hose assembly, can then be installed over the corresponding rail nuts. After this, the second clamp half, the cover plate (or Insert) and the hex head attachment bolts can be installed to complete the assembly.

### Stacking (Fig. N3)

A primary feature of the ParKlump system is its ability to accommodate stacking of a series of clamps to various heights, thus requiring a smaller footprint for mounting. To do this, simply use the stacking bolts to mount the first clamp assembly, then install a stacking plate over the first clamp and stacking bolts. The second clamp assembly can then be placed over the first clamp assembly. Complete the mounting by assembling a cover plate and using the hex head bolts to tighten the upper clamp assembly. **Note: When stacking, the clamps must be from the same series and group.**



Fig. N3 – Stacked Assembly

## Shearing Force Diagram

The forces shown in these diagrams represent the resistance to sliding provided by the clamps in the axial direction.

The sliding starts when the shown values are reached.

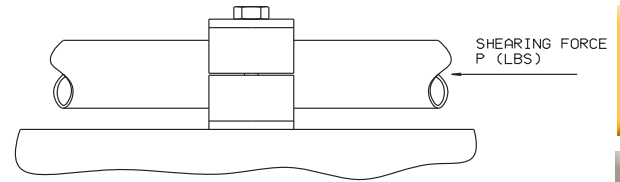

TABLE OF CONTENTS

VISUAL INDEX

STANDARD SERIES					
Clamp Group	Hexagon Head Bolt	Polypropylene			
		Tightening torque [Nm] Ft/lb		Max. load in pipe direction F [kN] lbf	
1		8	6	0,6	135
1A		8	6	1,1	247
2	M6 / 1/4"-20	8	6	1,3	292
3	UNC	8	6	1,4	315
4		8	6	1,5	337
5		8	6	1,9	427
6		8	6	2,0	450

HEAVY SERIES					
Clamp Group	Hexagon Head Bolt	Polypropylene			
		Tightening torque [Nm] Ft/lb		Max. load in pipe direction F [kN] lbf	
3S	M10 / 3/8"-	12	9	1,6	360
4S	16 UNC	12	9	2,9	652
5S	M12 / 7/16" -	15	11	3,3	742
6S	14 UNC	30	12	8,2	1.843

## Clamp Body Material Properties

	Polypropylene PP
<b>MECHANICAL PROPERTIES</b>	
Density	.901g/cc
Tensile Strength	25 MPa (4,000 psi)
Flexural Modulus	1073 MPa
Compressive Strength	90MPa (23,050 psi)
(Resistance) Notched	
IZOD Impact Strength	3.1 KJ/mm <sup>2</sup>

	Polypropylene PP
<b>THERMAL PROPERTIES</b>	
Max. Temperature	-30° to +90° C
Resistance	-22° to +194°F
<b>ELECTRICAL PROPERTIES</b>	
Specific Volume	
Resistivity Ohm x Inch	3.9 x 10 <sup>17</sup>
<b>CHEMICAL PROPERTIES</b>	
Light Acids, Solvents	Stable
Fuels, Mineral Oils	Stable
Alcohol, Paints, Saltwater	Stable

N

# How to Order ParKlamp Kits

Select a symbol from Box 1 and pair it with a symbol from Box 2 to create a part number for the kit.

**Example:** Weld Plate Kit – Twin Series for 3/4" tube.

Box 1	Box 2
WPT	3190

TABLE  
OF  
CONTENTS

VISUAL  
INDEX

Box 1 : Mounting – Assembly Type	
Symbol	Description
WP	Weld Plate Kit – Standard Series
WPH	Weld Plate Kit – Heavy Series
WPE	Elongated Weld Plate Kit – Standard Series
WPT	Weld Plate Kit – Twin Series
RN	Rail Nut Kit – Standard Series
RNH	Rail Nut Kit – Heavy Series
RNT	Rail Nut Kit – Twin Series
SA	Stacked Assembly Kit – Standard Series
SAH	Stacked Assembly Kit – Heavy Series
SAT	Stacked Assembly Kit – Twin Series

Box 2: Clamp Half – Size/Type Designation			
Symbol	Size	Type	Series
1064	1/4"	Tube	Standard – Twin
1064A	1/4"	Tube	Standard
3134H	1/4"	100R1 Hose	Standard
4150H	1/4"	100R2 Hose	Heavy
1095	3/8"	Tube	Standard – Twin
3095	3/8"	Tube	Heavy
1095A	3/8"	Tube	Standard
3174H	3/8"	100R1 Hose	Standard
4198H	3/8"	100R2 Hose	Heavy
2127	1/2"	Tube	Standard – Twin
3127	1/2"	Tube	Heavy
3205H	1/2"	100R1 Hose	Standard
4221H	1/2"	100R2 Hose	Heavy
3213	1/2"	Pipe	Standard
4213	1/2"	Pipe	Heavy
2160	5/8"	Tube	Standard – Twin
3160	5/8"	Tube	Heavy
3239H	5/8"	100R1 Hose	Standard
4251H	5/8"	100R2 Hose	Heavy
3190	3/4"	Tube	Standard – Twin
4190	3/4"	Tube	Heavy
5278H	3/4"	100R1 Hose	Standard
4292H	3/4"	100R2 Hose	Heavy
4266	3/4"	Pipe	Standard – Twin
4267	3/4"	Pipe	Heavy
3254	1"	Tube	Standard – Twin
4254	1"	Tube	Heavy
5357H	1"	100R1 Hose	Standard
6378H	1"	100R2 Hose	Heavy
5334	1"	Pipe	Standard – Heavy – Twin
5320	1 1/4"	Tube	Standard – Heavy – Twin
5438H	1 1/4"	100R1 Hose	Standard
6484H	1 1/4"	100R2 Hose	Heavy
5422	1 1/4"	Pipe	Heavy
5381	1 1/2"	Tube	Standard – Heavy – Twin
6498H	1 1/2"	100R1 Hose	Standard
6544H	1 1/2"	100R2 Hose	Heavy
6483	1 1/2"	Pipe	Standard – Heavy
6508	2"	Tube	Standard – Heavy
6603	2"	Pipe	Heavy
6635	2 1/2"	Tube	Heavy
7762	3"	Tube	Heavy



Weld Plate Kit



Rail Nut Kit



Stacked Assembly Kit

[Click here for CADs, Support Resources or to Configure Parts Online](#)

# Clamp Halves

Standard Series

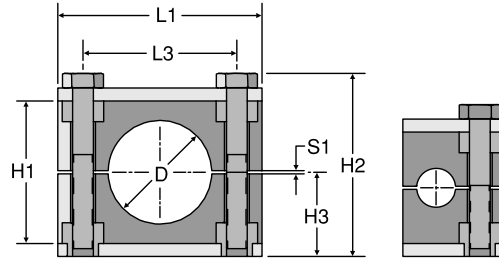

Groups 1A, 2, 3, 4, 5 and 6      Group 1

See note below

TUBE CLAMP HALVES											
PART #	TUBE SIZE	GROUP #	D		H1	H2	H3	L1	L3	S1	STANDARD FROM STOCK
			in.	mm	in.	in.	in.	in.	in.	in.	
1064-PP	1/4	1	0.25	6.4	1.06	1.45	0.65	1.02	NA	0.01	•
1095-PP	3/8	1	0.38	9.5	1.06	1.45	0.65	1.02	NA	0.01	•
1064A-PP	1/4	1A	0.25	6.4	1.06	1.45	0.65	1.45	0.78	0.01	•
1095A-PP	3/8	1A	0.38	9.5	1.06	1.45	0.65	1.45	0.78	0.01	•
2127-PP	1/2	2	0.50	12.7	1.29	1.69	0.77	1.65	1.02	0.01	•
2160-PP	5/8	2	0.63	16.0	1.29	1.69	0.77	1.65	1.02	0.01	•
3190-PP	3/4	3	0.75	19.0	1.41	1.77	0.80	1.96	1.29	0.01	•
3254-PP	1	3	1.00	25.4	1.41	1.77	0.80	1.96	1.29	0.01	•
5320-PP	1 1/4	5	1.25	32.0	2.28	2.72	1.28	2.79	2.04	0.03	•
5381-PP	1 1/2	5	1.50	38.1	2.28	2.72	1.28	2.79	2.04	0.03	•
6508-PP	2	6	2.00	50.8	2.59	3.00	1.42	3.38	2.59	0.03	•

PIPE CLAMP HALVES											
PART #	PIPE SIZE	GROUP #	D		H1	H2	H3	L1	L3	S1	STANDARD FROM STOCK
			in.	mm	in.	in.	in.	in.	in.	in.	
3213-PP	1/2	3	0.84	21.3	1.41	1.77	0.80	1.96	1.29	0.01	•
4266-PP	3/4	4	1.05	26.6	1.65	2.09	0.96	2.32	1.57	0.01	•
5334-PP	1	5	1.31	33.4	2.28	2.72	1.28	2.79	2.04	0.03	•
6483-PP	1 1/2	6	1.90	48.3	2.59	3.00	1.42	3.38	2.59	0.03	•

100R1 HOSE CLAMP HALVES											
PART #	HOSE SIZE	GROUP #	D		H1	H2	H3	L1	L3	S1	STANDARD FROM STOCK
			in.	mm	in.	in.	in.	in.	in.	in.	
H3134PP	1/4	3	0.53	13.4	1.41	1.77	0.80	1.96	1.29	0.01	•
H3174PP	3/8	3	0.69	17.4	1.41	1.77	0.80	1.96	1.29	0.01	•
H3205PP	1/2	3	0.81	20.5	1.41	1.77	0.80	1.96	1.29	0.01	•
H3239PP	5/8	3	0.94	23.9	1.41	1.77	0.80	1.96	1.29	0.01	•
H5278PP	3/4	5	1.09	27.8	2.28	2.72	1.28	2.79	2.04	0.03	•
H5357PP	1	5	1.41	35.7	2.28	2.72	1.28	2.79	2.04	0.03	•
H5438PP	1 1/4	5	1.72	43.8	2.28	2.72	1.28	2.79	2.04	0.03	•
H6498PP	1 1/2	6	1.96	49.8	2.59	3.00	1.42	3.38	2.59	0.03	•

**Note:** One clamp set includes two identical halves of polypropylene. Tube and pipe clamp halves are black in color. Hose clamp halves are green in color. Hardware shown in the illustrations above is **not** included.

Other sizes available. Please contact TFD for a quote.

**WARNING:** This product can expose you to chemicals including 1,4-Dioxane which is known to the State of California to cause cancer. For more information go to [www.P65Warnings.ca.gov](http://www.P65Warnings.ca.gov).

**When selecting components, please reference and match the "Group#" column in each part table with the associated clamps.**

- TABLE OF CONTENTS
- VISUAL INDEX
- FAQs
- GEN TECH
- TUBE CLAMPING HOW TO

N



[Click here for CADs, Support Resources or to Configure Parts Online](#)

**CP**  
Cover Plate

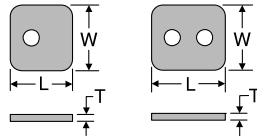

TUBE FITTING PART #	GROUP #	L LENGTH (in.)	W WIDTH (in.)	T THICKNESS (in.)	STANDARD FROM STOCK	
					-S	-SS
CP-1	1	1.10	1.18	0.11	•	•
CP-1A	1A	1.33	1.18	0.11	•	•
CP-2	2	1.59	1.18	0.11	•	•
CP-3	3	1.88	1.18	0.11	•	•
CP-4	4	2.24	1.18	0.11	•	•
CP-5	5	2.75	1.18	0.11	•	•
CP-6	6	3.38	1.18	0.11	•	•

**Material:** Steel: Zinc plated  
SS: 316 stainless steel

**WARNING:** This product can expose you to chemicals including Lead and Lead Compounds which is known to the State of California to cause cancer and birth defects or other reproductive harm. For more information go to [www.p65warnings.ca.gov](http://www.p65warnings.ca.gov).

**IPS**  
Insert

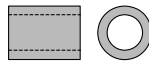

TUBE FITTING PART #	STANDARD FROM STOCK
IPS	•

**Material:** Plastic  
One size fits all groups (2 required for Groups 1A - 6).  
(Use when not using a cover plate.)

**WARNING:** This product can expose you to chemicals including Lead and Lead Compounds which is known to the State of California to cause cancer and birth defects or other reproductive harm. For more information go to [www.p65warnings.ca.gov](http://www.p65warnings.ca.gov).

**LP**  
Locking Plate

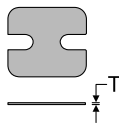

TUBE FITTING PART #	GROUP #	T THICKNESS (in.)	STANDARD FROM STOCK
LP-1	1	0.03	•
LP-1A	1A	0.03	•
LP-2	2	0.03	•
LP-3	3	0.03	•
LP-4	4	0.03	•
LP-5	5	0.03	•
LP-6	6	0.03	•

**Material:** Steel, zinc plated

**WARNING:** This product can expose you to chemicals including Lead and Lead Compounds which is known to the State of California to cause cancer and birth defects or other reproductive harm. For more information go to [www.p65warnings.ca.gov](http://www.p65warnings.ca.gov).

**BCP**  
Hexagon Head Bolt for Cover Plate  
(2 required for Groups 1A-6)

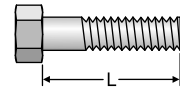

TUBE FITTING PART #	GROUP #	L LENGTH (in.)	STANDARD FROM STOCK	
			-S	-SS
BCP-1	1	1.25	•	•
BCP-1A	1A	1.25	•	•
BCP-2	2	1.38	•	•
BCP-3	3	1.50	•	•
BCP-4	4	1.88	•	•
BCP-5	5	2.38	•	•
BCP-6	6	2.75	•	•

**Note:** Bolt threads are 1/4 - 20 UNC, Grade 5, zinc clear chromate plated  
**Material:** SS: 316 stainless steel

**WARNING:** This product can expose you to chemicals including Lead and Lead Compounds which is known to the State of California to cause cancer and birth defects or other reproductive harm. For more information go to [www.p65warnings.ca.gov](http://www.p65warnings.ca.gov).

**BIP**  
Hexagon Head Bolt for Insert

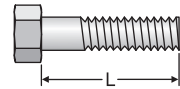

TUBE FITTING PART #	GROUP #	L LENGTH (in.)	STANDARD FROM STOCK
BIP-1	1	1.13	•
BIP-1A	1A	1.13	•
BIP-2	2	1.38	•
BIP-3	3	1.38	•
BIP-4	4	1.63	•
BIP-5	5	2.38	•
BIP-6	6	2.75	•

**Note:** Bolt threads are 1/4 - 20 UNC, Grade 5, zinc clear chromate plated

**WARNING:** This product can expose you to chemicals including Lead and Lead Compounds which is known to the State of California to cause cancer and birth defects or other reproductive harm. For more information go to [www.p65warnings.ca.gov](http://www.p65warnings.ca.gov).

**SB**  
Stacking Bolt  
(2 required for Groups 1A-6)

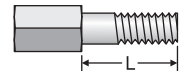

TUBE FITTING PART #	GROUP #	L LENGTH (in.)	STANDARD FROM STOCK
SB-1	1	0.78	•
SB-1A	1A	0.78	•
SB-2	2	1.00	•
SB-3	3	1.18	•
SB-4	4	1.38	•
SB-5	5	1.96	•
SB-6	6	2.36	•

**Note:** Bolt threads are 1/4 - 20 UNC, 1010 steel, zinc plated

**WARNING:** This product can expose you to chemicals including Lead and Lead Compounds which is known to the State of California to cause cancer and birth defects or other reproductive harm. For more information go to [www.p65warnings.ca.gov](http://www.p65warnings.ca.gov).

**TABLE OF CONTENTS**

**VISUAL INDEX**

**FAQs**

**GEN TECH**

**TUBE CLAMPING HOW TO**

[Click here for CADs, Support Resources or to Configure Parts Online](#)

## WP Weld Plate

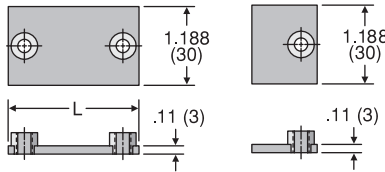

TUBE FITTING PART #	GROUP #	L LENGTH		STANDARD FROM STOCK	
		(in.)	(mm)	-S	-SS
WP-1	1	1.25	31.5	•	•
WP-1A	1A	1.41	36	•	•
WP-2	2	1.65	42	•	•
WP-3	3	1.96	50	•	•
WP-4	4	2.36	60	•	•
WP-5	5	2.79	71	•	•
WP-6	6	3.46	88	•	•

Material: Steel DD11 (1.0332): EN 10111  
Steel C4C (1.0303): EN 10263-2

**WARNING:** This product can expose you to chemicals including Lead and Lead Compounds which is known to the State of California to cause cancer and birth defects or other reproductive harm. For more information go to [www.p65warnings.ca.gov](http://www.p65warnings.ca.gov).

## WPE Weld Plate Elongated

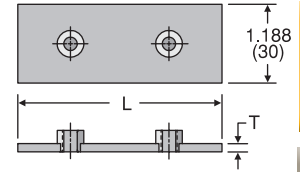

TUBE FITTING PART #	GROUP #	L LENGTH		T THICKNESS	STANDARD FROM STOCK
		(in.)	(mm)	(in.)	
WPE-1	1	2.28	58	0.11	•
WPE-1A	1A	2.51	64	0.11	•
WPE-2	2	2.75	70	0.11	•
WPE-3	3	3.07	78	0.11	•
WPE-4	4	3.42	87	0.11	•
WPE-5	5	3.93	100	0.11	•
WPE-6	6	4.52	115	0.11	•

Material: 1020 steel, zinc-phosphate plated

**WARNING:** This product can expose you to chemicals including Lead and Lead Compounds which is known to the State of California to cause cancer and birth defects or other reproductive harm. For more information go to [www.p65warnings.ca.gov](http://www.p65warnings.ca.gov).

## R Mounting Rail

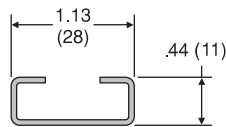

TUBE FITTING PART #	LENGTH	STANDARD FROM STOCK	
		-S	-SS
R-1	3.28 ft. (1 meter)	•	•
R-2	6.56 ft. (2 meters)	•	•

Material: Steel: Unplated  
SS: 316 stainless steel

**WARNING:** This product can expose you to chemicals including Lead and Lead Compounds which is known to the State of California to cause cancer and birth defects or other reproductive harm. For more information go to [www.p65warnings.ca.gov](http://www.p65warnings.ca.gov).

## HRN Hexagon Rail Nut

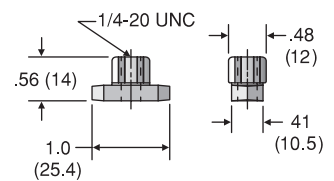

TUBE FITTING PART #	STANDARD FROM STOCK	
	-S	-SS
HRN	•	•

Material: Steel: Zinc plated  
SS: 316 stainless steel

Note: To be used with mounting rail (R)

**WARNING:** This product can expose you to chemicals including Lead and Lead Compounds which is known to the State of California to cause cancer and birth defects or other reproductive harm. For more information go to [www.p65warnings.ca.gov](http://www.p65warnings.ca.gov).

## CRA Channel Rail Adapter

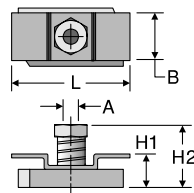

TUBE FITTING PART #	THREAD "A" UNC	L in. (mm)	B in. (mm)	H1 in. (mm)	H2 in. (mm)	STANDARD FROM STOCK
CRA 1-8	1/4-20	1.37 (35)	0.74 (19)	0.51 (13)	0.77 (19.5)	•

Material: Steel, zinc plated

**WARNING:** This product can expose you to chemicals including Lead and Lead Compounds which is known to the State of California to cause cancer and birth defects or other reproductive harm. For more information go to [www.p65warnings.ca.gov](http://www.p65warnings.ca.gov).

TABLE OF CONTENTS

VISUAL INDEX

FAQs

GEN TECH

TUBE CLAMPING HOW TO



[Click here for CADs, Support Resources or to Configure Parts Online](#)

# Clamp Halves

Heavy Series

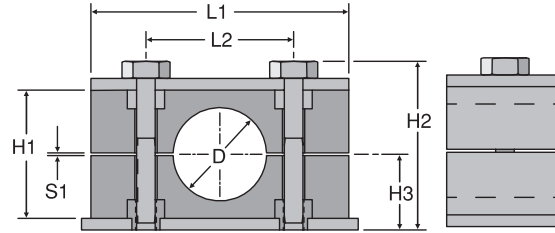

See note below

TUBE CLAMP HALVES											
PART #	TUBE SIZE	GROUP #	D		H1 (in.)	H2 (in.)	H3 (in.)	L1 (in.)	L2 (in.)	S1 (in.)	STANDARD FROM STOCK
			(in.)	(mm)							
3095-HPP	3/8	H3	0.37	9.5	1.25	2.17	0.94	2.16	1.29	0.02	•
3127-HPP	1/2	H3	0.50	12.7	1.25	2.17	0.94	2.16	1.29	0.02	•
3160-HPP	5/8	H3	0.63	16.0	1.25	2.17	0.94	2.16	1.29	0.02	•
4190-HPP	3/4	H4	0.75	19.0	1.88	2.80	1.26	2.75	1.77	0.02	•
4254-HPP	1	H4	1.00	25.4	1.88	2.80	1.26	2.75	1.77	0.02	•
5320-HPP	1 1/4	H5	1.25	32.0	2.36	3.27	1.50	3.34	2.36	0.02	•
5381-HPP	1 1/2	H5	1.50	38.1	2.36	3.27	1.50	3.34	2.36	0.02	•
6508-HPP	2	H6	2.00	50.8	3.50	4.61	2.17	4.52	3.54	0.07	•
6635-HPP	2 1/2	H6	2.50	63.5	3.50	4.61	2.17	4.52	3.54	0.07	•
7762-HPP	3	H7	3.00	76.2	4.72	5.74	2.75	5.98	4.80	0.07	•

PIPE CLAMP HALVES											
PART #	PIPE SIZE	GROUP #	D		H1 (in.)	H2 (in.)	H3 (in.)	L1 (in.)	L2 (in.)	S1 (in.)	STANDARD FROM STOCK
			(in.)	(mm)							
4213-HPP	1/2	H4	0.84	21.3	1.88	2.80	1.26	2.75	1.77	0.02	•
4267-HPP	3/4	H4	1.05	26.7	1.88	2.80	1.26	2.75	1.77	0.02	•
5334-HPP	1	H5	1.31	33.4	2.36	3.27	1.50	3.34	2.36	0.02	•
5422-HPP	1 1/4	H5	1.66	42.2	2.36	3.27	1.50	3.34	2.36	0.02	•
6483-HPP	1 1/2	H6	1.90	48.3	3.50	4.61	2.17	4.52	3.54	0.07	•
6603-HPP	2	H6	2.37	60.3	3.50	4.61	2.17	4.52	3.54	0.07	•

100R2 HOSE CLAMP HALVES											
PART #	HOSE SIZE	GROUP #	D		H1 (in.)	H2 (in.)	H3 (in.)	L1 (in.)	L2 (in.)	S1 (in.)	STANDARD FROM STOCK
			(in.)	(mm)							
H4150HPP	1/4	H4	0.59	15.0	1.83	2.80	1.26	2.75	1.77	0.02	•
H4198HPP	3/8	H4	0.78	19.8	1.83	2.80	1.26	2.75	1.77	0.02	•
H4221HPP	1/2	H4	0.87	22.1	1.83	2.80	1.26	2.75	1.77	0.02	•
H4251HPP	5/8	H4	0.99	25.1	1.83	2.80	1.26	2.75	1.77	0.02	•
H4292HPP	3/4	H4	1.15	29.2	1.83	2.80	1.26	2.75	1.77	0.02	•
H6378HPP	1	H6	1.49	37.8	3.42	4.61	2.17	4.52	3.54	0.07	•
H6484HPP	1 1/4	H6	1.91	48.4	3.42	4.61	2.17	4.52	3.54	0.07	•
H6544HPP	1 1/2	H6	2.14	54.4	3.42	4.61	2.17	4.52	3.54	0.07	•

**Note:** One clamp set includes two identical halves of polypropylene. Tube and pipe clamps are black in color. Hose clamp halves are green in color. Hardware shown in the illustration above is **not** included.

**WARNING:** This product can expose you to chemicals including 1,4-Dioxane which is known to the State of California to cause cancer. For more information go to [www.P65Warnings.ca.gov](http://www.P65Warnings.ca.gov).

When selecting components, please reference and match the "Group#" column in each part table with the associated clamps.

TABLE OF CONTENTS

VISUAL INDEX

FAQs

GEN TECH

TUBE CLAMPING HOW TO

[Click here for CADs, Support Resources or to Configure Parts Online](#)

## CPH

Cover Plate Heavy

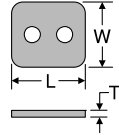

TUBE FITTING PART #	GROUP #	L LENGTH (in.)	W WIDTH (in.)	T THICKNESS (mm)		STANDARD FROM STOCK	
				(in.)	(mm)	-S	-SS
CPH-3	H3	2.16	1.18	0.31	8	•	•
CPH-4	H4	2.75	1.18	0.31	8	•	•
CPH-5	H5	3.34	1.18	0.31	8	•	•
CPH-6	H6	4.52	1.77	0.39	10	•	•
CPH-7	H7	5.98	2.36	0.39	10	•	•

Material: Steel: Zinc phosphate plated  
SS: 316 stainless steel

**WARNING:** This product can expose you to chemicals including Lead and Lead Compounds which is known to the State of California to cause cancer and birth defects or other reproductive harm. For more information go to [www.p65warnings.ca.gov](http://www.p65warnings.ca.gov).

## BCPH

Hexagon Head Bolt for Cover Plate  
(2 required per clamp set)

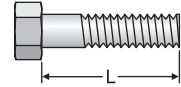

TUBE FITTING PART #	GROUP #	L LENGTH (in.)	UNC THREAD	STANDARD FROM STOCK	
				-S	-SS
BCPH-3	H3	1.75	3/8 - 16	•	•
BCPH-4	H4	2.25	3/8 - 16	•	•
BCPH-5	H5	2.75	3/8 - 16	•	•
BCPH-6	H6	4.00	7/16 - 14	•	•
BCPH-7	H7	5.25	5/8 - 11	•	•

Material: Steel: Zinc clear chromate plated, Grade 5 bolt  
SS: 316 stainless steel

**WARNING:** This product can expose you to chemicals including Lead and Lead Compounds which is known to the State of California to cause cancer and birth defects or other reproductive harm. For more information go to [www.p65warnings.ca.gov](http://www.p65warnings.ca.gov).

## LPH

Locking Plate Heavy

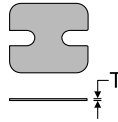

TUBE FITTING PART #	GROUP #	T THICKNESS (in.)	STANDARD FROM STOCK
LPH-3	H3	0.31	•
LPH-4	H4	0.31	•
LPH-5	H5	0.31	•
LPH-6	H6	0.39	•
LPH-7	H7	0.39	•

Material: Steel, zinc phosphate plated

**WARNING:** This product can expose you to chemicals including Lead and Lead Compounds which is known to the State of California to cause cancer and birth defects or other reproductive harm. For more information go to [www.p65warnings.ca.gov](http://www.p65warnings.ca.gov).

## SBH

Stacking Bolt Heavy  
(2 required per clamp set)

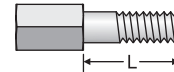

TUBE FITTING PART #	GROUP #	L LENGTH (in.)	STANDARD FROM STOCK
SBH-3	H3	1.02	•
SBH-4	H4	1.61	•
SBH-5	H5	2.01	•
SBH-6	H6	3.27	•
SBH-7	H7	4.33	•

Material: 1010 steel, zinc plated

**WARNING:** This product can expose you to chemicals including Lead and Lead Compounds which is known to the State of California to cause cancer and birth defects or other reproductive harm. For more information go to [www.p65warnings.ca.gov](http://www.p65warnings.ca.gov).

## WPH

Weld Plate Heavy

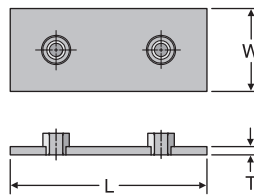

TUBE FITTING PART #	GROUP #	L LENGTH		W WIDTH		T THICKNESS		STANDARD FROM STOCK	
		(in.)	(mm)	(in.)	(mm)	(in.)	(mm)	-S	-SS
WPH-3	H3	2.88	73	1.18	30	0.31	8	•	•
WPH-4	H4	3.34	85	1.18	30	0.31	8	•	•
WPH-5	H5	3.94	100	1.18	30	0.31	8	•	•
WPH-6	H6	5.51	140	1.79	45	0.39	10	•	•
WPH-7	H7	7.09	180	2.36	60	0.39	10	•	•

Material: Steel: 1020 steel, zinc-phosphate plated  
SS: 316 stainless steel

**WARNING:** This product can expose you to chemicals including Lead and Lead Compounds which is known to the State of California to cause cancer and birth defects or other reproductive harm. For more information go to [www.p65warnings.ca.gov](http://www.p65warnings.ca.gov).

TABLE OF CONTENTS

VISUAL INDEX

FAQs

GEN TECH

TUBE CLAMPING HOW TO

N

[Click here for CADs, Support Resources or to Configure Parts Online](#)

## RH

Mounting Rail Heavy

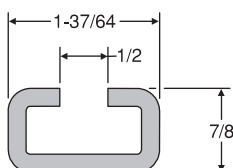

TUBE FITTING PART #	LENGTH	STANDARD FROM STOCK	
		-S	-SS
R1H	3.28 ft. (1 meter)	•	•
R2H	6.56 ft. (2 meters)	•	•

**Material:** Steel: Unplated  
SS: 316 stainless steel

**⚠ WARNING:** This product can expose you to chemicals including Lead and Lead Compounds which is known to the State of California to cause cancer and birth defects or other reproductive harm. For more information go to [www.p65warnings.ca.gov](http://www.p65warnings.ca.gov).

## RNH

Mounting Rail Nut Heavy

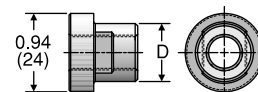

TUBE FITTING PART #	GROUP #	D DIAMETER		THREAD	STANDARD FROM STOCK	
		(in.)	(mm)		-S	-SS
RNH-10	H3, H4, H5	0.70	18	3/8 - 16 UNC	•	•
RNH-12	H6	0.78	20	7/16 - 14 UNC	•	•

**Material:** Steel: Zinc-phosphate plated  
SS: 316 stainless steel

Note: To be used with mounting rail heavy (RH)

**⚠ WARNING:** This product can expose you to chemicals including Lead and Lead Compounds which is known to the State of California to cause cancer and birth defects or other reproductive harm. For more information go to [www.p65warnings.ca.gov](http://www.p65warnings.ca.gov).

## CRA

Channel Rail Adapter

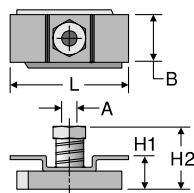

TUBE FITTING PART #	THREAD "A" UNC	L in. (mm)	B in. (mm)	H1 in. (mm)	H2 in. (mm)	STANDARD FROM STOCK
CRA 3-5	3/8-16	1.37 (35)	0.86 (22)	0.73 (18.5)	1.08 (27.5)	•
CRA 6	7/16-14	1.77 (45)	0.98 (25)	0.67 (17)	1.08 (27.5)	•

**Material:** Steel, zinc plated

Note: To be used with channel rails (Parker does not supply these).

**⚠ WARNING:** This product can expose you to chemicals including Lead and Lead Compounds which is known to the State of California to cause cancer and birth defects or other reproductive harm. For more information go to [www.p65warnings.ca.gov](http://www.p65warnings.ca.gov).

TABLE OF CONTENTS

VISUAL INDEX

FAQs

GEN TECH

TUBE CLAMPING HOW TO



[Click here for CADs, Support Resources or to Configure Parts Online](#)

# Clamp Halves

Twin Series

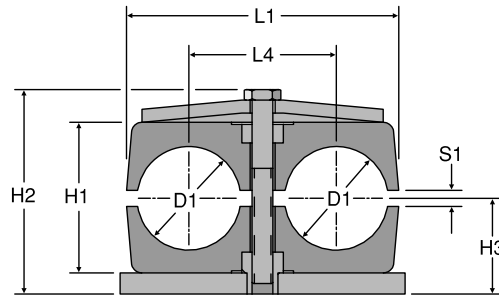

See note below

TUBE CLAMP HALVES												
PART #	TUBE SIZE	GROUP #	D1		H1	H2	H3	L1	L4	S1	STANDARD FROM STOCK	
			in.	mm	in.	in.	in.	in.	in.	in.		
1064/64-PP	1/4	T1	0.25	6.4	0.79	1.18	0.59	1.41	0.78	0.02	•	
1095/95-PP	3/8	T1	0.38	9.5	0.79	1.18	0.59	1.41	0.78	0.02	•	
2127/127-PP	1/2	T2	0.50	12.7	1.06	1.73	0.71	2.08	1.14	0.03	•	
2160/160-PP	5/8	T2	0.63	16.0	1.06	1.73	0.71	2.08	1.14	0.03	•	
3190/190-PP	3/4	T3	0.75	19.0	1.45	2.17	0.93	2.63	1.41	0.03	•	
3254/254-PP	1	T3	1.00	25.4	1.45	2.17	0.93	2.63	1.41	0.03	•	
5320/320-PP	1 1/4	T5	1.25	32.0	2.09	2.83	1.26	4.17	2.20	0.03	•	
5381/381-PP	1 1/2	T5	1.50	38.1	2.09	2.83	1.26	4.17	2.20	0.03	•	

PIPE CLAMP HALVES												
PART #	PIPE SIZE	GROUP #	D1		H1	H2	H3	L1	L4	S1	STANDARD FROM STOCK	
			in.	mm	in.	in.	in.	in.	in.	in.		
4266/266-PP	3/4	T4	1.05	26.6	1.77	2.36	1.02	3.14	1.77	0.03	•	
5334/334-PP	1	T5	1.31	33.4	2.08	2.83	1.26	4.17	2.20	0.03	•	

FOR USE WITH 100R1 HOSE												
PART #	HOSE SIZE	GROUP #	D1		H1	H2	H3	L1	L4	S1	STANDARD FROM STOCK	
			in.	mm	in.	in.	in.	in.	in.	in.		
H3206/206-PP	1/2	T3	0.81	20.6	1.45	2.17	0.93	2.63	1.41	0.03	•	
H5205/205-PP	1/2	T5	0.81	20.5	2.09	2.83	1.26	4.17	2.20	0.03	•	
H5230/230-PP	5/8	T5	0.91	23.0	2.09	2.83	1.26	4.17	2.20	0.03	•	
H5280/280-PP	3/4	T5	1.10	28.0	2.09	2.83	1.26	4.17	2.20	0.03	•	

FOR USE WITH 100R2 HOSE												
PART #	HOSE SIZE	GROUP #	D1		H1	H2	H3	L1	L4	S1	STANDARD FROM STOCK	
			in.	mm	in.	in.	in.	in.	in.	in.		
H3190/190-PP	3/8	T3	0.75	19.0	1.45	2.17	0.93	2.63	1.41	0.03	•	
H3222/222-PP	1/2	T3	0.87	22.2	1.45	2.17	0.93	2.63	1.41	0.03	•	
H3250/250-PP	5/8	T3	0.98	25.0	1.45	2.17	0.93	2.63	1.41	0.03	•	
H5295/295-PP	3/4	T5	1.16	29.5	2.09	2.83	1.26	4.17	2.20	0.03	•	
H5372/372-PP	1	T5	1.46	37.2	2.09	2.83	1.26	4.17	2.20	0.03	•	

**Note:** One clamp set includes two identical halves of polypropylene. Tube and pipe clamp halves are black in color. Hose clamp halves are green. Hardware shown in the illustration above is **not** included.

**WARNING:** This product can expose you to chemicals including 1,4-Dioxane which is known to the State of California to cause cancer. For more information go to [www.P65Warnings.ca.gov](http://www.P65Warnings.ca.gov).

When selecting components, please reference and match the "Group#" column in each part table with the associated clamps.

- TABLE OF CONTENTS
- VISUAL INDEX
- FAQs
- GEN TECH
- TUBE CLAMPING HOW TO

N

[Click here for CADs, Support Resources or to Configure Parts Online](#)

## CPT

Cover Plate

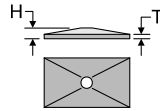

TUBE FITTING PART #	GROUP #	T THICKNESS		H HEIGHT		STANDARD FROM STOCK	
		(in.)	(mm)	(in.)	(mm)	-S	-SS
CPT-1	T1	0.06	1.5	—	—	•	•
CPT-2	T2	0.13	3.0	0.28	7.0	•	•
CPT-3	T3	0.13	3.0	0.28	7.0	•	•
CPT-4	T4	0.13	3.0	0.31	8.0	•	•
CPT-5	T5	0.13	3.0	0.31	8.0	•	•

**Material:** Steel: Zinc plated  
SS: 316 stainless steel

**WARNING:** This product can expose you to chemicals including Lead and Lead Compounds which is known to the State of California to cause cancer and birth defects or other reproductive harm. For more information go to [www.p65warnings.ca.gov](http://www.p65warnings.ca.gov).

## BCPT

Hexagon Head Bolt for Cover Plate

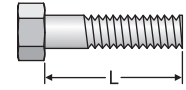

TUBE FITTING PART #	GROUP #	L LENGTH (in.)	UNC THREAD	STANDARD FROM STOCK	
				-S	-SS
BCPT-1	T1	1.38	1/4 - 20	•	•
BCPT-2	T2	1.38	5/16 - 18	•	•
BCPT-3	T3	1.75	5/16 - 18	•	•
BCPT-4	T4	2.00	5/16 - 18	•	•
BCPT-5	T5	2.50	5/16 - 18	•	•

**Material:** Steel: Zinc clear chromate plated  
SS: 316 stainless steel

**WARNING:** This product can expose you to chemicals including Lead and Lead Compounds which is known to the State of California to cause cancer and birth defects or other reproductive harm. For more information go to [www.p65warnings.ca.gov](http://www.p65warnings.ca.gov).

## LPT

Locking Plate

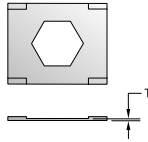

TUBE FITTING PART #	GROUP #	T THICKNESS (in.)	STANDARD FROM STOCK
LPT-1	T1	0.02	•
LPT-2	T2	0.02	•
LPT-3	T3	0.02	•
LPT-4	T4	0.02	•
LPT-5	T5	0.02	•

**Material:** Steel, zinc plated

**WARNING:** This product can expose you to chemicals including Lead and Lead Compounds which is known to the State of California to cause cancer and birth defects or other reproductive harm. For more information go to [www.p65warnings.ca.gov](http://www.p65warnings.ca.gov).

## SBT

Stacking Bolt

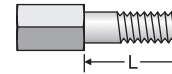

TUBE FITTING PART #	GROUP #	L LENGTH (in.)	UNC THREAD	STANDARD FROM STOCK
SBT-1	T1	0.59	1/4 - 20	•
SBT-2	T2	0.78	5/16 - 18	•
SBT-3	T3	1.13	5/16 - 18	•
SBT-4	T4	1.69	5/16 - 18	•
SBT-5	T5	1.78	5/16 - 18	•

**Material:** Zinc plated, 1010 steel

**WARNING:** This product can expose you to chemicals including Lead and Lead Compounds which is known to the State of California to cause cancer and birth defects or other reproductive harm. For more information go to [www.p65warnings.ca.gov](http://www.p65warnings.ca.gov).

TABLE OF CONTENTS

VISUAL INDEX

FAQs

GEN TECH

TUBE CLAMPING HOW TO

[Click here for CADs, Support Resources or to Configure Parts Online](#)

### WPT

Weld Plate Twin

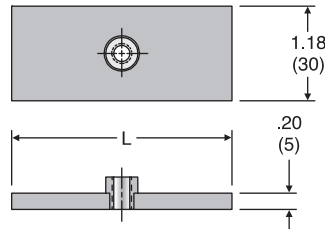

TUBE FITTING PART #	GROUP #	L LENGTH		STANDARD FROM STOCK	
		(in.)	(mm)	-S	-SS
WPT-1	T1	1.47	37	•	•
WPT-2	T2	2.31	55	•	•
WPT-3	T3	2.75	70	•	•
WPT-4	T4	3.34	85	•	•
WPT-5	T5	4.34	110	•	•

Material: Steel: Zinc-phosphate plated  
SS: 316 stainless steel

**WARNING:** This product can expose you to chemicals including Lead and Lead Compounds which is known to the State of California to cause cancer and birth defects or other reproductive harm. For more information go to [www.p65warnings.ca.gov](http://www.p65warnings.ca.gov).

### R

Mounting Rail

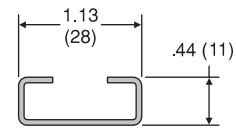

TUBE FITTING PART #	LENGTH	STANDARD FROM STOCK	
		-S	-SS
R-1	3.28 ft. (1 meter)	•	•
R-2	6.56 ft. (2 meters)	•	•

Material: Steel: Unplated  
SS: 316 stainless steel

**WARNING:** This product can expose you to chemicals including Lead and Lead Compounds which is known to the State of California to cause cancer and birth defects or other reproductive harm. For more information go to [www.p65warnings.ca.gov](http://www.p65warnings.ca.gov).

### RNT

Mounting Rail Nut Twin

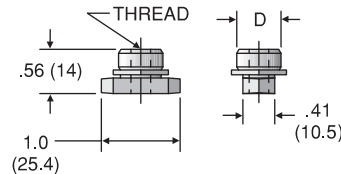

TUBE FITTING PART #	GROUP #	D DIAMETER		THREAD	STANDARD FROM STOCK	
		(in.)	(mm)		-S	-SS
RNT-1	T1	0.39	10	1/4 - 20 UNC	•	•
RNT-2-5	T2-T5	0.56	14	5/16 - 18 UNC	•	•

Material: Steel: Zinc plated  
SS: 316 stainless steel

Note: to be used with mounting rail (R)

**WARNING:** This product can expose you to chemicals including Lead and Lead Compounds which is known to the State of California to cause cancer and birth defects or other reproductive harm. For more information go to [www.p65warnings.ca.gov](http://www.p65warnings.ca.gov).

### CRA

Channel Rail Adapter

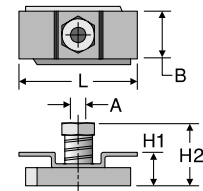

TUBE FITTING PART #	THREAD "A" UNC	L in. (mm)	B in. (mm)	H1 in. (mm)	H2 in. (mm)	STANDARD FROM STOCK
CRA 2-3D	5/16-18	1.49 (38)	2.55 (65)	0.73 (18.5)	1.08 (27.5)	•

Material: Steel, zinc plated

**WARNING:** This product can expose you to chemicals including Lead and Lead Compounds which is known to the State of California to cause cancer and birth defects or other reproductive harm. For more information go to [www.p65warnings.ca.gov](http://www.p65warnings.ca.gov).

TABLE OF CONTENTS

VISUAL INDEX

FAQs

GEN TECH

TUBE CLAMPING HOW TO

N

[Click here for CADs, Support Resources or to Configure Parts Online](#)

# Clamp Halves

Compact Spiral Hose Heavy Series

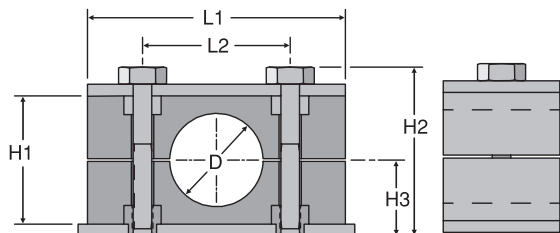

See note below

COMPACT SPIRAL HOSE CLAMP HALVES										
PART #	HOSE SIZE	GROUP #	D		H1 (in.)	H2 (in.)	H3 (in.)	L1 (in.)	L2 (in.)	STANDARD FROM STOCK
			(in.)	(mm)						
H4213-HPP	-8	H4	0.84	21.3	1.83	2.80	1.26	2.75	1.77	•
H4250-HPP	-10	H4	0.98	25.0	1.83	2.80	1.26	2.75	1.77	•
H4280-HPP	-12	H4	1.10	28.0	1.83	2.80	1.26	2.75	1.77	•
H6354-HPP	-16	H6	1.39	35.4	3.42	4.61	2.17	4.52	3.54	•
H6445-HPP	-20	H6	1.75	44.5	3.42	4.61	2.17	4.52	3.54	•
H6530-HPP	-24	H6	2.09	53.0	3.42	4.61	2.17	4.52	3.54	•
H6680-HPP	-32	H6	2.68	68.0	3.42	4.61	2.17	4.52	3.54	•

**Note:** One clamp set includes two identical halves of polypropylene. Hardware shown in the illustration above is **not** included.

**WARNING:** This product can expose you to chemicals including 1,4-Dioxane which is known to the State of California to cause cancer. For more information go to [www.P65Warnings.ca.gov](http://www.P65Warnings.ca.gov).

**When selecting components, please reference and match the "Group#" column in each part table with the associated clamps.**

- TABLE OF CONTENTS
- VISUAL INDEX
- FAQs
- GEN TECH
- TUBE CLAMPING HOW TO

[Click here for CADs, Support Resources or to Configure Parts Online](#)

## CPH

Cover Plate Heavy

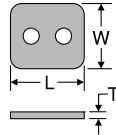

TUBE FITTING PART #	GROUP #	L LENGTH (in.)	W WIDTH (in.)	T THICKNESS		STANDARD FROM STOCK	
				(in.)	(mm)	-S	-SS
CPH-4	H4	2.75	1.18	0.31	8	•	•
CPH-6	H6	4.52	1.77	0.39	10	•	•

Material: Steel: Zinc plated

**WARNING:** This product can expose you to chemicals including Lead and Lead Compounds which is known to the State of California to cause cancer and birth defects or other reproductive harm. For more information go to [www.p65warnings.ca.gov](http://www.p65warnings.ca.gov).

## BCPH

Hexagon Head Bolt for Cover Plate  
(2 required per clamp set)

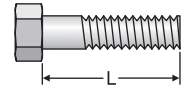

TUBE FITTING PART #	GROUP #	L LENGTH (in.)	UNC THREAD	STANDARD FROM STOCK	
				-S	-SS
BCPH-4	H4	2.25	3/8 - 16	•	•
BCPH-6	H6	4.00	7/16 - 14	•	•

Material: Steel: Zinc clear chromate plated, Grade 5 bolt  
SS: 316 stainless steel

**WARNING:** This product can expose you to chemicals including Lead and Lead Compounds which is known to the State of California to cause cancer and birth defects or other reproductive harm. For more information go to [www.p65warnings.ca.gov](http://www.p65warnings.ca.gov).

## LPH

Locking Plate Heavy

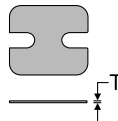

TUBE FITTING PART #	GROUP #	T THICKNESS (in.)	STANDARD FROM STOCK
LPH-4	H4	0.31	•
LPH-6	H6	0.39	•

Material: Steel: Zinc plated

**WARNING:** This product can expose you to chemicals including Lead and Lead Compounds which is known to the State of California to cause cancer and birth defects or other reproductive harm. For more information go to [www.p65warnings.ca.gov](http://www.p65warnings.ca.gov).

## SBH

Stacking Bolt Heavy  
(2 required per clamp set)

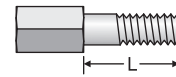

TUBE FITTING PART #	GROUP #	L LENGTH (in.)	STANDARD FROM STOCK
SBH-4	H4	1.61	•
SBH-6	H6	3.27	•

Material: Steel: Zinc plated

**WARNING:** This product can expose you to chemicals including Lead and Lead Compounds which is known to the State of California to cause cancer and birth defects or other reproductive harm. For more information go to [www.p65warnings.ca.gov](http://www.p65warnings.ca.gov).

## WPH

Weld Plate Heavy

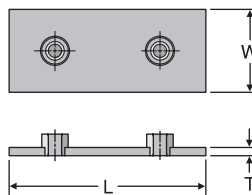

TUBE FITTING PART #	GROUP #	L LENGTH		W WIDTH		T THICKNESS		STANDARD FROM STOCK	
		(in.)	(mm)	(in.)	(mm)	(in.)	(mm)	-S	-SS
WPH-4	H4	3.34	85	1.18	30	0.31	8	•	•
WPH-6	H6	5.51	140	1.79	45	0.39	10	•	•

Material: Steel: Zinc-phosphate plated  
SS: 316 stainless steel

**WARNING:** This product can expose you to chemicals including Lead and Lead Compounds which is known to the State of California to cause cancer and birth defects or other reproductive harm. For more information go to [www.p65warnings.ca.gov](http://www.p65warnings.ca.gov).

TABLE OF CONTENTS

VISUAL INDEX

FAQs

GEN TECH

TUBE CLAMPING HOW TO

N



[Click here for CADs, Support Resources or to Configure Parts Online](#)

**RH**  
Mounting Rail Heavy

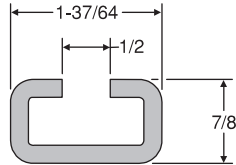

TUBE FITTING PART #	LENGTH	STANDARD FROM STOCK	
		-S	-SS
R1H	3.28 ft. (1 meter)	•	•
R2H	6.56 ft. (2 meters)	•	•

**Material:** Steel: Unplated  
SS: 316 stainless steel

**WARNING:** This product can expose you to chemicals including Lead and Lead Compounds which is known to the State of California to cause cancer and birth defects or other reproductive harm. For more information go to [www.p65warnings.ca.gov](http://www.p65warnings.ca.gov).

**RNH**  
Mounting Rail Nut Heavy

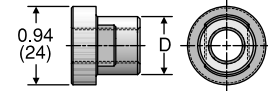

TUBE FITTING PART #	GROUP #	D DIAMETER		THREAD	STANDARD FROM STOCK	
		(in.)	(mm)		-S	-SS
RNH-10	H4	0.70	18	3/8 - 16 UNC	•	•
RNH-12	H6	0.78	20	7/16 - 14 UNC	•	•

**Material:** Steel: Zinc plated  
SS: 316 stainless steel

**Note:** To be used with mounting rail heavy (RH)

**WARNING:** This product can expose you to chemicals including Lead and Lead Compounds which is known to the State of California to cause cancer and birth defects or other reproductive harm. For more information go to [www.p65warnings.ca.gov](http://www.p65warnings.ca.gov).

**CRA**  
Channel Rail Adapter

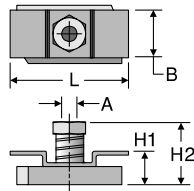

TUBE FITTING PART #	GROUP #	THREAD "A" UNC	L in. (mm)	B in. (mm)	H1 in. (mm)	H2 in. (mm)	STANDARD FROM STOCK
CRA 3-5	H4	3/8-16	1.37 (35)	0.86 (22)	0.73 (18.5)	1.08 (27.5)	•
CRA 6	H6	7/16-14	1.77 (45)	0.98 (25)	0.67 (17)	1.08 (27.5)	•

**Material:** Steel: Zinc plated

**WARNING:** This product can expose you to chemicals including Lead and Lead Compounds which is known to the State of California to cause cancer and birth defects or other reproductive harm. For more information go to [www.p65warnings.ca.gov](http://www.p65warnings.ca.gov).

TABLE OF CONTENTS

VISUAL INDEX

FAQs

GEN TECH

TUBE CLAMPING HOW TO

[Click here for CADs, Support Resources or to Configure Parts Online](#)

# Clamp Halves

Compact Spiral Hose Heavy Twin Series

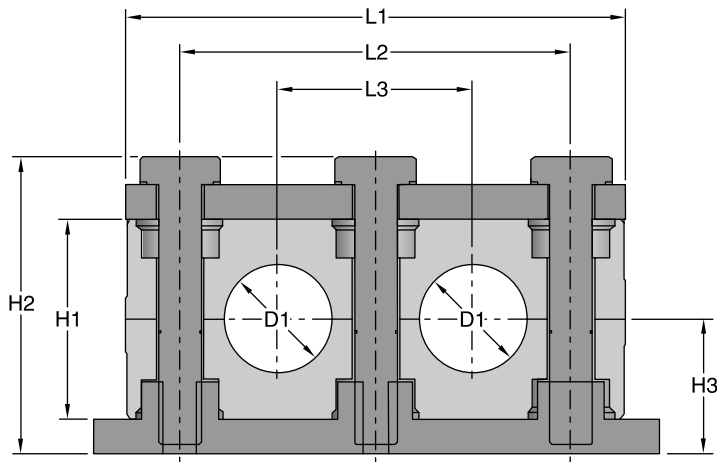

See note below

COMPACT SPIRAL HOSE CLAMP HALVES											
PART #	HOSE SIZE	GROUP #	D1		H1 (in.)	H2 (in.)	H3 (in.)	L1 (in.)	L2 (in.)	L3 (in.)	STANDARD FROM STOCK
			(in.)	(mm)							
H4213/213-HPP	-8	HT4	0.84	21.3	1.89	2.77	1.26	4.53	3.54	1.77	•
H4250/250-HPP	-10	HT4	0.98	25.0	1.89	2.77	1.26	4.53	3.54	1.77	•
H4280/280-HPP	-12	HT4	1.10	28.0	1.89	2.77	1.26	4.53	3.54	1.77	•
H5354/354-HPP	-16	HT5	1.39	35.4	2.36	3.24	1.50	5.71	4.72	2.36	•

**Note:** One clamp set includes two identical halves of polypropylene. Hardware shown in the illustration above is **not** included.

**WARNING:** This product can expose you to chemicals including 1,4-Dioxane which is known to the State of California to cause cancer. For more information go to [www.P65Warnings.ca.gov](http://www.P65Warnings.ca.gov).

When selecting components, please reference and match the "Group#" column in each part table with the associated clamps.

- TABLE OF CONTENTS
- VISUAL INDEX
- FAQs
- GEN TECH
- TUBE CLAMPING HOW TO

[Click here for CADs, Support Resources or to Configure Parts Online](#)

## CPHT

Cover Plate

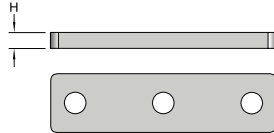

TUBE FITTING PART #	GROUP #	H HEIGHT		STANDARD FROM STOCK	
		(in.)	(mm)	-S	-SS
CPHT-4	HT4	0.31	8.0	•	•
CPHT-5	HT5	0.31	8.0	•	•

Material: Steel: Zinc plated

**WARNING:** This product can expose you to chemicals including Lead and Lead Compounds which is known to the State of California to cause cancer and birth defects or other reproductive harm. For more information go to [www.p65warnings.ca.gov](http://www.p65warnings.ca.gov).

## BCPH

Hexagon Head Bolt for Cover Plate  
(2 required per clamp set)

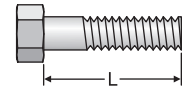

TUBE FITTING PART #	GROUP #	L LENGTH (in.)	UNC THREAD	STANDARD FROM STOCK	
				-S	-SS
BCPH-4	HT4	2.25	3/8 - 16	•	•
BCPH-5	HT5	2.75	3/8 - 16	•	•

Material: Steel: Zinc clear chromate plated, Grade 5 bolt  
SS: 316 stainless steel

**WARNING:** This product can expose you to chemicals including Lead and Lead Compounds which is known to the State of California to cause cancer and birth defects or other reproductive harm. For more information go to [www.p65warnings.ca.gov](http://www.p65warnings.ca.gov).

## WPHT

Weld Plate

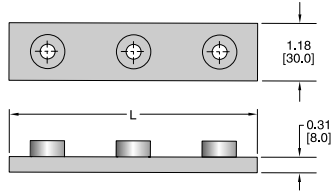

TUBE FITTING PART #	GROUP #	L LENGTH		STANDARD FROM STOCK	
		(in.)	(mm)	-S	-SS
WPHT-4	HT4	5.12	130.0	•	•
WPHT-5	HT5	6.30	160.0	•	•

Material: Steel: Zinc-phosphate plated

**WARNING:** This product can expose you to chemicals including Lead and Lead Compounds which is known to the State of California to cause cancer and birth defects or other reproductive harm. For more information go to [www.p65warnings.ca.gov](http://www.p65warnings.ca.gov).

## RH

Mounting Rail Heavy

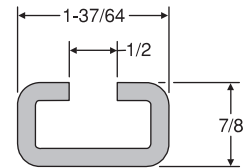

TUBE FITTING PART #	LENGTH	STANDARD FROM STOCK	
		-S	-SS
R1H	3.28 ft. (1 meter)	•	•
R2H	6.56 ft. (2 meters)	•	•

Material: Steel: Unplated  
SS: 316 stainless steel

**WARNING:** This product can expose you to chemicals including Lead and Lead Compounds which is known to the State of California to cause cancer and birth defects or other reproductive harm. For more information go to [www.p65warnings.ca.gov](http://www.p65warnings.ca.gov).

## RNH

Mounting Rail Nut Heavy

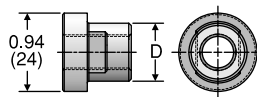

TUBE FITTING PART #	GROUP #	D DIAMETER		THREAD	STANDARD FROM STOCK	
		(in.)	(mm)		-S	-SS
RNH-10	HT4, HT5	0.70	18	3/8 - 16 UNC	•	•

Material: Steel: Zinc plated

Note: To be used with mounting rail heavy (RH)

**WARNING:** This product can expose you to chemicals including Lead and Lead Compounds which is known to the State of California to cause cancer and birth defects or other reproductive harm. For more information go to [www.p65warnings.ca.gov](http://www.p65warnings.ca.gov).

## CRA

Channel Rail Adapter

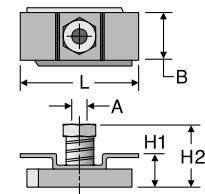

TUBE FITTING PART #	GROUP #	THREAD "A" UNC	L	B	H1	H2	STANDARD FROM STOCK
			in. (mm)	in. (mm)	in. (mm)	in. (mm)	
CRA 3-5	HT4	3/8-16	1.37 (35)	0.86 (22)	0.73 (18.5)	1.08 (27.5)	•

Material: Steel: Zinc plated

**WARNING:** This product can expose you to chemicals including Lead and Lead Compounds which is known to the State of California to cause cancer and birth defects or other reproductive harm. For more information go to [www.p65warnings.ca.gov](http://www.p65warnings.ca.gov).

TABLE OF CONTENTS

VISUAL INDEX











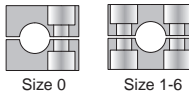



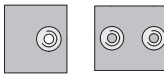
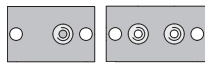
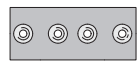
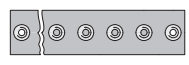
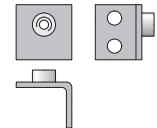

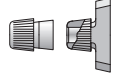
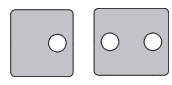
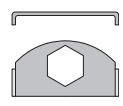

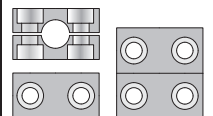



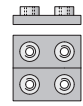

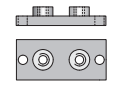

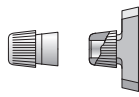
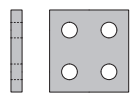

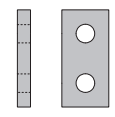
FAQs

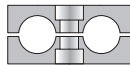
GEN TECH

TUBE CLAMPING HOW TO

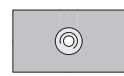
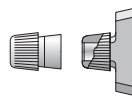
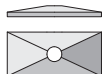
# 0 METRIC CLAMPS

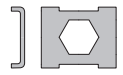

<p><b>Standard Series Normal Mechanical Stress</b></p>	<p><b>RAP/RAN/RAA</b> Clamp Halves</p>  <p>Size 0    Size 1-6</p> <p>O4</p>	<p><b>SLA</b> Slotted Screws</p>  <p>O5</p>	<p><b>SSLA</b> Hex Head Bolt</p>  <p>O5</p>	<p><b>ISA</b> Cap Screws</p>  <p>O5</p>	<p><b>ASA</b> Stacking Bolts</p>  <p>O6</p>
<p><b>APKA</b> Weld Plate-Short</p>  <p>Size 0    Size 1-6</p> <p>O5</p>	<p><b>APLA</b> Weld Plate-Long</p>  <p>Size 0    Size 1-6</p> <p>O5</p>	<p><b>APDA</b> Double Weld Plate</p>  <p>O5</p>	<p><b>APRA</b> Weld Plate-Strip</p>  <p>O6</p>	<p><b>APWA</b> Weld Plate Angled</p>  <p>O6</p>	<p><b>TS</b> Mounting Rail</p>  <p>O6</p>
<p><b>TMA</b> Lock Nut</p>  <p>O6</p>	<p><b>DPA</b> Top Plate</p>  <p>Size 0    Size 1-6</p> <p>O6</p>	<p><b>SBA</b> Locking Plate</p>  <p>O6</p>	<p><b>USA</b> Locking Washer</p>  <p>O6</p>	<p><b>Heavy Series High Mechanical Stress</b></p>	<p><b>RCP/RCN/RCA/RCPD</b> Clamp Halves</p>  <p>O7</p>
<p><b>SSC</b> Hex Head Bolts</p>  <p>O8</p>	<p><b>ASC</b> Stacking Bolts</p>  <p>O8</p>	<p><b>APC</b> Weld Plate</p>  <p>O8</p>	<p><b>APDC</b> Double Weld Plate</p>  <p>O8</p>	<p><b>ISC</b> Cap Screws</p>  <p>O9</p>	<p><b>APLC</b> Weld/Screw Plate</p>  <p>O8</p>
<p><b>TSC</b> Mounting Rail</p>  <p>O9</p>	<p><b>TMC</b> Lock Nut</p>  <p>O9</p>	<p><b>DPDC</b> Double Top Plate</p>  <p>O9</p>	<p><b>SPC</b> Locking Plate</p>  <p>O9</p>	<p><b>DPC</b> Top Plate</p>  <p>O10</p>	<p><b>USC</b> Locking Washer</p>  <p>O10</p>
<p><b>Twin Series Normal Mechanical Stress</b></p>	<p><b>RBP/RBN</b> Clamp Halves</p>  <p>O10</p>	<p><b>SSB</b> Hex Head Bolt</p>  <p>O11</p>	<p><b>ISB</b> Cap Screws</p>  <p>O11</p>	<p><b>ASB</b> Stacking Bolts</p>  <p>O11</p>	<p><b>APB</b> Weld Plate</p>  <p>O11</p>
<p><b>TMB</b> Lock Nut</p>  <p>O11</p>	<p><b>DPB</b> Top Plate</p>  <p>O11</p>	<p><b>APRB</b> Strip Weld Plate</p>  <p>O12</p>	<p><b>TS</b> Mounting Rail</p>  <p>O12</p>	<p><b>SBB</b> Locking Plate</p>  <p>O12</p>	<p><b>US</b> Locking Washer</p>  <p>O12</p>



## Metric Clamps

The Parker Metric Clamp system is designed for restraining tube, pipe and hose assemblies against unwanted, and potentially harmful effects of mechanical shock and vibration forces that are common in fluid power systems.

The clamping system is the most commonly overlooked aspect of fluid power system design. Failure to properly restrain the fluid conducting system can result in leakage, downtime and system malfunction, as well as significantly reduced life of tube, pipe and hose assemblies. With the Parker Metric Clamp system, the risk of problems resulting from mechanical shock and vibration can be significantly reduced.

## How Metric Clamps Work

The Metric Clamp system has two primary methods for mounting: weld plates and mounting rails. Clamps may be mounted to secure a single layer of tube or stacked for securing multiple layers.

Clamps should be mounted to a rigid structure for optimum performance. Clamping tube, pipe or hose assemblies together without mounting them to a rigid structure, often called “floating clamps,” does not provide adequate support.

Proper design of a clamping system requires that the clamps be positioned appropriately on the tube, pipe or hose assemblies. See the Assembly and Installation section of the catalog for more information on clamp location and spacing.

### Weld Plate Mounting (Fig. O1)

The weld plate mounting system allows the user to attach a single clamp assembly to a structure of similar material (steel to steel, etc) by welding the components together. Once the weld plate is attached to a structure, one clamp half can be placed onto the weld plate, followed by the tube, pipe or hose assembly. Next, the second plastic clamp half can be placed on the tube, pipe or hose assembly, followed by the cover plate. To complete the assembly, the Hex Head attachment bolts are inserted into the assembly and tightened.

### Mounting Rail Mounting (Fig. O2)

Use of a mounting rail is another way to assemble the clamping system components onto a support structure. Using a mounting rail allows multiple clamps to be mounted side-by-side for restraining a group of tube, pipe, or hose assemblies. The mounting rail also provides the ability to move the location of the clamps in one direction for easier alignment. The rail can be attached to a support structure by welding or bolting. Once the mounting rail is in place, rail nuts can be slid into the rail. The first clamp half, followed by the tube, pipe or hose assembly, can then be installed over the corresponding rail nuts. After this, the second clamp half, the cover plate and the hex head attachment bolts can be installed to complete the assembly.



Fig. O1 – Weld Plate Assembly



Fig. O2 – Mounting Rail Assembly

TABLE OF CONTENTS

VISUAL INDEX

### Stacking (Fig. O3)

A primary feature of the Metric Clamp system is its ability to accommodate stacking of a series of clamps to various heights, thus requiring a smaller footprint for mounting. To do this, simply use the stacking bolts to mount the first clamp assembly, then install a stacking plate over the first clamp and stacking bolts. The second clamp assembly can then be placed over the first clamp assembly. Complete the mounting by assembling a cover plate and using the hex head bolts to tighten the upper clamp assembly. **Note: When stacking, the clamps must be from the same series and group.**



Fig. O3 – Stacked Assembly

## Reference Locations

**Assembly and Installation:** Please refer to Section R for the assembly and installation instructions for Metric Clamps.

# RAP / RAN / RAA

Clamp Halves

TUBE FITTING PART #	GROUP #	A Metric Tube Size	A Inch Pipe Size	A Inch Tube Size	B (mm)	C (mm)	D (mm)	E (mm)
RAP006X		6						
RAP006.4X		6.4		1/4				
RAP008X		8		5/16				
RAP009.5X		9.5		3/8				
RAP010X		10	1/8					
RAP012X	0	12			28	27	12.5	13.5
RAP106X		6						
RAP106.4X		6.4		1/4				
RAP108X		8		5/16				
RAP109.5X		9.5		3/8				
RAP110X		10	1/8					
RAP112X	1	12			34	27	20	13.5
RAP212.7X		12.7		1/2				
RAP213.5X		13.5	1/4					
RAP214X		14						
RAP215X		15						
RAP216X		16		5/8				
RAP217.2X		17.2	3/8					
RAP218X	2	18			40	33	26	16.5
RAP319X		19		3/4				
RAP320X		20						
RAP321.3X		21.3	1/2					
RAP322X		22						
RAP323X		23						
RAP325X	3	25		1	48	35	33	17.5
RAP426.9X		26.9	3/4					
RAP428X		28						
RAP430X	4	30			57	42	40	21
RAP532X		32		1 1/4				
RAP533.7X		33.7	1					
RAP535X		35						
RAP538X		38		1 1/2				
RAP540X		40						
RAP542X	5	42	1 1/4		70	58	52	29
RAP644.5X		44.5		1 3/4				
RAP645X		45						
RAP648X		48	1 1/2					
RAP650X		50						
RAP650.8X		50.8		2				
RAP652X		52						
RAP655X	6	55			86	66	66	33
RAP657X		57	2 1/4					

Note: One clamp set includes two identical halves.

When selecting components, please reference and match the "Group#" column in each part table with the associated clamps.

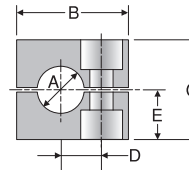

Group 0

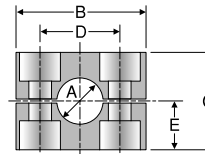

Groups 1-6

Material codes for clamp halves:

- Polypropylene - RAP
- inside plain - RAPG (for hose)
- Polyamide 6 - RAN (Nylon)
- inside plain - RANG (Nylon) (for hose)
- Aluminum - RAA (Group 1 to 6 only)

TABLE OF CONTENTS

VISUAL INDEX

FAQs

GEN TECH

TUBE CLAMPING HOW TO

## SLA

### Slotted Screws

TUBE FITTING PART #	GROUP #	D (mm)	L (mm)
SLA0X	0,1	M6 x 1	20
SLA2X	2	M6 x 1	25
SLA3X	3	M6 x 1	30
SLA4X	4	M6 x 1	35
SLA5X	5	M6 x 1	50
SLA6X	6	M6 x 1	60

**WARNING:** This product can expose you to chemicals including Lead and Lead Compounds which is known to the State of California to cause cancer and birth defects or other reproductive harm. For more information go to [www.p65warnings.ca.gov](http://www.p65warnings.ca.gov).

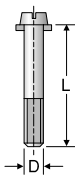

## APKA

### Weld Plate – Short

TUBE FITTING PART #	GROUP #	D (mm)	E (mm)
APKA0X	0	—	30
APKA1X	1	20	36
APKA2X	2	26	42
APKA3X	3	33	50
APKA4X	4	40	59
APKA5X	5	52	72
APKA6X	6	66	88

Thickness 3 mm

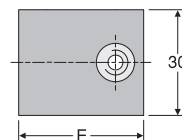

Group 0

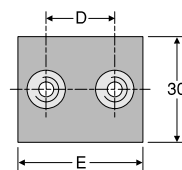

Groups 1-6

TABLE OF CONTENTS

VISUAL INDEX

FAQs

GEN TECH

TUBE CLAMPING HOW TO

## SSLA

### Hex Head Bolt

TUBE FITTING PART #	GROUP #	D (mm)	L (mm)
SSLA0X	0,1	M6 x 1	30
SSLA2/SSB1X	2	M6 x 1	35
SSLA3X	3	M6 x 1	40
SSLA4X	4	M6 x 1	45
SSLA5X	5	M6 x 1	60
SSLA6X	6	M6 x 1	70

**WARNING:** This product can expose you to chemicals including Lead and Lead Compounds which is known to the State of California to cause cancer and birth defects or other reproductive harm. For more information go to [www.p65warnings.ca.gov](http://www.p65warnings.ca.gov).

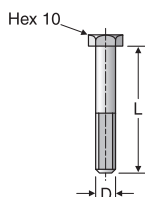

## APLA

### Weld Plate – Long

TUBE FITTING PART #	GROUP #	D (mm)	E (mm)	F (mm)
APLA0X	0	—	58	44
APLA1X	1	20	64	50
APLA2X	2	26	70	56
APLA3X	3	33	78	64
APLA4X	4	40	87	73
APLA5X	5	52	100	86
APLA6X	6	66	116	100

Thickness 3 mm

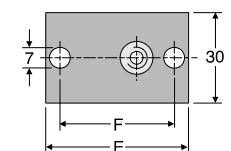

Group 0

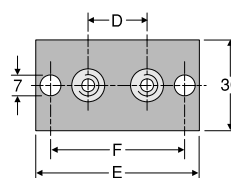

Groups 1-6

## ISA

### Cap Screws

TUBE FITTING PART #	GROUP #	D (mm)	L (mm)
ISA0X	0,1	M6 x 1	20
ISA2X	2	M6 x 1	25
ISA3X	3	M6 x 1	30
ISA4X	4	M6 x 1	35
ISA5X	5	M6 x 1	50
ISA6X	6	M6 x 1	60

**WARNING:** This product can expose you to chemicals including Lead and Lead Compounds which is known to the State of California to cause cancer and birth defects or other reproductive harm. For more information go to [www.p65warnings.ca.gov](http://www.p65warnings.ca.gov).

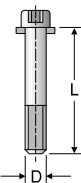

## APDA

### Double Weld Plate

TUBE FITTING PART #	GROUP #	A (mm)	D (mm)	E (mm)
APDA0X	0	30	—	61
APDA1X	1	35	20	69
APDA2X	2	43	26	86
APDA3X	3	52	33	104
APDA4X	4	60	40	117
APDA5X	5	75	52	145
APDA6X	6	90	66	176

Thickness 3 mm

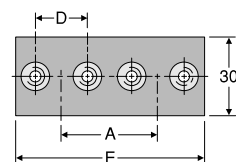

## ASA

Stacking Bolts

TUBE FITTING PART #	GROUP #	A (mm)	B (mm)	D (mm)
ASA0X	0,1	20	34	M6 x 1
ASA2X	2	25	39	M6 x 1
ASA3X	3	30	44	M6 x 1
ASA4X	4	35	49	M6 x 1
ASA5X	5	50	64	M6 x 1
ASA6X	6	60	74	M6 x 1

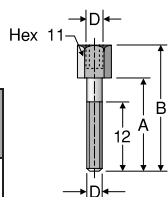

**WARNING:** This product can expose you to chemicals including Lead and Lead Compounds which is known to the State of California to cause cancer and birth defects or other reproductive harm. For more information go to [www.p65warnings.ca.gov](http://www.p65warnings.ca.gov).

## APRA

Weld Plate – Strip

TUBE FITTING PART #	GROUP #	D (mm)	A (mm)	E (mm)	NUMBER OF CLAMPS
APRA0X	0	—	30	298	10
APRA1X	1	20	35	349	10
APRA2X	2	26	43	427	10
APRA3X	3	33	52	516	10
APRA4X	4	40	60	297	5
APRA5X	5	52	75	370	5
APRA6X	6	66	90	446	5

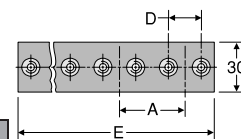

Thickness 3 mm

## APWA

Weld Plate – Angled

TUBE FITTING PART #	GROUP #	D (mm)	E (mm)
APWA0X	0	14	30
APWA1X	1	20	36
APWA2X	2	26	42
APWA3X	3	33	50
APWA4X	4	40	59
APWA5X	5	52	72
APWA6X	6	66	88

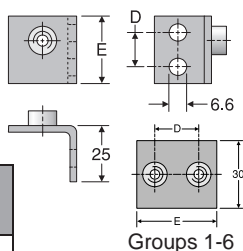

Thickness 3 mm

## DPA

Top Plate

TUBE FITTING PART #	GROUP #	B (mm)	D (mm)
DPA0X	0	0	—
DPA1X	1	34	20
DPA2X	2	40	26
DPA3X	3	48	33
DPA4X	4	57	40
DPA5X	5	70	52
DPA6X	6	86	66

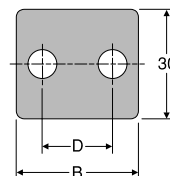
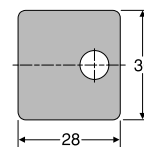

Thickness 3 mm

## TS

Mounting Rail

TUBE FITTING PART #	GROUP #	H (mm)	LENGTH (meter)
TS11A/B1X	ALL	11	1
TS14A/B1X	ALL	14	1
TS30A/B1X	ALL	30	1
TS11A/B2X	ALL	11	2
TS14A/B2X	ALL	14	2
TS30A/B2X	ALL	30	2

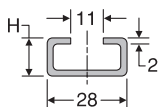

**WARNING:** This product can expose you to chemicals including Lead and Lead Compounds which is known to the State of California to cause cancer and birth defects or other reproductive harm. For more information go to [www.p65warnings.ca.gov](http://www.p65warnings.ca.gov).

## SBA

Locking Plate

TUBE FITTING PART #	GROUP #	A (mm)	SW (mm)
SBAX	ALL	30	11

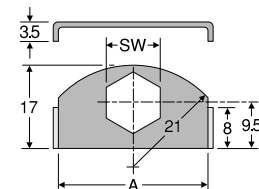

## TMA

Lock Nut

TUBE FITTING PART #	GROUP #	A (mm)	B (mm)	C (mm)	M (mm)
TMA/TMB1VERZX	ALL	25.4	10.4	12	M6 X 1

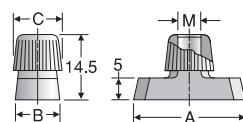

## USA

Locking Washer

TUBE FITTING PART #	GROUP #	A (mm)	B (mm)
USA/USB1X	ALL	9	18

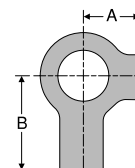

TABLE OF CONTENTS

VISUAL INDEX

FAQs

GEN TECH

TUBE CLAMPING HOW TO

# RCP / RCN / RCA / RCPG

## Clamp Halves

TUBE FITTING PART #	GROUP #	A Metric Tube Size	A Inch Pipe Size	A Inch Tube Size	B (mm)	C (mm)	D (mm)	E (mm)	F (mm)
RCP108X		8		5/16					
RCP110X		10	1/8						
RCP112X		12							
RCP113.5X	1	13.5	1/4						
RCP114X		14			55	32	33	16	30
RCP115X		15							
RCP116X		16		5/8					
RCP117.2X		17.2	3/8						
RCP118X		18							
RCP220X		20							
RCP221.3X		21.3	1/2						
RCP222X		22							
RCP223X	2	23			70	48	45	24	30
RCP225X		25		1					
RCP226.9X		26.9	3/4						
RCP228X		28							
RCP330X		30							
RCP332X		32		1 1/4					
RCP333.7X		33.7	1						
RCP335X	3	35			85	60	60	30	30
RCP338X		38		1 1/2					
RCP340X		40							
RCP342X		42	1 1/4						
RCP438X		38		1 1/2					
RCP440X		40							
RCP442X		42	1 1/4						
RCP445X		45							
RCP448.3X		48.3	1 1/2						
RCP450X	4	50			115	90	90	45	45
RCP451X		51		2					
RCP452X		52							
RCP455X		55							
RCP457X		57		2 1/4					
RCP460.3X		60.3	2						
RCP463X		63		2 1/2					
RCP465X		65							
RCP470X		70							
RCP570X		70							
RCP576.1X		76.1	2 1/2	3					
RCP580X	5	80			152	120	122	60	60
RCP582.5X		82.5		3 1/4					
RCP588.9X		88.9	3	3 1/2					
RCP690X		90							
RCP6101.6X		101.6	3 1/2	4					
RCP6108X	6	108		4 1/4	205	170	168	85	80
RCP6114.3X		114.3	4	4 1/2					
RCP6127X		127		5					
RCP7127X		127		5					
RCP7133X		133		5 1/4					
RCP7140X		140	5	5 1/2					
RCP7152.4X	7	152.4	5 1/2	6	250	200	205	100	90
RCP7159X		159		6 1/4					
RCP7165.1X		165.1	6	6 1/2					
RCP7168.3X		168.3		6 5/8					
RCP8168.3X		168.3		6 5/8					
RCP8177.8X	8	177.8		7	320	270	265	135	120
RCP8193.7X		193.7		7 5/8					
RCP8219.1X		219.1	8	8 5/8					

Note: One clamp set includes two identical halves.

When selecting components, please reference and match the "Group#" column in each part table with the associated clamps.

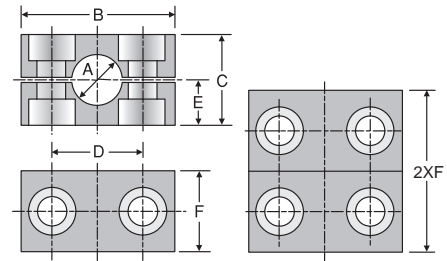

RCP

RCPD  
(2 pairs of RCP)

**Material codes for clamp halves:**  
 Polypropylene - RCP  
 inside plain - RCPG (for hose)  
 Polyamide 6 - RCN  
 Aluminum - RCA

TABLE OF CONTENTS

VISUAL INDEX

FAQs

GEN TECH

TUBE CLAMPING HOW TO





**SSC**  
Hex Head Bolts

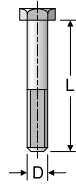

TUBE FITTING PART #	GROUP #	D (mm)	L (mm)
SSC1X	1	M10 x 1.5	45
SSC2X	2	M10 x 1.5	60
SSC3X	3	M10 x 1.5	70
SSC4X	4	M12 x 1.5	100
SSC5X	5	M16 x 2	130
SSC6X	6	M20 x 2	190
SSC7X	7	M24 x 2	220
SSC8X	8	M30 x 2	300

**WARNING:** This product can expose you to chemicals including Lead and Lead Compounds which is known to the State of California to cause cancer and birth defects or other reproductive harm. For more information go to [www.p65warnings.ca.gov](http://www.p65warnings.ca.gov).

**APC**  
Weld Plate

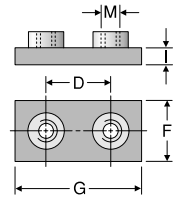

TUBE FITTING PART #	GROUP #	D (mm)	F (mm)	G (mm)	I (mm)	M (mm)
APC1X	1	33	30	73	8	M10 x 1.5
APC2X	2	45	30	85	8	M10 x 1.5
APC3X	3	60	30	100	8	M10 x 1.5
APC4X	4	90	45	140	10	M12 x 1.5
APC5X	5	122	60	180	10	M16 x 2
APC6X	6	168	80	225	15	M20 x 2
APC7X	7	205	90	270	15	M24 x 2
APC8X	8	265	120	340	25	M30 x 2

**ASC**  
Stacking Bolts

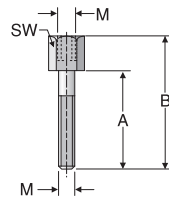

TUBE FITTING PART #	GROUP #	M (mm)	SW (mm)	A (mm)	B (mm)
ASC1X	1	M10 x 1.5	15	25	51
ASC2X	2	M10 x 1.5	15	40	66
ASC3X	3	M10 x 1.5	15	50	76
ASC4X	4	M12 x 1.5	17	85	112
ASC5X	5	M16 x 2	21	110	146
ASC6X	6	M20 x 2	27	155	206
ASC7X	7	M24 x 2	30	185	245
ASC8X	8	M30 x 2	36	250	330

**WARNING:** This product can expose you to chemicals including Lead and Lead Compounds which is known to the State of California to cause cancer and birth defects or other reproductive harm. For more information go to [www.p65warnings.ca.gov](http://www.p65warnings.ca.gov).

**APDC**  
Double Weld Plate

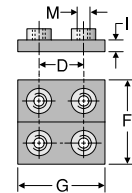

TUBE FITTING PART #	GROUP #	D (mm)	F (mm)	G (mm)	I (mm)	M (mm)
APDC1X	1	33	60	73	8	M10 x 1.5
APDC2X	2	45	60	85	8	M10 x 1.5
APDC3X	3	60	60	100	8	M10 x 1.5
APDC4X	4	90	90	140	10	M12 x 1.5
APDC5X	5	122	120	180	10	M16 x 2
APDC6X	6	168	160	225	15	M20 x 2
APDC7X	7	205	180	270	15	M24 x 2
APDC8X	8	265	240	340	25	M30 x 2

TABLE OF CONTENTS

VISUAL INDEX

FAQs

GEN TECH

TUBE CLAMPING HOW TO

**ISC**  
Cap Screws

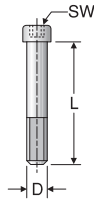

TUBE FITTING PART #	GROUP #	D (mm)	L (mm)	SW (mm)
ISC1X	1	M10 x 1.5	45	8
ISC2X	2	M10 x 1.5	60	8
ISC3X	3	M10 x 1.5	70	8
ISC4X	4	M12 x 1.5	100	10
ISC5X	5	M16 x 2	130	14
ISC6X	6	M20 x 2	190	17
ISC7X	7	M24 x 2	220	19
ISC8X	8	M30 x 2	300	22

**WARNING:** This product can expose you to chemicals including Lead and Lead Compounds which is known to the State of California to cause cancer and birth defects or other reproductive harm. For more information go to [www.p65warnings.ca.gov](http://www.p65warnings.ca.gov).

**TSC**  
Mounting Rail

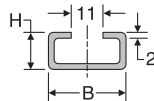

TUBE FITTING PART #	GROUP #	B (mm)	H (mm)	LENGTH (meter)
TSC1X	ALL	40	22	1
TSC2X	ALL	40	22	2

**WARNING:** This product can expose you to chemicals including Lead and Lead Compounds which is known to the State of California to cause cancer and birth defects or other reproductive harm. For more information go to [www.p65warnings.ca.gov](http://www.p65warnings.ca.gov).

**TMC**  
Lock Nut

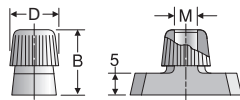

TUBE FITTING PART #	GROUP #	B (mm)	D (mm)	M (mm)
TMC1X	1-3	20	17.8	M10 x 1.5
TMC4X	4	23	19.8	M12 x 1.5

**APLC**  
Weld / Screw Plate

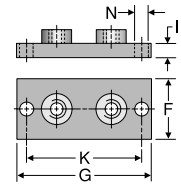

TUBE FITTING PART #	GROUP #	F (mm)	G (mm)	I (mm)	K (mm)	N (mm)
APLC1X	1	30	113	8	85	11
APLC2X	2	30	125	8	97	11
APLC3X	3	30	140	8	112	11
APLC4X	4	45	190	10	160	14
APLC5X	5	60	240	10	205	18
APLC6X	6	80	310	15	270	22
APLC7X	7	90	370	15	320	26
APLC8X	8	120	450	25	390	33

**DPDC**  
Double Top Plate

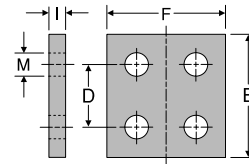

TUBE FITTING PART #	GROUP #	B (mm)	D (mm)	F (mm)	I (mm)	M (mm)
DPDC1X	1	55	33	60	8	11
DPDC2X	2	70	45	60	8	11
DPDC3X	3	85	60	60	8	11
DPDC4X	4	115	90	90	10	14
DPDC5X	5	152	122	120	10	18
DPDC6X	6	205	168	160	15	22
DPDC7X	7	250	205	180	15	26
DPDC8X	8	320	265	240	25	33

**SPC**  
Locking Plate

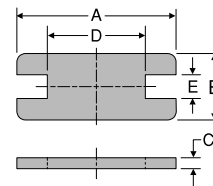

TUBE FITTING PART #	GROUP #	A (mm)	B (mm)	C (mm)	D (mm)	E (mm)
SPC1X	1	55	30	8	14	15.5
SPC2X	2	70	30	8	26	15.5
SPC3X	3	85	30	8	41	15.5
SPC4X	4	115	45	10	69	17.5
SPC5X	5	152	60	10	97	21.5
SPC6X	6	205	80	15	137	27.5
SPC7X	7	250	90	15	169	30.5
SPC8X	8	320	120	25	219	36.5

TABLE OF CONTENTS

VISUAL INDEX

FAQs

GEN TECH

TUBE CLAMPING HOW TO

O

**DPC**  
Top Plate

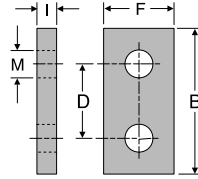

TUBE FITTING PART #	GROUP #	B (mm)	D (mm)	F (mm)	I (mm)	M (mm)
DPC1X	1	55	33	30	8	11
DPC2X	2	70	45	30	8	11
DPC3X	3	85	60	30	8	11
DPC4X	4	115	90	45	10	14
DPC5X	5	152	122	60	10	18
DPC6X	6	205	168	80	15	22
DPC7X	7	250	205	90	15	26
DPC8X	8	320	265	120	25	33

**USC**  
Locking Washer

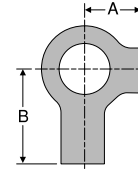

TUBE FITTING PART #	GROUP #	A (mm)	B (mm)
USC1X	1,2,3	13	22
USC4X	4	15	28
USC5X	5	18	32
USC6X	6	21	36
USC7X	7	25	42
USC8X	8	32	52

**RBP / RBN**  
Clamp Halves

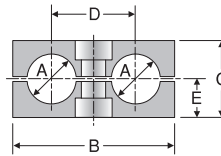

TUBE FITTING PART #	GROUP #	A Metric Tube Size	A Inch Pipe Size	A Inch Tube Size	B (mm)	C (mm)	D (mm)	E (mm)
RBP106X	1	6						
RBP106.4X		6.4		1/4				
RBP108X		8		5/16	36	27	20	13.5
RBP109.5X		9.5		3/8				
RBP110X		10	1/8					
RBP112X	12							
RBP212.7X	2	12.7		1/2				
RBP213.5X		13.5	1/4					
RBP214X		14						
RBP215X		15		5/8	53	26	29	13
RBP216X		16						
RBP217.2X	17.2	3/8						
RBP218X	18							
RBP319X	3	19		3/4				
RBP320X		20						
RBP321.3X		21.3	1/2		67	37	36	18.5
RBP322X		22						
RBP325X		25		1				
RBP426.9X	4	26.9	3/4					
RBP428X		28			82	42	45	21
RBP430X		30						
RBP532X	5	32		1 1/4				
RBP533.7X		33.7	1					
RBP535X		35			106	54	56	27
RBP538X		38		1 1/2				
RBP542X		42	1 1/4					

**Material codes for clamp halves:**  
 Polypropylene - RBP  
 inside plain - RBPG (for hose)  
 Polyamide 6 - RBN  
 Width 30 mm

Note: One clamp set includes two identical halves.

**WARNING:** This product can expose you to chemicals including 1,4-Dioxane which is known to the State of California to cause cancer. For more information go to [www.P65Warnings.ca.gov](http://www.P65Warnings.ca.gov).

When selecting components, please reference and match the "Group#" column in each part table with the associated clamps.

TABLE OF CONTENTS

VISUAL INDEX

FAQs

GEN TECH

TUBE CLAMPING HOW TO

## SSB

Hex Head Bolt

TUBE FITTING PART #	GROUP #	D (mm)	L (mm)	MATERIAL
SSLA2/SSB1X	1	M6 x 1	35	•
SSB2X	2	M8 x 1	35	•
SSB3X	3	M8 x 1	45	•
SSB4X	4	M8 x 1	50	•
SSB5X	5	M8 x 1	60	•

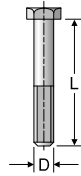

**WARNING:** This product can expose you to chemicals including Lead and Lead Compounds which is known to the State of California to cause cancer and birth defects or other reproductive harm. For more information go to [www.p65warnings.ca.gov](http://www.p65warnings.ca.gov).

## ISB

Cap Screws

TUBE FITTING PART #	GROUP #	D (mm)	L (mm)	MATERIAL
ISB1X	1	M6 x 1	35	•
ISB2X	2	M8 x 1	35	•
ISB3X	3	M8 x 1	45	•
ISB4X	4	M8 x 1	50	•
ISB5X	5	M8 x 1	60	•

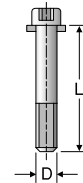

**WARNING:** This product can expose you to chemicals including Lead and Lead Compounds which is known to the State of California to cause cancer and birth defects or other reproductive harm. For more information go to [www.p65warnings.ca.gov](http://www.p65warnings.ca.gov).

## ASB

Stacking Bolts

TUBE FITTING PART #	GROUP #	D (mm)	A (mm)	B (mm)	SW (mm)
ASB1X	1	M6 x 1	20	34	11
ASB2X	2	M8 x 1	20	33	12
ASB3X	3	M8 x 1	29	44	12
ASB4X	4	M8 x 1	34	49	12
ASB5X	5	M8 x 1	47	62	12

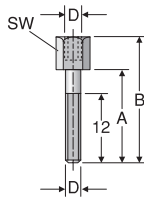

**WARNING:** This product can expose you to chemicals including Lead and Lead Compounds which is known to the State of California to cause cancer and birth defects or other reproductive harm. For more information go to [www.p65warnings.ca.gov](http://www.p65warnings.ca.gov).

## TMB

Lock Nut

TUBE FITTING PART #	GROUP #	A (mm)	B (mm)	C (mm)	M (mm)
TMA/TMB1VERZX	1	25.4	10.4	12	M6 x 1
TMB2X	2-5	25.4	10.4	12	M8 x 1

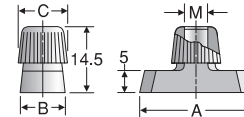

## APB

Weld Plate

THICKNESS	TUBE FITTING PART #	GROUP #	G (mm)	M (mm)
3	APB1X	1	37	M6 x 1
5	APB2X	2	55	M8 x 1
5	APB3X	3	70	M8 x 1
5	APB4X	4	85	M8 x 1
5	APB5X	5	110	M8 x 1

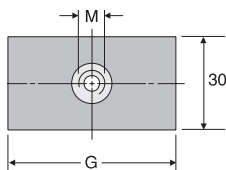

## DPB

Top Plate

TUBE FITTING PART #	GROUP #	B (mm)	D (mm)
DPB1X	1	34	6.6
DPB2X	2	51	8.6
DPB3X	3	64	8.6
DPB4X	4	78	8.6
DPB5X	5	102	8.6

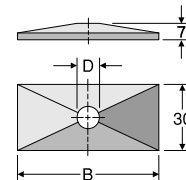

TABLE OF CONTENTS

VISUAL INDEX

FAQs

GEN TECH

TUBE CLAMPING HOW TO

O

## APRB

Weld Plate – Strip

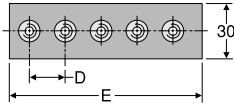

THICKNESS	TUBE FITTING PART #	GROUP #	D (mm)	E (mm)
3	APRB1X	1	40	196
5	APRB2X	2	58	288
5	APRB3X	3	72	358
5	APRB4X	4	90	446
5	APRB5X	5	112	558

## SBB

Locking Plate

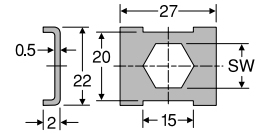

TUBE FITTING PART #	GROUP #	SW (mm)
SBB1X	1	11
SBB2X	2-5	12

## TS

Mounting Rail

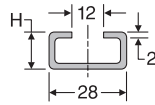

TUBE FITTING PART #	GROUP #	B (mm)	H (mm)	LENGTH (meter)
TS11A/B1X	ALL	28	11	1
TS14A/B1X	ALL	28	14	1
TS30A/B1X	ALL	28	30	1
TS11A/B2X	ALL	28	11	2
TS14A/B2X	ALL	28	14	2
TS30A/B2X	ALL	28	30	2

## US

Locking Washer

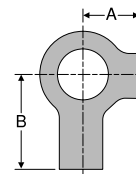

TUBE FITTING PART #	GROUP #	A (mm)	B (mm)
USA/USB1X	1	9	18
USB2X	2-5	11	20

**WARNING:** This product can expose you to chemicals including Lead and Lead Compounds which is known to the State of California to cause cancer and birth defects or other reproductive harm. For more information go to [www.p65warnings.ca.gov](http://www.p65warnings.ca.gov).

TABLE OF CONTENTS

VISUAL INDEX

FAQs

GEN TECH

TUBE CLAMPING HOW TO



# P METRIC TUBE





## Introduction

Parker offers three types of seamless metric tubes for hydraulic, pneumatic and instrumentation applications:

- Steel seamless cold drawn tube, phosphate and oil dipped for corrosion resistance
- Steel seamless cold drawn tube, zinc Chromium-6 free plating for corrosion resistance
- Stainless steel cold drawn tube

### Conformance and Material Specifications

#### Tests and Certificates

All tubes are subjected to a non-destructive leak test and marked accordingly. This marking is used in lieu of a works certificate DIN EN 10204-2.2. Test Class 1 DIN EN 10216-5 Table 7 applies for tubes made of 1.4571 material.

#### Materials and Mechanical Properties

Steel Types, mechanical properties and conditions are listed in Table P1.

Welding Suitability and Weldability:

- Steel tubes of St. 37.4, R Series, are weldable according to usual techniques.
- Not recommended to weld St. 37.4, R-CF series, Zinc Chromium-6 Free plated tubes.

Stainless steel tubes of 1.4571 are suitable for arc welding. The welding filler should be selected in accordance with DIN EN1600 and DIN EN12072 Part 1 taking into account the type of application and the welding technique.

## Assembly and Installation

Please refer to Section R for the assembly and installation instructions for Metric Tube fittings.

### Applications

#### Recommended Bend Radius

A bend radius of 3 times the tube O.D. or greater is recommended for cold bending of Parker tubes with hand, mechanical and power bending equipment.

#### \*Use of Tube Supports

The use of VH tube supports for EO and EO-2 fittings is required in certain thinner wall tubes to ensure proper assembly. Consult Fig. R45 & Fig. R46 on page R30.

#### Temperature Range

- Parker steel (St. 37.4) metric seamless tube can be used at the full rated working pressures without pressure rating reductions within the following temperature range: -40°C to +120°C. Maximum allowable operating temperature of +250°C.
- Parker stainless steel (1.4571) metric seamless tube can be used at full rated working pressures with-out pressure reductions within the following temperature ranges: -60°C to +20°C. Maximum allowable operating temperature of +400°C. Elevated temperature pressure reductions are as listed in Table P2.

#### As Delivered Conditions:

Standard Tube Lengths: 6 meters (approx. 20 ft)

Surface Finish:

- Steel (St. 37.4): Phosphated and oiled
  - I.D. dimensions 1.5 – 5 mm, outside and inside oiled
  - I.D. dimensions 6 mm and higher, outside and inside phosphated and oiled
- Steel (St. 37.4) R-CF Series: Zinc Chromium-6 Free

TABLE OF CONTENTS

FAQs

GEN TECH

P

Parker Series	Material	Tensile Strength	Yield Strength	% Elongation	Condition
R Series	Steel, fine grain E235N acc. to EN10305-4 (St. 37.4 acc. to DIN1630	340 N/mm <sup>2</sup> min. 49,000 PSI	235 N/mm <sup>2</sup> min. 34,000 PSI	25% min.	Seamless, cold drawn normal annealed, DIN EN 10305-1 and -4
R-71 Series	Stainless steel, 1.4571 X6CrNiMoTi17122	500 N/mm <sup>2</sup> min. 72,500 PSI	245 N/mm <sup>2</sup> min. 35,500 PSI	35% min.	Seamless, cold drawn free of scale, heat treated in accordance with DIN EN 10216-5 tab. 6

Table P1 — Parker Steel tubes mechanical properties and conditions

Temperature	Material	-60° up to +20° C	50° C	100° C	200° C	300° C	400° C
Pressure reductions in %	1.4571	—	5.5	11.5	21.5	29	34

Note: Interpolation is acceptable for intermediate temperature levels.

Table P2 — Parker stainless tube elevated temperature derating factors

# Seamless EO Steel Tubes Material E235N (St. 37.4)

Tolerances DIN EN 10305-4

TABLE OF CONTENTS

FAQs

GEN TECH

Order code		Tube O.D. (mm)	Tolerance	Wall thickness (mm)	Tube I.D. (mm)	Design pressure bar		Burst pressure bar	Weight kg/m
Phosphated and oiled	Cr(VI)-free					DIN 2413 I Static	DIN 2413 III Dynamic		
R04X0.5	R04X0.5CF	4		0.50	3.0	313	273	1160	0.047
R04X1	R04X0.75CF	4	±0.08	0.75	2.5	470	391	1820	0.063
	R04X1CF	4		1.00	2.0	627	500	2700	0.074
R06X1	R05X1CF	5	±0.08	1.00	3.0	501	416	2120	0.099
	R06X0.75CF	6		0.75	4.5	333	288	1150	0.103
	R06X1CF	6		1.00	4.0	444	372	1650	0.123
R06X1.5	R06X1.5CF	6	±0.08	1.50	3.0	666	526	2550	0.166
	R06X2CF	6		2.00	2.0	692	662	>3500	0.197
	R06X2.25CF	6		2.25	1.5	757	725	>3500	0.208
R08X1	R08X1CF	8		1.00	6.0	333	288	1175	0.173
R08X1.5	R08X1.5CF	8	±0.08	1.50	5.0	499	412	1925	0.240
	R08X2CF	8		2.00	4.0	666	526	2500	0.296
R08X2	R08X2.5CF	8		2.50	3.0	658	630	2650	0.339
	R10X1CF	10		1.00	8.0	282	248	900	0.222
R10X1.5	R10X1.5CF	10		1.50	7.0	423	357	1450	0.314
R10X2	R10X2CF	10	±0.08	2.00	6.0	564	458	2025	0.395
	R10X2.5CF	10		2.50	5.0	705	551	2675	0.462
	R10X3CF	10		3.00	4.0	666	638	>3500	0.518
R12X1	R12X1CF	12		1.00	10.0	235	209	750	0.271
R12X1.5	R12X1.5CF	12		1.50	9.0	353	303	1150	0.388
R12X2	R12X2CF	12	±0.08	2.00	8.0	470	391	1600	0.493
	R12X2.5CF	12		2.50	7.0	588	474	2025	0.586
	R12X3CF	12		3.00	6.0	705	551	2600	0.666
R12X2.5	R12X3.5CF	12		3.50	5.0	651	624	2600	0.734
	R14X1.5CF	14		1.50	11.0	302	264	975	0.462
	R14X2CF	14		2.00	10.0	403	342	1325	0.592
R14X2	R14X2.5CF	14	±0.08	2.50	9.0	504	415	1650	0.709
	R14X3CF	14		3.00	8.0	604	485	2200	0.814
R14X3	R14X3CF	14		3.50	7.0	705	551	2625	0.906
	R15X1CF	15		1.00	13.0	188	170	575	0.345
	R15X1.5CF	15		1.50	12.0	282	248	950	0.499
R15X2	R15X2CF	15	±0.08	2.00	11.0	376	321	1275	0.641
	R15X2CF	15		3.00	9.0	564	458	2000	0.888
	R16X1.5CF	16		1.50	13.0	264	233	850	0.536
R16X2	R16X2CF	16	±0.08	2.00	12.0	353	303	1175	0.691
R16X2.5	R16X2.5CF	16		2.50	11.0	441	370	1500	0.832
R16X3	R16X3CF	16		3.00	10.0	529	433	1850	0.962
R18X1	R18X1CF	18		1.00	16.0	157	143	450	0.419
R18X1.5	R18X1.5CF	18		1.50	15.0	235	209	700	0.610
R18X2	R18X2CF	18	±0.08	2.00	14.0	313	273	975	0.789
R18X2.5	R18X2.5CF	18		2.50	13.0	392	333	1300	0.956
	R18X3CF	18		3.00	12.0	470	391	1575	1.111

Table P3 — Seamless EO steel tubes

**Pressure Calculations:**

Calculation pressures given are according to DIN 2413 Part 1 for **static stress**

$$P = \frac{20 \cdot K \cdot s \cdot c}{S \cdot da} \text{ (bar)}$$

Material characteristic value K=235 N/mm<sup>2</sup>

and

DIN 2413 part III for **dynamic stress**

$$P = \frac{20 \cdot K \cdot s \cdot c}{S \cdot (da + s \cdot c)} \text{ (bar)}$$

Material characteristic value K=226 N/mm<sup>2</sup> (permanent fatigue strength)

Design correction value S=1.5 for static and dynamic stress.

Factor "c" for consideration of wall thickness **divergence for static and dynamic stress** =0.8 for tube o.d. 4 and 5; 0.85 for tube o.d. 6 and 8; 0.9 for larger tube o.d.

da = Tube O.D. in mm

s = Wall thickness in mm

**Standard Tube Length:**

- 6 m (19.7 ft.)

**Conversion Factors:**

- Bar x 14.5 = psig
- kg/m x 0.672 = lbs/ft
- N/mm<sup>2</sup> x 145 = lb/in<sup>2</sup>

See Remarks on page P5.

**WARNING:** This product can expose you to chemicals including Lead and Lead Compounds which is known to the State of California to cause cancer and birth defects or other reproductive harm. For more information go to [www.p65warnings.ca.gov](http://www.p65warnings.ca.gov).

# Seamless EO Steel Tubes Material E235N (St. 37.4) (continued)

Tolerances DIN EN 10305-4

TABLE OF CONTENTS

FAQs

GEN TECH

Order code		Tube O.D. (mm)	Tolerance	Wall thickness (mm)	Tube I.D. (mm)	Design pressure bar		Burst pressure bar	Weight kg/m
Phosphated and oiled	Cr(VI)-free					DIN 2413 I Static	DIN 2413 III Dynamic		
R20X2	R20X1.5CF	20	±0.08	1.50	17.0	212	190	675	0.684
	R20X2CF	20		2.00	16.0	282	248	900	0.888
R20X2.5	R20X2.5CF	20	±0.08	2.50	15.0	353	303	1100	1.079
R20X3	R20X3CF	20		3.00	14.0	423	357	1400	1.258
	R20X3.5CF	20	3.50	13.0	494	408	1650	1.424	
R22X1.5	R22X1.5CF	22	±0.08	1.50	19.0	192	173	550	0.758
	R22X2CF	22		2.00	18.0	256	227	775	0.986
R22X2.5	R22X2.5CF	22	±0.08	2.50	17.0	320	278	1025	1.202
R25X2	R22X3CF	22		3.00	16.0	385	328	1175	1.406
	R25X2CF	25	2.00	21.0	226	201	725	1.134	
R25X2.5	R25X2.5CF	25	±0.08	2.50	20.0	282	248	850	1.387
R25X3	R25X3CF	25		3.00	19.0	338	292	1025	1.628
	R25X4	R25X4CF	25	4.00	17.0	451	378	1500	2.072
R25X4.5	R25X4.5CF	25	±0.08	4.50	16.0	508	418	1625	2.275
R28X1.5	R28X1.5CF	28		1.50	25.0	151	138	425	0.980
	R28X2	R28X2CF	28	2.00	24.0	201	181	600	1.282
R28X2.5	R28X2.5CF	28	±0.08	2.50	23.0	252	223	750	1.572
R28X3	R28X3CF	28		3.00	22.0	302	264	900	1.850
	R30X2.5	R30X2CF	30	±0.08	2.00	26.0	188	170	575
R30X2.5CF		30	2.50		25.0	235	209	725	1.695
R30X3	R30X3CF	30	±0.08	3.00	24.0	282	248	850	1.998
R30X4	R30X4CF	30		4.00	22.0	376	321	1175	2.565
R30X5	R30X5CF	30	±0.15	5.00	20.0	470	391	1600	3.083
R35X2	R35X2CF	35		2.00	31.0	161	147	450	1.628
	R35X2.5	R35X2.5CF	35	2.50	30.0	201	181	600	2.004
R35X3	R35X3CF	35	±0.15	3.00	29.0	242	215	700	2.367
	R35X4CF	35		4.00	27.0	322	280	960	3.058
R38X3	R38X2.5CF	38	±0.15	2.50	33.0	186	168	550	2.189
	R38X3CF	38		3.00	32.0	223	199	675	2.589
R38X4	R38X4CF	38	±0.15	4.00	30.0	297	260	900	3.354
R38X5	R38X5CF	38		5.00	28.0	371	318	1150	4.069
	R42X2	R38X6CF	38	±0.2	6.00	26.0	445	373	1425
R42X2CF		42	2.00		38.0	134	123	375	1.973
R42X3	R42X3CF	42	±0.2	3.00	36.0	201	181	575	2.885
R42X4	R42X4CF	42		4.00	34.0	269	237	850	3.749
R50X6		50	±0.3	6.00	38.0	338	292		6.511
R65X8		65		8.00	49.0	347	299		11.246

Table P3 — Seamless EO steel tubes (cont'd.)

**Remarks:**

**Corrosion** — Additional allowances are not considered for the calculation of pressures

$$\frac{da \text{ (bar)}}{\text{dimax.}} > 2$$

are calculated for static stress in accordance with DIN 2413 Part III, but with K = 235 N/mm<sup>2</sup>

When a specific design factor is required, calculations should be based upon the burst pressures shown in the above tables.

**Temperature range:** -40°C up to 120°C without pressure reductions.

**Surface finish:**

Tubes with I.D. 1.5 to 5 mm: outside and inside oiled.

Tubes from 6 mm I.D. and above: outside and inside phosphated and oiled.

**For increased temperatures:**

control calculation according to DIN 2413 required (static application above 120°C).

$$P = \frac{20 \cdot K \cdot a \cdot c}{S \cdot (da + a \cdot c)} \text{ (bar)}$$

Material strength K for increased temperatures:

**WARNING:** This product can expose you to chemicals including Lead and Lead Compounds which is known to the State of California to cause cancer and birth defects or other reproductive harm. For more information go to [www.p65warnings.ca.gov](http://www.p65warnings.ca.gov).

Temperature in °C	K (Nmm <sup>2</sup> )
up to 200	185
up to 250	165

P



# Seamless EO Stainless Steel Tubes Material-No.: 1.4571

Tolerances EN 10305-1 / DIN 2391

TABLE  
OF  
CONTENTS

FAQs

GEN TECH

Order code	Tube O.D. (mm)	Tolerance	Wall thickness (mm)	Tube I.D. (mm)	1.4571 Design pressure bar DIN 2413 I Static	1.4571 burst pressure bar	Weight kg/m
R04X171	4	±0.08	1.0	2	735		0.075
R06X171	6	±0.08	1.0	4	490	1850	0.125
R06X1.571	6	±0.08	1.5	3	735	2900	0.169
R08X171	8	±0.08	1.0	6	368	1300	0.175
R08X1.571	8		1.5	5	551	2050	0.244
R10X171	10		1.0	8	294	950	0.225
R10X1.571	10	±0.08	1.5	7	441	1750	0.319
R10X271	10		2.0	6	588	2400	0.401
R12X171	12		1.0	10	245	850	0.275
R12X1.571	12	±0.08	1.5	9	368	1400	0.394
R12X271	12		2.0	8	490	1900	0.501
R14X1.571	14		1.5	11	315	1200	0.469
R14X271	14	±0.08	2.0	10	420	1550	0.601
R14X2.571	14		2.5	9	525	2100	0.720
R15X171	15		1.0	13	196	675	0.351
R15X1.571	15	±0.08	1.5	12	294	1100	0.507
R15X271	15		2.0	11	392	1400	0.651
R16X1.571	16	±0.08	1.5	13	276	950	0.545
R16X271	16		2.0	12	368	1300	0.701
R16X2.571	16	±0.08	2.5	11	459	1850	0.845
R16X371	16		3.0	10	551	2400	0.977
R18X1.571	18	±0.08	1.5	15	245	800	0.620
R18X271	18		2.0	14	327	1150	0.801
R20X271	20		2.0	16	294	1050	0.901
R20X2.571	20	±0.08	2.5	15	368	1400	1.095
R20X371	20		3.0	14	441	1800	1.277
R22X1.571	22	±0.08	1.5	19	200	650	0.770
R22X271	22		2.0	18	267	900	1.002
R25X2.571	25	±0.08	2.5	20	294	1050	1.408
R25X371	25		3.0	19	353	1275	1.653
R28X1.571	28	±0.08	1.5	25	158	550	0.995
R28X271	28		2.0	24	210	700	1.302
R30X2.571	30	±0.08	2.5	25	245	850	1.722
R30X371	30	±0.08	3.0	24	294	1150	2.028
R30X471	30		4.0	22	392	1500	2.605
R35X271	35	±0.15	2.0	31	168	550	1.653
R38X471	38	±0.15	4.0	30	309	1150	3.405
R42X271	42	±0.2	2.0	38	140	475	2.003
R42X371	42		3.0	36	210	750	2.930

Table P4 — Seamless EO stainless steel tubes

**Pressure Calculation:**

Pressure calculation given are according to DIN 2413 part I for **static stress**

$$P = \frac{20 \cdot K \cdot s \cdot c}{S \cdot da} \text{ (bar)}$$

Material characteristic value K=245 N/mm<sup>2</sup> (1.4571), K=245 N/mm<sup>2</sup> (1.4571) (1% proof stress)

Design factor S = 1.5

Factor "c" for consideration of wall thickness divergence: 0.9

da = Tube O.D. in mm

s = Wall thickness in mm

**Remarks:**

**Corrosion** — Additional allowances are not considered for the calculation of pressures.

Tubes with a diameter ratio da/di ≥ 1.35 are calculated according to DIN 2413 part III (formula see page P5) with above characteristic K value.

**Conversion Factors:**

- Bar x 14.5 = psig
- kg/m x 0.672 = lbs/ft
- N/mm<sup>2</sup> x 145 = lb/in<sup>2</sup>

**⚠ WARNING:** This product can expose you to chemicals including Lead and Lead Compounds which is known to the State of California to cause cancer and birth defects or other reproductive harm. For more information go to [www.p65warnings.ca.gov](http://www.p65warnings.ca.gov).













# Q EQUIPMENT



TABLE  
OF  
CONTENTS

<p><b>Benders</b></p> 	<p><b>Hand Tube Benders</b></p>  <p>Q4-Q5</p>	<p><b>Ratchet Hand Tube Bender</b></p>  <p>Q4</p>	<p><b>1" Hand Tube Bender</b></p>  <p>Q5</p>	<p><b>BAV06/12</b> Combined Tube Bending &amp; Cutting Tool</p>  <p>Q6</p>	<p><b>BV06/18, BV20/25</b> Tube Bending Tools</p>  <p>Q6</p>
<p><b>Bender Capacity Guides</b></p> <p>Q7</p>	<p><b>Exactol Benders</b> 412 &amp; 424</p>  <p>Q8-Q11</p>	<p><b>HB632</b> Hydraulic Bender</p>  <p>Q12-Q16</p>	<p><b>Mandrel Bending Components</b></p>  <p>Q16-Q18</p>	<p><b>CP432 Tube and Pipe Bender Kit</b></p>  <p>Q19</p>	
<p><b>Cutting &amp; Deburring Tools</b></p> 	<p><b>Kloskut</b> Medium (Sizes 2 to 18)</p>  <p>Q21</p>	<p><b>Kloskut</b> Large (Sizes 12 to 32)</p>  <p>Q21</p>	<p><b>Tru-Kut</b> Sawing Vise (Sizes 3-32)</p>  <p>Q21</p>	<p><b>Cut-Off Saw</b> 974250</p>  <p>Q21</p>	<p><b>In-Ex</b> Deburring Tool (Sizes 2-26)</p>  <p>Q22</p>
<p><b>Power Deburr Tool</b></p>  <p>Q22</p>	<p><b>FastSeal Tools</b></p> 	<p><b>FastSeal Mandrel</b></p>  <p>Q22</p>	<p><b>FastSeal Gauge</b></p>  <p>Q22</p>	<p><b>Flanging Tools</b></p> 	<p><b>Parflange 1025</b></p>  <p>Q23</p>
<p><b>Flanging Pin and Die Sets</b></p>  <p>Q23</p>	<p><b>Parflange ECO25</b></p>  <p>Q25</p>	<p><b>Parflange Pro 50</b></p>  <p>Q27</p>	<p><b>Flaring Tools</b></p> 	<p><b>Vise Block and Flaring Pin</b></p>  <p>Q31</p>	<p><b>Rolo-Flair</b> Rotary, Manual (Sizes 2 to 12)</p>  <p>Q32</p>
<p><b>Hydra-Tool</b> Hydraulic Flaring &amp; Pre-Setting Tool</p>  <p>Q33-Q35</p>	<p><b>Karryflare</b></p>  <p>Q36</p>	<p><b>Flaring Tooling for Parflange 1025</b></p>  <p>Q37</p>	<p><b>Flaring Tooling for Parflange ECO25</b></p>  <p>Q38</p>	<p><b>Porting Tools</b></p> 	<p><b>Straight Thread Port Tap</b> (Sizes 2 to 32)</p>  <p>Q39</p>
<p><b>SAE Straight Thread Port Counterbore</b> (Sizes 2 to 32)</p>  <p>Q39</p>	<p><b>BSPP Counterbores</b></p>  <p>Q40</p>	<p><b>BSPP/BSPT Taps</b></p>  <p>Q40</p>	<p><b>NPTF Taps</b></p>  <p>Q41</p>	<p><b>ISO 6149-1</b> Port Tap</p>  <p>Q41</p>	<p><b>ISO 6149-1</b> Port Counterbore</p>  <p>Q42</p>
<p><b>ISO 6149-1</b> Port Counterbore with ID Groove</p>  <p>Q42</p>	<p><b>Pre-Setting Tools</b></p> 	<p><b>Ferulset Ferrule Pre-Setter</b> (Sizes 2 to 32)</p>  <p>Q43</p>	<p><b>VOMO</b> Pre-Assembly Bodies</p>  <p>Q44</p>	<p><b>Hyferset Ferrule Pre-Setter</b> (Sizes 4 to 32)</p>  <p>Q45</p>	<p><b>Hydra-Tool</b></p>  <p>Q48</p>

TABLE  
 OF  
 CONTENTS

<p><b>Pre-Setting Tooling for Hydra-Tool</b></p>  <p>Q48-Q49</p>	<p><b>EO-Karrymat</b></p>  <p>Q50</p>	<p><b>O-Ring Assembly Tools</b></p>	<p><b>O-Ring Pick</b></p>  <p>Q52</p>	<p><b>Captive O-Ring Installation Tool</b></p>  <p>Q52</p>	<p><b>Brazing Flux and Cleaner</b></p>
<p><b>Braze Flux</b></p>  <p>Q53</p>	<p><b>Post Braze Cleaner</b></p>  <p>Q53</p>	<p><b>Sealants, Lubricants, &amp; Cleaners</b></p>	<p><b>LB 2000 &amp; MPG-2</b></p>  <p>Q54</p>	<p><b>EO Lubricants</b></p>  <p>Q54</p>	<p><b>O-Lube</b></p>  <p>Q54</p>
<p><b>Super O-Lube</b></p>  <p>Q54</p>	<p><b>Threadmate</b></p>  <p>Q55</p>	<p><b>Tube Preparation Centers</b></p>	<p><b>Modular Preparation Centers</b></p>  <p>Q56</p>	<p><b>Thread Identification</b></p>	<p><b>Thread Identification Kit</b></p>  <p>Q57</p>
<p><b>Portboards</b></p>  <p>Q57</p>	<p><b>ITK International Thread Kit</b></p>  <p>Q57</p>	<p><b>Wrenches</b></p>	<p><b>Par-Lok Wrenches</b></p>  <p>Q58- Q59</p>	<p><b>Weights</b></p>	<p><b>Tube Fabricating Equipment Weight Chart</b></p> <p>Q60-Q61</p>



## Hand Tube Benders – Inch

These are sturdy, easy-to-use hand tools for fast and accurate bending without kinks or visible flattening. Twelve individual sizes from -2 (1/8" O.D.) to -16 (1" O.D.) are available.

### Medium Duty Inch Hand Tube Benders

*Designed and built for fast, accurate bends and long service life.*

These are individual benders for eight inch tube sizes (1/8", 3/16", 1/4", 5/16", 3/8", 1/2" 5/8", 3/4"). All of these benders will bend copper, aluminum, annealed steel and stainless steel. These can be used in hands or mounted in a bench vise.

**HOW TO USE:** Simply align marks of the pressure arm and radius block, then bend to the desired angle (up to 180°) by pulling steadily on the slide block handle. Bend angles are indicated on the radius block, both front and back. (Detailed instructions are included with each bender.) See the table below for technical data and part numbers.

Size	Tube O.D. (in.)	Radius to Tube Centerline (in.)	Min. Wall Without Flattening (in.)	Recommended Max. Wall Thickness		Part No.
				Copper, Aluminum (in.)	Steel, Stainless Steel (in.)	
3	3/16	5/8	0.020	Any	0.032.....	<b>3-2829</b>
4	1/4	5/8	0.028	Any	0.083.....	<b>4-2829</b>
5	5/16	15/16	0.032	Any	0.083.....	<b>5-2829</b>
6	3/8	15/16	0.032	Any	0.083.....	<b>6-2829</b>
8	1/2	1 1/2	0.042	Any	0.083.....	<b>8-2829</b>

### Ratchet Hand Tube Benders

These are individual benders for three tube sizes, 5/8", 3/4" and 7/8", in copper, aluminum, annealed steel and stainless steel. They can be used in hands or mounted in a bench vise.

**HOW TO USE:** Position the tube in the bender, close the latch and pull the ratchet handle away from radius block handle until the desired angle (up to 180°) is formed. Bend angles are indicated on the radius block. (Detailed instructions are included with each bender.) See the table below for technical data and part numbers.

Size	Tube O.D. (in.)	Radius to Tube Centerline (in.)	Min. Wall Without Flattening (in.)	Recommended Max. Wall Thickness		Part No.
				Copper, Aluminum (in.)	Steel, Stainless Steel (in.)	
10	5/8	3	0.042	Any	0.049.....	<b>10-2829</b>
12	3/4	3 3/4	0.049	Any	0.065.....	<b>12-2829</b>
14	7/8	3 3/4	0.049	Any	0.065.....	<b>14-2829</b>

TABLE OF CONTENTS

VISUAL INDEX

FAQs

TOOL SPEC.COM



Fig. Q1 — Medium Duty Inch Hand Tube Bender

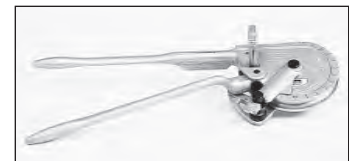

Fig. Q2 — Ratchet Hand Tube Bender



[Click here for Support Resources or to Configure Parts Online](#)

## 1" Hand Tube Bender

Part No. 16-2829

For 1" O.D. tube in soft copper and aluminum materials. This bender can be used in hands, but mounting in a bench vise is suggested, especially for heavier wall thickness tube.

**HOW TO USE:** Align marks and bend the tube to the desired angle (up to 180°) by pulling steadily on the operating handle. The handle may be re-positioned for maximum leverage. Bend angles are indicated on the radius block. (Detailed instructions are included with the bender.) See the table below for technical data and part numbers.

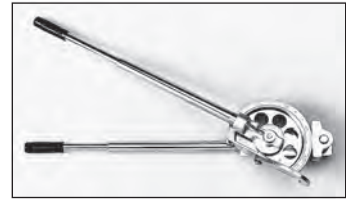

Fig. Q3 — 1" Hand Tube Bender

Size	Tube O.D. (in.)	Radius to Tube Centerline (in.)	Min. Wall Without Flattening (in.)	Recommended Max. Wall Thickness		Part No.
				Copper, Aluminum (in.)	Steel, Stainless Steel (in.)	
16	1	3 1/2	0.065	Any	Not Recommended	16-2829

**WARNING:** This product can expose you to chemicals including Lead and Lead Compounds which is known to the State of California to cause cancer and birth defects or other reproductive harm. For more information go to [www.p65warnings.ca.gov](http://www.p65warnings.ca.gov).

## Hand Tube Benders – Metric

These are sturdy, easy-to-use hand tools for fast and accurate bending without kinks or visible flattening. Individual sizes in ten models from size 5mm to 25mm are available.

### Medium Duty Metric Hand Tube Benders

*Designed and built for fast, accurate bends and long service life.*

These are individual benders for six metric tube sizes (5mm, 6mm, 8mm, 10mm, 12mm and 14mm). All of these benders will bend copper, aluminum, annealed steel and stainless steel. These can be used in hands or mounted in a bench vise.

**HOW TO USE:** Simply align the marks on the slide block and radius block, then bend to the desired angle (up to 180°) by pulling steadily on the slide block handle. Bend angles are indicated on the radius block, both front and back. (Detailed instructions are included with each bender.) See the table below for technical data and part numbers.



Fig. Q4 — Medium Duty Metric Hand Tube Bender

Tube O.D. (mm)	Radius to Tube Centerline (mm)	Min. Tube Wall Thickness (mm)	Recommended Max. Wall Thickness		Part No.
			Copper, Aluminum (mm)	Steel, Stainless Steel (mm)	
6	16	1.0	Any	1.5.....	2829-6mm
8	24	1.0	Any	1.5.....	2829-8mm
10	24	1.0	Any	2.0.....	2829-10mm
12	38	1.0	Any	2.0.....	2829-12mm

- TABLE OF CONTENTS
- VISUAL INDEX
- FAQs
- TOOL SPEC.COM



## Bench Mount Metric Hand Bender and Cutting Guide

This bender combines a tube cutting guide with the bender for sizes 6mm, 8mm, 10mm, and 12mm. There are three bender rollers that cover all sizes. The bender mounts easily to a work bench or table.

**Part Description**  
Bench Mount Tube Bender (6mm, 8mm, 10mm, 12mm)..... **Part No. BAV06/12KPLX**



Fig. Q5 — BAV06/12KPLX

## Vise Mount Metric Hand Benders

### Vise Mount Metric Bender – 6/18mm

This bender has six interchangeable rollers to cover tube sizes 6mm, 8mm, 10mm, 12mm, 14mm, 15mm, 16mm, and 18mm.

**Part Description**  
Vise Mount Tube Bender  
(6mm, 8mm, 10mm, 12mm, 14mm, 15mm, 16mm, 18mm) ..... **Part No. BV06/18KPLX**



Fig. Q6 — BV06/18KPLX

Tube O.D. (mm)	Bend Radius (mm)	Max. Wall Thickness (mm)
6	33	2.5
8	34	2.5
10	36	2.5
12	37	2.5
14	37	2.0
15	44	2.0
16	44	2.0
18	52	2.0

### Vise Mount Metric Bender – 20/25mm

This bender has three interchangeable rollers to cover tube sizes 20mm, 22mm, and 25mm. All bend radii are 86.5mm. Pressure arm is not included with the BV20/25KPLX, however it can be manufactured on site with a piece of tube, or it can be ordered separately with part number BV20/2510X. Maximum wall thickness for all sizes is 2.0mm.

**Part Description**  
Vise Mount Tube Bender (20mm, 22mm, 25mm)..... **Part No. BV20/25KPLX**  
Pressure Arm ..... **BV20/2510X**



Fig. Q7 — BV20/25KPLX

**WARNING:** This product can expose you to chemicals including Lead and Lead Compounds which is known to the State of California to cause cancer and birth defects or other reproductive harm. For more information go to [www.p65warnings.ca.gov](http://www.p65warnings.ca.gov).

TABLE OF CONTENTS

VISUAL INDEX

FAQs

TOOL SPEC.COM

[Click here for Support Resources or to Configure Parts Online](#)

# Hand Crank & Hydraulic Tube Bender Capacity Guides

All benders listed in Tables Q1 through Q3 are capable of bending 1/2" O.D. and under fully annealed steel and stainless steel tube with no limit on wall thickness. For HARD copper and HIGH STRENGTH aluminum, use the wall thickness shown for stainless steel. Observe that VERY HARD materials may not be ductile enough to bend without fracture.

TABLE  
OF  
CONTENTS

VISUAL  
INDEX

FAQs

TOOL  
SPEC.COM

## Inch Tube Sizes

Tube O.D.	Material	Tube Wall Thickness (in.)											
		0.035	0.049	0.058	0.065	0.072	0.083	0.095	0.109	0.120	0.134	0.156	0.188
3/4"	S	ABCD	ABCD	ABCD	ABCD	BCD	BCD	BCD	BCD	BCD	BCD	BCD	BCD
	SS	ABCD	ABCD	BCD	BCD	BCD	BCD	BCD	BCD	BCD	BCD	BCD	BCD
1"	S	BCD	BCD	BCD	BCD	BCD	BCD	BCD	BCD	BCD	BCD	BCD	BCD
	SS	BCD	BCD	BCD	BCD	BCD	BCD	BCD	BCD	BCD	BCD	BCD	BCD
1 1/4"	S	BCD	BCD	BCD	BCD	BCD	BCD	CD	CD	CD	CD	CD	CD
	SS	BCD	BCD	BCD	BCD	BCD	CD	CD	CD	CD	CD	C	C
1 1/2"	S	BCD	BCD	BCD	BCD	BCD	CD	CD	CD	CD	CD	CD	CD
	SS	BCD	BCD	CD	CD	CD	CD	CD	CD	CD	CD	C	C
2"	S	CD	CD	CD	CD	CD	CD	CD	CD	CD	CD	CD	CD
	SS	CD	CD	CD	CD	CD	CD	CD	CD	CD	CD	—	—

Table Q1 — Hand Crank and Hydraulic Tube Benders Maximum Capacity Guide – Inch Sizes

## Inch Pipe Sizes

Pipe Size	Material	Inch Pipe Schedule (IPS)	
		40	80
1/2"	S	CD	CD
	SS	CD	CD
3/4"	S	CD	CD
	SS	CD	CD
1"	S	CD	CD
	SS	CD	CD
1 1/4"	S	CD	CD
	SS	CD	CD
1 1/2"	S	CD	CD
	SS	CD	CD
2"	S	D	D
	SS	D	—

Table Q2 — Hand Crank and Hydraulic Benders Maximum Capacity Guide – Inch Pipe Sizes

## Metric Tube Sizes

Tube O.D. (mm)	Material	Tube Wall Thickness (mm)						
		1.5	2	2.5	3	3.5	4	5
18	S	ABCD	ABCD	ABCD	ABCD	BCD	BCD	CD
	SS	BCD	BCD	BCD	BCD	BCD	BCD	CD
20	S	ABCD	ABCD	ABCD	BCD	BCD	BCD	CD
	SS	BCD	BCD	BCD	BCD	BCD	BCD	CD
22	S	BCD	BCD	BCD	BCD	BCD	BCD	CD
	SS	BCD	BCD	BCD	BCD	BCD	CD	CD
25	S	BCD	BCD	BCD	BCD	BCD	CD	CD
	SS	BCD	BCD	BCD	BCD	CD	CD	CD
28	S	BCD	BCD	BCD	BCD	CD	CD	CD
	SS	BCD	BCD	CD	CD	CD	CD	CD
30	S	BCD	BCD	BCD	BCD	CD	CD	CD
	SS	BCD	BCD	CD	CD	CD	CD	CD
32	S	BCD	BCD	CD	CD	CD	CD	CD
	SS	BCD	BCD	CD	CD	CD	CD	CD
35	S	BCD	CD	CD	CD	CD	CD	CD
	SS	BCD	CD	CD	CD	CD	CD	CD
38	S	BCD	CD	CD	CD	CD	CD	CD
	SS	CD	CD	CD	CD	CD	CD	CD
42	S	CD	CD	CD	CD	CD	CD	CD
	SS	CD	CD	CD	CD	CD	CD	—
50	S	CD	CD	CD	CD	CD	CD	—
	SS	CD	CD	CD	CD	CD	—	—

Table Q3 — Hand Crank and Hydraulic Tube Benders Maximum Capacity Guide – Metric Tube Sizes

**\*Codes:**

- (A) Model 412 — Tube (1/4" thru 3/4" and 6mm thru 20mm) — Worm & Gear
- (B) Model 424 — Tube (1/4" thru 1 1/2" and 6mm thru 38mm) — Worm & Gear
- (C) Model HB632 — Tube (3/8" thru 2" and 10mm thru 50mm) — Hydraulic
- (D) Model CP432 — Tube (1/4" thru 2") — Hydraulic

**WARNING:** This product can expose you to chemicals including Lead and Lead Compounds which is known to the State of California to cause cancer and birth defects or other reproductive harm. For more information go to [www.p65warnings.ca.gov](http://www.p65warnings.ca.gov).

Q

## Exactol® Crank-Operated Benders

Models 412/424

These portable benders are vise or bench mountable for easy action and fast accurate bending to 180°. Two models are available to bend tube sizes 4 (1/4") through 24 (1 1/2"). Exactol benders are designed with a worm-gear drive with a 60 to 1 gear ratio to allow accurate bending with minimum effort. They bend aluminum, copper, annealed steel and annealed stainless steel without kinks or wrinkles. Easy crank operation permits continuous production without excessive operator fatigue; for use in tube fabrication shops, in the field, or in factory maintenance departments.

**Instructional video is available at [discover.parker.com/TFDTubeFabEquipment](http://discover.parker.com/TFDTubeFabEquipment).**



**See the 400 Series Bender manual, 4391-B400S.**



Fig. Q8 — 412 Bender

TABLE  
OF  
CONTENTS

VISUAL  
INDEX

FAQs

TOOL  
SPEC.COM

## Exactol® Model 412

The Exactol Model 412 will bend tube from size 4 (1/4") through size 12 (3/4") and 6mm through 20mm inclusive and is completely portable. Accessories include a sturdy metal carrying case, which accommodates the 412 bender, slide block, and selected radius blocks. See page Q7 for wall thickness capabilities. May be held in a vise or bench mounted using the bench mounting adapter. Bulletin 4391-B400S is included with the bender, which describes the operation in detail.

**NOTE:** The 412 must be bench mounted if mandrels are used.

### COMPONENTS REQUIRED

The minimum components required are a Model 412 Bender with a slide block and a radius block which match the tube O.D. to be bent.

Part Name	Part No.
Exactol Model 412 Bender (for 1/4" through 3/4" O.D.).....	<b>560569</b>
Slide Block (for sizes 4-5-6-8-10-12) .....	<b>550585</b>
Slide Block (for sizes 6mm-8mm-12mm-12mm-14mm) .....	<b>820091</b>
Slide Block (for sizes 15mm-16mm-18mm-20mm).....	<b>820092</b>
Radius Blocks (for sizes 4-5-6-8-10-12 and 6mm thru 38mm) ...	See pages Q10 – Q11

### OPTIONAL ACCESSORIES

Carrying Case (for bender, slide block and selected radius blocks) .....	<b>550572</b>
Bench Mounting Adapter .....	<b>550570</b>

### Mandrel Bending Components

for 412 and 424 Benders ..... See pages Q16 – Q18



Fig. Q9 — Slide Block

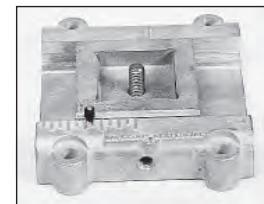

Fig. Q10 — Bench Mount Adapter

**WARNING:** This product can expose you to chemicals including Lead and Lead Compounds which is known to the State of California to cause cancer and birth defects or other reproductive harm. For more information go to [www.p65warnings.ca.gov](http://www.p65warnings.ca.gov).

**"Need help determining the correct tooling for your bending job? Use [TFDtoolspec.com](http://TFDtoolspec.com)"**

[Click here for Support Resources or to Configure Parts Online](#)

## Exactol® Model 412 Kit

This 412 kit contains all the basic tool requirements for bending tube from 1/4" through 3/4".

**Part No.**  
**412 KIT**

The following part numbers are included in the kit:

<b>Part Name</b>	<b>Part No.</b>
Exactol Model 412 Bender .....	<b>560569</b>
Carrying Case .....	<b>550572</b>
Slide Block for 1/4" through 3/4" tube .....	<b>550585</b>
Radius Block – 1/4" O.D. tube .....	<b>550579</b>
Radius Block – 3/8" O.D. tube.....	<b>550581</b>
Radius Block – 1/2" O.D. tube.....	<b>550582</b>
Radius Block – 5/8" O.D. tube.....	<b>550583</b>
Radius Block – 3/4" O.D. tube.....	<b>550584</b>

**⚠ WARNING:** This product can expose you to chemicals including Lead and Lead Compounds which is known to the State of California to cause cancer and birth defects or other reproductive harm. For more information go to [www.p65warnings.ca.gov](http://www.p65warnings.ca.gov).

## Exactol® Model 424

The Exactol Model 424 will bend tube from size 4 (1/4" O.D.) through size 24 (1 1/2" O.D.) and 6mm through 38mm inclusive. See page Q7 for wall thickness capabilities. It is completely portable and may be vise or bench mounted. Bulletin 4391-B400S is included with the bender, which describes the operation in detail.

**NOTE:** The 424 must be bench mounted if mandrels are used.

**▶** *Instructional video is available at [discover.parker.com/TFDTubeFabEquipment](http://discover.parker.com/TFDTubeFabEquipment).*

*See the 400 Series Bender manual, 4391-B400S.*

### COMPONENTS REQUIRED

The minimum components required are a Model 424 Bender with a slide block and a radius block that match the tube O.D. to be bent.

<b>Part Name</b>	<b>Part No.</b>
Exactol Model 424 bender (for 1/4" through 1 1/2" O.D.).....	<b>621044</b>
Slide Block (for sizes 4-5-6-8-10-12) .....	<b>550585</b>
Slide Block (for sizes 14-16-18-20).....	<b>621045</b>
Slide Block (for size 24).....	<b>870150</b>
Slide Block (for sizes 6mm-8mm-10mm-12mm-14mm) .....	<b>820091</b>
Slide Block (for sizes 15mm-16mm-18mm-20mm).....	<b>820092</b>
Slide Block (for sizes 22mm-25mm-28mm-30mm).....	<b>820093</b>
Slide Block (for size 35mm) .....	<b>820094</b>
Slide Block (for size 38mm) .....	<b>870150</b>
Radius Blocks (for sizes -4 thru -24 and 6mm thru 38mm) .....	See pages Q10 – Q11

### OPTIONAL ACCESSORIES

Bench Mounting Adapter .....	<b>631156</b>
Mandrel Bending Components for 412 and 424 Benders .....	See pages Q16 – Q18

**⚠ WARNING:** This product can expose you to chemicals including Lead and Lead Compounds which is known to the State of California to cause cancer and birth defects or other reproductive harm. For more information go to [www.p65warnings.ca.gov](http://www.p65warnings.ca.gov).

*"Need help determining the correct tooling for your bending job? Use [TFDtoolspec.com](http://TFDtoolspec.com)"*



Fig. Q11 — 412 Kit



Fig. Q12 — 424 Bender



Fig. Q13 — Slide Block

TABLE  
OF  
CONTENTS

VISUAL  
INDEX

FAQs

TOOL  
SPEC.COM

Q



[Click here for Support Resources or to Configure Parts Online](#)

## Exactol® Model 424 Kit

Part No. 424 Kit

This 424 Kit contains all the basic tool requirements for bending tube from 1/4" through 1 1/2". The following part numbers are included in the kit:

Part Name	Part No.
Exactol Model 424 bender (for 1/4" through 1 1/2" O.D.)	621044
Slide Block (for sizes 4-5-6-8-10-12)	550585
Slide Block (for sizes 14-16-18-20)	621045
Slide Block (for size 24)*	870150
Radius Blocks – 1/4" O.D. Tube*	550579
Radius Block – 3/8" O.D. Tube	550581
Radius Block – 1/2" O.D. Tube	550582
Radius Block – 5/8" O.D. Tube	550583
Radius Block – 3/4" O.D. Tube	550584
Radius Block – 1" O.D. Tube	621047
Radius Block – 1 1/4" O.D. Tube	621049
Radius Block – 1 1/2" O.D. Tube*	870149

\* Items not shown in the photo, but which are included in the 424 Kit.

**WARNING:** This product can expose you to chemicals including Lead and Lead Compounds which is known to the State of California to cause cancer and birth defects or other reproductive harm. For more information go to [www.p65warnings.ca.gov](http://www.p65warnings.ca.gov).

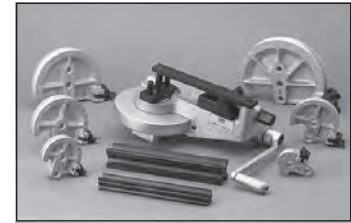

Fig. Q14 — 424 Kit

TABLE  
OF  
CONTENTS

VISUAL  
INDEX

FAQs

TOOL  
SPEC.COM

## Radius Blocks

For use with Exactol Models 412/424 benders.

The 412 and 424 bender radius blocks have built in tube clamps, therefore separate clamp blocks are not required. The radius blocks are interchangeable within bender size ranges. Close bend radius blocks utilize the small bend radii, but also allow the bend to begin closer to the end connection.

### 412 and 424 Bender – Small Bend Radius Blocks

Size	Tube O.D. (in.)	Bend Radius (in.)	Part No.
4	1/4	9/16	550573
5	5/16	11/16	550574
6	3/8	15/16	550575
8	1/2	1 1/4	550576
10	5/8	1 1/2	550577
12	3/4	1 3/4	550578



Fig. Q15 — Small Bend Radius Block

### 412 and 424 Bender – Large Bend Radius Blocks

Size	Tube O.D. (in.)	Bend Radius (in.)	Part No.
4	1/4	3/4	550579
5	5/16	1	550580
6	3/8	1 1/4	550581
8	1/2	2	550582
10	5/8	2 1/2	550583
12	3/4	3	550584
14	7/8	3 1/2	621046
16	1	4	621047
18	1 1/8	4 1/2	621048
20	1 1/4	5	621049
24	1 1/2	5	870149



Fig. Q16 — Large Bend Radius Block

**WARNING:** This product can expose you to chemicals including Lead and Lead Compounds which is known to the State of California to cause cancer and birth defects or other reproductive harm. For more information go to [www.p65warnings.ca.gov](http://www.p65warnings.ca.gov).

**"Need help determining the correct tooling for your bending job? Use [TFDtoolspec.com](http://TFDtoolspec.com)"**

[Click here for Support Resources or to Configure Parts Online](#)

## 412 and 424 Bender – Close Bend Radius Blocks

These adapters are used when bends are needed close to the end of the tube after the flare has been made, ferrule has been pre-set, or flange has been made. For flared or Ferulok fittings, attach tube end by threading tube nut onto the radius block threaded pin. To use this block with Seal-Lok fittings, Close Bend Adapters for Seal-Lok must be used to attach the tube to the radius block.

Size	Tube O.D. (in.)	Bend Radius (in.)	Part No.
8	1/2	1 1/4.....	590533
10	5/8	1 1/2.....	590535
12	3/4	1 3/4.....	590537

## Close Bend Adapters for Seal-Lok

These adapters are used when bends are needed close to the end of the tube after the flange has been made or the sleeve has been brazed onto the end of the tube.

**HOW TO USE:** Screw the Seal-Lok adapter into the internal thread\* of the threaded pin on the radius block. Then attach the flanged or brazed tube by threading the tube nut to the Seal-Lok adapter on the radius block threaded pin.

\* If the threaded pin does not have an internal thread, a new threaded pin is required.

Tube O.D. (in.)	Description	Part No.
1/2	Seal-Lok Adapter.....	930421-8
5/8	Seal-Lok Adapter.....	930421-10
3/4	Seal-Lok Adapter.....	930421-12
1/2	Threaded Pin (for Close Bend Radius Blocks) ..	930420-8
5/8	Threaded Pin (for Close Bend Radius Blocks) ..	930420-10
3/4	Threaded Pin (for Close Bend Radius Blocks) ..	930420-12

## 412 and 424 Bender – Metric Radius Blocks

Tube O.D. (mm)	Bend Radius (mm)	Part No.
6	14.....	820090-6mm
8	18.....	820090-8mm
10	24.....	820090-10mm
12	32.....	820090-12mm
14	38.....	820090-14mm
15	38.....	820090-15mm
16	38.....	820090-16mm
18	44.....	820090-18mm
20	44.....	820090-20mm
22	89.....	820090-22mm
25	102.....	820090-25mm
28	102.....	820090-28mm
30	127.....	820090-30mm
32	127.....	820090-32mm
35	127.....	820090-35mm
38	127.....	870149 (same as 1-1/2" Radius Block)

**WARNING:** This product can expose you to chemicals including Lead and Lead Compounds which is known to the State of California to cause cancer and birth defects or other reproductive harm. For more information go to [www.p65warnings.ca.gov](http://www.p65warnings.ca.gov).



Fig. Q17 — Close Bend Radius Block



Fig. Q18 — Seal-Lok Close Bend Adapter



Fig. Q19 — Radius Block

TABLE OF CONTENTS

VISUAL INDEX

FAQs

TOOL SPEC.COM

Q

*"Need help determining the correct tooling for your bending job? Use [TFDtoolspec.com](http://TFDtoolspec.com)"*

# Hydraulic Tube Bender

## Model HB632

Hydraulic power does the work in bending tube of all materials in sizes from 6 (3/8" O.D.) through size 32 (2" O.D.), 10mm through 50mm, with wall thicknesses as great as .188 for annealed steel, and pipe sizes from 3/8" through 1-1/2". See page Q7 for wall thickness capabilities. The radius block, around which the tube is bent, is driven by a roller chain and sprocket powered by a cylinder and a separate hydraulic power unit.

Maximum bend angle is 180° with radii from 1 1/4" to 8". Close second bends can be performed in either direction. An adjustable stop controls the degree of bend to a maximum of 180° and is graduated in 1° increments. After the bend is completed and pressure is released, a spring returns the clamp arm to the zero starting position.

The clamp vise arm features a quick release speed screw for positioning the required clamp block. Each size of tube requires the proper sized radius block, clamp block and slide block.

 **Instructional video is available at [discover.parker.com/TFDTubeFabEquipment](http://discover.parker.com/TFDTubeFabEquipment).**

See the **HB632 Tube Bender manual, 4391-B26**.

HB632 radius blocks, slide blocks and clamp blocks will work with the following benders as well: 624, 824, 832 and 848.

**NOTE:** For size 28 (1 3/4" O.D. tube) through 32 (2" O.D. tube) radius blocks, an adapter plate is required.

**DIMENSIONS:** L – 40" W – 11" H – 12"

### COMPONENTS REQUIRED

Minimum components required are a Model HB632 Bender, hose assembly, hydraulic pump and a radius, slide and clamp block which match the tube/pipe O.D. to be bent.

Part Name	Part No.
Hydraulic Bender Model HB632 (without pump) .....	<b>631050</b>
Hydraulic Pump (10,000 psi, 110V AC) .....	<b>900085</b>
High Flow Hydraulic Pump (10,000 psi, 110V) .....	<b>974691</b>
Hose Assembly (3' long) .....	<b>910004</b>

**One each of the following is required per tube O.D.:**  
**Radius Block, Clamp Block, Slide Block.**

Radius Block..... See pages Q13 – Q15

### INCH TUBE SIZES

Clamp Block (for -6) .....	<b>864266</b>
Clamp Block (for -8, -12, -16, -24) .....	<b>631092</b>
Clamp Block (for -10, -14, -18, -20) .....	<b>631093</b>
Clamp Block (for -28) .....	<b>027418-28</b>
Clamp Block (for -32) .....	<b>027418-32</b>
Slide Block (for -6) .....	<b>864276</b>
Slide Block (for -8, -12, -16, -24) .....	<b>520516</b>
Slide Block (for -10, -14, -18, -20) .....	<b>520518</b>
Slide Block (for -28) .....	<b>631063</b>
Slide Block (for -32) .....	<b>631066</b>

 **WARNING:** This product can expose you to chemicals including Lead and Lead Compounds which is known to the State of California to cause cancer and birth defects or other reproductive harm. For more information go to [www.p65warnings.ca.gov](http://www.p65warnings.ca.gov).

**"Need help determining the correct tooling for your bending job? Use [TFDtoolspec.com](http://TFDtoolspec.com)"**

TABLE  
OF  
CONTENTS

VISUAL  
INDEX

FAQs

TOOL  
SPEC.COM

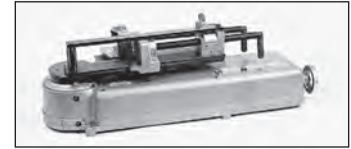

Fig. Q20 — HB632



Fig. Q21 — 900085 Pump



Fig. Q22 — High Flow Pump



Fig. Q23 — Clamp Block



Fig. Q24 — Slide Block

[Click here for Support Resources or to Configure Parts Online](#)

TABLE  
OF  
CONTENTS

VISUAL  
INDEX

FAQs

TOOL  
SPEC.COM

METRIC TUBE SIZES	Part No.
Clamp Block (for 10mm, 12mm, 14mm, 16mm) .....	790017
Clamp Block (for 15mm, 16mm, 18mm, 20mm) .....	780195
Clamp Block (for 22mm, 25mm, 30mm, 32mm) .....	780196
Clamp Block (for 35mm) .....	974346
Clamp Block (for 38mm) .....	631092
Clamp Block (for 42mm) .....	974349
Clamp Block (for 50mm) .....	974352
Slide Block (for 10mm, 12mm, 14mm, 16mm) .....	790016
Slide Block (for 15mm, 16mm, 18mm, 20mm) .....	780192
Slide Block (for 22mm, 25mm, 30mm, 32mm) .....	780193
Slide Block (for 35mm) .....	820094
Slide Block (for 38mm) .....	520516
Slide Block (for 42mm) .....	974348
Slide Block (for 50mm) .....	974351

INCH PIPE SIZES	Part No.
Clamp Block (for 3/8", 1/2", 3/4") .....	974332
Clamp Block (for 1") .....	974338
Clamp Block (for 1 1/4") .....	974341
Clamp Block (for 1 1/2") .....	974343
Slide Block (for 3/8", 1/2", 3/4") .....	974331
Slide Block (for 1") .....	974336
Slide Block (for 1 1/4") .....	974340
Slide Block (for 1 1/2") .....	974342

**OPTIONAL ACCESSORIES**

Radius Block Adapter Plate (for sizes 1 3/4", 42mm, 1 1/2 IPS and larger) .....	660221
Mandrel Bending Components for HB632 .....	See pages Q16 – Q18

**Radius Blocks**

For use with HB632 Bender

Radius blocks for every standard tube size from size 6 (3/8" O.D.) to size 32 (2" O.D.), 10mm through 50mm, and inch pipe sizes 3/8" through 1-1/2" are available.

**Standard Radius Blocks – Inch Sizes**

Size	Tube O.D. (in.)	Radius (in.)	Part No.
6	3/8	1 1/8	590512-18
6	3/8	1 1/4	540502
8	1/2	1 1/4	530763
8	1/2	1 1/2	590515-24
10	5/8	1 1/2	530764
10	5/8	1 7/8	590518-30
12	3/4	1 3/4	530765
12	3/4	2 1/4	590521-36
14	7/8	2	530766
14	7/8	2 5/8	590523-42
16	1	3	590524-48
18	1 1/8	3 3/8	590526-54
18	1 1/8	3 1/2	530768
20	1 1/4	3 3/4	590527-60
24	1 1/2	4 1/2	590530-72
24	1 1/2	5	530770
28	1 3/4	7	631057-112*
32	2	8	631060-128*

\* Requires the use of Radius Block Adapter Plate, Part No. 660221.



Fig. Q25 — Radius Block Adapter Plate



Fig. Q26 — Radius Block for use with HB632 Bender

Q

**WARNING:** This product can expose you to chemicals including Lead and Lead Compounds which is known to the State of California to cause cancer and birth defects or other reproductive harm. For more information go to [www.p65warnings.ca.gov](http://www.p65warnings.ca.gov).

**"Need help determining the correct tooling for your bending job? Use [TFDtoolspec.com](http://TFDtoolspec.com)"**

[Click here for Support Resources or to Configure Parts Online](#)

## Radius Blocks – Metric Sizes

Tube O.D./ Size (mm)	Radius (mm)	Part No.
10	32	810023
12	32	780175
14	38	780176
15	38	780177
16	38	780178
18	44	780179
20	44	780180
22	89	780181
25	100	780182
30	128	780183
32	128	780184
35	105	974344
38	114	590530-72
42	128	974347*
50	150	974350*



Fig. Q27 — Radius Block for use with HB632 Bender

TABLE  
OF  
CONTENTS

VISUAL  
INDEX

FAQs

TOOL  
SPEC.COM

## Radius Blocks – Inch Pipe Sizes

Inch Pipe Size (in.)	Bend Radius (in.)	Part No.
3/8	2 1/4	974325
1/2	2 5/8	974326
3/4	3 1/4	974327
1	4	974328
1 1/4	5	974329
1 1/2	6	974330*

\* Requires the use of Radius Block Adapter Plate, Part No. 660221.

**WARNING:** This product can expose you to chemicals including Lead and Lead Compounds which is known to the State of California to cause cancer and birth defects or other reproductive harm. For more information go to [www.p65warnings.ca.gov](http://www.p65warnings.ca.gov).

*“Need help determining the correct tooling for your bending job? Use [TFDtoolspec.com](http://TFDtoolspec.com)”*



[Click here for Support Resources or to Configure Parts Online](#)

## Close Bend Radius Blocks for HB632

These adapters are used when bends are needed close to the end of the tube after the flare has been made, ferrule has been pre-set, or flange has been made. For flared or Ferulok fittings, attach tube end by threading tube nut onto the radius block threaded pin. To use this block with Seal-Lok fittings, Close Bend Adapters for Seal-Lok must be used to attach the tube to the radius block.

### Close Bend Radius Blocks – Inch Sizes

Size (in.)	Tube O.D. (in.)	Radius (in.)	Part No.
8	1/2	1 1/4	530597
10	5/8	1 1/2	530601
12	3/4	1 3/4	530605
14	7/8	2	530609
16	1	3	530613
20	1 1/4	3 3/4	530621
24	1 1/2	5	530625



Fig. Q28 — Close Bend Radius Block

### Close Bend Adapters for Seal-Lok

These adapters are used when bends are needed close to the end of the tube after the flange has been made or the sleeve has been brazed onto the end of the tube.

**HOWTO USE:** Screw the Seal-Lok adapter into the internal thread\* of the threaded pin on the radius block. Then attach the flanged or brazed tube by threading the tube nut to the Seal-Lok adapter on the radius block threaded pin.

\* If the threaded pin does not have an internal thread, a new threaded pin is required.

Tube O.D. (in.)	Description	Part No.
1/2	Seal-Lok Adapter.....	930421-8
5/8	Seal-Lok Adapter.....	930421-10
3/4	Seal-Lok Adapter.....	930421-12
1	Seal-Lok Adapter.....	930421-16
1 1/4	Seal-Lok Adapter.....	930421-20
1 1/2	Seal-Lok Adapter.....	930421-24
1/2	Threaded Pin (for Close Bend Radius Blocks) ..	930420-8
5/8	Threaded Pin (for Close Bend Radius Blocks) ..	930420-10
3/4	Threaded Pin (for Close Bend Radius Blocks) ..	930420-12
1	Threaded Pin (for Close Bend Radius Blocks) ..	930420-16
1 1/4	Threaded Pin (for Close Bend Radius Blocks) ..	930420-20
1 1/2	Threaded Pin (for Close Bend Radius Blocks) ..	930420-24



Fig. Q29 — Seal-Lok Close Bend Adapter

### Close Bend Radius Blocks – Metric Sizes

Tube O.D./ Size (mm)	Radius (mm)	Thread Size	Part No.
12	32	3/4-16	780185
14	38	7/8-14	780186
15	38	7/8-14	780187
16	38	7/8-14	780188
18	44	1 1/16-12	780189
20	44	1 1/16-12	780190
38	127	1 7/8-12	530625

**WARNING:** This product can expose you to chemicals including Lead and Lead Compounds which is known to the State of California to cause cancer and birth defects or other reproductive harm. For more information go to [www.p65warnings.ca.gov](http://www.p65warnings.ca.gov).

TABLE OF CONTENTS

VISUAL INDEX

FAQs

TOOL SPEC.COM

Q

[Click here for Support Resources or to Configure Parts Online](#)

## Bender Table (With Locking Casters) for HB632

Sturdy, heavy all steel construction, strongly braced to keep bender, mandrel rod, and mandrel rod stop assembly rigidly aligned. All holes are pre-drilled at factory to accommodate the HB632 bender and rod stop assembly.

**DIMENSION:** H – 36" W – 30" L – 10'

**NOTE:** Table is supplied with locking casters for ease of mobility.

<b>Part Name</b>	<b>Part No.</b>
Bender Table (with locking casters) for HB632 .....	520515



Fig. Q30 — Bender Table  
(equipment not included)

TABLE  
OF  
CONTENTS

VISUAL  
INDEX

FAQs

TOOL  
SPEC.COM

## Mandrel Bending Components

When bending thin wall tube it may be necessary to insert a mandrel into the tube to prevent excessive distortion or flattening. To accomplish such bending, a Mandrel, Mandrel Rod, and a Mandrel Rod Stop Assembly are required. The Rod Stop Assembly holds the end of the Mandrel Rod in proper alignment with the tube while the Mandrel, which is threaded onto the other end of the Mandrel Rod, supports the tube on its I.D., thus preventing tube kinking or flattening during bending.

The following parts are required for mandrel bending with the 412 and 424 bender:

<b>Part Name</b>	<b>Part No.</b>
Mandrel Rod Stop Assembly .....	550571 (See page Q18)
Stop Assembly Adapter Riser (424 only).....	631154 (See page Q18)
Mandrel Rods .....	See page Q17
Mandrel.....	See page Q17

The following parts are required for mandrel bending with the 632 bender:

<b>Part Name</b>	<b>Part No.</b>
Mandrel Rod Stop Assembly .....	631141 (See page Q18)
Mandrel Rods .....	See page Q17
Mandrel.....	See page Q17

### Example:

Tube O.D.: 2"  
Wall Thickness: 0.095"  
Centerline Radius: 8"

$$\text{Vertical Axis} = \frac{8''}{2''} = 4$$

$$\text{Horizontal Axis} = \frac{2''}{.095''} \approx 21$$

Answer: Plug Mandrel required

**WARNING:** This product can expose you to chemicals including Lead and Lead Compounds which is known to the State of California to cause cancer and birth defects or other reproductive harm. For more information go to [www.p65warnings.ca.gov](http://www.p65warnings.ca.gov).

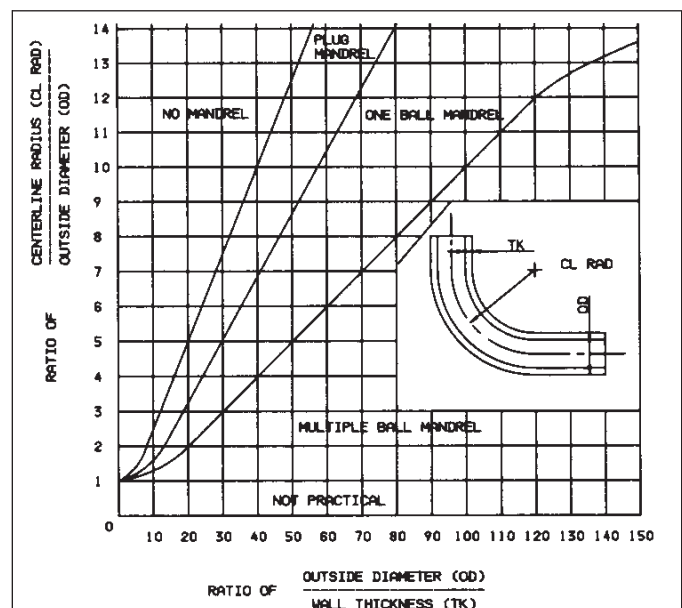

## Mandrels (Plug Type)

For use with Exactol Models 412, 424 and the HB632 benders. Mandrels ensure smooth bends without kinking, or wrinkling when bending thin-walled tube, or when making short-radius bends. Mandrels support the tube wall from the inside to keep it fully open for a smooth bend.

A rule that is generally followed to determine whether or not a mandrel is necessary is as follows: When the wall thickness of the tube to be bent is 7 percent or more of the tube O.D., a mandrel is usually not necessary. On wall thicknesses that range between 4-6 percent of the tube O.D., it is necessary to use a mandrel to avoid wrinkling and flattening in the bend area. This rule is based on a bend radii of between three and four times the tube O.D.

**Part Number Example:** 924417-Size X Wall Thickness =  
**924417-12X058**

\* See Fig. Q31 for mandrel usage.

To order mandrel, specify tube O.D. and wall thickness.

TABLE  
OF  
CONTENTS

VISUAL  
INDEX

FAQs

TOOL  
SPEC.COM



Fig. Q32 — Mandrel

Size	END SIZE (in.)	Wall Thickness				
		(in.)	(in.)	(in.)	(in.)	(in.)
6	3/8	—	—	—	—	—
8	1/2	—	0.035	—	—	—
10	5/8	0.035	—	—	—	—
12	3/4	—	—	—	0.058	—
14	7/8	—	—	—	0.058	0.065
16	1	—	0.042	—	0.058	0.065
18	1 1/8	—	0.042	—	—	0.065
20	1 1/4	—	—	—	0.065	0.095
24	1 1/2	—	0.058	—	0.083	—

Table Q4 — Mandrel Sizes

## Mandrel Rods

For use with the HB632 Model Bender and Exactol Models 412/424 benders. Mandrel rods (as well as a mandrel rod stop assembly) are required when using mandrels. Mandrel rod diameters are determined by tube I.D.



Fig. Q33 — Mandrel Rods

## Mandrel Rod Sizes

Mandrel Rod Dia. (in.)	Tube I.D. (in.)	Part No.
5/8	1.49 to 1.87 .....	520509

Q

[Click here for Support Resources or to Configure Parts Online](#)

## Mandrel Rod Stop Assembly

For use with Model HB632 bender.

The Mandrel Rod Stop Assembly, when bolted to the end of a table opposite of the bender, keeps the mandrel rod in alignment with the tube when mandrel bending.

Part Name	Part No.
Mandrel Rod Stop Assembly (for bender Model HB632).....	631141
Mandrel Rod Stop Adapter for 5/16" Mandrel Rod .....	522398
Mandrel Rod Stop Adapter for 1/4" Mandrel Rod .....	550501

## Mandrel Rod Stop Assembly

For use with Exactol 412/424 Model benders.

Part Name	Part No.
Mandrel Rod Stop Assembly .....	550571
Mandrel Rod Stop Adapter for 412/424 benders .....	820029

Part Name	Part No.
Stop Assembly Adapter/Riser for 424.....	631154

## Universal Side Angle Indicator

For use with Model HB632 bender.

Accurately determines angle between tube bends in different planes. Keeps out of plane angles accurate, when making repeated bends. Large, easy-to-read vernier dial. Maximum 3/4" O.D. tube can be used if the tube must be extended through the indicator. Maximum 1 1/2" O.D. tube can be used if end of tube is held in clamp jaw.

Part Name	Part No.
Universal Side Angle Indicator .....	520520

**WARNING:** This product can expose you to chemicals including Lead and Lead Compounds which is known to the State of California to cause cancer and birth defects or other reproductive harm. For more information go to [www.p65warnings.ca.gov](http://www.p65warnings.ca.gov).



Fig. Q34 — Mandrel Rod Stop Assembly /632



Fig. Q35 — Mandrel Rod Stop Assembly 412/424

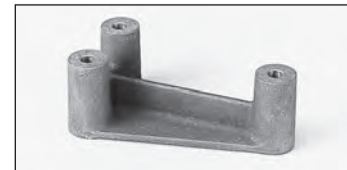

Fig. Q36 — Stop Assembly Adapter/Riser



Fig. Q37 — Universal Side Angle Indicator

TABLE  
OF  
CONTENTS

VISUAL  
INDEX

FAQs

TOOL  
SPEC.COM

Click here for Support Resources or to Configure Parts Online

## CP432 Tube and Pipe Bender

A 90 psi air supply does all the work for bending steel and stainless steel tube and pipe. This bender utilizes a center push bending method which is easy to master. Offered in an all inclusive kit. A separate accessory kit of tooling for bending 10mm through 50mm tube is also available. See page Q20 for part number information.

**Part Name** CP432 Tube and Pipe Bender Kit ..... **Part No.** CP432  
Includes all tooling necessary for bending 1/4" through 2" tube and 1/2 through 2" pipe.

*See Bulletin 4391-CP432 for more information.*

### REPLACEMENT COMPONENTS

**Part Name** **Part No.**  
Air/Hydraulic Pump ..... PAT-1102N  
Hose Assembly ..... 975222\*\*  
Quick Coupler, Receptacle ..... 3050-3  
Quick Coupler, Nipple ..... 3010-3  
Hydraulic Cylinder ..... RC-1010  
Radius Blocks ..... See below  
Slide Blocks ..... See below

### Radius Blocks for CP432 – Inch Tube Sizes

Tube O.D. (in.)	Bend Radius (in.)	Part No.
1/4	9/16	975179
3/8	1 1/4	975179
1/2	1 1/2	975179
5/8	1 7/8	975180
3/4	2 1/4	975180
1	3	975181
1 1/4	3 3/4	975182
1 1/2	4 1/2	975183
2	8	975184

### Slide Blocks for CP432 (2 required) – Inch Tube Sizes

Tube O.D. (in.)	Part No.
1/4	975185
3/8	975185
1/2	975185
5/8	975186
3/4	975186
1	975187
1 1/4	975187
1 1/2	975188
2	975188

\*For inch pipe size radius blocks and slide blocks refer to Table Q4 to right.

**WARNING:** This product can expose you to chemicals including Lead and Lead Compounds which is known to the State of California to cause cancer and birth defects or other reproductive harm. For more information go to [www.p65warnings.ca.gov](http://www.p65warnings.ca.gov).



Fig. Q38 — CP432 Bender Kit



Fig. Q39 — Pump



Fig. Q40 — Multi-Size Tube Radius Block

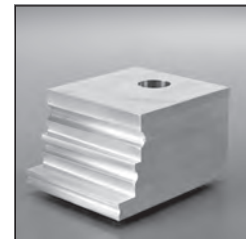

Fig. Q41 — Multi-Size Tube Slide Block

Pipe Size	Bend Radius	Radius Block Part #	Slide Block Part # (2 req'd.)	Drive Pin
1/2	3-3/16	BZ-12011	BZ-12071	A-12
3/4	5	BZ-12021		
1	5-7/8	BZ-12031		
1-1/4	7-1/4	BZ-12041		
1-1/2	8	BZ-12051		
2	9-1/2	BZ-12061		

Table Q5 - Inch Pipe Sizes

TABLE OF CONTENTS

VISUAL INDEX

FAQs

TOOL SPEC.COM

Q



[Click here for Support Resources or to Configure Parts Online](#)

### Radius Blocks for CP432 – Metric Tube Sizes

Tube O.D. (mm)	Bend Radius (mm)	Part No.
10	34	976503-Block
12	34	976503-Block
14	38	976503-Block
15	38	976505
16	38	976505
18	42	976508
20	42	976508
22	89	976510
25	100	976510
30	100	976512
32	100	976515
35	105	976516
38	114	976517
42	128	976518
50	200	976519

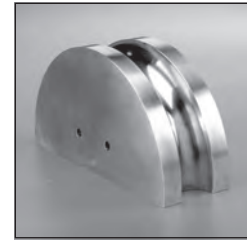

Fig. Q42 — Typical Radius Block

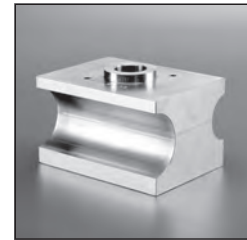

Fig. Q43 — Typical Slide Block

### Slide Blocks for CP432 (2 required) – Metric Tube Sizes

Tube O.D. (mm)	Part No.
10	976504
12	976504
14	976504
15	976506
16	976506
18	976509
20	976509
22	976511
25	976511
30	976513
32	976513
35	976520
38	976520
42	976521
50	976521

#### ACCESSORIES

Part Name	Part No.
Metric Tooling Kit (10-50mm).....	*CP432-MM TOOL KIT

\*Bender & pump is not included. CP432 is also needed.

TABLE OF CONTENTS

VISUAL INDEX

FAQs

TOOL SPEC.COM

[Click here for Support Resources or to Configure Parts Online](#)

## Kloskut® Tube Cutters

These adjustable tube cutters are designed to produce square cut ends with no external burr and minimum internal burr when used on fully annealed copper, brass, aluminum, and steel tube. Both feature a hardened and burnished tool-steel cutting wheel, flare cut-off grooves in rollers for removal of old flares and a swing-away reamer for removing internal burrs. The handle feeds and adjusts the cutting wheel to uniformly cut tube as the cutter is rotated.

**NOTE:** Tube cutters are **not recommended** for use with stainless steel tube because of the work hardening effect. The use of a hacksaw with a “Tru-Kut” Sawing Vise or a rotary teeth saw is recommended for stainless steel.

### Medium Kloskut

Part Description	Part No.
Tube cutter for 1/8” to 1 1/8” O.D.....	<b>218B</b>
Cutter Wheel for 218B .....	<b>218B Wheel</b>
Cutter Shaft .....	<b>218B Shaft</b>

### Large Kloskut

Part Description	Part No.
Tube Cutter for 3/4” to 2” O.D.....	<b>1232</b>
Cutter Wheel for 1232.....	<b>1232 Wheel</b>

## Tru-Kut® Sawing Vise

This hacksaw guide will accommodate tube, pipe and hose from sizes 3 (3/16” O.D.) to 32 (2” O.D.), assuring square cut-offs within  $\pm 1^\circ$ . For use with a fine tooth hacksaw blade for smooth cuts.

**HOW TO USE:** Mount in a vise or bolt to a bench. Clamp tube, pipe or hose into the Tru-Kut vise and cut off; guide ensures accurate square cuts.

Part Description	Part No.
Tru-Kut Sawing Vise .....	<b>710439</b>

## Cut-Off Saw

The 974250 Cut-Off Saw is designed to operate at low speed to prevent work hardening the tube end. The saw will assure a square cut on the tube with minimum burrs. The saw will cut 1/4” through 2 3/4” copper, brass, aluminum, steel and stainless steel tube. An adequate supply of cutting fluid is provided by an internal recirculating pump. The unit is designed for bench or stand mounting and operates on 110V, 15 amp power supply.

Part Description	Part No.
Cut-Off Saw .....	<b>974250</b>

Accessories	Part No.
Saw Base .....	<b>AF160026</b>

Replacement Parts	Part No.
Cutting Lubricant (Approx. 1 gal. container) .....	<b>Saw Lube</b>
Saw Blade – 250 mm x 2.0 mm thick (all purpose) .....	<b>987036</b>
Saw Blade – 200 mm x 2.0 mm thick (all purpose) .....	<b>987037</b>

**WARNING:** This product can expose you to chemicals including Lead and Lead Compounds which is known to the State of California to cause cancer and birth defects or other reproductive harm. For more information go to [www.p65warnings.ca.gov](http://www.p65warnings.ca.gov).

TABLE  
OF  
CONTENTS

VISUAL  
INDEX

FAQs

TOOL  
SPEC.COM



Fig. Q44 — 218B Medium Kloskut Tube Cutter



Fig. Q45 — 1232 Large Kloskut Tube Cutter



Fig. Q46 — Tru-Kut Sawing Vise



Fig. Q47 — Cut-Off Saw (shown on Saw Base)

Q

[Click here for Support Resources or to Configure Parts Online](#)

## Tube Deburring Tool 226B

A quick twist of the wrist will deburr either the O.D. or the I.D. of the tube end. Parker's In-Ex deburrer can be used on annealed steel, stainless steel, copper and aluminum, for tube sizes 1/8" to 1 5/8" O.D.

<b>Part Description</b>	<b>Part No.</b>
Deburring Tool .....	226B



Fig. Q48 — Deburr Tool 226B

## Power Deburr Tool

The Parker Power Deburr Tool is designed for deburring the I.D. and O.D. of 1/4" through 2" steel, stainless steel, copper and aluminum tube. The lightweight unit incorporates a modular design which allows Parker's Cut-Off Saw, part number 974250, to be easily mounted on the top. The Power Deburr Tool requires 110V/10A power supply.

Dimensions: L – 20", W – 18", H – 9".

<b>Part Description</b>	<b>Part No.</b>
Power Deburr Tool .....	972125



Fig. Q49 — Power Deburr Tool

<b>Replacement Parts</b>	
I.D. Deburr Cone .....	971816
O.D. Deburr Blades (six blade set).....	910485

## FastSeal Assembly Tools

Patent-pending FastSeal is a revolutionary new way to make O-ring Face Seal tube connections. Assembly and maintenance teams can quickly preset the sleeve onto the tube end for a permanent flat-face connection with no need for brazing or flanging equipment. The two tools that are recommended, but not required, for FastSeal assembly are a mandrel and gauge (marking tool). Part numbers correspond with the FastSeal part number being used and are shown in shown in table below. View FastSeal assembly instructions in the Assembly section of the catalog or on [the FastSeal Assembly Instructions page \(Parker FastSeal™ Assembly Instructions\)](#).



Fig. Q50— FastSeal Mandrel

Tube OD (in.)	Part Numbers		
	FastSeal	Mandrel	Marking Tool
1/4	4 TLFA-S	4 TLFA Mandrel	4 TLFA Gauge
3/8	6 TLFA-S	6 TLFA Mandrel	6 TLFA Gauge
1/2	8 TLFA-S	8 TLFA Mandrel	8 TLFA Gauge



Fig. Q51 — FastSeal Gauge

**Parker's patent-pending FastSeal creates quick leak-free permanent ORFS tube end connections with just a wrench. Get more details on this new technology now.**

TABLE OF CONTENTS

VISUAL INDEX

FAQs

TOOL SPEC.COM

# Parflange® 1025

## Bench-Top 90° Flanging and 37° Flaring System

Tooling must be ordered separately

- Eliminates braze joint
- Compact, lightweight design
- Bench mountable
- Easy to operate
- Available in 110-volt single-phase or 440-volt 3-phase (please specify by ordering 1025/110 or 1025/440)
- Flanges or flares tube in less than 20 seconds
- For tube sizes 1/4" O.D. thru 1-1/2" O.D. (steel); and 1/4" O.D. thru 1" O.D. (stainless steel) – Flanging/flaring of tube sizes 1" & greater results in heavy machine vibration. Therefore, this machine is only recommended for occasional use for preparing tube ends 1" or larger.

Tooling is also available for comparable metric tube sizes.

Electrical Power: 110V/20A single-phase, or 440V/3-phase/2.1A

Power Cable Length: 8 feet long (2.5 meters)

Dimensions: Height: 18 1/8 inches (460mm)

Width: 15 3/8 inches (390mm)

Depth: 26 3/8 inches (670mm)

Weight: Basic Unit: 175 lbs. (80 kg.)

Each Die (typical): 4 lbs. (1.8 kg.)

Flanging Pin Lubrication Fluid: **LB2000**

 **Instructional video is available at [discover.parker.com/TFDTubeFabEquipment](http://discover.parker.com/TFDTubeFabEquipment).**

**[View the Parflange Equipment Overview and Comparison Guide.](#)**

### COMPONENTS REQUIRED

Part Name	Part No.
Parflange 1025 (110 volt) .....	<b>1025/110</b>
Parflange 1025 (440 volt) .....	<b>1025/440</b>
Flanging Pin.....	See page Q23
Flanging Die Set.....	See page Q23
Flaring Pin .....	See page Q37
Flaring Die Set.....	See page Q37
Lubrication Fluid .....	<b>LB 2000</b>
Die Adjustment Shims (Old Style Dies Only).....	<b>Shim Kit</b>

### REPLACEMENT PART

Part Name	Part No.
Tube Stop .....	<b>1025/0281014</b>



Fig. Q52 — Parflange® 1025 Machine



Fig. Q53 — Flanging Pin



Fig. Q54 — Flanging Die Set



Fig. Q55 — LB 2000

TABLE  
OF  
CONTENTS

VISUAL  
INDEX

FAQs

TOOL  
SPEC.COM

Q



[Click here for Support Resources or to Configure Parts Online](#)

# Inch and Metric Flanging Tooling for 1025

TABLE  
OF  
CONTENTS

VISUAL  
INDEX

FAQs

TOOL  
SPEC.COM

Tube Size O.D. x Wall Thickness (in.)	Tooling for 90°/180° Tube Flanging			Available Flanging Tooling	
	Flange Pin and Die Set Part Number	Pin Part Number	Die Part Number	1025	
				-S	-SS
1/4 x .028	4004X028180	B4004X028180	M4004X028180	•	
1/4 x .035	4004X035180	B4004X035180	M4004X035180	•	•
1/4 x .049	4004X049180	B4004X049180	M4004X049180	•	
3/8 x .035	4006X035180	B4006X035180	M4006X035180	•	•
3/8 x .049	4006X049180	B4006X049180	M4006X049180	•	•
3/8 x .065	4006X065180	B4006X065180	M4006X065180	•	•
1/2 x .035	4008X035180	B4008X035180	M4008X035180	•	•
1/2 x .049	4008X049180	B4008X049180	M4008X049180	•	•
1/2 x .065	4008X065180	B4008X065180	M4008X065180	•	•
1/2 x .083	4008X083180	B4008X083180	M4008X083180	•	•
5/8 x .049	4010X049180	B4010X049180	M4010X049180	•	•
5/8 x .065	4010X065180	B4010X065180	M4010X065180	•	•
5/8 x .083	4010X083180	B4010X083180	M4010X083180	•	•
5/8 x .095	4010X095180	B4010X095180	M4010X095180	•	•
5/8 x .109	4010X109180	B4010X109180	M4010X109180	•	
5/8 x .120	4010X120180	B4010X120180	M4010X120180	•	
3/4 x .049	4012X049180	B4012X049180	M4012X049180	•	•
3/4 x .065	4012X065180	B4012X065180	M4012X065180	•	•
3/4 x .083	4012X083180	B4012X083180	M4012X083180	•	•
3/4 x .095	4012X095180	B4012X095180	M4012X095180	•	•
3/4 x .109	4012X109180	B4012X109180	M4012X109180	•	•
3/4 x .120	4012X120180	B4012X120180	M4012X120180	•	
1 x .065	4016X065180	B4016X065180	M4016X065180	•	•
1 x .083	4016X083180	B4016X083180	M4016X083180	•	•
1 x .095	4016X095180	B4016X095180	M4016X095180	•	
1 x .109	4016X109180	B4016X109180	M4016X109180	•	
1 x .120	4016X120180	B4016X120180	M4016X120180	•	
1 x .134	4016X134180	B4016X134180	M4016X134180	•	
1 x .148	4016X148180	B4016X148180	M4016X148180	•	
1 x .156	4016X156180	B4016X156180	M4016X156180	•	
1 x .188	4016X188180	B4016X188180	M4016X188180	•	
1 1/4 x .065	4020X065180	B4020X065180	M4020X065180	•	
1 1/4 x .083	4020X083180	B4020X083180	M4020X083180	•	
1 1/4 x .095	4020X095180	B4020X095180	M4020X095180	•	
1 1/4 x .109	4020X109180	B4020X109180	M4020X109180	•	
1 1/4 x .120	4020X120180	B4020X120180	M4020X120180	•	
1 1/4 x .134	4020X134180	B4020X134180	M4020X134180		
1 1/4 x .148	4020X148180	B4020X148180	M4020X148180		
1 1/4 x .156	4020X156180	B4020X156180	M4020X156180		
1 1/4 x .188	4020X188180	B4020X188180	M4020X188180		
1 1/2 x .065	4024X065180	B4024X065180	M4024X065180	•	
1 1/2 x .083	4024X083180	B4024X083180	M4024X083180	•	
1 1/2 x .095	4024X095180	B4024X095180	M4024X095180	•	
1 1/2 x .109	4024X109180	B4024X109180	M4024X109180		
1 1/2 x .120	4024X120180	B4024X120180	M4024X120180		
1 1/2 x .134	4024X134180	B4024X134180	M4024X134180		
1 1/2 x .148	4024X148180	B4024X148180	M4024X148180		
1 1/2 x .156	4024X156180	B4024X156180	M4024X156180		
1 1/2 x .188	4024X188180	B4024X188180	M4024X188180		

**Note:** Use “-SS” suffix after part number for flanging tools for stainless steel tube. Contact the Tube Fittings Division for sizes and/or materials not listed, or for additional SS sizes released for limited use.

**Table Q6 — Pin & Die Part Numbers for Inch Sizes**

Tube Size O.D. x Wall Thickness (mm)	Tooling for 90°/180° Tube Flanging		Available Flanging Tooling	
	Pin Part Number	Die Part Number	1025	
			S	SS
6 x 1	B3018006X1M	M4018006X1M	•	
6 x 1.5	B3018006X1.5M	M4018006X1.5M	•	
8 x 1	B3018008X1M	M4018008X1M	•	
8 x 1.5	B3018008X1.5M	M4018008X1.5M	•	
10 x 1	B3018010X1M	M4018010X1M	•	
10 x 1.5	B3018010X1.5M	M4018010X1.5M	•	
10 x 2	B3018010X2M	M4018010X2M	•	
12 x 1	B3018012X1M	M4018012X1M	•	
12 x 1.5	B3018012X1.5M	M4018012X1.5M	•	•
12 x 2	B3018012X2M	M4018012X2M	•	
15 x 1.5	B3018015X1.5M	M4018015X1.5M	•	
15 x 2	B3018015X2M	M4018015X2M	•	
16 x 1	B3018016X1M	M4018016X1M	•	
16 x 1.5	B3018016X1.5M	M4018016X1.5M	•	
16 x 2	B3018016X2M	M4018016X2M	•	•
16 x 2.5	B3018016X2.5M	M4018016X2.5M	•	
18 x 1	B3018018X1M	M4018018X1M	•	
18 x 1.5	B3018018X1.5M	M4018018X1.5M	•	
18 x 2	B3018018X2M	M4018018X2M	•	
20 x 2	B3018020X2M	M4018020X2M	•	•
20 x 2.5	B3018020X2.5M	M4018020X2.5M	•	
20 x 3	B3018020X3M	M4018020X3M	•	
22 x 1.5	B3018022X1.5M	M4018022X1.5M	•	
22 x 2	B3018022X2M	M4018022X2M	•	
22 x 2.5	B3018022X2.5M	M4018022X2.5M	•	
22 x 3	B3018022X3M	M4018022X3M	•	
25 x 2	B3018025X2M	M4018025X2M	•	
25 x 2.5	B3018028X2.5M	M4018028X2.5M	•	
25 x 3	B3018030X2M	M4018030X2M	•	
25 x 3.5	B3018025X3.5M	M4018025X3.5M	•	
25 x 4	B3018025X4M	M4018025X4M	•	
28 x 2	B3018028X2M	M4018028X2M	•	
28 x 2.5	B3018028X2.5M	M4018028X2.5M	•	
30 x 2	B3018030X2M	M4018030X2M	•	
30 x 3	B3018030X3M	M4018030X3M	•	
30 x 3.5	B3018030X3.5M	M4018030X3.5M	•	
30 x 4	B3018030X4M	M4018030X4M	•	
32 x 3	B3018032X3M	M4018032X3M	•	
32 x 4	B3018032X4M	M4018032X4M	•	
35 x 3	B3018035X3M	M4018035X3M	•	
38 x 3	B3018038X3M	M4018038X3M	•	
38 x 4	B3018038X4M	M4018038X4M	•	
38 x 5	B3018038X5M	M4018038X5M	•	

**Note:** Flanging tools (90°/180°) listed are for carbon steel tube. Contact the Tube Fittings Division for metric flanging tools for tube materials other than carbon steel or for sizes not listed.

**Table Q7 — Pin & Die Part Numbers for Metric Sizes**



# Parflange® ECO 25

## Bench-Top 90° Flanging and 37° Flaring System

Tooling and Hydraulic Pump must be ordered separately

- Eliminates braze joints
- More efficient than traditional flaring methods
- Only requires one die per tube size for both flanging and flaring
- For tube sizes 1/4" O.D. through 1-1/2" O.D. in both Steel and Stainless Steel
- Dies not dependent on wall thickness or tube material
- Uses same Parflange pins as 1025 and PRO 50 models
- Utilizes proven Parflange orbital process for consistent flanges and flares
- Burnishes flanges and flares for superior surface finish
- Compact, lightweight design
- Easy to operate
- Used with hand hydraulic pump
- 110-volt single-phase power
- Tooling also available in comparable metric sizes

Electrical Power: 110V/20A single-phase

Power Cable Length: 8 feet long (2.5 meters)

Dimensions: Height: 20.5 inches (520mm)

Width: 15 inches (381mm)

Depth: 20.5 (520mm)

Weight: 190 lbs. (86.4 kg.)

See Bulletin 4391-ECO25 for more information and instructions for use.

 Instructional video is available at [discover.parker.com/TFDTubeFabEquipment](http://discover.parker.com/TFDTubeFabEquipment).

View the Parflange Equipment Overview and Comparison Guide.

### COMPONENTS REQUIRED

Part Name	Part No.
*ECO 25 Basic Unit .....	<b>ECO 25</b>
*Hand Hydraulic Pump .....	<b>900086</b>
Flanging Pin.....	See page Q26
Flaring Pin .....	See page Q31
Flanging/Flaring Dual Function Die Set.....	See page Q26 & Q38
*Lubrication Fluid.....	<b>LB 2000</b>
*Hose Assembly (for hand pump).....	<b>910133**</b>
*Pressure gauge (0 - 10,000 psi).....	<b>900044***</b>
*Hydraulic Pump Adapter .....	<b>6-6 FLO-S</b>
*Hydraulic Pump Tee .....	<b>6 R6LO-S</b>
*Pressure Gauge Adapter .....	<b>6 G6L-S</b>
*Hose Conversion Adapter (#1).....	<b>6 G6L-S</b>
*Hose Conversion Adapter (#2).....	<b>6-6 G6L-S</b>

\*Included in ECO 25 kit (Part Number ECO 25 KIT)

 **WARNING:** \*\*\*This product can expose you to chemicals including Hex Chromium 6 which is known to the State of California to cause cancer and birth defects or other reproductive harm. For more information go to [www.p65warnings.ca.gov](http://www.p65warnings.ca.gov).

## ECO 25 Kit

Part Name	Part No.
ECO 25 Kit (includes hand pump) .....	<b>ECO 25 KIT</b>

(Kit includes basic unit, hand hydraulic pump, hose assembly, pressure gauge, hydraulic pump adapter, hydraulic pump tee, pressure gauge adapter, hose conversion adapters #1 & #2, Lubrication fluid, and operation manual.)

 **WARNING:** This product can expose you to chemicals including Lead and Lead Compounds which is known to the State of California to cause cancer and birth defects or other reproductive harm. For more information go to [www.p65warnings.ca.gov](http://www.p65warnings.ca.gov).



Fig. Q56 — Parflange ECO 25

**CAUTION:** Extension cords are *not* recommended and could cause damage to the machine due to a lack of power supply.



Fig. Q57 — Hand Pump

TABLE  
OF  
CONTENTS

VISUAL  
INDEX

FAQs

TOOL  
SPEC.COM

Q

## Inch Flanging Tooling for ECO25

TABLE  
OF  
CONTENTS

VISUAL  
INDEX

FAQs

TOOL  
SPEC.COM

Tube O.D. (in.)	Die Set Part Number
1/4	M2504
3/8	M2506
1/2	M2508
5/8	M2510
3/4	M2512
1	M2516
1 1/4	M2520
1 1/2	M2524

**Table Q8 — Flanging Die Set,  
Inch Sizes**

Tube O.D. (in.)	Wall Thickness (in.)	Flanging Pin Steel Tube	Flanging Pin Stainless Tube
1/4	0.028	B4004X028180	-
1/4	0.035	B4004X035180	B4004X035180SS
1/4	0.049	B4004X049180	B4004X049180SS
3/8	0.035	B4006X035180	B4006X035180SS
3/8	0.049	B4006X049180	B4006X049180SS
3/8	0.065	B4006X065180	B4006X065180SS
1/2	0.035	B4008X035180	B4008X035180SS
1/2	0.049	B4008X049180	B4008X049180SS
1/2	0.065	B4008X065180	B4008X065180SS
1/2	0.083	B4008X083180	B4008X083180SS
1/2	0.095	B4008X095180	B4008X095180SS
5/8	0.049	B4010X049180	B4010X049180SS
5/8	0.065	B4010X065180	B4010X065180SS
5/8	0.083	B4010X083180	B4010X083180SS
5/8	0.095	B4010X095180	B4010X095180SS
5/8	0.120	B4010X120180	-
3/4	0.049	B4012X049180	B4012X049180SS
3/4	0.065	B4012X065180	B4012X065180SS
3/4	0.083	B4012X083180	B4012X083180SS
3/4	0.095	B4012X095180	B4012X095180SS
3/4	0.104	-	B4012X104180SS
3/4	0.109	B4012X109180	B4012X109180SS
3/4	0.120	B4012X120180	B4012X120180SS
1	0.065	B4016X065180	B4016X065180SS
1	0.083	B4016X083180	B4016X083180SS
1	0.095	B4016X095180	B4016X095180SS
1	0.109	B4016X109180	B4016X109180SS
1	0.120	B4016X120180	B4016X120180SS
1	0.134	B4016X134180	B4016X134180SS
1	0.139	-	B4016X139180SS
1 1/4	0.065	B4020X065180	-
1 1/4	0.083	B4020X083180	B4020X083180SS
1 1/4	0.095	B4020X095180	B4020X095180SS
1 1/4	0.109	B4020X109180	B4020X109180SS
1 1/4	0.120	B4020X120180	B4020X120180SS
1 1/4	0.134	B4020X134180	-
1 1/2	0.065	B4024X065180	-
1 1/2	0.083	B4024X083180	-
1 1/2	0.095	B4024X095180	B4024X095180SS
1 1/2	0.109	B4024X109180	B4024X109180SS
1 1/2	0.120	B4024X120180	B4024X120180SS

**Table Q9 — Flanging Pin, Inch Sizes**



**Fig. Q58 — Flanging Pin**



**Fig. Q59 — Dual  
Function Die Set  
(Flaring and Flanging)**

[Click here for Support Resources or to Configure Parts Online](#)

## Parflange® Pro 50

The Parflange® Pro 50 is a production WorkCenter for orbital flaring and flanging of high pressure tube connections. The unique feature of the Parflange® process is that the deformation of the tube end is achieved by rolling rather than by just pushing a tool into the tube end.

The Parflange® machine smoothly compresses the tube material and achieves a high strength joint with a polished surface of the tube end. Seal-Lok and SAE flange sleeves are firmly fixed onto the tube end, resulting in a very rigid high-pressure tube connection.

The Pro50 is the heavy-duty mass production WorkCenter of the Parflange® machine program. It is recommended for industrial production of all sizes Triple-Lok® and required Seal-Lok tube connections. Maximum tube capacity is 2" tube O.D / 50 mm.

The powerful drive and the fast, automatic process allow short cycle times for efficient production. Its advantage is the quick and easy change of tooling and the simple operation without manual adjustments or programming. Tube clamping and tool lubrication are done automatically.

The Pro 50 comes ready to be used. Parflange® tools have to be purchased separately. For each tube dimension, special clamping dies and Parflange® pins are required. The machine can be moved on wheels, by forklift truck and crane. For basic use, just an electric power supply is required.



Fig. Q60 — Parflange Pro 50

TABLE  
OF  
CONTENTS

VISUAL  
INDEX

FAQs

TOOL  
SPEC.COM

 **Instructional video is available at [discover.parker.com/TFDTubeFabEquipment](http://discover.parker.com/TFDTubeFabEquipment).**

**View the Parflange Equipment Overview and Comparison Guide.**

**WARNING:** This product can expose you to chemicals including Lead and Lead Compounds which is known to the State of California to cause cancer and birth defects or other reproductive harm. For more information go to [www.p65warnings.ca.gov](http://www.p65warnings.ca.gov).

## Pro 50 Machine Specification

Purpose:	180° Flanging for Seal-Lok and 37° Flaring for Triple-Lok®
Process:	Orbital flaring and flanging according to Parflange® process
Design:	WorkCenter for industrial production
Tube material:	Steel and stainless steel tube
Tube diameter:	Inch: 1/4" to 2" Metric: 6 to 50 mm
Min. U-bend:	4.72 mm
Maximum capacity:	Steel tube (ST 37, ST52,...) Inch: 2" x 0.120 (tube O.D. x wall thickness) Metric: 38 x 5 / 50 x 3 mm Stainless steel tube (1.4571, 316, ...) Inch: 1-1/2" x 0.156 Metric: 38 x 4 mm
Tube specification:	Fully annealed seamless cold drawn or welded and redrawn precision tube
Operation:	Automatic clamping, automatic flanging/flaring
Speed:	5-8 sec. flanging time / 15-20 sec. total cycle time

Economic production quantity:	max. 500 flarings per day
Tools:	See Tables 9 & 10 on page Q30
Tool compartments:	10 die sets, 10 pins
Tool clamping:	Automatic
Tool lubrication:	Automatic lubrication device
Lubricant:	EO-NIROMONT (filled when delivered)
Hydraulic oil:	HLP 46 (filled when delivered)
Installation:	Electrical power
Dimensions:	27.6 in x 33 in x 40.7 in
Platform for bins:	2 platforms, 11.8 x 19.7 in, max. 11 lbs each
Weight:	838 lbs
Electrical power:	400 V, 3 Phase, 50 Hz, 4.5 kW
Transport options:	On wheels, by forklift truck, lifting attachments

Q

## Parflange® Pro 50 with Feeder

For industrial mass production of Seal-Lok tube end connections, the Parflange Pro 50 with sleeve feed is available. This sleeve feeding device increases the productivity, particularly of high volume - single tube dimension jobs.

In “Feeder ON - mode”, Seal-Lok sleeves just need to be inserted into feeder rails. First cycle start is initiated by manually closing the safety cover. Then, all following cycles are started by pushing the tube into the pre-clamped dies. All other machine activities, like tube clamping, flanging, tube release, insertion of Seal-Lok sleeves into dies, pre-clamping of dies and the operation of safety cover run fully automatic. The operator just is handling the tubes and refilling the sleeve-feeder from times to times with Seal-Lok sleeves.

In “Feeder OFF - mode”, the Parflange® PRO 50 operates like the Parflange® PRO 50 without Seal-Lok sleeve feeder. This mode is useful for maximum size flexibility and Triple-Lok® assembly. For quick changeover and safety reasons, the Seal-Lok sleeve feeder is just switched OFF but not be removed from the Parflange® PRO 50 WorkCenter.

For operation of Parflange Pro 50, compressed air supply is required.

**⚠ WARNING:** This product can expose you to chemicals including Lead and Lead Compounds which is known to the State of California to cause cancer and birth defects or other reproductive harm. For more information go to [www.p65warnings.ca.gov](http://www.p65warnings.ca.gov).



Fig. Q61 — Parflange Pro 50 w/Feeder

TABLE  
OF  
CONTENTS

VISUAL  
INDEX

FAQs

TOOL  
SPEC.COM

## Pro 50 Machine Specification

Specific differences of PRO 50 versus PRO 50 with Feeder	
Design:	Parflange® PRO 50 with additional Seal-Lok sleeve feeder
Normal Operation:	Same as Parflange® 50 when feeder is switched off
Feeder Operation:	Work-cycle initiated by inserting tube end Automatic clamping, automatic flanging/flaring Automatic insertion of Seal-Lok sleeves into dies Automatic operation of safety cover Automatic pre-clamping of dies
Manual operation:	Like Parflange® PRO 50
Cycle time:	5-8 sec. flanging time / approx. 15 to 20 sec. total cycle time
Tools:	Same tools as Parflange® PRO 50 without feeder
Feeder:	Feeder is delivered in separate box and must be firmly attached to machine. Feeder can be switched ON and OFF but must not be removed.
Feeder rails:	Feeder rail kits must be ordered separately for each Seal-Lok sleeve size
Feeder setup:	Installation of matching rail kit by knurled nuts and adjustment of scale wheel according to chart
Installation:	Electrical power, for feeder type machines: compressed air supply (6 bar)
Dimensions:	2.30 ft x 2.76 ft x 6.66 ft
Weight:	904 lbs



## Ordering

Type	Order code
Parflange® 50 machine Ready to use, including operation manual, filled with hydraulic oil and lubricant Without Parflange® tools Basic machine Europe version (not prepared for Seal-Lok sleeve feeder)	
Purchase:	PRO 50
Rent (monthly)	e-mail TFDrental@parker.com for availability

**WARNING:** This product can expose you to chemicals including Lead and Lead Compounds which is known to the State of California to cause cancer and birth defects or other reproductive harm. For more information go to [www.p65warnings.ca.gov](http://www.p65warnings.ca.gov).

Type	Order code
Parflange® 50 PRO machine Europe version including Seal-Lok sleeve feeder without feeder rails	
Purchase:	PRO 50 with Feeder
Rent (monthly)	e-mail TFDrental@parker.com for availability

**WARNING:** This product can expose you to chemicals including Lead and Lead Compounds which is known to the State of California to cause cancer and birth defects or other reproductive harm. For more information go to [www.p65warnings.ca.gov](http://www.p65warnings.ca.gov).

Sleeve feeder rails for Parflange® 50 PRO	Tube OD	Order code
Seal-Lok sleeve feeding rail	6mm / 1/4"	1050RAIL04
Seal-Lok sleeve feeding rail	8, 10mm / 3/8"	1050/RAIL06
Seal-Lok sleeve feeding rail	12mm / 1/2"	1050/RAIL08
Seal-Lok sleeve feeding rail	14,15,16mm / 5/8"	1050/RAIL10
Seal-Lok sleeve feeding rail	18,20mm / 3/4"	1050/RAIL12
Seal-Lok sleeve feeding rail	22,25 / 1"	1050/RAIL16
Seal-Lok sleeve feeding rail	28,30,32 / 1-1/4"	1050/RAIL20
Seal-Lok sleeve feeding rail	35,38 / 1-1/2"	1050/RAIL24

Parflange® machines and feeders are shipped in special containers which should be kept for future transports to avoid damage. Please don't dispose of the transport boxes!



Parflange®  
PRO 50



Parflange®  
PRO 50  
with Feeder  
for mass  
production  
of Seal-Lok  
assemblies

TABLE  
OF  
CONTENTS

VISUAL  
INDEX

FAQs

TOOL  
SPEC.COM

Q



Click here for Support Resources or to Configure Parts Online

# Inch and Metric Flanging Tooling for PRO 50

TABLE  
OF  
CONTENTS

VISUAL  
INDEX

FAQs

TOOL  
SPEC.COM

Tube Size O.D. x Wall Thickness (in.)	Tooling for 90°/180° Tube Flanging			Available Flanging Tooling	
	Flange Pin and Die Set Part Number	Pin Part Number	Die Part Number	1025	
				-S	-SS
1/4 x .028	4004X028180	B4004X028180	M4004X028180	•	
1/4 x .035	4004X035180	B4004X035180	M4004X035180	•	•
1/4 x .049	4004X049180	B4004X049180	M4004X049180	•	
3/8 x .035	4006X035180	B4006X035180	M4006X035180	•	•
3/8 x .049	4006X049180	B4006X049180	M4006X049180	•	•
3/8 x .065	4006X065180	B4006X065180	M4006X065180	•	•
1/2 x .035	4008X035180	B4008X035180	M4008X035180	•	•
1/2 x .049	4008X049180	B4008X049180	M4008X049180	•	•
1/2 x .065	4008X065180	B4008X065180	M4008X065180	•	•
1/2 x .083	4008X083180	B4008X083180	M4008X083180	•	•
5/8 x .049	4010X049180	B4010X049180	M4010X049180	•	•
5/8 x .065	4010X065180	B4010X065180	M4010X065180	•	•
5/8 x .083	4010X083180	B4010X083180	M4010X083180	•	•
5/8 x .095	4010X095180	B4010X095180	M4010X095180	•	•
5/8 x .109	4010X109180	B4010X109180	M4010X109180	•	•
5/8 x .120	4010X120180	B4010X120180	M4010X120180	•	•
3/4 x .049	4012X049180	B4012X049180	M4012X049180	•	•
3/4 x .065	4012X065180	B4012X065180	M4012X065180	•	•
3/4 x .083	4012X083180	B4012X083180	M4012X083180	•	•
3/4 x .095	4012X095180	B4012X095180	M4012X095180	•	•
3/4 x .109	4012X109180	B4012X109180	M4012X109180	•	•
3/4 x .120	4012X120180	B4012X120180	M4012X120180	•	•
1 x .065	4016X065180	B4016X065180	M4016X065180	•	•
1 x .083	4016X083180	B4016X083180	M4016X083180	•	•
1 x .095	4016X095180	B4016X095180	M4016X095180	•	•
1 x .109	4016X109180	B4016X109180	M4016X109180	•	•
1 x .120	4016X120180	B4016X120180	M4016X120180	•	•
1 x .134	4016X134180	B4016X134180	M4016X134180	•	•
1 x .148	4016X148180	B4016X148180	M4016X148180	•	•
1 x .156	4016X156180	B4016X156180	M4016X156180	•	•
1 x .188	4016X188180	B4016X188180	M4016X188180	•	•
1 1/4 x .065	4020X065180	B4020X065180	M4020X065180	•	•
1 1/4 x .083	4020X083180	B4020X083180	M4020X083180	•	•
1 1/4 x .095	4020X095180	B4020X095180	M4020X095180	•	•
1 1/4 x .109	4020X109180	B4020X109180	M4020X109180	•	•
1 1/4 x .120	4020X120180	B4020X120180	M4020X120180	•	•
1 1/4 x .134	4020X134180	B4020X134180	M4020X134180	•	•
1 1/4 x .148	4020X148180	B4020X148180	M4020X148180	•	•
1 1/4 x .156	4020X156180	B4020X156180	M4020X156180	•	•
1 1/4 x .188	4020X188180	B4020X188180	M4020X188180	•	•
1 1/2 x .065	4024X065180	B4024X065180	M4024X065180	•	•
1 1/2 x .083	4024X083180	B4024X083180	M4024X083180	•	•
1 1/2 x .095	4024X095180	B4024X095180	M4024X095180	•	•
1 1/2 x .109	4024X109180	B4024X109180	M4024X109180	•	•
1 1/2 x .120	4024X120180	B4024X120180	M4024X120180	•	•
1 1/2 x .134	4024X134180	B4024X134180	M4024X134180	•	•
1 1/2 x .148	4024X148180	B4024X148180	M4024X148180	•	•
1 1/2 x .156	4024X156180	B4024X156180	M4024X156180	•	•
1 1/2 x .188	4024X188180	B4024X188180	M4024X188180	•	•

**Note:** Use “-SS” suffix after part number for flanging tools for stainless steel tube. Contact the Tube Fittings Division for sizes and/or materials not listed, or for additional SS sizes released for limited use.

Table Q10 — Pin & Die Part Numbers for Inch Sizes

Tube Size O.D. x Wall Thickness (mm)	Tooling for 90°/180° Tube Flanging		Available Flanging Tooling	
	Pin Part Number	Die Part Number	1025	
			S	SS
6 x 1	B3018006X1M	M4018006X1M	•	
6 x 1.5	B3018006X1.5M	M4018006X1.5M	•	
8 x 1	B3018008X1M	M4018008X1M	•	
8 x 1.5	B3018008X1.5M	M4018008X1.5M	•	
10 x 1	B3018010X1M	M4018010X1M	•	
10 x 1.5	B3018010X1.5M	M4018010X1.5M	•	
10 x 2	B3018010X2M	M4018010X2M	•	
12 x 1	B3018012X1M	M4018012X1M	•	
12 x 1.5	B3018012X1.5M	M4018012X1.5M	•	•
12 x 2	B3018012X2M	M4018012X2M	•	
15 x 1.5	B3018015X1.5M	M4018015X1.5M	•	
15 x 2	B3018015X2M	M4018015X2M	•	
16 x 1	B3018016X1M	M4018016X1M	•	
16 x 1.5	B3018016X1.5M	M4018016X1.5M	•	
16 x 2	B3018016X2M	M4018016X2M	•	•
16 x 2.5	B3018016X2.5M	M4018016X2.5M	•	
18 x 1	B3018018X1M	M4018018X1M	•	
18 x 1.5	B3018018X1.5M	M4018018X1.5M	•	
18 x 2	B3018018X2M	M4018018X2M	•	
20 x 2	B3018020X2M	M4018020X2M	•	•
20 x 2.5	B3018020X2.5M	M4018020X2.5M	•	
20 x 3	B3018020X3M	M4018020X3M	•	
22 x 1.5	B3018022X1.5M	M4018022X1.5M	•	
22 x 2	B3018022X2M	M4018022X2M	•	
22 x 2.5	B3018022X2.5M	M4018022X2.5M	•	
22 x 3	B3018022X3M	M4018022X3M	•	
25 x 2	B3018025X2M	M4018025X2M	•	
25 x 2.5	B3018028X2.5M	M4018028X2.5M	•	
25 x 3	B3018030X2M	M4018030X2M	•	
25 x 3.5	B3018025X3.5M	M4018025X3.5M	•	
25 x 4	B3018025X4M	M4018025X4M	•	
28 x 2	B3018028X2M	M4018028X2M	•	
28 x 2.5	B3018028X2.5M	M4018028X2.5M	•	
30 x 2	B3018030X2M	M4018030X2M	•	
30 x 3	B3018030X3M	M4018030X3M	•	
30 x 3.5	B3018030X3.5M	M4018030X3.5M	•	
30 x 4	B3018030X4M	M4018030X4M	•	
32 x 3	B3018032X3M	M4018032X3M	•	
32 x 4	B3018032X4M	M4018032X4M	•	
35 x 3	B3018035X3M	M4018035X3M	•	
38 x 3	B3018038X3M	M4018038X3M	•	
38 x 4	B3018038X4M	M4018038X4M	•	
38 x 5	B3018038X5M	M4018038X5M	•	

**Note:** Use “-SS” suffix after part number for flanging tools for stainless steel tube. Contact the Tube Fittings Division for sizes and/or materials not listed, or for additional SS sizes released for limited use.

Table Q11 — Pin & Die Part Numbers for Metric Sizes

All tooling info also available on [www.TFDTOOLSPEC.com](http://www.TFDTOOLSPEC.com)

[Click here for Support Resources or to Configure Parts Online](#)

## Manual Flaring Tool Vise Block and Flaring Pin — Metric Tube

These 37° flaring tools are designed for use in a vise when flaring metric tube from 6mm O.D. to 38mm O.D.

From 20mm size tube and upward it is necessary to use a pre-flaring pin to start the flare.

- **Clamp tube flush in black halves**
- **Flare tube by hammering the flaring pin.**

A separate block and pin set is used for each tube size.

### Pre-Flaring Pins

Tube O.D. (mm)	Part No.
20 .....	P1E
25 .....	P1E
30 .....	P1E
32 .....	P1E
38 .....	P1E

### Flaring Pins

Tube O.D. (mm)	Part No.
6 .....	P17408
8 .....	P17408
10 .....	P17408
12 .....	P17414
14 .....	P17414
15 .....	P17414
16 .....	P17414
18 .....	P17418
20 .....	P17418
25 .....	P17422
30 .....	P17432
32 .....	P17432
38 .....	P17438

### Vise Blocks

Tube O.D. (mm)	Part No.
6 .....	M27406
8 .....	M27408
10 .....	M27410
12 .....	M27412
14 .....	M27414
15 .....	M27415
16 .....	M27416
18 .....	M27418
20 .....	M27420
25 .....	M27425
30 .....	M27430
32 .....	M27432
38 .....	M27438



Fig. Q62 — Vise Block



Fig. Q63 — Pre-Flaring Pins



Fig. Q64 — Flaring Pin

TABLE  
OF  
CONTENTS

VISUAL  
INDEX

FAQs

TOOL  
SPEC.COM

Q

[Click here for Support Resources or to Configure Parts Online](#)

## Rolo-Flair®

### Manual Rotary Flaring Tool

(For soft metal tube)

Precision burnished 37° and 45° flares in tube sizes from 2 (1/8" O.D.) to 12 (3/4" O.D.) with an easy turn of the handle. For use with copper and aluminum alloys. A depth gauge allows proper positioning of tube for consistent flaring.

**HOWTO USE:** Open die, insert tube up to the gauge and clamp the tube in the die. Turn drive handle clockwise to flare, then counterclockwise for retracting flaring cone. Open clamping die by loosening wing nut and remove flared tube.

Part Name	Part No.
Rolo-Flair for 37° flares (for 1/8", 3/16", 1/4", 5/16", 3/8", 1/2", 5/8", 3/4", O.D.)	212FB
Rolo-Flair for 45° flares (for 1/8", 3/16", 1/4", 5/16", 3/8", 1/2", 5/8", 3/4", O.D.)	945TH



Fig. Q65 — Rolo-Flair

TABLE  
OF  
CONTENTS

VISUAL  
INDEX

FAQs

TOOL  
SPEC.COM

**WARNING:** This product can expose you to chemicals including Lead and Lead Compounds which is known to the State of California to cause cancer and birth defects or other reproductive harm. For more information go to [www.p65warnings.ca.gov](http://www.p65warnings.ca.gov).

[Click here for Support Resources or to Configure Parts Online](#)

# Hydra-Tool

## Hydraulic Flaring and Pre-Setting Tool

### Flaring

An efficient dependable device for 37° and 45° flaring of steel, stainless steel and copper tube. This task is made easy through hydraulic power provided by a hand or electric pump. The equipment is portable and easy to use.

This tool accommodates dies for tubes ranging in inch sizes from 4 through 32 (1/4" through 2" outside diameters) with wall thicknesses as great as .134", and metric sizes from 6mm through 50mm. The hydraulic "push" of the Hydra-Tool flares the tube to a 37° flare angle. A gauge can be provided to enable the operator to determine the pressure required to adequately flare any given material and wall thickness of the tube. Complete instructions are included with the Hydra-Tool.

 See bulletin 4390-B10, or view the instructional video online at [discover.parker.com/TFDTubeFabEquipment](http://discover.parker.com/TFDTubeFabEquipment).

See the following for Hydra-Tool basic unit or kit, and choice of power sources and necessary tooling.

**NOTE:** Flaring die sets and other tooling are available in non-standard sizes upon request from the factory.

See Triple-Lok area of Assembly Section for flaring pressures.

### COMPONENTS REQUIRED

Part Name	Part No.
*Hydra-Tool (basic unit) .....	710400B
*Hydra-Tool Male Adapter .....	6-8 F5OLO-S
**"T" Adapter for Gauge .....	6 R6LO-S
*Hose Assembly (for hand or electric pumps) .....	910004
*Adapter for Gauge.....	6 G6L-S
*Pressure Gauge (0 - 10,000 psi).....	900044**
Electric Hydraulic Pump (10,000 psi; 1/2 hp; 40-125 volt) .....	900085
Hand Hydraulic Pump (10,000 psi; 2 speed) .....	900086
Die Ring (1/4" - 1 1/4") (6mm - 32mm) .....	710416A
Die Ring (1 1/2" - 2") (35mm - 50mm) .....	710412
37° Flaring Cone (1/4" - 1 1/4") (6mm - 32mm) .....	710419
37° Flaring Cone (1 1/2" - 2") (35mm - 50mm) .....	710411
Die Retainer Assembly (1/4" - 1 1/4") (6mm - 32mm).....	710424-1
Die Retainer Assembly (1 1/2" - 2") (35mm - 50mm).....	710424-2
Flaring Die Sets .....	See pages Q34 - Q35
45° Flaring Cone (1/4" - 1").....	910312

\*Included in Hydra-tool kit (Part 720370B-3)

STP Lubricant is the only lubricant recommended for use with Hydra-Tool.

### Hydra-Tool Kit

Part Name	Part No.
Hydra-Tool Kit (for use with electric or hand pump).....	720370B-3
Includes basic unit, gauge adapter, Hydra-Tool connector, lubricant, "T" adapter, carrying case, hose assembly, pressure gauge, p/n 900044, and operation manual.	

 **WARNING:** This product can expose you to chemicals including Lead and Lead Compounds which is known to the State of California to cause cancer and birth defects or other reproductive harm. For more information go to [www.p65warnings.ca.gov](http://www.p65warnings.ca.gov).

TABLE  
OF  
CONTENTS

VISUAL  
INDEX

FAQs

TOOL  
SPEC.COM



Fig. Q66 — Hydra-Tool



Fig. Q67 — Electric Pump



Fig. Q68 — Hand Pump



Fig. Q69 — Flaring Cone



Fig. Q70 — Die Ring



Fig. Q71 — Die Retainer



Fig. Q72 — Hydra-Tool Kit

Q

## Hydra-Tool 37° Flaring Die Sets for Steel – Inch

Size	Tube O.D. (in.)	Part No.
4	1/4	710417-4
5	5/16	710417-5
6	3/8	710417-6
8	1/2	710417-8
10	5/8	710417-10
12	3/4	710417-12
14	7/8	710417-14
16	1	710417-16
20	1 1/4	710417-20
24	1 1/2	710415-24
32	2	710415-32



Fig. Q73 — Flaring Die Set

TABLE  
OF  
CONTENTS

VISUAL  
INDEX

FAQs

TOOL  
SPEC.COM

## Hydra-Tool 37° Flaring Die Sets for Stainless Steel – Inch

Size	Tube O.D. (in.)	Part No.
4	1/4	710417-4 SS
5	5/16	710417-5 SS*
6	3/8	710417-6 SS
8	1/2	710417-8 SS
10	5/8	710417-10 SS
12	3/4	710417-12 SS
14	7/8	710417-14 SS*
16	1	710417-16 SS
20	1 1/4	710417-20 SS
24	1 1/2	710415-24 SS
32	2	710415-32 SS

\* Non-standard.

## Hydra-Tool 37° Flaring Die Sets – Metric

Tube O.D./ Size (mm)	Part No.
6	770106-6
8	770106-8
10	770106-10
12	770106-12
14	770106-14
15	770106-15
16	770106-16
18	770106-18
20	770106-20
22	770106-22
25	770106-25
28	770106-28
30	770106-30
32	770106-32
35	770095-35
38	770095-38
42	770095-42
50	770095-50



[Click here for Support Resources or to Configure Parts Online](#)

## Hydra-Tool 45° Flaring Die Sets – Inch

TABLE  
 OF  
 CONTENTS

VISUAL  
 INDEX

FAQs

TOOL  
 SPEC.COM

Size	Tube O.D. (in.)	Part No.
4	1/4 .....	977420-4
6	3/8 .....	977420-6
8	1/2 .....	977420-8
10	5/8 .....	977420-10
12	3/4 .....	977420-12
14	7/8 .....	977420-14
16	1 .....	977420-16

### REPLACEMENT PART

Part Name	Part No.
Tube Stop Assembly .....	710420B

### OPTIONAL ACCESSORIES

Part Name	Part No.
Hydra-Tool Carrying Case .....	720377
Sturdy wood case for Hydra-Tool and tooling. (Hydra-Tool Kit is shipped in this carrying case.)	



Fig. Q74 — Carrying Case

**WARNING:** This product can expose you to chemicals including Lead and Lead Compounds which is known to the State of California to cause cancer and birth defects or other reproductive harm. For more information go to [www.p65warnings.ca.gov](http://www.p65warnings.ca.gov).

Q

## Karryflare Portable Flaring Machine

The Karryfare is a portable flaring machine that is designed for fabricating 37 degree tube flares. It's lightweight, portable, and is capable of flaring 1/4" through 1-1/2" (6mm-38mm) steel & stainless steel tubing. It's telescopic handle and wheeled carrying case allows it to be easily transported from one work site location to another.

**Part Name** ..... **Part No.**  
Karry Flare ..... KarryFlare

Hydraulic power is generated by a hand operated pump. A pressure gauge is provided which enables the operator to review the necessary pressure requirements for proper flaring of their specific tubing requirements (operating pressures are specific to the tubes O.D. and wall thickness). The complete unit is mounted on a wheeled base plate, with telescopic handle, and includes 37° cone and case cover.

**Dimensions:** H – 10" W – 14" L – 30"

### Application range

The Karryflare machine is capable of flaring tube from 1/4" O.D. to 1 1/2" O.D. or from 6mm O.D. to 38mm O.D.

### FLARING COMPONENTS

**Part Name** ..... **Part No.**  
Replacement 37° Flaring Cone ..... Karryflare/FPIN  
37° Flaring Die Sets ..... See below

### Tube Die Sets – Inch

Tube O.D. (in.)	Part No.
1/4 .....	M047415-1
5/16 .....	M157408-1
3/8 .....	M067415-1
1/2 .....	M087415
5/8 .....	M107415
3/4 .....	M127415
1 .....	M167415
1 1/4 .....	M207415
1 1/2 .....	M157438

### Tube Die Sets – Metric

Tube O.D. (mm)	Part No.
6 .....	M157406-1
8 .....	M157408-1
10 .....	M157410-1
12 .....	M157412
14 .....	M157414
15 .....	M157415
16 .....	M157416
18 .....	M157418
20 .....	M157420
22 .....	M157422
25 .....	M157425
30 .....	M157430
32 .....	M157432
38 .....	M157438

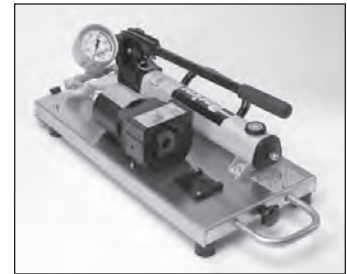

Fig. Q75 — KarryFlare



Fig. Q76— Flaring Die Set

TABLE  
OF  
CONTENTS

VISUAL  
INDEX

FAQs

TOOL  
SPEC.COM

[Click here for Support Resources or to Configure Parts Online](#)

# Inch and Metric Flaring Tooling for 1025

## Parflange® 1025 37° Flaring and Flanging Systems

Parker's Parflange 1025 machine is designed to create 37° flared tube ends. For more detailed information on the machine and part numbers, refer to page Q23.



Fig. Q77 — Parflange 1025

TABLE  
OF  
CONTENTS

VISUAL  
INDEX

FAQs

TOOL  
SPEC.COM

Tube Size O.D. x Wall Thickness (in.)	Tooling for 37°/74° Tube Flaring		Available Flaring Tooling
	Pin	Die	
	Part Number	Part Number	1025
1/4 x .020	B4004X020074	M4004074	•
1/4 x .028	B4004X028074	M4004074	•
1/4 x .035	B4004X035074	M4004074	•
1/4 x .049	B4004X049074	M4004074	•
1/4 x .065	B4004X065074	M4004074	•
3/8 x .020	B4006X020074	M4006074	•
3/8 x .028	B4006X028074	M4006074	•
3/8 x .035	B4006X035074	M4006074	•
3/8 x .049	B4006X049074	M4006074	•
3/8 x .065	B4006X065074	M4006074	•
1/2 x .028	B4008X028074	M4008074	•
1/2 x .035	B4008X035074	M4008074	•
1/2 x .049	B4008X049074	M4008074	•
1/2 x .065	B4008X065074	M4008074	•
1/2 x .083	B4008X083074	M4008074	•
5/8 x .035	B4010X035074	M4010074	•
5/8 x .049	B4010X049074	M4010074	•
5/8 x .065	B4010X065074	M4010074	•
5/8 x .083	B4010X083074	M4010074	•
5/8 x .095	B4010X095074	M4010074	•
3/4 x .035	B4012X035074	M4012074	•
3/4 x .049	B4012X049074	M4012074	•
3/4 x .065	B4012X065074	M4012074	•
3/4 x .083	B4012X083074	M4012074	•
3/4 x .095	B4012X095074	M4012074	•
3/4 x .109	B4012X109074	M4012074	•
1 x .035	B4016X035074	M4016074	•
1 x .049	B4016X049074	M4016074	•
1 x .065	B4016X065074	M4016074	•
1 x .083	B4016X083074	M4016074	•
1 x .095	B4016X095074	M4016074	•
1 x .109	B4016X109074	M4016074	•
1 x .120	B4016X120074	M4016074	•
1 1/4 x .049	B4020X049074	M4020074	•
1 1/4 x .065	B4020X065074	M4020074	•
1 1/4 x .083	B4020X083074	M4020074	•
1 1/4 x .095	B4020X095074	M4020074	•
1 1/4 x .109	B4020X109074	M4020074	•
1 1/4 x .120	B4020X120074	M4020074	•
1 1/2 x .065	B4024X065074	M4024074	•
1 1/2 x .083	B4024X083074	M4024074	•
1 1/2 x .095	B4024X095074	M4024074	•
1 1/2 x .109	B4024X109074	M4024074	•
1 1/2 x .120	B4024X120074	M4024074	•

Table Q12 — Parflange Flaring Tooling for Inch Sizes

Tooling suitable for 37°/74° flaring of steel, stainless steel, aluminum, monel, copper, and cupro-nickel tube materials. For 37°/74° flaring, one die covers each tube O.D.; a different pin is required for each tube wall. Setscrews in flaring dies may require slight adjustment for different tube materials and/or tube walls.

Tube Size O.D. x Wall Thickness (mm)	Tooling for 37°/74° Tube Flaring		Available Flaring Tooling
	Pin	Die	
	Part Number	Part Number	1025
6 x 1	B3007406X1M	M4007406M	•
6 x 1.5	B3007406X1.5M	M4007406M	•
8 x 1	B3007408X1M	M4007408M	•
8 x 1.5	B3007408X1.5M	M4007408M	•
10 x 1	B3007410X1M	M4007410M	•
10 x 1.5	B3007410X1.5M	M4007410M	•
12 x 1.5	B3007412X1.5M	M4007412M	•
12 x 2	B3007412X2M	M4007412M	•
15 x 1.5	B3007415X1.5M	M4007415M	•
15 x 2	B3007415X2M	M4007415M	•
16 x 1.5	B3007416X1.5M	M4007416M	•
16 x 2	B3007416X2M	M4007416M	•
18 x 2	B3007418X2M	M4007418M	•
20 x 2	B3007420X2M	M4007420M	•
20 x 2.5	B3007420X2.5M	M4007420M	•
25 x 2	B3007425X2M	M4007425M	•
25 x 2.5	B3007425X2.5M	M4007425M	•
25 x 3	B3007425X3M	M4007425M	•
30 x 2.5	B3007430X2.5M	M4007430M	•
30 x 3	B3007430X3M	M4007430M	•
32 x 3	B3007432X3M	M4007432M	•
38 x 3	B3007438X3M	M4007438M	•
38 x 4	B3007438X4M	M4007438M	•

Table Q13 — Parflange Flaring Tooling for Metric Sizes

Tooling suitable for 37°/74° flaring of steel, stainless steel, aluminum, monel, copper, and cupro-nickel tube materials. Apply LB 2000 lube to flaring pin. Setscrews in flaring dies may require slight adjustment for different tube materials and/or tube walls.



Fig. Q78 — Flaring Pin



Fig. Q79 — Flaring Die

Q

# Inch Flaring Tooling for ECO25

## Parflange® ECO25 37° Flaring and Flanging Systems

Parker's Parflange ECO25 machine is designed to create 37° flared tube ends. For more detailed information on the machine and part numbers, refer to page Q25.

Fitting Dash Size	Tube O.D. (in.)	Die Set Part Number
4	1/4	M2504
6	3/8	M2506
8	1/2	M2508
10	5/8	M2510
12	3/4	M2512
16	1	M2516
20	1 1/4	M2520
24	1 1/2	M2524

Table Q14 — Flaring Die Set, Inch Sizes

Tube O.D. (in.)	Wall Thickness (in.)	Flaring Pin Part Number
1/4	0.028	B4004X028074
1/4	0.035	B4004X035074
1/4	0.049	B4004X049074
1/4	0.065	B4004X065074
3/8	0.020	B4006X020074
3/8	0.028	B4006X028074
3/8	0.035	B4006X035074
3/8	0.049	B4006X049074
3/8	0.065	B4006X065074
1/2	0.028	B4008X028074
1/2	0.035	B4008X035074
1/2	0.049	B4008X049074
1/2	0.065	B4008X065074
1/2	0.083	B4008X083074
5/8	0.035	B4010X035074
5/8	0.049	B4010X049074
5/8	0.065	B4010X065074
5/8	0.083	B4010X083074
5/8	0.095	B4010X095074
3/4	0.035	B4012X035074
3/4	0.049	B4012X049074
3/4	0.065	B4012X065074
3/4	0.083	B4012X083074
3/4	0.095	B4012X095074
3/4	0.109	B4012X109074
1	0.035	B4016X035074
1	0.049	B4016X049074
1	0.065	B4016X065074
1	0.083	B4016X083074
1	0.095	B4016X095074
1	0.109	B4016X109074
1	0.120	B4016X120074
1 1/4	0.049	B4020X049074
1 1/4	0.065	B4020X065074
1 1/4	0.095	B4020X095074
1 1/4	0.109	B4020X109074
1 1/4	0.120	B4020X120074
1 1/2	0.065	B4024X065074
1 1/2	0.083	B4024X083074
1 1/2	0.095	B4024X095074
1 1/2	0.109	B4024X109074
1 1/2	0.120	B4024X120074

Table Q15 — Flaring Pin, Inch Sizes



Fig. Q80 — Parflange ECO25



Fig. Q81 — Flaring Pin



Fig. Q82 — Dual Function Die Set (Flaring and Flanging)

TABLE OF CONTENTS

VISUAL INDEX

FAQs

TOOL SPEC.COM

[Click here for Support Resources or to Configure Parts Online](#)

## SAE Straight Thread Port Tapping Tools\*

Taps are available for SAE J1926-1 female straight thread ports in sizes 2 through 32. Taps are bottoming type and made from high speed tool steel.

SAE Dash Size	Overall Length (in.)	Shank Dia. (in.)	Wrench Flat Size (in.)	Part No.
2	2 23/32	0.318	0.238.....	5/16X24 UNF-2B
3	2 15/16	0.381	0.286.....	3/8X24 UNF-2B
4	3 5/16	0.323	0.242.....	7/16X20 UNF-2B
5	3 3/8	0.367	0.275.....	1/2X20 UNF-2B
6	3 19/32	0.429	0.322.....	9/16X18 UNF-2B
8	4 1/4	0.590	0.442.....	3/4X16 UNF-2B
10	4 11/16	0.697	0.523.....	7/8X14 UNF-2B
12	5 1/8	0.896	0.672.....	1 1/16X12 UNF-2B
14	5 7/16	1.021	0.766.....	1 3/16X12 UNF-2B
16	5 3/4	1.108	0.831.....	1 5/16X12 UNF-2B
20	6 11/16	1.305	0.979.....	1 5/8X12 UNF-2B
24	7 5/16	1.519	1.139.....	1 7/8X12 UNF-2B
32	8 3/4	2.100	1.575.....	2 1/2X12 UNF-2B



Fig. Q83 — SAE Straight Thread Port Tapping Tool

TABLE OF CONTENTS

VISUAL INDEX

FAQs

TOOL SPEC.COM

## SAE Straight Thread Port Counterboring Tools\*

Parker offers counterboring tools for SAE J1926-1 female straight thread ports in sizes 2 through 32. Counterbores are 4-fluted high speed tool steel.

SAE Dash Size	Shank Dia. (in.)	Shank Length (in.)	Overall Length (in.)	Recommended Pilot Drill or Bore Size (in.)	Part No.
2	1/2	1 1/2	2 1/2	0.266 .....	Y-34730
3	1/2	1 1/2	2 1/2	0.328 .....	Y-34731
4	1/2	1 1/2	2 41/64	0.377 .....	Y-34732
5	1/2	1 1/2	2 41/64	0.438 .....	Y-34733
6	3/4	1 1/2	2 47/64	0.500 .....	Y-34734
8	3/4	1 1/2	2 53/64	0.672 .....	Y-34735
10	1	2	3 29/64	0.797 .....	Y-34736
12	1	2	3 19/32	0.969 .....	Y-34737
14	1	2	3 41/64	1.095 .....	Y-34738
16	1	2	3 41/64	1.220 .....	Y-34739
20	1 1/2	2	3 37/64	1.530 .....	Y-34740
24	1 1/2	2	3 37/64	1.780 .....	Y-34741
32	1 1/2	2	3 49/64	2.405 .....	Y-34743



Fig. Q84 — SAE Straight Thread Port Counterboring Tool

Q

\* See General Technical for recommended use of port tools.



[Click here for Support Resources or to Configure Parts Online](#)

## BSPP Straight Thread Port Counterboring Tools\*

Parker offers counterboring/spotfacing tools for DIN 3852-2 female straight thread port connections in sizes 1/8" through 1-1/2". Counterbores are carbide tipped.

SAE Dash Size	Overall Length (in.)	Shank Dia. (in.)	Wrench Flat Size (in.)	Part No.
2	2 23/32	0.318	0.238.....	5/16X24 UNF-2B
3	2 15/16	0.381	0.286.....	3/8X24 UNF-2B
4	3 5/16	0.323	0.242.....	7/16X20 UNF-2B
5	3 3/8	0.367	0.275.....	1/2X20 UNF-2B
6	3 19/32	0.429	0.322.....	9/16X18 UNF-2B
8	4 1/4	0.590	0.442.....	3/4X16 UNF-2B
10	4 11/16	0.697	0.523.....	7/8X14 UNF-2B
12	5 1/8	0.896	0.672.....	1 1/16X12 UNF-2B
14	5 7/16	1.021	0.766.....	1 3/16X12 UNF-2B
16	5 3/4	1.108	0.831.....	1 5/16X12 UNF-2B
20	6 11/16	1.305	0.979.....	1 5/8X12 UNF-2B
24	7 5/16	1.519	1.139.....	1 7/8X12 UNF-2B
32	8 3/4	2.100	1.575.....	2 1/2X12 UNF-2B

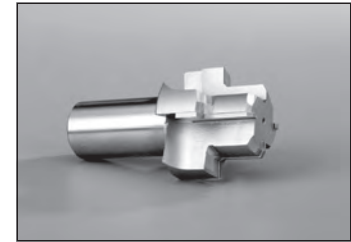

Fig. Q85 — BSPP Straight Thread Port Counterboring Tool

TABLE OF CONTENTS

VISUAL INDEX

FAQs

TOOL SPEC.COM

## BSPP Straight Thread Tapping Tools\*

BSPP taps are available for ISO 228-1 threaded connections in sizes 1/8" through 1 1/2". All taps are bottoming type manufactured from high speed steel.

Shank Dia. (in.)	Shank Length (in.)	Overall Length (in.)	Recommended Pilot Drill or Bore Size (in.)	Part No.
G1/8	1/2	1 1/2	0.332 .....	974094-G1/8
G1/4	1/2	1 1/2	0.438 .....	974094-G1/4
G3/8	3/4	1 1/2	0.578 .....	974094-G3/8
G1/2	3/4	2	0.728 .....	974094-G1/2
G3/4	1	2	0.938 .....	974094-G3/4
G1	1	2	1.181 .....	974094-G1
G1-1/4	1 1/2	2	1.531 .....	974094-G1-1/4
G1-1/2	1 1/2	2	1.750 .....	974094-G1-1/2

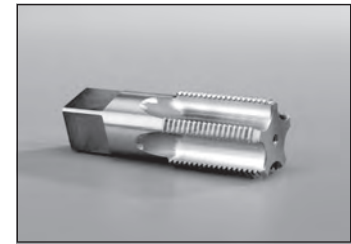

Fig. Q86 — BSPP Straight Thread Tapping Tool

## BSPT Taper Pipe Thread Tapping Tools\*

BSPT taps are available for ISO 7-1 taper thread connections in sizes 1/8" through 1 1/2". All taps are bottoming type manufactured from high speed steel.

Size	Shank Dia. (in.)	Overall Length (in.)	Thread Size	Part No.
R1/8	0.438	2 1/8	1/8-28.....	974243-R1/8
R1/4	0.563	2 7/16	1/4-19.....	974243-R1/4
R3/8	0.700	2 9/16	3/8-19.....	974243-R3/8
R1/2	0.688	3 1/8	1/2-14.....	974243-R1/2
R3/4	0.906	3 1/4	3/4-14.....	974243-R3/4
R1	1.125	3 3/4	1-11.....	974243-R1
R1-1/4	1.313	4	1 1/4-11.....	974243-R1-1/4
R1-1/2	1.500	4 1/4	1 1/2-11.....	974243-R1-1/2

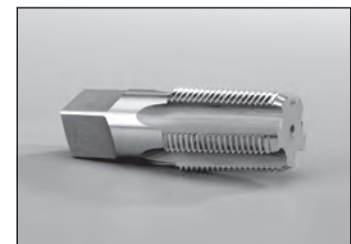

Fig. Q87 — BSPT Taper Pipe Thread Tapping Tool

\* See General Technical for recommended use of port tools.

[Click here for Support Resources or to Configure Parts Online](#)

### NPTF Thread Tapping Tools\*

NPTF taps are available for taper pipe thread connections in sizes 1/8" through 1 1/2". All taps are bottoming type manufactured from high speed steel.

Shank Dia. (in.)	Overall Length (in.)	Thread Size	Part No.
0.438	2 1/8	1/8-27	974244-1/8
0.563	2 7/16	1/4-18	974244-1/4
0.700	2 9/16	3/8-18	974244-3/8
0.688	3 1/8	1/2-14	974244-1/2
0.906	3 1/4	3/4-14	974244-3/4
1.125	3 3/4	1-11 1/2	974244-1
1.313	4	1 1/4-11 1/2	974244-1-1/4
1.500	4 1/4	1 1/2-11 1/2	974244-1-1/2

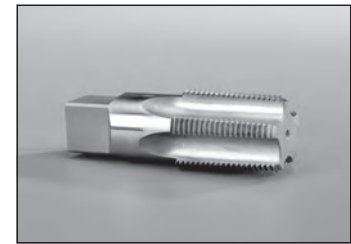

Fig. Q88 — NPTF Port Tap

TABLE OF CONTENTS

VISUAL INDEX

FAQs

TOOL SPEC.COM

### ISO 6149-1 Straight Thread Port Tapping Tools\*

ISO 6149-1 female straight thread port taps are available for M8 to M48 port sizes. Taps are bottoming type and made from high speed steel.

Overall Length (in.)	Shank Dia. (in.)	Wrench Flat Size (in.)	Thread Size	Part No.
2 23/32	0.318	0.238	M8x1	M8X1 D5 2FL
2 15/16	0.381	0.286	M10x1	M10X1-6H
3 3/8	0.367	0.275	M12x1.5	M12X1.5-6H TAP
3 19/32	0.429	0.322	M14x1.5	M14X1.5-6H-TAP
3 13/16	0.400	0.360	M16x1.5	M16X1.5-6H-TAP
4 1/32	0.542	0.406	M18x1.5	M18X1.5-6H-TAP
4 11/16	0.697	0.523	M22x1.5	M22X1.5-6H-TAP
5 1/8	0.896	0.672	M27x2	M27X2-6H-TAP
5 3/4	1.108	0.831	M33x2	M33X2-6H-TAP
7	1.430	1.072	M42x2	M42X2-6H-TAP
7 5/8	1.644	1.233	M48x2	M48X2-6H-TAP



Fig. Q89 — ISO 6149-1 Straight Thread Port Tap

Q

\* See General Technical for recommended use of port tools.

[Click here for Support Resources or to Configure Parts Online](#)

## ISO 6149-1 Straight Thread Port Counterboring Tools — Small Spotface\*

ISO 6149-1 female straight thread port counterboring tools are available with small spotface for M8 to M48 port sizes. Counterbores are 4-fluted\*, carbide-tipped.

Shank Dia. (in.)	Shank Length (in.)	Overall Length (in.)	Recommended Pilot Drill or Bore Size (in.)	Use with Thread Size	Part No.
1/2	2	4 1/8	0.272	M8x1* .....	R1449B
1/2	2	4 1/8	0.348	M10x1* .....	R1450B
1/2	2	4 1/8	0.406	M12x1.5 .....	R 1451B-S
1/2	2	4 1/8	0.484	M14x1.5 .....	R 1452B-S
1/2	2	4 1/8	0.563	M16x1.5 .....	R 1453B-S
1/2	2	4 1/8	0.641	M18x1.5 .....	R 1454B-S
1/2	2	4 1/8	0.797	M22x1.5 .....	R 1455B-S
3/4	2 1/2	5	0.969	M27x2.....	R 1456B-S
3/4	2 1/2	5	1.210	M33x2.....	R 1457B-S
3/4	2 1/2	5	1.565	M42x2.....	R 1458B-S
3/4	2 1/2	5	1.801	M48x2 .....	R1459B

\* M8 and M10 are 3-fluted

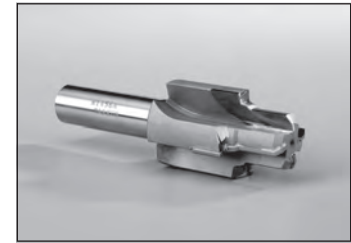

Fig. Q90 — ISO 6149-1 Straight Thread Port Counterboring Tool — Small Spotface

## ISO 6149-1 Straight Thread Port Counterboring Tools with ID Groove\*

ISO 6149-1 female straight thread port counterboring tools are available with identification groove for M8 to M48 port sizes. Counterbores are 4-fluted\*, carbide-tipped.

Shank Dia. (in.)	Shank Length (in.)	Overall Length (in.)	Recommended Pilot Drill or Bore Size (in.)	Use with Thread Size	Part No.
1/2	2	4 1/8	0.348	M10x1* .....	R1450A
1/2	2	4 1/8	0.406	M12x1.5 .....	R1451A
1/2	2	4 1/8	0.484	M14x1.5 .....	R1452A
1/2	2	4 1/8	0.563	M16x1.5 .....	R1453A
1/2	2	4 1/8	0.641	M18x1.5 .....	R1454A
1/2	2	4 1/8	0.797	M22x1.5 .....	R1455A
3/4	2 1/2	5	0.969	M27x2.....	R1456A
3/4	2 1/2	5	1.210	M33x2.....	R1457A

\* M10 are 3-fluted

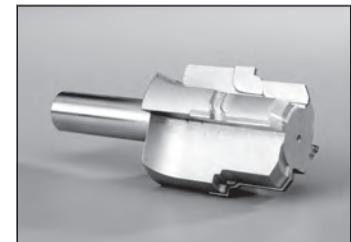

Fig. Q91 — ISO 6149-1 Straight Thread Port Counterboring Tool with ID Groove

**WARNING:** This product can expose you to chemicals including Lead and Lead Compounds which is known to the State of California to cause cancer and birth defects or other reproductive harm. For more information go to [www.p65warnings.ca.gov](http://www.p65warnings.ca.gov).

\* See General Technical for recommended use of port tools.

TABLE OF CONTENTS

VISUAL INDEX

FAQs

TOOL SPEC.COM

[Click here for Support Resources or to Configure Parts Online](#)

## Ferulset® Pre-Setting Tool

For Ferulok® flareless tube fittings.

Ferulset provides a fast and easy way to manually pre-set the ferrule onto steel and stainless steel tube with the famous Ferulok “bite.” Ferulset bodies are manufactured from hardened steel for withstanding repeated pre-sets. A separate tool is required for each size tube; size 2 (1/8” O.D.) through size 32 (2” O.D.).

**HOW TO USE:** Lubricate threads on tool, threads on nut, as well as tail and lead ends of ferrule with a suitable lubricant such as STP. Insert tube end with ferrule into tool until it bottoms against shoulder and thread the nut down until finger tight. Light wrenching may be required to get to a consistent starting position, especially with larger sizes. Hold tube steady against internal shoulder and tighten nut 1-3/4 turns. Loosen nut and inspect bite using inspection criteria outlined for Ferulok in the Assembly / Installation section.



Fig. Q92 — Ferulset®

TABLE  
OF  
CONTENTS

VISUAL  
INDEX

FAQs

TOOL  
SPEC.COM

Size	Tube O.D. (in.)	Part No.
2	1/8	560576
3	3/16	560577
4	1/4	560578
5	5/16	560579
6	3/8	560580
8	1/2	560581
10	5/8	560582
12	3/4	560583
14	7/8	560584
16	1	560585
20	1 1/4	560586
24	1 1/2	560587
32	2	560589

[Click here for Support Resources or to Configure Parts Online](#)

## VOMO Pre-Assembly Bodies

### For EO and EO-2 Flareless Metric Tube Fittings

VOMO tools are made of hardened tool-steel, for standard assembly of steel fittings, stainless steel fittings and hose standpipes (BE).

Refer to the EO/EO2 Assembly and Installation section for use information (page R35).

**NOTE:** It is strongly recommended that a hydraulic tool be used to preset EO and EO-2 fittings in sizes 30S, 35L, 38S and 42L.



Fig. Q93 — VOMO Pre-Assembly Tool

Series	Tube O.D. (mm)	Part No.
LL	4	VOMO04LLX
LL	6	VOMO06LLX
LL	8	VOMO08LLX
LL	10	VOMO10LLX
LL	12	VOMO12LLX
L	6	VOMO06LX
L	8	VOMO08LX
L	10	VOMO10LX
L	12	VOMO12LX
L	15	VOMO15LX
L	18	VOMO18LX
L	22	VOMO22LX
L	28	VOMO28LX
L	35	VOMO35LX
L	42	VOMO42LX
S	6	VOMO06SX
S	8	VOMO08SX
S	10	VOMO10SX
S	12	VOMO12SX
S	14	VOMO14SX
S	16	VOMO16SX
S	20	VOMO20SX
S	25	VOMO25SX
S	30	VOMO30SX
S	38	VOMO38SX

TABLE OF CONTENTS

VISUAL INDEX

FAQs

TOOL SPEC.COM



[Click here for Support Resources or to Configure Parts Online](#)

## Hyferset

Parker Hydraulic Ferrule Pre-Setting Tool for Ferulok® Fittings and EO/EO-2 Metric Fittings

PORTABLE...EFFICIENT...EASY TO USE

The Hyferset is an efficient, dependable device for pre-setting Parker ferrules on tube of steel and stainless steel. This task is made easy through hydraulic power provided by a hand or electric pump. The equipment is portable, and has an optional sturdy wood carrying case.

In hydraulic pre-setting, little physical strength is required by the operator to set ferrules properly. Although the amount of force needed increases as the ferrule size increases, the pressure can be easily achieved.

This tool accommodates pre-setting dies for tubes ranging in size from 4 through 32 (1/4" through 2" outside diameter) and 6mm to 28mm O.D. metric sizes. The tube, with tube nut and ferrule, is positioned in the die. The hydraulic "push" of the Hyferset pre-sets the ferrule onto the tube — producing a visible ridge of metal, in front of the sleeve bite edge, that can be easily inspected.

### Positive Stop Body Dies (For Ferulok Fittings Only)

The positive stop body die design eliminates the need for predetermined relief valve settings, pressure gauges or chart reading. Positive stop feature allows for uniform assemblies to be made on tube from 1/4" thru 2". One set of dies can be used on both steel and stainless steel tube. When used in conjunction with the Ferulok visible bite ferrules, the entire system is the most reliable method available for assembling a fitting to a piece of tube.

See Assembly for pre-setting pressures for EO and EO-2 steel fittings.

**You will find instructions for proper use in the 4393-B1 user manual.**

 **Instructional video is available at [discover.parker.com/TFDTubeFabEquipment](http://discover.parker.com/TFDTubeFabEquipment).**

### COMPONENTS REQUIRED

Part Name	Part No.
*Hyferset (basic unit, no accessories) .....	611011A
*Hyferset Adapter .....	6 FLO-S
Gauge "T" Adapter .....	6 R6LO-S
*Hose Assembly .....	910004
Gauge Swivel Adapter .....	6 G6L-S
Pressure Gauge (0 - 10,000 psi) .....	900044
*Hand pump (10,000 psi, 2 speed) .....	900086
Electric pump (10,000 psi, 1/2 HP, 40-125 volt) .....	900085
Nut die set (1/4" to 2" O.D.) .....	See page Q46
Positive Stop body die (1/4" to 2" O.D.) .....	See page Q46
Nut Die Set (6mm to 28mm) .....	See page Q47
Body Die (6mm to 28mm) .....	See page Q47

\* Included in Hyferset Kit

Part Name	Part No.
Hyferset Kit .....	611049C
Includes basic unit, hand hydraulic pump, hose assembly, 1 adapter (6 FLO-S), wooden carrying case, and operation manual.	

 **WARNING:** This product can expose you to chemicals including Lead and Lead Compounds which is known to the State of California to cause cancer and birth defects or other reproductive harm. For more information go to [www.p65warnings.ca.gov](http://www.p65warnings.ca.gov).



Fig. Q94 — Hyferset



Fig. Q95 — Electric Pump



Fig. Q96 — Hand Pump



Fig. Q97 — Hyferset Kit

TABLE  
OF  
CONTENTS

VISUAL  
INDEX

FAQs

TOOL  
SPEC.COM

Q

[Click here for Support Resources or to Configure Parts Online](#)

**OPTIONAL ACCESSORIES**

Part Name	Part No.
Wooden carrying case.....	651085



Fig. Q98 — Hyferset Wood Carrying Case

**Hyferset Body Dies for Ferulok Fittings**

Size	Tube O.D. (in.)	Part No.
4	1/4 .....	720105-4
6	3/8 .....	720105-6
8	1/2 .....	720105-8
10	5/8 .....	720105-10
12	3/4 .....	720105-12
14	7/8 .....	720105-14
16	1 .....	720105-16
20	1 1/4 .....	720105-20
24	1 1/2 .....	720105-24
32	2 .....	720105-32



Fig. Q99 — Body Die

**Hyferset Nut Dies for Ferulok Fittings**

Size	Tube O.D. (in.)	Part No.
4	1/4 .....	680370-4
6	3/8 .....	680370-6
8	1/2 .....	680370-8
10	5/8 .....	680370-10
12	3/4 .....	680370-12
14	7/8 .....	680370-14
16	1 .....	680370-16
20	1 1/4 .....	680370-20
24	1 1/2 .....	680370-24
32	2 .....	680370-32



Fig. Q100 — Nut Die

TABLE  
OF  
CONTENTS

VISUAL  
INDEX

FAQs

TOOL  
SPEC.COM

[Click here for Support Resources or to Configure Parts Online](#)

## Hyferset Body Dies for EO / EO-2 Fittings

Series	Tube O.D. Size (mm)	Part No.
L	6.....	910290-6L
L	8.....	910290-8L
L	10.....	910290-10L
L	12.....	910290-12L
L	15.....	910290-15L
L	18.....	910290-18L
L	22.....	910290-22L
L	28.....	910290-28L
S	6.....	910289-6S
S	8.....	910289-8S
S	10.....	910289-10S
S	12.....	910289-12S
S	14.....	910289-14S
S	16.....	910289-16S
S	20.....	910289-20S
S	25.....	910289-25S



Fig. Q101 — Body Die

TABLE  
OF  
CONTENTS

VISUAL  
INDEX

FAQs

TOOL  
SPEC.COM

## Hyferset Nut Dies for EO / EO-2 Fittings

Tube O.D. Size (mm)	Part No.
6.....	910291-6 mm
8.....	910291-8 mm
10.....	910291-10 mm
12.....	910291-12 mm
14.....	910291-14 mm
15.....	910291-15 mm
16.....	910291-16 mm
18.....	910291-18 mm
20.....	910291-20 mm
22.....	910291-22 mm
25.....	910291-25 mm
28.....	910291-28 mm



Fig. Q102 — Nut Die

Q

[Click here for Support Resources or to Configure Parts Online](#)

# Hydra-Tool

## Pre-Setting Components

### COMPONENTS REQUIRED

Part Name	Part No.
*Hydra-Tool (basic unit) (Fig. Q102) .....	710400B
Hand pump (10,000 psi, 2 speed) .....	900086
Electric pump (10,000 PSI, 1/2 HP, 40-125 volt) .....	900085
*Hose Assembly .....	910004
Back-up Plate (sizes -4 to -32 and 6mm to 28mm) .....	770102
Back-up Plate (sizes 30 to 42mm).....	See page Q49
Ram Insert (sizes -4 to -32).....	770101
Small Ram Insert (EO & EO-2 only).....	971108
Large Piston Stop Adapter (EO & EO-2 only) .....	971107
Nut die set (1/4" to 2" O.D.).....	See below
Positive Stop body die (1/4" to 2" O.D.).....	See below
Nut Die Set (6mm to 42mm).....	See page Q49
Body Die (6mm to 42mm).....	See page Q49
*Pressure Gauge (0 - 10,000 psi).....	900044**
*Male Adapter.....	6-8 F5OLO-S
*Adapter.....	6 G6L-S
*Hydra-Tool Gauge Adapter .....	6 R6LO-S

\* Included in Kit

STP lubricant is the only lubricant recommended for use with the Hydra-Tool.

See Assembly for pre-setting pressures.

 **Instructional video is available at [discover.parker.com/TFDTubeFabEquipment](http://discover.parker.com/TFDTubeFabEquipment).**

**See the Hydra-Tool 4392-B10 manual.**

## Hydra-Tool Kit

Part Name	Part No.
Hydra-Tool Kit (for use with electric or hand pump).....	720370B-3
Includes basic unit, gauge adapter, Hydra-Tool connector, lubricant, "T" adapter, carrying case, hose assembly, pressure gauge, p/n 900044, and operation manual.	

## Hydra-Tool Body Dies for Ferulok Fittings

Size	Tube O.D. (in.)	Part No.
4	1/4	720105-4
6	3/8	720105-6
8	1/2	720105-8
10	5/8	720105-10
12	3/4	720105-12
14	7/8	720105-14
16	1	720105-16
20	1 1/4	720105-20
24	1 1/2	720105-24
32	2	720105-32

## Hydra-Tool Nut Dies for Ferulok Fittings

Size	Tube O.D. (in.)	Part No.
4	1/4	680370-4
6	3/8	680370-6
8	1/2	680370-8
10	5/8	680370-10
12	3/4	680370-12
14	7/8	680370-14
16	1	680370-16
20	1 1/4	680370-20
24	1 1/2	680370-24
32	2	680370-32

**WARNING:** This product can expose you to chemicals including Lead and Lead Compounds which is known to the State of California to cause cancer and birth defects or other reproductive harm. For more information go to [www.p65warnings.ca.gov](http://www.p65warnings.ca.gov).



Fig. Q103 — Hydra Tool



Fig. Q104 — Ram Insert (Ferulok Only)

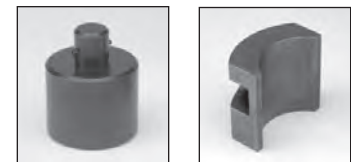

Fig. Q105 — Small Ram Insert and Stop Adapter (EO and EO-2 only)



Fig. Q106 — Hydra-Tool Kit



Fig. Q107 — Body Die



Fig. Q108 — Nut Die

TABLE OF CONTENTS

VISUAL INDEX

FAQs

TOOL SPEC.COM

## Hydra-Tool Body Dies for EO / EO-2 Fittings

Series	Tube O.D. Size (mm)	Part No.
L	6	910290-6L
L	8	910290-8L
L	10	910290-10L
L	12	910290-12L
L	15	910290-15L
L	18	910290-18L
L	22	910290-22L
L	28	910290-28L
L	35	910290-35L
L	42	910290-42L
S	6	910289-6S
S	8	910289-8S
S	10	910289-10S
S	12	910289-12S
S	14	910289-14S
S	16	910289-16S
S	20	910289-20S
S	25	910289-25S
S	30	910289-30S
S	38	910289-38S



Fig. Q109 — Body Die



Fig. Q110 — Back up Plate

## Hydra-Tool Nut Die / Split Back-up Plate Sets for EO / EO-2 Fittings

Tube O.D. Size (mm)	Part No.
6	910291-6 mm
8	910291-8 mm
10	910291-10 mm
12	910291-12 mm
14	910291-14 mm
15	910291-15 mm
16	910291-16 mm
18	910291-18 mm
20	910291-20 mm
22	910291-22 mm
25	910291-25 mm
28	910291-28 mm
30	970135-30 mm
35	970135-35 mm
38	970135-38 mm
42	970135-42 mm



Fig. Q111 — Split Nut Dies



Fig. Q112 — Nut Die

TABLE  
OF  
CONTENTS

VISUAL  
INDEX

FAQs

TOOL  
SPEC.COM

Q



[Click here for Support Resources or to Configure Parts Online](#)

## EO-Karrymat

The EO-Karrymat is a dependable device for safe and efficient bite-type pre-setting. It allows pre-assembly of all sizes of EO, EO-2 and Ferulok fittings without the need for electric power.

The EO-Karrymat consists of a hydraulic drive, Handpump and pressure gauge, all firmly attached to a carrying case.

Part Name	Part No.
EO-Karrymat .....	EOKarrymat

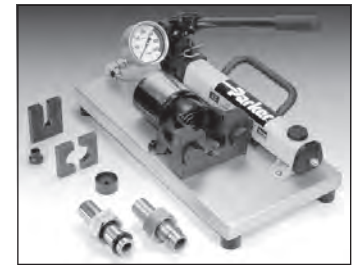

Fig. Q113 — EO-Karrymat

## EO-Karrymat Body Dies for EO / EO-2 Fittings

Series	Tube O.D. (mm)	Part No.
LL	4	MOK04LLX
LL	6	MOK06LLX
LL	8	MOK08LLX
LL	10	MOK10LLX
LL	12	MOK12LLX
L	6	MOK06LX
L	8	MOK08LX
L	10	MOK10LX
L	12	MOK12LX
L	15	MOK15LX
L	18	MOK18LX
L	22	MOK22LX
L	28	MOK28LX
L	35	MOK35LX
L	42	MOK42LX
S	6	MOK06SX
S	8	MOK08SX
S	10	MOK10SX
S	12	MOK12SX
S	14	MOK14SX
S	16	MOK16SX
S	20	MOK20SX
S	25	MOK25SX
S	30	MOK30SX
S	38	MOK38SX



Fig. Q114 — MOK Body Die

TABLE  
 OF  
 CONTENTS

VISUAL  
 INDEX

FAQs

TOOL  
 SPEC.COM

[Click here for Support Resources or to Configure Parts Online](#)

## EO-Karrymat Nut Dies for EO / EO-2 Fittings

Series	Tube O.D. (mm)	Part No.
LL	4	GHP04X
LL	6	GHP06X*
LL	8	GHP08X*
LL	10	GHP10X*
LL	12	GHP12X*
L	6	GHP06X*
L	8	GHP08X*
L	10	GHP10X*
L	12	GHP12X*
L	15	GHP15X
L	18	GHP18X
L	22	GHP22X
L	28	GHP28X
L	35	GHP35X
L	42	GHP42X
S	6	GHP06X*
S	8	GHP08X*
S	10	GHP10X*
S	12	GHP12X*
S	14	GHP14X
S	16	GHP16X
S	20	GHP20X
S	25	GHP25X
S	30	GHP30X
S	38	GHP38X

\* Nut Dies for 6-12mm are identical in LL, L and S series.



Fig. Q115 — GHP Nut Die

TABLE  
OF  
CONTENTS

VISUAL  
INDEX

FAQs

TOOL  
SPEC.COM

## EO-Karrymat Body Dies for Ferulok Fittings

Tube Size (in.)	Part No.
1/4	976521-4
3/8	976521-6
1/2	976521-8
5/8	976521-10
3/4	976521-12
7/8	976521-14
1	976521-16
1 1/4	976521-20
1 1/2	976521-24
2	976521-32



Fig. Q116 — EO-Karrymat Body Die for Ferulok

## EO-Karrymat Back-up Plates for Ferulok Fittings

Tube Size (in.)	Part No.
1/4	975867-4
3/8	975867-6
1/2	975867-8
5/8	975867-10
3/4	975867-12
7/8	975867-14
1	975867-16
1 1/4	975867-20
1 1/2	975867-24
2	975867-32



Fig. Q117 — EO-Karrymat Back-up Plates for Ferulok

Q

[Click here for Support Resources or to Configure Parts Online](#)

## O-Ring Pick

Plastic O-ring pick allows for easy removal of O-rings without causing damage to the fitting.

**Part Name** O-Ring Pick ..... **Part No.** O-Ring Pick

## Captive O-Ring Assembly Tool

The captive O-ring (CORG) assembly tool utilizes a Parker patented method for inserting O-rings in ORFS fittings, such as Seal-Lok, without causing O-ring damage. These tools can be used both as a hand tool and a bench-mounted tool. All CORG tools have a #8-32 tapped hole to allow easy mounting.

Fitting Size	L (in.)	D1 (in.)	D2 (in.)	O-Ring Size	Part No.
-4	1.4	0.8	0.6	2-011 .....	<b>CORG-4</b>
-6	1.5	0.9	0.6	2-012 .....	<b>CORG-6</b>
-8	1.5	1.1	0.8	2-014 .....	<b>CORG-8</b>
-10	1.6	1.3	0.9	2-016 .....	<b>CORG-10</b>
-12	1.9	1.4	1.1	2-018 .....	<b>CORG-12</b>
-16	1.9	1.7	1.3	2-021 .....	<b>CORG-16</b>
-20	2.1	1.9	1.6	2-025 .....	<b>CORG-20</b>
-24	2.1	2.3	1.9	2-029 .....	<b>CORG-24</b>
-32	2.2	2.8	2.4	2-135 .....	<b>CORG-32</b>

**WARNING:** This product can expose you to chemicals including Lead and Lead Compounds which is known to the State of California to cause cancer and birth defects or other reproductive harm. For more information go to [www.p65warnings.ca.gov](http://www.p65warnings.ca.gov).



Fig. Q118— O-Ring Pick



Fig. Q119 — Captive O-Ring Assembly Tool

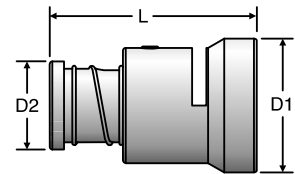

Fig. Q120 — Captive O-Ring Assembly Tool dimensions

TABLE OF CONTENTS

VISUAL INDEX

FAQs

TOOL SPEC.COM

[Click here for Support Resources or to Configure Parts Online](#)

## Braze Flux

Black braze flux can be used for brazing either steel or stainless steel components. When applied liberally this flux helps the flow of the silver braze alloy and prevents oxidation.

Part Name	Part No.
Black Flux .....	<b>Black Flux 1/2 lb</b>
Black Flux .....	<b>Black Flux 1 lb</b>



Fig. Q121 — Braze Flux

## Post Braze Cleaner

This cleaner is used to clean the assembly after brazing. Once the silver braze alloy has solidified, immediately immerse the joint into the braze cleaner solution. The cleaner combined with the sudden change in temperature removes the flux from the assembly. Braze cleaner does not provide corrosion protection. See “Corrosion Protection After Brazing” in the Assembly / Installation section, page R17.

Available in sizes 2 1/2 lb. and 5 lb. jars. When ordering simply denote quantity after Braze Cleaner.

Part Name	Part No.
Braze Cleaner.....	<b>Braze Cleaner 2 1/2 lb</b>
Braze Cleaner.....	<b>Braze Cleaner 5 lb</b>



Fig. Q122 — Post Braze Cleaner

TABLE  
 OF  
 CONTENTS

VISUAL  
 INDEX

FAQs

TOOL  
 SPEC.COM

Q

## Lubricants

Lubricants act as friction reducers to ease forming processes, fitting assembly and prevent galling, corrosion and seizing of components. The use of the correct lubricant for various purposes is critical to achieve maximum tool life during forming processes and performance of threaded connections.

### Parflange® Lubricants

Lubricants are used to maximize tool life during the flanging process. Selection of the appropriate lubricant for the type of Parflange machine is critical to its proper operation.

<b>Part Description</b>	<b>Part No.</b>
Recommended for use with steel or stainless steel .....	<b>LB 2000</b> (8 oz.)



Fig. Q123 — Parflange Lubricant, LB 2000

### EO / EO-2 Fitting Lubricants

EO Niromont lubricants are specifically developed for lubrication of threads prior to assembly of EO and EO-2 fittings.

<b>Part Description</b>	<b>Part No.</b>
EO Niromont – Liquid 250cc bottle .....	<b>Niromont Liquid</b>
EO Niromont – Paste 130 g. tin .....	<b>Niromont Paste</b>



Fig. Q124 — EO Niromont

## O-Ring Lubricants

### Parker O-Lube

O-Lube is an outstanding general-purpose grease intended for use with O-rings and other seals in hydraulic and pneumatic systems. The temperature range is from -29°C to +82°C (-20°F to +180°F).

<b>Part Description</b>	<b>Part No.</b>
O-ring Lubricant 2 oz. ....	<b>OLUBE-884-2-TFD</b>



Fig. Q125 — Parker O-Lube

### Parker Super O-Lube

Super O-Lube is an all-purpose O-ring lubricant. It is not a grease, but rather a high-viscosity silicone oil. The temperature range is -54°C to +204°C (-65°F to +400°F).

<b>Part Description</b>	<b>Part No.</b>
O-ring Lubricant.....	<b>SLUBE-884-2-TFD</b>



Fig. Q126 — Parker Super O-Lube

TABLE  
OF  
CONTENTS

VISUAL  
INDEX

FAQs

TOOL  
SPEC.COM



[Click here for Support Resources or to Configure Parts Online](#)

## Thread Sealants

Thread sealants seal and secure metal pipes and fittings by filling the space between the threaded metal parts. Thread sealants harden to prevent leakage caused by vibration loosening, solvent evaporation, damaged threads and temperature cycling. Designed for low and high pressure applications, thread sealants seal quickly for on-line low pressure testing. When fully cured, they seal to the burst strength of most systems. Thread sealants are easily removed with basic hand tools. Thread sealants can be used on pipe thread fittings.

### Threadmate™ Sealant/Lubricant

Threadmate™ is an extreme-duty lubricant developed to reduce galling during the assembly of pipe thread fittings. Threadmate™ promotes reliable sealing of pipe threads, even at high pressure. Recommended for use on stainless steel pipe threads.

**Size available**

4 oz. tube ..... **Part No. MTM04T-TFD**



**Fig. Q127 — Threadmate Sealant/Lubricant**

TABLE OF CONTENTS

VISUAL INDEX

FAQs

TOOL SPEC.COM

Q

[Click here for Support Resources or to Configure Parts Online](#)

## Tube Preparation Centers

Parker offers five different styles of tube preparation centers to meet various user's needs, from the basic TP-1 unit which includes a cabinet and deburr unit, to the TP1025 which offers the ability to cut, deburr, Parflange and flare tube.

Utilizing a sturdy steel cabinet with bins for fitting storage, tooling shelves and heavy duty casters to ease mobility, Parker Tube Preparation Centers cover almost every tube preparation need. All machines require 110V, 20A power supply.

<b>Part Description</b>	<b>Part No.</b>
Tube Prep Center with Deburr Unit.....	<b>TP-1</b>
Tube Prep Center with Deburr and Saw .....	<b>TP-974250</b>
Tube Prep Center with Deburr, Saw and Hydratool.....	<b>TP432</b>
Tube Prep Center with Deburr, Saw and Hyferset.....	<b>TP-611011A</b>
Tube Prep Center with Deburr, Saw and Karryflare Tool .....	<b>TP-Karryflare</b>
Tube Prep Center with Deburr, Saw and 1025 Parflange.....	<b>TP1025</b>

<b>Replacement Parts</b>	<b>Part No.</b>
I.D. Deburr Cone.....	<b>971816</b>
O.D. Deburr Blades (set of 6).....	<b>910485</b>
Cutting Lubricant .....	<b>Saw Lube</b>
Saw Blade – 250 mm x 2.0 mm thick (all purpose) .....	<b>987036</b>
Saw Blade – 200 mm x 2.0 mm thick (all purpose) .....	<b>987037</b>
Flaring tooling for TP432 .....	See page Q33 – Q35
Presetting tooling for TP432 and TP-611011A .....	See page Q45 – Q47
Karryflare Flaring tooling .....	See page Q36
Flanging tooling for TP1025.....	See page Q24
Flaring tooling for TP1025 .....	See page Q37
Lubricant for TP1025 .....	<b>LB 2000</b>

**⚠ WARNING:** This product can expose you to chemicals including Lead and Lead Compounds which is known to the State of California to cause cancer and birth defects or other reproductive harm. For more information go to [www.p65warnings.ca.gov](http://www.p65warnings.ca.gov).



Fig. Q128 — Tube Preparation Center TP1025

- TABLE OF CONTENTS
- VISUAL INDEX
- FAQs
- TOOL SPEC.COM

Click here for Support Resources or to Configure Parts Online

## Thread Identification Kit

The Thread Identification Kit can be used to identify metric, BSP, SAE and NPT threads, as well as SAE flanges. It contains thread gauges, calipers, thread profiles, and an instruction booklet that details most thread forms and connection styles found in fluidpower systems worldwide.

**Part Name** Thread Identification Kit.....  
**Part No.** MIK-1

**⚠ WARNING:** This product can expose you to chemicals including Diisononyl Phthalate which is known to the State of California to cause cancer. For more information go to [www.p65warnings.ca.gov](http://www.p65warnings.ca.gov).

### Need help identifying threads?

See our article: *Four Easy Steps to Identify Hydraulic Threads.*  
<http://blog.parker.com/four-easy-steps-to-identify-hydraulic-threads>

## Portboards

The Portboards can be used for identification of ISO, SAE, BSP and NPT ports and port threads. They are machined with female threads for quick and easy identification by screwing in the male port end.

Portboard A (SAE Straight Thread -2 through -32 and NPT 1/8 through 1 1/2).

**Part Name** Portboard A .....  
**Part No.** Portboard A

Portboard B (Metric 8mm through 48mm and BSP 1/8 through 1 1/2).

**Part Name** Portboard B .....  
**Part No.** Portboard B

**⚠ WARNING:** This product can expose you to chemicals including Lead and Lead Compounds which is known to the State of California to cause cancer and birth defects or other reproductive harm. For more information go to [www.p65warnings.ca.gov](http://www.p65warnings.ca.gov).

## International Thread Kit

Parker's International Thread Kit offers the necessary tools to identify almost any thread you may encounter. The new ITK has LL, L and S series plugs to identify female DIN threads such as EO style hose ends. It also includes the MIK-1 and BSPP plugs in order to identify BSPP hose ends from 1/8" to 2".

**Part Name** International Thread Kit .....  
**Part No.** ITK

**⚠ WARNING:** This product can expose you to chemicals including Lead and Lead Compounds which is known to the State of California to cause cancer and birth defects or other reproductive harm. For more information go to [www.p65warnings.ca.gov](http://www.p65warnings.ca.gov).



Fig. Q129 — Thread Identification Kit



Fig. Q130 — Portboard A



Fig. Q131 — Portboard B



Fig. Q132 — International Thread Kit (ITK)

TABLE OF CONTENTS

VISUAL INDEX

FAQs

TOOL SPEC.COM

Q

## Par-Lok® Wrench

360° Snap-action ratchet wrench for hex sizes from 3/8" to 2 1/4" across the flats and metric from 10mm to 50mm. Inch sizes meet government specifications and are listed as NSN-5120-00-474-7227. Wrenches are covered by a limited lifetime warranty. Damage due to over-torque is not covered by warranty.

### Install Tube Fittings Faster

Easy access ratchet wrench speeds fittings installation in tight locations. Rugged, snap-action jaws can be opened over tube lines, locked onto fitting hex and ratcheted within 1/8 turn. Full six point contact prevents fitting distortion common with wrench slippage. Ideal for tube line installations where compact runs require multiple fittings make-up, disassembly and remakes.

### Specifications

Par-Lok wrenches are available individually or in six different kit combinations. Par-Lok jaws are constructed from drop-forged, high carbon steel material with a black conversion coat finish. Par-Lok handles are made from heavy gauge steel material, heat treated and with a corrosion resistant black finish. Solid stainless steel rivets and tempered jaw springs are designed into every wrench for maximum strength.

### Inch Hex Size Par-Lok Wrenches

Hex Size (in.)	Part No.
3/8	860062-6
7/16	860062-7
1/2	860062-8
9/16	860062-9
5/8	860062-10
11/16	860062-11
3/4	860062-12
13/16	860062-13
7/8	860062-14
15/16	860062-15
1	860062-16
1 1/8	860062-18
1 1/4	860062-20
1 3/8	860062-22
1 1/2	860062-24
1 5/8	860062-26
1 7/8	860062-30
2	860062-32
2 1/4	860062-36

Part Description	Part No.
Full kit of sizes 3/8" to 1"	860062-KIT
Full kit of sizes 1 1/8" to 2 1/4"	860062-KIT2
Seal-Lok Wrench Kit (5/8", 11/16", 3/4", 13/16", 7/8", 15/16")	860062-LKIT
Triple-Lok and Ferulok Wrench Kit (9/16", 11/16", 7/8", 1", 1 1/4")	860062-XUKIT

**WARNING:** This product can expose you to chemicals including Lead and Lead Compounds which is known to the State of California to cause cancer and birth defects or other reproductive harm. For more information go to [www.p65warnings.ca.gov](http://www.p65warnings.ca.gov).

TABLE OF CONTENTS

VISUAL INDEX

FAQs

TOOL SPEC.COM



Fig. Q133 — Par-Lok Wrench



Fig. Q134 — Par-Lok Wrench Kit



Fig. Q135 — Par-Lok Wrench



Fig. Q136 — Seal-Lok Wrench Kit

[Click here for Support Resources or to Configure Parts Online](#)

## Metric Hex Size Par-Lok Wrenches

Hex Size (mm)	Max. Torque (ft.-lbs.)	Max. Torque (N-m)	Part No.
10	26	35	860063-10
11	27	37	860063-11
12	31	42	860063-12
13	33	45	860063-13
14	42	57	860063-14
16	65	88	860063-16
17	79	107	860063-17
19	92	125	860063-19
21	110	149	860063-21
22	131	178	860063-22
24	154	209	860063-24
27	74	100	860063-27
30	74	100	860063-30
32	125	170	860063-32
36	125	170	860063-36
41	229	310	860063-41
46	243	330	860063-46
50	243	330	860063-50

Part Description	Part No.
Full kit of sizes 10mm to 22mm	860063-KIT
Full kit of sizes 27mm to 50mm	860063-KIT2

**WARNING:** This product can expose you to chemicals including Lead and Lead Compounds which is known to the State of California to cause cancer and birth defects or other reproductive harm. For more information go to [www.p65warnings.ca.gov](http://www.p65warnings.ca.gov).



Fig. Q137 — Triple-Lok and Ferulok Wrench Kit



Fig. Q138 — Par-Lok Wrench Kit

TABLE OF CONTENTS

VISUAL INDEX

FAQs

TOOL SPEC.COM

Q



Click here for Support Resources or to Configure Parts Online

Tube Fabricating Equipment Weights		Tube Fabricating Equipment Weights		Tube Fabricating Equipment Weights	
Part No.	Approx. Ship Weight (lbs.)	Part No.	Approx. Ship Weight (lbs.)	Part No.	Approx. Ship Weight (lbs.)
<b>Rolo-Flare Tool</b>		<b>Ferulok Pre-Set Tool</b>		<b>Straight Thread Taps and Counterbores (Cont'd)</b>	
945 TH	4.00	560576	0.50	Y-34730	0.50
212FB	4.00	560577	0.50	Y-34731	0.50
<b>Hydra-Tool</b>		560578	0.50	Y-34732	0.50
710400B	62.00	560579	0.50	Y-34733	0.75
720370B-3	85.00	560580	0.50	Y-34734	1.00
<b>Accessories (Hydra-Tool)</b>		560581	0.50	Y-34735	1.00
900044*	1.00	560582	0.50	Y-34736	1.50
910004	1.50	560583	0.50	Y-34737	1.50
720377	16.00	560584	0.50	Y-34738	1.75
710416	4.00	560585	0.50	Y-34739	2.00
710412	3.00	560586	0.50	Y-34740	2.00
710419	2.00	560587	1.00	Y-34741	2.50
710411	2.00	560589	1.00	Y-34743	2.50
710424-1	4.00	<b>Hyferset (Ferulok Pre-Set Tool)</b>		<b>Par-Lok Wrenches</b>	
710424-2	4.00	611011A	35.00	860062-Kit	4.50
710417-4	2.00	<b>Hyferset Accessories</b>		860062-Kit 2	28.00
710417-5	2.00	900086	10.00	860063-Kit	4.00
710417-6	2.00	910004	2.00	<b>Tube Cutters</b>	
710417-8	2.00	651085	15.00	218B	1.00
710417-10	2.00	<b>Hyferset and Tooling</b>		1232	3.00
710417-12	2.00	611049C	53.00	<b>Parker Tru-Kut Sawing Vise</b>	
710417-14	2.00	680370-4	3.50	710439	9.00
710417-16	2.00	720105-4	0.50	974250	198.00
710417-20	2.00	680370-6	3.00	<b>Deburring Tools</b>	
710415-24	2.00	720105-6	0.50	226A	1.00
710415-32	2.00	680370-8	3.00	972125	90.00
<b>Power Source (Pumps)</b>		720105-8	0.50	<b>Hand Tube Benders</b>	
900085	30.00	680370-10	2.50	2-2829S	2.00
900086	10.00	720105-10	0.50	3-2829S	2.00
<b>Flaring Dies - Metric (Hydra-Tool)</b>		680370-12	2.50	4-2829S	2.50
770106-6	2.00	720105-12	0.50	5-2829S	2.50
770106-8	2.00	680370-14	2.50	6-2829S	3.00
770106-10	2.00	720105-14	0.50	8-2829S	3.00
770106-12	2.00	680370-16	1.50	10-2829	8.00
770106-16	2.00	720105-16	1.00	12-2829	15.00
770106-18	2.00	680370-20	2.00	14-2829	15.00
770106-20	2.00	720105-20	1.00	16-2829	16.00
770106-25	2.00	680370-24	1.50	4-2829AH	1.20
770106-30	2.00	720105-24	1.00	6-2829AH	3.70
770106-32	2.00	680370-32	1.50	8-2829AH	7.60
<b>Hydra-Tool</b>		720105-32	1.00	<b>Exactol Tube Benders (412 &amp; 424)</b>	
<b>Ferulok Pre-Set Tooling</b>		<b>Straight Thread Taps and Counterbores</b>		560569	18.50
770101	5.00	7/16-20 UNF-2B	1.00	550570	5.00
770102	3.00	9/16-18 UNF-2B	1.00	550572	25.50
		3/4-16 UNF-2B	1.00	621044	38.00
		7/8-14 UNF-2B	1.50	631156	10.00
		1 1/16-12 UN-2B	1.75	412 Kit	42.00
		1 3/16-12 UN-2B	2.00	424 Kit	—
		1 5/16-12 UN-2B	2.00	<b>Slide Blocks (412 &amp; 424)</b>	
		1 5/8-12 UN-2B	2.50	550585	3.50
		1 7/8-12 UN-2B	2.50	621045	5.00
		2 1/2-12 UN-2B	3.00	870150	5.00

TABLE OF CONTENTS

VISUAL INDEX

FAQs

TOOL SPEC.COM

**WARNING:** This product can expose you to chemicals including Lead and Lead Compounds which is known to the State of California to cause cancer and birth defects or other reproductive harm. For more information go to [www.p65warnings.ca.gov](http://www.p65warnings.ca.gov).

(Continued on next page)

Table Q16 — Tube Fabricating Equipment Weight Chart

Click here for Support Resources or to Configure Parts Online

Tube Fabricating Equipment Weights		Tube Fabricating Equipment Weights		Tube Fabricating Equipment Weights	
Part No.	Approx. Ship Weight (lbs.)	Part No.	Approx. Ship Weight (lbs.)	Part No.	Approx. Ship Weight (lbs.)
<b>Radius Blocks (412 &amp; 424)</b>		<b>HB632 Hydraulic Tube Bender</b>		<b>Clamp Blocks for HB632</b>	
550579	1.00	631050 (632)	245.00	864266	4.00
550580	1.00	660221	8.00	631092	3.00
550581	2.50	900085	30.00	631093	3.00
550582	3.00	<b>Radius Blocks (HB632)</b>		027418-28	5.00
550583	4.00	540502	3.00	027418-32	5.00
550584	5.00	530763	3.50	<b>Metric Clamp Blocks for HB632</b>	
621046	7.00	530764	4.00	790017	3.00
621047	9.00	530765	6.00	780194	4.00
621048	9.50	530766	10.00	780195	3.00
621049	10.00	530768	14.00	780186	4.00
870149	11.00	530770	54.00	<b>Metric Slide Blocks for HB632</b>	
<b>Small Radius Blocks (412 &amp; 424)</b>		590512-18	35.00	790016	8.00
550573	2.00	590515-24	4.00	780191	11.00
550574	2.00	590518-30	6.00	780192	9.00
550575	2.50	590521-36	7.00	780193	8.00
550576	2.50	590523-42	8.00	<b>Bender Table</b>	
550577	3.00	590524-48	10.00	520515	470.00
550578	4.00	590526-54	12.00	<b>Mandrel Rod Stop Assemblies</b>	
<b>Close Bend Radius Blocks</b>		590630-72	16.00	550571	5.00
590533	2.00	631060-128	50.00	631141	20.00
590535	3.00	<b>Close Bend Radius Blocks for HB632</b>		<b>Universal Side Angle Indicator</b>	
590537	3.00	530597	3.50	520520	25.00
<b>Metric Slide Blocks (412 &amp; 424)</b>		530601	5.00	<b>Karryflare Inch Flaring Dies for Karryflare</b>	
820091	3.00	530605	6.00	M 047415-1	4.00
820092	5.00	530609	8.00	M 157408-1	4.00
820093	5.00	530613	10.50	M 067415-1	4.00
<b>Metric Radius Blocks (412 &amp; 424)</b>		530621	12.00	M 087415	4.00
820090-6mm	1.00	530625	13.00	M 107415	3.50
820090-8mm	2.00	<b>Metric Radius Blocks for HB632</b>		M 127415	3.50
820090-10mm	2.00	810023	3.00	M 167415	3.50
820090-12mm	3.00	780175	3.50	M 207415	3.00
820090-14mm	3.00	780176	4.00	M 157438	3.00
820090-16mm	4.00	780177	4.00	<b>Parflange Tooling</b>	
820090-18mm	4.50	780178	5.00	Pin and Die Set (1025)	4.50
820090-20mm	6.50	780179	6.00	Pin (1025)	.75
820090-22mm	7.00	780180	8.00	Die (1025)	3.75
820090-25mm	9.00	780181	9.00	<b>Parflange Pro 50</b>	
820090-28mm	9.50	780182	10.50	Pro 50	838.00
820090-30mm	10.00	780183	12.00		
820090-32mm	10.50	780184	13.00		
<b>Tube Preparation Centers</b>		780186	175.00		
TP432	560.00	<b>CP432 Parflange Machines</b>			
TP1025	880.00	1025	175.00		
<b>EO Presetting Tooling</b>		<b>Metric Close Bend Radius Blocks for HB632</b>			
Nut Die	1.75	780185	3.50		
Body Die	.75	780186	3.50		
EO-Karrymat	55.00	780187	4.00		
		780188	5.00		
		780189	6.00		
		780190	6.50		

TABLE OF CONTENTS

VISUAL INDEX

FAQs

TOOL SPEC.COM



**WARNING:** This product can expose you to chemicals including Lead and Lead Compounds which is known to the State of California to cause cancer and birth defects or other reproductive harm. For more information go to [www.p65warnings.ca.gov](http://www.p65warnings.ca.gov)

Table Q16 — Tube Fabricating Equipment Weight Chart (continued from previous page)

[Click here for Support Resources or to Configure Parts Online](#)

TABLE  
OF  
CONTENTS

VISUAL  
INDEX

FAQs

TOOL  
SPEC.COM

# R ASSEMBLY/INSTALLATION

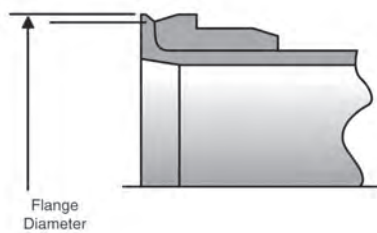
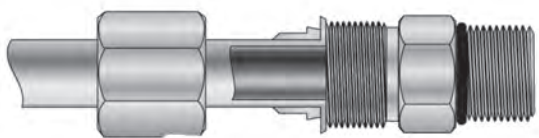
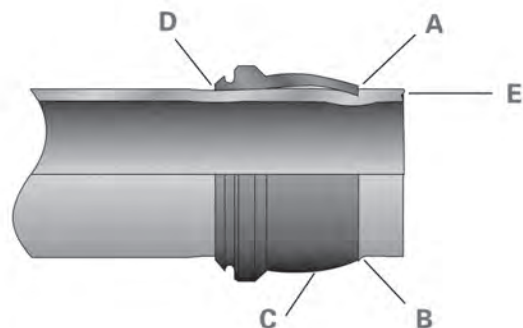
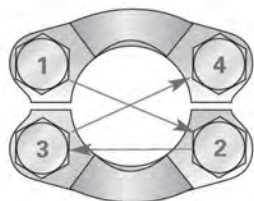

Improper Cut

Proper Cut

## Table of Contents

Port End Assembly .....	R3	EO-2 Metric Bite Type Fittings .....	R39
Parallel Thread Ports .....	R3	Pre-set of the Retaining Ring .....	R39
Adjustable Port End Assembly .....	R4	Pre-set Using the Fitting Body or Hardened Pre-assembly Tool .....	R39
Non-adjustable Port End Assembly .....	R4	Pre-set Inspection .....	R39
Tapered Thread Ports .....	R6	Pre-set Using EO-Karrymat, Hydra-Tool or Hyferset .....	R39
Tapered Thread Port Assembly .....	R7	Hydra-Tool Pre-Setting Pressures .....	R40
Flange Ports .....	R8	Hyferset Pre-Setting Pressures .....	R41
Troubleshooting Port End Connections .....	R9	Installation .....	R42
Tube End Assembly .....	R12	Re-assembly with Replacement of Sealing Ring (DOZ) .....	R42
Tube End Preparation .....	R12	EO-2 Troubleshooting Guide .....	R42
Seal-Lok O-Ring Face Seal Fittings and UPTC Assembly .....	R13	24° Flareless Bite .....	R43
Sleeve Attachment .....	R13	Bulkhead Locknut Assembly .....	R44
Flanging .....	R13	Pipe Swivel Assembly .....	R44
Brazing .....	R16	Routing and Clamping .....	R45
Final Installation .....	R17	Routing of Lines .....	R45
FastSeal Assembly Instructions .....	R19	Tube Clamping .....	R46
FastSeal Troubleshooting Guide .....	R21	Layout Data for Tube, Pipe and Hose Clamps	
Universal Push-to-Connect (UPTC) .....	R22	Standard (Inch) and Series A (Metric) .....	R46
Seal-Lok Troubleshooting Guide .....	R23	Heavy Series (Inch) and Series C (Metric) .....	R47
Triple-Lok 37° Flare Fittings .....	R24	Twin Series (Inch) and Series B (Metric) .....	R47
Flaring .....	R24	Tools for Tube Bending .....	R48
Installation .....	R25	Mandrel Bending Tools .....	R48
Triple-Lok Reassembly Method .....	R26	Plumbing and Assembly Hints .....	R49
Hydra-Tool Recommended Flaring Pressures .....	R27		
Triple-Lok Troubleshooting Guide .....	R29		
Ferulok Flareless Bite Type Fittings .....	R30		
Ferrule Pre-set .....	R30		
Hydra-Tool Pre-Setting Pressures .....	R31		
Hyferset Pre-Setting Pressures .....	R32		
Ferulok Troubleshooting Guide .....	R33		
24° Flareless Bite .....	R34		
EO Metric Bite Type Fittings .....	R35		
Pre-set of Progressive Ring .....	R35		
Pre-set Using the Fitting Body or Hardened Pre-assembly Tool .....	R35		
Pre-set Inspection .....	R36		
Pre-set Using EO-Karrymat, Hydra-Tool or Hyferset .....	R36		
Installation .....	R36		
Steps for Proper Assembly of Support Sleeve (VH) .....	R37		
EO Troubleshooting Guide .....	R38		





## Port End Assembly

The three common types of port ends used in the United States with tube fittings, pipe fittings and hose fittings are:

1. Parallel thread
2. Tapered Thread
3. Flanges

### 1. Parallel Thread Ports

Unlike tapered threads, parallel thread ports do not require sealing by the threads. The seal is obtained by other means, typically an elastomeric seal. When assembled properly, parallel thread ports provide the best leak-free port connection available.

Parker tube fittings are available with several types of parallel thread port studs (ends):

- SAE straight threads (SAE J1926 / ISO 11926)
- ISO (ISO 6149)
- JIS (JIS B2351)
- BSPP flat face (ISO 1179)
- DIN Metric flat face (ISO 9974).

The SAE straight thread, ISO 6149 and JIS B2351 ports are all of similar design. The male end is fitted with an O-ring. On assembly, the O-ring is firmly sandwiched between the angular sealing surface of the female port, the male end undercut, and the shoulder or back-up washer of the male end. Sealing is thus made possible and maintained by the O-ring compression, as shown in Fig. R1. The straight threads do not offer sealing action; they provide the resistance (holding power) for service pressure. Port dimensions for SAE and ISO 6149 ports are given on pages S31 and S32 respectively. For JIS B2351 dimensions, please contact the Tube Fittings Division.

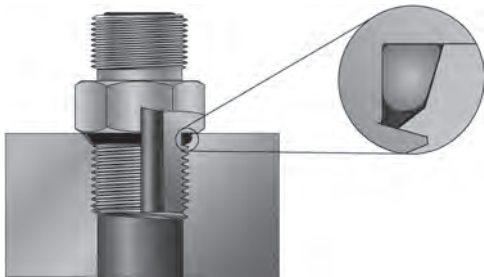

**Fig. R1 – SAE / ISO / JIS B2351 Straight Thread Port O-Ring Upon Assembly**

With the BSPP and metric flat face port ends, the sealing actually takes place on the top surface (spot face) of the port. Port dimensions can be found on pages S34 and S35 respectively. There are several sealing methods available for these ports. Port studs with type “E” sealing utilize Parker’s EOlastic seal (ED) (see Fig. R2) and are recommended for higher pressures than the other types. Types “G” and “H” use an O-ring that is supported on the outside by a removable retaining ring (see Fig. R3). Type B (cutting face) is designed with a relatively sharp

ridge of material that seals by coining the flat face of the female port (see Fig. R4). A fourth sealing method uses a bonded seal which consists of a metal ring with an elastomer bonded to the inside surface (often referred to as Dowty® seal) (see Fig. R5).

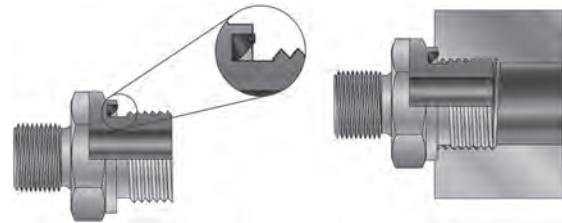

**Fig. R2 – EOlastic Seal, Type E**

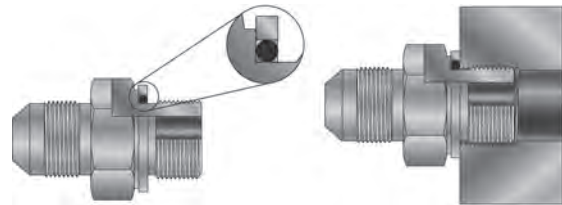

**Fig. R3 – O-Ring with Retaining Ring, Types G & H**

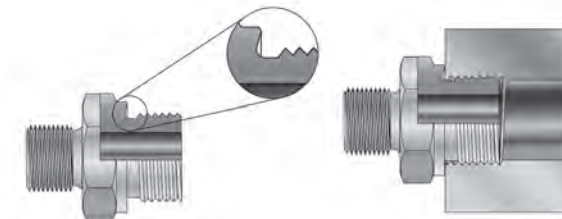

**Fig. R4 – Cutting Face, Type B**

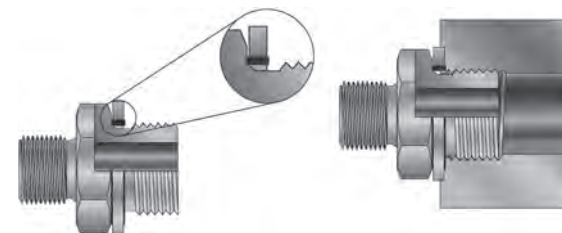

**Fig. R5 – Bonded Seal**

TABLE  
OF  
CONTENTS

SECTION  
TABLE OF  
CONTENTS

FAQs

R

For assembly purposes, there are two main categories of parallel port ends: adjustable and non-adjustable. Adjustable port ends are commonly found on shaped fittings to allow for proper orientation of the fitting. Besides the elastomeric seal, adjustable port ends are assembled with a locknut and a back-up washer as shown in Fig. R6. Non-adjustable port ends are found on straight fittings.

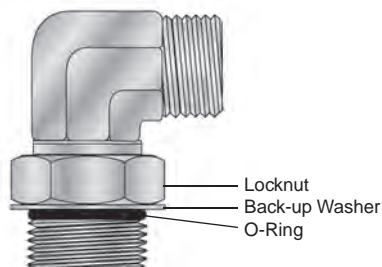
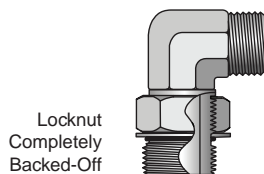

**Fig. R6 – Adjustable Port End Assembly**

The general assembly procedure for all adjustable parallel thread port ends is the same. Likewise, the assembly procedure is the same for all non-adjustable parallel thread port ends.

### Adjustable Port End Assembly

1. Inspect components to ensure that male and female port threads and sealing surfaces are free of burrs, nicks and scratches, or any foreign material.
2. If O-ring or seal is not pre-installed to fitting male port end, install proper size O-ring or seal, taking care not to damage it.
3. Lubricate O-ring with light coat of system fluid or a compatible lubricant to help the O-ring slide smoothly into the port and avoid damage.
4. Back off lock nut as far as possible. Make sure back-up washer is not loose Parker Robust Port Stud and is pushed up as far as possible.



**Step 4**

5. Screw fitting into port until the back-up washer or the retaining ring contacts face of the port. Light wrenching may be necessary. **Over tightening may damage washer.** This potential damage is eliminated with Parker's Robust Port Stud.

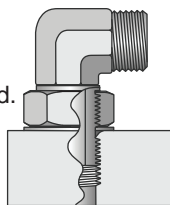

**Step 5**

6. To align the tube end of the fitting to accept incoming tube or hose assembly, unscrew the fitting by the required amount, but not more than one full turn.

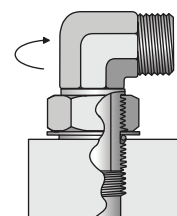

**Step 6**

7. Using two wrenches, hold fitting in desired position and tighten locknut to the proper torque value from the appropriate table located on pages R5 - R6.

8. Inspect to ensure that O-ring is not pinched and that washer is seated flat on face of port.

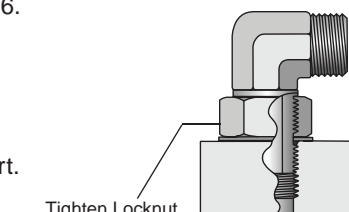

**Steps 7 and 8**

### Non-adjustable Port End Assembly

1. Inspect components to ensure that male and female port threads and sealing surfaces are free of burrs, nicks, and scratches, or any foreign material.
2. If O-ring or seal is not pre-installed to fitting male port end, install proper size O-ring or seal, taking care not to damage it.
3. Lubricate O-ring with light coating of system fluid or a compatible lubricant to help the O-ring slide past the port entrance corner and avoid damaging it.
4. Screw fitting into port and tighten to proper torque from the appropriate table located on pages R5 - R6.

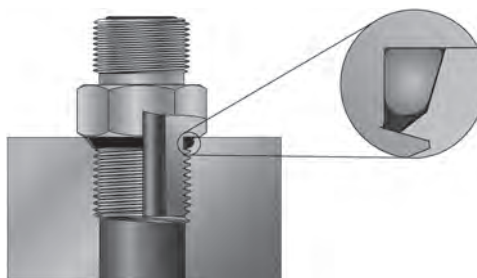

**Fig. R7 — Non-Adjustable Port End Assembly**

TABLE OF CONTENTS

SECTION TABLE OF CONTENTS

FAQs

### SAE Straight Thread Port Assembly (SAE J1926)

SAE Dash Size	Thread Size UN/UNF	Assembly Torque (+10% -0)											
		Non-Adjustables				Adjustables				Plugs			
		Seal-Lok (Heavy Duty SAE J1926-2)		Triple-Lok Ferulok Adapters (Light Duty SAE J1926-3)		Seal-Lok (Heavy Duty SAE J1926-2)		Triple-Lok Ferulok Adapters (Light Duty SAE J1926-3)		HP50N-S (Light Duty SAE J1926-3)		P50N-S (Light Duty SAE J1926-3)	
		ft.lbs. (in. lbs)	N-m	ft.lbs. (in. lbs)	N-m	ft.lbs. (in. lbs)	N-m	ft.lbs. (in. lbs)	N-m	ft.lbs. (in. lbs)	N-m	ft.lbs. (in. lbs)	N-m
2	5/16-24	—	—	(85)	10	—	—	(60)	7	(60)	7	(85)	10
3	3/8-24	—	—	(155)	18	—	—	(100)	11	(100)	11	(155)	18
4	7/16-20	(310)	35	(260)	29	(180)	20	(180)	20	(180)	20	(260)	29
5	1/2-20	(360)	41	(280)	32	(360)	41	(250)	28	(250)	28	(280)	32
6	9/16-18	(420)	47	(350)	40	(420)	47	(350)	40	(350)	40	(350)	40
8	3/4-16	(720)	81	(620)	70	(720)	81	(620)	70	(620)	70	(620)	70
10	7/8-14	100	136	85	115	100	136	85	115	85	115	85	115
12	1 1/16-12	135	183	135	183	135	183	135	183	135	183	135	183
14	1 3/16-12	175	237	175	237	175	237	175	237	175	237	175	237
16	1 5/16-12	200	271	200	271	200	271	200	271	200	271	200	271
20	1 5/8-12	250	339	250	339	250	339	250	339	250	339	250	339
24	1 7/8-12	305	414	305	414	305	414	305	414	305	414	305	414
32	2 1/2-12	375	508	375	508	375	508	375	508	375	508	375	508

Table R1 – SAE J1926 Straight Thread Port Assembly Torques

Notes: Lubricate threads before assembly. Values in chart are for plated steel fittings in steel ports. For stainless steel fittings, use the upper limit of torque range. For brass and aluminum decrease torque value by 35%.

### BSPP (Thread G) Port Assembly (ISO 1179 / DIN 3852-2)

Series	Tube O.D.	BSPP Thread G Size	Assembly Torque Nm +10% -0								
			Straight Male Stud Fittings			Non-Return Valves RHV / RHZ	Banjo Fittings		Plugs VSTI-ED	Straight and Adjustable Fittings	
			Form A for Sealing Washer	Form B with Cutting Face	Form E with ED-Sealing	Form E with ED-Sealing	WH / TH	SWVE	Form E with ED-Sealing	O-Ring with Retaining Ring and Bonded Washer	
	6	1/8 - 28	9	18	18	18	18	18	13	18	
	8	1/4 - 19	35	35	35	35	45	40	30	35	
	10	1/4 - 19	35	35	35	35	45	40	30	35	
L	12	3/8 - 19	45	70	70	50	70	65	60	70	
	15	1/2 - 14	65	140	90	85	120	90	80	90	
	18	1/2 - 14	65	100	90	85	120	90	80	90	
	22	3/4 - 14	90	180	180	140	230	125	140	180	
	28	1 - 11	150	330	310	190	320	—	200	310	
	35	1 1/4 - 11	240	540	450	360	540	—	400	450	
	42	1 1/2 - 11	290	630	540	540	700	—	450	540	
S	6	1/4 - 19	35	55	40	45	45	40	—	40	
	8	1/4 - 19	35	55	40	45	45	40	—	40	
	10	3/8 - 19	45	90	80	60	70	65	—	60	
	12	3/8 - 19	45	90	80	60	70	65	—	60	
	14	1/2 - 14	65	150	115	145	120	90	—	90	
	16	1/2 - 14	65	130	115	100	120	90	—	90	
	20	3/4 - 14	90	270	180	145	230	125	—	180	
	25	1 - 11	150	340	310	260	320	—	—	310	
		30	1 1/4 - 11	240	540	450	360	540	—	—	450
		38	1 1/2 - 11	290	700	540	540	700	—	—	540

Table R2 – Assembly Torques for ISO 1179-1 / DIN 3852-2 Port

Note: Lubricate threads before assembly! Tightening torques are for steel fittings assembled in steel components. Values in chart are for steel fittings in steel ports. For stainless steel fittings, use the upper limit of torque range. For brass and aluminum decrease torque value by 35%.

TABLE OF CONTENTS

SECTION TABLE OF CONTENTS

FAQs



### Metric (ISO Thread M) Port Assembly (ISO 9974-1 / DIN 3852-1)

Series	Tube O.D.	Metric Thread M Size	Assembly Torque Nm +10% -0							
			Straight Male Stud Fittings			Non-Return Valves RHV / RHZ	Banjo Fittings		Plugs VSTI-ED	Straight and Adjustable Fittings
			Form A for Sealing Washer	Form B with Cutting Face	Form E with ED-Sealing	Form E with ED-Sealing	WH / TH	SWVE	Form E with ED-Sealing	O-Ring with Retaining Ring
L	6	M 10 x 1	9	18	18	18	18	18	12	18
	8	M 12 x 1.5	20	30	25	25	45	35	25	25
	10	M 14 x 1.5	35	45	45	35	55	50	35	40
	12	M 16 x 1.5	45	65	55	50	80	60	50	55
	15	M 18 x 1.5	55	80	70	70	100	80	65	70
	18	M 22 x 1.5	65	140	125	125	140	120	90	90
	22	M 27 x 2	90	190	180	145	320	130	135	180
	28	M 33 x 2	150	340	310	210	360	—	225	310
S	35	M 42 x 2	240	500	450	360	540	—	360	450
	42	M 48 x 2	290	630	540	540	700	—	360	540
	6	M 12 x 1.5	20	35	35	35	45	35	—	35
	8	M 14 x 1.5	35	55	45	45	55	50	—	55
	10	M 16 x 1.5	45	70	70	55	80	60	—	70
	12	M 18 x 1.5	55	110	90	70	100	80	—	90
	14	M 20 x 1.5	55	150	125	100	125	110	80	125
	16	M 22 x 1.5	65	170	135	125	135	120	—	135
	20	M 27 x 2	90	270	180	135	320	135	—	190
	25	M 33 x 2	150	410	310	210	360	—	—	310
30	M 42 x 2	240	540	450	360	540	—	—	450	
38	M 48 x 2	290	700	540	540	700	—	—	540	

Table R3 – Assembly Torques for ISO 9974-1 / DIN 3852-1 Port

Note: Lubricate threads before assembly. Values in chart are for steel fittings in steel ports. For stainless steel fittings, use the upper limit of torque range. For brass and aluminum decrease torque value by 35%.

### Metric ISO Port Assembly (ISO 6149/DIN 3852-3)

Metric Thread M Size	Assembly Torque (+10% -0) <sup>2)</sup>			
	ISO 6149-2 Stud Ends (S-Series) (Seal-Lok, EO & VSTI-OR Plugs)		ISO 6149-3 Stud Ends (L-Series) (Triple-Lok, EO, Ferulok & Pipe Adapters)	
	N.m.	ft. lbs.	N.m.	ft. lbs.
M8x1	10	7.5	8	6
M10x1	20	15	15	11
M12x1.5	35	26	25	18
M14x1.5	45	33	35	26
M16x1.5	55	41	40	30
M18x1.5	70	52	45	33
M20x1.5 <sup>3)</sup>	80	59	—	—
M22x1.5	100	74	60	44
M27x2	170	125	100	74
M30x2	235	175	130	95
M33x2	310	230	160	120
M38x2 <sup>1)</sup>	320	235	185	135
M42x2	330	245	210	155
M48x2	420	310	260	190
M60x2	500	370	315	230

Table R4 – ISO 6149 / DIN 3852-3 Port Assembly Torques

- M38X2 is not covered in ISO 6149 standards.
- These torques are for steel fittings, assembled lubricated, for brass and aluminum decrease torque value by 35%.
- For cartridge valves only.

### 2. Tapered Thread Ports

Tapered thread ports include NPT/NPTF, BSPT and metric taper. The tapered threads in these ports serve two functions: 1) to hold the fitting in place while under pressure, and 2) to serve as the primary seal. The seal for NPTF threads is created by the metal-to-metal contact between the mating roots and crests of the male and female threads. With tapered threads, there is not always contact at the roots and crests. There can be a spiral gap which is small enough for a sealant to fill and provide an effective seal.

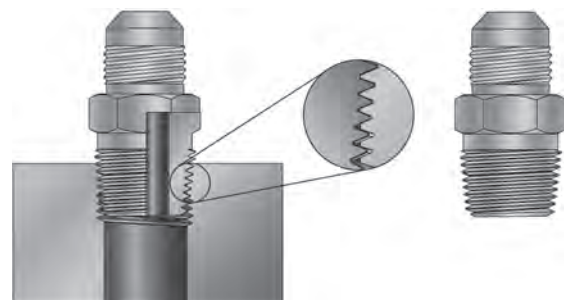

Fig. R8 – Tapered Thread Port

TABLE OF CONTENTS

SECTION TABLE OF CONTENTS

FAQs



The variety of thread forms available under taper threads include:

**NPT** – American Standard Taper Pipe Thread (ANSI B1.20.1).

**NPTF** – Dryseal American Standard Taper Pipe Thread (SAE J476, ANSI B1.20.3).

**BSPT or JIS “PT”** – British Standard Pipe, Tapered (BS21, JIS B 0203, ISO 7), also known as “R” for male and “Rc” for female.

**M-Keg** – Metric taper threads (DIN 158).

The vast majority of Parker Tube Fittings Division’s standard pipe thread fittings are machined with the NPTF thread form. NPTF thread is also referred to as Dryseal Pipe Thread.

The full thread profile contact of NPTF threads is designed to give the tapered threads self-sealing ability without thread sealant. **However, variations in condition of mating threads, fitting and port materials, assembly procedures and operating conditions make self-sealing highly improbable. Therefore, some type of thread sealant is required to achieve proper seal and, in some cases, additional lubricity to prevent galling.**

#### Types of Sealant/Lubricant

Sealant/Lubricants assist in sealing and provide lubrication during assembly, reducing the potential for galling. Pipe thread sealants are available in various forms such as dry pre-applied, tape, paste and anaerobic liquid.

Pre-applied sealants, such as Vibraseal® and powdered PTFE are usually applied to connectors by the manufacturer. Connectors with some of these sealants may be remade a few times without needing additional sealant. Vibraseal may also help reduce loosening due to vibration.

PTFE tape, if not applied properly, can contribute to system contamination during assembly and installation. In addition, because of PTFE’s high lubricity, fittings can be more easily over tightened; and it does not offer much resistance to loosening due to vibration.

Paste sealants, if not applied properly, can also contribute to system contamination. Generally they can be messy to work with and some types require a cure period after component installation prior to system start up.

Anaerobic liquids are available from several manufacturers and perform sealing as well as thread locking functions. They are applied to the connectors by the user and require a cure period prior to system start up. Some are soluble in common hydraulic fluids and will not contaminate the system. For proper performance they need to be applied to clean and dry components, carefully following the manufacturer’s directions.

**How many times can you reassemble a tapered thread pipe fitting? Read our article for what you need to know.**

### Tapered Thread Port Assembly

The proper method of assembling tapered threaded connectors is to assemble them finger tight and then wrench tighten further to the specified number of turns from finger tight (T.F.F.T.) given in Table R5. The following assembly procedure is recommended to minimize the risk of leakage and/or damage to components.

1. Inspect components to ensure that male and female port threads and sealing surfaces are free of burrs, nicks, scratches, or any foreign material.
2. Apply sealant/lubricant to male pipe threads if not pre-applied. For stainless steel fittings, the use of Parker Thread-mate sealant/lubricant is strongly recommended. (Pre-applied dry sealants are preferred over other sealants). With any sealant, the first one to two threads should be left uncovered to avoid system contamination. If PTFE tape is used it should be wrapped 1-1/2 to 2 turns in clockwise direction when viewed from the pipe thread end.  
**Caution:** More than two turns of tape may cause distortion or cracking of the port.
3. Screw the connector into the port to the finger tight position.
4. Wrench tighten the connector to the appropriate T.F.F.T. values shown in Table R5, making sure that the tube end of a shaped connector is aligned to receive the incoming tube or hose assembly. **Never back off (loosen) pipe threaded connectors to achieve alignment.**
5. If leakage persists after following the above steps, check for damaged threads and total number of threads engaged.

If threads on the fitting are badly nicked or galled, replace the fitting. If port threads are damaged, re-tap, if possible, or replace the component. If the port is cracked, replace the component.

Normally, the total number of tapered threads engaged should be between 3-1/2 and 6. Any number outside of this range may indicate either under or over tightening of the joint or out of tolerance threads. If the joint is under tightened, tighten it further but no more than one full turn. If it is over tightened, check both threads, and replace the part which has out-of-tolerance threads.

As a general rule, pipe fittings with tapered threads should not be assembled to a specific torque because the torque required for a reliable joint varies with thread quality, port and fitting materials, sealant used, and other factors. Where many of these factors are well-controlled, such as particular jobs on an assembly floor, a torque range that produces the desired results may be determined by test and used in lieu of turns count for proper joint assembly.

Tapered Pipe Thread Size		T.F.F.T.
BSPT	NPTF	
1/8-28	1/8-27	2 - 3
1/4-19	1/4-18	2 - 3
3/8-19	3/8-18	2 - 3
1/2-14	1/2-14	2 - 3
3/4-14	3/4-14	2 - 3
1-11	1-11 1/2	1.5 - 2.5
1 1/4-11	1 1/4-11 1/2	1.5 - 2.5
1 1/2-11	1 1/2-11 1/2	1.5 - 2.5
2-11	2-11 1/2	1.5 - 2.5

**Table R5 – Assembly Turns From Finger Tight (T.F.F.T) Values For Steel, Stainless Steel and Brass Pipe Fittings**



**R**



### 3. Flange Ports

Large threaded port connections, such as SAE straight thread, require very high torque to assemble. This makes assembly very difficult, especially where wrench clearance is limited. Split flange connections solve this problem by dividing the hydraulic load among four bolts each requiring much less torque, smaller wrenches and smaller wrench clearance.

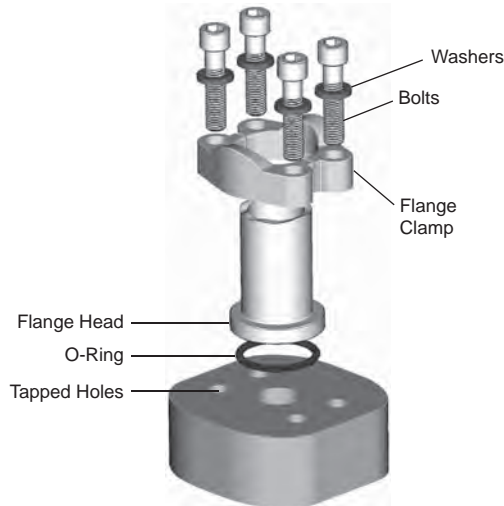

**Fig. R9 – 4-Bolt Split Flange Components**

There are two types of flange port connections:

1. ISO 6162
  - SAE Code 61 4-bolt split flange
  - SAE Code 62 4-bolt split flange
2. ISO 6164

The 4-Bolt Split Flange consists of four main components:

1. A body (flange head)
2. An O-ring
3. One captive or two split flange clamps
4. Four bolts and washer

The four-bolt port is simply a circular opening (flow passage) surrounded by four tapped holes in a certain pattern for acceptance of the flange clamping bolts. The flat surface of the port compresses the O-ring contained in the groove in the flange head when the clamp bolts are torqued. In some instances, the groove is in the port and not in the flange head. The bolts clamp down the flange head onto the flat surface of the port compressing and trapping the O-ring in the groove and leaving no gap for it to extrude under pressure. The hydraulic pressure is thus sealed by the compressed O-ring as long as the bolts are tightened enough to maintain solid metal to metal contact between the flange head at the outside diameter of the O-ring and the top of the port.

#### Flange Port Assembly

The steps to properly assemble the flange port clamping bolts are:

1. Inspect components to ensure that male and female port threads and sealing surfaces are free of burrs, nicks and scratches, or any foreign material.
2. Lubricate the O-ring.

3. Position flange and clamp halves.
4. Place lock washers on bolts and insert through clamp halves.
5. Hand tighten bolts.
6. Torque bolts in diagonal sequence (see Fig. R10) in small increments to the appropriate torque level listed in Table R6 or R7 below.

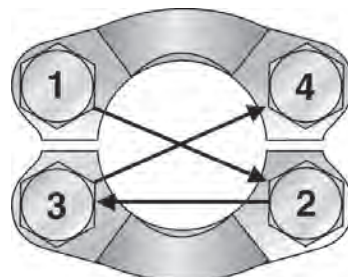

**Fig. R10 – Flange Bolt Tightening Sequence**

Dash Size	Flange Size	Inch Bolt (J518)	+10% -0 Torque ft. lbs.	Metric Bolt (ISO 6162)	+10% -0 Torque N-m
8	1/2	5/16-18	17	M8	24
12	3/4	3/8-16	31	M10	50
16	1	3/8-16	31	M10	50
20	1-1/4	7/16-14	52	M10	50
24	1-1/2	1/2-13	77	M12	92
32	2	1/2-13	77	M12*	92
40	2-1/2	1/2-13	77	M12	92
48	3	5/8-11	155	M16	210
56	3-1/2	5/8-11	155	M16	210
64	4	5/8-11	155	M16	210
80	5	5/8-11	155	M16	210

\* Does not meet ISO 6162 specification.

**Table R6 – Code 61 Flange Recommended Bolt Torque**

Dash Size	Flange Size	Inch Bolt (J518)	+10% -0 Torque ft. lbs.	Metric Bolt (ISO 6162)	+10% -0 Torque N-m
8	1/2	5/16-18	17	M8	24
12	3/4	3/8-16	31	M10	50
16	1	7/16-14	52	M12	92
20	1-1/4	1/2-13	77	M14*	130
24	1-1/2	5/8-11	155	M16	210
32	2	3/4-10	265	M20	400

**Table R7 – Code 62 Flange Recommended Bolt Torque**

Socket Screw Bolt Circle (LK)	Socket Head Cap Screws	Tightening Torques N-m
LK35	M6	10
LK40	M6	10
LK55	M8	25

**Table R8 – Hydraulic Flange Recommended Bolt Torque**

\* In general, variances of torque for soft metal ports/manifolds (ie: aluminum block - 66% of specified torque)

TABLE OF CONTENTS

SECTION TABLE OF CONTENTS

FAQs

## Troubleshooting Port End Connections 60° Cone (Metric, BSPP and NPSM)

Read our blog post “[Troubleshooting Leaks: Fixing a Port End Connection Issue](#)”



CONDITION	PROBABLE CAUSE(S)	RECOMMENDATION
End of swivel nut contacts hex shoulder of adapter before cone and ball nose tightens	<ul style="list-style-type: none"> <li>Wrong combination of swivel nut and adapter</li> </ul>	<ul style="list-style-type: none"> <li>Ensure that components are to the same specification (even with the same type, there are different designs for 60° cone fittings)</li> </ul>
Thread engagement seems adequate and swivel nut is tight but leakage still occurs	<ul style="list-style-type: none"> <li>Scratches or nicks on sealing surface</li> <li>Chatter marks on sealing surface</li> </ul>	<ul style="list-style-type: none"> <li>Replace components. These fittings depend on metal-to-metal seal and require smooth mating surfaces to seal</li> </ul>
There is leakage from the joint and the swivel nut is loose	<ul style="list-style-type: none"> <li>Inadequate make-up torque</li> </ul>	<ul style="list-style-type: none"> <li>Use proper torque to create a seal as well as prevent vibration loosening</li> </ul>
Swivel nut tightens, cone is tight but connection still leaks	<ul style="list-style-type: none"> <li>Inadequate or no chamfer in adapter</li> </ul>	<ul style="list-style-type: none"> <li>Use components with proper chamfer (very common occurrence with NPTF/ NPSM 60° cone fittings). Male pipe end must have chamfer for proper sealing. Not all male pipe ends have chamfer as standard</li> </ul>

## Tapered Thread (including BSPT, NPT and metric taper)

CONDITION	PROBABLE CAUSE(S)	RECOMMENDATION
Thread galling	<ul style="list-style-type: none"> <li>Most common in stainless steel, caused by friction and lack of lubricant</li> </ul>	<ul style="list-style-type: none"> <li>Replace fitting and apply proper thread sealant/lubricant to replacement fitting and tighten to appropriate TFFT</li> </ul>
Fitting leaks, even after proper tightening	<ul style="list-style-type: none"> <li>Sealant omitted or inadequately applied</li> <li>Damaged or cracked threads</li> <li>Cracked port</li> <li>Thread mixing of BSPT and NPT threads</li> </ul>	<ul style="list-style-type: none"> <li>Re-apply sealant to appropriate TFFT and re-tighten</li> <li>Replace fitting</li> <li>Replace component</li> <li>Determine port thread type and replace fitting with matching thread type</li> </ul>
Insufficient thread engagement (3 to 6 threads of engagement required)	<ul style="list-style-type: none"> <li>Quality problem with port or adapter</li> <li>Too much thread sealant (tape)</li> </ul>	<ul style="list-style-type: none"> <li>Have port and adapter thread inspected; replace faulty parts</li> <li>Remove all thread sealant and re-apply 1 to 2 layers of tape</li> </ul>
Too much thread engagement (more than recommended 3 to 6 threads)	<ul style="list-style-type: none"> <li>Typically port or adapter machining or wear problem, or port could be cracked due to excessive torque</li> </ul>	<ul style="list-style-type: none"> <li>Inspect port and adapter for proper tolerance or wear, replace faulty parts, retighten to appropriate TFFT</li> </ul>
Poor-quality threads or damaged/nicked threads	<ul style="list-style-type: none"> <li>Larger sizes are more prone to having nicked threads due to handling damage</li> </ul>	<ul style="list-style-type: none"> <li>Replace fitting with threads that are free of scratches and nicks</li> </ul>



Dimensions and pressures for reference only, subject to change.

## Troubleshooting Port End Connections

### Parallel (SAE, BSPP and metric)

CONDITION	PROBABLE CAUSE(S)	RECOMMENDATION
Washer is too loose (moves by its own weight or rocks too much on the undercut)	<ul style="list-style-type: none"> <li>Washer damaged</li> </ul>	<ul style="list-style-type: none"> <li>Replace fitting</li> </ul>
Fitting threads are distorted	<ul style="list-style-type: none"> <li>Over-torqued</li> <li>Mixed threads</li> </ul>	<ul style="list-style-type: none"> <li>Replace fitting and tighten to proper torque</li> <li>Determine correct thread type</li> </ul>
Several scratches or nicks on the port face	<ul style="list-style-type: none"> <li>Port face contaminated (dirty)</li> </ul>	<ul style="list-style-type: none"> <li>Reface the port</li> </ul>
Spot face of port is smaller than washer diameter	<ul style="list-style-type: none"> <li>Improper port tool was used</li> <li>Wrong fitting selected for port</li> </ul>	<ul style="list-style-type: none"> <li>Reface the port</li> <li>Select a proper fitting</li> </ul>
Port threads are distorted (yielded)	<ul style="list-style-type: none"> <li>Fitting over-torqued</li> </ul>	<ul style="list-style-type: none"> <li>Replace component</li> </ul>
Leakage persists after locknut has been torqued	<ul style="list-style-type: none"> <li>Damaged O-ring</li> <li>Damaged washer</li> <li>Improper assembly</li> </ul>	<ul style="list-style-type: none"> <li>Replace O-ring with new quality O-ring (90 durometer) and reconnect fitting to proper torque</li> <li>Replace fitting</li> <li>Follow proper assembly procedure</li> </ul>
Washer distorted, allowing opportunity for O-ring to extrude	<ul style="list-style-type: none"> <li>Exposed upper thread forced washer into port during assembly (over-torquing makes this more prevalent)</li> </ul>	<ul style="list-style-type: none"> <li>Replace fitting, using proper installation techniques for adjustable port ends</li> </ul>

TABLE  
OF  
CONTENTS

SECTION  
TABLE OF  
CONTENTS

FAQs

Dimensions and pressures for reference only, subject to change.

## Troubleshooting Port End Connections

### Flange (i.e., ISO 6162 4-Bolt)

CONDITION	PROBABLE CAUSE(S)	RECOMMENDATION
Missing or improper O-ring	<ul style="list-style-type: none"> <li>• Assembly/re-assembly oversight</li> </ul>	<ul style="list-style-type: none"> <li>• Replace with proper O-ring and re-tighten connection using incremental alternating tightening procedure</li> </ul>
O-ring pinched or extruded	<ul style="list-style-type: none"> <li>• Improper tightening procedure</li> </ul>	<ul style="list-style-type: none"> <li>• Replace O-ring and re-tighten connection using incremental alternating tightening procedure</li> </ul>
Evidence of yielded or cracked flange head, tube or hose end	<ul style="list-style-type: none"> <li>• Misaligned tube or hose connection</li> </ul>	<ul style="list-style-type: none"> <li>• Re-bend or re-route hose/tube lines to eliminate misalignment</li> </ul>
Components do not mate or gap is too large	<ul style="list-style-type: none"> <li>• Proprietary flange or pressure series matching problem</li> </ul>	<ul style="list-style-type: none"> <li>• Properly identify all components—most proprietary flanges use standard Code 61/62 bolt patterns and threads but are not usually interchangeable</li> </ul>
Port has severe scratches or nicks in seal area	<ul style="list-style-type: none"> <li>• Mishandling or abuse</li> </ul>	<ul style="list-style-type: none"> <li>• Resurface the port to remove scratches and nicks</li> </ul>
Clamp halves are bent	<ul style="list-style-type: none"> <li>• Over-pressurization or over-torque</li> </ul>	<ul style="list-style-type: none"> <li>• Replace clamp halves and tighten to proper torque</li> </ul>
Bolts are bent	<ul style="list-style-type: none"> <li>• Bolts are too weak or over-torqued</li> </ul>	<ul style="list-style-type: none"> <li>• Replace bolts with grade 8 or better; retighten to proper torque</li> </ul>

TABLE OF CONTENTS

SECTION TABLE OF CONTENTS

FAQs

R

Dimensions and pressures for reference only, subject to change.

## Tube End Assembly

The assembly of the tube end consists of the following two steps:

1. Tube end preparation (cutting, deburring and cleaning)
2. Assembly and installation

### Tube End Preparation

Tube end preparation is a very critical step to assure the integrity of a tube assembly. Failure to properly perform this function can result in leakage. The three steps in proper tube end preparation are: cutting, deburring and cleaning.

#### Cutting

Cut tube square (within +/- 1°) using a circular toothed cut-off saw (see Fig. R11), or a hacksaw with a fine tooth blade guided by a Tru-Cut Saw Guide (Fig. R12) or other mitre-type saw guide.

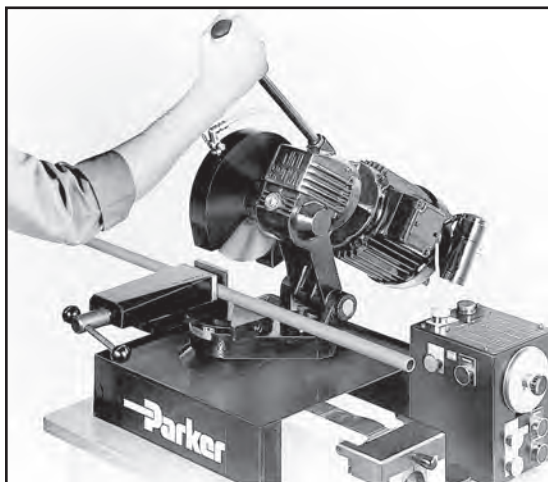

Fig. R11 – Cut-off Saw on Parker's TP432 or TP1025 Tube Preparation Center

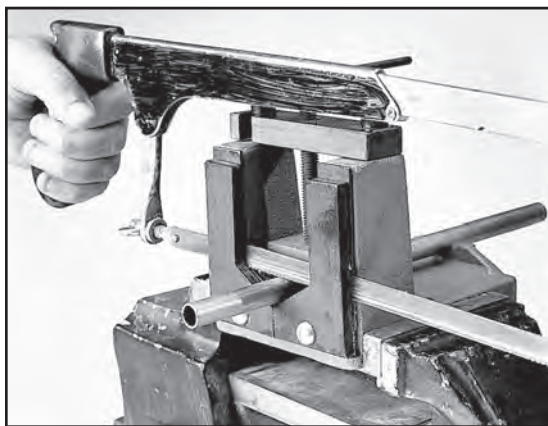

Fig. R12– Parker's Tru-Kut Sawing Vise used with hacksaw

A tube cutter may be used with soft tube such as copper and aluminum. It is not recommended for steel and stainless steel tube because it creates a large burr on the I.D., which is difficult to remove and creates flow restriction. Furthermore, if the tube needs to be flared or flanged, the build up on the ID can compromise the sealing surface. For a steel or stainless steel tube application, Fig. R13 illustrates a proper cut and an improper cut (with the improper cut performed by a tube cutter).

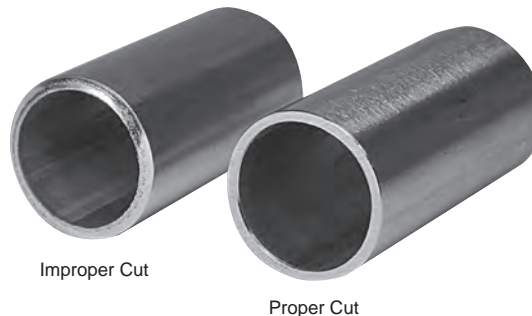
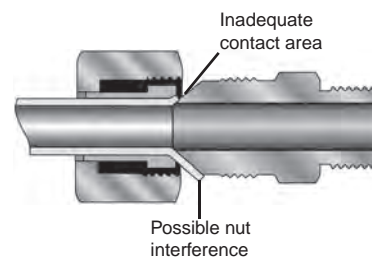

Fig. R13 – Samples of improper and proper cuts on steel tube

A square cut is essential to assure a leak-free connection. The following illustrations depict what will result from an uneven cut.

#### Flare Connection



#### Flareless Bite Type Connection

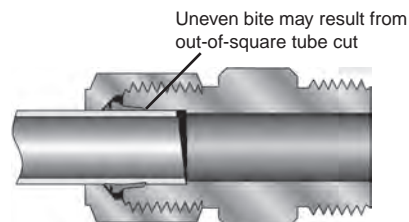

#### Mechanical Formed ORFS Connection

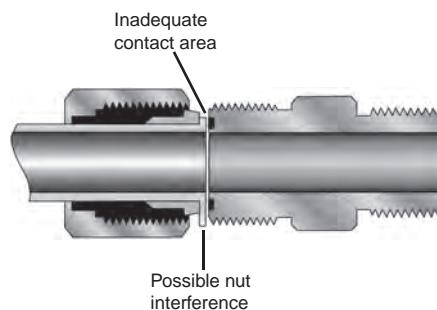

#### Brazed ORFS Connection

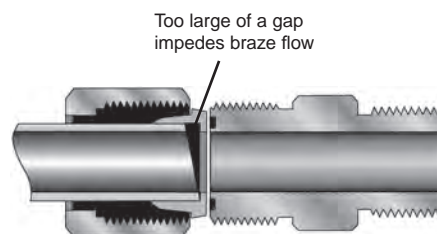

Fig. R14 – Results of Uneven Tube Cuts

TABLE OF CONTENTS

SECTION TABLE OF CONTENTS

FAQs



### Deburring

Lightly deburr the I.D. and O.D. of the tube end to remove burrs and sharp edges. Use a hand deburring tool or power deburring tool (shown on page Q22), or emery paper if using tube cutter (for soft tube). Use front mounted deburring tools if using TP432 or TP1025 tube preparation center found on page Q56.

**Note:** Point tube end downward during deburring to keep chips from entering the tube.

### Cleaning

Remove metal chips from I.D. with a brush or compressed air. Wipe the I.D. and the O.D. of the deburred tube end with a clean rag. Debris present in the tube end can result in system contamination or can get embedded into the flange or flare, causing imperfections that are potential leak paths.

## Seal-Lok O-Ring Face Seal Fittings

The proper assembly of the Seal-Lok fitting requires several steps, each important in guaranteeing a leak-free connection and a long service life:

1. Cutting, deburring and cleaning the tube
2. Sleeve Attachment
3. Inspection of sleeve attachment
4. Final installation

For cutting, deburring and cleaning see pages R12-R13, or refer to the detailed blog post and video on [www.TFDtechconnect.com](http://www.TFDtechconnect.com).

For recommended minimum and maximum tube wall thickness for Seal-Lok fittings, please refer to Table R9 and R10 on page R14.

### Sleeve Attachment

Attaching the sleeve to the tube end is the next critical assembly step. This can be accomplished by two methods: flanging or brazing.

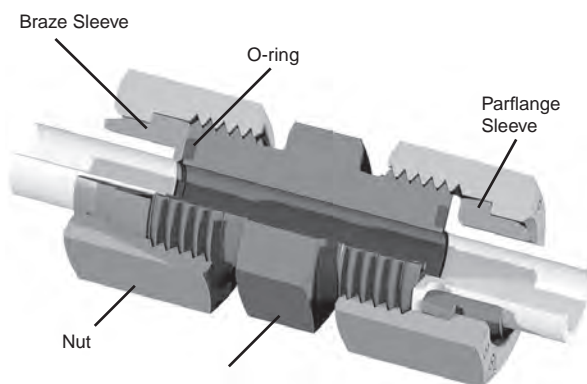

Fig. R15 – Seal-Lok Union cutaway with flanged and brazed assemblies

### Flanging

The flanging method requires the use of an appropriate forming machine to create the flange or flat face on the tube end. Since the flat face of the flanged tube seals against the O-ring within the fitting groove, it is important that this surface be relatively smooth. Proper tube end preparation (cutting, deburring and cleaning) will help accomplish this goal.

The Parker Parflange® machines utilize an orbital cold forming process to produce a flat, smooth, rigidly supported 90° sealing surface on the tube end.

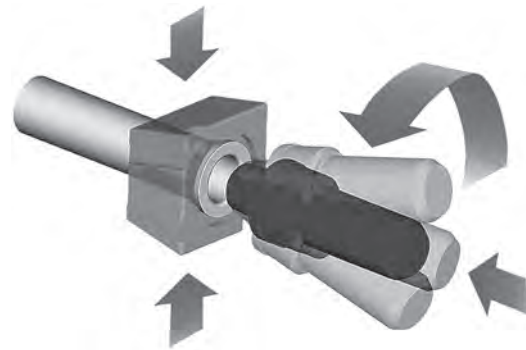

Fig. R16 – Parker's exclusive orbital spindle motion produces a perfect flange every time

Parker offers three Parflange machine options: ECO 25, 1025, and Pro 50. These models range in portability, cycle times, and tube size capability. For additional information on the Parflange machines and tooling, refer to section R of this catalog or see [www.TFDToolSpec.com](http://www.TFDToolSpec.com).



Fig. R17 – Parflange 1025 machine

TABLE OF CONTENTS

SECTION TABLE OF CONTENTS

FAQs

**Flanging Steps:**

1. Determine the extra cut-off length required for the Parflange process by referring to Tables R9 and R10. (Each table is only a guide. Variations in tube wall thickness and inconsistency in quality of tube cut-off may affect actual dimensions. User should verify actual extra tube cut-off length with one or two flanges prior to large scale flanging.)
2. Select the proper tooling for the tube size. The tube OD, wall thickness and material must be known for proper selection. Refer to Table R11 on page R15 for flanging capability by Parflange machine and availability of tooling

3. With the sleeve properly positioned within the die set, place the die set into the die holder of the machine.
4. Insert the tube through the die opening until it comes in contact with the tube stop. Do not forget to position the tube nut over the tube in the proper orientation, especially if the other tube end has already been flanged, or the tube has sharp bends.
5. Flange the tube as shown in Figure R17.

**Note:** For more information on Parflange procedures, machines, required tooling, etc., see [www.TFDToolSpec.com](http://www.TFDToolSpec.com).

TABLE OF CONTENTS

SECTION TABLE OF CONTENTS

FAQs

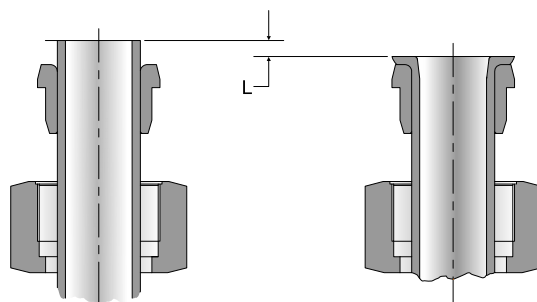

Fig. R18 – Extra cut-off length

Tube O.D. (in.)	Tube Wall Thickness – Inch										
	.028	.035	.049	.065	.083	.095	.109	.120	.134	.156	.188
1/4	3/16	13/64	7/32								
3/8		5/32	3/16	13/64	15/64	1/4					
1/2		9/64	9/64	3/16	13/64	9/32	19/64	19/64			
5/8			11/64	3/16	13/64	1/4	17/64	17/64			
3/4			11/64	3/16	7/32	7/32	1/4	17/64	9/32		
1				3/16	3/16	13/64	15/64	1/4	19/64		
1 1/4				11/64	3/16	13/64	15/64	1/4	19/64	19/64	21/64
1 1/2				13/64	15/64	15/64	1/4	17/64	19/64	23/64	3/8

Table R9 – Extra tube cut-off length guide for inch tube

Tube O.D. (in.)	Metric Tube Outside Diameter – (mm)								
	6	8	10	12	16	20	25	30	38
1.0	3/16	7/32	1/8	5/32	9/64				
	5.2	5.7	3.1	4.1	3.6				
1.5	17/64	15/64	13/64	7/32	11/64				
	6.7	5.9	5.1	5.4	4.2				
2.0			13/64	15/64	3/16	7/32	15/64	17/64	9/32
			5.3	6.1	4.9	5.4	6.1	6.6	7.2
2.5				17/64	7/32	15/64	1/4	19/64	
				6.7	5.5	6.1	6.4	7.6	
3.0					15/64	17/64	9/32	5/16	19/64
					5.8	6.7	7.2	7.9	7.7
3.5						17/64	19/64	21/64	
						6.9	7.5	8.5	
4.0						9/32	5/16	11/32	11/32
						7.2	8.0	8.6	8.7
5.0							11/32		3/8
							8.8		9.4

Table R10 – Extra tube cut-off length guide for metric tube

Another consideration prior to flanging is the minimum straight length to the start of a 90° bend. Table R11 provides this information.

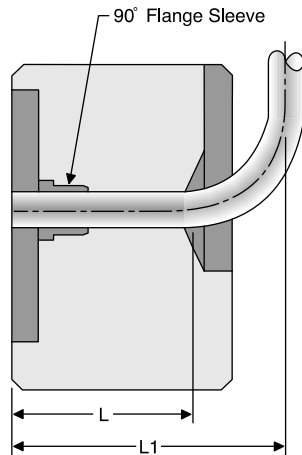

**Fig. R19 – Minimum straight length to start of bend for 90° flanging**

Tube O.D. Inch Sizes	Tube O.D. Metric Sizes	L*		L1**	
		(in.)	(mm)	(in.)	(mm)
1/4"	6	1 5/16	35	3 1/8	79
5/16"	8	1 5/16	35	3 5/32	80
3/8"	10	1 5/16	40	3 3/16	81
1/2"	12	1 3/8	40	3 1/4	82
	15	1 3/8	40	3 5/16	84
5/8"	16	1 1/2	41	3 5/16	84
	18	1 5/8	42	3 11/32	85
3/4"	20	1 3/4	50	3 3/8	86
	22	1 7/8	50	3 7/16	87
	25	1 7/8	50	3 1/2	89
1"	28	1 7/8	50	3 9/16	90
	30	1 7/8	50	3 19/32	91
1 1/4"	32	1 7/8	50	3 5/8	92
	35	2	50	3 11/16	94
1 1/2"	38	2	50	3 3/4	95

**Table R11 – Minimum straight length to start of bend for 90° flanging**

**Notes:**

- \* L is the minimum straight length to the start of tube bend.
- \*\* L1 is the minimum centerline dimension necessary for 90° bent tube to clear the frame of the Parflange machine. In bending of the tubes, use radius blocks which will ensure that L1 dimensions are met or exceeded.

**Flange Inspection**

The flange should be inspected for proper diameter and sealing surface quality. Table R12 provides the flange diameters for the different sizes. The sleeve can also be used as a quick gauge of the flange diameter. Visually compare the flange diameter to the tapered surface located at the front end of the sleeve (right behind the flange). The large diameter and small diameters at each end of this surface serve as the maximum and minimum flange diameter limits, respectively.

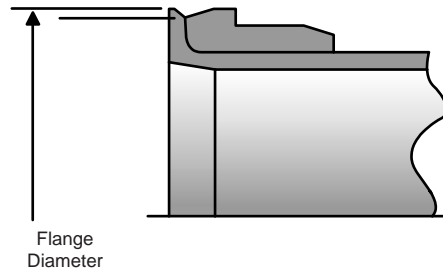

**Fig. R20 — Flange diameter**

Inch Tube O.D. (in.)	Metric Tube O.D. (mm)	Flange Diameter (in.)
1/4	6	.478 / .502
3/8	10	.594 / .620
1/2	12	.719 / .744
5/8	14, 15, 16	.875 / .923
3/4	18, 20	1.048 / 1.096
1	22, 25	1.298 / 1.346
1-1/4	28, 30, 32	1.549 / 1.597
1-1/2	38	1.861 / 1.909

**Table R12 – Flange dimensions**

TABLE OF CONTENTS

SECTION TABLE OF CONTENTS

FAQs

R

Over-flanging will result in tube nut interference, as well as thinning of the flange tube end. Under-flanging reduces the contact area for sealing against the O-ring in the fitting.

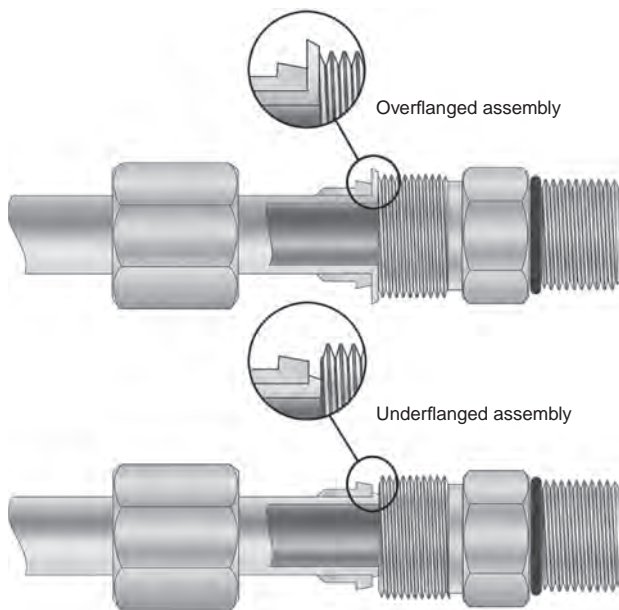

Fig. R21 – Overflanging and Underflanging

**Advantages of Parflange process**

There are numerous advantages to using the Parflange process over the braze or weld process:

- The Parflange process is several times faster than the brazing or welding methods. For instance, the 1025 model can produce flanges at a rate of 9 to 12 times the speed of comparable induction brazing.
- The Parflange process does not require any special pre- or post-flange cleaning of the tube and sleeve.
- Unlike brazing, the Parflange process does not require any flux, braze alloy, post braze cleaner or rust inhibitor. An environmentally safe lubricant applied to the flanging pin is the only additive associated with the Parflange.
- The Parflange process is inherently safe. It does not require open flame or any form of heating. Additionally, there is no emission of hazardous fumes, as is typical with welding and brazing.
- The Parflange process uses only a fraction of the energy needed for welding or brazing.
- The Parflange process accommodates the use of plated components (i.e., tube and sleeve), thus eliminating the need to electroplate assemblies after fabrication.
- The Parflange process eliminates the potential for leaks at the braze or weld joint.
- The Parflange process produces a burnished sealing surface, typically much smoother than the 125 micro-inch requirement of SAE J1453.

**Brazing**

Brazing is the other method of attaching the sleeve to the tube end. This process can be accomplished by using a multi-flame torch, as shown in Fig. R22, or an induction brazing unit. (Note: multi-flame torches and induction brazing units are not available through Tube Fittings Division). During the heating process, the pre-formed braze ring or wire-fed filler material is melted between the tube O.D. and the sleeve I.D., creating a strong bond between the two.



Fig. R22 – Multi-flame torch brazing

**Brazing Steps:**

1. Determine the tube length allowance using Table S13.

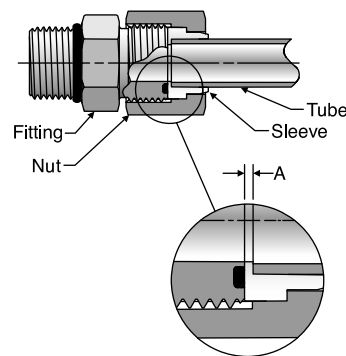

Fig. R23 – Tube length allowance

Nominal Tube O.D.		A (in.)
Inch	Metric	
1/4	6	0.04
3/8	8, 10	0.04
1/2	12	0.04
5/8	14, 15, 16	0.06
3/4	18, 20	0.06
1	22, 25	0.06
1 1/4	28, 30, 32	0.06
1 1/2	35, 38	0.06

Table R13 – Tube length allowance

TABLE OF CONTENTS

SECTION TABLE OF CONTENTS

FAQs



- 2. Cleaning the tube end:** All oil and oxide build-up must be removed from the tube end for at least the length of the braze joint. Oil may be removed by using an oil-free solvent. Oxide build-up may be removed by pickling or by lightly sanding with an aluminum-free emery paper.
- 3. Fixturing the parts for brazing:** Care should be taken so the braze fixture allows the sleeve to settle and bottom on the tube completely during heating. Since the Seal-Lok fitting sleeve is designed for a slip fit, this should happen easily. Short tubes can be brazed in the vertical position. On longer tubes, the joint may need to be in the horizontal position, requiring a slight nudge to seat the sleeve on the tube.
- 4. Applying flux:** Apply proper flux to tube end (about 1½ sleeve lengths) and sleeve's face and outside surface. Insert appropriate braze ring in the sleeve and place the sleeve on end of the tube. The flux helps protect the parts from oxidizing and promotes braze flow.
- 5. Heating the part:** Apply heat uniformly to the joint by using a multi-flame torch as shown in Fig. R22 or with an induction braze unit. Proper brazing involves heating the assembly to brazing temperature and flowing the filler metal through the joint. Heat should be applied broadly and uniformly to the tube as well as the Seal-Lok sleeve. Keep in mind that thicker fitting and tubing sections take longer to heat. The entire assembly should heat to brazing temperature at about the same time. The braze alloy will always flow towards the area of higher temperature. The pre-formed braze ring has been placed inside the joint area—the last area to reach melting temperature. Therefore, when you see the braze material flow to the outside of the joint, you know the joint is complete. If the sleeve does not settle, a slight pressure will cause the sleeve to settle, completing the braze joint.
- 6. Cleaning the brazed joint:** After stopping heat application, allow about 10 seconds for the braze alloy to solidify. Then, immerse the joint in hot water (approx. 140°F.). To make cleaning easier, add braze cleaner to the hot water. This sudden cooling cracks the braze flux residue, making it easier to remove. Any remaining residue can be removed by careful wire brushing, making sure not to scratch the sealing surface of the sleeve.
- 7. Corrosion protection after brazing:** This is an extremely important step following brazing and even more so following the use of a braze cleaner. Braze cleaners available from Parker are used to facilitate the removal of residual flux after brazing, however are generally corrosive. The residue left on the surface by the cleaner, especially on the I.D. of the tube, can cause rusting in carbon steel tubes rather quickly, if it is not neutralized. Therefore, it is important to neutralize the cleaner residue after cleaning with a solution such as Bernite 136<sup>2</sup> (mix 4 ounces of Bernite 136 with one gallon of water). If the brazed parts are not to be used soon after brazing, a coating of rust inhibitors such as WD-40<sup>3</sup> or SP-350<sup>4</sup> is recommended for the braze and heat affected area.

2 ) Products of Bernite Products, Inc. 84 New York, Westbury, NY 11500 (516) 338-4646.

3 ) A product of WD-40 Company, San Diego, CA 92220.

4 ) A product of CRC Chemicals, USA, Warminster, PA 18974 (215) 674-4300

## Inspection of Brazing

Inspect the braze for a fillet all the way around the tube at the far end (small diameter) of the sleeve.

**Caution:** If there are gaps in the fillet, the joint may not be sound. In this case, rebrazing is recommended. Remove the sleeve and rebraze a new one in its place.

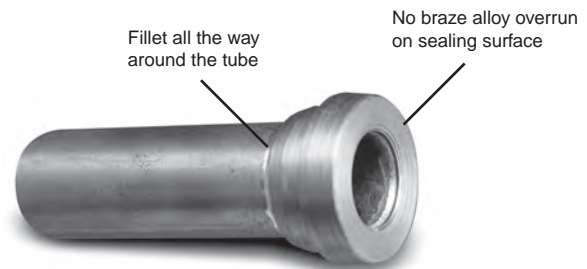

Fig. R24 – Brazed fitting

Inspect the sealing surface. There should be no braze alloy overrun or build-up on this surface. If there is build-up, remove it with emery paper, being careful not to scratch the seal surface. If this is not possible, remove the old sleeve and rebraze a new one in its place.

## Final Installation

The following steps are required for final installation of the Seal-Lok fitting:

1. Ensure that the seal is properly installed in the groove of the face seal. Parker provides Seal-Lok fittings with pre-installed trap seals on the groove of the face seal. However, if the seal is being replaced, standard round O-Ring face seal O-rings can be found on page M4, in section M. Since Seal-Lok is machined with the Captive O-ring Groove (CORG), it is recommended that a CORG assembly tool be utilized, as shown in Fig. R25. To properly use the assembly tool, follow these steps
  - Position the O-ring inside the CORG assembly tool against the pusher.
  - Position the tool over the Seal-Lok tube end until the end is bottomed in the tool.
  - Push the plunger of the tool until the O-ring is inserted and seated into the groove.



Fig. R25 – O-Ring installation using the CORG assembly tool



2. Place the tube assembly against the fitting body so that the flat face of the flange tube (or braze sleeve) comes in full contact with the O-ring. Thread the nut onto the fitting body by hand and tighten it to the recommended torque represented in Table R14. If torque wrenches are not available, an alternate method of assembly is the Flats From Wrench Resistance (F.F.W.R.) method. Wrench tighten the nut onto the fitting body until light wrench resistance is reached. Tighten further to the appropriate F.F.W.R. value.

**Caution: The torque method of assembly is the preferred method of assembly for Seal-Lok fittings. It reduces the risk of human error during assembly that is more prevalent in the Flats From Wrench Resistance (F.F.W.R.) method. To ensure the most accurate assembly of the Seal-Lok fitting, it is strongly recommended that the torque method be utilized.**

**Note:** A second wrench may be required to prevent the fitting from moving during assembly.

TABLE OF CONTENTS

SECTION TABLE OF CONTENTS

FAQs

O.D.		SAE Dash Size	Tube Side Thread Size (UN/UNF)	Tube Side Assembly Torque (+10% -0%)			Flats from Wrench Resistance (F.F.W.R.)	
(in.)	(mm)			in.-lb.	ft.-lb.	N-m	Tube Nuts	Swivel & Hose Ends
1/4	6	-4	9/16-18	220	18	25	1/4 to 1/2	1/2 to 3/4
3/8	8, 10	-6	11/16-16	360	30	40	1/4 to 1/2	1/2 to 3/4
1/2	12	-8	13/16-16	480	40	55	1/4 to 1/2	1/2 to 3/4
5/8	14, 15, 16	-10	1-14	—	60	80	1/4 to 1/2	1/2 to 3/4
3/4	18, 20	-12	1 3/16-12	—	85	115	1/4 to 1/2	1/3 to 1/2
1	22, 25	-16	1 7/16-12	—	110	150	1/4 to 1/2	1/3 to 1/2
1 1/4	28, 30, 32	-20	1 11/16-12	—	150	205	1/4 to 1/2	1/3 to 1/2
1 1/2	35, 38	-24	2-12	—	230	315	1/4 to 1/2	1/3 to 1/2
2	50	-32	2 1/2-12	—	375	510	1/4 to 1/2	1/3 to 1/2

**Table R14 – Seal-Lok assembly torque and F.F.W.R. For brass, aluminum (and other soft metals) decrease torque value by 35%, however F.F.W.R. is the same.**

**Note:** Assembly torque values are for unlubricated carbon steel components and properly lubricated stainless steel components. All stainless steel Seal-Lok tube nuts have an anti-seize lubricant to prevent galling during assembly. No additional lubricant is needed unless the tube nuts are washed or heated above 150°F.

Dimensions and pressures for reference only, subject to change.

# FastSeal Assembly Instructions and Troubleshooting

FastSeal assembly consists of the following steps:

1. Prep - cutting, deburring and cleaning of the tube
2. Pre-set
3. Pre-set inspection
4. Final installation

## 1. Prep

To start, please select your tubing OD and wall thickness using Table R15.

Tube OD	Wall Thickness			
	0.035	0.049	0.065	0.083
1/4"	X	X		
3/8"		X	X	
1/2"		X	X	X

**Table R15 – Recommended inch tube OD and wall thickness – carbon steel**

See the proper tube end preparation steps provided previously in this Assembly and Installation section or [watch our techConnect Tube End Preparation Video](#).

### ⚠ CRITICAL STEP:

A heavy deburr, per Fig. R26 of at least 1 mm on the tube is recommended to prevent damage to the internal O-ring. Ensure tube is clean and all chips and debris have been removed from the tube. The deburr dimension can be checked visually (roughly the thickness of a coin) or with the depth gauge on the back end of the marking tool.

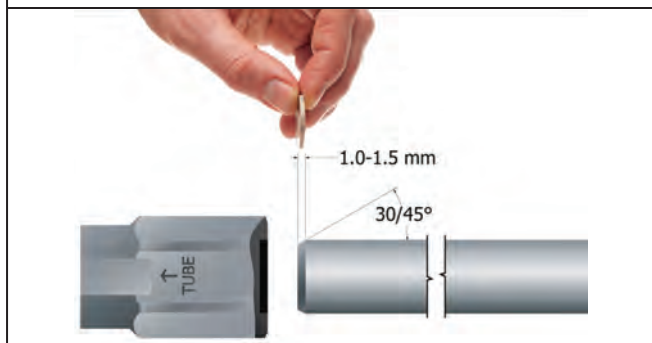

**Fig. R26 – Recommended deburr**

## 2. Pre-Set

FastSeal connections require pre-setting that can be accomplished by hand with a wrench and is best done with the assistance of a fixed vice.



**Step 1** – Place marking tool on tube until it bottoms out. Mark around OD as shown. If marking tool is not available, use insertion depths shown in **Table R16**.



**Step 2** – Thread FastSeal nut onto fitting body or mandrel hand tight. This is best completed with the assistance of a fixed vice if available.



**Step 3** – Lubricate the end of the tube with hydraulic oil to help with insertion in the next step.



**Step 4** – Insert the tube into the FastSeal nut to the tube depth mark. Twist and push tube to aid the insertion. You will feel the tube pop past the O-ring and bottom out.



**Step 5** – Mark the nut and body as shown to assist with the FFFT preset.



**Step 6** – Tighten the nut to specified FFFT of 7-8 flats. You should feel a perceptible torque rise around 7 flats.

TABLE OF CONTENTS

SECTION TABLE OF CONTENTS

FAQs

R

Tube OD	Depth - in (mm)
1/4"	0.62 (16)
3/8"	0.66 (17)
1/2"	0.71 (18)

Table R16 – Tube Insertion Depths

### 3. Pre-set Inspection

The gap closure is an important visual inspection to make after presetting the **FastSeal** nut. A “closed gap” can vary from 0-0.01” (0-0.25mm). This small gap may be caused by spring back of the material and will close when the parts are tightened at final assembly.



Loosen and back off nut to inspect the sleeve gap to ensure it has closed.  
(see Fig. R27).

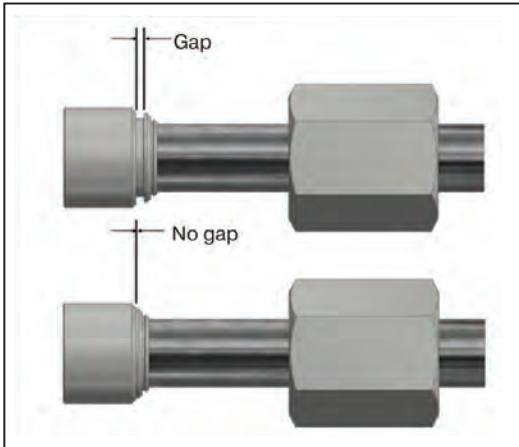

Fig. R27 – Gap Closure Inspection Reference

### 4. Installation

Once the gap is confirmed closed, assemble tube to fitting body and torque to the values shown in Table R17.

Tube OD	Torque – in-lb (Nm)
1/4"	220 (25)
3/8"	360 (40)
1/2"	480 (55)

Table R17 – Final Assembly Torque

*Parker's patent-pending FastSeal creates quick leak-free permanent ORFS tube end connections with just a wrench. Get more details on this new technology now.*

TABLE  
OF  
CONTENTS

SECTION  
TABLE OF  
CONTENTS

FAQs

## FastSeal Troubleshooting

TABLE  
OF  
CONTENTS

SECTION  
TABLE OF  
CONTENTS

FAQs

<b>Unsure if tube is bottomed</b>	Use tube marking tool or insertion depths in Table R16 to mark tube prior to insertion and to identify if you have met appropriate depth when tube is inserted into nut.
<b>Unable or difficult to push tube into nut</b>	<p>Tube may be oversized or oval. Use tube making gauge to check for correct size and ovality. If tube does not fit in gauge do not use, select another tube and use gauge to verify the size and ovality before using.</p> <p style="text-align: center;"><b>OR</b></p> <p>Ensure nut was not tightened more than hand tight onto fitting or mandrel body before inserting tube. Do not wrench tighten nut before tube is fully inserted this may cause bite ring to begin to preset, interfering with tube insertion.</p>
<b>Tube will not push to marked depth on tube</b>	Avoid O-ring damage, <b>DO NOT FORCE TUBE</b> . Remove tube and ensure tube is properly deburred to at least 0.040in (1.0 mm) and is cleaned thoroughly. Inspect the tube to ensure it is round, within dimensional specs (should easily fit in tube marking gauge). Ensure a small amount of oil is applied to end of tube before inserting, use slight twist when inserting. <b>DO NOT FORCE, DO NOT USE A HAMMER.</b>
<b>Gap not closed after presetting</b>	If gap of more than 0.01in (0.25mm) is detected, reassemble to last marked position, tighten nut ½ additional flat, inspect gap for closure.
<b>Leaks at low pressure</b>	Internal O-ring may be damaged. Contact Division for assistance.
<b>Leaks at high pressure</b>	Inspect the ferrule and sleeve to confirm there was no gap after presetting. Ensure connection was tightened to proper Seal-Lok assembly torque per table S14 4300 catalog. Confirm Seal-Lok trap seal is not damaged or missing. Internal O-ring may be damaged. Contact Division for assistance.
<b>Tube moves in nut after presetting or final assembly</b>	Preset was not done correctly. <b>DO NOT USE CONNECTION</b> . Remake tube assembly.
<b>Tube pulls out of nut after preset</b>	Preset was not done correctly, tube too hard. <b>DO NOT USE CONNECTION</b> . Check tube material, wall thickness and size. FastSeal nuts are intended for use with low carbon steel seamless or DOM tube intended for hydraulic applications (reference SAE J524/J525).
<b>Unsure what tubes to use</b>	FastSeal nuts are intended for use with low carbon steel seamless or DOM tube intended for hydraulic applications (reference SAE J524/J525). Use of the correct tube wall is critical to meet performance criteria. Recommended tube walls can be found in <b>Table R15</b> .

R

# Universal Push-to-Connect (UPTC)

## Assembly and Installation

UPTC Seal-Lok subassembly utilizes standard Seal-Lok assembly torques, as shown in Table R18.

Size	Torque (+/-10%)		
	in.-lb.	ft.-lb.	N-m
-4	220	18	25
-6	360	30	40
-8	480	40	55
-10	—	60	80
-12	—	85	115

Table R18 – UPTC Seal-Lok Assembly Torque

TABLE  
OF  
CONTENTS

SECTION  
TABLE OF  
CONTENTS

FAQs



# Seal-Lok Troubleshooting Guide

## O-Ring Face Seal

TABLE  
OF  
CONTENTS

SECTION  
TABLE OF  
CONTENTS

FAQs

CONDITION	PROBABLE CAUSE(S)	RECOMMENDATION
Immediate leakage when system is pressurized	<ul style="list-style-type: none"> <li>Improper tightening of joint</li> </ul>	<ul style="list-style-type: none"> <li>Check for O-ring damage and re-tighten connection to the recommended torque value</li> </ul>
Under-flanged assembly	<ul style="list-style-type: none"> <li>Undersized tube diameter resulting in tube slippage during flanging</li> <li>Die gripping surface is worn or dirty</li> </ul>	<ul style="list-style-type: none"> <li>Verify that the O.D. is correct; if undersized, replace tube.</li> <li>Inspect die gripping surface; if clogged or excessively worn, clean or replace.</li> </ul>
Over-flanged assembly	<ul style="list-style-type: none"> <li>Sleeve is positioned incorrectly in die</li> </ul>	<ul style="list-style-type: none"> <li>Check for proper positioning of sleeve in die; if over-flanged, replace tubing</li> </ul>
Flange out-of-round	<ul style="list-style-type: none"> <li>Tubing was not cut properly</li> <li>Tube was not properly supported during flanging</li> <li>Tubing is eccentric</li> </ul>	<ul style="list-style-type: none"> <li>Cut tubing within <math>90^\circ \pm 1^\circ</math></li> <li>Support tubing so that tube end is perpendicular to tube stop during flanging</li> <li>Replace with quality tubing</li> <li>Replace out-of-round flanges</li> </ul>
Cracked flange	<ul style="list-style-type: none"> <li>Tubing too hard</li> </ul>	<ul style="list-style-type: none"> <li>Replace tubing using recommended quality tube</li> </ul>
Scored, pitted flange	<ul style="list-style-type: none"> <li>Improper deburring and cleaning of tube prior to flanging</li> <li>Flange pin not cleaned and lubricated properly</li> </ul>	<ul style="list-style-type: none"> <li>Replace flange using proper deburring and cleaning recommendations</li> <li>Keep flanging pin clean and working surfaces well lubricated.</li> </ul>
Leakage at braze joint	<ul style="list-style-type: none"> <li>Poor braze joint/improper joint clearance</li> <li>Mixing of sleeve and tube material</li> <li>Improper/inadequate flux, braze alloy overrun, or buildup on face</li> <li>Improper/inadequate braze temperature</li> </ul>	<ul style="list-style-type: none"> <li>Flux and reheat the joint, remove and replace with new sleeve</li> <li>Always use steel sleeves with steel tubing and stainless sleeves with stainless tubing</li> <li>Apply flux liberally to sleeve and tube end prior to brazing. Use recommended flux, braze alloy and brazing temperature.</li> </ul>
Leakage at face-seal end	<ul style="list-style-type: none"> <li>Misalignment or improper fit</li> <li>Damaged, pinched, improper, or missing O-ring</li> <li>Extruded O-ring</li> <li>Damaged fitting</li> <li>Braze overflow on sealing surface</li> </ul>	<ul style="list-style-type: none"> <li>Align tube end and connecting fitting properly before tightening tube nut, holding the flat face of the mating fitting against O-ring while tightening</li> <li>Replace O-ring, properly installing it in the face seal groove</li> <li>Replace O-ring and check for proper alignment and pressure surges exceeding rated pressure of fitting; tighten the nut to recommended torque or replace fitting if threads or sealing surface is grossly damaged.</li> <li>Remove and replace sleeve which has braze overflow on its sealing surface.</li> </ul>

Table R19 – Seal-Lok Troubleshooting guide

Dimensions and pressures for reference only, subject to change.

## Triple-Lok 37° Flare Fittings

For leak-free performance, the Triple-Lok fitting requires the following steps:

1. Cutting, deburring and cleaning of the tube
2. Flaring
3. Flare inspection
4. Installation

**Caution:** Use only seamless or welded and drawn tube that is fully annealed for flaring and bending. (See page S17 for tube/fitting material compatibility information.)

For proper tube end preparation see pages R12-R13, or refer to the detailed blog post and video on [www.TFDtechconnect.com](http://www.TFDtechconnect.com).

For the recommended minimum and maximum tube wall thickness for Triple-Lok fittings, please refer to Table S16 on page S27.

### Flaring

Several flaring methods are available, ranging from simple hand flaring to hydraulic/electric power flaring. Various tools for flaring are shown on pages Q31 through Q34. Power flaring is the preferred method as it is quicker and produces more accurate and consistent flares. Hand flaring should be limited to places where power flaring tools are not readily available. The Parflange machines shown on page Q23 also flare tube with an orbital flaring process and provide the best flare for steel and stainless steel tube.

Prior to flaring, determine the tube length allowance using Table R20. This tube length allowance should be added to the cut tube length to allow for the “loss” of tube caused by flaring.

Nominal Tube O.D.		A (in.)
(in.)	mm	
1/8	—	0.07
3/16	—	0.08
1/4	6	0.09
5/16	8	0.08
3/8	10	0.08
1/2	12	0.12
5/8	14, 15, 16	0.13
3/4	18, 20	0.15
7/8	22	0.15
1	25	0.15
1 1/4	30, 32	0.20
1 1/2	38	0.18
2	42	0.28

Table R20 — Tube length allowance

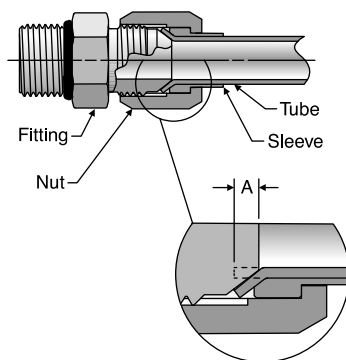

Fig. R28 — Tube length allowance



Fig. R29 — Flaring with Hydra-Tool



Fig. R30— Nuts and sleeves assembled before flaring

### Flare Inspection

Inspect flare for dimensions and surface quality. Table R21 shows the proper flare dimensions. The sleeve can also be used for a quick check of the flare dimensions as shown in Fig. R31.

Inch Tube O.D. (in.)	Metric Tube O.D. (mm)	37° Flare Diameter ØA (in.)
1/4	6	.340/.360
5/16	8	.400/.430
3/8	10	.460/.490
1/2	12	.630/.660
5/8	15 & 16	.760/.790
3/4	18 & 20	.920/.950
1	25	1.170/1.200
1 1/4	30 & 32	1.480/1.510
1 1/2	38	1.700/1.730

37° Flare Dimensions

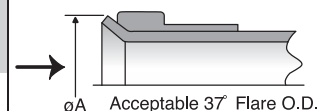

Table R21 — 37° Flare Dimensions

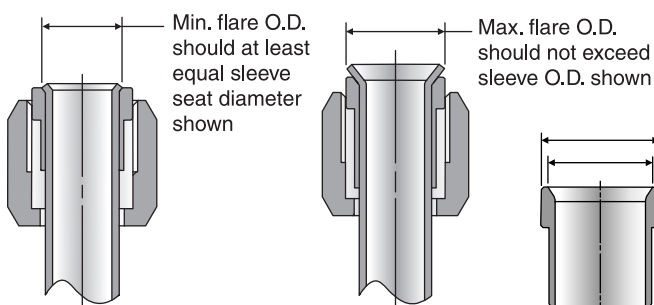

Fig. R31 — Comparing flare O.D. with sleeve seat and O.D.

Flare tube end using one of the flaring tools and following its operating instructions or see [www.TFDToolSpec.com](http://www.TFDToolSpec.com). Fig. R29 shows flaring with Hydra-Tool.

**Note:** Be sure to insert a nut and a sleeve in proper sequence and orientation before flaring either end of a bent tube, or second end of a straight tube (see Fig. R29).

**Underflaring** (see Fig. R32) reduces contact area causing excessive nose collapse and leakage in extreme cases the tube may pull out under pressure.

**Overflaring** (see Fig. R32) causes tube nut thread interference, either preventing assembly altogether, or giving a false sense of joint tightness resulting in leakage.

TABLE OF CONTENTS

SECTION TABLE OF CONTENTS

FAQs

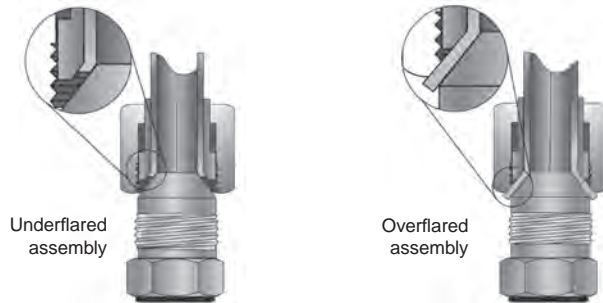
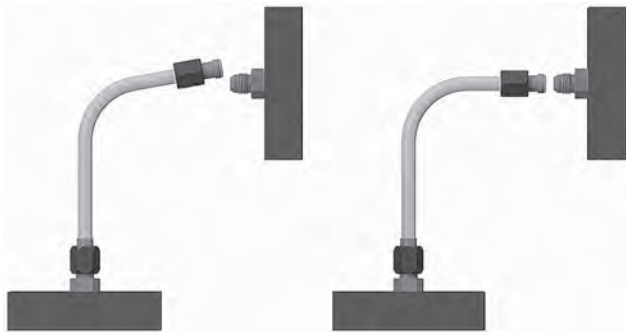

**Fig. R32 – Underflaring and overflaring**

The flare must be reasonably square and concentric with the tube O.D. Its surface must be smooth, free of rust, scratches, splits, weld beads, draw marks, embedded chips, burrs or dirt. If the flare does not meet the above requirements, cut it off, determine the probable cause from the troubleshooting guide shown in Table R26, take corrective action and re-flare.

## Installation

Proper installation is critical for a trouble free operation. Improper flaring or installation causes over half of the leakage with flared fittings.



**Fig. R33 – Improper bend and short tube**

Align the tube on the flare (nose) of the fitting body and tighten the nut using one of two methods described below.

1. Flats from Wrench Resistance (FFWR) or “Flats” method
2. Torque method

**Note:** Do not force an improperly bent tube into alignment (Fig. R31) or draw-in too short a tube using the nut. It puts undesirable strain on the joint leading, eventually, to leakage.

### Flats Method

Tighten the nut lightly with a wrench (approximately 30 in.lb.), clamping the tube flare between the fitting nose and the sleeve. This is considered the Wrench Resistance (WR) position. Starting from this position, tighten the nut further by the number of flats from Table R22. A flat is referred to as one side of the hexagonal tube nut and equates to 1/6 of a turn.

This Flats method is more forgiving than the torque method. It circumvents the effects of differences in plating, lubrication, surface finishes, etc., that greatly influence the torque required to achieve proper joint tightness or clamping load.

Therefore, it is recommended to use this method wherever possible, and especially where the plating combination of components is not known, and during maintenance and repair where the components may be oily. Use Table R22 as a guide for proper tightening method.

Condition	Recommended Tightening Method
1. Plating of all components is the same.	Either method is acceptable. Use Table R19.
2. Plating is mixed.	Use FFWR method.
3. Plating of nut and sleeve or hose end is unknown.	Use FFWR method.
4. Parts are oily.	Use FFWR method.
5. Stainless or brass components.	Use FFWR method.

**Table R22 – Joint tightening method guide**

Parker also recommends that wherever possible, the step of marking the nut position relative to the body should be done. This step serves as a quick quality assurance check for joint tightening. To do this, at the initial wrench resistance position, make a longitudinal mark on one of the flats of the nut and continue it on to the body hex with a permanent type ink marker as shown in Fig. R34a. Then, at the properly tightened position, extend the previous mark on the nut hex to the body hex, as shown in Fig. R34b.

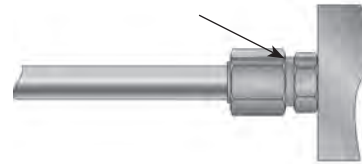

**Fig. R34a – Tighten Joint to Wrench Resistance (Approximately 30 in-lb). Make reference mark on nut and fitting body.**

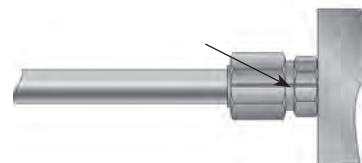

**Fig. R34b – For initial assembly only, tighten by number of flats recommended in Table R23. Make a second reference mark on fitting body, lined up with mark on nut; 1 FFWR shown. See page R26 for reassembly procedure.**

These marks serve two important functions:

1. The displaced marks serve as a quick quality assurance check that the joint has been tightened.
2. The second mark on the body serves as a proper tightening position after a joint has been loosened.

The flats method is slower than the torque method, but it has the two distinct advantages described earlier: circumvention of plating differences and a quick visual check for proper joint tightening.

TABLE  
OF  
CONTENTS

SECTION  
TABLE OF  
CONTENTS

FAQs

R

### Torque Method

With proper tube flare alignment with the nose of the fitting, tighten the nut to appropriate torque value in Table R19. This method is fast and accurate when preset torque wrenches are used. Consistent component selection is recommended so that the effects of dissimilar plating is not an adverse factor in joint integrity. This makes it desirable for high production assembly lines. However, a joint assembled using the torque method can only be checked for proper tightening by torquing it again.

**Note:** This method should not be used if the type of plating on the fitting and mating parts (sleeve + nut or hose swivel) is not known. The torque method should not be used for lubricated or oily parts as improper clamping forces may result. Over-tightening and fitting damage may occur as a result.

### Triple-Lok Reassembly Method

Prior to loosening the joint, make a reference mark as seen in Fig. R34b. After the joint is loosened, this reference mark will represent the correct tightening position upon reassembly. When tightening the joint, ensure the mark on the nut lines up with, or is slightly past, the mark on the fitting body. Torque method is not recommended for reassembly.

*How many times can you reassemble a 37-degree flare fitting? Read our article for what you need to know.*



Tube O.D.		SAE Dash Size	Thread Size	Assembly Torque* (+10% -0)		Tube Connection FFWR	Swivel Nut or Hose Connection FFWR
(in.)	(mm)			in. lb.	ft. lb.		
1/8	—	-2	5/16-24	35	3	—	—
3/16	—	-3	3/8-24	65	5	—	—
1/4	6	-4	7/16-20	155	13	2 1/2	2
5/16	8	-5	1/2-20	165	14	2	2
3/8	10	-6	9/16-18	265	22	2	1 1/2
1/2	12	-8	3/4-16	505	42	2	1 1/2
5/8	14, 15, 16	-10	7/8-14	720	60	1 1/2	1 1/2
3/4	18	-12	1 1/16-12	1000	84	1 1/2	1 1/4
7/8	22	-14	1 3/16-12	1200	100	1 1/2	1 1/4
1	25	-16	1 5/16-12	1415	118	1 1/2	1
1 1/4	28, 30, 32	-20	1 5/8-12	2015	168	1	1
1 1/2	35, 38	-24	1 7/8-12	2340	195	1	1
2	42, 50	-32	2 1/2-12	3180	265	1	1
2 1/2	—	-40	3-12	—	—	1	1

Table R23 – Triple-Lok assembly torques and FFWR

**Notes:**

1. Assembly Torque: Torque values are for unlubricated carbon steel components and properly lubricated stainless steel components. All stainless steel Triple-Lok tube nuts have an anti-seize lubricant to prevent galling during assembly. No additional lubricant is needed unless the tube nuts are washed or heated above 150°F. Stainless steel fittings use the upper limit of torque range.
2. FFWR: The Flats From Wrench Resistance or “Flats” method is recommended for steel, stainless steel and brass components. Torque and FFWR: Torques and FFWR shown in the chart are for use with the tube materials, wall thickness, etc. recommended by Parker Hannifin Tube Fittings Division for use with Parker Triple-Lok fittings.
3. For brass and aluminum fittings, use approximately 65% of the torque values shown, unlubricated, however FFWR is same for all materials.
4. Reference Fig. R34a and R34b for example of FFWR method.
5. FFWR values are for initial assembly only.

Dimensions and pressures for reference only, subject to change.

# Hydra-Tool

## Recommended Flaring Pressures For Metric Tube

Size (mm)	Material	Tube Wall Thickness					Min. Straight Length to Start of Bend
		1.0	1.5	2.0	2.5	3.0	
6	SS	400	700	1100			1-5/8
	Steel	300	500	800			
	Copper	150	200	350			
	Aluminum	150	200	350			
8	SS	500	800	1300			1-5/8
	Steel	400	600	1000			
	Copper	150	250	400			
	Aluminum	150	250	400			
10	SS	600	900	1500			1-5/8
	Steel	500	700	1100			
	Copper	200	300	500			
	Aluminum	200	300	500			
12	SS	800	1200	2000	2500		2-3/16
	Steel	600	900	1500	1900		
	Copper	250	350	600	750		
	Aluminum	250	350	600	750		
16	SS	900	2000	2500	2800	3000	2-5/16
	Steel	680	1500	1900	2100	2300	
	Copper	275	600	750	800	900	
	Aluminum	275	600	750	800	900	
18	SS	1000	1700	2500	3100	3500	2-5/16
	Steel	750	1300	1900	2300	2700	
	Copper	300	500	750	900	1100	
	Aluminum	300	500	750	900	1100	
20	SS		1500	2400	3000	3400	2-7/16
	Steel		1100	1800	2300	2600	
	Copper		500	700	900	1000	
	Aluminum		500	700	900	1000	
25	SS			2400	3000	3400	2-7/16
	Steel			1800	2300	2600	
	Copper			700	900	1000	
	Aluminum			700	900	1000	
30	SS			2800	3400	4000	2-1/2
	Steel			2100	2600	3000	
	Copper			800	1000	1200	
	Aluminum			800	1000	1200	
32	SS				4000	4500	2-7/8
	Steel				3000	3400	
	Copper				1200	1300	
	Aluminum				1200	1300	
38	SS				4500	5800	2-7/8
	Steel				3400	4400	
	Copper				1300	1700	
	Aluminum				1300	1700	
42	SS				4700	6500	2-7/8
	Steel				3600	5200	
	Copper				1500	1900	
	Aluminum				1500	1900	
50	SS				5200	7200	2-7/8
	Steel				3900	6100	
	Copper				1900	2300	
	Aluminum				1900	2300	

Table R24 — Recommended Flaring Pressures, Metric Tube

TABLE OF CONTENTS

SECTION TABLE OF CONTENTS

FAQs

R



# Hydra-Tool

## Recommended Flaring Pressures For Inch Tube

TABLE  
OF  
CONTENTS

SECTION  
TABLE OF  
CONTENTS

FAQs

Size	Material	Tube Wall Thickness								Minimum Straight Length To Start of Bend
		0.035	0.049	0.065	0.083	0.095	0.109	0.120	0.134	
4	SS	400	700	1100						1-5/8
	Steel	300	500	800						
	Copper	150	200	350						
	Aluminum	150	200	350						
5	SS	500	800	1300						1-5/8
	Steel	400	600	1000						
	Copper	150	250	400						
	Aluminum	150	250	400						
6	SS	600	900	1500						1-5/8
	Steel	500	700	1100						
	Copper	200	300	500						
	Aluminum	200	300	500						
8	SS	800	1200	2000	2500					2-3/16
	Steel	600	900	1500	1900					
	Copper	250	350	600	750					
	Aluminum	250	350	600	750					
10	SS	900	2000	2500	2800	3000				2-5/16
	Steel	680	1500	1900	2100	2300				
	Copper	275	600	750	800	900				
	Aluminum	275	600	750	800	900				
12	SS	1000	1700	2500	3100	3500	4000			2-5/16
	Steel	750	1300	1900	2300	2700	3000			
	Copper	300	500	750	900	1100	1200			
	Aluminum	300	500	750	900	1100	1200			
14	SS		1500	2400	3000	3400	4200			2-7/16
	Steel		1100	1800	2300	2600	3200			
	Copper		500	700	900	1000	1300			
	Aluminum		500	700	900	1000	1300			
16	SS			2400	3000	3400	4200	4800		2-7/16
	Steel			1800	2300	2600	3200	3600		
	Copper			700	900	1000	1300	1400		
	Aluminum			700	900	1000	1300	1400		
20	SS			2800	3400	4000	4800	5300		2-1/2
	Steel			2100	2600	3000	3600	4000		
	Copper			800	1000	1200	1400	1600		
	Aluminum			800	1000	1200	1400	1600		
24	SS				4000	4500	5300	5800		2-7/8
	Steel				3000	3400	4000	4400		
	Copper				1200	1300	1600	1700		
	Aluminum				1200	1300	1600	1700		
32	SS					3300	4000	5000	6300	3
	Steel					2500	3000	3800	4700	
	Copper					1000	1200	1500	1900	
	Aluminum					1000	1200	1500	1900	

Table R25 — Recommended Flaring Pressures, Inch Tube

**Note:** If tube size and wall thickness are not shown on this chart, see page S25, Table S14 for recommended tube size for use with 37° flare fittings.

## Triple-Lok Troubleshooting Guide

### 37° Flare

CONDITION	PROBABLE CAUSE(S)	RECOMMENDATION
<p>Tube nut binds to tube flare</p> <p>Tube nut cannot engage the fitting body</p>	<ul style="list-style-type: none"> <li>• Flare too large or tube wall too heavy</li> </ul>	<ul style="list-style-type: none"> <li>• Flare new tube end using proper flare diameters</li> </ul>
<p>Flare is out-of-round (lopsided)</p>	<ul style="list-style-type: none"> <li>• Tube cut at an angle</li> </ul>	<ul style="list-style-type: none"> <li>• Re-cut tube, reasonably square, to <math>90^\circ \pm 1^\circ</math> and flare new tube end</li> </ul>
<p>Nicks, scratches, pock marks on tube flare of fitting</p>	<ul style="list-style-type: none"> <li>• Contaminants on tube ID or flaring cone/pin prior to flaring</li> <li>• Worn/damaged flaring cone/pin</li> <li>• Poor-quality tube</li> </ul>	<ul style="list-style-type: none"> <li>• Flare new tube end using proper tube preparation techniques</li> <li>• Assure that flare cone is clean</li> <li>• Replace poor-quality tube</li> </ul>
<p>Tube crack on flare</p>	<ul style="list-style-type: none"> <li>• Poor-quality welded tube; work-hardened tube; tube not annealed (too hard)</li> </ul>	<ul style="list-style-type: none"> <li>• Flare new tube end using appropriate tube (e.g., fully annealed) and tube cutting methods</li> </ul>
<p>Tube nut bottoms out before seats are mated properly</p>	<ul style="list-style-type: none"> <li>• Unintentional use of 45° flare tube nut, or tube sleeve was omitted</li> </ul>	<ul style="list-style-type: none"> <li>• Use appropriate 37° flare components (body, nut and sleeve)</li> </ul>
<p>Immediate leakage from tube nut</p>	<ul style="list-style-type: none"> <li>• Connection may not be tightened properly (if at all)</li> </ul>	<ul style="list-style-type: none"> <li>• Check joint for appropriate FFWR or torque; retighten as appropriate</li> </ul>
<p>Tube nut continues to back off or loosen</p>	<ul style="list-style-type: none"> <li>• Damaged Fitting</li> <li>• Excessive vibration</li> <li>• Improper assembly torque</li> </ul>	<ul style="list-style-type: none"> <li>• Replace damaged fitting</li> <li>• Re-route or clamp properly</li> <li>• Assemble to appropriate torque</li> </ul>
<p>Damaged fitting and/or nose collapse, flow reduction</p>	<ul style="list-style-type: none"> <li>• Frequent assembly and disassembly or over-tightening</li> </ul>	<ul style="list-style-type: none"> <li>• Fitting should be replaced and tightened properly; avoid frequent assembly/disassembly</li> </ul>

Table R26 — Triple-Lok Troubleshooting guide

TABLE OF CONTENTS

SECTION TABLE OF CONTENTS

FAQs

R

## Ferulok Flareless Bite Type Fittings

Ferulok fitting assembly consists of the following steps:

1. Cutting, deburring and cleaning of the tube
2. Ferrule pre-set
3. Pre-set inspection
4. Final installation

For proper tube end preparation see pages R12-R13, or refer to the detailed blog post and video on [www.TFDtechconnect.com](http://www.TFDtechconnect.com).

For the recommended minimum and maximum tube wall thickness for Ferulok fittings, please refer to Table S16 on page S27.

Prior to pre-setting, determine the tube length allowance “A” using Table R27.

Nominal Tube O.D.	A
1/8	0.19
3/16	0.23
1/4	0.23
5/16	0.25
3/8	0.25
1/2	0.31
5/8	0.35
3/4	0.35
7/8	0.35
1	0.42
1 1/4	0.42
1 1/2	0.49
2	0.49

Table R27 — Tube length allowance

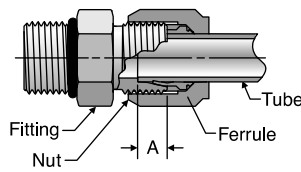

Fig. R35 — Tube length allowance

### Ferrule Pre-set

Prior to final installation, the Ferulok fitting requires a pre-setting operation that creates a bite by the ferrule into the outer surface of the tubing. Pre-setting can be accomplished by two different methods: manually using a hardened Ferulset tool or the fitting body, or hydraulically using a Hyferset Tool or a Hydra-Tool.

When using the Hyferset or Hydra-Tool method, the pressure build-up “bites” the ferrule into the tubing. When using the Ferulset or fitting body, thread the connection to finger tight and wrench an additional 1-3/4 turns. This will “bite” the ferrule into the tube.

#### Pre-setting using Ferulset Tool or Fitting Body

Ferulset pre-setting tools made from hardened steel are available for sizes 2 through 32. (See page Q43.) They are recommended over the fitting body because they can be used repeatedly to perform the pre-set operation. The fitting body can be used only once for pre-setting and should be used during final installation with the pre-set tube line. The following steps are required for proper pre-set of the ferrule using the Ferulset tool or fitting body.



**Step 1** – Lubricate thread and cone of Ferulset Tool (or fitting body).

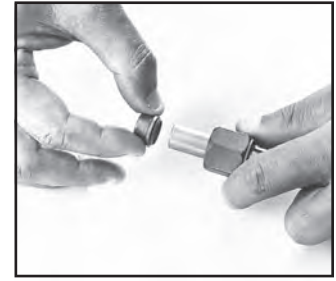

**Step 2** – Slip nut and ferrule over deburred tube end. Be sure the long, straight end of the ferrule points toward tube end.



**Step 3** – Lubricate ferrule with system fluid or a compatible lubricant. This ensures that the tooling won't stick to the ferrule.

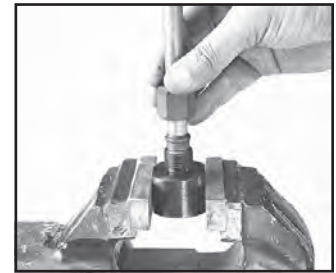

**Step 4** – Bottom tube end firmly on internal shoulder of Ferulset Tool (or fitting body).



**Step 5** – Manually screw nut onto Ferulset Tool or fitting body until finger tight.



**Step 6** – Make reference mark on nut and tube.



**Step 7** – Hold tube steady against internal shoulder of Ferulset Tool or fitting body and tighten nut an additional 1-3/4 turns.

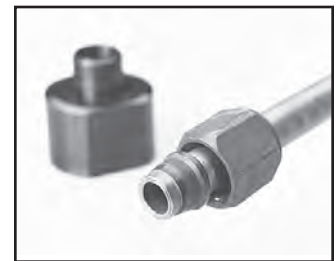

**Step 8** – Loosen nut and check for proper pre-set. Use the following inspection criteria.

TABLE OF CONTENTS

SECTION TABLE OF CONTENTS

FAQs

### Pre-setting with Hyferset Tool or Hydra-Tool

Pre-setting with hydraulic equipment (Hyferset or Hydra-Tool) is preferred for fittings larger than size 8 or large production quantities in any sizes.

For full instruction on the use of the Hyferset Tool (see Fig. R36), please refer to Bulletin 4393-B1, which is included with each shipment of the Hyferset Kit #611049C. For full instructions on the use of the Hydra-Tool, please refer to Bulletin 4392-B10. A22toolspec Bulletins and videos can be found at [www.parker.com/TFD](http://www.parker.com/TFD) or [www.TFDToolSpec.com](http://www.TFDToolSpec.com).

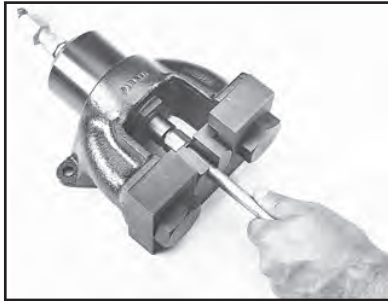

Fig. R36 – Hyferset tool

### Pre-Set Inspection

All Ferulok fitting presets must be disassembled and inspected for proper ferrule pre-set before final installation. The following detailed inspection procedures must be followed regardless of the method used to pre-set the ferrule to the tube. (Refer to Fig. R37 for the five inspection points discussed below).

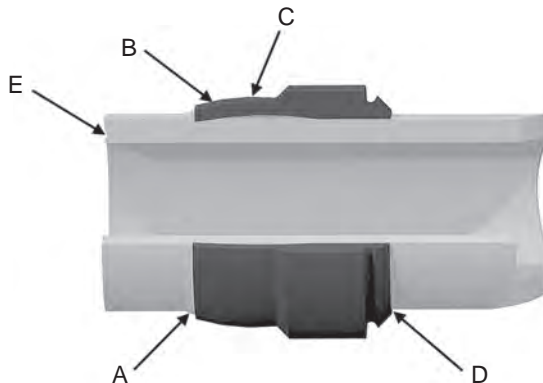

Fig. R37 – Ferulok preset inspection points

1. A ridge of metal (A) has been raised above the tube surface to a height of at least 50% of the thickness of the ferrule's leading edge, completely around the tube.
2. While the leading edge of the ferrule may be coined flat (B) there is a slight bow to the balance of the pilot section (C).
3. The tail or back end of the ferrule is snug against the tube (D).

4. There is a slight indentation around the end of the tube (E) that indicates the tube was bottomed in the tool or fitting during pre-setting.
5. Avoid rotating the ferrule. Steel ferrules should not be capable of moving back and forth along the tube beyond the bite area (a stainless steel ferrule will move more than steel because of its spring back characteristics).

**Caution:** Wrench torque should never be used as the gauge for reliable Ferulok pre-set and/or assembly. The reliability of the pre-set and assembly of bite type fittings is dependent on the ferrule traveling a prescribed distance into the tapered fitting throat in order to bite into the tube and effect a strong grip and seal.

### Installation

Use one of the following installation procedures, depending on the tooling used earlier to pre-set the ferrule to the tubing.

1. **Fitting body, Hyferset, Hydra-Tool, or Ferulset used to pre-set ferrule** – If the fitting body was used for pre-setting the ferrule, complete the final installation with the **same** fitting body. If one of the tools was used, select the compatible fitting body and lubricate\* the threads. Tighten the nut until a sudden and noticeable wrench resistance is achieved. Then wrench an additional **1/6 to 1/4 turn** to complete the final assembly.
2. **Swivel nut assembly procedure (R6BU, C6BU and S6BU)** – For final assembly of swivel nut, a **3/4 turn** from finger tight is required for all sizes.

\*No additional lubrication is required with stainless steel fittings as the nuts are pre-lubricated.

TABLE  
OF  
CONTENTS

SECTION  
TABLE OF  
CONTENTS

FAQs

R

## Hydra-Tool Pre-Setting Pressures for Ferulok Fittings<sup>1) 2) 3)</sup>

Tube Size	Wall Thickness — Steel							Wall Thickness — Stainless Steel						
	0.035	0.049	0.065	0.083	0.095	0.109	0.120	0.035	0.049	0.065	0.083	0.095	0.109	0.120
4	300	300	500	600	600	600	600	300	300	500	700	700	700	700
6	300	500	600	700	700	700	700	300	500	700	700	700	700	800
8		500	700	800	900	1,000	1,000		600	700	1,000	1,000	1,100	1,100
10			700	900	1,000	1,100	1,100			800	1,000	1,100	1,300	1,300
12			900	1,000	1,100	1,100	1,300			1,000	1,100	1,300	1,300	1,500
14			1,000	1,100	1,100	1,300	1,500			1,000	1,300	1,300	1,500	1,600
16				1,100	1,300	1,500	1,600				1,500	1,500	1,600	1,600
20					1,500	1,600	1,800					1,600	2,000	2,000
24					1,800	2,000	2,300					2,100	2,300	2,300
32					2,800	2,900	3,300					3,100	3,300	3,300

Table R28 — Hydra-Tool Recommended Pre-Setting Pressures for Inch Tube

- 1) These values are provided as a guide only and normally will produce a satisfactory bite.
- 2) Ferulok pre-setting dies are positive stop dies. Use of above pressures is optional.
- 3) For wall thicknesses greater than those listed, contact the Tube Fittings Division.

## Hyferset Pre-Setting Pressures for Ferulok Fittings<sup>1)</sup>

Tube Size	Wall Thickness — Steel							Wall Thickness — Stainless Steel						
	0.035	0.049	0.065	0.083	0.095	0.109	0.120	0.035	0.049	0.065	0.083	0.095	0.109	0.120
4	800	900	1,400	1,800	1,800	1,800	1,800	900	1,000	1,500	2,000	2,000	2,000	2,000
6	900	1,400	800	2,000	2,000	2,000	2,200	1,000	1,500	2,000	2,000	2,000	2,000	2,500
8		1,600	2,000	2,500	2,700	3,000	3,200		1,800	2,200	3,000	3,000	3,500	3,500
10			2,200	2,700	3,000	3,500	3,500			2,500	3,000	3,500	4,000	4,000
12			2,700	3,000	3,500	3,500	4,000			3,000	3,500	4,000	4,000	4,500
14			3,000	3,500	3,500	4,000	4,500			3,000	4,000	4,000	4,500	5,000
16				3,500	4,000	4,500	5,000				4,500	4,500	5,000	5,000
18				4,000	4,500	4,500	5,000				4,500	5,000	5,000	5,500
20					4,500	5,000	5,500					5,000	6,000	6,000
24					5,500	6,000	7,000					6,500	7,000	7,000
28					7,000	7,500	8,000					7,500	8,000	8,500
32					8,500	9,000	10,000					9,500	10,000	10,000

Table R29 — Pre-Setting Pressures for Ferulok Fittings

- 1) Ferulok pre-setting dies are positive stop dies. Use of above pressures is optional.

TABLE OF CONTENTS

SECTION TABLE OF CONTENTS

FAQs



## Ferulok Troubleshooting Guide

Problems with bite type hydraulic fittings are most often traced to faulty Pre-Set/Assembly procedure.

Problem / Probable Cause	Remedy
Tube not bottomed	Check for the indentation on the tube end or compare the length from the end of the tube to the front end of the ferrule of a known good assembly to that of the assembly in question. This assembly should be scrapped. (Fig. R38)
Shallow bite	Inspect for turned up ridge of material. A failure to achieve this ridge can be traced either to the nut not being tightened enough or the tube not being bottomed against the stop which allowed the tube to travel forward with the ferrule. In some instances this assembly may be re-worked. (Fig. R39)
Over-set ferrule	Too much pressure or more than 1 3/4 turns from finger tight were used to pre-set ferrule, or the nut was severely over-tightened in final assembly. This assembly should be scrapped. (Fig. R40)
Ferrule cocked on tube	The ferrule may become cocked on the tube when the tube end is not properly lined up with the body. Generally, this condition is caused by faulty tube bending. All bent tube assemblies should drop into the fitting body prior to make up. This assembly should be scrapped. (Fig. R41)
No bite	If all of the prior checks have been made and the ferrule still shows no sign of biting the tube, it may be that the tube is too hard. This assembly should be scrapped. (Fig. R42)

Table R30 – Ferulok fitting troubleshooting guide

**Caution: Pre-set tools such as the Ferulset and Hyferset are preferred for pre-setting ferrules prior to final assembly. However, when an actual fitting body is used to pre-set the ferrule, that body should be connected only to the specific ferrule it was used to pre-set.**

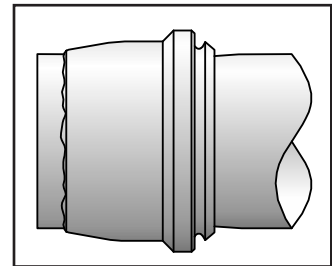

Fig. R38 – Tube not bottomed

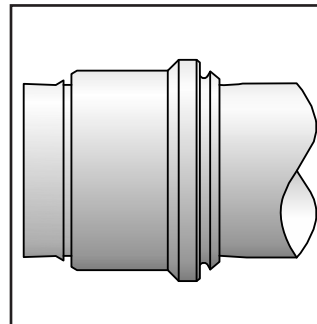

Fig. R39 – Shallow bite

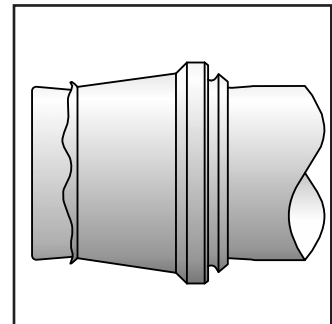

Fig. R40 – Over-set ferrule

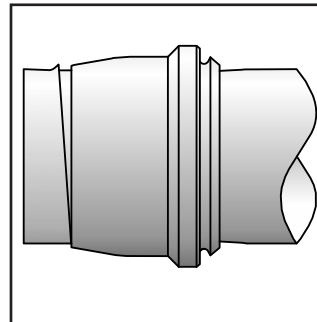

Fig. R41 – Ferrule cocked on tube

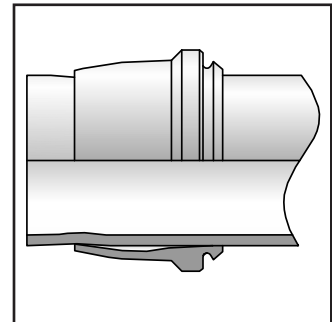

Fig. R42 – No bite

TABLE OF CONTENTS

SECTION TABLE OF CONTENTS

FAQs

R

## 24° Flareless Bite

CONDITION	PROBABLE CAUSE(S)	RECOMMENDATION
Immediate leakage when system is pressurized	<ul style="list-style-type: none"> <li>• Improper ferrule/bite ring orientation</li> </ul>	<ul style="list-style-type: none"> <li>• Reset ferrule to ensure that the leading edge of ferrule/bite ring is pointing towards end of tube and seat of the mating fitting</li> </ul>
Additional/excessive stress apparent on bite	<ul style="list-style-type: none"> <li>• Non-square tube cut; tube not being properly supported in seat of adapter</li> </ul>	<ul style="list-style-type: none"> <li>• Re-cut tube to <math>90^\circ \pm 1^\circ</math></li> </ul>
Flexural stresses allow tube to “rock” back and forth	<ul style="list-style-type: none"> <li>• Tube not fully supported in fitting’s body seat</li> </ul>	<ul style="list-style-type: none"> <li>• Reset tube end. This time ensure that the tube is bottomed in the presetting tool or fitting body</li> </ul>
Poor ferrule/bite ring pre-set and/or tube collapse	<ul style="list-style-type: none"> <li>• Tube may be too hard; or preset pressure or torque might be too high</li> <li>• Tube is too thin</li> </ul>	<ul style="list-style-type: none"> <li>• Use fully annealed tube max hardness <math>R_B 72</math> for steel, <math>R_B 90</math> for stainless steel</li> <li>• Consult manufacturer's minimum tube wall thickness requirements; tube supports must be used with certain thin-walled steel or stainless-steel tube. Review preset requirements</li> </ul>
Tube not bottoming out in fitting body	<ul style="list-style-type: none"> <li>• Improper preset or wrong tool used for presetting</li> </ul>	<ul style="list-style-type: none"> <li>• In the presetting process, it is important to exert axial force on the tube to keep it fully bottomed in the tool. Check for indentation on end of the tube</li> </ul>
Shallow bite of ferrule or cut ring into tube	<ul style="list-style-type: none"> <li>• Worn preset tool</li> <li>• Too low preset pressure or torque</li> <li>• Tube too hard</li> <li>• Tube not bottomed against stop initially in preset</li> </ul>	<ul style="list-style-type: none"> <li>• Replace preset tool</li> <li>• Observe manufacturer's recommendation for proper preset</li> <li>• Ensure that tube is of correct hardness or material</li> <li>• Hold tube against stop in preset</li> </ul>
Tube pulls out of fitting in application and ferrule skives end of tube	<ul style="list-style-type: none"> <li>• Improper preset</li> <li>• Tube too hard</li> <li>• Excessive internal pressure</li> <li>• Excessive axial load on tube</li> <li>• Inadequate make up</li> </ul>	<ul style="list-style-type: none"> <li>• Preset must be inspected for evidence of proper preset, such as raised ridge of metal in front of leading edge</li> <li>• Ensure that tube is of proper hardness and material</li> <li>• Ensure that internal pressure is within rating of fitting (tube might be of a higher rating)</li> <li>• Avoid additional axial load than that caused by internal pressure</li> <li>• Follow proper presetting and assembly procedures</li> </ul>
Fitting nut is tight but leakage still occurs	<ul style="list-style-type: none"> <li>• Overset ferrule</li> <li>• Cracked tube</li> <li>• Damaged components</li> </ul>	<ul style="list-style-type: none"> <li>• Excessive force used in presetting of ferrule can cause it not to spring back and effect a seal. Follow manufacturer's recommendation for preset</li> <li>• Check tube for circumferential crack due to fatigue</li> <li>• Check components for damage such as nicks, scratches and cracks</li> </ul>

TABLE OF CONTENTS

SECTION TABLE OF CONTENTS

FAQs

## EO Metric Bite Type Fittings

The proper make-up and assembly of EO bite type fittings, as with other fittings, is critical to their proper functioning. Proper assembly consists of the following steps:

1. Cutting, deburring and cleaning of the tube
2. Pre-set of progressive ring
3. Pre-set inspection
4. Installation

For proper tube end preparation see pages R12-R13, or refer to the detailed blog post and video on [www.TFDtechconnect.com](http://www.TFDtechconnect.com).

### Pre-set of Progressive Ring

The EO fitting requires a pre-set operation that creates a bite by the progressive ring into the outer surface of the tube. There are two methods of achieving the pre-set:

- Manually with the fitting body or hardened pre-assembly tool (not recommended for stainless steel tube).
- Hydraulically with the EO-Karrymat, Hydra Tool or Hyferset

### Pre-set Using the Fitting Body or Hardened Pre-assembly Tool

Pre-setting with the fitting body is only recommended for small diameter steel and copper tubes. For frequent pre-setting, stainless steel tube and hose standpipe fittings, a hardened pre-assembly tool (VOMO) is strongly recommended (see Fig. R43).

**Steps for pre-set using the fitting body or the hardened pre-assembly tool.**

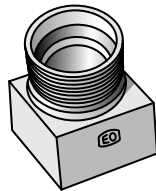
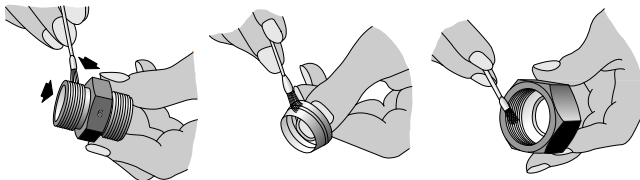
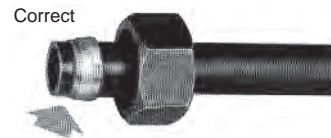

Fig. R43 – VOMO pre-assembly tool

1. Lubricate thread and cone of fitting body or hardened pre-assembly tool, as well as the progressive ring and nut threads.



2. Slip nut and progressive ring over tube, assuring that they are in the proper orientation.



3. Screw nut onto fitting body or hardened pre-assembly tool until finger-tight or light wrench resistance. Hold tube against the shoulder in the cone of the fitting body or hardened pre-assembly tool.

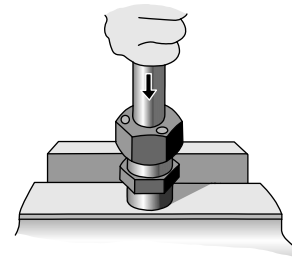

4. Mark nut and tube in the finger-tight or light wrench-resistant position.

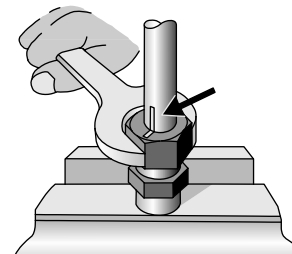

TABLE  
OF  
CONTENTS

SECTION  
TABLE OF  
CONTENTS

FAQs

R

5. Tighten nut 1½ turns if using the fitting body or hardened pre-assembly tool. The tube must not turn with the nut. The stop edge in the progressive ring limits over tightening by sharply increasing the tightening torque.

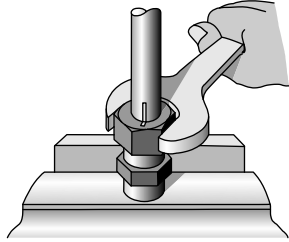

### Pre-set Using EO-Karrymat, Hydra-Tool or Hyferset

When pre-setting EO fittings larger than sizes 18 mm, it is recommended that a hydraulic tool be used. The EO-Karrymat, Hydra-Tool or the Hyferset (shown in Fig. R44) are recommended for low to medium volume production.



Fig. R44 – Hyferset tool



Fig. R45 – EO Karrymat

For full instruction on the use of these hydraulic tools, please refer to [www.TFDToolSpec.com](http://www.TFDToolSpec.com) for the bulletins indicated below:

- EO-Karrymat – Bulletin 4044-T1/UK/DE/FR/T
- Hyferset - Bulletin 4393-B1
- Hydra-Tool – Bulletin 4392-B10

### Pre-set Inspection

To inspect the pre-set, remove the nut and tube from the fitting and check if a visible collar fills the space completely in front of first cutting edge. If not, tighten slightly more. It does not matter if ring can be rotated on tube end.

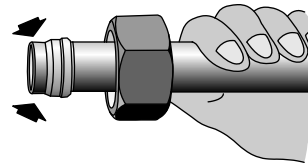

### Installation

To install the pre-set tube assembly to the fitting body, wrench-tighten nut to wrench resistance (light wrenching). From this position, tighten nut another 1/12 turn or 1/2 flat (30°) of the nut. Another wrench must be used to prevent movement of the fitting body.

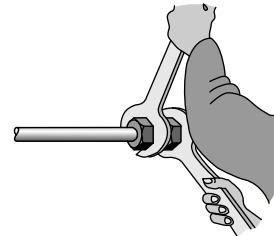

### Assembly with Support Sleeve (VH)

If the tube wall thickness is small relative to the tube O.D., this may lead to tube collapse. As a rule, the tube collapse (reduction in diameter) should not exceed 0.3 mm for tubes up to 16 mm O.D. and 0.4 mm for tubes from 18 mm O.D. and above.

When assembling thin walled tube, there is insufficient cross sectional rigidity where the progressive ring cuts. This will have a detrimental effect on the sealing efficiency. For this, internal support sleeves (VH) are available which are inserted in the tube to prevent tube collapse and also increase the cross-sectional rigidity.

TABLE OF CONTENTS

SECTION TABLE OF CONTENTS

FAQs

The shape of the tube supports allows them to be inserted easily in the tube. One end of the EO support sleeve is enlarged on its external diameter by a knurl. On insertion, this knurl forces itself into the interior wall of the tube and secures the sleeve against shifting or falling out during assembly and without widening the tube end.

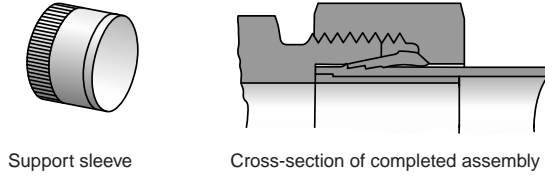
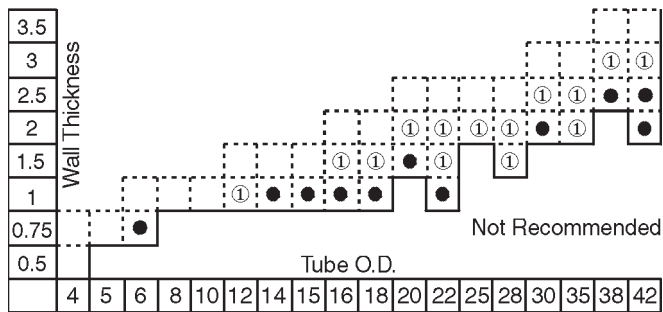

**Fig. R46 — EO fitting completely assembled with support sleeve**

Steel tubes made of 37.4 or soft metal tubes can be checked in accordance with Figs. R47 and R48, respectively, to see if they require support sleeves; for plastic tubes, (support) sleeves are always necessary (see Page D21 for E type sleeves).

For stainless steel tubes of material 1.4571/1.4541, refer to Fig. R44 to determine the need for a support tube.

For thin-walled steel tube of material St.37.4 and stainless steel tubes of material 1.4571/1.4541.



**Fig. R47 — Recommended Tube Wall Thicknesses, Steel, SS**

- Use of VH necessary
- ① Use of VH is recommended especially in case of frequent loosening and with heavy-duty tubes (vibrations)

For soft metal tubes

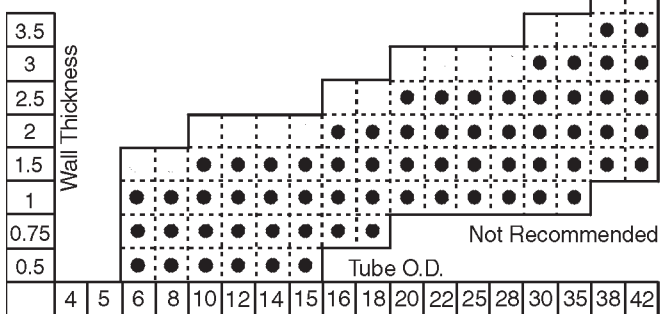
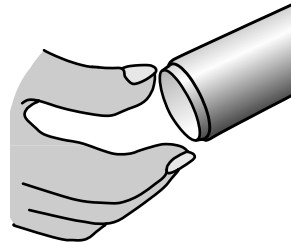

**Fig. R48 — Recommended Tube Wall Thicknesses, Soft Metal Tubing**

- Use of VH necessary
- ① Use of VH is recommended especially in case of frequent loosening and with heavy-duty tubes (vibrations)

## Steps for Proper Assembly of Support Sleeve (VH)

**Step 1** – Insert support sleeve up to knurl.



**Step 2** – Drive knurled end of support into tube.

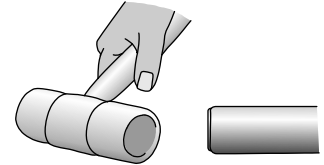

**Step 3** – Ensure that support sleeve is flush with tube end.

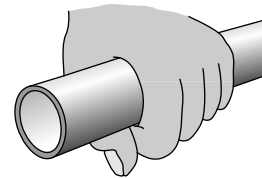

**Step 4** – Pre-set progressive ring following one of the pre-setting methods covered earlier (page R33). The support sleeve prevents collapse of tube.

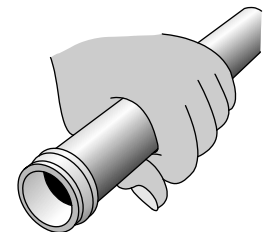

**TABLE OF CONTENTS**

**SECTION TABLE OF CONTENTS**

**FAQs**

**R**



## EO Troubleshooting Guide

Problems with bite type hydraulic fittings are most often traced to faulty pre-set/assembly procedure.

Problem	Solution
Tube not bottomed	Check for a visible mark on the tube end with EO fitting. (Fig. R49)
Shallow bite	Inspect for turned up ridge of material (collar). A failure to achieve this ridge can be traced either to the nut not being tightened enough or the tube not being bottomed against the stop which allowed the tube to travel forward with the ferrule. In some instances this assembly may be re-worked. (Fig. R50)
Over-set ferrule	Too much pressure or more than recommended turns from finger tight were used to pre-set ferrule, or the nut was severely over-tightened in final assembly. This assembly should be scrapped. (Fig. R51)
Ferrule cocked on tube	The ferrule may become cocked on the tube when the tube end is not properly lined up with the body. Generally, this condition is caused by faulty tube bending. All bent tube assemblies should drop into the fitting body prior to make up. This assembly should be scrapped. (Fig. R52)
No bite	If all of the prior checks have been made and the ferrule still shows no sign of biting the tube, it may be that the tube is too hard. This assembly should be scrapped. (Fig. R53)

Table R31 — EO Fitting troubleshooting guide

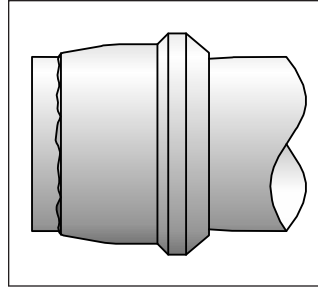

Fig. R49 — Tube not bottomed

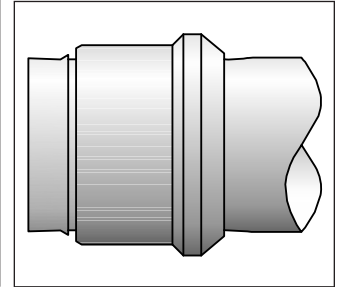

Fig. R50 — Shallow bite

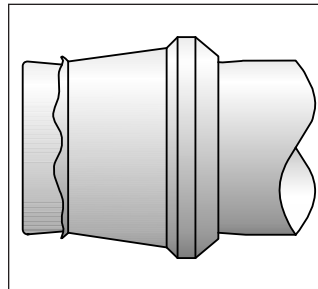

Fig. R51 — Over-set ferrule

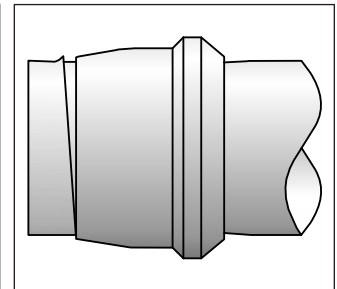

Fig. R52 — Ferrule cocked on tube

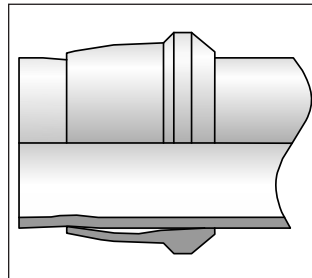

Fig. R53 — No bite

TABLE OF CONTENTS

SECTION TABLE OF CONTENTS

FAQs

## EO-2 Metric Bite Type Fittings

The steps for the proper assembly of the EO-2 fittings are similar to those of the EO fitting:

1. Cutting, deburring and cleaning of the tube
2. Pre-set of the retaining ring
3. Inspection of the pre-set
4. Installation

For proper tube and preparation see pages R12-R13, or refer to the detailed blog post and video on [www.TFDtechconnect.com](http://www.TFDtechconnect.com).

### Pre-set of the Retaining Ring

The EO-2 functional nut consists of the nut, the sealing ring and the retaining ring. Unlike the EO fitting, the sealing and holding functions are performed by two separate components: the sealing ring and the retaining ring. The retaining ring must be pre-set to create the necessary bite on the tube O.D. The two methods to pre-set the retaining ring are:

- Manually with the fitting body or hardened pre-assembly tool (VOMO)
- Hydraulically with the EO-Karrymat, Hydra Tool or Hyferset

### Pre-set Using the Fitting Body or Hardened Pre-Assembly Tool

1. Prepare the fitting or hardened pre-assembly tool by lubricating the threads of the following sizes:

#### Steel Fittings:

20, 22, 25, 28 Lubrication is recommended for ease in assembly

#### Stainless Steel Fitting:

For all sizes, lubrication is recommended for ease in assembly

High quality Niromont (liquid or paste) is recommended for lubrication of the fitting body threads.

**It is strongly recommended that a hydraulic tool be used to preset EO-2 fittings in sizes 30S, 35L, 38S and 42L.**

2. Insert tube into the EO-2 fitting body or hardened pre-assembled tool and press hard against the stop in the inner cone.

**Note:** A faulty assembly will result if the tube is not against the tube stop in the fitting body or hardened pre-assembly tool. To achieve the necessary assembling force, an additional wrench leverage may be necessary for tube O.D.'s 20mm and larger.

3. Turn nut until wrench resistance is felt. Tighten nut further 1 to 1-1/2 turns. As a recommended process control, mark the position of the nut relative to the fitting body.



### Pre-set Inspection

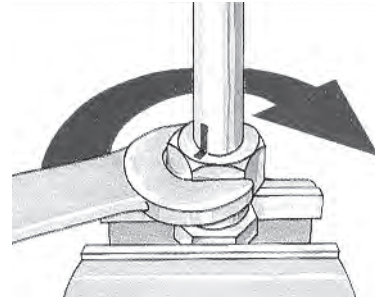

Loosen the nut and check that the gap between the sealing ring and retaining ring is fully closed. A slight gap (up to 0.2mm) due to spring back is acceptable.

\*Refer to Fig. R47 and R48 for required support sleeves.

### Pre-set Using EO-Karrymat, Hyferset, Hydra-Tool and EOMAT III

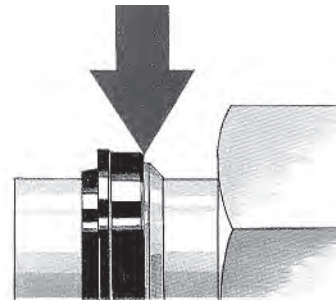

**EO-Karrymat:** Recommended for use with EO-2 fittings from 6mm through to 42mm.

**Hyferset:** Recommended for use with EO-2 fittings from 6mm through to 28mm.

**Hydra-Tool:** Recommended for use with EO-2 fittings from 6mm through to 42mm.

For instructions on operating one of these machines, refer to [www.TFDToolSpec.com](http://www.TFDToolSpec.com) for the following bulletins:

- EO-Karrymat – Bulletin 4044-T1/UK/DE/FR/IT
- Hyferset – Bulletin 4393-B1
- Hydra-Tool – Bulletin 4392-B10

TABLE  
OF  
CONTENTS

SECTION  
TABLE OF  
CONTENTS

FAQs

R

# Hydra-Tool Pre-Setting Pressures for EO and EO-2 Steel Fittings

## Pressures for Steel EO Fittings Using Stop Adapter (971107 & 971108)

Pre-Setting Pressures (psi) for EO Fittings							
Wall Thickness (mm)							
Size	Series	1.0	1.5	2.0	2.5	3.0	4.0
6	L	500	500	500			
6	S	500					
8	L	500		500			
8	S	500	500				
10	L		500				
10	S		500				
12	L	300	300	500			
12	S		300				
14	S			1,500			
15	L		500	800			
16	S			1,200		1,300	
18	L		1,000			1,300	
20	S				2,000		
22	L		1,500	1,500			
25	S					2,000	2,000
28	L				2,000		
30	S					3,000	
35	L				3,000	3,300	
38	S						3,500
42	L					4,000	

**Table R32 — Pre-Setting Pressures for Steel EO Fittings**

**NOTE:** The values provided in this chart are provided as a guide only and normally will produce a satisfactory bite when using the Parker Hydra-Tool.

## Pressures for Steel EO-2 Fittings Using Stop Adapter (971107 & 971108)

Hydra-Tool Pre-Setting Pressures (psi) for EO-2 Fittings in Steel and Stainless Steel Using the Stop Adapter		
Size	Series	psi
6	L	1,100
6	S	1,100
8	L	1,300
8	S	1,300
10	L	1,800
10	S	1,800
12	L	2,000
12	S	2,000
14	S	2,300
15	L	2,300
16	S	3,000
18	L	3,000
20	S	4,100
22	L	3,100
25	S	5,500
28	L	3,700
30	S	6,600
35	L	5,300
38	S	8,400
42	L	7,600

**Table R33 — Pre-Setting Pressures for Steel and Stainless Steel EO-2 Fittings**

**NOTE:** The values provided in this chart are provided as a guide only and normally will produce a satisfactory bite when using the Parker Hydra-Tool.

TABLE  
OF  
CONTENTS

SECTION  
TABLE OF  
CONTENTS

FAQs

## Hyferset Pre-Setting Pressures for EO Steel Fittings<sup>2)</sup>

Pre-Setting Pressures (psi) for EO2 Fittings					
Tube Size (mm)	Wall Thickness (mm)				
	1.0	1.5	2.0	2.5	3.0
6-L	650	650			
6-S	650	650			
8-L	900	900			
8-S	900	900			
10-L	1,350	1,350	1,550		
10-S	1,350	1,350	1,550		
12-L	1,750	1,750	1,750	1,750	
12-S	1,750	1,750	1,750	1,750	
14-S		2,000	2,000	2,200	2,200
15-L	1,800	1,800			
16-S		2,200	1,450	1,450	
18-L	2,000	2,000	2,000		
20-S			3,300	3,500	
22-L		3,100	3,100		
25-S				4,000	4,000
28-L		3,500	3,500		

**Table R34 — Pre-Setting Pressures for EO Fittings**

2) EO and EO-2 pre-setting dies are not positive stop style. Pre-setting must be done using pressures given in these charts.

## Hyferset Pre-Setting Pressures for EO-2 Steel Fittings<sup>2)</sup>

Hyferset Pre-Setting Pressures (psi) for EO-2 Fittings		
Size	Series	Any wall
6	L	1,150
6	S	1,150
8	L	1,450
8	S	1,450
10	L	2,450
10	S	2,450
12	L	2,800
12	S	2,800
14	S	3,500
15	L	2,800
16	S	3,900
18	L	3,200
20	S	5,600
22	L	4,950
25	S	6,400
28	L	5,600

**Table R35— Pre-Setting Pressures for EO-2 Fittings**

2) EO and EO-2 pre-setting dies are not positive stop style. Pre-setting must be done using pressures given in these charts.

TABLE OF CONTENTS

SECTION TABLE OF CONTENTS

FAQs

R

## Installation

Connect tube and nut to fitting body. Holding the body rigid, tighten nut with a wrench until resistance is felt. Continue turning the nut approximately 1/6 to 1/4 turns (= 1 to 1-1/2 flats) to the same position as it was prior to disassembly.

If the assembled position was marked, reassemble until the marks match. To achieve the necessary assembling force, use an additional wrench leverage for tube O.D.'s 20 mm and larger.

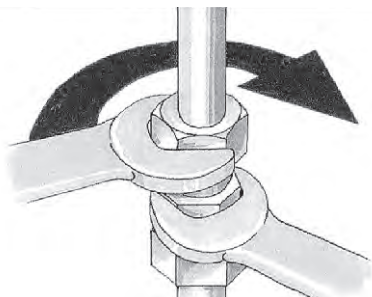

**Caution:** Improper tightening may reduce the seal reliability, pressure capability and the vibration resistance of the connection.

## Re-Assembly with Replacement of Sealing Ring (DOZ)

1. After the nut has been loosened, the sealing ring can be pulled off the tube end. It must be checked for damage and replaced if necessary.
2. Push new sealing ring onto the tube, with metal inner cone facing the retaining ring.
3. Re-install using the installation procedures previously covered in this section.

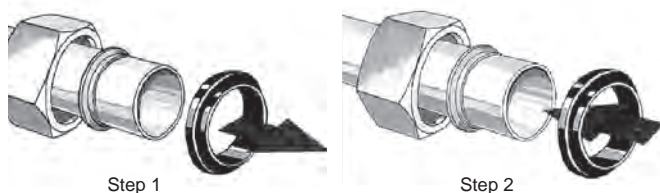

## EO-2 Troubleshooting Guide

Problems with bite type hydraulic fittings are most often traced to faulty pre-set/assembly procedure.

Problem/ Probable Cause	Remedy
Tube not bottomed	The tube end is not in firm contact with the fitting body at assembly. The tubing was not completely inserted into the throat of the fitting body until it bottomed out. Failure to bottom out the tubing against the tube stop of the fitting body during the presetting procedure will allow the tube to travel forward with the ferrule resulting in a shallow bite. This assembly should be scrapped.
Shallow bite	After presetting, inspect to see that the gap between the bite ring and the sealing ring is closed. A failure to achieve a closed gap can be traced to the nut not being tightened enough. This assembly can be reworked by completing the assembly instructions as indicated in the catalog. Utilization of lubrication and wrench elongation may be necessary for larger sizes.
Damaged Seals	Check sealing area for contamination such as chips, zinc particles or other dirt. Also check the inner cone of the fitting body and tubing for damage. Replace DOZ sealing ring if necessary.
Fatigue Crack at Bite	Ensure proper assembly techniques are utilized. Utilize lubrication and wrench elongation for larger sizes. Check that the gap between the sealing ring and bite ring are closed.
Fatigue Crack at Rear Shoulder of Bite Ring	Check that the application does not have excessive vibration. Utilize rigid clamping, tension piping or hose assemblies if relative movements are evident.
Distorted FM Functional Nut at Hydraulic Pre-Assembly	Utilize a split die nut back up plate for presetting of 35L and 42L functional nuts.

Table R36 — EO-2 troubleshooting guide

TABLE OF CONTENTS

SECTION TABLE OF CONTENTS

FAQs



## 24° Flareless Bite

CONDITION	PROBABLE CAUSE(S)	RECOMMENDATION
Immediate leakage when system is pressurized	<ul style="list-style-type: none"> <li>• Improper ferrule/bite ring orientation</li> </ul>	<ul style="list-style-type: none"> <li>• Reset ferrule to ensure that the leading edge of ferrule/bite ring is pointing towards end of tube and seat of the mating fitting</li> </ul>
Additional/excessive stress apparent on bite	<ul style="list-style-type: none"> <li>• Non-square tube cut; tube not being properly supported in seat of adapter</li> </ul>	<ul style="list-style-type: none"> <li>• Re-cut tube to <math>90^\circ \pm 1^\circ</math></li> </ul>
Flexural stresses allow tube to “rock” back and forth	<ul style="list-style-type: none"> <li>• Tube not fully supported in fitting’s body seat</li> </ul>	<ul style="list-style-type: none"> <li>• Reset tube end. This time ensure that the tube is bottomed in the presetting tool or fitting body</li> </ul>
Poor ferrule/bite ring pre-set and/or tube collapse	<ul style="list-style-type: none"> <li>• Tube may be too hard; or preset pressure or torque might be too high</li> <li>• Tube is too thin</li> </ul>	<ul style="list-style-type: none"> <li>• Use fully annealed tube max hardness <math>R_B 72</math> for steel, <math>R_B 90</math> for stainless steel</li> <li>• Consult manufacturer’s minimum tube wall thickness requirements; tube supports must be used with certain thin-walled steel or stainless-steel tube. Review preset requirements</li> </ul>
Tube not bottoming out in fitting body	<ul style="list-style-type: none"> <li>• Improper preset or wrong tool used for presetting</li> </ul>	<ul style="list-style-type: none"> <li>• In the presetting process, it is important to exert axial force on the tube to keep it fully bottomed in the tool. Check for indentation on end of the tube</li> </ul>
Shallow bite of ferrule or cut ring into tube	<ul style="list-style-type: none"> <li>• Worn preset tool</li> <li>• Too low preset pressure or torque</li> <li>• Tube too hard</li> <li>• Tube not bottomed against stop initially in preset</li> </ul>	<ul style="list-style-type: none"> <li>• Replace preset tool</li> <li>• Observe manufacturer’s recommendation for proper preset</li> <li>• Ensure that tube is of correct hardness or material</li> <li>• Hold tube against stop in preset</li> </ul>
Tube pulls out of fitting in application and ferrule skives end of tube	<ul style="list-style-type: none"> <li>• Improper preset</li> <li>• Tube too hard</li> <li>• Excessive internal pressure</li> <li>• Excessive axial load on tube</li> <li>• Inadequate make up</li> </ul>	<ul style="list-style-type: none"> <li>• Preset must be inspected for evidence of proper preset, such as raised ridge of metal in front of leading edge</li> <li>• Ensure that tube is of proper hardness and material</li> <li>• Ensure that internal pressure is within rating of fitting (tube might be of a higher rating)</li> <li>• Avoid additional axial load than that caused by internal pressure</li> <li>• Follow proper presetting and assembly procedures</li> </ul>
Fitting nut is tight but leakage still occurs	<ul style="list-style-type: none"> <li>• Overset ferrule</li> <li>• Cracked tube</li> <li>• Damaged components</li> </ul>	<ul style="list-style-type: none"> <li>• Excessive force used in presetting of ferrule can cause it not to spring back and effect a seal. Follow manufacturer’s recommendation for preset</li> <li>• Check tube for circumferential crack due to fatigue</li> <li>• Check components for damage such as nicks, scratches and cracks</li> </ul>

TABLE OF CONTENTS

SECTION TABLE OF CONTENTS

FAQs

R

## Bulkhead Locknut Assembly

A bulkhead fitting allows one to connect tube or hose through a panel. This panel, often referred to as bulkhead, may be a structural element of the equipment, or an additional plate which is joined to the equipment, to facilitate convenient routing of hose and tube. Bulkhead fittings are also used as a transition point in a hydraulic system, such as connection of tube lines to hose lines or to a quick disconnect coupling.

The following steps are recommended for the proper assembly of the locknut for Triple-Lok, Ferulok and Seal-Lok bulkhead fittings.

1. Drill a pilot hole to dimension  $W + 0.015''$  (where  $W$  is shown in Tables R37 and R38).
2. Insert the bulkhead end of the fitting (without the locknut assembled) through the bulkhead opening and attach the locknut to the bulkhead end.
3. Finger tighten the locknut and wrench tighten further to the recommended torque shown in Table R37 for Seal-Lok fittings or Table R38 for Triple-Lok and Ferulok fittings.

TUBE FITTING PART #	THREAD SIZE UN/UNF	W*	ASSEMBLY TORQUE +10% - 0		
			in.-lb.	ft.-lb.	N-m
4 WLNL	9/16-18	0.56	180	15	20
6 WLNL	11/16-16	0.69	300	25	34
8 WLNL	13/16-16	0.81	—	55	75
10 WLNL	1-14	1.00	—	85	115
12 WLNL	1 3/16-12	1.19	—	135	180
14 WLNL	1 5/16-12	1.31	—	170	230
16 WLNL	1 7/16-12	1.44	—	200	270
20 WLNL	1 11/16-12	1.69	—	245	330
24 WLNL	2-12	2.00	—	270	365

\* Recommended clearance hole is  $W + 0.015''$

Table R37 – Torque for Seal-Lok Bulkhead Fittings

TUBE FITTING PART #	THREAD SIZE UN/UNF	W*	ASSEMBLY TORQUE (+10 - 0)		
			in.-lb.	ft.-lb.	N-m
3 WLN	3/8-24	0.38	100	—	11
4 WLN	7/16-20	0.44	155	13	18
5 WLN	1/2-18	0.50	250	20	28
6 WLN	9/16-18	0.56	300	25	35
8 WLN	3/4-16	0.75	600	50	65
10 WLN	7/8-14	0.88	—	85	115
12 WLN	1 1/16-12	1.06	—	135	180
14 WLN	1 3/16-12	1.19	—	170	230
16 WLN	1 5/16-12	1.31	—	200	270
20 WLN	1 5/8-12	1.63	—	245	330
24 WLN	1 7/8-12	1.88	—	270	365
32 WLN	2 1/2-12	2.50	—	310	420

\* Recommended clearance hole is  $W + 0.015''$

Table R38 – Torque for Triple-Lok and Ferulok Bulkhead Fittings

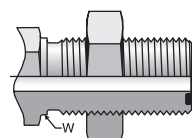

Seal-Lok Bulkhead Assembly

See page A8 for maximum bulkhead thickness.

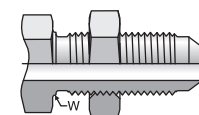

Triple-Lok Straight Bulkhead

See page B8 for maximum bulkhead thickness.

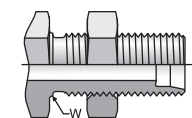

Ferulok Straight Bulkhead

See page C6 for maximum bulkhead thickness.

TABLE OF CONTENTS

SECTION TABLE OF CONTENTS

FAQs

## Pipe Swivel Assembly (NPSM)

Unlike traditional pipe thread, these connections seal on the nose of the swivel end. The nose has a 60° inclusive angle that mates against a chamfer of the same angle on the male pipe thread end (also known as a 30° chamfer).

Fig. R52 - Illustration showing how swivel adapters seal on mating chamfer in male pipe thread end.

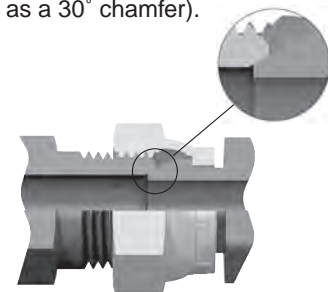

Fig. R54

### NPSM Pipe Swivels

NPSM Pipe swivels, also known as Parker 07 Adapters, must connect with a male NPT/NPTF pipe thread with a 30° machined seat per SAE J514.

NPSM Size in.	Steel Assembly TORQUE (+10% - 0%)		
	in.-lb.	ft.-lb.	F.F.F.T.
1/8	106	9	1.0 - 1.5
1/4	156	13	1.0 - 1.5
3/8	192	16	1.0 - 1.5
1/2	396	33	1.0 - 1.5
3/4	580	48	2.0 - 2.5
1	1140	95	2.0 - 2.5
1 1/4	1420	118	2.0 - 2.5
1 1/2	2840	237	2.0 - 2.5
2	3720	310	2.0 - 2.5

#### Steps:

1. Finger tight
2. Wrench tighten to torque specs in Table (R39)

Table R39– NPSM Pipe Swivel Torques

## Routing and Clamping

Most hydraulic, pneumatic and lubrication systems require some form of tube line fabrication and fitting installation for completion. Proper fabrication and installation are essential for the overall efficiency, leak free performance, and general appearance of any system.

The following factors should be considered early in the design process, after sizing the tube lines and selecting the appropriate style of fitting:

1. Proper routing of tube lines
2. Adequate tube line support (clamping)

### Routing of Lines

Routing of lines is one of the most difficult, yet most significant of these system design considerations. Proper routing involves getting a connecting line from one point to another through the most logical path, while considering other factors as discussed below.

The most logical path is not always the direct path and should have the following characteristics:

- **Avoid excessive strain on joint** — A strained joint will eventually leak. A straight line tube assembly (with no bends) or a joint that is forced into position are common examples of strain applied to tube assemblies.
- **Allow for expansion and contraction** — Use a “U” bend or a hose in long lines to allow for expansion and contraction due to pressure or temperature fluctuations.
- **Allow for motion under load** — Even some apparently rigid systems do move under load. Use an offset (“S”) bend.
- **Get around obstructions without using excessive amount of 90° bends** — Pressure drop due to one 90° bend is greater than that due to two 45° bends.
- **Keep tube lines away from components that require regular maintenance.**
- **Leave fitting joints as accessible as possible** — Inaccessible joints are more difficult to assemble and tighten properly, and more time consuming to service.
- **Have a neat appearance and allow for easy trouble-shooting, maintenance and repair.**

The following illustrations provide several examples of typical routing situations. The graphics show the preferred and non-preferred path along with an explanation.













Non-preferred Routing	Preferred Routing	Explanation
		Avoid straight tube lines. There is no margin for error on a straight line, resulting in excess joint strain. Straight tube lines do not allow for expansion and contraction due to pressure and temperature fluctuations.
		
		
		
		Allow for expansion and contraction of lines by utilizing “U” bend.
		Offset (“S”) bend allows for motion under load.
		Avoid excessive pressure drop by getting around obstructions without using 90° bends. One 90° bend causes more pressure drop than two 45° bends.
		Avoid creating an obstruction by routing lines around areas that require service. Leave adequate clearance for wrenches.
		Route lines to allow for proper clamping. When done properly, several lines can typically be clamped together.  Route lines to allow for trouble-shooting. Lines that cross and are not in logical order tend to be difficult to work with during maintenance.

TABLE OF CONTENTS

SECTION TABLE OF CONTENTS

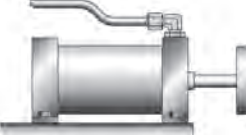
FAQs

R

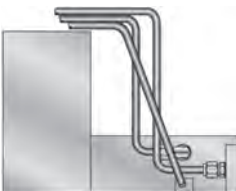
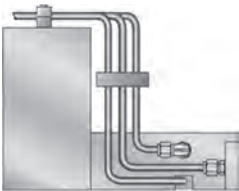
## Tube Clamping

Tube line supports (clamps) serve two primary purposes in tube line systems: mounting and vibration dampening. Fatigue failure due to mechanical vibration accounts for the majority of tube line failures. Proper clamping of the tube also reduces system noise.

Use a clamping system such as Parker's ParKlump series along with proper clamp spacing provided in Table R42.

**For tube clamps to dampen vibration effectively, they need to be anchored to a rigid structure. Clamping several tubes together, without rigid structural anchoring, does not provide effective dampening.**

A mountie can be used in lieu of clamps in certain product lines by anchoring a tee fitting to the equipment's structure (see Fig. R55).

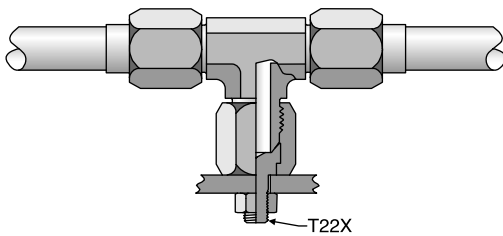

The Mountie Caps the End and Provides an Anchor

Fig. R55 — Mountie cap used with Triple-Lok for anchoring tube lines

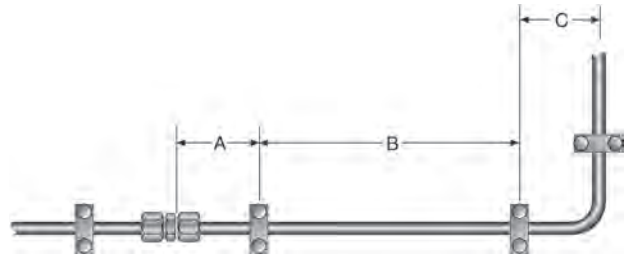

Tube O.D.		A (in.)	B (ft.)	C (in.)
(in.)	(mm)			
1/4	6	2	3	4
5/16	8			
3/8	10			
1/2	12	4	5	8
5/8	14			
3/4	18			
7/8	22			
1	25	6	7	12
1-1/4	30			
1-1/2	38			
2	50			

Table R42 — Recommended tube clamp spacing

## Layout Data for Tube, Pipe and Hose Clamps: Standard (Inch) and Series A (Metric)

Group #	Installation Dimensions					
		M	P	N	O	R
1	in.	1 5/16	1 3/16	1 3/16	5/8	15/16
	mm	33	30	30	16.5	24.5
1a	in.	1 7/16		1 1/8	5/8	15/16
	mm	36		29	16	24.0
2	in.	1 11/16		1 7/16	3/4	1 1/16
	mm	42		36	19.5	27.5
3	in.	2		1 1/2	13/16	1 1/8
	mm	50		38	20.5	28.5
4	in.	2 3/8		1 3/4	15/16	1 1/4
	mm	60		45	24	32.0
5	in.	2 13/16		2 3/8	1 1/4	1 9/16
	mm	70		61	32	40.0
6	in.	3 1/2		2 11/16	1 7/16	1 3/4
	mm	88		69	36	44.0

Table R40— ParKlump Standard Series Installation Dimensions

Bolt Thread	Torque	
	in.-lbs.	Nm
1/4 - 20 UNC	70	8

Table R41 — ParKlump Standard Series maximum tightening torque

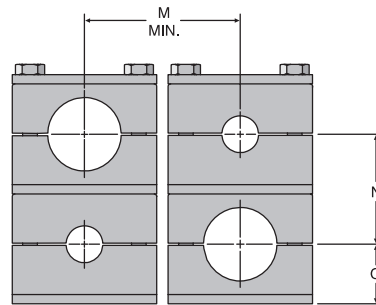

With Weld Plate

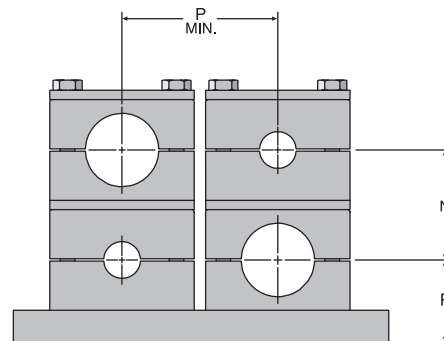

Rail Mounting

TABLE OF CONTENTS

SECTION TABLE OF CONTENTS

FAQs

### Layout Data for Tube, Pipe and Hose Clamps: Heavy Series (Inch) and Series C (Metric)

Group #		Installation Dimensions				
		M	N	O	P	R
H3	in.	2 15/16	1 9/16	15/16	2 5/16	1 1/2
	mm	74	40	24	58	38
H4	in.	3 1/2	2 3/16	1 1/4	2 7/8	1 13/16
	mm	89	56	32	73	46
H5	in.	4 1/16	2 11/16	1 1/2	3 7/16	2 1/16
	mm	103	68	38	87	52
H6	in.	5 7/8	3 7/8	2 1/8	4 5/8	2 5/8
	mm	150	98	54	118	66
H7	in.	7 1/8	5 1/16	2 3/4	N/A	N/A
	mm	180	129	69	N/A	N/A

Table R43 — ParKlump Heavy Series installation dimensions

Group #	Bolt Thread	Torque	
		in-Lb	Nm
H3, H4	3/8 - 16 UNC	106	12
H5	3/8 - 16 UNC	133	15
H6	7/16 - 14 UNC	265	30
H7	5/8 - 11 UNC	398	45

Table R44 — ParKlump Heavy Series maximum tightening torque

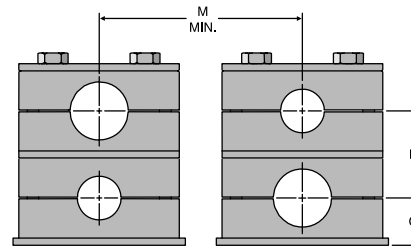

With Weld Plate

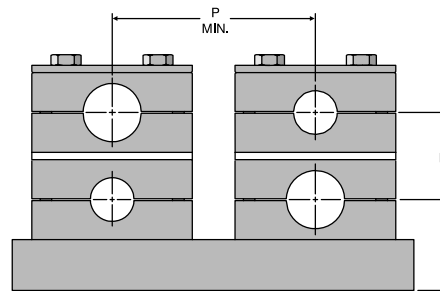

Rail Mounting

TABLE OF CONTENTS

SECTION TABLE OF CONTENTS

FAQs

### Layout Data for Tube, Pipe and Hose Clamps: Twin Series (Inch) and Series B (Metric)

Group #		Installation Dimensions			
		M	N	O	R
T1	in.	13/16	13/16	9/16	13/16
	mm	20	20	15	21
T2	in.	1 1/8	1	11/16	15/16
	mm	29	26	18	24
T3	in.	1 7/16	1 7/16	15/16	1 3/16
	mm	36	37	23.5	29.5
T4	in.	1 3/4	1 11/16	1	1 1/4
	mm	45	42	26	32
T5	in.	2 3/16	2 1/8	1 1/4	1 1/2
	mm	56	54	32	38

Table R45 — ParKlump Twin Series installation dimensions

Group #	Bolt Thread	Torque	
		in.-lbs.	Nm
T1	1/4 - 20 UNC	45	5
T2 - T4	5/16 - 18 UNC	104	12
T5	5/16 - 18 UNC	70	8

Table R46 — ParKlump Twin Series maximum tightening torque

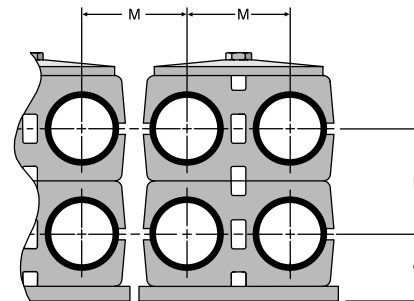

With Weld Plate

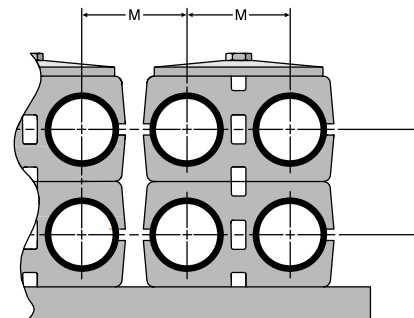

Rail Mounting

R

Dimensions and pressures for reference only, subject to change.



## Tools for Tube Bending

For smooth, wrinkle free tube bending without excessive flattening, there are a number of benders that can be selected. Consult the specific bender's instruction bulletins for CLR (centerline radius), wall thickness, and tube material recommendations and limitations. For crank and hydraulic benders, utilize both the mandrel bending determination chart (Fig. R59) and the Parker Bender Capacity Guides on page Q7.

- 1. Hand held lever type benders** (see pages Q4-Q6). Individually sized for tube sizes 1/8" through 1" and 6mm through 25mm.

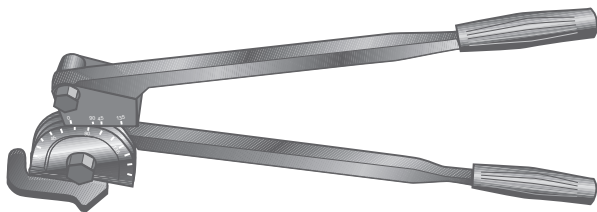

Fig. R56 — Hand held tube bender

- 2. Manual crank, table mount or vise mount benders:**

- 1) Model 412 (page Q8). For bending 1/4" through 3/4" O.D. tube or 6mm through 20mm.
- 2) Model 424 (page Q9). For bending 1/4" through 1 1/2" O.D. tube or 6mm through 38mm.

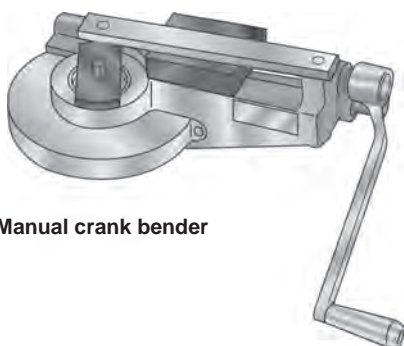

Fig. R57 — Manual crank bender

- 3. Hydraulically powered bender**

Model 632 (page Q12). For bending 3/8" through 2" O.D. tube or 10mm through 50mm.

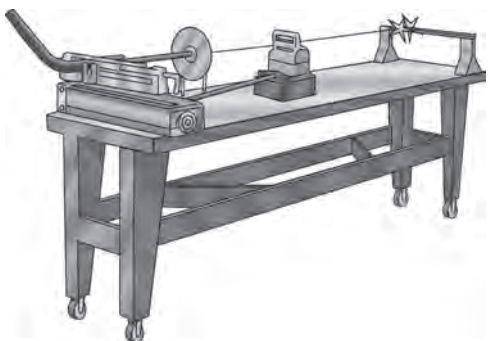

Fig. R58 — Hydraulic bender with portable table for mandrel bending

## Mandrel Bending Tools

When bending thin wall tube it may be necessary to insert a mandrel into the tube to prevent excessive distortion, flattening or wrinkling. To determine whether mandrel bending is required, see the Mandrel Bending Requirements Chart and example below.

To accomplish such bending, a mandrel, mandrel rod, and a mandrel rod stop assembly are required. The rod stop assembly holds the end of the mandrel rod in proper alignment with the tube while the mandrel, which is threaded on the other end of the mandrel rod, supports the tube on its I.D., thus preventing tube kinking or flattening during bending.

Mandrel Bending Requirements Chart

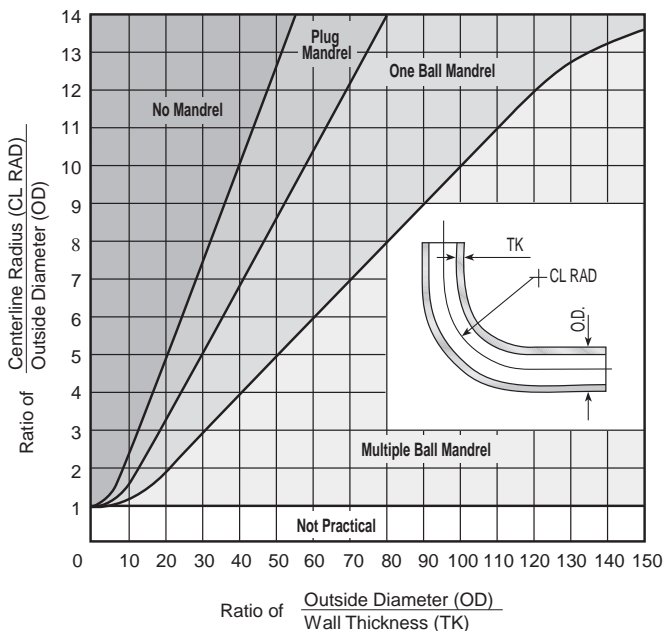

Fig. R59 — Mandrel bending requirements chart

**Example:** Determine if it's necessary to use mandrel for bending 3/4 x .049 steel tube through a 3" bend radius without excessive flattening.

$$\text{Centerline Radius/Tube Outside Diameter} = 3 / .75 = 4$$

$$\text{Outside Diameter / Wall Thickness} = .75 / .049 = 15.3$$

Intersection of these two ratios on the graph falls within the area indicating that no mandrel is required. Note, however, that for the same tube O.D. at a smaller bend radius (e.g. 2") or with a thinner wall thickness (e.g. .035"), a mandrel would be required for preventing excessive flattening.

If the tube wall is very thin, then a plug mandrel alone may not be adequate to prevent wrinkling. In such cases, special ball type mandrels and wiper shoes may be necessary (See Fig. R49 for illustrations of plug and ball type mandrels). As a rule of thumb, if the tube wall thickness is less than 7% of the tube O.D. then mandrel bending is recommended.

TABLE OF CONTENTS

SECTION TABLE OF CONTENTS

FAQs

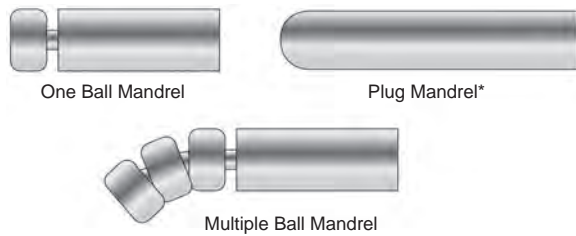

**Fig. R60 — Types of mandrels**

\*Parker Tube Fittings Division offers only the plug mandrel.

## Plumbing and Assembly Hints

Even after choosing the appropriate type of fitting for your application, there are certain instances when a particular style has advantages over others.

1. Straight thread adjustable elbows and tees have several advantages over similar shaped fittings using tapered pipe threads:

Adjustable straight thread connections:

- Permit exact positioning
- Provide leak free joint
- Eliminate distortion and cracking of boss due to over-tightening
- Are easier to maintain

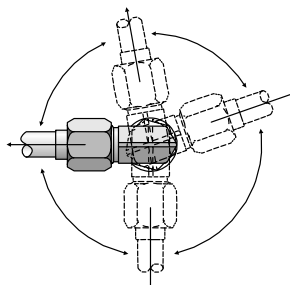

**Fig. R61 — Top view of adjustable straight thread connection — allows for 360° positioning of fitting without losing its sealing capability**

2. Swivel nut fitting should be used with a straight connector to allow for connections in tight spaces, where an elbow or tee fitting cannot be fully rotated (see Fig. R62).

This same combination of fittings, shown in Fig. R60, can also be used to stack tube lines or provide clearance for ports that are relatively close and within the same plane (see Fig. R63).

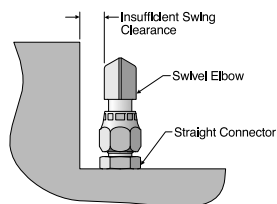

**Fig. R62 — Swivel nut fitting used with straight connector in tight space**

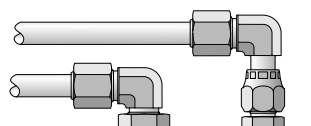

**Fig. R63 — Swivel end fitting with straight connector provides clearance above regular elbow**

3. Use reducers/expanders and jump size fittings.

There are some instances when it becomes necessary to connect tube lines of different sizes or tube lines to ports of different sizes. This can be accomplished by using either tube reducers, port expanders, port reducers, or jump size fittings. Achieving the reduction or enlargement is the main concern, but this should be accomplished by using the minimum number of connections (potential leak points and wrenching requirements) possible.

4. Use conversion fittings and adapters.

There are instances when it becomes necessary to use conversion adapters for connecting a fitting to a port with different style threads, for example, UNF thread fitting to a metric thread port. There are also some instances when it is necessary to connect tube ends or hose ends with different style terminations to one another or to a fitting. This can be achieved by using conversion fittings.

5. Use of other adapters and fittings for special applications are shown below.

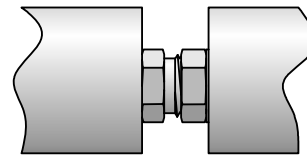

**Fig. R64 — F50HAO for close coupling of components with two SAE Straight thread ports**

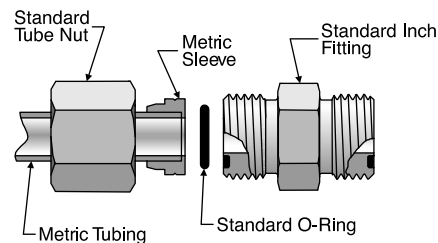

**Fig. R65 — Metric sleeve adapts metric tube to standard Seal-Lok**

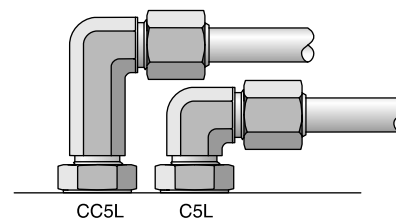

**Fig. R66 — Long elbow (CC5L) stacks above regular elbow (C5L)**

TABLE OF CONTENTS

SECTION TABLE OF CONTENTS

FAQs

R



# S

# GENERAL TECHNICAL

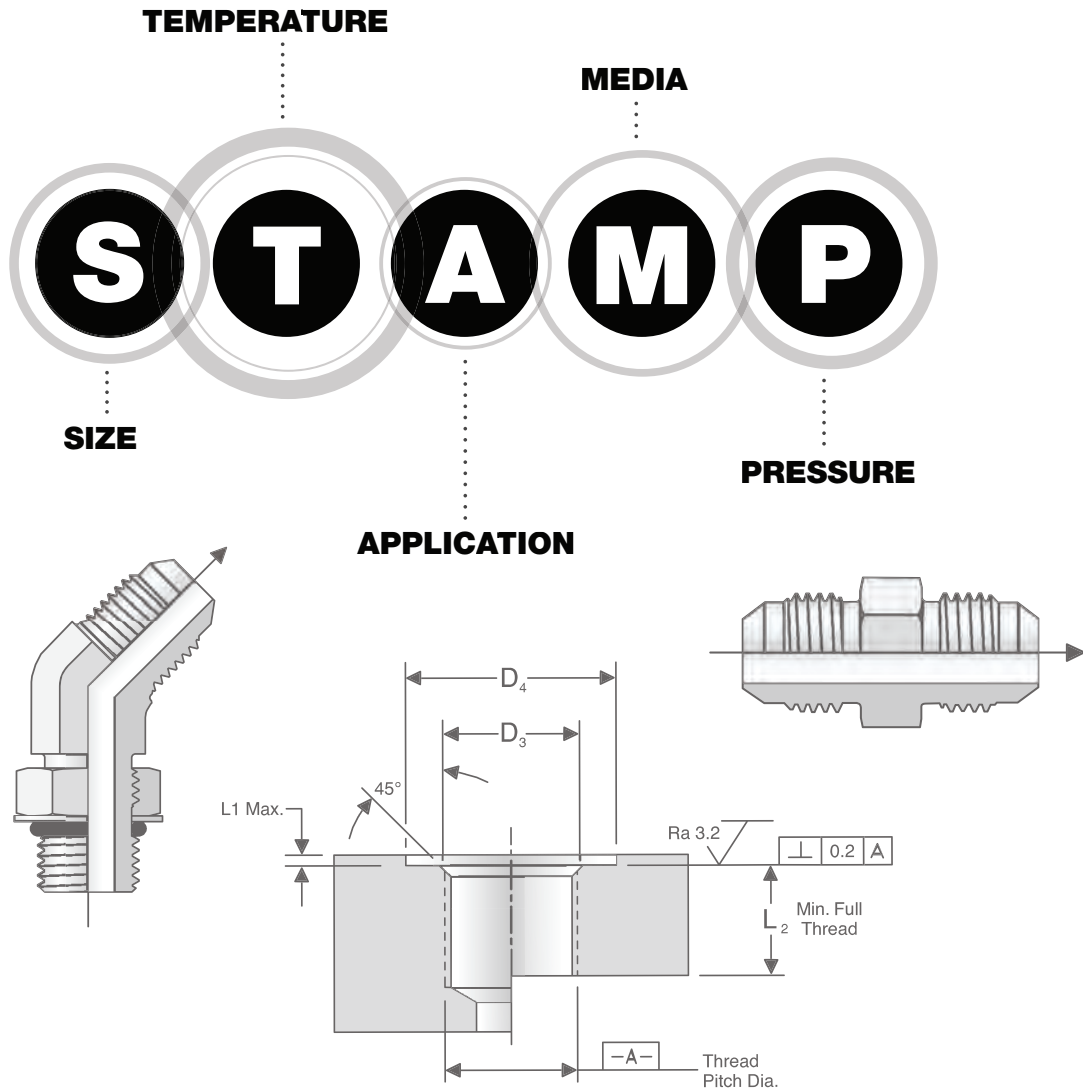

# Contents



	<b>STAMP Overview .....</b>	<b>S3</b>
	<b>Fitting and Tube Selection Chart .....</b>	<b>S4</b>
<b>S</b>	<b>Size</b>	
	Overview .....	S4
	Recommended Flow Diameter — In Inches .....	S5
	Recommended Flow Diameter — In Millimeters .....	S6
	Tube Fittings Pressure Drop .....	S7-S9
<b>T</b>	<b>Temperature</b>	
	Overview .....	S10
<b>A</b>	<b>Application</b>	
	Overview .....	S13
	Tube to Port Pairing .....	S14
	Port End Summary .....	S15
	Tube/Hose End Summary.....	S16
<b>M</b>	<b>Media</b>	
	Fluid Compatibility, Protective Coatings On Steel, Choosing Tube Material and Type.....	S17
	Tube and Fitting Material Compatibility.....	S19
<b>P</b>	<b>Pressure</b>	
	Fitting and Adapter Pressure Ratings.....	S25
	Inch Tube Pressure Ratings.....	S27
	Metric Tube Pressure Ratings.....	S29
	<b>Fitting and Tube Selection Chart Completed Example .....</b>	<b>S31</b>
	<b>Reference .....</b>	<b>S33</b>
	Port and Tube Pairing .....	S33
	Common Port Details.....	S34
	Recommended Use of Porting Tools .....	S40
	Common Tube End Thread Sizes .....	S41
	Conformance Standards.....	S43
	Fitting Materials .....	S46
	Fitting Designs Industry Standards.....	S47
	<b>How To Order (TFD Standard Nomenclature Construction)</b>	
	Seal-Lok, Triple-Lok, Ferulok, JIS and K4.....	S48
	4-Bolt Hydraulic Flanges.....	S49
	EO and EO-2 Fittings and Accessories .....	S50

Dimensions and pressure for reference only, subject to change.



# STAMP OVERVIEW

## Tube Fitting and Adapter Selection Process

### Critical information needed prior to tube fitting and adapter selection can start:

In general, even though a tube fitting or adapter is just a small component in a complex system, all the system information is needed to ensure the proper tube fitting or adapter selection. Without taking these into consideration, system issues will occur.

Below is the minimum system information needed to start this process:

- Flow rate
- Temperature range
- Media type
- Working pressure

With this information, a process named “STAMP” can be followed to choose a proper tube fitting or adapter. STAMP is an industry acronym that stands for Size, Temperature, Application, Media or Material, and Pressure. When STAMP is followed, the tube fittings and adapters with the proper size, appropriate material of construction and correct pressure rating for the application will result.

Below is an overview of each part of STAMP:

**Size:** Fitting and tube internal diameter (I.D.) and outside diameter (O.D.)

The I.D. can be calculated based on flow rate and velocity, and the O.D. will be determined based on pressure rating and considerations from other categories.

**Temperature:** System and environment temperature range.

Fitting and seal material types, connection types and pressure rating are temperature dependent.

**Application:** Severity of service, industry custom, regulation, standards, geographic region, serviceability, etc.

Severe, hazardous or critical to safety service needs more robust solutions. Some industries have special standards or regulation requirements. As well, certain regions tend to use specific types of products.

**Media or Material:** System and environment media, fitting and seal material type

Fitting and seal material must be compatible with system media and the environment. Incompatible material can result in excessive corrosion, system contamination, and leakage.

**Pressure:** System pressure requirements and fitting pressure rating

Fittings and tubes must meet the system pressure rating requirements.

TABLE  
OF  
CONTENTS

SECTION  
TABLE OF  
CONTENTS

S

## Tube Fitting and Adapter Selection Steps using STAMP .....



TABLE OF CONTENTS

SECTION TABLE OF CONTENTS

On the following pages, detailed steps on how to properly pick tube fittings and adapters for your system using STAMP are outlined.

The blank table below can be used to organize the information from each of the steps. This table can also be printed and used as a worksheet for any tube fitting and adapter selection. At the end of this section (page S31), a completed table has been filled out as an example.

Summary Information				
Size	I.D.		O.D.	
Temperature	Material Conveyed		Environment	
	Min.	Max.	Min.	Max
Application	Industrial Standards	Connection Styles	Severity of Service	Other
Material Media	Internal Media		External Environment	
Pressure	Max. Working Pressure		Spikes	Vacuum
Selection Process				
STAMP Process			Explanation	

### STEP 1: SIZE

The first step of fitting selection is to determine the size. Fitting size is driven by flow diameter or internal diameter (I.D.). System flow rate and flow velocity are needed to calculation flow diameter. Normally system flow rate is expressed in gallons per minute (GPM) or liters per minute (LPM). Flow velocity is expressed in feet per second (ft/sec) or meters per second (m/sec). The following formulae can be used to calculate the fitting I.D.

In hydraulic systems, the following maximum flow velocities are commonly used:

- Pressure lines: 25 ft/sec or 7.62 m/sec
- Return lines: 10 ft/sec or 3.05 m/sec
- Suction lines: 4 ft/sec or 1.22 m/sec

Tube/Fitting I.D. (in) = 0.64	$\sqrt{\frac{\text{Flow in GPM}}{\text{Velocity in ft/sec}}}$
OR	
Tube/Fitting I.D. (mm) = 4.61	$\sqrt{\frac{\text{Flow in LPM}}{\text{Velocity in m/sec}}}$

Dimensions and pressure for reference only, subject to change.

# Recommended Flow Diameter — In Inches.....



TABLE OF CONTENTS

SECTION TABLE OF CONTENTS

For your convenience, the flowing tables have been prepared based on the formula and maximum flow velocities on the previous page.

Maximum Flow Rate GPM	Recommended Flow Diameter in Inches		
	Pressure Lines	Return Lines	Suction Lines
0.25	0.064	0.101	0.160
0.50	0.091	0.143	0.226
0.75	0.111	0.175	0.277
1.00	0.128	0.202	0.320
1.25	0.143	0.226	0.358
1.50	0.157	0.247	0.392
1.75	0.169	0.267	0.423
2.00	0.181	0.286	0.453
2.50	0.202	0.319	0.506
3.00	0.222	0.350	0.554
3.50	0.239	0.378	0.599
4.00	0.256	0.404	0.640
4.50	0.272	0.429	0.679
5.00	0.286	0.452	0.716
5.50	0.300	0.474	0.750
6.00	0.314	0.495	0.784
6.50	0.326	0.515	0.816
7.00	0.339	0.534	0.847
7.50	0.351	0.553	0.876
8.00	0.362	0.571	0.905
8.50	0.373	0.589	0.933
9.00	0.384	0.606	0.960
9.50	0.395	0.623	0.986
10.00	0.405	0.639	1.012
11.00	0.425	0.670	1.061
12.00	0.443	0.700	1.109
13.00	0.462	0.728	1.154
14.00	0.479	0.756	1.197
15.00	0.496	0.782	1.239
16.00	0.512	0.808	1.280
17.00	0.528	0.833	1.319
18.00	0.543	0.857	1.358
19.00	0.558	0.880	1.395
20.00	0.572	0.905	1.431
21.00	0.587	0.927	1.466

Maximum Flow Rate GPM	Recommended Flow Diameter in Inches		
	Pressure Lines	Return Lines	Suction Lines
22.00	0.600	0.947	1.501
24.00	0.627	0.990	1.568
26.00	0.653	1.030	1.632
28.00	0.677	1.069	1.693
30.00	0.701	1.106	1.753
32.00	0.724	1.143	1.810
34.00	0.746	1.178	1.866
36.00	0.768	1.212	1.920
38.00	0.789	1.245	1.973
40.00	0.810	1.278	2.024
42.00	0.830	1.309	2.074
44.00	0.849	1.340	2.123
46.00	0.868	1.370	2.170
48.00	0.887	1.399	2.217
50.00	0.905	1.428	2.263
55.00	0.949	1.498	2.373
60.00	0.991	1.565	2.479
65.00	1.032	1.629	2.580
70.00	1.071	1.690	2.677
75.00	1.109	1.749	2.771
80.00	1.145	1.807	2.862
85.00	1.180	1.862	2.950
90.00	1.214	1.916	3.036
95.00	1.248	1.969	3.119
100.00	1.280	2.020	3.200
110.00	1.342	2.119	3.356
120.00	1.402	2.213	3.505
130.00	1.459	2.303	3.649
140.00	1.515	2.390	3.786
150.00	1.568	2.474	3.919
160.00	1.619	2.555	4.048
170.00	1.669	2.634	4.172
180.00	1.717	2.710	4.293
190.00	1.764	2.784	4.411
200.00	1.810	2.857	4.525

Table S1 — Recommended Flow Diameters, in Inches



## Recommended Flow Diameter — In Millimeters .....



TABLE OF CONTENTS

SECTION TABLE OF CONTENTS

Maximum Flow Rate LPM*	Recommended Flow Diameter in mm			Maximum Flow Rate LPM*	Recommended Flow Diameter in mm		
	Pressure Lines	Return Lines	Suction Lines		Pressure Lines	Return Lines	Suction Lines
1.00	1.67	2.64	4.18	80.00	14.94	23.61	37.39
2.00	2.36	3.73	5.91	85.00	15.40	24.34	38.54
3.00	2.89	4.57	7.24	90.00	15.84	25.05	39.66
4.00	3.34	5.28	8.36	95.00	16.28	25.73	40.74
5.00	3.73	5.90	9.35	100.00	16.70	26.40	41.80
6.00	4.09	6.47	10.24	110.00	17.52	27.69	43.84
7.00	4.42	6.99	11.06	120.00	18.29	28.92	45.79
8.00	4.72	7.47	11.82	130.00	19.04	30.10	47.66
9.00	5.01	7.92	12.54	140.00	19.76	31.24	49.46
10.00	5.28	8.35	13.22	150.00	20.45	32.33	51.19
11.00	5.54	8.75	13.84	160.00	21.12	33.39	52.87
12.00	5.79	9.15	14.48	170.00	21.77	34.42	54.50
14.00	6.25	9.88	15.64	180.00	22.41	35.42	56.08
16.00	6.68	10.56	16.72	190.00	23.02	36.39	57.62
18.00	7.09	11.20	17.73	200.00	23.62	37.34	59.11
20.00	7.47	11.81	18.69	220.00	24.77	39.16	62.00
22.00	7.83	12.38	19.61	240.00	25.87	40.90	64.76
24.00	8.18	12.93	20.48	260.00	26.93	42.57	67.40
26.00	8.52	13.46	21.31	280.00	27.94	44.18	69.95
28.00	8.84	13.97	22.12	300.00	28.93	45.73	72.40
30.00	9.15	14.46	22.90	320.00	29.87	47.23	74.77
32.00	9.45	14.93	23.65	340.00	30.79	48.68	77.08
34.00	9.74	15.39	24.37	360.00	31.69	50.09	79.31
36.00	10.02	15.84	25.08	380.00	32.55	51.46	81.48
38.00	10.30	16.27	25.77	400.00	33.40	52.80	83.60
40.00	10.56	16.70	26.44	450.00	35.43	56.00	88.67
45.00	11.20	17.71	28.04	500.00	37.34	59.03	93.47
50.00	11.81	18.67	29.56	550.00	39.17	61.91	98.03
55.00	12.39	19.58	31.00	600.00	40.91	64.67	102.39
60.00	12.94	20.45	32.38	650.00	42.58	67.31	106.57
65.00	13.46	21.28	33.70	700.00	44.18	69.85	110.59
70.00	13.97	22.09	34.97	750.00	45.74	72.30	114.47
75.00	14.46	22.86	36.20	800.00	47.24	74.67	118.23

**Table S2 — Recommended Flow Diameters, in Millimeters**

\*LPM = Liters Per Minute

Dimensions and pressure references only, subject to change.

Proceed to step 2 once size is determined.

For deeper understanding, the detailed information below explains the effect of tube fitting and adapter size. It is provided only as a reference for further understanding.

### Effect of fitting size:

Fitting size directly affects system efficiency. Proper sizing for various parts of a hydraulic system results in an optimum combination of efficient and cost-effective performance.

A tube or fitting that is too small causes high fluid velocity, which has many detrimental effects. In suction lines, it causes cavitation which starves and damages pumps. In pressure lines, it causes high friction losses and turbulence, both resulting in high pressure drops, noise and heat generation. High heat accelerates wear in moving parts and rapid aging of seals and hoses, all resulting in reduced component life. High heat generation also means wasted energy, and hence, low efficiency.

Too large of a tube or fitting increases system cost, weight and envelop size. Therefore, fitting size selection should balance considerations of efficiency, cost, weight and size.

Hydraulic systems efficiency can be simply measured by pressure drop. Pressure drop represents loss of energy and therefore should be kept to a minimum with the constraints of acceptable system cost and overall size. Pressure loss in straight tubing and fittings is mainly caused by the

..... **S**

**TABLE OF CONTENTS**

**SECTION TABLE OF CONTENTS**

frictional resistance of the walls, while in shaped fittings it is mainly caused by changes in the magnitude or direction of the fluid velocity. Mathematical analysis of pressure drop, even though possible, may not be exact because of the interrelationship of factors such as fluid density, velocity, flow area and frictional coefficients.

The following pressure drop charts were derived from actual test data and may be used as a guide for determining pressure drops at various flow rates through fittings for fluid indicated. To determine pressure drop for a given flow, trace a vertical line up from the flow axis to the desired size line then trace a horizontal line from this intersection over to the pressure drop axis.

**Example:**

The Parker fitting 8 CTX (1/2" OD 90-degree elbow fitting), with oil similar to the test fluid, flowing through it at 4 gallons per minute, would cause a pressure drop of approximately 2.3 psi, as shown in Fig. 2. Conversions will have to be made for fluids which are not similar to the test fluid.

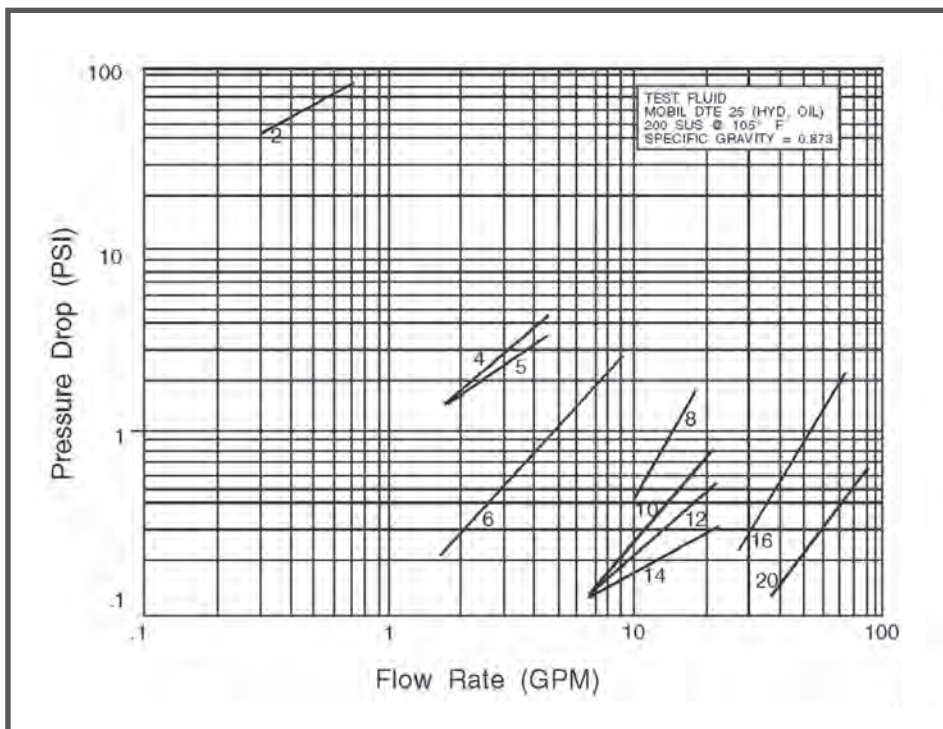

**Examples:**



Fig. 1 — Pressure Drop Chart for Straight Fittings and Run Legs of Tees and Crosses (Triple-Lok)

**S**





TABLE OF CONTENTS

SECTION TABLE OF CONTENTS

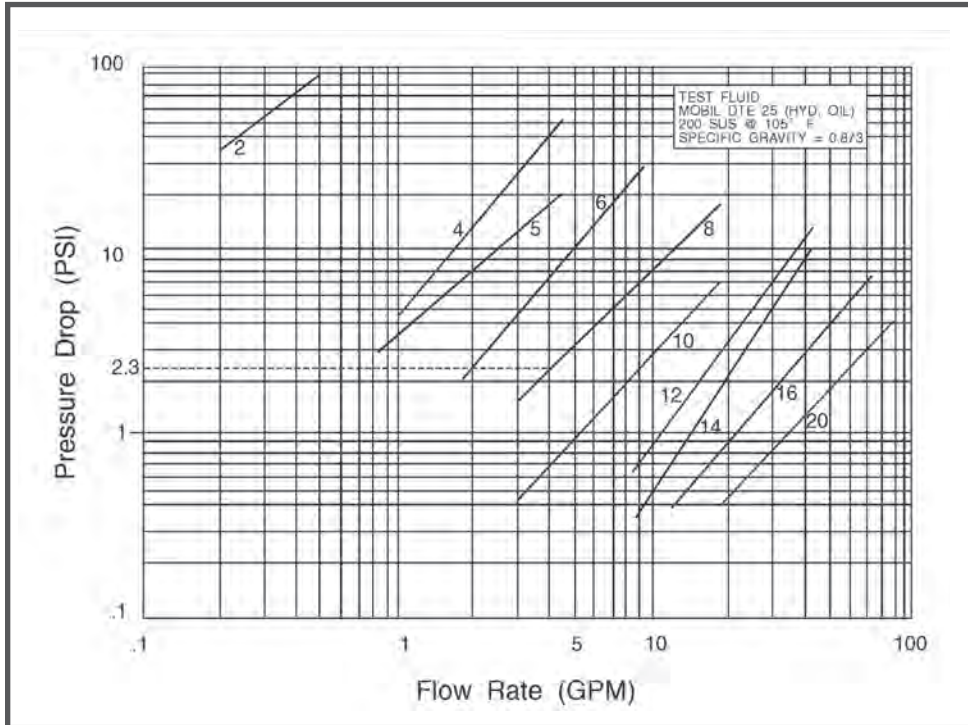

Example:



Examples:



Fig. 2 — Pressure Drop Chart for 90° Fittings or Branch Path Through a Tee or Cross Fitting (Triple-Lok)

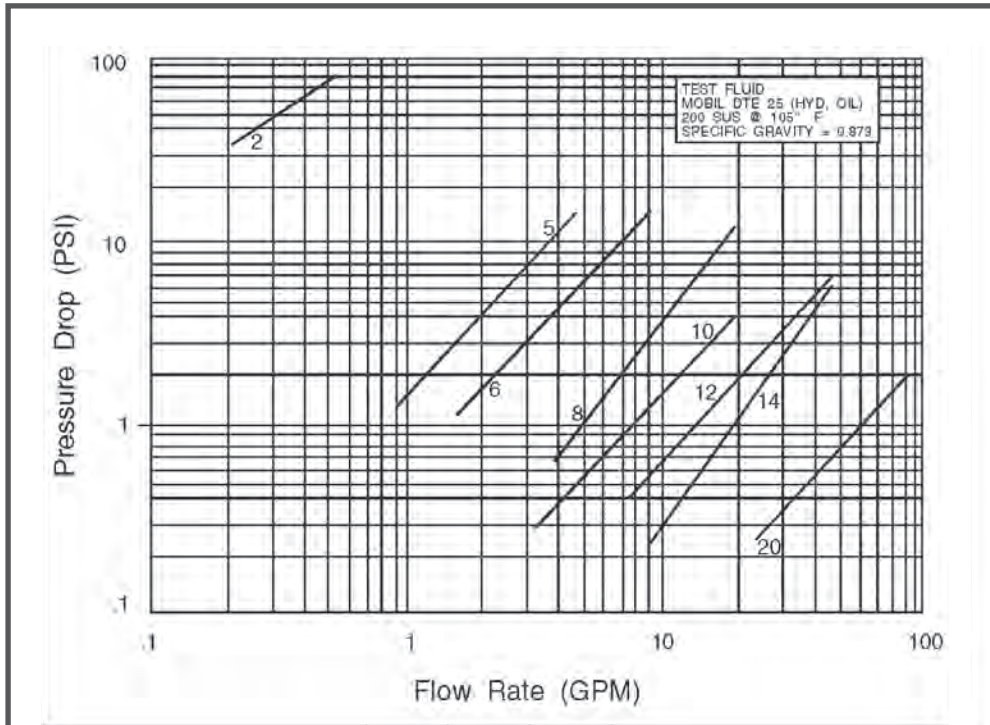

Example:



Fig. 3 — Pressure Drop Chart for 45° Elbow Fittings (Triple-Lok)

## Pressure Drops for Other Fittings: .....



These pressure drop curves were established with Triple-Lok 37-degree flare fittings. The pressure drop values can be adjusted for other fittings of the same size by multiplying the value from the chart by the ratio of Triple-Lok flow diameter to that of the other fitting, raised to the 4th power.

Example: Find pressure drop for 6 C5L (Seal-Lok O-Ring Face Seal Fitting) at 5 gallons per minute flow rate:

From the chart, the pressure drop for 6 C5X is 10 psi.

Also, the ratio of 6 C5X to 6 C5L flow diameters is 0.297/0.264, or 1.125.

Therefore, the pressure drop for Seal-Lok O-Ring Face Seal fitting =  $10 \times (1.125)^4 = 16$  psi.

## Pressure Drops for Other Fluids:

Pressure drop through a fitting is mainly caused by change in direction and velocity of the fluid. Therefore, it is directly proportional to the specific gravity of the fluid. The drop due to friction, which is dependent on the viscosity of the fluid, is so small in this case that it can be ignored. Thus, the pressure drop with a different fluid can be estimated by multiplying the value from the graph above by the ratio of specific gravity of the two fluids, or:

$$\text{New Drop} = \text{Value from the graph} \times \frac{\text{Specific Gravity of New Fluid}}{\text{Specific Gravity of Test Fluid (0.873)}}$$

***Read our TFD techConnect blog post “Sizing Tube to Maximize Hydraulic System Efficiency” for more details.***



TABLE  
OF  
CONTENTS

SECTION  
TABLE OF  
CONTENTS

## STEP 2: TEMPERATURE

Temperature range is a very important factor to consider during tube fitting and adapter selection. Both environment temperature and system media temperature should be considered. Ensure that the tube fitting or adapter, tube and seal material temperature ranges are adequate for the system temperature range.

Temperature range of common tube fitting, adapter, and seal materials can be found in Table S3 and S4.

Material	Specification	Construction	Condition	Max Hardness	Temperature Range
Carbon Steel C-1010	SAE J524 (ASTM A179)	Seamless	Fully Annealed	HRB 72	-65° to 500°F -55° to 260°C
	SAE J525 (ASTM A178)	Welded & Drawn			
	SAE J356	Welded & Flash Controlled			
Carbon Steel C-1021	SAE J2467	Welded & Flash Controlled	Fully Annealed	HRB 75	-65° to 500°F -55° to 260°C
	SAE J2435	Welded & Drawn			
Carbon Steel High Strength Low Alloy (HSLA)	SAE 2613	Welded & Flash Controlled	Sub-critically annealed	HRB 90	-65° to 500°F -55° to 260°C
	AE J2614	Welded & Drawn			
Alloy Steel 4130	ASTM A519	Seamless			-65° to 500°F -55° to 260°C
St 37.4 (Carbon Steel)	DIN 2391 Part 2 (Metric)	Seamless	Fully Annealed	HRB 72	-65° to 500°F -55° to 260°C
Stainless Steel 304 & 316	ASTM A213 ASTM A269	Seamless	Fully Annealed	HRB 90	-425° to 1200°F -255° to 650°C
	ASTM A249 ASTM A269	Welded & Drawn			
1.4571 1.4541 Stainless Steel	DIN 17458 Tab 8 (Metric)	Seamless	Fully Annealed	HRB 90	-425° to 1200°F -255° to 650°C
Copper	SAE J528 (ASTM B75)	Seamless	Soft Annealed Temper O	60 Max. Rockwell 15T	-325° to 400°F -200° to 205°C
Aluminum 6061	ASTM B210	Seamless	T6 Temper	HRB 56	-325° to 400°F -200° to 205°C
			O & T4 Temper	HRB 30	
Monel 400	ASTM B165	Seamless	Fully Annealed	HRB 70	-400° to 800°F -240° to 425°C
Nylon		Extruded	Flexibe & Semi-Rigid		-60° to 200°F -50° to 95°C
Polyethylene	ASTM D1248	Extruded	Instrument Grade		-80° to 150°F -60° to 65°C
PVC		Extruded	Instrument & Laboratory Grade		0° to 140°F -20° to 60°C
PFTE		Extruded & Cintered			-65° to 400°F -55° to 205°C

Table S3 — Temperature range for common tube and fitting materials



TABLE OF CONTENTS

SECTION TABLE OF CONTENTS

Polymer Family	Abbreviated Name	Parker Compound No.	Color	SAE J515 Type	Hardness Shore "A" <sup>7)</sup>	Temperature Range (°F)	Recommended For	Not Recommended For
Nitrile-Butadiene Nitrile-Butadiene Nitrile-Butadiene	NBR NBR NBR	N1490/N0552 N0674 N0103	Black Black Black	CH <sup>2)</sup> — —	90 <sup>6)</sup> 70 70	-30° to 250° -30° to 250° -65° to 225°	Petroleum base oils and fluids, mineral oils, ethylene glycol base fluids, silicone and di-ester base lubricants, air, water under 150°F, and natural gas.	Phosphate ester base hydraulic fluids, automotive brake fluids, strong acids, ozone, freons, ketones, halogenated hydrocarbons, and methanol.
Nitrile-Butadiene (Low compression set)	NBR	N1059	Black	CH <sup>2)</sup>	90	-30° to 275°		
Nitrile-Butadiene Nitrile-Butadiene Nitrile-Butadiene	NBR NBR NBR	N0507 N0304 N0508	Black Black Black	— — —	90 75 75	-65° to 225° -65° to 180° -65° to 225°	Meets FDA requirements for food products	
Nitrile-Butadiene	NBR	N0756	Black	—	75 <sup>6)</sup>	-35° to 250°		
Ethylene-Propylene	EPDM	E0540	Black	CA <sup>3)</sup>	80	-65° to 275°	Phosphate ester base hydraulic fluids, hot water, steam to 400°F, silicone oils and greases, dilute acids and alkalis, ketones, alcohols and automotive brake fluids.	Petroleum base oils and di-ester base lubricants.
Ethylene-Propylene	EPDM	E0893	Purple <sup>1)</sup>	CA <sup>3)</sup>	80	-65° to 275°		
Ethylene-Propylene	EPDM	E0962	Black	—	90	-65° to 275°	CO2 climate control systems.	
Neoprene Neoprene	CR CR	C0873 C0944	Black Red <sup>1)</sup>	— —	70 70	-45° to 250° -45° to 250°	Refrigerants (freons, ammonia), high aniline point petroleum oils, mild acids, and silicate ester lubricants.	Phosphate ester fluids and ketones.
Fluorocarbon	FKM <sup>5)</sup> or FPM	V0747 V0884 V1412/V0894	Black Brown <sup>1)</sup> Brown <sup>1)</sup> , 5)	— — HK <sup>4)</sup>	75 75 90 <sup>6)</sup>	-15° to 400° -15° to 400° -15° to 400°	Petroleum base oils and fluids, some phosphate ester base fluids, silicone and silicate ester base lubricants, di-ester base lubricants, acids and halogenated hydrocarbons.	Ketones, skydrol fluids, amines (VDMH), anhydrous ammonia, low molecular weight esters and ethers, and hot hydrofluoric or chlorosulfonic acids.
Silicone	Si	S0604	Rust <sup>1)</sup>	—	70	-65° to 450°	Dry Hear (air to 400°) and high aniline point oils.	Most petroleum fluids, ketones, water and steam.

- 1) These Parker "Chromassure" color assurance O-Rings are available from the Parker Hannifin O-Ring Division. They help eliminate assembly errors, reduce warranty costs and liability risks, and assure safety in aftermarket business.
- 2) Formerly SAE Type I.
- 3) Formerly SAE Type II.
- 4) Formerly SAE Type III.
- 5) "FKM" is the ASTM designation for fluorocarbon. Its ISO designation is "FPM". For "DIN" Fittings, color is green.
- 6) Standard compounds available from stock.
- 7) Use 90 durometer hard O-Rings for applications with 1500 psi or higher pressures.

**Table S4 — Temperature range and media compatibility for common seal materials**

Standard seals supplied with Parker tube fittings and adapters are 90 durometer hard nitrile (Buna-N) Parker compound **N1490, N0552 or similar**. These O-Rings are well suited for most industrial hydraulic and pneumatic systems. They have high extrusion resistance making them suitable for very high-pressure static applications. Optional high temperature fluorocarbon, Parker compound **V1412 or V0894**, is also available for higher temperature specifications.

Seals for other than normal hydraulic media or higher temperature applications can be selected from Table S4. The table should be used only as a general guide. Before making final selection for a given application, it is recommended that appropriate tests be conducted to assure compatibility with the fluid, temperature, pressure and other environmental conditions.





TABLE  
 OF  
 CONTENTS

SECTION  
 TABLE OF  
 CONTENTS

High operating temperature also reduces allowable working pressure of fittings. Temperature derating factors for various metals are given in Table S5. Where applicable, temperature derating factors should be applied to the design pressure values to arrive at the maximum recommended working pressure. The derating factors are based on allowable design stress values at various temperatures per ASME B31.1 code for pressure piping.

Maximum Operating Temperature (°F)	Steel C-1010 and C-4130	Stainless Steel		Brass CA360 CA377	Copper	Aluminum 6061-T6	Monel Type 4000
		304	316				
100	1.00	1.00	1.00	1.00	1.00	1.00	1.00
150	1.00	0.91	1.00	0.94	0.85	1.00	0.97
200	1.00	0.84	1.00	0.90	0.80	1.00	0.94
250	1.00	0.79	1.00	0.87	0.80	0.94	0.91
300	1.00	0.75	1.00	0.83	0.78	0.80	0.88
350	0.99	0.72	0.99	0.80	0.67	0.60	0.86
400	0.98	0.69	0.97	0.40	0.50	0.43	0.85
500	0.96	0.65	0.90				0.84
600		0.61	0.85				0.84
700		0.59	0.82				0.84
800		0.57	0.80				0.83
900		0.54	0.78				
1000		0.52	0.77				
1100		0.47	0.62				
1200		0.32	0.37				

Table S5 — Temperature derating factor for common metals



## STEP 3: APPLICATION

The nature of applications must be carefully evaluated, such as vibration, side load, severity of service, external environment, regional custom and convention, industry standards, regulation, etc. Table S6 lists different service categories and their recommended design factors.

Severity of Service	Description	Design Factor	Derating Factor
A (Normal)	Moderate mechanical and hydraulic shocks.	4.00	1.00
B (Severe)	Severe hydraulic shocks and mechanical strain.	6.00	0.67
C (Hazardous)	Hazardous application with severe service conditions.	8.00	0.50

**Table S6 — Severity of Service Design and Derating Factors**

Today many different types of connectors are being used around the world. Most of these have come about through historical use and local preference for a certain design concept. Some of them are only used in a specific geographic region or a particular industry. Some connections of North American origin such as four bolt flange, SAE straight thread, and 37° flare have found some degree of acceptance and use in Europe and Japan as a result of the exports of U.S. machinery to the regions after World War II. But, most of the usage is made up of a variety of indigenous port and tube connections. A quick review of the commonly used connections around the world reveals that there are eight different port connections and eleven different tube/hose connections.

### Port Connections

- ISO 6149 (Metric Straight Thread O-Ring Port)
- SAE Straight Thread (UN/UNF)
- NPTF
- 4-Bolt Flange
- ISO 1179 (BSPP)
- ISO 9974 (Metric)
- JIS-PT (BSPT)
- JIS-B2351 (BSPP similar to SAE)

### Tube/Hose Connections:

- O-Ring Face Seal (SAE)
- 37° Flare (SAE)
- 24° Flareless, Inch Threads (SAE)
- 24° Cone, Metric (DIN)
- 60° Cone Swivel, NPSM (SAE)
- 60° Cone, BSPP (BSI)
- 60° Cone, BSPP (JIS)
- 60° Cone, Metric (JIS)
- 30° Flare, BSPP (JIS)
- 24° Flareless, Metric (JIS)
- 37° Flare, Metric (Russia)

To promote interchangeability and reduce complexity, the following table lists preferred connection types according to ISO recommendations. The preferred fitting styles should be selected when possible.



Application	Port	Tube/Hose Connection			
		24° Cone Flareless (Din) (Bite Type)	37° Flare (Inch Threads)	ORFS	24° Cone Weld Nipple
For All Designs	Metric ISO 6149 (SAE J2244)	ISO 8434-1	ISO 8434-2	ISO 8434-3	ISO 8434-1
Not for New Designs in Hydraulic Fluid Power	Metric ISO 1179 (DIN 3852-2)	ISO 8434-1	ISO 8434-2	— —	ISO 8434-1
	Metric ISO 9974 (DIN 3852-1)	ISO 8434-1	— —	— —	ISO 8434-1
	UN/UNF ISO 11926 (SAE J1926)	— —	ISO 8434-2	— —	— —

**Table S7 — ISO Standard Port and Tube/Hose Connection Combinations**

Table S8 on the following page shows a summary of port connections

*See our TFD techConnect blog post “Spatial Allowance for Fittings in Fluid and Gas Systems” for the seven questions Parker recommends asking when selecting fittings.*











*Learn the difference between AN 37 (degree sign) Flare vs Industrial 37 (degree sign) Flare Fittings in our TFD techConnect blog post.*

# Port End Summary .....

**A**

**TABLE OF CONTENTS**

**SECTION TABLE OF CONTENTS**

Port End Type and Seal Style	Illustration	Pressure — Dynamic	Pressure — Static	Temperature	Positioning	Contamination	Seal Reliability	Reusability	Fluid Compatibility
Tapered (NPT, NPTF, BSPT and Metric Taper)		Poor	Good	Excellent	Poor	Poor	Poor	Poor	Excellent
O-Ring in Chamfer (SAE J1926, ISO 6149 and JIS B2351)		Excellent	Excellent	Limited by Seal	Excellent	Very Good	Excellent	Excellent	Limited by Seal
Spot Face with ED Seal (ISO 1179-2 and ISO 9974-2)		Excellent	Excellent	Limited by Seal	Not Applicable	Very Good	Excellent	Excellent	Limited by Seal
Spot Face with Bonded Seal (ISO 1179 and ISO 9974)		Good	Good	Good	Not Applicable	Very Good	Good	Excellent	Limited by Seal
Spot Face with Cutting Face (ISO 1179-4 and ISO 9974-3)		Poor	Fair	Excellent	Not Applicable	Fair	Poor	Poor	Excellent
Spot Face with O-Ring and Retaining Ring (ISO 1179-3)		Good	Good	Good	Excellent	Very Good	Good	Excellent	Limited by Seal
Spot Face with Hard Metal Seal (ISO 1179 and ISO 9974)		Poor	Fair	Excellent	Not Applicable	Fair	Poor	Poor	Excellent
Spot Face with Soft Metal Seal (ISO 1179 and ISO 9974 with copper gasket)		Poor	Fair	Good	Not Applicable	Very Good	Poor	Fair	Excellent
4 Bolt Flange (SAE J518 and ISO 6162)		Excellent	Excellent	Good	Good	Very Good	Good	Excellent	Limited by Seal
4 Bolt Flange (ISO 6164)		Excellent	Excellent	Good	Good	Good	Good	Excellent	Limited by Seal

**Table S8 — Application of Common Port Ends**

Table S9 on the following page shows a summary of tube connections

**S**

# Tube End Summary .....

**A**

**TABLE OF CONTENTS**

**SECTION TABLE OF CONTENTS**







Tube/Hose End Type	Illustration	Pressure — Dynamic	Pressure — Static	Seal Reliability	Vibration Resistance (in Rigid Systems)	Ease of Installation	Ease of Maintenance	Reusability	Temperature
Seal-Lok O-Ring Face Seal		Excellent	Excellent	Excellent	Very Good	Excellent	Excellent	Excellent	Limited by Seal
Triple-Lok 37° Flare		Very Good	Very Good	Good	Good	Good	Very Good	Good	Excellent
Ferulok Inch Bite Type		Very Good	Very Good	Very Good	Very Good	Good	Good	Very Good	Excellent
EO Metric Bite Type		Excellent	Excellent	Very Good	Very Good	Good	Good	Very Good	Excellent
EO-2 Soft Seal Metric Bite Type		Excellent	Excellent	Excellent	Very Good	Very Good	Good	Excellent	Limited by Seal
JIS 30° Flare		Good	Good	Very Good	Not Applicable	Very Good	Very Good	Very Good	Limited by Seal
JIS 60° Cone B8363		Good	Good	Very Good	Not Applicable	Very Good	Very Good	Very Good	Limited by Seal
Komatsu 30° Flare		Good	Good	Very Good	Not Applicable	Very Good	Very Good	Very Good	Limited by Seal
K4 BSP Adapters		Good	Good	Very Good	Not Applicable	Very Good	Very Good	Very Good	Limited by Seal
NPSM (Swivel)		Good	Good	Very Good	Not Applicable	Good	Good	Very Good	Very Good

Table S9 — Application of Common Tube Ends

# STEP 4: MEDIA OR MATERIAL

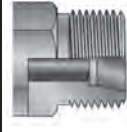
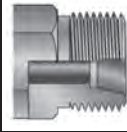
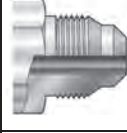
In addition to temperature, proper selection of tube, fitting and adapter material will also depend on the system media and corrosive nature of the service environment. Table S10 can be used to select the proper fitting and seal material based on system media type.

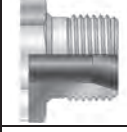
This table is intended as a guide only and is not to be considered as a sole selection criteria when choosing Parker Tube Fittings and adapters for a specific application or with a specific fluid.

Media	Fitting Material			Seal Material			
	Brass	Steel	316 SS	BUNA-N	Ethylene Propylene	Fluorocarbon	Neoprene
Acetylene	NR	F	S	S	S	S	F
Air (oil free) @ 190°F	S	F	S	S	S	S	S
Air (oil free) @ 300°F	S	F	S	F	F	S	F
Air (oil free) @ 400°F	S	F	S	NR	NR	S	NR
Alcohol, Ethyl	S	NR	NR	NR	S	NR	S
Animal Oils (Lard Oil)	F	F	F	S	F	S	F
Aromatic Fuel - 50%	ID	ID	ID	F	NR	S	NR
Aromatic Solvents	ID	ID	F	F	ID	S	NR
Asphalt	NR	NR	S	F	NR	S	F
ASTM Oil #1	S	S	S	S	NR	S	S
ASTM Oil #2	S	S	S	S	NR	S	F
ASTM Oil #3	S	S	S	S	NR	S	NR
ASTM Oil #4	S	S	S	F	NR	S	NR
ATF Oil	S	S	S	S	NR	S	F
Automotive Brake Fluid	ID	ID	ID	NR	S	NR	F
Benzene	NR	F	NR	NR	NR	S	NR
Brine (Sodium Chloride)	NR	NR	S	S	S	S	S
Butane	NR	S	S	S	NR	S	S
Carbon Dioxide	S	F	S	S	S	S	S
Carbon Monoxide	S	S	S	S	S	S	F
Chlorine (Dry)	F	F	NR	NR	ID	F	F
Compressed Air	S	F	S	S	S	S	S
Crude Oil	NR	F	S	F	NR	S	NR
Cutting Oil	ID	S	S	S	NR	S	F
Diesel Fuel	S	S	S	S	NR	S	NR
Ethanol	S	NR	S	NR	S	NR	S
Ethers	S	S	S	NR	F	F	NR
Freon 11	S	ID	ID	F	NR	F	NR
Freon 12	S	S	NR	F	NR	S	S
Freon 22	S	NR	S	NR	NR	NR	S
Fuel Oil	NR	S	S	S	NR	S	F
Gasoline	S	F	S	S	NR	S	NR
Gas, Liquid Propane (LPG)	S	S	S	S	NR	S	F
Gas, Natural	F	S	S	S	NR	S	S
Helium	S	S	S	S	S	S	S
Hydraulic Oil, Petroleum Base	S	S	S	S	NR	S	S
Hydraulic Oil, Water Base	ID	S	S	F	S	NR	F
Hydrogen Gas	S	S	S	S	S	S	S
Jet Fuel	S	S	S	S	NR	S	NR
Kerosene	S	S	S	S	NR	S	F
Lubricating Oil SAE 10, 20, 30, 40, 50	S	S	S	S	NR	S	F
Methanol	S	S	S	S	S	NR	S
MIL-F-8192 (JP-9)	S	S	S	NR	NR	S	NR
MIL-H-5606	S	S	S	S	NR	S	F
MIL-H-6083	S	S	S	S	NR	S	S
MIL-H-7083	S	S	S	S	S	F	F
MIL-H-8446 (MLO-8515)	F	S	S	F	NR	S	S
Mil-L-2104 & 2104B	S	S	S	S	NRX	S	F

Table S10 — Fitting, Seal Material and Media Compatibility (Cont'd)

Codes: S = Satisfactory F = Fair NR = Not recommended ID = Insufficient Data





TABLE OF CONTENTS

SECTION TABLE OF CONTENTS

Media	Fitting Material			Seal Material			
	Brass	Steel	316 SS	BUNA-N	Ethylene Propylene	Fluorocarbon	Neoprene
MIL-L-7808	NR	F	S	S	NR	S	NR
Mineral Oil	S	S	S	F	NR	S	F
Nitrogen	S	S	S	F	S	S	S
Petrolatum	S	S	S	S	NR	S	F
Petroleum Oil (<250°F)	S	S	S	S	NR	S	F
Propane	S	S	S	S	NR	S	F
R134A	S	S	S	NR	S	NR	NR
Sea Water	F	NR	S	S	S	S	F
Skydrol 500, Type 2	NR	S	S	NR	S	NR	NR
Skydrol 7000, Type 2	NR	S	S	NR	S	F	NR
Soap Solutions	NR	NR	S	S	S	S	F
Steam (<400°F)	F	S	S	NR	S	NR	NR
Stoddard Solvent	F	S	S	S	NR	S	F
Transmission Fluid (Type A)	S	S	S	S	NR	S	F
Trichloroethane	ID	F	S	NR	NR	S	NR
Water	S	F	S	S	S	F	F

**Table S10 — Fitting, Seal Material and Media Compatibility (Cont'd)**

Codes: S = Satisfactory F = Fair NR = Not recommended ID = Insufficient Data

In addition to being compatible with the media, tube fittings and adapters must also be compatible with tube material and type. Table S11 lists several common tube types with their recommended operating temperature ranges, general application, and fitting and adapter compatibility. Based on the fluid system parameters and media, select the appropriate tube fitting or adapter type and material. As a general rule, tube and fitting materials should be the same. Since operating conditions differ with applications, different material combinations in this table should be used only as a guide and not a firm recommendation. Before making a final decision on material combination, it should be sufficiently tested under appropriate conditions to assure suitability for the intended application.



TABLE OF CONTENTS

SECTION TABLE OF CONTENTS

Tube Material	Specification	Construction	Condition	Max. Hardness	Temperature Range (7)	Application	Tube Material to Fitting & Material Compatibility											
							Seal-Lok ORFS (SAE J1453)			Triple-Lok 37°Flare (SAE J514)				Ferulok Flareless (SAE J514)			EO/EO-2 Flareless (ISO 8434-1)	
							S	SS	B	S	SS	B	M	S	SS	M	S, SS, B	
Carbon Steel C-1010	SAE J524 (ASTM A179) (8)	Seamless	Fully Annealed	HRB 72	-65° to 500°F -55° to 260°C	High pressure hydraulic, air, & some specialty chemicals	E	NR	(6)	G	NR	(6)	NR	E	NR	NR	NR	
	SAE J525 (ASTM A178) (8)	Welded & Drawn					E	NR	(6)	E	NR	(6)	NR	E	NR	NR	NR	
	SAE J356	Welded & Flash Controlled					G	NR	(6)	NR	NR	(6)	NR	G	NR	NR	NR	
Carbon Steel C-1021	SAE J2435	Welded & Flash Controlled	Fully Annealed	HRB 75	-65° to 500°F -55° to 260°C	High pressure hydraulic	E	NR	(6)	NR	NR	(6)	NR	E	NR	NR	NR	
	SAE J2467	Welded & Drawn					E	NR	(6)	E	NR	(6)	NR	E	NR	NR	NR	
Carbon Steel High Strength Low Alloy (HSLA)	SAE 2613	Welded & Flash Controlled	Sub-critically annealed	HRB 90	-65° to 500°F -55° to 260°C	High pressure hydraulic	E (10)	NR	(6)	NR	NR	(6)	NR	NR	NR	NR	NR	
	SAE J2614	Welded & Drawn					E	NR	(6)	NR	NR	(6)	NR	NR	NR	NR	NR	
Alloy Steel 4130	ASTM A519	Seamless			-65° to 500°F -55° to 260°C	High pressure hydraulics	E (4)	NR	NR	NR	NR	NR	NR	NR	NR	NR	NR	
St 37.4 (Carbon Steel)	DIN 2391 Part 2 (Metric)	Seamless	Fully Annealed	HRB 72	-65° to 500°F -55° to 260°C	High pressure hydraulic, air, & some specialty chemicals	E	NR	NR	G	NR	NR	NR	NR	NR	NR	E	
Stainless Steel 304 & 316	ASTM A213 ASTM A269	Seamless	Fully Annealed	HRB 90	-425° to 1200° -255° to 650°C (3)	High pressure, high temperature, or generally corrosive media (1)	(6)	E	(6)	(6)	G	(6)	NR	(6)	E	NR	E	
	ASTM A249 ASTM A269	Welded & Drawn					(6)	E	(6)	(6)	E	(6)	NR	(6)	E	NR	E	
1.4571 1.4541 Stainless Steel	DIN 17458 Tab 8 (Metric)	Seamless	Fully Annealed	HRB 90	-425° to 1200° -255° to 650°C (3)	High pressure, high temperature, or generally corrosive media (1)	(6)	E	NR	(6)	G	NR	NR	E	NR	E		
Copper	SAE J528 (ASTM B75) (8)	Seamless	Soft Annealed Temper 0	60 Max. Rockwell 15T	-325° to 400°F -200° to 205°C	Low pressure, low temperature, water, oil & air	E	(6)	E	G	(6)	E	NR	G (2)	NR	NR	E	
Aluminum 6061	ASTM B210	Seamless	T6 Temper	HRB 56	-325° to 400°F -200° to 205°C	Low pressure, low temperature, water, oil, air & some specialty chemicals	NR	NR	NR	G	NR	NR	NR	E (2)	NR	NR	NR	
			0 & T4 Temper	HRB 30			E (5)	NR	NR	G	NR	NR	NR	E (2)	NR	NR	NR	
Monel 400	ASTM B165	Seamless	Fully Annealed	HRB 70	-400° to 800°F -240° to 425°C	Sour gas, marine & general chemical processing media	NR	(6)	NR	NR	(6)	NR	E	NR	(6)	E	NR	
Nylon		Extruded	Flexible & Semi-Rigid		-60° to 200°F -50° to 95°C	Lube lines, chemical process controls & air	NR	NR	NR	NR	NR	NR	G (2)	G (2)	G (2)	G (2), (9)		
Polyethylene	ASTM D1248	Extruded	Instrument Grade		-80° to 150°F -60° to 65°C	Instrumentation lines	NR	NR	NR	NR	NR	NR	G (2)	G (2)	G (2)	G (2), (9)		
PVC		Extruded	Instrument & Laboratory Grade		0° to 140°F -20° to 60°C	General purpose laboratory use	NR	NR	NR	NR	NR	NR	NR	NR	NR	NR		
PTFE		Extruded & Cinkered			-65° to 400°F -55° to 205°C	Very low pressure, high temperature, fuel, lube, chemical & air applications	NR	NR	NR	NR	NR	NR	G (2)	G (2)	G (2)	G (2), (9)		

Table S11 — Tube and Fitting Material Compatibility

Notes:

- 1) For highly corrosive media or service environment, contact the Tube Fittings Division.
- 2) Requires different assembly procedure. Contact the Tube Fittings Division.
- 3) Low temperature limit for stainless steel Ferulok fittings is -20°F (-30°C).
- 4) For brazing only. Grade 4130 not recommended with Parflange process.
- 5) For use with Parflange process only. Not recommended with brazing.
- 6) Use depends on specific application. Contact the Tube Fittings Division.
- 7) Applies to tube material.
- 8) Comparable specifications to SAE.
- 9) With metric version of tubing.
- 10) Not tested with Parflange. Contact the Tube Fittings Division.

Ratings Key:

- NR Not Recommended
- F Fair
- G Good
- E Excellent

Fitting Materials Code:

- S Steel
- SS Stainless Steel
- B Brass
- M Monel

S

If elastomer seals are used in a tube fitting or adapter, the seals must be compatible with the media and environment as well. Table S12 lists compatible seal material based on media type.



Recommended for	Temperature Range	Not Recommended For	Polymer	Abbreviated Name	Parker Compound	No. Color	SAE J515 Type	Shore Hardness
Acids	-15° to 400°F	Ketones, skydrol fluids, amines (VDMH), anhydrous ammonia, low molecular weight esters and ethers, hot hydrofluoric or chlorosulfuric acids	Fluorocarbon	FKM <sup>(5)</sup> or FPM	V0747	Black	—	75
Acids	-15° to 400°F	Ketones, skydrol fluids, amines (VDMH), anhydrous ammonia, low molecular weight esters and ethers, hot hydrofluoric or chlorosulfuric acids	Fluorocarbon	FKM <sup>(5)</sup> or FPM	V0884	Brown <sup>(1)</sup>	—	75
Acids	-15° to 400°F	Ketones, skydrol fluids, amines (VDMH), anhydrous ammonia, low molecular weight esters and ethers, hot hydrofluoric or chlorosulfuric acids	Fluorocarbon	FKM <sup>(5)</sup> or FPM	V0894	Brown <sup>(1,5)</sup>	HK <sup>(4)</sup>	90 <sup>(6)</sup>
Air	-30° to 250°	Phosphate ester base hydraulic fluids, automotive brake fluids, strong acids, ozone, freons, ketones, halogenerated hydrocarbons and methonal	Nitrile-Butadiene	NBR	N0674	Black	—	70
Air	-30° to 250°F	Phosphate ester base hydraulic fluids, automotive brake fluids, strong acids, ozone, freons, ketones, halogenerated hydrocarbons and methonal	Nitrile-Butadiene	NBR	N0552	Black	CH <sup>(2)</sup>	90 <sup>(6)</sup>
Air	-30° to 275°F	Phosphate ester base hydraulic fluids, automotive brake fluids, strong acids, ozone, freons, ketones, halogenerated hydrocarbons and methonal	Nitrile-Butadiene	NBR	N1059	Black	CH <sup>(2)</sup>	90
Air	-65° to 225°	Phosphate ester base hydraulic fluids, automotive brake fluids, strong acids, ozone, freons, ketones, halogenerated hydrocarbons and methonal	Nitrile-Butadiene	NBR	N0103	Black	—	70
Alcohols	-65° to 225°F	Petroleum based oils and di-ester base lubricants	Ethylene-Propylene	EPDM	E0540	Black	CA <sup>(3)</sup>	80
Alcohols	-65° to 225°F	Petroleum based oils and di-ester base lubricants	Ethylene-Propylene	EPDM	E0893	Purple <sup>(1)</sup>	CA <sup>(3)</sup>	80
Automotive brake fluids	-65° to 225°F	Petroleum based oils and di-ester base lubricants	Ethylene-Propylene	EPDM	E0540	Black	CA <sup>(3)</sup>	80
Automotive brake fluids	-65° to 225°F	Petroleum based oils and di-ester base lubricants	Ethylene-Propylene	EPDM	E0893	Purple <sup>(1)</sup>	CA <sup>(3)</sup>	80
CO <sup>2</sup> Climate control systems	-65° to 225°F	Petroleum based oils and di-ester base lubricants	Ethylene-Propylene	EPDM	E0962	Black	—	90
CNG Applications	-58° to 300°F	Phosphate ester base hydraulic fluids, automotive brake fluids, strong acids, ozone, freons, ketones, halogenerated hydrocarbons and methonal	Nitrile-Butadiene	HNBR	KA183	Black	—	85
Di-ester base lubricants	-15° to 400°F	Ketones, skydrol fluids, amines (VDMH), anhydrous ammonia, low molecular weight esters and ethers, hot hydrofluoric or chlorosulfuric acids	Fluorocarbon	FKM <sup>(5)</sup> or FPM	V0747	Black	—	75
Di-ester base lubricants	-15° to 400°F	Ketones, skydrol fluids, amines (VDMH), anhydrous ammonia, low molecular weight esters and ethers, hot hydrofluoric or chlorosulfuric acids	Fluorocarbon	FKM <sup>(5)</sup> or FPM	V0884	Brown <sup>(1)</sup>	—	75
Di-ester base lubricants	-15° to 400°F	Ketones, skydrol fluids, amines (VDMH), anhydrous ammonia, low molecular weight esters and ethers, hot hydrofluoric or chlorosulfuric acids	Fluorocarbon	FKM <sup>(5)</sup> or FPM	V0894	Brown <sup>(1,5)</sup>	HK <sup>(4)</sup>	90 <sup>(6)</sup>
Dilute acids and alkalis	-65° to 275°F	Petroleum based oils and di-ester base lubricants	Ethylene-Propylene	EPDM	E0540	Black	CA <sup>(3)</sup>	80
Dilute acids and alkalis	-65° to 275°F	Petroleum based oils and di-ester base lubricants	Ethylene-Propylene	EPDM	E0893	Purple <sup>(1)</sup>	CA <sup>(3)</sup>	80
Dry heat (air to 400°F)	-65° to 450°F	Most petroleum fluids, ketones, water and steam	Silicone	Si	S0604	Rust <sup>(1)</sup>	—	70
Ethylene glycol base fluids	-30° to 250°	Phosphate ester base hydraulic fluids, automotive brake fluids, strong acids, ozone, freons, ketones, halogenerated hydrocarbons and methonal	Nitrile-Butadiene	NBR	N0674	Black	—	70

Table S12 – Seal and Media Compatibility (Cont'd)



TABLE OF CONTENTS

SECTION TABLE OF CONTENTS

Recommended for	Temperature Range	Not Recommended For	Polymer	Abbreviated Name	Parker Compound	No. Color	SAE J515 Type	Shore Hardness
Ethylene glycol base fluids	-30° to 250°F	Phosphate ester base hydraulic fluids, automotive brake fluids, strong acids, ozone, freons, ketones, halogenerated hydrocarbons and methonal	Nitrile-Butadiene	NBR	N0552	Black	CH <sup>2)</sup>	90 <sup>6)</sup>
Ethylene glycol base fluids	-30° to 275°F	Phosphate ester base hydraulic fluids, automotive brake fluids, strong acids, ozone, freons, ketones, halogenerated hydrocarbons and methonal	Nitrile-Butadiene	NBR	N1059	Black	CH <sup>2)</sup>	90
Ethylene glycol base fluids	-65° to 225°	Phosphate ester base hydraulic fluids, automotive brake fluids, strong acids, ozone, freons, ketones, halogenerated hydrocarbons and methonal	Nitrile-Butadiene	NBR	N0103	Black	—	70
Food product applications (meets FDA requirements)	-35° to 250°	Phosphate ester base hydraulic fluids, automotive brake fluids, strong acids, ozone, freons, ketones, halogenerated hydrocarbons and methonal	Nitrile-Butadiene	NBR	N0508	Black	—	75
Halogenated hydrocarbons	-15° to 400°F	Phosphate ester base hydraulic fluids, automotive brake fluids, strong acids, ozone, freons, ketones, halogenerated hydrocarbons and methonal	Fluorocarbon	FKM <sup>5)</sup> or FPM	V0747	Black	—	75
Halogenated hydrocarbons	-15° to 400°F	Ketones, skydrol fluids, amines (VDMH), anhydrous ammonia, low molecular weight esters and ethers, hot hydrofluoric or chlorosulfuric acids	Fluorocarbon	FKM <sup>5)</sup> or FPM	V0884	Brown <sup>1)</sup>	—	75
Halogenated hydrocarbons	-15° to 400°F	Ketones, skydrol fluids, amines (VDMH), anhydrous ammonia, low molecular weight esters and ethers, hot hydrofluoric or chlorosulfuric acids	Fluorocarbon	FKM <sup>5)</sup> or FPM	V0894	Brown <sup>1),5)</sup>	HK <sup>4)</sup>	90 <sup>6)</sup>
High aniline point oils	-65° to 450°F	Most petroleum fluids, ketones, water and steam	Silicone	Si	S0604	Rust <sup>1)</sup>	—	70
High aniline point petroleum oils	-45° to 250°F	Phosphate ester fluids and ketones	Neoprene	CR	C0873	Black	—	70
High aniline point petroleum oils	-45° to 250°F	Phosphate ester fluids and ketones	Neoprene	CR	C0944	Red <sup>1)</sup>	—	70
Hot water	-65° to 275°F	Petroleum based oils and di-ester base lubricants	Ethylene-Propylene	EPDM	E0540	Black	CA <sup>3)</sup>	80
Hot water	-65° to 275°F	Petroleum based oils and di-ester base lubricants	Ethylene-Propylene	EPDM	E0893	Purple <sup>1)</sup>	CA <sup>3)</sup>	80
Hydrogen Fuel Cells	-65° to 180°F	Phosphate ester base hydraulic fluids, automotive brake fluids, strong acids, ozone, freons, ketones, halogenerated hydrocarbons and methonal	Nitrile-Butadiene	NBR	N0507	Black	—	90
Hydrogen Fuel Cells	-65° to 225°F	Phosphate ester base hydraulic fluids, automotive brake fluids, strong acids, ozone, freons, ketones, halogenerated hydrocarbons and methonal	Nitrile-Butadiene	NBR	N0304	Black	—	75
Ketones	-65° to 275°F	Petroleum based oils and di-ester base lubricants	Ethylene-Propylene	EPDM	E0540	Black	CA <sup>3)</sup>	80
Ketones	-65° to 275°F	Petroleum based oils and di-ester base lubricants	Ethylene-Propylene	EPDM	E0893	Purple <sup>1)</sup>	CA <sup>3)</sup>	80
Mild Acids	-45° to 250°F	Phosphate ester fluids and ketones	Neoprene	CR	C0873	Black	—	70
Mild Acids	-45° to 250°F	Phosphate ester fluids and ketones	Neoprene	CR	C0944	Red <sup>1)</sup>	—	70
Mineral Oils	-30° to 250°	Phosphate ester base hydraulic fluids, automotive brake fluids, strong acids, ozone, freons, ketones, halogenerated hydrocarbons and methonal	Nitrile-Butadiene	NBR	N0674	Black	—	70
Mineral Oils	-30° to 250°F	Phosphate ester base hydraulic fluids, automotive brake fluids, strong acids, ozone, freons, ketones, halogenerated hydrocarbons and methonal	Nitrile-Butadiene	NBR	N0552	Black	CH <sup>2)</sup>	90 <sup>6)</sup>
Mineral Oils	-30° to 275°F	Phosphate ester base hydraulic fluids, automotive brake fluids, strong acids, ozone, freons, ketones, halogenerated hydrocarbons and methonal	Nitrile-Butadiene	NBR	N1059	Black	CH <sup>2)</sup>	90
Mineral Oils	-65° to 225°	Phosphate ester base hydraulic fluids, automotive brake fluids, strong acids, ozone, freons, ketones, halogenerated hydrocarbons and methonal	Nitrile-Butadiene	NBR	N0103	Black	—	70
Natural Gas	-30° to 250°	Phosphate ester base hydraulic fluids, automotive brake fluids, strong acids, ozone, freons, ketones, halogenerated hydrocarbons and methonal	Nitrile-Butadiene	NBR	N0674	Black	—	70
Natural Gas	-30° to 250°F	Phosphate ester base hydraulic fluids, automotive brake fluids, strong acids, ozone, freons, ketones, halogenerated hydrocarbons and methonal	Nitrile-Butadiene	NBR	N0552	Black	CH <sup>2)</sup>	90 <sup>6)</sup>

Table S12 – Seal and Media Compatibility (Cont'd)

S



TABLE OF CONTENTS

SECTION TABLE OF CONTENTS

Recommended for	Temperature Range	Not Recommended For	Polymer	Abbreviated Name	Parker Compound	No. Color	SAE J515 Type	Shore Hardness
Natural Gas	-30° to 275°F	Phosphate ester base hydraulic fluids, automotive brake fluids, strong acids, ozone, freons, ketones, halogenated hydrocarbons and methanol	Nitrile-Butadiene	NBR	N1059	Black	CH <sup>2)</sup>	90
Natural Gas	-65° to 225°	Phosphate ester base hydraulic fluids, automotive brake fluids, strong acids, ozone, freons, ketones, halogenated hydrocarbons and methanol	Nitrile-Butadiene	NBR	N0103	Black	—	70
Petroleum based oils and fluids	-30° to 250°	Phosphate ester base hydraulic fluids, automotive brake fluids, strong acids, ozone, freons, ketones, halogenated hydrocarbons and methanol	Nitrile-Butadiene	NBR	N0674	Black	—	70
Petroleum based oils and fluids	-15° to 400°F	Ketones, skydrol fluids, amines (VDMH), anhydrous ammonia, low molecular weight esters and ethers, hot hydrofluoric or chlorosulfuric acids	Fluorocarbon	FKM <sup>5)</sup> or FPM	V0747	Black	—	75
Petroleum based oils and fluids	-15° to 400°F	Ketones, skydrol fluids, amines (VDMH), anhydrous ammonia, low molecular weight esters and ethers, hot hydrofluoric or chlorosulfuric acids	Fluorocarbon	FKM <sup>5)</sup> or FPM	V0884	Brown <sup>1)</sup>	—	75
Petroleum based oils and fluids	-15° to 400°F	Ketones, skydrol fluids, amines (VDMH), anhydrous ammonia, low molecular weight esters and ethers, hot hydrofluoric or chlorosulfuric acids	Fluorocarbon	FKM <sup>5)</sup> or FPM	V0894	Brown <sup>1),5)</sup>	HK <sup>4)</sup>	90 <sup>6)</sup>
Petroleum based oils and fluids	-30° to 250°F	Phosphate ester base hydraulic fluids, automotive brake fluids, strong acids, ozone, freons, ketones, halogenated hydrocarbons and methanol	Nitrile-Butadiene	NBR	N0552	Black	CH <sup>2)</sup>	90 <sup>6)</sup>
Petroleum based oils and fluids	-30° to 275°F	Phosphate ester base hydraulic fluids, automotive brake fluids, strong acids, ozone, freons, ketones, halogenated hydrocarbons and methanol	Nitrile-Butadiene	NBR	N1059	Black	CH <sup>2)</sup>	90
Petroleum based oils and fluids	-65° to 225°	Phosphate ester base hydraulic fluids, automotive brake fluids, strong acids, ozone, freons, ketones, halogenated hydrocarbons and methanol	Nitrile-Butadiene	NBR	N0103	Black	—	70
Phosphate ester base hydraulic fluids	-65° to 275°F	Petroleum based oils and di-ester base lubricants	Ethylene-Propylene	EPDM	E0540	Black	CA <sup>3)</sup>	80
Phosphate ester base hydraulic fluids	-65° to 275°F	Petroleum based oils and di-ester base lubricants	Ethylene-Propylene	EPDM	E0893	Purple <sup>1)</sup>	CA <sup>3)</sup>	80
Phosphate ester base hydraulic fluids (some)	-15° to 400°F	Ketones, skydrol fluids, amines (VDMH), anhydrous ammonia, low molecular weight esters and ethers, hot hydrofluoric or chlorosulfuric acids	Fluorocarbon	FKM <sup>5)</sup> or FPM	V0747	Black	—	75
Phosphate ester base hydraulic fluids (some)	-15° to 400°F	Ketones, skydrol fluids, amines (VDMH), anhydrous ammonia, low molecular weight esters and ethers, hot hydrofluoric or chlorosulfuric acids	Fluorocarbon	FKM <sup>5)</sup> or FPM	V0884	Brown <sup>1)</sup>	—	75
Phosphate ester base hydraulic fluids (some)	-15° to 400°F	Ketones, skydrol fluids, amines (VDMH), anhydrous ammonia, low molecular weight esters and ethers, hot hydrofluoric or chlorosulfuric acids	Fluorocarbon	FKM <sup>5)</sup> or FPM	V0894	Brown <sup>1),5)</sup>	HK <sup>4)</sup>	90 <sup>6)</sup>
Refrigerants (freons, ammonia)	-45° to 250°F	Phosphate ester fluids and ketones	Neoprene	CR	C0873	Black	—	70
Refrigerants (freons, ammonia)	-45° to 250°F	Phosphate ester fluids and ketones	Neoprene	CR	C0944	Red <sup>1)</sup>	—	70
Silicate ester lubricants	-45° to 250°F	Phosphate ester fluids and ketones	Neoprene	CR	C0873	Black	—	70
Silicate ester lubricants	-45° to 250°F	Phosphate ester fluids and ketones	Neoprene	CR	C0944	Red <sup>1)</sup>	—	70
Silicone and di-ester base lubricants	-30° to 250°	Phosphate ester base hydraulic fluids, automotive brake fluids, strong acids, ozone, freons, ketones, halogenated hydrocarbons and methanol	Nitrile-Butadiene	NBR	N0674	Black	—	70
Silicone and di-ester base lubricants	-30° to 250°F	Phosphate ester base hydraulic fluids, automotive brake fluids, strong acids, ozone, freons, ketones, halogenated hydrocarbons and methanol	Nitrile-Butadiene	NBR	N0552	Black	CH <sup>2)</sup>	90 <sup>6)</sup>
Silicone and di-ester base lubricants	-30° to 275°F	Phosphate ester base hydraulic fluids, automotive brake fluids, strong acids, ozone, freons, ketones, halogenated hydrocarbons and methanol	Nitrile-Butadiene	NBR	N1059	Black	CH <sup>2)</sup>	90
Silicone and di-ester base lubricants	-65° to 225°	Phosphate ester base hydraulic fluids, automotive brake fluids, strong acids, ozone, freons, ketones, halogenated hydrocarbons and methanol	Nitrile-Butadiene	NBR	N0103	Black	—	70

Table S12 – Seal and Media Compatibility (Cont'd)





TABLE OF CONTENTS

SECTION TABLE OF CONTENTS

Recommended for	Temperature Range	Not Recommended For	Polymer	Abbreviated Name	Parker Compound	No. Color	SAE J515 Type	Shore Hardness
Silicone and silicate ester based lubricants	-15° to 400°F	Ketones, skydrol fluids, amines (VDMH), anhydrous ammonia, low molecular weight esters and ethers, hot hydrofluoric or chlorosulfuric acids	Fluorocarbon	FKM <sup>5)</sup> or FPM	V0747	Black	—	75
Silicone and silicate ester based lubricants	-15° to 400°F	Ketones, skydrol fluids, amines (VDMH), anhydrous ammonia, low molecular weight esters and ethers, hot hydrofluoric or chlorosulfuric acids	Fluorocarbon	FKM <sup>5)</sup> or FPM	V0884	Brown <sup>1)</sup>	—	75
Silicone and silicate ester based lubricants	-15° to 400°F	Ketones, skydrol fluids, amines (VDMH), anhydrous ammonia, low molecular weight esters and ethers, hot hydrofluoric or chlorosulfuric acids	Fluorocarbon	FKM <sup>5)</sup> or FPM	V0894	Brown <sup>1),5)</sup>	HK <sup>4)</sup>	90 <sup>6)</sup>
Silicone oils and greases	-65° to 275°F	Petroleum based oils and di-ester base lubricants	Ethylene-Propylene	EPDM	E0540	Black	CA <sup>3)</sup>	80
Silicone oils and greases	-65° to 275°F	Petroleum based oils and di-ester base lubricants	Ethylene-Propylene	EPDM	E0893	Purple <sup>1)</sup>	CA <sup>3)</sup>	80
Steam to 400°F	-65° to 275°F	Petroleum based oils and di-ester base lubricants	Ethylene-Propylene	EPDM	E0540	Black	CA <sup>3)</sup>	80
Steam to 400°F	-65° to 275°F	Petroleum based oils and di-ester base lubricants	Ethylene-Propylene	EPDM	E0893	Purple <sup>1)</sup>	CA <sup>3)</sup>	80
Water under 150°F	-30° to 250°	Phosphate ester base hydraulic fluids, automotive brake fluids, strong acids, ozone, freons, ketones, halogenated hydrocarbons and methanol	Nitrile-Butadiene	NBR	N0674	Black	—	70
Water under 150°F	-30° to 250°F	Phosphate ester base hydraulic fluids, automotive brake fluids, strong acids, ozone, freons, ketones, halogenated hydrocarbons and methanol	Nitrile-Butadiene	NBR	N0552	Black	CH <sup>2)</sup>	90 <sup>6)</sup>
Water under 150°F	-30° to 275°F	Phosphate ester base hydraulic fluids, automotive brake fluids, strong acids, ozone, freons, ketones, halogenated hydrocarbons and methanol	Nitrile-Butadiene	NBR	N1059	Black	CH <sup>2)</sup>	90
Water under 150°F	-65° to 225°	Phosphate ester base hydraulic fluids, automotive brake fluids, strong acids, ozone, freons, ketones, halogenated hydrocarbons and methanol	Nitrile-Butadiene	NBR	N0103	Black	—	70

**Table S12 – Seal and Media Compatibility**

- 1) These Parker “Chromasure” color assurance O-Rings are available from the Parker Hannifin O-Ring Division. They help eliminate assembly errors, reduce warranty costs and liability risks, and assure safety in aftermarket business.
- 2) Formerly SAE Type I.
- 3) Formerly SAE Type II.
- 4) Formerly SAE Type III.
- 5) “FKM” is the ASTM designation for fluorocarbon. Its ISO designation is “FPM”. For “DIN” Fittings, color is green.
- 6) Standard compounds available from stock.
- 7) Use 90 durometer hard O-Rings for applications with 1500 psi or higher pressures.

**Caution: When working with highly corrosive media, always consult the Tube Fittings Division**

### Other material considerations:

Protective coatings such as electroplated zinc and zinc phosphate are usually applied to steel fittings for extending their useful service life in corrosive environments. Zinc corrodes sacrificially, protecting the steel substrate from normal atmospheric rusting due to the common presence of oxygen, moisture and acidic gases. They are, however, rapidly attacked by many fluids including those containing acidic hydrogen and reactive fluorine, chlorine, bromine, iodine, and nitrogen. Zinc plating will further be attacked by strong bases or water with pH > 12. Zinc reacts with glycol-based fire-resistant fluids and forms a gelatinous compound that can plug up filters and be harmful otherwise, in a system with many zinc plated tube and hose fittings. Stainless-steel fittings, along with brass fittings in low pressure applications, are viable options.

The other option is to run the fluid through the system, without components with moving parts in it, with an auxiliary power source, to generate and flush the gelatinous

compound. Then re-connect all components, change filters and charge the system with new fluid.

Zinc-Nickel plating offers enhanced performance over Chromium-6 Free zinc plating. Parker XTR plating increases protection in salt spray (ASTM B117) testing and in fertilizer (urea) applications.

**Caution:** Where low toxicity and low corrosion are required, as in food or beverage applications, steel coated with any form of zinc or other protective coatings is not recommended.

Tube and tube fitting and adapter materials should be similar when possible. If different materials must be used, galvanic corrosion prevention needs to be considered. The susceptibility of different base metals to corrosion while in contact, depends upon the difference between the contact potentials, or the electromotive voltages of the metals involved.

S

The electromotive potential of common metals is listed in table S13. The greater the potential difference is, the greater is the tendency for corrosion. The metal with the higher potential forms the anode and is corroded. In other words, the larger the separation distance in the electromotive chart between the two metals in contact, the higher the contact potential and chances for corrosion. For example, zinc and aluminum are very short distance apart in the chart. Therefore, potential for corrosion when these two metals are in contact is very low. On the other hand, aluminum and passivated 316 stainless steel are far apart; hence, when in contact, the potential for corrosion is very high. Aluminum, being more anodic metal, will corrode in this combination.

..... M

As a general guideline, if the metals are half the length of the chart or more apart, the combination should be avoided. Also, it is not a good idea to combine an anodic metal part with thin cross section, such as thin wall tubing, with a cathodic or less anodic metal part of a heavy cross section, such as a fitting. For example, a thin wall brass tube with steel fitting is a better, although not ideal, combination than a thin wall steel tube with brass fitting.

**TABLE OF CONTENTS**

**SECTION TABLE OF CONTENTS**

Electromotive or Galvanic Series for Metals	
	Magnesium
	Magnesium Alloys
+ Anodic (least noble) corroded	Zinc (Parker steel fittings are zinc plated)
	Zinc-Nickel (Parker XTR Plating)
	Beryllium
	Aluminum 5052, 3004, 3003, 1100, 6053
	Cadmium
	Aluminum 2117, 2017, 2024 T4
	Mild steel (1018), wrought iron, free machining steel (12L14)
	Low alloy high strength steel, cast iron
	Chrome iron (active)
	430 Stainless (active)
	302, 303, 321, 347, 410, 416, stainless steel (active)
	Ni-resist
	316, 317 stainless steel (active)
	Carpenter 20Cb-3 stainless (active)
	Aluminum bronze (CA 687)
	Hastelloy C (active) Inconel 625 (active) Titanium (active)
	Lead/Tin solder
	Lead
	Tin
	Inconel 600 (active)
	Nickel (active)
	60 Ni-15 Cr (active)
	80 Ni-20 Cr (active)
	Hastelloy B (active)
	Naval brass (CA 464), Yellow brass (CA 268), Brass (CA360)
	Red brass (CA 230), Admiralty brass (CA 443)
	Copper (CA 102)
	Manganese bronze (CA 675), Tin bronze (CA 903, 905)
	410, 416 Stainless (passive) Phosphor bronze (CA 521, 524)
	Silicon bronze (CA 651, 655)
	Nickel silver (CA 732, 735, 745, 752, 754, 757, 764, 770, 794)
	Cupro Ni 90-10
	Cupro Ni 80-20
	430 Stainless steel (passive)
	Cupro Ni 70-30
	Nickel aluminum bronze (CA 630, 632)
	Monel 400, K500
	Silver solder
	Nickel (passive)
	60 Ni 15 Cr (passive)
	Inconel 600 (passive)
	80 Ni 20 Cr (passive)
	Chrome iron (passive)
	302, 303, 304, 321, 347 stainless steel (passive)
	316, 317 stainless steel (passive) (Parker stainless steel fittings are passivated)
	Carpenter 20 Cb-3 stainless (passive), Incoloy 825
	Silver
	Titanium (passive), Hastelloy C & C276 (passive), Inconel 625 (passive)
- Cathodic (most noble) protected	Graphitic
	Zirconium
	Gold
	Platinum

Table S13 — Electromotive or Galvanic Series for Metals

# STEP 5: PRESSURE

Finally, any selected tube fitting or adapter and tubing should have a pressure rating satisfying the system requirement. Pressure ratings shown on the product pages of Tube Fittings catalog are for dynamic systems with normal severity of service (see Table S6) at standard temperature range. A vast majority of systems where our tube fittings and adapters are used fall in this category. However, there are applications, such as hydraulic jacks, where the system pressure is essentially static once it is pressurized. For this type of an application the tube fittings and adapters can be used at higher pressures. On the other hand, there are applications where temperature is elevated, or service is severe or even hazardous. The pressure ratings in the catalog shall be de-rated accordingly.

### Dynamic and static systems can be defined as follows:

**Dynamic:** A system in which the operating pressure fluctuates, in accordance with load, up to a maximum pressure limited by the relief valve. In addition, the system may also experience shocks, vibration and temperature excursions.

**Example:** A backhoe.

**Static:** A system, once pressurized, is essentially free of pressure fluctuations, shock, vibration and temperature excursions, with such pressurizations not exceeding 30,000 times in the life of the system.

**Example:** A hydraulic jack.

Dynamic pressure ratings are based on a minimum design factor of 4. In other words, the fitting is capable of holding a pressure equal to 4 times the rated pressure before leakage or failure. For static applications, the design factor can be 3. So, the static rating can be determined by multiplying the dynamic rating by 1.33.

**Static pressure rating = 1.33 x Dynamic pressure rating**

**Example:** Static pressure rating for a fitting rated at 6000 psi  
= 1.33 x 6000 = 8000 psi

Selected tubes should have enough wall thickness and I.D. to satisfy pressure and flow requirements. Once I.D. and wall thickness are determined, O.D. can be calculated. Tube fitting size should match selected tube O.D. size. Some fittings can only work with limited wall thickness ranges. Therefore, selected fittings should be able to accept the selected tube wall thickness. Tables S14 and S15 shows the wall thickness range for common fittings.

Tube Material		Steel St. Steel Copper Aluminum	Steel St. Steel Monel	Steel Alloy Steel St. Steel Copper Monel	Copper Aluminum Plastics
Size		SAE 37° Flare Triple-Lok	SAE Flareless Ferulok	SAE O-Ring Face Seal Seal-Lok	Intru-Lok
O.D. (in.)	Dash #				
1/8	-2	.010 - .035	.010 - .035	—	.012 - .028
3/16	-3	.010 - .035	.020 - .049	—	.012 - .035
1/4	-4	.020 - .065	.028 - .065	.020 - .083	.020 - .049
5/16	-5	.020 - .065	.028 - .065	.020 - .095	.020 - .065
3/8	-6	.020 - .065	.035 - .095	.020 - .109	.028 - .065
1/2	-8	.028 - .083	.049 - .120	.028 - .148	.035 - .083
5/8	-10	.035 - .095	.058 - .120	.035 - .134	.035 - .083
3/4	-12	.035 - .109	.065 - .120	.035 - .148	.035 - .095
7/8	-14	.035 - .109	.072 - .120	.035 - .156	.049 - .095
1	-16	.035 - .120	.083 - .148	.035 - .188	.049 - .120
1 1/4	-20	.049 - .120	.095 - .188	.049 - .220	
1 1/2	-24	.049 - .120	.095 - .220	.049 - .250	
2	-32	.058 - .134	.095 - .220	.058 - .250	

- 1) Brazing to attach sleeve can be used for all wall thicknesses.
- 2) Thinner wall can be used for Ferulok with support of an insert.
- 3) Thicker wall can be used for Ferulok but pressure capability is limited by fittings.

**Table S14 – Recommended Inch Tube Wall Thickness Ranges for Common Fittings**

**Read more about Pressure Ratings in our article [The Truth About Pressure Ratings for Hydraulic Fittings and Adapters.](#)**

Tube O.D. (mm)	Recommended Wall Thickness (mm)								
	Seal-Lok			Triple-Lok			EO/EO2		
	Fitting Size	Min.	Max.	Fitting Size	Min.	Max.	Fitting Size	Min.	Max.
6	-4	0.5	2.25	-4	0.5	2.0	6LL, 6L, 6S	1.0	2.0
8	-6	1.0	2.5	-5	0.5	2.0	8LL, 8L, 8S	1.0	2.5
10	-6	1.0	3.0	-6	0.5	2.0	10LL, 10L, 10S	1.0	3.0
12	-8	1.0	3.5	-8	1.0	2.0	12LL, 12L, 12S	1.5	3.5
14	-10	1.0	4.0	-10	1.0	2.5	14S	1.5	4.0
15	-10	1.0	3.0	-10	1.0	2.5	15L	1.5	4.0
16	-10	1.0	3.0	-10	1.0	2.5	16S	2.0	4.0
18	-12	1.0	3.0	-12	1.0	3.0	18L	2.0	4.0
20	-12	1.5	4.0	-12	1.0	3.0	20S	2.5	4.0
22	-16	1.0	3.0	-14	1.0	3.0	22L	2.5	4.0
25	-16	2.0	5.0	-16	1.0	3.0	25S	2.5	4.5
28	-20	1.5	5.0	-20	1.5	3.0	28L	2.5	4.5
30	-20	2.0	5.0	-20	1.5	3.0	30S	3.0	5.0
32	-20	2.0	2.5	-20	1.5	3.0	-	-	-
35	-24	2.0	6.0	-24	1.5	3.0	35L	3.0	5.0
38	-24	2.5	7.0	-24	1.5	3.0	38S	3.5	6.0
42	-	-	-	-	-	-	42L	3.5	7.0
50	-	-	-	-32	1.5	3.5	-	-	-

- 1) Brazing to attach sleeve can be used for all wall thicknesses.
- 2) Thinner wall can be used for EO/EO2 with support of an insert.
- 3) Thicker wall can be used for EO/EO2 but pressure capability is limited by fittings.

**Table S15 – Recommended Metric Tube Wall Thickness Ranges for Common Fittings**

One final consideration in choosing the right wall thickness for tubing is bending. If the tube will be bent, and bending without the use of a mandrel is desired, then wall thickness of less than 7% of the tube O.D. should not be used.

Some parts are capable of performing at higher pressures than those shown on the product pages. For information on higher ratings, contact Tube Fittings Division.

## Additional Information

### Tubing Pressure Ratings

Use Tables S16 and S17 to determine the tube O.D. and wall thickness combination that satisfies the following two conditions:

- A. Has recommended design pressure equal to or higher than maximum operating pressure.
- B. Provides tube I.D. equal to or greater than required flow diameter determined earlier.

Design pressure values in Tables S16 and S17 are based on the severity of service rating “A” (design factor of 4) in Table S6, and temperature derating factor of 1 in Table S5. If more severe operating conditions are involved, the values in Tables S16 and S17 should be multiplied by appropriate derating factors from Tables S5 and S6 before determining the tube O.D. and wall thickness combination. Contact the Tube Fittings Division when in doubt.



# Inch Tube Pressure Ratings



TABLE OF CONTENTS

SECTION TABLE OF CONTENTS

Inch Tubes*							Inch Tubes*						
Tube O.D. (in.)	Wall Thick. (in.)	Tube I.D. (in.)	Design Pressure				Tube O.D. (in.)	Wall Thick. (in.)	Tube I.D. (in.)	Design Pressure			
			Steel C-1010	Steel C-1021	Stainless Steel 304 & 316, 4130 HSLA	Copper K or Y				Steel C-1010	Steel C-1021	Stainless Steel 304 & 316, 4130 HSLA	Copper K or Y
0.125	0.010	0.105	1,900	2,550	3,200	1,000	0.625	0.058	0.509	2,250	3,000	3,750	1,200
0.125	0.020	0.085	4,100	5,500	6,850	2,200	0.625	0.065	0.495	2,550	3,400	4,250	1,350
0.125	0.028	0.069	5,950	7,950	9,950	3,150	0.625	0.083	0.459	3,350	4,450	5,600	1,750
0.125	0.035	0.055	7,550	10,100	12,650	4,050	0.625	0.095	0.435	3,900	5,200	6,500	2,050
0.188	0.010	0.168	1,250	1,650	2,100	650	0.625	0.109	0.407	4,500	6,050	7,550	2,400
0.188	0.020	0.148	2,600	3,500	4,400	1,400	0.625	0.120	0.385	5,050	6,700	8,400	2,700
0.188	0.028	0.132	3,800	5,050	6,350	2,000	0.625	0.134	0.357	5,700	7,600	9,500	3,000
0.188	0.035	0.118	4,850	6,500	8,150	2,600	0.750	0.035	0.680	1,050	1,450	1,800	550
0.188	0.049	0.090	7,000	9,400	11,750	3,750	0.750	0.049	0.652	1,550	2,050	2,600	800
0.250	0.020	0.210	1,900	2,550	3,200	1,000	0.750	0.058	0.634	1,850	2,450	3,100	1,000
0.250	0.028	0.194	2,750	3,700	4,650	1,450	0.750	0.065	0.620	2,100	2,800	3,500	1,100
0.250	0.035	0.180	3,350	4,750	5,900	1,900	0.750	0.083	0.584	2,750	3,650	4,550	1,450
0.250	0.049	0.152	5,150	6,900	8,600	2,750	0.750	0.095	0.560	3,150	4,250	5,300	1,700
0.250	0.058	0.134	6,200	8,300	10,350	3,300	0.750	0.109	0.532	3,700	4,950	6,150	1,950
0.250	0.065	0.120	7,000	9,350	11,700	3,750	0.750	0.120	0.510	4,100	5,500	6,850	2,200
0.250	0.083	0.084	8,950	11,950	14,900	4,750	0.750	0.134	0.482	4,650	6,200	7,750	2,450
0.313	0.020	0.273	1,500	2,000	2,500	800	0.750	0.148	0.454	5,200	6,950	8,650	2,750
0.313	0.028	0.257	2,150	2,900	3,600	1,150	0.750	0.188	0.374	6,750	9,000	11,250	3,600
0.313	0.035	0.243	2,750	3,700	4,600	1,450	0.875	0.035	0.805	900	1,200	1,550	500
0.313	0.049	0.215	4,000	5,350	6,700	2,150	0.875	0.049	0.777	1,300	1,750	2,200	700
0.313	0.058	0.197	4,850	6,450	8,100	2,550	0.875	0.058	0.759	1,550	2,100	2,600	800
0.313	0.065	0.183	5,500	7,350	9,150	2,900	0.875	0.065	0.745	1,750	2,350	2,950	950
0.313	0.083	0.147	7,150	9,550	11,950	3,800	0.875	0.083	0.709	2,300	3,100	3,850	1,200
0.313	0.095	0.123	8,200	10,950	13,700	4,350	0.875	0.095	0.685	2,650	3,600	4,500	1,400
0.375	0.020	0.335	1,250	1,650	2,100	650	0.875	0.109	0.657	3,100	4,150	5,200	1,650
0.375	0.028	0.319	1,800	2,400	3,000	950	0.875	0.120	0.635	3,450	4,650	5,800	1,850
0.375	0.035	0.305	2,250	3,050	3,800	1,200	0.875	0.134	0.607	3,900	5,250	6,550	2,100
0.375	0.049	0.277	3,300	4,400	5,500	1,750	0.875	0.148	0.579	4,350	5,850	7,300	2,300
0.375	0.058	0.259	3,950	5,300	6,600	2,100	1.000	0.035	0.930	800	1,050	1,350	400
0.375	0.065	0.245	4,500	6,000	7,500	2,400	1.000	0.049	0.902	1,150	1,500	1,900	600
0.375	0.083	0.209	5,900	7,850	9,850	3,150	1.000	0.058	0.884	1,350	1,800	2,300	700
0.375	0.095	0.185	6,800	9,100	11,400	3,650	1.000	0.065	0.870	1,550	2,050	2,550	800
0.375	0.109	0.157	7,850	10,500	13,150	4,200	1.000	0.083	0.834	2,000	2,650	3,350	1,050
0.500	0.028	0.444	1,300	1,750	2,200	700	1.000	0.095	0.810	2,300	3,100	3,850	1,200
0.500	0.035	0.430	1,650	2,200	2,800	850	1.000	0.109	0.782	2,700	3,600	4,500	1,400
0.500	0.049	0.402	2,400	3,200	4,000	1,250	1.000	0.120	0.760	3,000	4,000	5,000	1,600
0.500	0.058	0.384	2,900	3,850	4,800	1,500	1.000	0.134	0.732	3,350	4,500	5,650	1,800
0.500	0.065	0.370	3,250	4,350	5,450	1,750	1.000	0.148	0.704	3,750	5,050	6,300	2,000
0.500	0.083	0.334	4,300	5,700	7,150	2,250	1.000	0.156	0.688	4,000	5,350	6,700	2,100
0.500	0.095	0.310	4,950	6,650	8,300	2,650	1.000	0.188	0.624	4,900	6,550	8,200	2,600
0.500	0.109	0.282	5,800	7,750	9,700	3,100	1.000	0.220	0.560	5,850	7,800	9,750	3,100
0.500	0.120	0.260	6,450	8,600	10,750	3,400	1.250	0.049	1.152	900	1,200	1,500	450
0.500	0.134	0.232	7,250	9,650	12,100	3,850	1.250	0.058	1.134	1,050	1,450	1,800	550
0.500	0.148	0.204	8,000	10,700	13,350	4,250	1.250	0.065	1.120	1,200	1,600	2,050	650
0.500	0.188	0.124	9,900	13,250	16,550	5,300	1.250	0.083	1.084	1,550	2,100	2,650	800
0.625	0.028	0.569	1,050	1,400	1,750	550	1.250	0.095	1.060	1,800	2,450	3,050	950
0.625	0.035	0.555	1,300	1,750	2,200	700	1.250	0.109	1.032	2,100	2,800	3,550	1,100
0.625	0.049	0.527	1,900	2,500	3,150	1,000	1.250	0.120	1.010	2,350	3,150	3,900	1,250

Table S16 — Inch Tube Pressure Ratings  
See Table S11 for tube specifications.





# Inch Tube Pressure Ratings (cont'd) .....



TABLE OF CONTENTS

SECTION TABLE OF CONTENTS

Inch Tubes*						
Tube O.D. (in.)	Wall Thick. (in.)	Tube I.D. (in.)	Design Pressure			
			Pressure C-1010	Steel C-1021	Stainless Steel 304 & 316, 4130 HSLA	Copper K or Y
1.250	0.134	0.982	2,650	3,550	4,400	1,400
1.250	0.148	0.954	2,950	3,950	4,900	1,550
1.250	0.156	0.938	3,100	4,150	5,200	1,650
1.250	0.188	0.874	3,850	5,100	6,400	2,050
1.250	0.220	0.810	4,550	6,100	7,650	2,450
1.500	0.065	1.370	1,000	1,350	1,650	500
1.500	0.083	1.334	1,300	1,750	2,150	700
1.500	0.095	1.310	1,500	2,000	2,500	800
1.500	0.109	1.282	1,750	2,300	2,900	900
1.500	0.120	1.260	1,900	2,550	3,200	1,000
1.500	0.134	1.232	2,150	2,900	3,600	1,150
1.500	0.148	1.204	2,400	3,200	4,050	1,250
1.500	0.156	1.188	2,550	3,400	4,250	1,350
1.500	0.188	1.124	3,150	4,200	5,250	1,650
1.500	0.220	1.060	3,750	5,000	6,250	2,000
1.500	0.250	1.000	4,300	5,750	7,200	2,300
2.000	0.065	1.870	750	1,000	1,250	400
2.000	0.083	1.834	950	1,250	1,600	500
2.000	0.095	1.810	1,100	1,450	1,850	550
2.000	0.109	1.782	1,250	1,700	2,150	650
2.000	0.120	1.760	1,400	1,900	2,350	750
2.000	0.134	1.732	1,600	2,100	2,650	850
2.000	0.148	1.704	1,750	2,350	2,950	950
2.000	0.156	1.688	1,850	2,500	3,150	1,000
2.000	0.188	1.624	2,300	3,050	3,800	1,200
2.000	0.220	1.560	2,700	3,650	4,550	1,450
2.000	0.250	1.500	3,100	4,200	5,250	1,650
2.000	0.281	1.438	3,550	4,750	5,950	1,900

Table S16 — Inch Tube Pressure Ratings (cont'd.)

See Table S11 for tube specifications.

Dimensions and pressure ratings are only subject to change.

# Metric Tube Pressure Ratings .....



TABLE OF CONTENTS

SECTION TABLE OF CONTENTS

Metric Tubes				
Tube O.D. (mm.)	Wall Thick. (mm.)	Tube I.D. (mm.)	Static Design Pressure (Bar)	
			Steel Low-Carbon St. 37.4	Stainless Steel 1.4571
4	0.5	3.0	313	
4	0.75	2.5	409	
4	1.0	2.0	522	600
5	1.0	3.0	432	
6	0.75	4.5	333	
6	1.0	4.0	389	426
6	1.5	3.0	549	600
6	2.0	2.0	692	
6	2.25	1.5	757	
8	1.0	6.0	333	368
8	1.5	5.0	431	472
8	2.0	4.0	549	
8	2.5	3.0	658	
10	1.0	8.0	282	294
10	1.5	7.0	373	389
10	2.0	6.0	478	498
10	2.5	5.0	576	
10	3.0	4.0	666	
12	1.0	10.0	235	245
12	1.5	9.0	353	368
12	2.0	8.0	409	426
12	2.5	7.0	495	
12	3.0	6.0	576	
12	3.5	5.0	651	
14	1.5	11.0	302	315
14	2.0	10.0	357	420
14	2.5	9.0	434	452
14	3.0	8.0	507	
14	3.5	7.0	576	
14	4.0	6.0	641	
15	1.0	13.0	188	196
15	1.5	12.0	282	294
15	2.0	11.0	336	392
15	3.0	9.0	478	
16	1.5	13.0	264	276
16	2.0	12.0	353	368
16	2.5	11.0	386	403
16	3.0	10.0	452	472
18	1.0	16.0	157	
18	1.5	15.0	235	245
18	2.0	14.0	313	327
18	2.5	13.0	392	

Metric Tubes				
Tube O.D. (mm.)	Wall Thick. (mm.)	Tube I.D. (mm.)	Static Design Pressure (Bar)	
			Steel Low-Carbon St. 37.4	Stainless Steel 1.4571
18	3.0	12.0	409	
20	1.5	17.0	212	
20	2.0	16.0	282	294
20	2.5	15.0	353	368
20	3.0	14.0	373	389
20	3.5	13.0	426	
20	4.0	12.0	478	
22	1.5	19.0	192	200
22	2.0	18.0	256	267
22	2.5	17.0	320	
22	3.0	16.0	343	
25	2.0	21.0	226	
25	2.5	20.0	282	294
25	3.0	19.0	338	353
25	4.0	17.0	394	
25	4.5	16.0	437	
25	5.0	15.0	478	
28	1.5	25.0	151	158
28	2.0	24.0	201	210
28	2.5	23.0	252	
28	3.0	22.0	302	
30	2.0	26.0	188	
30	2.5	25.0	235	245
30	3.0	24.0	282	294
30	4.0	22.0	336	392
30	5.0	20.0	409	
35	2.0	31.0	161	168
35	2.5	30.0	201	
35	3.0	29.0	242	
35	4.0	27.0	322	
38	2.5	33.0	186	
38	3.0	32.0	223	
38	4.0	30.0	297	309
38	5.0	28.0	332	
38	6.0	26.0	390	
38	7.0	24.0	446	
42	2.0	38.0	134	140
42	3.0	36.0	201	210
42	4.0	34.0	269	
50	6.0	38.0	338	
50	9.0	32.0	437	
65	8.0	49.0	347	

Table S17 — Metric Tube Pressure Ratings



The pressure tables above are calculated using LAME's equation:



TABLE OF CONTENTS

SECTION TABLE OF CONTENTS

**Design Pressure Formula (LAME'S)**

$$P = S \left( \frac{D^2 - d^2}{D^2 + d^2} \right) \text{ where:}$$

- D = Outside diameter of tube, in.
- d = Inside diameter of tube (D-2T), in
- P = Recommended design pressure, psi
- S = Allowable stress for design factor of 4, psi
- T = Tube wall thickness, in.

**Table S18 — Design Pressure Formula**

\*For thin wall tubes (D/T ≥ 10) the following formula may be used: **P = 2ST/D**

The allowable stress for popular material in the equations is listed in table below. The design factor is generally applied to ultimate strength of material (or burst pressure of tubing) to provide a measure of design margin against the unknowns in material and operating conditions.

Material and Type	Allowable Design Stress for Factor of 4 at 72°F	Tube Specification
Steel C1010	11,250 PSI	SAE J356, J524, J525
Steel C1021	15,000 PSI	SAE J2435, L2467
Steel, High Strength Low Alloy (HSLA)	18,000 PSI	SAE J2613, J2614
Stainless Steel 304 & 316	18,800 PSI	ASTM A213, A249, A269
Alloy Steel C4130	18,800 PSI	ASTM A519
Copper, K or Y	6,000 PSI	SAE J528, ASTM B75
Aluminum 6061-T6	10,500 PSI	ASTM B210
Monel, 400	17,500 PSI	ASTM B165

**Table S19 — Design Stress Values**

## FITTING AND TUBE SELECTION EXAMPLE:

As mentioned at the beginning of this section, the form below can be used as a guide when determining the proper tube fittings and adapters for your system. Below outlines an example application and illustrates how the table could be filled out.

A hydraulic power unit for a factory press in the U.S. has the following operating parameters:

- Type of fluid: Petroleum based hydraulic fluid
- Operating temperature range: -20°F to +140°F
- Maximum operating pressure: 3500psi
- Maximum flow rate through each line: 10GPM
- Severity of service: normal

For clarity, the application information can be organized into the Summary Information section of the table, and the selection steps can be documented in the Selection Process section.

Summary Information				
<b>Size</b>	<b>I.D.</b>		<b>O.D.</b>	
	TBD		TBD	
<b>Temperature</b>	<b>Material Conveyed</b>		<b>Environment (in a typical factory)</b>	
	<b>Min.</b>	<b>Max.</b>	<b>Min.</b>	<b>Max</b>
	-20°F	+140°F	+32°F	+100°F
<b>Application</b>	<b>Industrial Standards</b>	<b>Connection Styles</b>	<b>Severity of Service</b>	<b>Other</b>
	SAE(U.S.)	TBD	normal	NA
<b>Material/Media</b>	<b>Internal Media</b>		<b>External Environment</b>	
	Petroleum based hydraulic fluid		Inside a factory	
<b>Pressure</b>	<b>Max. Working Pressure</b>		<b>Spikes</b>	<b>Vacuum</b>
	3500psi		Normal	Low in suction line
Selection Process				
<b>STAMP Process</b>			<b>Explanation</b>	
<b>Size I.D.:</b> <ul style="list-style-type: none"> <li>• 10 GPM flow rate</li> <li>• Pressure line I.D. = 0.405</li> <li>• Return line I.D. = 0.639</li> <li>• Suction line I.D. = 1.012</li> <li>• O.D. and fitting size will be determined later</li> </ul>			<ul style="list-style-type: none"> <li>• Given</li> <li>• Use Table S1</li> </ul>	
<b>Temperature:</b> <ul style="list-style-type: none"> <li>• Operating temperature range: -20°F to +140°F</li> <li>• Potential fitting material: steel, stainless steel or brass</li> <li>• Potential seal material: NBR, EPDM, CR or SI</li> </ul>			<ul style="list-style-type: none"> <li>• Given</li> <li>• Use Table S3</li> <li>• Use Table S4</li> </ul>	

(Continued)

<p><b>Application:</b></p> <ul style="list-style-type: none"> <li>• Hydraulic power unit</li> <li>• Severity of service: normal</li> <li>• Geographic region: U.S.</li> <li>• No extreme pressure spikes, excessive vibration, extreme temperature swings or hazardous environment</li> <li>• Potential fitting types: SAE fittings</li> </ul>	<ul style="list-style-type: none"> <li>• Given</li> <li>• Given</li> <li>• Given</li> <li>• Based on normal service and experience with the hydraulic power unit</li> <li>• For U.S. use</li> </ul>
<p><b>Material/Media:</b></p> <ul style="list-style-type: none"> <li>• Petroleum based hydraulic fluid</li> <li>• Environment: indoors factory setting</li> <li>• Fitting material: narrow down to steel</li> <li>• Seal material: narrow down to NBR</li> </ul>	<ul style="list-style-type: none"> <li>• Given</li> <li>• Given</li> <li>• Use Table S3 and S10 and cost, availability</li> <li>• Use Table S4 and S10 and cost, availability</li> </ul>
<p><b>Pressure:</b></p> <ul style="list-style-type: none"> <li>• System type: dynamic</li> <li>• Design factor: 4:1</li> <li>• Derating factor: 1</li> <li>• Pressure line: 3500psi                         <ul style="list-style-type: none"> <li>o Tube: 5/8" O.D. x .083" wall, C1010 material (.095" and .109" wall can also be used)</li> <li>o Fitting size: -10</li> <li>o Fitting type: Seal-Lok</li> </ul> </li> <li>• Return line: &lt; 100psi                         <ul style="list-style-type: none"> <li>o Tube: 3/4" O.D. x .035" wall, C1010 material (.049" wall can also be used)</li> </ul> </li> <li>o Fitting Size: -12</li> <li>o Fitting type: Seal-Lok</li> <li>• Suction line: low vacuum                         <ul style="list-style-type: none"> <li>o Tube: 1 1/4" O.D. x .049" wall, C1010 material (thicker wall up to .083" can also be used)</li> <li>o Fitting Size: -20</li> <li>o Fitting type: Seal-Lok</li> </ul> </li> </ul>	<ul style="list-style-type: none"> <li>• Power unit for press is normally dynamic</li> <li>• Table S6</li> <li>• Table S5 and S6</li> <li>• Given</li> <li>• Use Table S27</li> <li>• To connect to 5/8" O.D. tube</li> <li>• Table S11 and S14 pressure rating, superior performance and availability in the U.S.</li> <li>• Experience</li> <li>• Use table S27</li> <li>• To connect to 3/4" O.D. tube</li> <li>• To be consistent with pressure line</li> <li>• Experience</li> <li>• Use Table S27</li> <li>• To connect to 1 1/4" O.D. tube</li> <li>• To be consistent with pressure line</li> </ul>

TABLE OF CONTENTS

SECTION TABLE OF CONTENTS

Dimensions and pressure for reference only, subject to change



## REFERENCE:

### 1. Tube and Port Size Pairing:

Table S20 and S21 provides the optimum tube to port size pairing. When the listed pairs are selected, the flow diameters of tube and port are closely matched.

TABLE  
OF  
CONTENTS

SECTION  
TABLE OF  
CONTENTS

Tube O.D.			Port Thread			
Inch (Dash Size)		Metric (mm.)	SAE	ISO	NPTF	BSPP
1/8	(-2)	4	5/16-24	M8 x 1	1/16-27	G 1/8-28
3/16	(-3)	5	3/8-24	M10 x 1	1/8-27	G 1/8-28
1/4	(-4)	6	7/16-20	M10 x 1	1/8-27	G 1/8-28
5/16	(-5)	8	1/2-20	M12 x 1.5	1/8-27	G 1/4-19
3/8	(-6)	10	9/16-18	M14 x 1.5	1/4-18	G 1/4-19
1/2	(-8)	12	3/4-16	M16 x 1.5	3/8-18	G 3/8-19
—		15	3/4-16	M18 x 1.5	1/2-14	G 1/2-14
5/8	(-10)	16, 18	7/8-14	M22 x 1.5	1/2-14	G 1/2-14
3/4	(-12)	20	1 1/16-12	M27 x 2	3/4-14	G 3/4-14
7/8	(-14)	22	1 3/16-12	M27 x 2	3/4-14	G 3/4-14
1	(-16)	25, 28	1 5/16-12	M33 x 2	1-11 1/2	G 1-11
1 1/4	(-20)	30, 35	1 5/8-12	M42 x 2	1 1/4-11 1/2	G 1 1/4-11
1 1/2	(-24)	38, 42	1 7/8-12	M48 x 2	1 1/2-11 1/2	G 1 1/2-11
2	(-32)	50	2 1/2-12	M60 x 2	2-11 1/2	G 2-11

**Table S20 — Tube to Port Pairing for Medium Pressure Applications**

- 1) Ports are in accordance with the standards listed below:  
SAE J1926-1, ISO 6149-1, NPTF-SAE J476 and BSPP-ISO 1179-1
- 2) The pressure range covering all the sizes shown is 1000 to 5000 PSI.

Tube O.D.			Port Thread			
Inch (Dash Size)		Metric (mm.)	SAE	ISO	NPTF	BSPP
1/8	(-2)	4	5/16-24	M8 x 1	1/16-27	G 1/8-28
3/16	(-3)	5	3/8-24	M10 x 1	1/8-27	G 1/8-28
1/4	(-4)	6	7/16-20	M12 x 1.5	1/8-27	G 1/8-28
5/16	(-5)	8	1/2-20	M14 x 1.5	1/8-27	G 1/4-19
3/8	(-6)	10	9/16-18	M16 x 1.5	1/4-18	G 1/4-19
1/2	(-8)	12	3/4-16	M18 x 1.5	3/8-18	G 3/8-19
5/8	(-10)	14, 16	7/8-14	M22 x 1.5	1/2-14	G 1/2-14
3/4	(-12)	20	1 1/16-12	M27 x 2	3/4-14	G 3/4-14
7/8	(-14)	—	1 3/16-12	M30 x 2	3/4-14	G 3/4-14
1	(-16)	25	1 5/16-12	M33 x 2	1-11 1/2	G 1-11
1 1/4	(-20)	30	1 5/8-12	M42 x 2	1 1/4-11 1/2	G 1 1/4-11
1 1/2	(-24)	38	1 7/8-12	M48 x 2	1 1/2-11 1/2	G 1 1/2-11
2	(-32)	50	2 1/2-12	M60 x 2	2-11 1/2	—

**Table S21 — Tube to Port Pairing for High Pressure Applications**

- 1) Ports are in accordance with the standards listed below:  
SAE J1926-1, ISO 6149-1, NPTF-SAE J476 and BSPP-ISO 1179-1
- 2) The pressure range covering all the sizes shown is 2500 to 9000 PSI

S

## 2. Common Port Details:

### ISO 6149-1 — Metric Straight Thread O-Ring Port

(SAE 2244-1/DIN 3852, Part 3) Metric ISO 261, "M" Thread

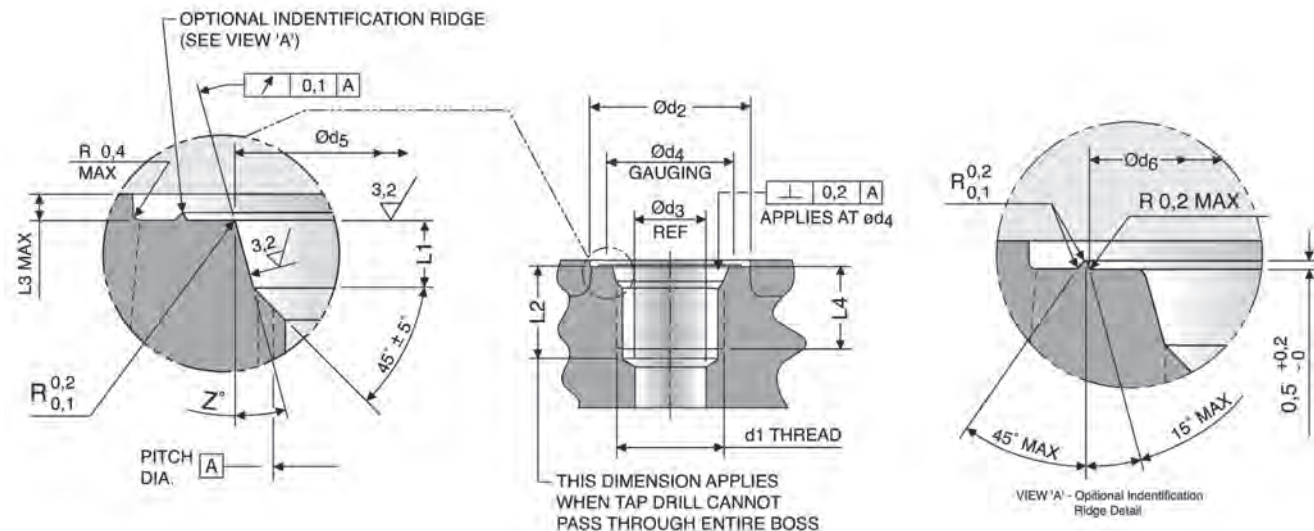

Thread Size	Large d2 <sup>2)</sup>	Small d2 <sup>3)</sup>	d3 <sup>4)</sup>	d4	d5	d6	L1	L2 <sup>9)</sup>	L3	L4	Z°	Parker O-Ring Size <sup>8)</sup>
d1 <sup>1)</sup>	min	min.	ref.		+0.1 0	+0.5 0	+0.4 0	min.	max	min. full thread	±1°	
M8 X 1	17	14	3	12.5	9.1	14	1.6	11.5	1	10	12°	M8 ISO O-Ring
M10 X 1	20	16	4.5	14.5	11.1	16	1.6	11.5	1	10	12°	M10 ISO O-Ring
M12 X 1.5	23	19	6	17.5	13.8	19	2.4	14	1.5	11.5	15°	M12 ISO O-Ring
M14 X 1.5 <sup>6)</sup>	25	21	7.5	19.5	15.8	21	2.4	14	1.5	11.5	15°	M14 ISO O-Ring
M16 X 1.5	28	24	9	22.5	17.8	24	2.4	15.5	1.5	13	15°	M16 ISO O-Ring
M18 X 1.5	30	26	11	24.5	19.8	26	2.4	17	2	14.5	15°	M18 ISO O-Ring
M22 X 1.5	33	29	14	27.5	23.8	29	2.4	18	2	15.5	15°	M22 ISO O-Ring
M27 X 2	40	34	18	32.5	29.4	34	3.1	22	2	19	15°	M27 ISO O-Ring
M30 X 2	44	38	21	36.5	32.4	38	3.1	22	2	19	15°	M30 ISO O-Ring
M33 X 2	49	43	23	41.5	35.4	43	3.1	22	2.5	19	15°	M33 ISO O-Ring
M42 X 2	58	52	30	50.5	44.4	52	3.1	22.5	2.5	19.5	15°	M42 ISO O-Ring
M48 X 2	63	57	36	55.5	50.4	57	3.1	25	2.5	22	15°	M48 ISO O-Ring
M60 X 2	74	67	44	65.5	62.4	67	3.1	27.5	2.5	24.5	15°	M60 ISO O-Ring

#### FOR CARTRIDGE VALVE CAVITIES ONLY (SEE ISO 7789)

M20X1.5 <sup>7)</sup>	32	27	—	25.5	21.8	27	2.4	—	2	14.5	15°	M20 ISO O-Ring
-----------------------	----	----	---	------	------	----	-----	---	---	------	-----	----------------

Table S22 — Port Detail — ISO 6149-1

- 1) Per ISO 261 tolerance class 6H. Tap drill per ISO 2306 class 6H.
- 2) Spotface diameter with the optional identification ridge.
- 3) Spotface diameter without identification ridge. Port to be identified by marking "metric" or "M" next to it or "ISO 6149-1 Metric" on component name plate.
- 4) Reference only. Connecting hole application may require a different size.
- 5) Tap drill depths given require use of a bottoming tap to produce the specified full thread lengths. Where standard taps are used, increase tap drill depths accordingly.
- 6) Preferred for diagnostic port applications.
- 7) For cartridge valve cavity applications only.
- 8) 90 durometer nitrile is standard for hydraulic applications.

NOTE: For port tapping tools, see page S40. See page R5 for assembly torques.

TABLE  
OF  
CONTENTS

SECTION  
TABLE OF  
CONTENTS

# SAE J1926-1 — SAE Straight Thread O-Ring Port (ISO 11926-1)

UN/UNF Threads

TABLE OF CONTENTS

SECTION TABLE OF CONTENTS

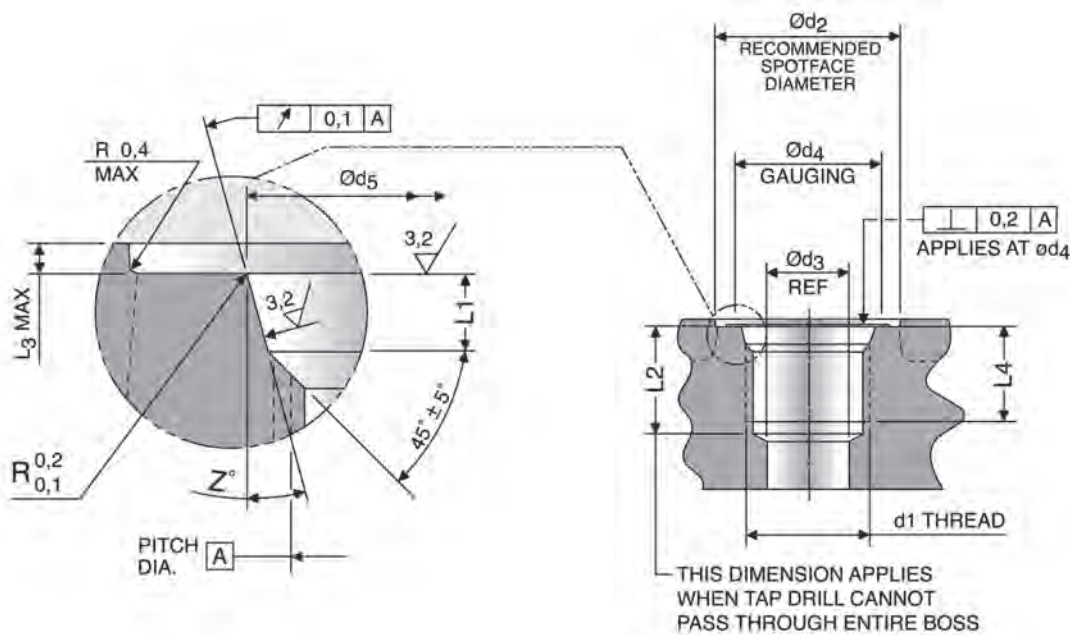

Nominal Tube OD <sup>1)</sup>			Thread Size ANSI B1.1 (ISO 263) (in.)	d2 dia. <sup>3)</sup> (mm.)	d3 dia. min. (mm.)	d4 dia. min. (mm.)	d5 dia. <sup>4)</sup> +0.13 -0.00 (mm.)	L1 +0.4 -0.00 (mm.)	L2 <sup>5)</sup> min. (mm.)	L3 <sup>3), 6)</sup> max (mm.)	L4 Full Thread min. (mm.)	Z $\pm 1^\circ$ deg.	Parker O-Ring Size <sup>7)</sup>
Nom <sup>2)</sup> SAE Dash Size	Inch (in.)	Metric (mm.)											
-2	1/8	—	5/16-24 UNF-2B	17	1.6	11	9.1	1.9	12.0	1.6	10.0	12°	3-902
-3	3/16	4	3/8-24 UNF-2B	19	3.2	13	10.7	1.9	12.0	1.6	10.0	12°	3-903
-4	1/4	6	7/16-20 UNF-2B	21	4.4	15	12.4	2.4	14.0	1.6	11.5	12°	3-904
-5	5/16	8	1/2-20 UNF-2B	23	6.0	16	14.0	2.4	14.0	1.6	11.5	12°	3-905
-6	3/8	10	9/16-18 UNF-2B	25	7.5	18	15.6	2.5	15.5	1.6	12.7	12°	3-906
-8	1/2	12	3/4-16 UNF-2B	30	10.0	22	20.6	2.5	17.5	2.4	14.3	15°	3-908
-10	5/8	14, 15, 16	7/8-14 UNF-2B	34	12.5	26	23.9	2.5	20.0	2.4	16.7	15°	3-910
-12	3/4	18, 20	1 1/16-12 UN-2B	41	16.0	32	29.2	3.3	23.0	2.4	19.0	15°	3-912
-14	7/8	22	1 3/16-12 UN-2B	45	18.0	35	32.3	3.3	23.0	2.4	19.0	15°	3-914
-16	1	25, 28	1 5/16-12 UN-2B	49	21.0	38	35.5	3.3	23.0	3.2	19.0	15°	3-916
-20	1 1/4	30, 32, 35	1 5/8-12 UN-2B	58	27.0	48	43.5	3.3	23.0	3.2	19.0	15°	3-920
-24	1 1/2	38, 42	1 7/8-12 UN-2B	65	33.0	54	49.8	3.3	23.0	3.2	19.0	15°	3-924
-32	2	50	2 1/2-12 UN-2B	88	45.0	70	65.7	3.3	23.0	3.2	19.0	15°	3-932

Table S23 — Port Detail — SAE J1926-1 (ISO 11926-1)

- Nominal tube OD is shown for the standard inch sizes and the conversion to equivalent millimeter sizes. Figures are for reference only, as any boss can be used for a tubing size depending upon other design criteria.
- See SAE J846 for more information.
- If face of boss is on a machined surface, dimensions d2 and L3 need not apply as long as corner radius R0.2 is maintained.
- Diameter d5 shall be concentric with thread pitch diameter within 0.004 in (0.1mm) FIM, and shall be free from longitudinal and spiral tool marks. Annular tool marks up to 100  $\mu$ in (2.5 $\mu$ m) max. shall be permissible.
- Tap drill depths given require use of bottoming taps to produce the specified full thread lengths. Where standard taps are used, the tap drill depths must be increased accordingly.
- Maximum recommended spotface depth to permit sufficient wrench grip for proper tightening of the fitting or locknut.
- 90 durometer nitrile is standard for hydraulic applications.

For assembly torques see page R5.

Learn more about the size differences of SAE J1926 port ends in our TFD techConnect blog "Important System Design Considerations for SAE J1926 Ports."

# ISO 6162 — Four-Bolt Flange Connection (Includes SAE J518)

TABLE OF CONTENTS

SECTION TABLE OF CONTENTS

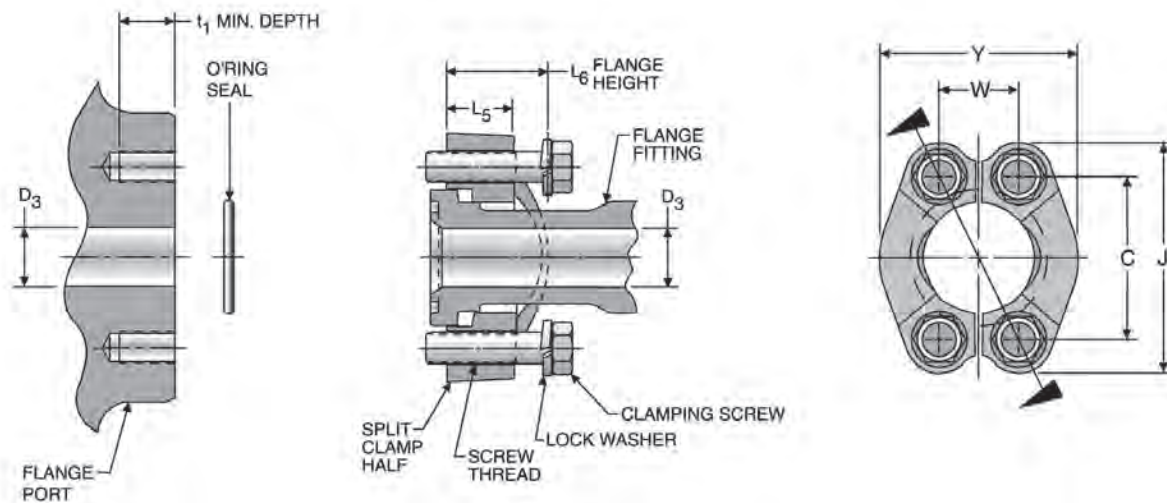

Nominal Flange Size D3		2.5 to 31.5 MPa Series <sup>1)</sup> (SAE Code 61)											O-Rings <sup>3)</sup>	
		Clamping Screws Screw Holes				Flange Half and Bolt Pattern								
		Type I		Type II <sup>2)</sup> (SAE J518)		C	J		W	Y	L5	L6	ISO 3601-1 ID x Section	Parker O-Ring Size
(in.)	(mm.)	Thread	t <sub>1</sub> Min. depth	Thread (UNC)	t <sub>1</sub> Min. depth	± 0.25	max.	min.	± 0.25	Ref.				
1/2	13	M8 x 1.5	12.5	5/16 - 18	24	38.1	54.9	53.1	17.5	46	13	19	19 x 3.55	2-210
3/4	19	M10 x 1.5	16.5	3/8 - 16	22	47.6	65.8	64.3	22.3	52	14	22	25 x 3.55	2-214
1	25	M10 x 1.5	14.5	3/8 - 16	22	52.4	70.6	69.1	26.2	59	16	22	32.5 x 3.55	2-219
1 1/4	32	M10 x 1.5	16.5	7/16 - 14	28	58.7	80.3	78.5	30.2	73	14 <sup>4)</sup>	24	37.5 x 3.55	2-222
1 1/2	38	M12 x 1.75	19.5	1/2 - 13	27	69.9	94.5	93.0	35.7	83	16	25	47.5 x 3.55	2-225
2	51	M12 x 1.75	19.5	1/2 - 13	27	77.8	103.1	100.1	42.9	97	16	26	56 x 3.55	2-228
2 1/2	64	M12 x 1.75	21.5	1/2 - 13	30	88.9	115.8	112.8	50.8	109	19	38	69 x 3.55	2-232
3	76	M16 x 2	28.5	5/8 - 11	30	106.4	136.7	133.4	61.9	131	22	41	85 x 3.55	2-237
3 1/2	89	M16 x 2	28.5	5/8 - 11	33	120.7	153.9	150.9	69.9	140	22	28	97.5 x 3.55	2-241
4	102	M16 x 2	25.5	5/8 - 11	30	130.2	163.6	160.3	77.8	152	25	35	112 x 3.55	2-245
5	127	M16 x 2	27.5	5/8 - 11	33	152.4	182.6	185.7	92.1	181	28	41	136 x 3.55	2-253

Nominal Flange Size D3		40 MPa Series <sup>1)</sup> (SAE Code 62)											O-Rings <sup>3)</sup>	
		Clamping Screws Screw Holes				Flange Half and Bolt Pattern								
		Type I		Type II <sup>2)</sup> (SAE J518)		C	J		W	Y	L5	L6	ISO 3601-1 ID x Section	Parker O-Ring Size
(in.)	(mm.)	Thread	t <sub>1</sub> Min. depth	Thread (UNC)	t <sub>1</sub> Min. depth	± 0.25	max.	min.	± 0.25	Ref.				
1/2	13	M8 x 1.5	14.5	5/16 - 18	21	40.5	57.2	55.6	18.2	48	16	22	19 x 3.55	2-210
3/4	19	M10 x 1.5	16.5	3/8 - 16	24	50.8	72.1	70.6	23.8	60	19	28	25 x 3.55	2-214
1	25	M12 x 1.75	21.5	7/16 - 14	27	57.2	81.8	80.3	27.8	70	24	33	32.5 x 3.55	2-219
1 1/4	32	M12 x 1.75	18.5	1/2 - 13	25	66.6	96.0	94.5	31.8	78	27	38	37.5 x 3.55	2-222
1 1/2	38	M16 x 2	25.5	5/8 - 11	35	79.3	114.3	111.3	36.5	95	30	43	47.5 x 3.55	2-225
2	51	M20 x 2.5	33.5	3/4 - 10	38	96.8	134.9	131.8	44.5	114	37	52	56 x 3.55	2-228

Table S24 — Port Detail — ISO 6162

- 1) 1 MPa = 10 bar = 145 PSI.
- 2) Not for new design.
- 3) 90 durometer nitrile is standard for hydraulic applications.

See page R5 for assembly torques.



# ISO 1179-1) — Flat Face Port with British Standard Pipe, Parallel (BSP) Threads

(DIN 3852, Part 2)

ISO 228-1, "G" Threads

TABLE OF CONTENTS

SECTION TABLE OF CONTENTS

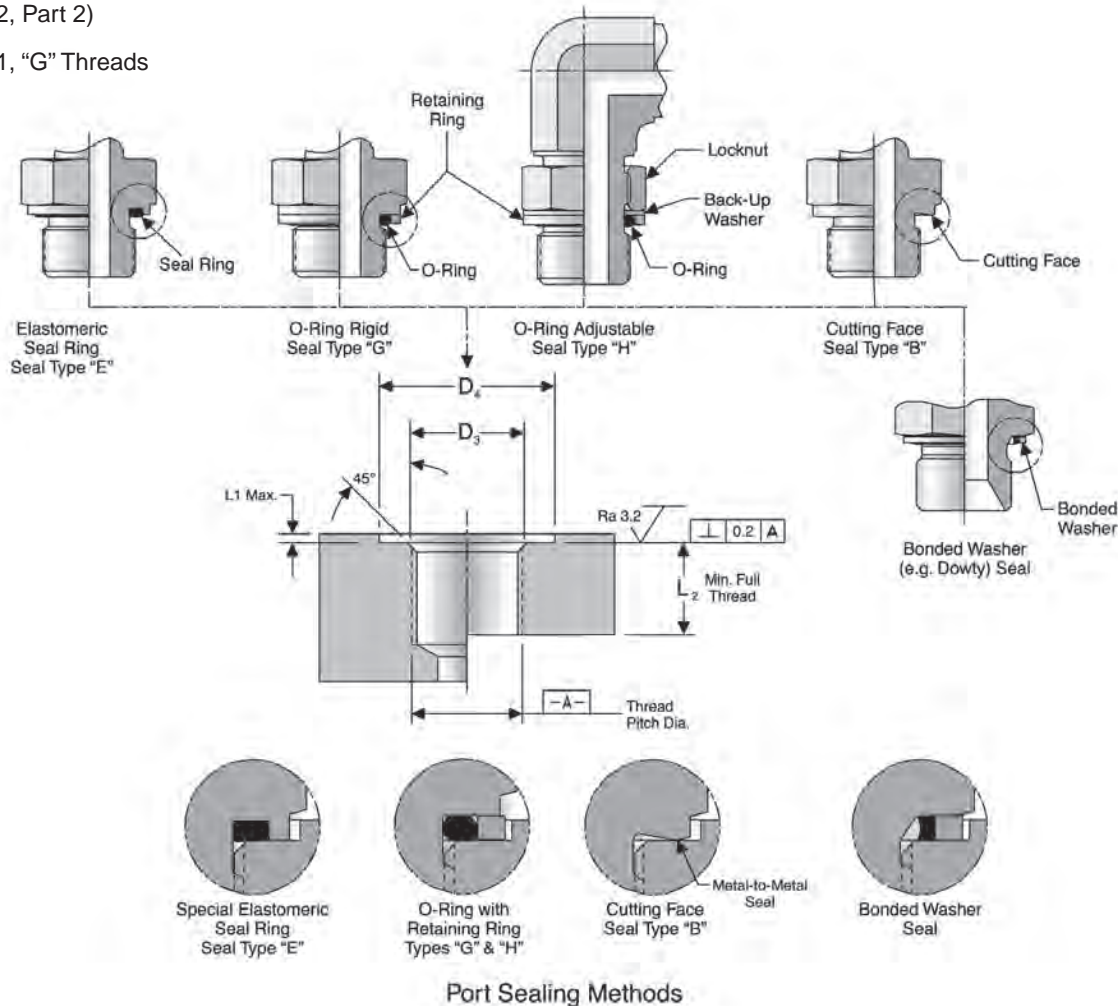

Port Sealing Methods

Thread Size (ISO 228-1)	D3 (mm.)	D4 (mm.)		L1 max. (mm.)	L2 min. (mm.)	EOlastic Seal (Type E)		O-Ring and Retaining Ring (Types G & H)		Bonded Washer Part No. <sup>3)</sup>
		Narrow Types B & E	Wide Types G & H			Part No.	O-Ring Size <sup>1)</sup>	O-Ring ID x section (mm.)	Retaining Ring Part No.	
G 1/8-28	9.9	15	17.2	1.0	8.5	ED10X1X	5-585	7.98 x 1.88	1/8 RR	D9DT-2
G 1/4-19	13.3	20	20.7	1.5	12.5	ED14X1.5X	2-111	10.77 x 2.62	1/4 RR	D9DT-4
G 3/8 19	16.8	23	24.5	2.0	12.5	EDR3/8X	2-113	13.94 x 2.62	3/8 RR	D9DT-6
G 1/2-14	21.1	28	34.0	2.5	14.5	EDR1/2X	5-256	17.96 x 2.62	1/2 RR	D9DT-8
G 3/4-14	26.6	33	40.0	2.5	16.5	ED26X1.5X	2-119	23.47 x 2.62	3/4 RR	D9DT-12
G 1-11	33.5	41	46.1	2.5	18.5	ED33X2X	2-217	29.74 x 3.53	1 RR	D9DT-16
G 1 1/4-11	42.2	51	54.0	2.5	20.5	ED42X2X	2-222	37.69 x 3.53	1 1/4 RR	D9DT-20
G 1 1/2-11	48.1	56	60.5	2.5	22.5	ED48X2X	2-224	44.04 x 3.53	1 1/2 RR	D9DT-24
G 2-11	59.9	69	73.3	3.0	26.0	—	—	—	—	D9DT-32

Table S25 — Port Detail — ISO 1179-1

- 1) 90 durometer nitrile is standard for hydraulic applications.
- 2) See page M6 for O-ring and retaining ring ordering information.
- 3) See page M3 for details.

S



# ISO 9974-1 — Flat Face Port with Metric Threads

(DIN 3852, Part 1)

Metric ISO261, "M" Thread

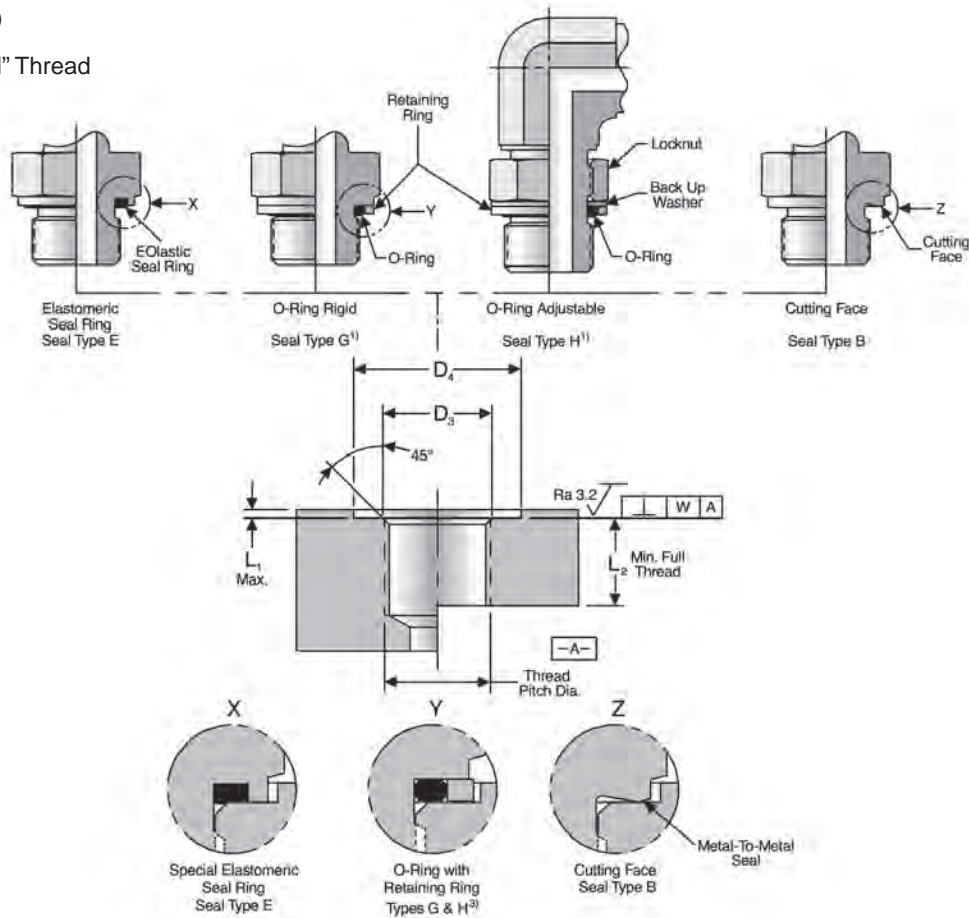

(See Note 1)

ISO 9974 Port seal types available from Parker

Thread Size (ISO 261)	D3 (mm.)	D4 (mm.)	L1 max. (mm.)	L2 min. (mm.)	W (mm.)	Elastic Seal (Type E)			
						Part No.	O-Ring Size <sup>2)</sup>	O-Ring ID x section (mm.)	Retaining Ring Part No.
M8 x 1	8 +0.2	13	1	8		ED8X1X	3-902	6.07 x 1.63	M8 RR
M10 x 1	10 +0.2	15	1	8		ED10X1X	6-074	8.00 x 1.50	M10 RR
M12 x 1.5	12 +0.2	18	1.5	12		ED12X1.5X	2-012	9.25 x 1.78	M12 RR
M14 x 1.5	14 +0.2	20	1.5	12	0.1	ED14X1.5X	2-013	10.82 x 1.78	M14 RR
M16 x 1.5	16 +0.2	23	1.5	12		ED16X1.5X	3-907	13.46 x 2.08	M16 RR
M18 x 1.5	18 +0.2	25	2	12		ED18X1.5XX	2-114	15.54 x 2.62	M18 RR
M20 x 1.5 <sup>3)</sup>	20 +0.2	27	2	14		ED20X1.5X	2-017	17.17 x 1.78	M20 RR
M22 x 1.5	22 +0.2	28	2.5	14		ED22X1.5X	2-018	18.77 x 1.78	M22 RR
M24 x 1.5 <sup>4)</sup>	24 +0.2	30	2.5	14		—	2-019	20.35 x 1.78	M24 RR
M26 x 1.5	26 +0.2	33	2.5	16		ED26X1.5X	2-118	21.89 x 2.62	M26 RR
M27 x 2	27 +0.2	33	2.5	16		ED26X1.5X	2-119	23.47 x 2.62	M27 RR
M33 x 2	33 +0.3	41	2.5	18	0.2	ED33X2X	2-122	28.24 x 2.62	M33 RR
M36 x 2 <sup>4)</sup>	36 +0.3	43	2.5	18		—	2-124	31.42 x 2.62	M36 RR
M42 x 2	42 +0.3	51	2.5	20		ED42X2X	2-128	37.77 x 2.62	M42 RR
M45 x 2 <sup>4)</sup>	45 +0.3	50	2.5	20		—	2-130	40.94 x 2.62	M45 RR
M48 x 2	48 +0.3	56	2.5	22		ED48X2X	2-132	44.12 x 2.62	M48 RR

Table S26 — Port Detail — ISO 9974-1

- 1) Seal types G and H are not covered in ISO 9974-1. See page M5 for retaining ring and O-ring ordering information.
- 2) 90 durometer nitrile is standard for hydraulic applications.
- 3) For diagnostic applications.
- 4) These sizes are not covered in ISO 9974-1.

## NPTF and BSPT Dimensions

TABLE  
OF  
CONTENTS

SECTION  
TABLE OF  
CONTENTS

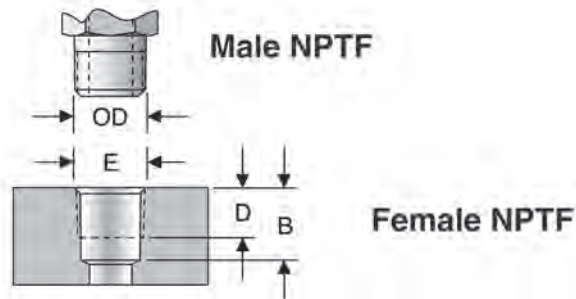

Thread Size NPTF	O.D. Male Thread Large Dia.	D Min.. Thread Length	B Min.. Tap Drill Depth <sup>1)</sup>	E Chmf. Dia.
1/8-27	0.41	0.31	0.38	0.42
1/4-18	0.55	0.44	0.47	0.55
3/8-18	0.68	0.47	0.53	0.69
1/2-14	0.85	0.59	0.69	0.85
3/4-14	1.06	0.63	0.75	1.06
1-11 1/2	1.33	0.75	0.84	1.34
1 1/4-11 1/2	1.67	0.78	0.84	1.68
1 1/2-11 1/2	1.91	0.81	0.88	1.92
2-11 1/2	2.39	0.81	0.91	2.39

Table S27 — NPTF Dimensions

1) For bottoming taps only.

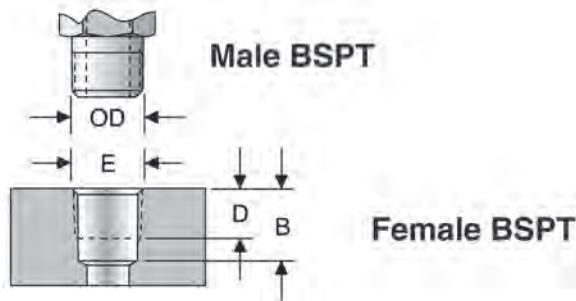

Thread Size BSPT	O.D. Male Thread Large Dia.	D Min.. Thread Length	B Min.. Tap Drill Depth <sup>1)</sup>	E Chmf. Dia.
1/8-28	0.39	0.31	0.38	0.42
1/4-19	0.53	0.44	0.47	0.55
3/8-19	0.67	0.47	0.53	0.69
1/2-14	0.84	0.59	0.69	0.85
3/4-14	1.06	0.63	0.75	1.06
1-11	1.33	0.75	0.84	1.34
1 1/4-11	1.67	0.78	0.84	1.68
1 1/2-11	1.90	0.81	0.88	1.92
2-11	2.37	0.81	0.91	2.39

Table S28 — BSPT Dimensions

1) For bottoming taps only.

2) Male BSPT may be used with female BSPP ports.

S

## Recommended Use of Porting Tools

Parker recommends porting tools for machining precision ports (glands) conforming to DIN 3852-1, SAE J1926-1 (SAE straight thread port) and ISO 6149-1. Please see the equipment section for the available Parker porting tools.

Machining ports to accept Parker tube fittings is completed in three simple steps.

To begin, select the appropriate size port tooling for the fitting end in question. Next, follow these machining steps.

TABLE  
OF  
CONTENTS

SECTION  
TABLE OF  
CONTENTS

### 1. Pilot Hole Drilling.

First, make a pilot hole for the counterbore by using an appropriate drill or bore size. Make hole depth according to the port detail on pages S34, S35, S37 and S38.

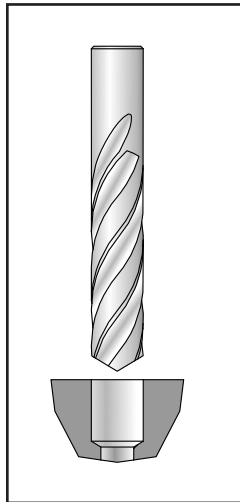

Fig. S4 — Pilot drilling for counterbore tool

### 2. Port Counterboring.

Run the counterbore tool into the pilot diameter created in step 1. All features and dimensions of the port and O-ring cavity are built into the counterboring tool except the depth. The depth of the counterbore machining may vary from a light spotface, up to the maximum spotface depth listed on the port detail on pages S34 and S35.

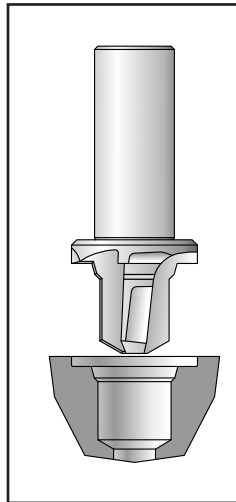

Fig. S5 — Counterboring tool

### 3. Thread Tapping.

Lastly, the machined port must be threaded to accommodate the fitting. Use the appropriate tap intended for the same thread type, size, and class.

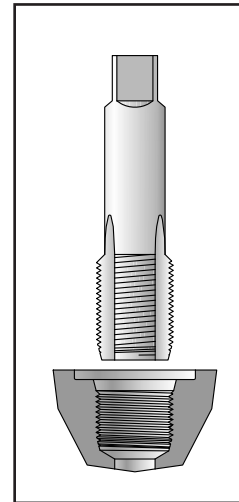

Fig. S6 — Tapping

**Note:** It is necessary to create a spotface surface which is flat and perpendicular to the port, and with a smooth finish to prevent leakage or O-ring extrusion. Cast or forged surfaces must be spotface machined to meet these requirements. Even on smooth surfaces (machined surfaces), it is necessary to lightly touch the surface to assure a smooth radius at the entrance of the port.

### 3. Common Tube End Thread Size

#### Tube End Connections

#### Thread Size Guide — Inch Thread

TABLE  
OF  
CONTENTS

SECTION  
TABLE OF  
CONTENTS

Tube O.D. or Adapter Size			O-ring Face Seal (ORFS)	37° Flare	Inch 24° cone <sup>3)</sup> Flareless	SAE 45° Flare <sup>3)</sup>
Nominal metric size <sup>3)</sup>	Nominal Inch		SAE J1453	SAE J514	SAE J514	SAE J512
	size	SAE dash size	“Seal-Lok”	“Triple-Lok”	“Ferulok”	
(mm)	(in)		Inch ANSI B1.1, unified (ISO 263)	Inch ANSI B1.1, unified (ISO 263)	Inch ANSI B1.1, unified (ISO 263)	Inch ANSI B1.1, unified (ISO 263)
—	1/8	-2	—	5/16-24	5/16-24	5/16-24
4	—	—	—	—	—	—
5	3/16	-3	—	3/8-24	3/8-24	3/8-24
6	1/4	-4	9/16-18	7/16-20	7/16-20	7/16-20
8	5/16	-5	—	1/2-20	1/2-20	1/2-20
10	3/8	-6	11/16-16	9/16-18	9/16-18	5/8-18
12	1/2	-8	13/16-16	3/4-16	3/4-16	3/4-16
14	5/8	-10	1-14	7/8-14	7/8-14	7/8-14
15 <sup>1)</sup>	5/8	-10	1-14	7/8-14	—	—
16	5/8	-10	1-14	7/8-14	—	—
18 <sup>1)</sup>	3/4	-12	1 3/16-12	1 1/16-12	1 1/16-12	1 1/16-14
20	3/4	-12	1 3/16-12	1 1/16-12	—	—
22 <sup>1)</sup>	7/8	-14	—	1 3/16-12	1 3/16-12	—
25	1	-16	1 7/16-12	1 5/16-12	1 5/16-12	—
28 <sup>1)</sup>	1 1/4	-20	1 11/16-12	—	1 5/8-12	—
30	1 1/4	-20	1 11/16-12	1 5/8-12	—	—
32 <sup>2)</sup>	1 1/4	-20	1 11/16-12	1 5/8-12	—	—
38	1 1/2	-24	2-12	1 7/8-12	1 7/8-12	—
50	2	-32	2 1/2-12	2 1/2-12	2 1/2-12	—

Table S29 — Tube End Connections

- 1) Not preferred for high pressure applications.
- 2) Non-preferred size. Use 30mm size in place of 32mm size.
- 3) Metric tube sizes do not apply to “Ferulok” and 45° flare fittings.

S

## Tube End Connections Thread Size Guide — Metric, BSPP and JIS Threads

TABLE  
OF  
CONTENTS

SECTION  
TABLE OF  
CONTENTS

Tube O.D. or Adapter Size (mm)	Metric 24° cone			Metric 24° cone Flareless	60° Cone	30° Flare and 60° Cone
	Flareless DIN 3861 LL Series Metric ISO 261	Weld Nipple DIN 3865 L Series Metric ISO 261	S Series Metric ISO 261	JIS B2351 “JIS” Metric ISO 261 (JIS B0207)	BS 5200 ISO 228-1 (BSPP) <sup>5)</sup>	JIS B8363 ISO 228-1 (JIS B 0202) (BSPP) <sup>5)</sup>
—	—	—	—	—	—	—
4	M8 x 1	—	—	—	—	—
5	M10 x 1 <sup>3)</sup>	—	—	—	—	—
6	M10 x 1	M12 x 1.5	M14 x 1.5	M12 x 1.5	G 1/8 A	G 1/4 B
8	M12 x 1	M14 x 1.5	M16 x 1.5	M14 x 1.5	G 1/4 A	—
9 <sup>2)</sup>	—	—	—	—	—	G 3/8 B
10	M14 X 1 <sup>4)</sup>	M16 x 1.5	M18 x 1.5	M16 x 1.5	G 3/8 A	—
12	M16 x 1 <sup>4)</sup>	M18 x 1.5	M20 x 1.5	M18 x 1.5	G 1/2 A	G 1/2 B
14	—	—	M22 x 1.5	—	—	—
15 <sup>1)</sup>	—	M22 x 1.5	—	—	—	—
16	—	—	M24 x 1.5	M24 x 1.5	G 5/8 A <sup>6)</sup>	—
18 <sup>1)</sup>	—	M26 x 1.5	—	—	—	—
19 <sup>2)</sup>	—	—	—	—	—	G 3/4 B
20	—	—	M30 x 2	M28 x 1.5	G 3/4 A	—
22 <sup>1)</sup>	—	M30 x 2	—	—	—	—
25	—	—	M36 x 2	M35 x 1.5	G 1 A	G 1 B
28 <sup>1)</sup>	—	M36 x 2	—	—	—	—
30	—	—	M42 x 2	M40 x 1.5	G 1-1/4 A	—
32 <sup>2)</sup>	—	—	—	—	—	G 1-1/4 B
35 <sup>1)</sup>	—	M45 x 2	—	—	—	—
38	—	—	M52 x 2	M48 x 1.5	G 1-1/2 A	G 1-1/2 B
42 <sup>1)</sup>	—	M52 x 2	—	—	—	—
50	—	—	—	—	G 2 A	G 2 B

Table S30— Tube End Connections

- 1) Not preferred for high pressure applications.
- 2) Not preferred sizes. Use 10mm, 20mm and 30mm sizes in place of 9mm, 19mm and 32mm sizes, respectively.
- 3) Covered in ISO 8434-1. Non-standard with Parker.
- 4) Not part of DIN or ISO standards, but offered by Parker.
- 5) ISO 228-1 G threads and JIS B 0202 G or PF threads can be interchanged. “A” and “B” indicate different tolerance classes on the male threads, “A” having tighter tolerances than “B”.
- 6) Non-preferred size.



## 4. Conformance Standards:

### Tube End Connections

#### Threads, Conformance Specifications and Use

TABLE  
OF  
CONTENTS

SECTION  
TABLE OF  
CONTENTS

						
Description	O-Ring Face Seal (ORFS) "Seal-Lok"	37° Flare "Triple-Lok"	Inch 24° Cone Flareless "Ferulok"	Metric 24° Cone Flareless "EO" and "EO2"	Metric 24° Cone Flareless "JIS"	30° Flare and 60° Cone "JIS"
Thread Type	ISO 263 ANSI B1.1 unified	ISO 263 ANSI B1.1, unified	ISO 263 ANSI B1.1, unified	ISO 261 Metric fine	ISO 261 JIS B 0207	ISO 228-1 JIS B0202, BS2779
ISO No.	8434-3 (12151-1) <sup>1)</sup>	8434-2 (12151-6) <sup>1)</sup>	—	8434-1 & -4 (12151-2) <sup>1)</sup>	—	—
SAE No.	J1453/J516 <sup>2)</sup>	J514/J516 <sup>2)</sup>	J514	—	—	—
DIN No.	—	—	—	3861, 3865 & 20078 <sup>2)</sup>	—	—
JIS No.	—	—	—	Similar to B2351	B2351	B8363 <sup>3)</sup>
BSI No.	—	—	—	—	—	Similar to BS 5200 <sup>4)</sup>
Current use	Mainly used in North America gaining acceptance in Europe and Japan.	Used throughout the world with major usage in North America.	Mainly used in North America.	Mainly used in Europe. Slowly gaining acceptance in North America.	Mainly used in Japan for hard plumbed systems.	Mainly used in Japan, U.K. and British commonwealth countries.

Table S31 — Tube End Connections

- 1) Hose fitting specification no.
- 2) Hose fitting specification no.
- 3) Adapter and hose fitting specification no.
- 4) 60° cone fittings only. See page S42 for more information.

S

Dimensions and pressures for reference only, subject to change.

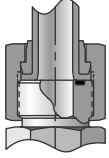
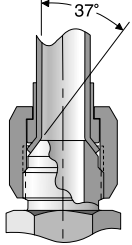
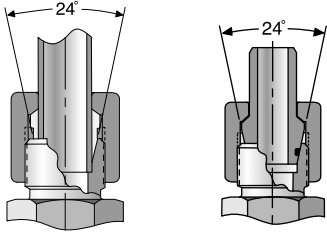
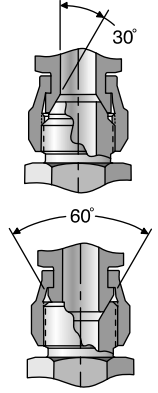
## Port End Connections Threads, Conformance Specifications, and Use

TABLE  
OF  
CONTENTS

SECTION  
TABLE OF  
CONTENTS

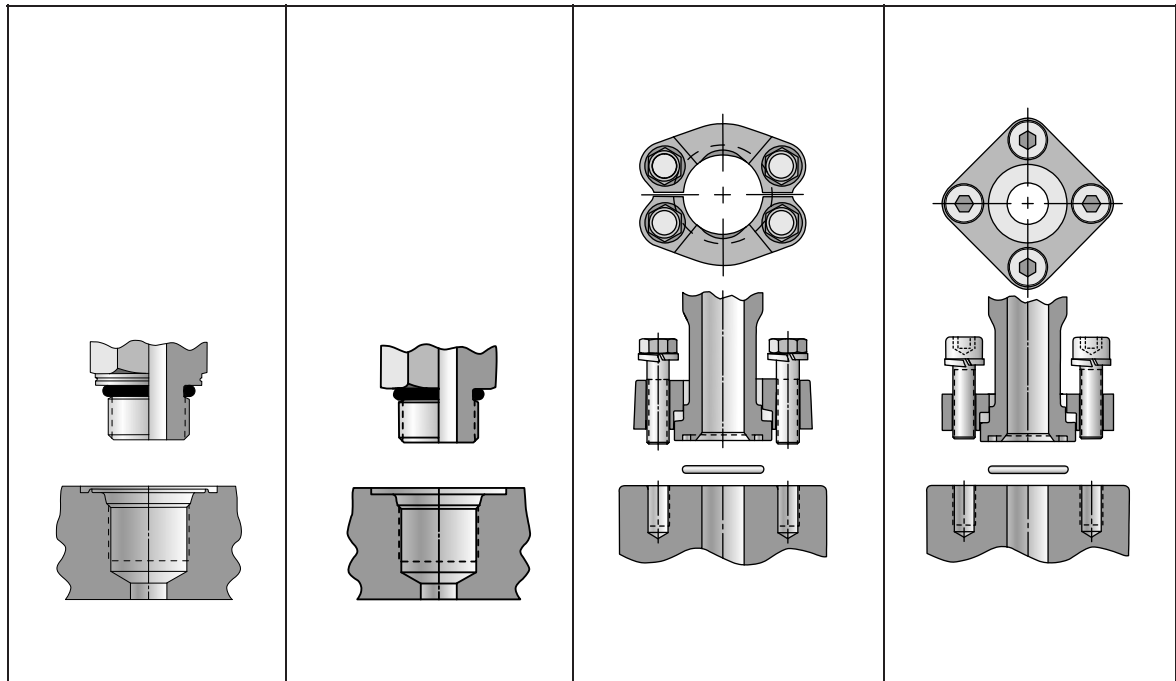

Port Description	Metric Straight Thread O-Ring Port	SAE Straight Thread O-Ring Port	Four Screw Split Flange	Four Screw One Piece Square Flange
<b>Thread Type</b>	ISO 261 Metric Fine	ISO 263 ANSI B1.1, Unified	Metric screws: ISO 261 Inch screws: ISO 263	ISO 261
<b>ISO No.</b>	6149	11926	6162	6164
<b>SAE No.</b>	J2244	J1926	J518	—
<b>DIN No.</b>	3852-3 Form "W"	—	—	—
<b>JIS No.</b>	—	—	B8363 (covers flange head only)	—
<b>BSI No.</b>	—	—	—	—
<b>Current use</b>	Gaining use in U.S. and western Europe. Widely used in former Soviet block countries.	Widely used in North America.	Widely used throughout the world.	Mainly used in Germany. Limited use elsewhere.

Table S32 — Port End Connections

## Port End Connections

### Threads, Conformance Specifications, and Use

TABLE  
OF  
CONTENTS

SECTION  
TABLE OF  
CONTENTS

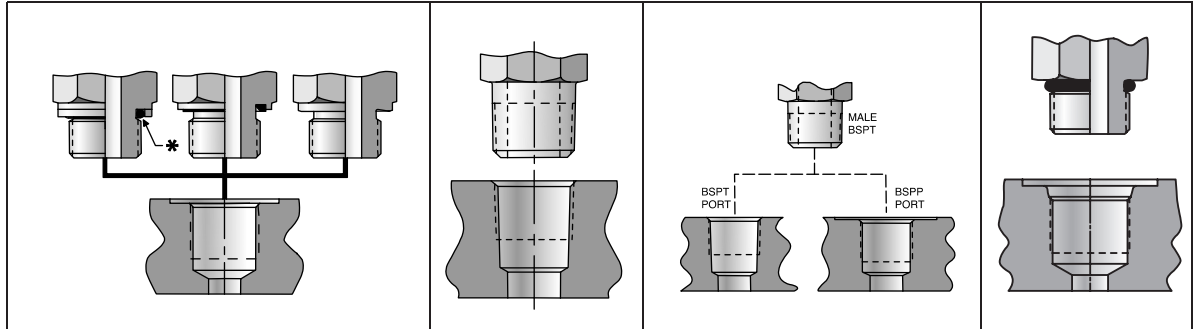

Port Description	British Standard Pipe Parallel (BSPP) Flat Face Port	Metric Straight Thread Flat Face Port	NPTF - Dryseal American Standard Taper Pipe	JIS/BSPT British Standard Pipe, Taper	JIS/BSPP British Standard Pipe, Parallel O-ring Port
Thread Type	ISO 228-1 BS 2779	ISO 261 Metric Fine	ANSI B1.20.3	ISO 7 BS 21 JIS B 0203	ISO 228-1 BS 2779 JIS B 0202
ISO No.	1179	9974	—	—	—
SAE No.	—	—	J476	—	—
DIN No.	3852-2 Form X or Y	3852-1 Form X or Y	—	Similar to: 3852-2 form Z	—
JIS No.	—	—	—	B8363	B2351 Type "O"
BSI No.	—	—	—	—	Similar to BS 5380
Current use	Most popular in western Europe and former UK colonies. Limited use in rest of the world.	Moderate use in Europe, mainly in Germany.	Mainly used in North America some use in rest of the world.	Mainly used in Japan and parts of western Europe.	Mainly used in Japan. Some use in U.K. of similar port, BS5380.

Table S33 — Port End Connections

## Fitting Materials

TABLE  
OF  
CONTENTS

SECTION  
TABLE OF  
CONTENTS

Material				Product Type				
Type	Condition	Standard	Grade	Seal-Lok, Triple-Lok, Ferulok, Pipe, Port Adapters, JIS, Komatsu, Flanges				
				Body	Nut	Sleeve	Ferrule	Welding Parts
Steel <sup>1)</sup>	Bar Stock	ASTM A108	12L14	•	•	•	•	
		ASTM A108	1215	•	•	•	•	
		ASTM A108	C1045	•	•	•		
		ASTM A108	C1018		•			•
	Cold Form	ASTM A576	C1008	•	•	•		
		ASTM A576	C1010	•	•	•		
		ASTM A576	C1012	•	•	•		
		ASTM A576	C1020			•		
	Forging	ASTM A576	1214	•				
		ASTM A576	1215	•				
ASTM A576		C1045	•	•				
Stainless Steel <sup>2)</sup>	Bar Stock	ASTM A479	316	•	•	•		
		ASTM A479	316L	•	•	•		•
		ASTM A564	630				•	
	Cold Form	ASTM A479	316	•	•	•		
		ASTM A479	316L	•	•	•		•
	Forging	ASTM A182	316	•	•			
		ASTM A182	316L	•	•			•
Brass <sup>3)</sup>	Bar Stock	ASTM B16	CA360	•	•	•	•	
		ASTM B453	CA345	•	•			
		ASTM B371	CA694			•		
	Cold Form	ASTM B121	CA335	•	•			
		ASTM B111	CA443			•		
		ASTM B111	CA444			•		
	Forging	ASTM B124	CA377	•	•			
Aluminum	Bar Stock	ASTM B211	2024-T351	•	•	•		
		ASTM B211	6061-T6	•	•	•		
	Forging	AMS 4133	2014-T6	•				

**Table S34 — Standard Material Specifications**

- <sup>1)</sup> Standard steel products have silver/clear zinc chromium 6 free or grey zinc nickel plating. Brazing and welding products are not plated.  
<sup>2)</sup> Stainless steel fittings are passivated. Standard stainless steel nuts are coated to prevent galling during assembly.  
<sup>3)</sup> Brass is not available for Ferulok.

Material					Product Type		
Type	Condition	Standard	Grade	U.S. Equivalent grade	EO, EO2, K4		
					Body	Nut	Welding Parts
Steel <sup>1)</sup>	Bar Stock	DIN EN 10277-3	1.0718	12L14	•		
		DIN EN 10277-3	1.0715	1213/1215	•		
		DIN EN 10277-3	1.0727	1146	•		
		DIN EN 10277-3	1.0401	C1015			•
	Cold Form	DIN EN 10263	1.0214	C1010		•	
	Forging	DIN 1651	1.0710		•		
		DIN EN 10087	1.0764		•		
DIN EN 10083		1.0503	C1045 modified		•		
Stainless Steel	Bar Stock	DIN EN 10088	1.4571	316Ti	•	•	•
	Forging	DIN EN 10088	1.4571	316Ti	•	•	•
Brass	Bar Stock	DIN 17660	2.0540		•	•	
	Forging	DIN 17660	2.0540		•		

- <sup>1)</sup> Standard steel products have silver/clear zinc chromium 6 free or grey zinc nickel plating. Brazing and welding products are not plated.

**Table S35 — Standard Material Specifications for EO and K4 Product**

## Fitting Designs:

Parker's tube fittings and adapters meets the following industrial standards:

Fitting Family	Specifications
Seal-Lok ORFS	SAE J1453 ISO 8434-3
Triple-Lok 37-Degree Flare	SAE J514 ISO 8434-2
Ferulok Flareless	SAE J514
EO and EO-2 Metric Flareless	ISO 8434-1
	ISO 8434-4
	DIN 3861
	DIN 3865 DIN 3859
Flange Adapters and Hydraulic Flanges	SAE J518
	ISO 6162
	ISO 6164
JIS Adapters	JIS B8363 (with some exceptions)
K4 Adapters	ISO 8434-6 BS 5200
Pipe Fittings and Adapters, and Swivels	SAE J514
Pipe Plugs	SAE J531
Straight Thread Plugs	SAE J1926

### Fitting Performance:

Many Parker tube fittings meet various performance standards recognized by diverse organizations, among which are:

- American Bureau of Shipping (ABS)
- American National Standards Institute (ANSI)
- American Society of Mechanical Engineers (ASME)
- Canadian Technical Standards and Safety Registration (CRN)
- China Classification Society (CCS)
- Det Norske Veritas (DNV)
- Deutscher Verein des Gas- und Wasserfaches (DVGW)
- Germanischer Lloyd (GL)
- Lloyds Register of Shipping (LR)
- Russian Maritime Register of Shipping (RMS)

### Attention:

Performance Type Approvals usually are limited to certain products, applications, working conditions, validity time or other restrictions. Please contact Tube Fittings Division for detailed information.

TABLE  
OF  
CONTENTS

SECTION  
TABLE OF  
CONTENTS

Surface Finish Type	Specification
Carbon Steel – Chromium 6 Free Zinc Plating	ASTM B633 Class Fe/Zn 8 Type V, JIS H8610 Grade 3
Carbon Steel – Zinc Nickel Plating	ASTM B841 Class 2, Type AN/E, Grade 8
Stainless Steel - Passivation	ASTM A967, ASTM A380

Test Methods	Specification
Leak, Proof, Burst, Impulse, Over-Torque, Vacuum, and Repeated Assembly	ISO 19879
Rotary Flexure Vibration	NFPA T3.8.3, ISO 19879, ISO 7257

**Table S36— Conformance Standards**

Some parts do not meet dimensional requirements.



# How to Order Seal-Lok, Triple-Lok, Ferulok, JIS and K4

## TFD Standard Nomenclature Construction

Box 1	Box 2	Box 3	Box 4	Box 5	Box 6
Size	Shape or Style	Sub-Style	Type	Material	Plating Options
1 to 4 sets of numbers from Box 1	Letter code from Box 2	Number/Letter code from Box 3	Number/Letter code from Box 4	Letter code from Box 5	Letter code from Box 6

**Example: Steel Seal-Lok Adjustable Elbow Connector — 3/8" O.D. (-6) Tube to 7/16-20 UNF (-4) ORB = 6-4 C5L-S**

(See the shading in the boxes below for the construction of this example)

Tube End		Port End		Port End	
Dash Size	Tube O.D.	Dash Size	SAE Straight Thread	Dash Size	NPTF Pipe Thread
-2	1/8	-2	5/16-24	-2	1/8
-3	3/16	-3	3/8-24	-2	1/8
-4	1/4	-4	7/16-20	-2	1/8
-5	5/16	-5	1/2-20	-2	1/8
-6	3/8	-6	9/16-18	-4	1/4
-8	1/2	-8	3/4-16	-6	3/8
-10	5/8	-10	7/8-14	-8	1/2
-12	3/4	-12	1 1/16-12	-12	3/4
-14	7/8	-14	1 3/16-12	-12	3/4
-16	1	-16	1 5/16-12	-16	1
-20	1 1/4	-20	1 5/8-12	-20	1 1/4
-24	1 1/2	-24	1 7/8-12	-24	1 1/2
-32	2	-32	2 1/2-12	-32	2

Straights	
B	Nut
F*	Male Connector
FF*	Long Male Connector or Pipe Nipple
FFF*	Extra Long Male Connector or Pipe Nipple
FN	Cap
G*	Female Connector
H	Union
HH	Long Union
HPN*	Plug, Straight Thread, Hollow Hex
LH	Large Hex Union
PN*	Plug, Straight Thread, Hex Head
T	Sleeve or Ferrule
TP	Sleeve, Parflange
TR	Tube Reducer
T22	Mountie
W	Bulkhead Union
WF	Bulkhead Male
WG	Bulkhead Female
WLN	Bulkhead Locknut for Triple-Lok, Ferulok, and Intru-Lok
WLNL	Bulkhead Locknut for Seal-Lok
90° Elbows	
C*	Male Elbow Connector
CC*	Long Male Elbow
CCC*	Extra Long Male Elbow
D	Female Elbow
E	Union Elbow
WE	Bulkhead Union Elbow
45° Elbows	
N	Union Elbow
V*	Male Elbow Connector
WN	Bulkhead Union Elbow
Tees	
J	Union Tee
M	Female Run Tee
O	Female Branch Tee
R*	Male Run Tee
S*	Male Branch Tee
WJ	Bulkhead Branch Tee
WJJ	Bulkhead Run Tee
Cross	
K	Union Cross

Connectors (a)	
3	BSPT Port End
4**	BSPP Port End, O-ring & RR
5**	SAE Straight Thread Port End
8**	Metric Port End, O-ring & RR
9	SAE-ORB with Metal Seal
42	BSPP Port End, "ED" Seal
47**	BSPP O-ring Port, B2351
82	Metric Port End, "ED" Seal
87**	ISO 6149 Port End
J4 (e)	Banjo Connection, BSPP, Soft Seal
J8 (e)	Banjo Connection, Metric, Soft Seal
Swivel Unions (b)	
6	Female Swivel
Swivel Connectors (c)	
63	BSPT Port, Swivel Connector
64**	BSPP Port, Swivel Connector
642	BSPP, "ED" Seal, Swivel Connector
65**	SAE-ORB, Swivel Connector
68**	Metric Port, Swivel Connector
682	Metric Port, Swivel Connector
687**	ISO 6149, Swivel Connector
Straight Thread Plugs (d) (Modifiers for P)	
4, 5, 8, 9 and 87 as in Connectors above.	
Notes	
a. Modifiers for Connectors as noted with asterisk in Box 2.	
b. Modifier for C, V, R, S, H, E and J in Box 2.	
c. Modifiers for F only in Box 2.	
d. Modifiers for P only in PN and HPN in Box 2.	
e. Applies to 90° elbows and tees only.	

K4	60° Cone BSPP
L**	Seal-Lok
P4	JIS 60° Cone
T4	JIS 30° Flare
U	Ferulok
X	Triple-Lok

B	Brass
CUNI	Cupro-Nickel (ex. CUNI 70/30)
D	Dural (Aluminum)
M	Monel
S	Steel w/ zinc plating
SS	Stainless Steel 316/316L passivated

ZJ	Parker XTR Plating
----	--------------------

\*\*Placing the letter "O" after these sub-style modifiers and fitting types will indicate that you would like an O-Ring on that corresponding end.

**Use Parker's FittingFinder App to easily identify the part number of the fitting or adapter you need. Download Parker FittingFinder from the App Store or Google Play, or use the web app at <https://divapps.parker.com/divapps/tfd/FittingFinder/>**

# How to Order 4-Bolt Hydraulic Flanges

## TFD Standard Nomenclature Construction

Box 1	Box 2	Box 3	Box 4	Box 5	Box 6	Box 7
Flange Size	Connection Description	Shape	Flange Connection Type	Mounting Style	Material	Kit Designation

TABLE OF CONTENTS

SECTION TABLE OF CONTENTS

### Box 1 — Port/Tube/Pipe Flange Size

Symbol	Description
One-to-two digit codes	Size in inches x 16

One code is required if end connections are the same size. Two codes are required if they are different sizes (e.g., 16-12).

### Box 2 — Port/Tube/Pipe Connection Description

Symbol	Description
B3	Braze Socket — silver braze
CP1	Connector Plate — Code 61
CP2	Connector Plate — Code 62
FCC1	Flange Clamp, Captive — Code 61
FCC2	Flange Clamp, Captive — Code 62
FCCT1	Flange Clamp, Captive with Tapped Holes — Code 61
FCCT2	Flange Clamp, Captive with Tapped Holes — Code 62
FCS1	Flange Clamp, Split — Code 61
FCS2	Flange Clamp, Split — Code 62
G	NPTF Port
G3	BSPT Port
G4	BSPP Port
G5	SAE Port
P	Plug (blanking end)
SP	Spacer w/o Gage Ports
SPG	Spacer w/ 1/4-18 NPTF Gage Port
SPG5	Spacer w/ 7/16-20 UNF Gage Port
SPGG5	Spacer w/ 1/4-18 NPTF & 7/16-20 UNF Ports
WSD1	Weld Saddle — Pipe
WSD2	Weld Saddle — Tube
W4	Flat Weld Socket — Tube
W4S	Flat Weld Socket — Tube (shallow)
W5	Flat Weld Socket — Pipe
W5S	Flat Weld Socket — Pipe (shallow)
W6	Extended Weld Socket — Tube
W6S	Extended Weld Socket — Tube (shallow)
W7	Extended Weld Socket — Pipe
W7S	Extended Weld Socket — Pipe (shallow)
WB1	Weld Butt — Schedule 40
WB3	Weld Butt — Schedule 80
WB5	Weld Butt — Schedule 160
WB7	Weld Butt — Schedule XXS
WBT	Weld Butt — Tank Pilot
WPL	Weld Plate
W	Weld Socket
W2	Weld Nipple
W3 or WB	Weld Nipple — Weld Butt, Tube

### Box 3 — Shape Description

Symbol	Description
None	Block and Pad, Straight*
E	Elbow 90°
H	Barstock, Straight
J	Tee

\*The “Block” has O-ring and drilled mounting holes, while the “Pad” has no O-ring groove and tapped mounting holes.

### Box 4 — Flange Connection Type

Symbol	Description
Q1	Code 61 Flange Head w/ O-ring Groove
Q1N	Code 61 Flange Head w/o O-ring Groove
Q2	Code 62 Flange Head w/ O-ring Groove
Q2N	Code 62 Flange Head w/o O-ring Groove
Q1B	Code 61 Flange Block w/ O-ring Groove and Drilled Mounting Holes
Q1P	Code 61 Flange Block w/o O-ring Groove and Drilled Mounting Holes
Q2B	Code 62 Flange Block w/ O-ring Groove and Drilled Mounting Holes
Q2P	Code 62 Flange Pad w/o O-ring Groove and Tapped Mounting Holes
QSB	Square Flange Block w/ O-ring Groove and Drilled Mounting Holes
QSP	Square Flange Pad w/o O-ring Groove and Tapped Mounting Holes

### Box 5 — Mounting Style

Symbol	Description
Omit	Inch Mounting Bolts (screws)
M	Metric Mounting Bolts (screws)

### Box 6 — Material

Symbol	Description
S	Steel, Zinc Plated (braze or weld parts may not be plated)
SX	Steel, Oil Dipped
SS	Stainless Steel

### Box 7 — Kit Designation

Symbol	Description
Omit	Flange Only
K	Kit (O-ring, 4 bolts and washers)

# How to Order EO and EO-2 Fittings and Accessories

TFD Standard Nomenclature Construction

TABLE OF CONTENTS

SECTION TABLE OF CONTENTS

Box 1	Box 2	Box 3	Box 4	Box 5	Box 6	Box 7	Box 8	Box 9
Shape/Style	Tube Size (mm.)	EO-2 Designator	Pressure Series	Port Size/ Designator	Port Sealing Method Modifier	Modifier 1	Material	Modifier 2

Box 1 — Shape/Style Code			
<b>Straights</b>		<b>Tees</b>	
AS	Weld Connector	EL	Swivel Nut Run
AS_/_	Weld Flange	ET	Swivel Nut Branch
BFG	Square Flange Connector	GMA1/	Union w/ Test Point, Pin
DA	Distance Adapter	GMA3/	Union w/ Test Point, M16x2
DG101/	Rotary Union	LEE	Adjustable Run
DG102/	Rotary Connector	T	Union
DG107/	Rotary Bulkhead Union	TEE	Adjustable Branch
DVGE	Plain Bearing Rotary	TH	High Pressure Banjo
EGE	Swivel Nut Connector	TR	Reducer Union
EGEO	ISO 6149 Swivel Nut Connector	WV	Alternating Valve
ESV	Weld Bulkhead Union	Cross	
G	Union	K	Union
GAI	Female Connector	Accessories	
GE	Male Connector	D	Cutting Ring
GEO	ISO 6149 Connector	DKA	Metal Seal Ring
GFS_/_	Flange Connector	DKI	Pressure Gage Seal
GR	Reducer Union	DOZ	EO-2 Seal Ring
GZ	Swivel Union	DPR	Progressive Ring
GZR	Reducer Swivel Union	E	Insert
MAV	Gage Connector	ED	EOlastic Seal
MAVE	Swivel Nut Gage Connector	FM	EO-2 Functional Nut
RED	Tube End Reducer	GM	Bulkhead Locknut
SKA	Weld Adapter	KD	Plastic Seal
SV	Bulkhead Union	KDS	Elastomeric Seal
VKA1/	Test Point Connector, Pin	M	Tube Nut
VKA3/	Test Point Connector, M16x2	OR	O-ring
<b>90° Elbows</b>		PSR	Progressive Ring (new)
BFW	Square Flange Connector	R	Tube
DG103/	Rotary Union	ROV	Plug
DG104/	Rotary Connector	VH	Insert
DG108/	Rotary Bulkhead Union	VKA	Cap
DVWE	Plain Bearing Rotary	VSTI	Hollow Hex Plug
EW	Swivel Nut	<b>Valves</b>	
SWVE	Banjo	RHD	Union Check
W	Union	RHV	Connector Check
WAS	Weld Connector	RHZ	Connector Check
WE	Male Connector	RHDI	Female Check
WEE	Adjustable	RVP	Cartridge Check
WFS_/_	Flange Connector	DV	Low Pressure Shut Off
WH	High Pressure Banjo	LD	Medium Pressure Shut Off
WSV	Bulkhead Union	VDHA	High Pressure Shut Off
<b>Double 90° Elbows</b>		VDHB	High Pressure Shut Off
DG105/	Rotary Union	KH	2-way Ball Valve
DG106/	Rotary Connector	KH3/2-	3-way Ball Valve
<b>45° Elbows</b>		WV	Alternating Union Tee
EV	Swivel Nut		
VEE	Adjustable		

Box 2 — Tube Size (mm.)
04
05
06
08
10
12
14
15
16
18
20
22
25
28
30
35
38
42

Box 3 — EO-2 Designator	
Z	EO-2 Assy.

Box 4 — Pressure Series	
LL	Very Light
L	Light
S	Heavy

Box 5 — Port Size/ Designator (optional)	
<b>Metric</b>	
M_	Metric Parallel
M_X_	Metric Parallel (Jump Size)
M_X_keg	Metric Taper
<b>NPT — Inch</b>	
1/8NPT	NPT Thread
1/4NPT	NPT Thread
3/8NPT	NPT Thread
1/2NPT	NPT Thread
3/4NPT	NPT Thread
1NPT	NPT Thread
1 1/3NPT	NPT Thread
1 1/2NPT	NPT Thread
<b>SAE-ORB</b>	
7/16UNF	Inch Parallel Thread
9/16UNF	Inch Parallel Thread
3/4UNF	Inch Parallel Thread
3/4UNF	Inch Parallel Thread
7/8UNF	Inch Parallel Thread
11/16UNF	Inch Parallel Thread
15/16UNF	Inch Parallel Thread
1 5/8UNF	Inch Parallel Thread
1 7/8UNF	
<b>BSPP/BSPT</b>	
R_	BSPP
R_/_keg	BSPT

Box 6 — Port Sealing Method Modifier (optional)	
ED	EOlastic Seal
OR	ISO 6149 O-ring
Kds	Banjo Seal Ring

Box 7 — Modifier 1 (optional)	
OMD	Without Nut and Sleeve
VIT	FPM (omitted for Stainless)
NBR	Nitrile Seals (omitted for Steel and Brass)
_ _ B	Special Cracking Pressure (check valve)

Box 8 — Material	
CF	Chromium 6 Free
MS	Brass
71	Stainless Steel
VZ	Zinc Plated (tube only)

Box 9 — Modifier 2 (optional)	
X	Unassembled



T

# APPENDIX

## Table of Contents



<i>Applicable Standards For TFD Products by Standard Number.....</i>	<i>T3</i>
<i>Thread Designations and Standards for Threads Used in Fluid Connectors .....</i>	<i>T4</i>
<i>Document Sources for Connector Specifications.....</i>	<i>T5</i>
<i>Helpful Information.....</i>	<i>T6</i>
<i>Glossary of Key Tube Fittings, Fluid Power and Other Engineering Terms .....</i>	<i>T8</i>



## Applicable Standards For TFD Products by Standard Number

ASTM A269	Seamless and welded type 316 Stainless Steel tubing	NFPA T3.8.3 <sup>2)</sup>	Test methods for steel separable tube fittings
ASTM B633	Zinc plating	SAE J343	Tests and procedures for hose and hose assemblies (impulse test applies to fittings)
ASTM F1387	Mechanically attached fittings — Triple-Lok, Ferulok and Seal-Lok	SAE J356	Welded and flash controlled low carbon steel tubing
DIN 2353	24° cone compression (bite-type) fitting range (configurations)	SAE J512	Automotive tube fittings - 45° flare type - Inverted flare type
DIN 3852-1	Metric parallel thread port (ISO 9974-1)	SAE J514	Hydraulic tube fittings - 37° flare (Triple-Lok) - Flareless — 24° bite type (Ferulok) - O-ring plugs - Pipe fittings - Adapter unions (pipe swivel — “07” adapters)
DIN 3852-2	BSPP parallel thread port (ISO 1179-1)	SAE J515	Hydraulic O-rings (SAE straight thread, face seal, four-bolt split flange, and metric O-ring port)
DIN 3852-3	Metric O-ring port (ISO 6149-1)	SAE J518	Code 61 and 62 four-bolt split flange connections — (same as ISO 6162 Type II flange connection)
DIN 3861	24° cone machining and sleeve for compression (bite-type) fittings	SAE J524	Seamless low carbon steel tubing
DIN 3865	24° cone nipple with O-ring	SAE J525	Welded and cold drawn low carbon steel tubing
DIN 3859	Technical delivery conditions for compression fittings	SAE J527	Brazed double wall steel tubing
DIN 1630	Seamless steel tube	SAE J528	Seamless copper tube
DIN 2391	Seamless precision steel tubes	SAE J531	Automotive pipe, filler and drain plugs (HP and HHP plugs)
DIN 17458	Stainless steel tubes	SAE J533	Flares for tubing — 37° and 45° single and double flares
ISO 1179	BSPP, flat face port and stud ends — same as DIN 3852 - Part 2	SAE J846	Coding system for identification of fluid connectors
ISO 3304	Seamless precision steel tubes	SAE J1065	Pressure ratings for hydraulic tubing
ISO 3305	Welded precision steel tubes	SAE J1231	Beaded tube hose fittings
ISO 6149	Metric straight thread O-ring port and stud ends — same as SAE J2244 and DIN 3852, Part 3	SAE J1453	O-ring face seal fitting with SAE port end — (Seal-Lok)
ISO 6162	Four bolt split flange connections — inch and metric bolts (inch bolt, Part II — same as SAE J518)	SAE J1644	Test methods for fluid connectors
ISO 8434-1	24° cone bite type fittings (EO fittings)	SAE J1926	SAE straight thread O-ring port and stud ends — same as ISO 11926
ISO 8434-2	Metric 37° flare fittings (Metric Triple-Lok)	SAE J2244	Metric straight thread O-ring port and stud ends — same as ISO 6149
ISO 8434-3	Metric face seal fitting with ISO 6149 port end — (Metric Seal-Lok)	SAE J2435	Welded and flash controlled C-1021 tubing
ISO 8434-4	24° cone bite type fittings with weld nipple (EO Fittings)	SAE J2467	Welded and cold drawn, C-1021 tubing
ISO 19879	Test methods for threaded fluid connectors	SAE J2613	Welded and flash controlled high strength low alloy (HSLA) tubing
ISO 8434-6	60° cone connectors with BSPP threads	SAE J2614	Welded and cold drawn HSLA tubing
ISO 9974	Metric flat face port and stud ends — same as DIN 3852 - Part 1		
JIS B8363	60° cone (male and female) hose adapters		
MIL-16142	UN/UNF straight thread O-ring port — same as SAE J1926-1		
MIL-F-18866	37° flare and flareless tube fittings — Triple-Lok and Ferulok (dimensionally similar to SAE J514)		
MIL-33649	Straight thread O-ring port — <b>different from SAE J1926-1</b>		

Table T1 — Applicable Standards by Standard Number

Dimensions and pressures for reference only, subject to change.

## Thread Designations and Standards for Threads Used in Fluid Connectors

Abbreviation	Description	Applicable Std.
<b>Straight Pipe</b>		
NPSC	American Standard Straight Pipe Threads in Pipe Couplings Couplings	ANSI B1.20.1 FED-STD-H28/7
NPSF	Dryseal American Standard Fuel Internal Straight Pipe Threads (generally used in soft or ductile materials to mate with NPTF external taper threads)	SAE J476 ANSI B1.20.3 FED-STD-H28/8
NPSI	Dryseal American Intermediate Internal Straight Pipe Threads (for brittle or hard materials; intended to mate with PTF-SAE short external taper threads)	SAE J476 ANSI B1.20.3 FED-STD-H28/8
NPSM	American Standard Straight Pipe Threads for Free-Fitting Mechanical Joints for Fixtures (these threads fit freely over NPTF threads. They are used in swivel nuts of 07 adapters)	ANSI B1.20.1 FED-STD-H28/7
<b>Taper Pipe</b>		
ANPT	Aeronautical National Taper Pipe Threads (similar to NPT with various additional requirements in gaging)	MIL-P-7105
NPT	American Standard Taper Pipe Threads for General Use	ANSI B1.20.1 FED-STD-H28/7
NPTF	Dryseal American Standard Taper Pipe Threads (used in all of our steel and brass fittings)	SAE J476 ANSI B1.20.3 FED-STD-H28/8
PTF — SAE Short	Dryseal SAE Short Taper Pipe Threads (mainly used in low pressure pneumatic and fuel applications)	SAE J476 ANSI B1.20.3 FED-STD-H28/8
PTF — SPL Short <sup>1)</sup>	Dryseal Special Short Taper Pipe Threads	ANSI B1.20.3
PTF — SPL Extra Short <sup>1)</sup>	Dryseal Special Extra Short Taper Pipe Threads	ANSI B1.20.3
<b>Unified Threads</b>		
UN	Unified Constant Pitch Threads (standard series: 4, 6, 8, 12, 16, 20, 28, 32)	ANSI B1.1 FED-STD-H28/2
UNC	Unified Coarse Threads	ANSI B1.1 FED-STD-H28/2
UNEF	Unified Extra Fine Threads	ANSI B1.1 FED-STD-H28/2
UNF	Unified Fine Threads	ANSI B1.1 FED-STD-H28/2
UNS	Unified Special Pitch Threads	ANSI B1.1 FED-STD-H28/3
UNJ	Unified Controlled Root Radius Threads	ANSI B1.15 FED-STD-H28/4

Table T2— Thread Designations and Standards for Threads Used in Fluid Connectors (continued on the next page)

1) Used in some pneumatic components where shortened thread depth is required because of lack of enough material due to component size limitations.

## Thread Designations and Standards for Threads Used in Fluid Connectors (Continued)

Abbreviation	Description	Applicable Std.
<b>Metric Threads</b>		
M	Metric Screw Threads — M profile	ISO 261 ANSI B1.13M FED-STD-H28/21
M — Keg	Metric Taper Threads (mainly used in Germany)	DIN 158
<b>British Standard Pipe Threads</b>		
R (BSPT)	British Standard Taper Pipe Threads, External	BS 21 ISO 7/1
Rc (BSPT)	British Standard Taper Pipe Threads, Internal	BS 21 ISO 7/1
Rp or G (BSPP)	British Standard Pipe (Parallel) Threads	BS 2779 ISO 228/1
<b>Japanese Standard Pipe Threads</b>		
PF <sup>1)</sup>	JIS Parallel Pipe Threads	JIS B202 ISO 228/1
PT <sup>1)</sup>	JIS Taper Pipe Threads	JIS B203 ISO 7/1
PS	JIS Parallel Internal Pipe Threads (to mate with PT threads)	JIS B203

Table T2 (Cont'd) — Thread Designations and Standards for Threads Used in Fluid Connectors

1) PF and PT threads are functionally interchangeable with BSPP and BSPT threads, respectively. These are old designations. They are being replaced with G (for PF) and R and Rc (for PT) as documents are revised.

## Document Sources for Connector Specifications

**ANSI** American National Standards Institute  
11 West 42nd Street, 13th Floor  
New York, New York 10036-8002  
Phone: 212-642-4900  
Fax: 212-398-0023  
[www.ansi.org/public/std\\_info.html](http://www.ansi.org/public/std_info.html)

**BSI** British Standards Institution  
389 Chiswick High Road  
London, W4 4AL  
United Kingdom  
Phone: 44-181-996-9000  
Fax: 44-181-996-7400  
[www.bsi.org.uk/bsis/index.htm](http://www.bsi.org.uk/bsis/index.htm)

British Standards are also available from ANSI

**DIN** Deutsches Institut Fur Normung  
(German Institute for Standards)  
Burggrafenstrasse 6  
Postfach 1107  
D - 1000 Berlin 30, Germany  
[www.beuth.de/beuth.htm/?datenbanken](http://www.beuth.de/beuth.htm/?datenbanken)

English translations of some German Standards can be obtained from:

**ANSI**  
— or —

**Global Engineering Documents**  
15 Inverness Way East  
Englewood, CO 80112-9660  
Phone: 1-800-854-7179

**FED-STD** Federal Standard  
Department of Defense Single Stock Point  
Commanding Officer  
Naval Publications and Forms Center  
5801 Taber Avenue  
Philadelphia, PA 19120-5099

**ISO** International Organization for Standardization  
Case Postale 56  
1, Rue de Varembe  
CH - 1211 Geneve 20  
Switzerland  
[www.iso.ch/infoe/catinfo.html](http://www.iso.ch/infoe/catinfo.html)

**ISO Documents are also available from ANSI**

**JIS** Japanese Industrial Standards  
Published by Japanese Standards Association  
1-24 Akasaka 4  
Minto-ku, Tokyo 107-8440  
Japan  
Phone: 81-3-3583-8000  
Fax: 81-3-3586-2014

English translations of some Japanese Standards can be obtained from ANSI

**SAE** SAE International  
400 Commonwealth Drive  
Warrendale, PA 15096-0001  
Phone: 412-776-4841  
Fax: 412-776-0002  
[www.sae.org/prodserv/stds/stdsinfo/standard.html](http://www.sae.org/prodserv/stds/stdsinfo/standard.html)

SI Prefixes		
Prefix	SI Symbol	Multiplication Factor
tera	T	10 <sup>12</sup>
giga	G	10 <sup>9</sup>
mega	M	10 <sup>6</sup>
kilo	k	10 <sup>3</sup>
hecto	h	10 <sup>2</sup>
deka	da	10 <sup>1</sup>
deci	d	10 <sup>-1</sup>
centi	c	10 <sup>-2</sup>
milli	m	10 <sup>-3</sup>
micro	μ	10 <sup>-6</sup>
nano	n	10 <sup>-9</sup>
pico	p	10 <sup>-12</sup>
femto	f	10 <sup>-15</sup>
atto	a	10 <sup>-18</sup>

Table T3 — SI Prefixes

Derived Units			
Quantity	Unit	SI Symbol	Formula
Acceleration	Meter per Second Squared	—	m/s <sup>2</sup>
Angular Velocity	Radian per Second	—	rad/s
Area	Square Meter	—	m <sup>2</sup>
Density	Kilogram per Cubic Meter	—	kg/m <sup>3</sup>
Electric Resistance	Ohm	W	V/A
Energy & Work	Joule	J	N.m
Force	Newton	N	kg.m/s <sup>2</sup>
Frequency	Hertz	Hz	cycles/s
Power	Watt	W	J/s
Pressure & Stress	Pascal	Pa	N/m <sup>2</sup>
Quantity of Heat	Joule	J	N.m
Specific Heat	Joule per Kilogram-Kelvin	—	J/kg.K
Thermal Conductivity	Watt per Meter-Kelvin	—	W/m.K
Velocity	Meter per second	—	m/s
Viscosity, Dynamic	Pascal Second	—	Pa.s
Viscosity, Kinematic	Square Meter per Second	—	m <sup>2</sup> /s
Voltage	Volt	V	W/A
Volume	Cubic Meter	—	m <sup>3</sup>

Table T4 — Derived Units

Basic Units		
Quantity	Unit	SI Symbol
Length	Meter	m
Mass	Kilogram	kg
Time	Second	s
Electric Current	Ampere	A
Thermodynamic Temperature	Kelvin	K
Amount of Substance	Mole	mol
Luminous Intensity	Candela	cd

Table T5 — Basic Units

Supplementary Units		
Quantity	Unit	SI Symbol
Plane Angle	Radian	rad
Solid Angle	Steradian	sr

Table T6 — Supplementary Units

	English to Metric			Metric to English		
	To Convert From	To	Multiply By	To Convert From	To	Multiply By
Area	sq. in. (in <sup>2</sup> )	sq. mm (mm <sup>2</sup> )	645.16	square millimeters (mm <sup>2</sup> )	square inches (in <sup>2</sup> )	0.00155
	sq. in. (in <sup>2</sup> )	sq. cm (cm <sup>2</sup> )	6.4516			
	sq. ft. (ft <sup>2</sup> )	sq. meters (m <sup>2</sup> )	0.0929			
Density	pounds/cubic ft (lb/ft <sup>3</sup> )	Kilograms/cubic meter (kg/m <sup>3</sup> )	16.02	kilograms/cubic meter (kg/m <sup>3</sup> )	pounds/cubic ft (lb/ft <sup>3</sup> )	0.0624
	British thermal units (Btu) (1 J = Ws = 0.2388 cal)	joules (J)	1055	joules (J)	British thermal units (Btu)	0.000947
Force	pounds - force (lbf) (1N = 0.102 kgf)	newtons (N)	4.448	newtons (N)	pounds - force (lbf)	0.2248
	inches (in) feet (ft) miles (mi)	millimeters (mm) meters (m) kilometers (km)	25.4 0.3048 1.609	millimeters (mm) meters (m) kilometers (km)	inches (in) feet (ft) miles (mi)	0.03937 3.281 0.621
Mass (Weight)	ounces (oz)	grams (g)	28.35	grams (g)	ounces (oz)	0.035
	pounds-mass (lb)	kilograms (kg)	0.4536	kilograms (kg)	pounds-mass (lb)	2.205
	short tons (2000 lb) (tn)	metric tons (1000 kg) (t)	0.9072	metric tons (1000 kg) (t)	short tons (2000 lb) (tn)	1.102
	horsepower (550 ft. lb/s) (hp)	kilowatts (kW)	0.7457	kilowatts (kW)	horsepower (550 ft. lb/s) (hp)	1.341
Pressure	pounds/square inch (psi)	kilograms (f)/square cm (kg (f)/cm <sup>2</sup> )	0.0703	kilograms (f)/square cm (kg (f)/cm <sup>2</sup> )	pounds/square inch (psi)	14.22
	pounds/square inch (psi)	kilopascals (kPa)	6.8948	kilopascals (kPa)	pounds/square inch (psi)	0.145
	pounds/square inch (psi)	bars (100 kPa)	0.06895	bars (100 kPa)	pounds/square inch (psi)	14.503
Stress	pounds/square inch (psi) (1 N/mm <sup>2</sup> = 1 MPa)	megapascals (MPa)	0.006895	megapascals (MPa) (1 N/mm <sup>2</sup> = 1 MPa)	pounds/square inch (psi)	145.039
	degrees fahrenheit (°F)	degrees celsius (°C)	5/9 (after subtracting 32)	degrees celsius (°C)	degrees fahrenheit (°F)	9/5 (then add 32)
Torque or Bending Moment	pounds-force-foot (lb-ft)	Newtons-meter (Nm)	1.3567	Newtons-meter (Nm)	pounds-force-foot (lb-ft)	0.737
	pounds-force-inch (lb-in)	Newtons-meter (Nm)	0.113	Newtons-meter (Nm)	pounds-force-inch (lb-in)	8.85
Velocity	feet/second (ft/s)	meters/second (m/s)	0.3048	meters/second (m/s)	feet/second (ft/s)	3.2808
	dynamic (centipoise)	pascal-second (Pas)	0.001	pascal-second (Pas)	dynamic (centipoise)	1000
Viscosity	kenematic-foot <sup>2</sup> /sec (ft <sup>2</sup> /s)	meter <sup>2</sup> /sec (m <sup>2</sup> /s)	0.0929	meter <sup>2</sup> /sec (m <sup>2</sup> /s)	foot <sup>2</sup> /sec (ft <sup>2</sup> /s)	10.7643
	cubic inch (in <sup>3</sup> )	cubic centimeter (cm <sup>3</sup> ) (milliliter)	16.3871	cubic centimeter (cm <sup>3</sup> ) (milliliter)	cubic inch (in <sup>3</sup> )	0.061
Volume	quarts (qt)	liters (1000 cm <sup>3</sup> )	0.9464	liters (1000 cm <sup>3</sup> )	quarts (qt)	1.057
	gallons (gal)	liters	3.7854	liters	gallons (gal)	0.2642

Table T7 — English to Metric and Metric to English Conversions



## Glossary of Key Tube Fittings, Fluid Power and Other Engineering Terms

**Alloy:** A substance having metallic properties and composed of two or more chemical elements of which at least one is a metal.

**Annealing:** Heat treating process used primarily to soften metals or to stabilize their structures.

**Boss:** A relatively short protrusion or projection from the surface of a forging or casting, often cylindrical in shape.

**Brass:** An alloy consisting mainly of copper (over 50%) and zinc, to which smaller amounts of other elements may be added.

**Braze 505:** Braze 505 is a trademark of the Handy & Harman Company.

**Brazing:** The joining of metals through the use of heat and capillary flow of a filler metal. The filler metal having a melting temperature above 840 degrees Fahrenheit, but below the melting point of the metals being joined.

**Bright Annealing:** Annealing in a protective atmosphere to prevent discoloration of the bright surface.

**Brinell Hardness Test:** A test for determining the hardness of a material by forcing a hard steel or carbide ball of specified diameter into it under a specified load.

**Brittle Fracture:** A fracture which is accompanied by little or no plastic deformation.

**Brittleness:** The quality of a material that leads to crack propagation without appreciable plastic deformation.

**Bulk Modulus:** The measure of resistance to compressibility of a fluid. It is the reciprocal of the compressibility.

**Burnishing:** Smoothing surfaces of a work piece through frictional contact between it and some hardened tooling.

**Carbonitriding:** A case hardening process of suitable ferrous material that is effected by the simultaneous absorption of nitrogen and carbon into the surface of the work piece, by heating above the lower transformation temperature in a suitable gaseous atmosphere.

**Cavitation:** A localized gaseous condition within a liquid stream which occurs when the pressure is reduced to the vapor pressure. Generally occurs in pumps and suction lines where fluid velocity is too high due to poorly sized (too small) line size.

**Chatter:** The undesirable wavy surface on a machined surface, produced by vibration of the tool, grinding wheel or work piece itself during machining or grinding.

**Chromate Treatment:** A treatment of metal in a solution of a hexavalent chromium compound to produce a conversion coating of chromium compounds on the surface of the metal, thus improving the resistance to corrosion.

**Cold Heading:** Working metal at room temperature in such a manner that the cross-sectional area of a portion or all of the stock is increased.

**Cold Working (Cold Forming):** Permanently deforming metal, usually at room temperature, by the application of an external force in order to produce a near net shape component.

**Compressibility:** The change in volume of a unit volume of a fluid when subjected to a unit change in pressure.

**Corrosion:** The deterioration of a metal by chemical or electrochemical reaction with its environment.

**Creep:** Time dependent strain occurring under stress. This phenomenon may result in relaxation i.e. the relief of pre-load/pre-stress in assembled components.

**Crimping:** A swaging and squeezing operation usually used to secure components, such as, nuts and shells to their mating parts.

**Deburring:** Removing burrs, sharp edges or fins from metal parts usually by filing, grinding or tumbling the work in a barrel containing suitable liquid medium and abrasives.

**Density:** Ratio of the mass of an object (including fluids) to its volume.

**Diamond Pyramid Hardness Test (DPH):** An indentation hardness test employing a 136° diamond pyramid indenter and variable loads.

**Ductility:** The ability of a metal to deform plastically (permanently) without fracturing.

**Dynamic Pressure Rating:** See PRESSURE, RATED DYNAMIC.

**Easy Flo 45:** Easy Flo 45 is a trademark of the Handy & Harman Company.

**Elastic Deformation:** Change of dimensions accompanying stress in the elastic range, original dimensions being restored upon release of stress.

**Elastomer:** Often referred to as rubber, is a high polymer that can be, or has been modified to a state exhibiting little plastic flow and quick recovery from an extending force.

**Erosion:** Destruction of metals or other materials by the abrasive action of moving fluids, or particles.

**Extrusion:** Conversion of an ingot slug or billet into lengths of uniform cross section by plastically forcing the metal through a die orifice having the desired cross sectional profile.

**Fatigue/Endurance Limit:** The maximum stress below which a material can presumably endure an infinite number of stress cycles.

**Fatigue Fracture:** The initiation of minute cracks, propagating into ultimate fracture under the application of repeated or fluctuating stresses having a maximum value less than the tensile strength of the material.

**Ferrous Metal:** A metal in which the major constituent is iron.

**Fire Point:** The temperature to which a fluid must be heated to *ignite* and *burn* for at least five seconds in the presence of air when a small flame is applied.

**Fitting:** A connector or closure for fluid power lines and passages.

**Flare Test:** A test applied to tubing, involving a tapered expansion over a cone, in order to verify tube ductility and resistance to cracking during flaring operation.

**Flaring:** Forming an outward acute-angle flange on a tubular part.

**Flash Point:** The temperature to which a liquid must be heated to form a mixture with air that can be ignited *momentarily* by a flame.

**Flow:** Movement of fluid generated by pressure differences.

**Flow, Laminar:** A flow situation in which fluid moves in parallel lamina or streamlined layers.

**Flow Lines:** A fiber pattern, frequently observed in wrought metal, which indicates the manner in which the metal flowed during forming.

**Flow Rate:** The volume, mass or weight of a fluid passing through any conductor per unit of time.

**Flow, Turbulent:** A flow situation in which the fluid particles move in a random fluctuation manner. This is generally caused by too high fluid velocity.

**Fluid Friction:** Friction due to the viscosity of the fluid.

**Fluid Power System:** A system that transmits and controls power through the use of a pressurized fluid within an enclosed circuit.

**Fluorocarbon Rubber:** An elastomeric material which is extensively used for O-ring. Fluorocarbon (Viton) is recommended for higher temperatures than nitrile (Buna N) material.

**Flux:** In brazing, cutting, soldering or welding, material used to dissolve or facilitate the removal of oxides and other undesirable substances.

**Folds:** Defects in metals, usually on or near the surface caused by continued fabrication of overlapping surfaces.

**Forgeability:** Term used to describe the relative ability of materials to deform without rupture.

**Forging:** Plastically deforming metal, usually hot, into desired shapes with compressive force, with or without dies.

**Forging Die:** A forging whose shape is determined by impressions in specially prepared dies.

**Free Machining:** Denotes the machining characteristics of an alloy to which one or more ingredients have been introduced to produce small broken chips, lower power consumption, better surface finish and longer tool life.

**Galling:** Localized welding on mating surfaces of metal parts caused from excessive friction developed during the rubbing action that occurs during assembly.

**Galvanic Corrosion:** Corrosion resulting from the placing of two dissimilar metals in direct contact with each other then exposing them to an incompatible fluid or atmosphere.

**Hammer, Liquid:** Pressure and depression waves created by relatively rapid flow changes and transmitted through the system.

**Handy Flux:** Handy Flux is a trademark of the Handy & Harman Company.

**Hardening:** Increasing the hardness of a material by suitable treatment, usually involving heating and rapid cooling.

**Hardness:** Resistance of a material to scratching, abrasion, cutting or deformation.

**Head, Pressure:** The pressure due to the height of a column or body of fluid.

**Heading:** See COLD HEADING.

**Hot Finishing/Hot Forming:** A deformation operation performed at elevated temperature, usually above the recrystallization temperature of the metal.

**Hydraulic Power:** Power derived from flow rate and pressure differential of the fluid.

**Hydraulics:** Engineering science pertaining to liquid pressure and flow.

**Hydrogen Embrittlement:** A condition of low ductility in metals resulting from the absorption of hydrogen.

**Hydropneumatics:** Engineering science pertaining to the combination of hydraulic and pneumatic fluid power.

**Impact Test:** A single blow to determine the behavior of materials when subjected to high rates of loading, usually sudden and in the bending, tension or torsion mode. Charpy or Izod tests are typically used to measure materials' impact energy characteristics.

**Inclusions:** Nonmetallic materials in solid metallic matrix.

**Intergranular Corrosion:** A preferential corrosive attack at the grain boundaries of a metal.

**LB2000:** Registered Trademark of ITW.

**Lubricant:** Any substance used to reduce friction between two surfaces which are in contact.

**MPG 2:** Registered Trademark of Dubois Chemical Inc.

**Machinability:** The relative ease of machining a metal.

**Machining:** Removing material, in the form of chips, from work, usually through the use of a machine.

**Malleability:** The characteristic of metals that permits plastic deformation in compression without rupture.

**Mandrel:** (1) A metal bar around which other metal may be cast bent, formed, or shaped. (2) A rod used to retain the cavity in hollow metal products during working.

**Mechanical Properties:** The properties of a material that reveal its elastic and inelastic behavior under the application of force, thus indicating the material's suitability for mechanical applications. Examples of such properties are: tensile strength, elongation, modulus of elasticity, yield strength, reduction in area and fatigue limit.

**Microhardness:** The hardness of microscopic areas or of the individual microconstituents in a metal.

**Microstructure:** The structure of polished and etched metals as revealed by a microscope at a magnification greater than ten diameters.

**Fitting:** A connector or closure for fluid power lines and passages.

**Flare Test:** A test applied to tubing, involving a tapered expansion over a cone, in order to verify tube ductility and resistance to cracking during flaring operation.

**Flaring:** Forming an outward acute-angle flange on a tubular part.

**Flash Point:** The temperature to which a liquid must be heated to form a mixture with air that can be ignited *momentarily* by a flame.

**Flow:** Movement of fluid generated by pressure differences.

**Flow, Laminar:** A flow situation in which fluid moves in parallel lamina or streamlined layers.

**Flow Lines:** A fiber pattern, frequently observed in wrought metal, which indicates the manner in which the metal flowed during forming.

**Flow Rate:** The volume, mass or weight of a fluid passing through any conductor per unit of time.

**Flow, Turbulent:** A flow situation in which the fluid particles move in a random fluctuation manner. This is generally caused by too high fluid velocity.

**Fluid Friction:** Friction due to the viscosity of the fluid.

**Fluid Power System:** A system that transmits and controls power through the use of a pressurized fluid within an enclosed circuit.

**Fluorocarbon Rubber:** An elastomeric material which is extensively used for O-ring. Fluorocarbon (Viton) is recommended for higher temperatures than nitrile (Buna N) material.

**Flux:** In brazing, cutting, soldering or welding, material used to dissolve or facilitate the removal of oxides and other undesirable substances.

**Folds:** Defects in metals, usually on or near the surface caused by continued fabrication of overlapping surfaces.

**Forgeability:** Term used to describe the relative ability of materials to deform without rupture.

**Forging:** Plastically deforming metal, usually hot, into desired shapes with compressive force, with or without dies.

**Forging Die:** A forging whose shape is determined by impressions in specially prepared dies.

**Free Machining:** Denotes the machining characteristics of an alloy to which one or more ingredients have been introduced to produce small broken chips, lower power consumption, better surface finish and longer tool life.

**Galling:** Localized welding on mating surfaces of metal parts caused from excessive friction developed during the rubbing action that occurs during assembly.

**Galvanic Corrosion:** Corrosion resulting from the placing of two dissimilar metals in direct contact with each other then exposing them to an incompatible fluid or atmosphere.

**Hammer, Liquid:** Pressure and depression waves created by relatively rapid flow changes and transmitted through the

system.

**Handy Flux:** Handy Flux is a trademark of the Handy & Harman Company.

**Hardening:** Increasing the hardness of a material by suitable treatment, usually involving heating and rapid cooling.

**Hardness:** Resistance of a material to scratching, abrasion, cutting or deformation.

**Head, Pressure:** The pressure due to the height of a column or body of fluid.

**Heading:** See COLD HEADING.

**Hot Finishing/Hot Forming:** A deformation operation performed at elevated temperature, usually above the recrystallization temperature of the metal.

**Hydraulic Power:** Power derived from flow rate and pressure differential of the fluid.

**Hydraulics:** Engineering science pertaining to liquid pressure and flow.

**Hydrogen Embrittlement:** A condition of low ductility in metals resulting from the absorption of hydrogen.

**Hydropneumatics:** Engineering science pertaining to the combination of hydraulic and pneumatic fluid power.

**Impact Test:** A single blow to determine the behavior of materials when subjected to high rates of loading, usually sudden and in the bending, tension or torsion mode. Charpy or Izod tests are typically used to measure materials' impact energy characteristics.

**Inclusions:** Nonmetallic materials in solid metallic matrix.

**Intergranular Corrosion:** A preferential corrosive attack at the grain boundaries of a metal.

**LB2000:** Registered Trademark of ITW.

**Lubricant:** Any substance used to reduce friction between two surfaces which are in contact.

**MPG 2:** Registered Trademark of Dubois Chemical Inc.

**Machinability:** The relative ease of machining a metal.

**Machining:** Removing material, in the form of chips, from work, usually through the use of a machine.

**Malleability:** The characteristic of metals that permits plastic deformation in compression without rupture.

**Mandrel:** (1) A metal bar around which other metal may be cast bent, formed, or shaped. (2) A rod used to retain the cavity in hollow metal products during working.

**Mechanical Properties:** The properties of a material that reveal its elastic and inelastic behavior under the application of force, thus indicating the material's suitability for mechanical applications. Examples of such properties are: tensile strength, elongation, modulus of elasticity, yield strength, reduction in area and fatigue limit.

**Microhardness:** The hardness of microscopic areas or of the individual microconstituents in a metal.



**Microstructure:** The structure of polished and etched metals as revealed by a microscope at a magnification greater than ten diameters.

**Mild Steel:** Carbon steel with a maximum of .25 percent carbon.

**Nitriding:** A case hardening process conducted by the introduction of nitrogen into the surface of a solid ferrous alloy.

**Nitrile (Buna N):** A copolymer of butadiene and acrylonitrile. It is the elastomer most widely used to manufacture O-rings.

**Nondestructive:** Inspection or test by methods that do not destroy the part.

**O-ring:** A torus, or doughnut shaped object, generally made from elastomer and is used primarily for sealing.

**Passivation:** A process used to improve corrosive behavior of a metal by changing its chemically active surface to a much less reactive state.

**Pipe:** (1) The defect in wrought or cast products resulting from the central cavity formed by contraction in metal, especially ingots, during solidification. (2) A tubular metal product that includes iron pipe size (I.P.S.) and schedule number in its classification.

**Pipe Thread, Dry Seal:** Tapered pipe threads in which sealing is a function of root and crest interference.

**Pitting:** Forming small sharp cavities in a metal surface by corrosion, mechanical action or nonuniform electrodeposition.

**Plastic Deformation:** Deformation that does or will remain permanent in an element after removal of the stress that caused it.

**Pneumatics:** Engineering science pertaining to gaseous pressure and flow.

**Port:** A terminus of a passage in a component to which conductors can be connected.

**Port, Pipe:** A port which conforms to pipe thread standards.

**Port, Straight Thread:** A port which conforms to straight thread standards. It typically employs an O-ring compressed in a wedge-shaped cavity.

**Power Supply, Fluid:** Energy source which generates and maintains a flow of fluid under pressure.

**Precipitation Hardening:** Hardening caused by the precipitation of a constituent from a supersaturated solid solution.

**Pressure:** Force per unit area, usually expressed in pounds per square inch (psi).

**Pressure, Absolute:** The pressure above absolute zero, i.e., the sum of atmospheric pressure plus gage pressure.

**Pressure, Atmospheric:** Pressure exerted by the atmosphere at any specific location. [Sea level atmospheric pressure is approximately 14.7 pounds per square inch (about 1 bar)]

**Pressure, Burst:** The pressure which causes failure of, and consequential loss of fluid through the product envelope.

**Pressure, Cyclic Test:** A pressure range applied in cyclic endurance tests that are performed to help determine recommended working pressure.

**Pressure, Differential (Pressure Drop):** The difference in pressure between any two points of a system or a component.

**Pressure, Gage:** Pressure differential above or below ambient atmospheric pressure.

**Pressure, Nominal:** A pressure value assigned to a component or system for the purpose of convenient designation.

**Pressure, Operating:** See WORKING PRESSURE.

**Pressure, Proof:** The non-destructive test pressure, in excess of the maximum rated operating pressure, which causes no permanent deformation, external leakage, or other resulting malfunction.

**Pressure, Rated Dynamic:** The maximum fluctuating pressure load that a pressure containing envelope is capable of sustaining for a minimum of 1 million operating cycles without failure.

**Pressure, Rated Static:** The maximum pressure that a pressure containing envelope is capable of sustaining in an application not exceeding 30,000 operating cycles in a system free of pressure surges, shocks, vibration, temperature excursions, etc.

**Pressure, Relief:** The pressure at which the relief valve is set for actuation. This pressure is generally slightly higher than the system working pressure.

**Pressure Shock:** A pressure wave front which moves at a sonic velocity, due to sudden stoppage of fluid flow.

**Pressure, Static:** The pressure in a fluid at rest.

**Pressure, Surge:** The pressure increases resulting from pressure fluctuations in a hydraulic system.

**Pressure, Working:** The pressure at which the apparatus is being operated in a given application.

**Pressure, Working Rated:** The qualified operating pressure which is recommended for a system or a component by the manufacturer.

**Proof Load:** A pre-determined load, generally some multiple of the service load, to which a specimen or structure is submitted before acceptance for use.

**Quenching:** Rapid cooling method used in heat treating process.

**Residual Stress:** Stress existing in a body that is free of external forces or thermal gradients.

**Rockwell Hardness Test:** A test for determining the hardness of a material based upon the depth of penetration of a specified penetrator into the specimen.

**Roughness:** Relatively finely-spaced surface irregularities, the height, width and direction of which establish the predominant surface pattern.

**STP:** Distributed by First Brand Corp. Danbury, CT.

**Scaling:** (1) Forming a thick layer of oxidation products on metals at high temperatures. (2) Depositing water-insoluble constituents on a metal surface, as in cooling tubes and water boilers.

**Seam:** A fold or lap on the surface of a metal appearing as a crack, usually resulting from a defect obtained in casting or in working.

**Segregation:** Concentration of alloying elements in specific regions in a metallic object.

**Shear Strength:** The load divided by the original cross-sectional area of a section separated by a shear force.

**Sour Environment:** Fluids containing water as a liquid and hydrogen sulfide, and may cause sulfide stress cracking (SSC) of susceptible materials.

**Specific Gravity, Liquid:** The ratio of the weight of a given volume of liquid to an equal volume of water.

**Spot Facing:** Machining in the mating component, a flat seat for a bolt head, nut, locknut or other similar element.

**Springback:** (1) The elastic recovery of metal after stressing. (2) The degree to which metal tends to return to its original shape or contour after undergoing a forming operation.

**Stainless Steel:** Basically, low carbon alloy steels containing at least 11.5% chromium. These steels are characterized by their high resistance to corrosion.

**Static Pressure Rating:** See pressure, rated static

**Steel:** An iron-based alloy, containing: manganese, usually carbon, and often other alloying elements.

**Strain:** A measure of the relative change in size or shape of a body. Example, linear strain is computed as the ratio of change in length to the original length.

**Stress:** The result of a force acting on a given surface area. Computed as the ratio of the applied force to the affected area.

**Stress Corrosion Cracking (SCC):** Fracture in a material resulting from the combined action of applied stress and corrosive environment.

**Stress Raisers/Concentration:** Changes in contour or discontinuities in structure that cause local increases in stress.

**Stringer:** In wrought materials, an elongated configuration of microconstituents or foreign material aligned in the direction of working.

**Sulfide Stress:** Brittle failure by cracking under the combined action of tensile stress and corrosion in the presence of water Cracking (SSC) and hydrogen sulfide.

**Surge:** A transient rise of pressure or flow.

**Swaging:** Forming a taper or a reduction on metal products such as rod and tubing by forging, squeezing or hammering.

**Temperature, Ambient:** The temperature of the environment in which the apparatus is working.

**Tensile Strength:** In tensile testing, the ratio of maximum load to original cross-sectional area.

**Tensile Strength, Ultimate:** The maximum stress that a material can withstand.

**Torque:** Turning effort (moment) applied to a component for fastening, tightening or assembling.

**Torsion:** A twisting action resulting in shear stresses and strain.

**Toughness:** Ability of a metal to absorb energy and deform without fracturing.

**Tube:** Hollow, cylindrical products having outside diameters that are not standardized for threading. Tubes are dimensionally classified in terms of their outside diameters and wall thicknesses.

**Upsetting:** See COLD HEADING.

**Vacuum:** Pressure less than ambient atmospheric pressure.

**Vibra-Seal:** Vibra-Seal is a registered trademark of Loctite Corporation.

**Viscosity:** A measure of the internal friction or the resistance of a fluid to flow.

**Viton:** Viton is a registered trademark of E.I. Du Pont de Nemours and Company.

**Welding:** Joining two or more pieces of metal by applying heat, pressure or both with or without filler metal, to produce a localized union through fusion or recrystallization across the interface.

**Work Hardening:** An increase in hardness and strength caused by plastic deformation at temperatures lower than the recrystallization range. (Same as Strain Hardening. See also, Cold Working.)

**Working Pressure, Dynamic:** See PRESSURE, RATED DYNAMIC.

**Working Pressure, Static:** See PRESSURE, RATED STATIC.

**Yield Strength:** The maximum stress that can be applied to a material, which upon removal, the material will return to approximately its original shape.





TABLE  
OF  
CONTENTS

U

# NUMERIC INDEX

Part Number .....	Page	Part Number .....	Page	Part Number .....	Page
<b>- 0 -</b>					
0107.....	F5	AOE4G.....	E23	C3MX.....	B30
0109.....	L11	AOEG5.....	E23	C3P4.....	G8
0207.....	F6	AOEL6.....	A25	C3T4.....	G6
0507.....	F5	AOEX6.....	B25	C4OMLO.....	A28
077T.....	F8	AOG5JG5.....	E26	C4OMX.....	B30
<b>- 1 -</b>					
1' hand tube bender.....	Q5	APB.....	O11	C5BU.....	C10
157422.....	Q36	APC.....	O8	C5OLO.....	A25
<b>- 2 -</b>					
2107.....	F7	APDA.....	O5	C5OX.....	B27
217T.....	F8	APDC.....	O8	C5OXO.....	B38
2207.....	F8	APKA.....	O5	C6BU.....	C10
227T.....	F8	APLA.....	O5	C6LO.....	A25
2507.....	F7	APLC.....	O9	C6MK4.....	H9
<b>- 3 -</b>					
3107.....	F6	APRA.....	O6	C6MLO.....	A25
3207.....	F6	APRB.....	O12	C6X.....	B25
3507.....	F6	APWA.....	O6	C6XO.....	B38
<b>- 4 -</b>					
412.....	Q8	AS.....	D40, K28	C87OMLO.....	A26
424.....	Q9	AS3 / AS6.....	K28	C87OMX.....	B29
<b>- 5 -</b>					
522398.....	Q18	ASA.....	O6	C8OMLO.....	A27
550501.....	Q18	ASB.....	O11	C8OMX.....	B29
5507.....	F7	ASC.....	O8	Captive O-Ring Assembly	
5607.....	F7	<b>- B -</b>			
<b>- 7 -</b>					
770106.....	Q34	B3HQ.....	K13	tool.....	Q52
<b>- 8 -</b>					
820029.....	Q18	BAV06/12.....	Q6	CBU.....	C11
<b>- 9 -</b>					
900044.....	Q25, Q33	BCP.....	N8	CC5BU.....	C11
900044.....	Q45	BCPH.....	N11, N17, N20	CC5OLO.....	A26
974250.....	Q21	BCPT.....	N14	CC5OX.....	B27
<b>- A -</b>					
A87LPOEG87LPM.....	E25	Bender capacity guides.....	Q7	CC87OMLO.....	A27
AOEG.....	E23	BFG.....	K15	CCCTX.....	B28
<b>- B -</b>					
B3HQ.....	K13	BFW.....	K36	CCTX.....	B28
BAV06/12.....	Q6	BIP.....	N8	CD.....	E24
BCP.....	N8	BL.....	A9	CD45.....	E22
BCPH.....	N11, N17, N20	BML.....	A9	Clamp Halves - Compact Spiral	
BCPT.....	N14	Bonded Seal for Banjo Fittings.....	M8	Hose Heavy Series.....	N16
Bender capacity guides.....	Q7	Braze flux.....	Q53	Clamp Halves - Compact Spiral	
BFG.....	K15	BSPP Bonded Seal.....	M7	Hose Heavy Twin.....	N19
BFW.....	K36	BSPP counterbores.....	Q40	Clamp Halves Heavy Series....	
BIP.....	N8	BSPP O-Ring.....	M6	Standard Series . N7	
BL.....	A9	BSPP/BSPT taps.....	Q40	Clamp Halves Twin Series.....	
BML.....	A9	BTX.....	B9	..... N13	
Bonded Seal for Banjo Fittings.....	M8	BU.....	C7	CLO.....	
Braze flux.....	Q53	BUEQ1.....	K33	A26	
BSPP Bonded Seal.....	M7	BUHLO.....	J4	CP.....	
BSPP counterbores.....	Q40	BUHQ1.....	K12	K31	
BSPP O-Ring.....	M6	BUVQ1.....	K32	N8	
BSPP/BSPT taps.....	Q40	BV06/1, BV20/25.....	Q6	CP432 tube & pipe bender kit .	
BTX.....	B9	..... Q19			
BU.....	C7	CPH.....			
BUEQ1.....	K33	N11, N17			
BUHLO.....	J4	CPHT.....			
BUHQ1.....	K12	N20			
BUVQ1.....	K32	CPT.....			
BV06/1, BV20/25.....	Q6	N14			
<b>- C -</b>					
CRA.....					
N9, N12, N15, N18, N20					



Part Number	Page	Part Number	Page	Part Number	Page	
CTX	B28	EO lubricants	Q54	F65OL	A19	
CTXO	B38	EO O-Ring	M10	F65OX	B20	
Cut-off saw	Q21	EO Swivel O-Ring	M9	F682EDML	A20	
<b>- D -</b>			EO-2 Sealing Ring	M7	F682EDMX	B21
D	D19	EO-Karrymat	Q50	F687OML	A20	
DA	D45	Eolastic Seal Ring	M6	F687OMX	B20	
DBU	C11	ESV	D26	F68OMX	B21	
DD	E24	ET	D77	F6L	A20	
DD45	E23	ET-M-ED	D79	F6MK4	H7	
DG101	D95	ET-R-ED	D78	F6X	B20	
DG102-M	D101	ETX	B25	F82EDMLO	A16	
DG102-R	D100	ETXO	B38	F82EDMX	B17	
DG103	D96	EW	D64	F82HG8	E19	
DG104-M	D103	EW-M-ED	D66	F87OHG87M	E18	
DG104-R	D102	EW-R-ED	D63	F87OMLO	A16	
DG105	D97	Exactol benders	Q8 - Q11	F87OMX	B17	
DG106-M	D105	<b>- F -</b>			F8OHA80	E13
DG106-R	D104	F3HG	E22	F8OHG	E18	
DG107	D98	F3HG5	E22	F8OHG5	E18	
DG108	D99	F3MK4	H7	F8OMX	B18	
DPA	O6	F3MX	B19	FBU	C8	
DPB	O11	F3P4	G6	FCC	K9	
DPC	O10	F3T4	G5	FCS	K9	
DPDC	O9	F42EDMLO	A16	Ferulset ferrule pre-setter	Q43	
DPR	D18	F42EDMX	B18	FF	E12	
DTX	B29	F4OHG	E19	FF33M	E13	
DV	D114	F4OHG5	E19	FF5OLO	A15	
DVGE-M	D92	F4OMX	B19	FF5OX	B15	
DVWE-M	D94	F5BU	C8	FFF	E12	
DVGE-R	D91	F5OF	E12	FFTX	B16	
DVWE-R	D93	F5OG	E15	FG	E17	
<b>- E -</b>			F5OG5	E15	FHF3	E22
E	D21	F5OHAO	E12	FHG4	E17	
E6MK4	H9	F5OHF42	E16	FHG5	E16	
EBU	C10	F5OHG4	E16	FHG8	E17	
EGE-M-ED	D52	F5OHG8	E16	FHQ40	K43	
EGE-NPT	D49	F5OHQ1	K13	FHS3	K10	
EGEO	D50	F5OHQ2	K13	FHS6	K11	
EGE-R-ED	D51	F5OHQ40	K44	Flange Seal O-Ring	M10	
EL	D80	F5OLO	A15	Flanging pin and die sets	Q23	
EL-M-ED	D82	F5OX	B15	Flaring tooling for Parflange		
ELO	A23	F5OXO	B37	ECO25	Q38	
EL-R-ED	D81	F63MX	B21	Flaring tooling for Parflange		
EMK4	H9	F63P4	G7	1025	Q37	
EMLO	A23	F642EDML	A21	FLO	A15	
		F642EDMX	B21	FM	D16	
				FMK4	H7	



Part Number .....	Page	Part Number .....	Page	Part Number .....	Page
FNL.....	A36	GE-R Keg .....	D34	Hyferset ferrule pre-setter .....	Q45
FNLBA .....	L10	GE-UNF/UN.....	D27	<b>- I -</b>	
FNMK4 .....	H8	GFS .....	K14	In-Ex deburring tool.....	Q22
FNMKA.....	I5	GG .....	E13	IPS.....	N8
FNML.....	A36	GG44M.....	E14	ISA.....	O5
FNMP4 .....	G8	GHG4 .....	E19	ISB.....	O11
FNMT4.....	G5	GHQ / G5HQ .....	K16	ISC.....	09
FNTX.....	B36	GHQ40.....	K44	ISO 6149 O-Ring .....	M5
FNU .....	C14	GLO .....	A16	ISO 6149-1 port counterbore ..	Q42
FTX .....	B16	GLO .....	L7	ISO 6149-1 port counterbore	
FTXO .....	B37	GM.....	D20	with ID groove .....	Q42
<b>- G -</b>		GMA3 .....	L5	ISO 6149-1 port tap .....	Q41
G.....	D23	GQ.....	K20	ITK.....	Q57
G3P4 .....	G7	GQ - Stainless Steel.....	K40	I-TL .....	D113
G4MK4 .....	H8	GQS.....	K29	<b>- J -</b>	
G4MLOSMO.....	L6	GR .....	D24	J6MK4 .....	H10
G4MX .....	B19	GTX.....	B17	JBU.....	C12
G4MXSMO .....	L6	GTX.....	L7	JIS B2351 O-Ring .....	M7
G4Q .....	K21	GTXO.....	B37	JLO.....	A28
G5EQ.....	K37	GZ.....	D46	JMK4 .....	H9
G5G5JAO .....	E25	GZR .....	D47	JMLO.....	A28
G5G5JG5 .....	E26	<b>- H -</b>		JTX .....	B31
G5HG5 .....	E13	H6MK4 .....	H7	JTXO.....	B39
G5HQ40.....	K44	Hand tube benders.....	Q4, Q5	JX6 .....	B32
G5LO .....	L7	HB632 .....	Q12 - Q16	<b>- K -</b>	
G5Q .....	K19	HBU.....	C7	K.....	D87
G5Q - Stainless Steel.....	K40	HHP .....	E29	Karryflare .....	Q36
G63P4 .....	G7	HL6.....	A19	KBU.....	C14
G65L.....	A19	HLO .....	A13	KH.....	D118
G65L.....	L7	HMK4 .....	H6	KH.....	D119
G6L.....	A20	HMKA .....	I5	KH-R/NPT .....	D122
G6L.....	L7	HMLO .....	A13	KLO .....	A35
G6X.....	B20	HP.....	E28	Kloskut - large .....	Q21
G6X.....	L7	HP3M .....	E31	Kloskut - medium.....	Q21
G8HG8 .....	E14	HP4.....	G6	KMMOO .....	E28
GAI-M.....	D39	HP46.....	G8	KOR.....	D57
GAI-R.....	D38	HP5ON .....	E28	KTX.....	B36
GBU.....	C9	HPBA.....	L10	K4HF8O.....	H8
GE-M .....	D36	HPC.....	E29	<b>- L -</b>	
GE-M-ED.....	D35	HRN.....	N9	LB 2000 & MPG-2 .....	Q54
GE-M Keg.....	D37	HTX.....	B11	LD .....	D115
GE-NPT .....	D28	HTXO.....	B37	LHTX.....	B11
GEO .....	D30	HT4 .....	G5	LOEQ1 .....	K33
GEQ.....	K38	HX6.....	B19	LOEQ2.....	K33
GE-R.....	D33	Hydra-Tool.....	Q33 - Q35		
GE-R-ED.....	D31	Hydra-Tool.....	Q48		





Part Number .....	Page	Part Number .....	Page	Part Number .....	Page
LOEX6 .....	J3	P .....	K15	R6X .....	B33
LOHB3 .....	A17	P47OMN .....	E30	R87OMLO .....	A34
LOHL6 .....	A19	P47OMN .....	G8	R87OMX .....	B36
LOHL6 Orifice .....	L9	P5ON .....	E28	Radial Seal O-Ring .....	M10
LOHL6G5TP .....	L5	P5ONBA .....	L10	Ratchet hand tube bender .....	Q4
LOHQ1 .....	K12	P87OMN .....	E29	RBP / RBN .....	O10
LOHQ2 .....	K12	Parflange ECO25 .....	Q25	RBU .....	C13
LOHQ40 .....	K43	Parflange 1025 .....	Q23	RCP / RCN / RCA / RCPD .....	O7
LOHT3 .....	A17	Par-Lok wrenches .....	Q58 - Q59	RED .....	D41
LOHU86 .....	J4	PNLO .....	A36	Retaining Ring .....	M6
LOHX6 .....	J3	PNLOBA .....	L10	RH .....	N12, N18, N20
LOVQ1 .....	K32	PNMK4 .....	H8	RHD .....	D106
LOVQ2 .....	K32	PNMKA .....	I5	RHDI .....	D111
LP .....	N8	PNMLO .....	A36	RHV-M-ED .....	D108
LPH .....	N11, N17	PNMP4 .....	G7	RHV-R-ED .....	D107
LPT .....	N14	PNMT4 .....	G5	RHZ-M-ED .....	D110
<b>- M -</b>		PNTX .....	B36	RHZ-R-ED .....	D109
M .....	D15	PNU .....	C14	RI .....	E21
Mandrel bending		Portboards .....	Q57	RI-ED .....	E20
components .....	Q16 - Q18	Post braze cleaner .....	Q53	RNH .....	N12, N18, N20
MAV .....	L6	Power deburr tool .....	Q22	RNT .....	N6
MAVE .....	L6	PQ .....	K30	Rolo-Flair rotary, manual .....	Q32
MBU .....	C14	PQ - Stainless Steel .....	K42	ROV .....	D89
Metal Seal for Banjo Fittings .....	M8	PQ40 .....	K45	RRS .....	E26
Metric O-Ring .....	M5	Pre-setting tooling for		RTX .....	B34
Metric Retaining Ring .....	M5	Hydra-Tool .....	Q48 - Q49	RTXO .....	B39
MMLOHB3 .....	A17	Pressure Gauge Sealing Ring .....	M9	RVP .....	D112
MMO .....	E27	PSR .....	D19	<b>- S -</b>	
MMO444M .....	E27	PTR .....	E17	S4OMLO .....	A34
MMS .....	E27	PTR34M .....	E19	S4OMX .....	B35
Moduar preparation centers .....	Q56	<b>- Q -</b>		S5BU .....	C12
MOK38SX .....	Q50	Q4 Insert .....	K45	S5OLO .....	A32
MRO .....	E27	QPQPJQ .....	K37	S5OX .....	B33
MTX .....	B34	<b>- R -</b>		S6BU .....	C12
<b>- N -</b>		R .....	N9, N15	S6LO .....	A31
NPTF taps .....	Q41	R4OMLO .....	A35	S6MK4 .....	H10
<b>- O -</b>		R4OMX .....	B35	S6MLO .....	A31
OBU .....	C13	R5BU .....	C13	S6X .....	B32
O-lube .....	Q54	R5OLO .....	A32	S87OMLO .....	A33
ORFS O-Ring .....	M4	R5OX .....	B33	S87OMX .....	B35
O-Ring pick .....	Q52	R5OXO .....	B39	SAE 4-Bolt Flange O-Ring .....	M10
OTX .....	B34	R6BU .....	C12	SAE O-Ring .....	M4
<b>- P -</b>		R6LO .....	A31	SAE straight thread port	
		R6MK4 .....	H10	counterbore .....	Q39
		R6MLO .....	A31	SB .....	N8
				SBA .....	O6





Part Number .....	Page	Part Number .....	Page	Part Number .....	Page
SBB .....	O12	TS .....	O6	W5Q .....	K22
SBH .....	N11, N17	TS .....	O12	W5Q - Stainless Steel .....	K41
SBR .....	B10	TSC.....	O9	W5SQS.....	K30
SBR (Inch).....	A12	TU.....	C7	W6EQ .....	K39
SBR (Metric) .....	A11	Tube fabricating equipment		W6Q .....	K25
SBT.....	N14	weight chart.....	Q60 - Q61	W7EQ .....	K34
SBU .....	C13	TX (Inch).....	B9	W7HQ.....	K16
Seamless stainless steel tubes ..	P6	TX (metric) .....	B9	W7HQ4O .....	K45
Seamless steel tubes .....	P4, P5			W7Q .....	K24
SHP .....	E29			WAS.....	D73
SKA .....	D53	<b>- U -</b>		WB1HQ1 / WB3HQ1 /	
SLA.....	O5	UPTC Nut Assembly.....	A37	WB5HQ1 .....	K17
SLO .....	A33	US.....	O12	WB1Q1 / WB3Q1 / WB5Q1.....	K26
SPC .....	O9	USA .....	O6	WB3HQ2 / WB5HQ2 /	
SPGG5 .....	K31	USC .....	O10	WB7HQ2 .....	K18
SSB .....	O10			WB3Q2 / WB5Q2 / WB7Q2.....	K27
SSC .....	O8	<b>- V -</b>		WBT.....	K28
SSLA.....	O5	V3MX.....	B24	WBU .....	C8
Straight thread port tap .....	Q39	V3P4 .....	G8	WEBU .....	C10
STX.....	B34	V3T4 .....	G6	WELO .....	A24
Super o-lube.....	Q54	V4OMLO.....	A23	WE-M keg.....	D63
SV .....	D25	V4OMX .....	B24	WEMLO .....	A24
SWVE-M.....	D68	V5BU .....	C9	WE-NPT.....	D61
SWVE-R.....	D67	V5OLO .....	A22	WE-R keg .....	D62
		V5OX .....	B23	WETX.....	B26
		V6LO.....	A22	WF5OLO.....	A14
<b>- T -</b>		V6X .....	B22	WF5OX .....	B12
T .....	D74	V87OMLO.....	A22	WFS.....	K35
T22X .....	B36	V87OMX .....	B23	WFTX.....	B12
TH-M .....	D84	VBU .....	C9	WGTX .....	B13
TH-M-KDS.....	D86	VDHA.....	D116	WH-M .....	D70
TH-R.....	D83	VDHB.....	D117	WH-M-KDS .....	D71
Thread identification kit .....	Q57	VH.....	D22	WH-R.....	D69
Threadmate .....	Q55	Vise block and flaring		WH-R-KDS.....	D71
TH-R-KDS .....	D85	pin.....	Q31 - Q32	WJJLO.....	A30
TL (Inch).....	A11	VKA.....	D88	WJJMLO.....	A30
TLFA .....	A9	VKAM .....	D90	WJJTX .....	B32
TLS (Metric) .....	A11	VKA3.....	L8	WJLO.....	A29
TMA .....	O6	VLO.....	A23	WJMLO .....	A29
TMB.....	O11	VOMO.....	Q44	WJTX .....	B31
TMC.....	O9	VSTI M-ED.....	E30	WLN.....	B10
TPL (Inch) .....	A10	VSTI M-OR .....	E30	WLN.....	C7
TPLS (Metric).....	A10	VSTI R-ED .....	E30	WLN.....	A12
TR .....	D75	VTX .....	B24	WLNML .....	A12
TRBU .....	C9			WLO .....	A13
TRLON.....	A18	<b>- W -</b>		WMK4WL4NM.....	H6
TRTX / TRTXN .....	B14	W .....	D59	WMLO .....	A14
Tru-Kut.....	Q21	W4Q .....	K23		





Part Number .....	Page
WNLO .....	A21
WNMLO .....	A22
WNTX .....	B22
WP .....	N9
WPE .....	N9
WPH .....	N11, N17
WPHT .....	N20
WPT .....	N15
WSD .....	K29
WSV .....	D60
WTX .....	B12
WV .....	D124

**- X -**

X6EF .....	B27
XEMK46 .....	J6
XEQ1 .....	K33
XEQ2 .....	K33
XHB3 .....	B15
XHBU .....	J4
KHBU2 .....	J4
XHK4 .....	J5
XHL6 .....	J3
XHLO .....	J3
XHMK46 .....	J5
XHMKA .....	I5
XHMKA6 .....	I6
XHQ1 .....	K12
XHQ2 .....	K12
XHQ40 .....	K43
XHT4 .....	J5
XHT46 .....	J5
XHU86 .....	J6
XHX6 .....	B13
XHX6G5TP .....	L5
XHX7 Orifice .....	L9
XO O-Ring .....	M4
XVQ1 .....	K32
XVQ2 .....	K32



1/8" 1/4" 3/8"

Male Pipe Thread Sizes

1/2"  
3/4"  
1"  
1-1/4"  
1-1/2"  
2"

TABLE  
OF  
CONTENTS

2" -32  
1-1/2" -24  
1-1/4" -20  
1" -16  
7/8" -14

SAE (JIC) 37° Flare Nose Cone Sizes

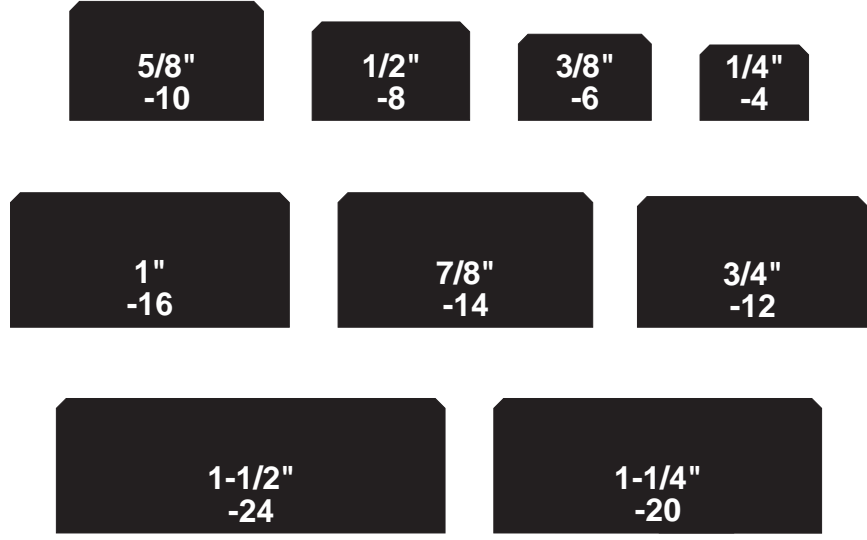

O-Ring Face Seal (SAE J1453)

Male Pipe Thread Sizes

FITTING END SIZE CHART

SAE (JIC) 37° Flare Nose Cone Sizes

SAE 45° Flare  
Nose Cone Sizes



## Parker Safety Guide for Selecting and Using Hose, Tubing, Fittings, Connectors, Conductors, Valves and Related Accessories

Parker Publication No. 4400-B.1

**WARNING:** Failure or improper selection or improper use of hose, tubing, fittings, assemblies, valves, connectors, conductors or related accessories (“Products”) can cause death, personal injury and property damage. Possible consequences of failure or improper selection or improper use of these Products include but are not limited to:

- Fittings thrown off at high speed.
- High velocity fluid discharge.
- Explosion or burning of the conveyed fluid.
- Electrocution from high voltage electric powerlines.
- Contact with suddenly moving or falling objects that are controlled by the conveyed fluid.
- Injections by high-pressure fluid discharge.
- Dangerously whipping Hose.
- Tube or pipe burst.
- Weld joint fracture.
- Contact with conveyed fluids that may be hot, cold, toxic or otherwise injurious.
- Sparking or explosion caused by static electricity buildup or other sources of electricity.
- Sparking or explosion while spraying paint or flammable liquids.
- Injuries resulting from inhalation, ingestion or exposure to fluids.

Before selecting or using any of these Products, it is important that you read and follow the instructions below. No product from any division in Parker Fluid Connectors Group is approved for in-flight aerospace applications. For hoses and fittings used in in-flight aerospace applications, please contact Parker Aerospace Group.

TABLE  
OF  
CONTENTS

### 1.0 GENERAL INSTRUCTIONS

**1.1 Scope:** This safety guide provides instructions for selecting and using (including assembling, installing, and maintaining) these Products. For convenience, all rubber and/or thermoplastic products commonly called “hose” or “tubing” are called “Hose” in this safety guide. Metallic tube or pipe are called “tube”. All assemblies made with Hose are called “Hose Assemblies”. All assemblies made with Tube are called “Tube Assemblies”. All products commonly called “fittings”, “couplings” or “adapters” are called “Fittings”. Valves are fluid system components that control the passage of fluid. Related accessories are ancillary devices that enhance or monitor performance including crimping, flaring, flanging, presetting, bending, cutting, deburring, swaging machines, sensors, tags, lockout handles, spring guards and associated tooling. This safety guide is a supplement to and is to be used with the specific Parker publications for the specific Hose, Fittings and Related Accessories that are being considered for use. Parker publications are available at [www.parker.com](http://www.parker.com). SAE J1273 ([www.sae.org](http://www.sae.org)) and ISO 17165-2 ([www.ansi.org](http://www.ansi.org)) also provide recommended practices for hydraulic Hose Assemblies, and should be followed.

**1.2 Fail-Safe:** Hose, Hose Assemblies, Tube, Tube Assemblies and Fittings can and do fail without warning for many reasons. Design all systems and equipment in a fail-safe mode, so that failure of the Hose, Hose Assembly, Tube, Tube Assembly or Fitting will not endanger persons or property.

**1.3 Distribution:** Provide a copy of this safety guide to each person responsible for selecting or using Hose, Tube and Fitting products. Do not select or use Parker Hose, Tube or Fittings without thoroughly reading and understanding this safety guide as well as the specific Parker publications for the Products.

**1.4 User Responsibility:** Due to the wide variety of operating conditions and applications for Hose, Tube and Fittings. Parker does not represent or warrant that any particular Hose, Tube or Fitting is suitable for any specific end use system. This safety guide does not analyze all technical parameters that must be considered in selecting a product. The user, through its own analysis and testing, is solely responsible for:

- Making the final selection of the Products.
- Assuring that the user’s requirements are met and that the application presents no health or safety hazards.
- Following the safety guide for Related Accessories and being trained to operate Related Accessories.
- Providing all appropriate health and safety warnings on the equipment on which the Products are used.
- Assuring compliance with all applicable government and industry standards.

**1.5 Additional Questions:** Call the appropriate Parker technical service department if you have any questions or require any additional information. See the Parker publication for the Products being considered or used, or call 1-800-CPARKER, or go to [www.parker.com](http://www.parker.com), for telephone numbers of the appropriate technical service department.

### 2.0 HOSE, TUBE AND FITTINGS SELECTION INSTRUCTIONS

**2.1 Electrical Conductivity:** Certain applications require that the Hose be nonconductive to prevent electrical current flow. Other applications require the Hose and the Fittings and the Hose/Fitting interface to be sufficiently conductive to drain off static electricity. Extreme care must be exercised when

selecting Hose, Tube and Fittings for these or any other applications in which electrical conductivity or nonconductivity is a factor.

The electrical conductivity or nonconductivity of Hose, Tube and Fittings is dependent upon many factors and may be susceptible to change. These factors include but are not limited to the various materials used to make the Hose and the Fittings, Fitting finish (some Fitting finishes are electrically conductive while others are nonconductive), manufacturing methods (including moisture control), how the Fittings contact the Hose, age and amount of deterioration or damage or other changes, moisture content of the Hose at any particular time, and other factors.

The following are considerations for electrically nonconductive and conductive Hose. For other applications consult the individual catalog pages and the appropriate industry or regulatory standards for proper selection.

**2.1.1 Electrically Nonconductive Hose:** Certain applications require that the Hose be nonconductive to prevent electrical current flow or to maintain electrical isolation. For applications that require Hose to be electrically nonconductive, including but not limited to applications near high voltage electric lines, only special nonconductive Hose can be used. The manufacturer of the equipment in which the nonconductive Hose is to be used must be consulted to be certain that the Hose, Tube and Fittings that are selected are proper for the application. Do not use any Parker Hose or Fittings for any such application requiring nonconductive Hose, including but not limited to applications near high voltage electric lines or dense magnetic fields, unless (i) the application is expressly approved in the Parker technical publication for the product, (ii) the Hose is marked “nonconductive”, and (iii) the manufacturer of the equipment on which the Hose is to be used specifically approves the particular Parker Hose, Tube and Fittings for such use.

**2.1.2 Electrically Conductive Hose:** Parker manufactures special Hose for certain applications that require electrically conductive Hose. Parker manufactures special Hose for conveying paint in airless paint spraying applications. This Hose is labeled “Electrically Conductive Airless Paint Spray Hose” on its layline and packaging. This Hose must be properly connected to the appropriate Parker Fittings and properly grounded in order to dissipate dangerous static charge buildup, which occurs in all airless paint spraying applications. Do not use any other Hose for airless paint spraying, even if electrically conductive. Use of any other Hose or failure to properly connect the Hose can cause a fire or an explosion resulting in death, personal injury, and property damage. All hoses that convey fuels must be grounded.

Parker manufactures a special Hose for certain compressed natural gas (“CNG”) applications where static electricity buildup may occur. Parker CNG Hose assemblies comply with the requirements of ANSI/IAS NGV 4.2; CSA 12.52, “Hoses for Natural Gas Vehicles and Dispensing Systems” ([www.ansi.org](http://www.ansi.org)). This Hose is labeled “Electrically Conductive for CNG Use” on its layline and packaging. This Hose must be properly connected to the appropriate Parker Fittings and properly grounded in order to dissipate dangerous static charge buildup, which occurs in, for example, high velocity CNG dispensing or transfer. Do not use any other Hose for CNG applications where static charge buildup may occur, even if electrically conductive. Use of other Hoses in CNG applications or failure to properly connect or ground this Hose can cause a fire or an explosion resulting in death, personal injury, and property damage. Care must also be taken to protect against CNG permeation through the Hose wall. See section 2.6, Permeation, for more information. Parker CNG Hose is intended for dispenser and vehicle use

## Parker Safety Guide, Parker Publication No. 4400-B.1 (Continued)

within the specified temperature range. Parker CNG Hose should not be used in confined spaces or unventilated areas or areas exceeding the specified temperature range. Final assemblies must be tested for leaks. CNG Hose Assemblies should be tested on a monthly basis for conductivity per ANSI/IAS NGV 4.2; CSA 12.52.

Parker manufactures special Hose for aerospace in-flight applications. Aerospace in-flight applications employing Hose to transmit fuel, lubricating fluids and hydraulic fluids require a special Hose with a conductive inner tube. This Hose for in-flight applications is available only from Parker's Stratoflex Products Division. Do not use any other Parker Hose for in-flight applications, even if electrically conductive. Use of other Hoses for in-flight applications or failure to properly connect or ground this Hose can cause a fire or an explosion resulting in death, personal injury and property damage. These Hose assemblies for in-flight applications must meet all applicable aerospace industry, aircraft engine and aircraft requirements.

**2.2 Pressure:** Hose, Tube and Fitting selection must be made so that the published maximum working pressure of the Hose, Tube and Fittings are equal to or greater than the maximum system pressure. The maximum working pressure of a Hose, or Tube Assembly is the lower of the respective published maximum working pressures of the Hose, Tube and the Fittings used. Surge pressures or peak transient pressures in the system must be below the published maximum working pressure for the Hose, Tube and Fitting. Surge pressures and peak pressures can usually only be determined by sensitive electrical instrumentation that measures and indicates pressures at millisecond intervals. Mechanical pressure gauges indicate only average pressures and cannot be used to determine surge pressures or peak transient pressures. Published burst pressure ratings for Hose is for manufacturing test purposes only and is no indication that the Product can be used in applications at the burst pressure or otherwise above the published maximum recommended working pressure.

**2.3 Suction:** Hoses used for suction applications must be selected to insure that the Hose will withstand the vacuum and pressure of the system. Improperly selected Hose may collapse in suction application.

**2.4 Temperature:** Be certain that fluid and ambient temperatures, both steady and transient, do not exceed the limitations of the Hose, Tube, Fitting and Seals. Temperatures below and above the recommended limit can degrade Hose, Tube, Fittings and Seals to a point where a failure may occur and release fluid. Tube and Fittings performances are normally degraded at elevated temperature. Material compatibility can also change at temperatures outside of the rated range. Properly insulate and protect the Hose Assembly when routing near hot objects (e.g. manifolds). Do not use any Hose in any application where failure of the Hose could result in the conveyed fluids (or vapors or mist from the conveyed fluids) contacting any open flame, molten metal, or other potential fire ignition source that could cause burning or explosion of the conveyed fluids or vapors.

**2.5 Fluid Compatibility:** Hose, and Tube Assembly selection must assure compatibility of the Hose tube, cover, reinforcement, Tube, Plating and Seals with the fluid media used. See the fluid compatibility chart in the Parker publication for the product being considered or used. This information is offered only as a guide. Actual service life can only be determined by the end user by testing under all extreme conditions and other analysis.

Hose, and Tube that is chemically compatible with a particular fluid must be assembled using Fittings and adapters containing likewise compatible seals. Flange or flare processes can change Tube material properties that may not be compatible with certain requirements such as NACE

**2.6 Permeation:** Permeation (that is, seepage through the Hose or Seal) will occur from inside the Hose or Fitting to outside when Hose or Fitting is used with gases, liquid and gas fuels, and refrigerants (including but not limited to such materials as helium, diesel fuel, gasoline, natural gas, or LPG). This permeation may result in high concentrations of vapors which are potentially flammable, explosive, or toxic, and in loss of fluid. Dangerous explosions, fires, and other hazards can result when using the wrong Hose for such applications. The system designer must take into account the fact that this permeation will take place and must not use Hose or Fitting if this permeation could be hazardous. The system designer must take into account all legal, government, insurance, or any other special regulations which govern the use of fuels and refrigerants. Never use a Hose or Fitting even though the fluid compatibility is acceptable without considering the potential hazardous effects that can result from permeation through the Hose or Tube Assembly.

Permeation of moisture from outside the Hose or Fitting to inside the Hose or Fitting will also occur in Hose or Tube assemblies, regardless of internal pressure. If this moisture permeation would have detrimental effects (particularly, but not limited to refrigeration and air conditioning systems), incorporation of sufficient drying capacity in the system or other appropriate system safeguards should be selected and used. The sudden pressure re-

lease of highly pressurized gas could also result in Explosive Decompression failure of permeated Seals and Hoses.

**2.7 Size:** Transmission of power by means of pressurized fluid varies with pressure and rate of flow. The size of the components must be adequate to keep pressure losses to a minimum and avoid damage due to heat generation or excessive fluid velocity.

**2.8 Routing:** Attention must be given to optimum routing to minimize inherent problems (kinking or flow restriction due to Hose collapse, twisting of the Hose, proximity to hot objects or heat sources). For additional routing recommendations see SAE J1273 and ISO 17165-2. Hose Assemblies have a finite life and should be installed in a manner that allows for ease of inspection and future replacement. Hose because of its relative short life, should not be used in residential and commercial buildings inside of inaccessible walls or floors, unless specifically allowed in the product literature. Always review all product literature for proper installation and routing instructions.

**2.9 Environment:** Care must be taken to insure that the Hose, Tube and Fittings are either compatible with or protected from the environment (that is, surrounding conditions) to which they are exposed. Environmental conditions including but not limited to ultraviolet radiation, sunlight, heat, ozone, moisture, water, salt water, chemicals and air pollutants can cause degradation and premature failure.

**2.10 Mechanical Loads:** External forces can significantly reduce Hose, Tube and Fitting life or cause failure. Mechanical loads which must be considered include excessive flexing, twist, kinking, tensile or side loads, bend radius, and vibration. Use of swivel type Fittings or adapters may be required to insure no twist is put into the Hose. Use of proper Hose or Tube clamps may also be required to reduce external mechanical loads. Unusual applications may require special testing prior to Hose selection.

**2.11 Physical Damage:** Care must be taken to protect Hose from wear, snagging, kinking, bending smaller than minimum bend radius and cutting, any of which can cause premature Hose failure. Any Hose that has been kinked or bent to a radius smaller than the minimum bend radius, and any Hose that has been cut or is cracked or is otherwise damaged should be removed and discarded. Fittings with damages such as scratches on sealing surfaces and deformation should be replaced.

**2.12 Proper End Fitting:** See instructions 3.2 through 3.5. These recommendations may be substantiated by testing to industry standards such as SAE J517 for hydraulic applications, or MIL-A-5070, AS1339, or AS3517 for Hoses from Parker's Stratoflex Products Division for aerospace applications.

**2.13 Length:** When determining the proper Hose or Tube length of an assembly, be aware of Hose length change due to pressure, Tube length change due to thermal expansion or contraction, and Hose or Tube and machine tolerances and movement must be considered. When routing short hose assemblies, it is recommended that the minimum free hose length is always used. Consult the hose manufacturer for their minimum free hose length recommendations. Hose assemblies should be installed in such a way that any motion or flexing occurs within the same plane.

**2.14 Specifications and Standards:** When selecting Hose, Tube and Fittings, government, industry, and Parker specifications and recommendations must be reviewed and followed as applicable.

**2.15 Hose Cleanliness:** Hose and Tube components may vary in cleanliness levels. Care must be taken to insure that the Hose and Tube Assembly selected has an adequate level of cleanliness for the application.

**2.16 Fire Resistant Fluids:** Some fire resistant fluids that are to be conveyed by Hose or Tube require use of the same type of Hose or Tube as used with petroleum base fluids. Some such fluids require a special Hose, Tube, Fitting and Seal, while a few fluids will not work with any Hose at all. See instructions 2.5 and 1.5. The wrong Hose, Tube, Fitting or Seal may fail after a very short service. In addition, all liquids but pure water may burn fiercely under certain conditions, and even pure water leakage may be hazardous.

**2.17 Radiant Heat:** Hose and Seals can be heated to destruction without contact by such nearby items as hot manifolds or molten metal. The same heat source may then initiate a fire. This can occur despite the presence of cool air around the Hose or Seal. Performance of Tube and Fitting subjected to the heat could be degraded.

**2.18 Welding or Brazing:** When using a torch or arc welder in close proximity to hydraulic lines, the hydraulic lines should be removed or shielded with appropriate fire resistant materials. Flame or weld spatter could burn through the Hose or Seal and possibly ignite escaping fluid resulting in a catastrophic failure. Heating of plated parts, including Hose Fittings and adapters, above 450°F (232°C) such as during welding, brazing or soldering may emit deadly gases. Any elastomer seal on fittings shall be removed prior to welding or brazing, any metallic surfaces shall be protected after brazing or welding when necessary. Welding and brazing filler





## Parker Safety Guide, Parker Publication No. 4400-B.1 (Continued)

material shall be compatible with the Tube and Fitting that are joined.

- 2.19 Atomic Radiation:** Atomic radiation affects all materials used in Hose and Tube assemblies. Since the long-term effects may be unknown, do not expose Hose or Tube assemblies to atomic radiation. Nuclear applications may require special Tube and Fittings.
- 2.20 Aerospace Applications:** The only Hose, Tube and Fittings that may be used for in-flight aerospace applications are those available from Parker's Stratoflex Products Division. Do not use any other Hose or Fittings for in-flight applications. Do not use any Hose or Fittings from Parker's Stratoflex Products Division with any other Hose or Fittings, unless expressly approved in writing by the engineering manager or chief engineer of Stratoflex Products Division and verified by the user's own testing and inspection to aerospace industry standards.
- 2.21 Unlocking Couplings:** Ball locking couplings or other Fittings with quick disconnect ability can unintentionally disconnect if they are dragged over obstructions, or if the sleeve or other disconnect member, is bumped or moved enough to cause disconnect. Threaded Fittings should be considered where there is a potential for accidental uncoupling.
- 3.0 HOSE AND FITTINGS ASSEMBLY AND INSTALLATION INSTRUCTIONS**
- 3.1 Component Inspection:** Prior to assembly, a careful examination of the Hose and Fittings must be performed. All components must be checked for correct style, size, catalog number, and length. The Hose must be examined for cleanliness, obstructions, blisters, cover looseness, kinks, cracks, cuts or any other visible defects. Inspect the Fitting and sealing surfaces for burrs, nicks, corrosion or other imperfections. Do NOT use any component that displays any signs of nonconformance.
- 3.2 Hose and Fitting Assembly:** Do not assemble a Parker Fitting on a Parker Hose that is not specifically listed by Parker for that Fitting, unless authorized in writing by the engineering manager or chief engineer of the appropriate Parker division. Do not assemble a Parker Fitting on another manufacturer's Hose or a Parker Hose on another manufacturer's Fitting unless (i) the engineering manager or chief engineer of the appropriate Parker division approves the Assembly in writing or that combination is expressly approved in the appropriate Parker literature for the specific Parker product, and (ii) the user verifies the Assembly and the application through analysis and testing. For Parker Hose that does not specify a Parker Fitting, the user is solely responsible for the selection of the proper Fitting and Hose Assembly procedures. See instruction 1.4.
- To prevent the possibility of problems such as leakage at the Fitting or system contamination, it is important to completely remove all debris from the cutting operation before installation of the Fittings. The Parker published instructions must be followed for assembling the Fittings on the Hose. These instructions are provided in the Parker Fitting catalog for the specific Parker Fitting being used, or by calling 1-800-CPARKER, or at [www.parker.com](http://www.parker.com).
- 3.3 Related Accessories:** Do not crimp or swage any Parker Hose or Fitting with anything but the listed swage or crimp machine and dies in accordance with Parker published instructions. Do not crimp or swage another manufacturer's Fitting with a Parker crimp or swage die unless authorized in writing by the engineering manager or chief engineer of the appropriate Parker division.
- 3.4 Parts:** Do not use any Parker Fitting part (including but not limited to socket, shell, nipple, or insert) except with the correct Parker mating parts, in accordance with Parker published instructions, unless authorized in writing by the engineering manager or chief engineer of the appropriate Parker division.
- 3.5 Field Attachable/Permanent:** Do not reuse any field attachable Hose Fitting that has blown or pulled off a Hose. Do not reuse a Parker permanent Hose Fitting (crimped or swaged) or any part thereof. Complete Hose Assemblies may only be reused after proper inspection under section 4.0. Do not assemble Fittings to any previously used hydraulic Hose that was in service, for use in a fluid power application.
- 3.6 Pre-Installation Inspection:** Prior to installation, a careful examination of the Hose Assembly must be performed. Inspect the Hose Assembly for any damage or defects. DO NOT use any Hose Assembly that displays any signs of nonconformance.
- 3.7 Minimum Bend Radius:** Installation of a Hose at less than the minimum listed bend radius may significantly reduce the Hose life. Particular attention must be given to preclude sharp bending at the Hose to Fitting juncture. Any bending during installation at less than the minimum bend radius must be avoided. If any Hose is kinked during installation, the Hose must be discarded.
- 3.8 Twist Angle and Orientation:** Hose Assembly installation must be such that relative motion of machine components does not produce twisting.
- 3.9 Securement:** In many applications, it may be necessary to restrain, protect, or guide the Hose to protect it from damage by unnecessary flexing, pressure

surges, and contact with other mechanical components. Care must be taken to insure such restraints do not introduce additional stress or wear points.

- 3.10 Proper Connection of Ports:** Proper physical installation of the Hose Assembly requires a correctly installed port connection insuring that no twist or torque is transferred to the Hose when the Fittings are being tightened or otherwise during use.
- 3.11 External Damage:** Proper installation is not complete without insuring that tensile loads, side loads, kinking, flattening, potential abrasion, thread damage or damage to sealing surfaces are corrected or eliminated. See instruction 2.10.
- 3.12 System Checkout:** All air entrapment must be eliminated and the system pressurized to the maximum system pressure (at or below the Hose maximum working pressure) and checked for proper function and freedom from leaks. Personnel must stay out of potential hazardous areas while testing and using.
- 3.13 Routing:** The Hose Assembly should be routed in such a manner so if a failure does occur, the escaping media will not cause personal injury or property damage. In addition, if fluid media comes in contact with hot surfaces, open flame or sparks, a fire or explosion may occur. See section 2.4.
- 3.14 Ground Fault Equipment Protection Devices (GFEEDs): WARNING! Fire and Shock Hazard.** To minimize the danger of fire if the heating cable of a Multitube bundle is damaged or improperly installed, use a Ground Fault Equipment Protection Device. Electrical fault currents may be insufficient to trip a conventional circuit breaker.
- For ground fault protection, the IEEE 515:** ([www.ansi.org](http://www.ansi.org)) standard for heating cables recommends the use of GFEEDs with a nominal 30 milliampere trip level for "piping systems in classified areas, those areas requiring a high degree of maintenance, or which may be exposed to physical abuse or corrosive atmospheres".
- 4.0 TUBE AND FITTINGS ASSEMBLY AND INSTALLATION INSTRUCTIONS**
- 4.1 Component Inspection:** Prior to assembly, a careful examination of the Tube and Fittings must be performed. All components must be checked for correct style, size, material, seal, and length. Inspect the Fitting and sealing surfaces for burrs, nicks, corrosion, missing seal or other imperfections. Do NOT use any component that displays any signs of nonconformance.
- 4.2 Tube and Fitting Assembly:** Do not assemble a Parker Fitting with a Tube that is not specifically listed by Parker for that Fitting, unless authorized in writing by the engineering manager or chief engineer of the appropriate Parker division. The Tube must meet the requirements specified to the Fitting.
- The Parker published instructions must be followed for assembling the Fittings to a Tube. These instructions are provided in the Parker Fitting catalog for the specific Parker Fitting being used, or by calling 1-800-CPARKER, or at [www.parker.com](http://www.parker.com).
- 4.3 Related Accessories:** Do not preset or flange Parker Fitting components using another manufacturer's equipment or procedures unless authorized in writing by the engineering manager or chief engineer of the appropriate Parker division. Tube, Fitting component and tooling must be checked for correct style, size and material. Operation and maintenance of Related Accessories must be in accordance with the operation manual for the designated Accessory.
- 4.4 Securement:** In many applications, it may be necessary to restrain, protect, or guide the Tube to protect it from damage by unnecessary flexing, pressure surges, vibration, and contact with other mechanical components. Care must be taken to insure such restraints do not introduce additional stress or wear points.
- 4.5 Proper Connection of Ports:** Proper physical installation of the Tube Assembly requires a correctly installed port connection insuring that no torque is transferred to the Tube when the Fittings are being tightened or otherwise during use.
- 4.6 External Damage:** Proper installation is not complete without insuring that tensile loads, side loads, flattening, potential abrasion, thread damage or damage to sealing surfaces are corrected or eliminated. See instruction 2.10.
- 4.7 System Checkout:** All air entrapment must be eliminated and the system pressurized to the maximum system pressure (at or below the Tube Assembly maximum working pressure) and checked for proper function and freedom from leaks. Personnel must stay out of potential hazardous areas while testing and using.
- 4.8 Routing:** The Tube Assembly should be routed in such a manner so if a failure does occur, the escaping media will not cause personal injury or property damage. In addition, if fluid media comes in contact with hot surfaces, open flame or sparks, a fire or explosion may occur. See section 2.4.
- 5.0 HOSE AND FITTING MAINTENANCE AND REPLACEMENT INSTRUCTIONS**



## Parker Safety Guide, Parker Publication No. 4400-B.1 (Continued)



- 5.1** Even with proper selection and installation, Hose life may be significantly reduced without a continuing maintenance program. The severity of the application, risk potential from a possible Hose failure, and experience with any Hose failures in the application or in similar applications should determine the frequency of the inspection and the replacement for the Products so that Products are replaced before any failure occurs. Certain products require maintenance and inspection per industry requirements. Failure to adhere to these requirements may lead to premature failure. A maintenance program must be established and followed by the user and, at minimum, must include instructions 5.2 through 5.7
- 5.2 Visual Inspection Hose/Fitting:** Any of the following conditions require immediate shut down and replacement of the Hose Assembly:
- Fitting slippage on Hose;
  - Damaged, cracked, cut or abraded cover (any reinforcement exposed);
  - Hard, stiff, heat cracked, or charred Hose;
  - Cracked, damaged, or badly corroded Fittings;
  - Leaks at Fitting or in Hose;
  - Kinked, crushed, flattened or twisted Hose; and
  - Blistered, soft, degraded, or loose cover.
- 5.3 Visual Inspection All Other:** The following items must be tightened, repaired, corrected or replaced as required:
- Leaking port conditions;
  - Excess dirt buildup;/
  - Worn clamps, guards or shields; and
  - System fluid level, fluid type, and any air entrapment.
- 5.4 Functional Test:** Operate the system at maximum operating pressure and check for possible malfunctions and leaks. Personnel must avoid potential hazardous areas while testing and using the system. See section 2.2.
- 5.5 Replacement Intervals:** Hose assemblies and elastomeric seals used on Hose Fittings and adapters will eventually age, harden, wear and deteriorate under thermal cycling and compression set. Hose Assemblies and elastomeric seals should be inspected and replaced at specific replacement intervals, based on previous service life, government or industry recommendations, or when failures could result in unacceptable downtime, damage, or injury risk. See section 1.2. Hose and Fittings may be subjected to internal mechanical and/or chemical wear from the conveying fluid and may fail without warning. The user must determine the product life under such circumstances by testing. Also see section 2.5.
- 5.6 Hose Inspection and Failure:** Hydraulic power is accomplished by utilizing high pressure fluids to transfer energy and do work. Hoses, Fittings and Hose Assemblies all contribute to this by transmitting fluids at high pressures. Fluids under pressure can be dangerous and potentially lethal and, therefore, extreme caution must be exercised when working with fluids under pressure and handling the Hoses transporting the fluids. From time to time, Hose Assemblies will fail if they are not replaced at proper time intervals. Usually these failures are the result of some form of misapplication, abuse, wear or failure to perform proper maintenance. When Hoses fail, generally the high pressure fluids inside escape in a stream which may or may not be visible to the user. Under no circumstances should the user attempt to locate the leak by “feeling” with their hands or any other part of their body. High pressure fluids can and will penetrate the skin and cause severe tissue damage and possibly loss of limb. Even seemingly minor hydraulic fluid injection injuries must be treated immediately by a physician with knowledge of the tissue damaging properties of hydraulic fluid.

If a Hose failure occurs, immediately shut down the equipment and leave the area until pressure has been completely released from the Hose Assembly. Simply shutting down the hydraulic pump may or may not eliminate the pressure in the Hose Assembly. Many times check valves, etc., are employed in a system and can cause pressure to remain in a Hose Assembly even when pumps or equipment are not operating. Tiny holes in the Hose, commonly known as pinholes, can eject small, dangerously powerful but hard to see streams of hydraulic fluid. It may take several minutes or even hours for the pressure to be relieved so that the Hose Assembly may be examined safely.

- Once the pressure has been reduced to zero, the Hose Assembly may be taken off the equipment and examined. It must always be replaced if a failure has occurred. Never attempt to patch or repair a Hose Assembly that has failed. Consult the nearest Parker distributor or the appropriate Parker division for Hose Assembly replacement information.
- Never touch or examine a failed Hose Assembly unless it is obvious that the Hose no longer contains fluid under pressure. The high pressure fluid is extremely dangerous and can cause serious and potentially fatal injury.
- 5.7 Elastomeric seals:** Elastomeric seals will eventually age, harden, wear and deteriorate under thermal cycling and compression set. Elastomeric seals should be inspected and replaced.
- 5.8 Refrigerant gases:** Special care should be taken when working with refrigeration systems. Sudden escape of refrigerant gases can cause blindness if the escaping gases contact the eye and can cause freezing or other severe injuries if it contacts any other portion of the body.
- 5.9 Compressed natural gas (CNG):** Parker CNG Hose Assemblies should be tested after installation and before use, and at least on a monthly basis per instructions provided on the Hose Assembly tag. The recommended procedure is to pressurize the Hose and check for leaks and to visually inspect the Hose for damage and to perform an electrical resistance test.
- Caution:** Matches, candles, open flame or other sources of ignition shall not be used for Hose inspection. Leak check solutions should be rinsed off after use.
- 6.0 HOSE STORAGE**
- 6.1 Age Control:** Hose and Hose Assemblies must be stored in a manner that facilitates age control and first-in and first-out usage based on manufacturing date of the Hose and Hose Assemblies. Unless otherwise specified by the manufacturer or defined by local laws and regulations:
- 6.1.1** The shelf life of rubber hose in bulk form or hose made from two or more materials is 28 quarters (7 years) from the date of manufacture, with an extension of 12 quarters (3 years), if stored in accordance with ISO 2230;
- 6.1.2** The shelf life of thermoplastic and polytetrafluoroethylene hose is considered to be unlimited;
- 6.1.3** Hose assemblies that pass visual inspection and proof test shall not be stored for longer than 2 years.
- 6.1.4 Storage:** Stored Hose and Hose Assemblies must not be subjected to damage that could reduce their expected service life and must be placed in a cool, dark and dry area with the ends capped. Stored Hose and Hose Assemblies must not be exposed to temperature extremes, ozone, oils, corrosive liquids or fumes, solvents, high humidity, rodents, insects, ultraviolet light, electromagnetic fields or radioactive materials.

Issue Date	ECO Number:	Revision Letter:	Revision Date:	Specification
24-SEP-2015	XXXXXX	A	30-OCT-2015	FC-Safety Guide

THIS DOCUMENT CONTAINS INFORMATION THAT IS CONFIDENTIAL AND PROPRIETARY TO PARKER HANNIFIN. THIS DOCUMENT IS FURNISHED ON THE UNDERSTANDING THAT THE DOCUMENT AND THE INFORMATION IT CONTAINS WILL NOT BE COPIED OR DISCLOSED TO OTHERS EXCEPT WITH THE WRITTEN CONSENT OF PARKER, WILL NOT BE USED FOR ANY PURPOSE OTHER THAN CONDUCTING BUSINESS WITH PARKER, AND WILL BE RETURNED AND ALL FURTHER USE DISCONTINUED UPON REQUEST BY PARKER. COPYRIGHT PARKER. YEAR OF COPYRIGHT IS FIRST YEAR INDICATED ON THIS DOCUMENT. ALL RIGHTS RESERVED

## Offer of Sale



- 1. Definitions.** As used herein, the following terms have the meanings indicated.
  - Buyer:** means any customer receiving a Quote for Products from Seller.
  - Goods:** means any tangible part, system or component to be supplied by the Seller.
  - Products:** means the Goods, Services and/or Software as described in a Quote provided by the Seller.
  - Quote:** means the offer or proposal made by Seller to Buyer for the supply of Products.
  - Seller:** means Parker-Hannifin Corporation, including all divisions and businesses thereof.
  - Services:** means any services to be supplied by the Seller.
  - Software:** means any software related to the Products, whether embedded or separately downloaded.
  - Terms:** means the terms and conditions of this Offer of Sale or any newer version of the same as published by Seller electronically at [www.parker.com/saleterms](http://www.parker.com/saleterms).
- 2. Terms.** All sales of Products by Seller are contingent upon, and will be governed by, these Terms and, these Terms are incorporated into any Quote provided by Seller to any Buyer. Buyer's order for any Products whether communicated to Seller verbally, in writing, by electronic data interface or other electronic commerce, shall constitute acceptance of these Terms. Seller objects to any contrary or additional terms or conditions of Buyer. Reference in Seller's order acknowledgement to Buyer's purchase order or purchase order number shall in no way constitute an acceptance of any of Buyer's terms of purchase. No modification to these Terms will be binding on Seller unless agreed to in writing and signed by an authorized representative of Seller.
- 3. Price; Payment.** The Products set forth in Seller's Quote are offered for sale at the prices indicated in Seller's Quote. Unless otherwise specifically stated in Seller's Quote, prices are valid for thirty (30) days and do not include any sales, use, or other taxes or duties. Seller reserves the right to modify prices at any time to adjust for any raw material price fluctuations. Unless otherwise specified by Seller, all prices are F.C.A. Seller's facility (INCOTERMS 2010). All sales are contingent upon credit approval and payment for all purchases is due thirty (30) days from the date of invoice (or such date as may be specified in the Quote). Unpaid invoices beyond the specified payment date incur interest at the rate of 1.5% per month or the maximum allowable rate under applicable law.
- 4. Shipment; Delivery; Title and Risk of Loss.** All delivery dates are approximate. Seller is not responsible for damages resulting from any delay. Regardless of the manner of shipment, delivery occurs and title and risk of loss or damage pass to Buyer, upon placement of the Products with the shipment carrier at Seller's facility. Unless otherwise agreed, Seller may exercise its judgment in choosing the carrier and means of delivery. No deferral of shipment at Buyers' request beyond the respective indicated shipping date will be made except on terms that will indemnify, defend and hold Seller harmless against all loss and additional expense. Buyer shall be responsible for any additional shipping charges incurred by Seller due to Buyer's acts or omissions.
- 5. Warranty.** The warranty related to the Products is as follows: (i) Goods are warranted against defects in material or workmanship for a period of twelve (12) months from the date of delivery or 2,000 hours of use, whichever occurs first; (ii) Services shall be performed in accordance with generally accepted practices and using the degree of care and skill that is ordinarily exercised and customary in the field to which the Services pertain and are warranted for a period of six (6) months from the completion of the Services by Seller; and (iii) Software is only warranted to perform in accordance with applicable specifications provided by Seller to Buyer for ninety (90) days from the date of delivery or, when downloaded by a Buyer or end-user, from the date of the initial download. All prices are based upon the exclusive limited warranty stated above, and upon the following disclaimer:  
**DISCLAIMER OF WARRANTY: THIS WARRANTY IS THE SOLE AND ENTIRE WARRANTY PERTAINING TO PRODUCTS. SELLER DISCLAIMS ALL OTHER WARRANTIES, EXPRESS AND IMPLIED, INCLUDING DESIGN, NONINFRINGEMENT, MERCHANTABILITY, AND FITNESS FOR A PARTICULAR PURPOSE. SELLER DOES NOT WARRANT THAT THE SOFTWARE IS ERROR-FREE OR FAULT-TOLERANT, OR THAT BUYER'S USE THEREOF WILL BE SECURE OR UNINTERRUPTED. BUYER AGREES AND ACKNOWLEDGES THAT UNLESS OTHERWISE AUTHORIZED IN WRITING BY SELLER THE SOFTWARE SHALL NOT BE USED IN CONNECTION WITH HAZARDOUS OR HIGH RISK ACTIVITIES OR ENVIRONMENTS. EXCEPT AS EXPRESSLY STATED HEREIN, ALL PRODUCTS ARE PROVIDED "AS IS".**
- 6. Claims; Commencement of Actions.** Buyer shall promptly inspect all Products upon receipt. No claims for shortages will be allowed unless reported to the Seller within ten (10) days of delivery. Buyer shall notify Seller of any alleged breach of warranty within thirty (30) days after the date the non-conformance is or should have been discovered by Buyer. Any claim or action against Seller based upon breach of contract or any other theory, including tort, negligence, or otherwise must be commenced within twelve (12) months from the date of the alleged breach or other alleged event, without regard to the date of discovery.
- 7. LIMITATION OF LIABILITY.** IN THE EVENT OF A BREACH OF WARRANTY, SELLER WILL, AT ITS OPTION, REPAIR OR REPLACE THE NON-CONFORMING PRODUCT, RE-PERFORM THE SERVICES, OR REFUND THE PURCHASE PRICE PAID WITHIN A REASONABLE PERIOD OF TIME. **IN NO EVENT IS SELLER LIABLE FOR ANY SPECIAL, INDIRECT, INCIDENTAL OR CONSEQUENTIAL DAMAGES ARISING OUT OF, OR AS THE RESULT OF, THE SALE, DELIVERY, NON-DELIVERY, SERVICING, NON-COMPLETION OF SERVICES, USE, LOSS OF USE OF, OR INABILITY TO USE THE PRODUCTS OR ANY PART THEREOF, LOSS OF DATA, IDENTITY, PRIVACY, OR CONFIDENTIALITY, OR FOR ANY CHARGES OR EXPENSES OF ANY NATURE INCURRED WITHOUT SELLER'S WRITTEN CONSENT, WHETHER BASED IN CONTRACT, TORT OR OTHER LEGAL THEORY. IN NO EVENT SHALL SELLER'S LIABILITY UNDER ANY CLAIM MADE BY BUYER EXCEED THE PURCHASE PRICE PAID FOR THE PRODUCTS.**
- 8. Loss to Buyer's Property.** Any designs, tools, patterns, materials, drawings, confidential information or equipment furnished by Buyer or any other items which are or become Buyer's property, will be considered obsolete and may be destroyed by Seller after two (2) consecutive years have elapsed without Buyer ordering the Products manufactured using such property. Seller shall not be responsible for any loss or damage to such property while it is in Seller's possession or control.
- 9. Special Tooling.** Special Tooling includes but is not limited to tooling, jigs, fixtures and associated manufacturing equipment acquired or necessary to manufacture Products. A tooling charge may be imposed for any Special Tooling. Such Special Tooling shall be and remain Seller's property notwithstanding payment of any charges by Buyer. In no event will Buyer acquire any interest in Special Tooling belonging to Seller that is utilized in the manufacture of the Products, even if such Special Tooling has been specially converted or adapted for such manufacture and notwithstanding any charges paid by Buyer. Unless otherwise agreed, Seller has the right to alter, discard or otherwise dispose of any Special Tooling or other property in its sole discretion at any time.
- 10. Security Interest.** To secure payment of all sums due, Seller retains a security interest in all Products delivered to Buyer and, Buyer's acceptance of these Terms is deemed to be a Security Agreement under the Uniform Commercial Code. Buyer authorizes Seller as its attorney to execute and file on Buyer's behalf all documents Seller deems necessary to perfect its security interest.
- 11. User Responsibility.** The Buyer through its own analysis and testing, is solely responsible for making the final selection of the Products and assuring that all performance, endurance, maintenance, safety and warning requirements of the application of the Products are met. The Buyer must analyze all aspects of the application and follow applicable industry standards, specifications, and other technical information provided with the Product. If Seller provides Product options based upon data or specifications provided by the Buyer, the Buyer is responsible for determining that such data and specifications are suitable and sufficient for all applications and reasonably foreseeable uses of the Products. In the event the Buyer is not the end-user, Buyer will ensure such end-user complies with this paragraph.
- 12. Use of Products, Indemnity by Buyer.** Buyer shall comply with all instructions, guides and specifications provided by Seller with the Products.  
**Unauthorized Uses.** If Buyer uses or resells the Products for any uses prohibited in Seller's instructions, guides or specifications, or Buyer otherwise fails to comply with Seller's instructions, guides and specifications, Buyer acknowledges that any such use, resale, or non-compliance is at Buyer's sole risk. Buyer shall indemnify, defend, and hold Seller harmless from any losses, claims, liabilities, damages, lawsuits, judgments and costs (including attorney fees and defense costs), whether for personal injury, property damage, intellectual property infringement or any other claim, brought by or incurred by Buyer, Buyer's employees, or any other person, arising out of: (a) improper selection, application, design, specification or other misuse of Products provided by Seller; (b) any act or omission, negligent or otherwise,



of Buyer; (c) Seller's use of patterns, tooling, equipment, plans, drawings, designs or specifications or other information or things furnished by Buyer; (d) damage to the Products from an external cause, repair or attempted repair by anyone other than Seller, failure to follow instructions, guides and specifications provided by Seller, use with goods not provided by Seller, or opening, modifying, deconstructing or tampering with the Products for any reason; or (e) Buyer's failure to comply with these Terms. Seller shall not indemnify Buyer under any circumstance except as otherwise provided in these Terms.

**13. Cancellations and Changes.** Buyer may not cancel or modify any order for any reason, except with Seller's written consent and upon terms that will indemnify, defend and hold Seller harmless against all direct, incidental and consequential loss or damage. Seller, at any time, may change Product features, specifications, designs and availability.

**14. Limitation on Assignment.** Buyer may not assign its rights or obligations without the prior written consent of Seller.

**15. Force Majeure.** Seller does not assume the risk and is not liable for delay or failure to perform any of Seller's obligations by reason of events or circumstances beyond its reasonable control ("Events of Force Majeure"). Events of Force Majeure shall include without limitation: accidents, strikes or labor disputes, acts of any government or government agency, acts of nature, delays or failures in delivery from carriers or suppliers, shortages of materials, or any other cause beyond Seller's reasonable control.

**16. Waiver and Severability.** Failure to enforce any provision of these Terms will not invalidate that provision; nor will any such failure prejudice Seller's right to enforce that provision in the future. Invalidation of any provision of these Terms by legislation or other rule of law shall not invalidate any other provision herein and, the remaining provisions will remain in full force and effect.

**17. Termination.** Seller may terminate any agreement governed by or arising from these Terms for any reason and at any time by giving Buyer thirty (30) days prior written notice. Seller may immediately terminate, in writing, if Buyer: (a) breaches any provision of these Terms (b) appoints a trustee, receiver or custodian for all or any part of Buyer's property (c) files a petition for relief in bankruptcy on its own behalf, or one if filed by a third party (d) makes an assignment for the benefit of creditors; or (e) dissolves its business or liquidates all or a majority of its assets.

**18. Ownership of Software.** Seller retains ownership of all Software supplied to Buyer hereunder. In no event shall Buyer obtain any greater right in and to the Software than a right in the nature of a license limited to the use thereof and subject to compliance with any other terms provided with the Software.

**19. Indemnity for Infringement of Intellectual Property Rights.** Seller is not liable for infringement of any patents, trademarks, copyrights, trade dress, trade secrets or similar rights ("Intellectual Property Rights") except as provided in this Section. Seller will defend at its expense and will pay the cost of any settlement or damages awarded in an action brought against Buyer based on a third party claim that one or more of the Products sold hereunder infringes the Intellectual Property Rights of a third party in the country of delivery of the Products by the Seller to the Buyer. Seller's obligation to defend and indemnify Buyer is contingent on Buyer notifying Seller within ten (10) days after Buyer becomes aware of any such claim, and Seller having sole control over the defense of the claim including all negotiations for settlement or compromise. If one or more Products sold hereunder is subject to such a claim, Seller may, at its sole expense and option, procure for Buyer the right to continue using the Products, replace or modify the Products so as to render them non-infringing, or offer to accept return of the Products and refund the purchase price less a reasonable allowance for depreciation. Seller has no obligation or liability for any claim of infringement: (i) arising from information provided by Buyer; or (ii) directed to any Products provided hereunder for which the designs are specified in whole or part by Buyer; or (iii) resulting from the modification, combination or use in a system of any Products provided hereunder. The foregoing provisions of this Section constitute Seller's sole and exclusive liability and Buyer's sole and exclusive remedy for such claims of infringement of Intellectual Property Rights.

**20. Governing Law.** These Terms and the sale and delivery of all Products are deemed to have taken place in, and shall be governed and construed in accordance with, the laws of the State of Ohio, as applicable to contracts executed and wholly performed therein and without regard to conflicts of laws principles. Buyer irrevocably agrees and consents to the exclusive jurisdiction and venue of the courts of Cuyahoga County, Ohio with respect to any dispute, controversy or claim arising out of or relating to the sale and delivery of the Products.

**21. Entire Agreement.** These Terms, along with the terms set forth in the main body of any Quote, forms the entire agreement between the Buyer and Seller and constitutes the final, complete and exclusive expression of the terms of sale. In the event of a conflict between any term set forth in the main body of a Quote and these Terms, the terms set forth in the main body of the Quote shall prevail. All prior or contemporaneous written or oral agreements or negotiations with respect to the subject matter shall have no effect. These Terms may not be modified unless in writing and signed by an authorized representative of Seller.

**22. Compliance with Laws.** Buyer agrees to comply with all applicable laws, regulations, and industry and professional standards, including those of the United States of America, and the country or countries in which Buyer may operate, including without limitation the U.S. Foreign Corrupt Practices Act ("FCPA"), the U.S. Anti-Kickback Act ("Anti-Kickback Act"), U.S. and E.U. export control and sanctions laws ("Export Laws"), the U.S. Food Drug and Cosmetic Act ("FDCA"), and the rules and regulations promulgated by the U.S. Food and Drug Administration ("FDA"), each as currently amended. Buyer agrees to indemnify, defend, and hold harmless Seller from the consequences of any violation of such laws, regulations and standards by Buyer, its employees or agents. Buyer acknowledges that it is familiar with all applicable provisions of the FCPA, the Anti-Kickback Act, Export Laws, the FDCA and the FDA and certifies that Buyer will adhere to the requirements thereof and not take any action that would make Seller violate such requirements. Buyer represents and agrees that Buyer will not make any payment or give anything of value, directly or indirectly, to any governmental official, foreign political party or official thereof, candidate for foreign political office, or commercial entity or person, for any improper purpose, including the purpose of influencing such person to purchase Products or otherwise benefit the business of Seller. Buyer further represents and agrees that it will not receive, use, service, transfer or ship any Product from Seller in a manner or for a purpose that violates Export Laws or would cause Seller to be in violation of Export Laws.



# Parker's Motion & Control Product Groups

At Parker, we're guided by a relentless drive to help our customers become more productive and achieve higher levels of profitability by engineering the best systems for their requirements. It means looking at customer applications from many angles to find new ways to create value. Whatever the motion and control technology need, Parker has the experience, breadth of product and global reach to consistently deliver. No company knows more about motion and control technology than Parker. For further info call 1 800 C-Parker (1 800 272 7537).



## Aerospace

### Key Markets

Aftermarket services  
Commercial transports  
Engines  
General & business aviation  
Helicopters  
Launch vehicles  
Military aircraft  
Missiles  
Power generation  
Regional transports  
Unmanned aerial vehicles

### Key Products

Control systems & actuation products  
Engine systems & components  
Fluid conveyance systems & components  
Fluid metering, delivery & atomization devices  
Fuel systems & components  
Fuel tank inerting systems  
Hydraulic systems & components  
Thermal management  
Wheels & brakes



## Automation

### Key Markets

Alternative energy  
Conveyor & material handling  
Factory automation  
Food & beverage  
Life sciences & medical  
Machine tools  
Packaging machinery  
Paper machinery  
Plastics machinery  
Primary metals  
Safety & security  
Semiconductor & electronics  
Transportation & automotive

### Key Products

AC/DC drives & systems  
Air preparation  
Electric actuators, gantry robots & slides  
Human machine interfaces  
Inverters  
Manifolds  
Miniature fluidics  
Pneumatic actuators & grippers  
Pneumatic valves & controls  
Rotary actuators  
Stepper motors, servo motors, drives & controls  
Structural extrusions  
Vacuum generators, cups & sensors



## Climate & Industrial Controls

### Key Markets

Agriculture  
Air conditioning  
Construction Machinery  
Food & beverage  
Industrial machinery  
Life sciences  
Oil & gas  
Precision cooling  
Process  
Refrigeration  
Transportation

### Key Products

Accumulators  
Advanced actuators  
CO<sub>2</sub> controls  
Electronic controllers  
Filter driers  
Hand shut-off valves  
Heat exchangers  
Hose & fittings  
Pressure regulating valves  
Refrigerant distributors  
Safety relief valves  
Smart pumps  
Solenoid valves  
Thermostatic expansion valves



## Filtration

### Key Markets

Aerospace  
Food & beverage  
Industrial plant & equipment  
Life sciences  
Marine  
Mobile equipment  
Oil & gas  
Power generation & renewable energy  
Process  
Transportation  
Water Purification

### Key Products

Analytical gas generators  
Compressed air filters & dryers  
Engine air, coolant, fuel & oil filtration systems  
Fluid condition monitoring systems  
Hydraulic & lubrication filters  
Hydrogen, nitrogen & zero air generators  
Instrumentation filters  
Membrane & fiber filters  
Microfiltration  
Sterile air filtration  
Water desalination & purification filters & systems

TABLE OF CONTENTS



## Fluid Connectors

### Key Markets

Aerial lift  
Agriculture  
Bulk chemical handling  
Construction machinery  
Food & beverage  
Fuel & gas delivery  
Industrial machinery  
Life sciences  
Marine  
Mining  
Mobile  
Oil & gas  
Renewable energy  
Transportation

### Key Products

Check valves  
Connectors for low pressure fluid conveyance  
Deep sea umbilicals  
Diagnostic equipment  
Hose couplings  
Industrial hose  
Mooring systems & power cables  
PTFE hose & tubing  
Quick couplings  
Rubber & thermoplastic hose  
Tube fittings & adapters  
Tubing & plastic fittings



## Hydraulics

### Key Markets

Agriculture  
Alternative energy  
Construction machinery  
Forestry  
Industrial machinery  
Machine tools  
Marine  
Material handling  
Mining  
Oil & gas  
Power generation  
Refuse vehicles  
Renewable energy  
Truck hydraulics  
Turf equipment

### Key Products

Accumulators  
Cartridge valves  
Electrohydraulic actuators  
Human machine interfaces  
Hybrid drives  
Hydraulic cylinders  
Hydraulic motors & pumps  
Hydraulic systems  
Hydraulic valves & controls  
Hydrostatic steering  
Integrated hydraulic circuits  
Power take-offs  
Power units  
Rotary actuators  
Sensors



## Instrumentation

### Key Markets

Alternative fuels  
Biopharmaceuticals  
Chemical & refining  
Food & beverage  
Marine & shipbuilding  
Medical & dental  
Microelectronics  
Nuclear Power  
Offshore oil exploration  
Oil & gas  
Pharmaceuticals  
Power generation  
Pulp & paper  
Steel  
Water/wastewater

### Key Products

Analytical Instruments  
Analytical sample conditioning products & systems  
Chemical injection fittings & valves  
Fluoropolymer chemical delivery fittings, valves & pumps  
High purity gas delivery fittings, valves, regulators & digital flow controllers  
Industrial mass flow meters/ controllers  
Process control double block & bleeds  
Process control fittings, valves, regulators & manifold valves  
Permanent no-weld tube fittings  
Precision industrial regulators & flow controllers



## Seal

### Key Markets

Aerospace  
Chemical processing  
Consumer  
Fluid power  
General industrial  
Information technology  
Life sciences  
Microelectronics  
Military  
Oil & gas  
Power generation  
Renewable energy  
Telecommunications  
Transportation

### Key Products

Dynamic seals  
Elastomeric o-rings  
Electro-medical instrument design & assembly  
EMI shielding  
Extruded & precision-cut, fabricated elastomeric seals  
High temperature metal seals  
Homogeneous & inserted elastomeric shapes  
Medical device fabrication & assembly  
Metal & plastic retained composite seals  
Shielded optical windows  
Silicone tubing & extrusions  
Thermal management  
Vibration dampening



**GOODYEAR**  
RUBBER PRODUCTS, INC.

+1.727.342.5087

También puede enviarnos un correo electrónico a [ventas@goodyearrubberproducts.com](mailto:ventas@goodyearrubberproducts.com)



# Parker Fluid Connectors Group North American Divisions & Distribution Service Centers

TABLE  
OF  
CONTENTS

**Your complete source** for quality tube fittings, hose & hose fittings, brass & composite fittings, quick-disconnect couplings, valves and assembly tools, locally available from a worldwide network of authorized distributors.

**Fittings:**

Available in inch and metric sizes covering SAE, BSP, DIN, GAZ, JIS and ISO thread configurations, manufactured from steel, stainless steel, brass, aluminum, nylon and thermoplastic.

**Hose, Tubing and Bundles:**

Available in a wide variety of sizes and materials including rubber, wire-reinforced, thermoplastic, hybrid and custom compounds.

**Worldwide Availability:**

Parker operates Fluid Connectors manufacturing locations and sales offices throughout North America, South America, Europe and Asia-Pacific.

**For information**, call toll free...

**1-800-C-PARKER  
(1-800-272-7537)**

## North American Divisions

### Fluid System Connectors Division

Otsego, MI  
phone 269 694 9411  
fax 269 694 4614

### Hose Products Division

Wickliffe, OH  
phone 440 943 5700  
fax 440 943 3129

### Parflex Division

Ravenna, OH  
phone 330 296 2871  
fax 330 296 8433

### Quick Coupling Division

Minneapolis, MN  
phone 763 544 7781  
fax 763 544 3418

### Tube Fittings Division

Columbus, OH  
phone 614 279 7070  
fax 614 279 7685

## Distribution Service Centers

### Buena Park, CA

phone 714 522 8840  
fax 714 994 1183

### Louisville, KY

phone 502 937 1322  
fax 502 937 4180

### Portland, OR

phone 503 283 1020  
fax 503 283 2201

### Toledo, OH

phone 419 878 7000  
fax 419 878 7001  
fax 419 878 7420  
(FCG Kit Operations)

### Canada

#### Milton, ONT

phone 905 693 3000  
fax 905 876 1958  
(Contact Milton for other Service Center locations.)

### Mexico

#### Toluca, MEX

phone (52) 722 2754 200  
fax (52) 722 2722 168

Parker Hannifin Corporation

### Tube Fittings Division

3885 Gateway Blvd.  
Columbus, OH 43228  
phone 614 279 7070  
fax 614 279 7868  
[www.parker.com/tfd](http://www.parker.com/tfd)

