



OTSEGO, MICHIGAN



TIJUANA, MEXICO



ALBION, INDIANA



LAKEVIEW, MICHIGAN



MESA, ARIZONA

⚠ WARNING – USER RESPONSIBILITY

FAILURE OR IMPROPER SELECTION OR IMPROPER USE OF THE PRODUCTS DESCRIBED HEREIN OR RELATED ITEMS CAN CAUSE DEATH, PERSONAL INJURY AND PROPERTY DAMAGE.

This document and other information from Parker-Hannifin Corporation, its subsidiaries and authorized distributors provide product or system options for further investigation by users having technical expertise.

The user, through its own analysis and testing, is solely responsible for making the final selection of the system and components and assuring that all performance, endurance, maintenance, safety and warning requirements of the application are met. The user must analyze all aspects of the application, follow applicable industry standards, and follow the information concerning the product in the current product catalog and in any other materials provided from Parker or its subsidiaries or authorized distributors.

To the extent that Parker or its subsidiaries or authorized distributors provide component or system options based upon data or specifications provided by the user, the user is responsible for determining that such data and specifications are suitable and sufficient for all applications and reasonably foreseeable uses of the components or systems.

Offer of Sale

The items described in this document are hereby offered for sale by Parker Hannifin Corporation, its subsidiaries or its authorized distributors. This offer and its acceptance are governed by the provisions stated on the separate page of this document entitled "Offer of Sale".

Safe Drinking Water Act

In accordance with 42 USC § 300g-6, parts in this catalog are to be used exclusively for nonpotable services such as manufacturing, industrial processing, irrigation, outdoor watering, or any other uses where the water is not anticipated to be used for human consumption. The only exceptions are parts described explicitly as "low lead" or suitable for potable water.

© Copyright 1997, Parker Hannifin Corporation, All Rights Reserved

GOODYEAR
RUBBER PRODUCTS, INC.

+1.727.342.5087

**También puede enviarnos un correo electrónico a
ventas@goodyearrubberproducts.com**

Directives and Regulations

Parker complies with the directives and regulations listed below and goes beyond its statutory obligations for the ranges in question.



D.O.T. FMVSS 571.106
Fittings comply with the performance requirements



European RoHS directives: 2015/863
Relating to the limitation of the use of 10 hazardous substances in electrical and electronic equipment (Lead, Mercury, Cadmium, Hexavalent Chromium, PBB, PBDE, Bis Phthalate, BBP, DBP, DIBP).



Fittings meet the requirements of the specific SAE standard called out in the product sections



CFR 21: Code of Federal Regulation Title 21: Food and Drugs
This code consists of lists of prohibited substances for materials intended to come into contact with foodstuffs.



DIN 74324
Fittings comply with the performance requirements



Regulation 1935/2004
This framework regulation relates to materials and objects designed to come into contact with foodstuffs. It describes specific measures per product group (Art. 5).



Fittings are listed under 1 of 3 categories depending on the application. Fittings meet dimensional and testing requirements as specified by Underwriter Laboratories and carry the UL symbol.



NSF 51: NSF / ANSI-51
Fittings and tubes complying with this standard are tested and approved by NSF for contact with drinks and foodstuffs.



ISO 6149-3
Fittings meet the dimensional requirements



NSF 61: NSF / ANSI-61
Fittings and tubes complying with this standard are tested and approved by NSF for contact with drinking water.



Gold Seal Program
Fittings comply with the ANSI standards and approved by WQA for contact with drinks and foodstuffs.



NSF 42 and 58: NSF/ANSI-42/58
Tubes complying with this standard are tested and approved by NSF for drinking water treatment systems.



REACH regulation: no. 1907/2006
As product manufacturer, we are subject to article 33 of the regulation which defines a duty to inform when a candidate substance is present at more than 0.1% weight for weight.



WRAS: Water Regulations Advisory Scheme
(UK) Fittings approved by this programme are declared compliant for water supply by WRc - NSF.



WHAT DOWNTIME?



THE QUALITY OF YOUR CONNECTORS MAKES A DIFFERENCE

When a line or machine stops due to a defective part, the cost of the downtime is greater than the cost of all the connectors. That's why we guarantee the quality and traceability of every connector we sell. And why our products meet or exceed both national and international standards.

It's what keeps your employees safe, your lines and machines running, and your productivity high.

REACH ✓

FDA



RoHS 2002/95/EC ✓

CE

NSF

DIN



ISO

SAE



UL

WRAS APPROVED PRODUCT

WHY PARKER

FOR FLUID SYSTEM CONNECTORS

More Selection



More Materials

Materials suited to your application, including plastic, composite, brass, stainless steel, and plated brass.

More Connector Styles

Choose from push-to-connect, compression, barbed, flare, and pipe fittings, as well as flow controls, ball valves, angle stops, manifolds, and cartridges in both inch and metric sizes from 1/8" to 1-1/2".

Customized Solutions

Don't be boxed in by conventional thinking or the conventional parts that go with it. Whether you need a valve, fitting or manifold, we can produce it in any quantity or configuration, with any connector end.

For prototypes, one-of-a-kind pieces, and emergency repair parts to small or large production runs, our customized solutions can reduce lead times as well as the price of lower-volume components. Three of our locations now specialize in non-standard service, ensuring you get what you need ASAP. Plus they comply with SAE, ISO, DIN, JIS, ASTM, and MIL standards.



Lower Overall Product Cost

Due to tested and approved products with longer life

Find Your Fittings Solution. Fast.

The FittingFinder app helps identify replacement fittings, pull specs and dimensions, locate nearby distributors and more.



The Power of Partnership

13,000

distributors, sales offices, and MRO outlets – instant access to parts, products, maintenance, service, and solutions.

THE PARKER BINS PROGRAM



A line of bins and cabinets used for bin fill placements at OEM and MRO accounts. Sizes and styles range from scoop boxes to open bins and a rolling pneumatic cabinet for storage flexibility. Bins provide increased visibility of Parker products and centralize all fittings needed in one location. When paired with Parker's Bin Labeling Program, distributors can offer customers the benefits of simple part identification and easy restocking.

www.parker.com/bins

Reliable System Solutions

Fittings, valves, and manifolds engineered to work together to provide easy-to-assemble, leak-free connections.

Reduced Time to Market



Our ability to design, prototype, and manufacture world-wide will shorten your design cycle, improve production efficiency, and simplify procurement procedures.



Global and Local Support

Your language, your time zone, your currency. No matter where you develop, assemble, manufacture or install, Parker is there.

WHY PARKER FOR FLUID SYSTEM CONNECTORS



EDI Transmission

Computerized data exchange to increase productivity and speed communication.



Improved Stock Management

Packaging, barcodes, and customized labels according to your needs.



E-Catalog

Integration of our product data into your information systems (e-procurement, e-commerce site, etc.)

Communication Tools

We can provide you with any promotional sales material you might need, from brochures and flash animations to sample kits.



PRODUCTS FOR NEWLY MANDATED POTABLE WATER SYSTEMS

Effective on January 4, 2014, amendments to the Safe Drinking Water Act (42 USC § 300g-6) now limit the lead content of components installed in potable water systems to 0.25% weighted average. Potable water systems are systems that provide water suitable for human ingestion i.e., drinking, food preparation, dishwashing, and maintaining

The good news? Our LIQUIfit™ and TrueSeal™ fittings, valves, angle stops, and cartridges are already NSF and FDA approved and conform to the new “lead free” standard. In addition, we offer pipe and compression products in “lead free” brass and can quote “lead free” fittings as a special.

ParkerStores

Around the corner and around the world, ParkerStores meet customer needs to stay productive by providing the broadest range of products and service choices. Whether for individual parts or entire system solutions, the professionals at the ParkerStore are here to help. Visit us online at www.parkerstore.com.



PTAC

Through education and technical training on FCG products and safe practices, the Parker Training and Certification (P-TAC) program is designed to improve the professionalism and technical skills of participating distributors and Parker employees.



Kitting

Multiple components in a customized kit with a single part number for easier order processing and assembly.



CAD Library

Available online at www.parker.com. Dimensional drawings of every product in various industry formats to help in the design process.



MEETING STRINGENT SANITARY AND ASEPTIC STANDARDS IN FOOD PROCESSING AND PACKAGING

Connecting you to reduced downtime, increased throughput, and lower maintenance costs

Market research firm RTS Resource says natural highs, one-step convenience, foraged ingredients, flavor-full benefits, and next generation proteins are the five key food and drink trends to watch in the future.

Innova Market Insights has also highlighted the key issues of reducing waste and regaining consumer trust as top food industry trends to look out for. Plus the need for food safety will remain paramount.

FOOD PROCESSING AND PACKAGING

APPLICATIONS

Mixing | Baking | Cooling | Packaging | Filling | Washing | Labeling | Conveying

PERFORMANCE EXPECTATIONS

- FDA compliance
- Hygienic design
- Compact
- Highly reliable
- Ability to work in a vacuum
- Wide range of chemical compatibility
- Ability to withstand high temperatures
- Detectability



APPLICABLE PRODUCTS

- Prestolok® PLM Metal Fittings
- Prestolok® PLS Stainless Steel Fittings
- LIQUIfit™ Fittings and Valves
- TrueSeal™ Fittings and Ball Valves
- Flow Controls
- Stainless Steel Flow Controls



ENGINEERING DURABILITY

Withstanding harsh washdown chemicals



Situation: A food processing equipment manufacturer was receiving customer complaints about fittings that degraded when exposed to harsh washdown chemicals in food processing plants.

Solution: Parker's Prestolok® Composite fittings. Manufactured from an engineered grade of glass-filled nylon, the fittings withstood exposure to the aggressive washdown chemicals. Additionally, the compact fittings, available in a wide variety of configurations, maintained full airflow throughout the system, which allowed the equipment designers to optimize the routings.

Benefits: Reduced warranty service • Reduced component quantity • Reduced energy consumption due to full-flow design





COLLABORATING FOR LEAK-FREE INNOVATION IN LIFE SCIENCE

Connecting you to higher productivity,
increased efficiency, and faster assembly



According to Deloitte, a changing health care landscape, expiring patents, generic competition, pricing pressures, heightened regulatory scrutiny, expansion into emerging markets, increasing alliances and acquisitions, and a persistent economic slowdown are prompting global life sciences companies to adopt new business models designed to counter slowing sales growth and declining profitability, deliver better patient outcomes at lower cost, and position them for success.

APPLICATIONS

Oxygen Transfer | Fluid Transfer | Dispensing | Cleaning and Sterilization | Pneumatic Circuits



PERFORMANCE EXPECTATIONS

- Quality traceability
- Cleanliness
- Compact design
- Suitable for use with O₂
- High reliability
- Installation flexibility

APPLICABLE PRODUCTS

Prestolok® PLM Metal Fittings
Prestolok® PLS Stainless Steel Fittings
LIQUIfit™ Fittings and Valves
TrueSeal™ Fittings and Ball Valves
Stainless Steel Flow Controls



ENGINEERING INTEGRATED ASSEMBLIES

Single-piece solution simplifies, speeds, and economizes



Situation: A major medical OEM was using a very labor-intensive, six-step assembly process for an oxygen service connection.

Solution: Working with a distributor, Parker developed a customized, single-piece filtering cartridge, cleaned for oxygen use. The OEM was able to eliminate five components and five assembly steps, saving \$19.88 per unit. With 3,000 units annually, the OEM was able to reduce total costs by \$59,640.

Benefits: Reduced assembly time and installation labor costs • Reduced type and quantity of components • Reduced potential leak points • Reduced total product costs





IN WATER AND BEVERAGE: KEEPING IT CLEAN, KEEPING IT SAFE

Connecting you to leak-free innovation,
smaller footprints, and faster assembly



According to Innova Market Insights, now is the time for the small innovator who develops a distinct product. These products' small-scale appeal will be accompanied by big trend potential accelerated by social media platforms. A more holistic approach to nutritious beverage solutions is another trend. These "well drink" trends will include more function in functional beverages, better sweetened drinks, and healthy alcohol-based beverages.

APPLICATIONS

Filtration | Purification | Processing | Dispensing | Bottling | Treatment | Aeroponics

PERFORMANCE EXPECTATIONS

- Manufactured from FDA-compliant materials
- Meet NSF-61 requirements for potable water contact
- Excellent chemical resistance
- Wide range of fluid compatibility
- Mechanical resistance
- Installation flexibility



DID YOU KNOW?

Parker's entire TrueSeal™ line is now available in Kynar. A fluoropolymer with excellent chemical and abrasion resistance, mechanical strength, and dielectric properties, Kynar is an excellent choice for high purity water.

APPLICABLE PRODUCTS

Check Valves

LIQUIfit™ Fittings

LIQUIfit™ Ball Valves

TrueSeal™ Thermoplastic Fittings

TrueSeal™ Ball Valves

Fast & Tite® Fittings

Par-Barb® Fittings



NEW LOW LEAD AMENDMENT

What it means for you



Effective January 4, 2014, all products in contact with drinking water were limited to a maximum lead content of 0.25% for all wetted components. The new rule, which mostly replicated California's regulation governing lead in drinking water, impacts virtually every component of a water treatment and distribution system, as well as services and applications that provide water suitable for human ingestion (think food preparation, beverage manufacturing, and dishwashing, for example).

Products excluded from the lead rule include those used exclusively for non-potable services such as manufacturing, industrial processing, and irrigation. Leaded components already in use by the January 4th deadline are grandfathered in. Repairs can be made in place, but once a leaded component is removed for any reason, it must be replaced with a lead-free component.

Parker Fluid System Connectors is committed to growing its "lead free" product offerings in both brass and polymer product ranges. Our existing low lead products - LIQUIfit™, TrueSeal™, and Green Brass - are available in a range of styles and are:

- Suitable for high-pressure brewing and dispensing at temperatures up to 400°F
- Flavor-neutral
- Designed for harsh commercial environments
- More cost effective than other metals, including stainless steel



IMPROVING DURABILITY, LESSENING RISK IN PETROCHEMICAL MANUFACTURING

Connecting you to higher productivity,
faster assembly, and leak-free innovation

The Institute for Trend Research predicted 2014 would be a growth year for North American petrochemical manufacturers. Abundant gas, tight oil, and potential energy self-sufficiency would spur investments in the U.S. and Canada. Overseas opportunities from emerging countries would also increase. This very strong growth is predicted to continue the following year. As a result, companies should focus now on cutting costs, right-sizing, creating new products, and hiring good people to take advantage of the upswing.

PETROCHEMICAL MANUFACTURING

APPLICATIONS

Processing | Transferring | Pneumatic Circuits | Cooling | Measuring



PERFORMANCE EXPECTATIONS

- High chemical resistance
- Robust design
- Excellent chemical compatibility
- Wide temperature range
- Quality traceability

CASE STUDY:

TrueSeal™ Kynar® Thermoplastic Fittings



Polyvinylidene fluoride, or PVDF – also known as Kynar – is a fluoropolymer that has excellent abrasion resistance, dielectric properties, and mechanical strength. In the area of chemical compatibility, Kynar is highly resistant to wet or dry chlorine, bromine, and other halogens, alcohols, strong acids, aliphatics, aromatics, and chlorinated solvents.

That makes our TrueSeal Kynar fittings an excellent choice for chemical processing, as well as manufacturing involving exposure to chlorine, solvents, and UV-sensitive chemicals.

APPLICABLE PRODUCTS

- Prestolok® PLM Metal Fittings
- Prestolok® PLS Stainless Steel Fittings
- Prestolok® PLP Metal Fittings
- Stainless Steel Check Valves
- Stainless Steel Flow Controls
- TrueSeal™ Kynar® Fittings



Kynar® is a registered trademark of Arkema Group.



INCREASING PERFORMANCE, STANDARDIZING INVENTORY IN FACTORY / PROCESS AUTOMATION

Connecting you to increased efficiency, improved
throughput, and bottom line benefits



According to IMS research, the global industrial automation market will profit from improved economies worldwide. Frost and Sullivan predicts factories will utilize cloud computing, cyber security and mobile communication technologies to evolve into information and data hubs providing interaction between the factory floor and the enterprise across all end users. Asset management and flexible manufacturing will also play a role in driving factory enterprise integration.

FACTORY / PROCESS AUTOMATION

APPLICATIONS

Processing | Transferring | Pneumatic Circuits | Cooling | Measuring

ENGINEERING PRODUCTION THROUGHPUT

Higher flow and more accurate speed control enhance process automation for a faster production rate



Situation: A food packaging integrator built a custom piece of equipment to transfer uncooked product in and out of curing ovens. The rodless cylinder used to shuttle racks from the conveyor into the ovens was not moving fast enough to keep up with the anticipated production rate.

Solution: Parker replaced the rodless cylinder with a smaller Parker Legris flow control, creating faster rack movement and finer speed adjustment. The advanced flow control is now standard for the company's pneumatic cylinders.

Benefits: Optimal flow • Finer speed adjustment • Enhanced production rate



PERFORMANCE EXPECTATIONS

- Compact design
- Weld spatter resistance
- Robustness
- Vacuum performance
- High reliability
- Mechanical resistance
- Installation flexibility

APPLICABLE PRODUCTS

Prestolok® PLP Metal Fittings
Prestolok® PLP Composite Fittings
Prestolok® PLM Metal Fittings
Flow Controls





IN TRANSPORTATION, GLOBAL LOGISTICS AND VENDOR PARTNERSHIPS

Connecting you to higher productivity, increased efficiencies, and improved inventory management

Industry experts see growth for the U.S. in most modes of transportation, particularly truck, rail, and intermodal. With the global economy still on the mend, trade is predicted to grow at a modest 3-4% as developed nations contend with weak growth, eurozone debt, a slowdown in China as well as other emerging economies, and unpredictable oil prices. Concern over environmental issues will continue, spurring biofuels and hybrid vehicles. The need for global system solution partners will remain strong.

APPLICATIONS

Air Brakes | Cab Controls | Fuel System | Engine | Transmission | Cooling | Air Tanks



PERFORMANCE EXPECTATIONS

- Compact design
- Impact resistant
- Meets DOT and SAE requirements
- Robustness
- Vibration resistance
- High reliability
- High temperature resistance
- Installation flexibility

APPLICABLE PRODUCTS

PTC Brass Fittings

PTC/PTCR Composite Fittings

SAE Encapsulated Cartridges

Manifolds

NTA Fittings

Transmission Fittings

Vibra-Lok Fittings

Truck Valves

Lanyard Valve



ENGINEERING AN INNOVATIVE SOLUTION QUICKLY

SLA model confirms solution design and fit, saves time and expense



SITUATION: A major North American truck manufacturer initiated a tubing routing change that required a fitting not currently in stock. To meet the build schedule, the customer needed a production-ready solution in six weeks.

SOLUTION: With the application requirements understood, the Parker team provided a 3D model within two days to confirm the tube

The customer approved the functionality of the design, but still needed to confirm fit in the confined application. In fewer than 10 days, the Parker team provided a stereolithography (SLA) model that confirmed the design's fit. Satisfied with the results, the client authorized the go-ahead to create the final part, meeting his need for a production-ready solution.

BENEFITS: Concept to production in less than five weeks • Reduced



Product	Type	Body Material	Temperature		Maximum Pressure		Tubing Size	
			MIN.	MAX.	PSI	BAR	IN.	MM

Pneumatic

Prestolok Metal	Push-to-Connect	Nickel Plated Brass	0° F (-18° C)	+200° F (+93° C)	300	21	1/8 - 1/2	-
Prestolok Composite	Push-to-Connect	Glass Filled Nylon	-4° F (-20° C)	+175° F (+79° C)	290	20	1/8 - 1/2	3 - 14
Prestolok PLM	Push-to-Connect	Nickel Plated Brass	-4° F (-20° C)	+302° F (+150° C)	435	30	5/32 - 1/2	4 - 14
Prestolok PLS	Push-to-Connect	Stainless Steel	-4° F (-20° C)	+302° F (+150° C)	435	30	5/32 - 1/2	4 - 12
Flow controls	Function	Nylon/Treated Brass	+30° F (-1° C)	+160° F (+71° C)	145	10	1/8 - 1/2	4 - 14
Blocking Valves	Function	Treated Brass	-4° F (-20° C)	+160° F (+71° C)	145	10	1/8 - 3/8	4 - 14
Slow Start Valve	Function	Nickel Plated Brass	+5° F (-15° C)	+140° F (+60° C)	150	10	1/4 - 3/8	4 - 6
Threshold Sensor	Function	Polymer	+5° F (-15° C)	+140° F (+60° C)	115	8	5/32	4
Check Valve	Function	Nylon/Nickel Plated Brass	+34° F (+1° C)	+150° F (+65° C)	145	10	5/32 - 3/8	4 - 12
Slide Valves								
Quick Exhaust Valves		Nickel-plated brass	0° F (-18° C)	+160° F (+71° C)	150	10	1/8 - 1/2	-
Mini Ball Valves		Nylon	-4° F (-20° C)	+175° F (+79° C)	145	10		

Water & Beverage

LIQUIfit	Push-to-Connect	Bio-based Polymer	+35° F (1° C)	+200° F (+93° C)	230	16	1/4 - 1/2	4 - 12
TrueSeal Acetal	Push-to-Connect	Acetal	-20° F (-29° C)	+180° F (+82° C)	300	21	1/4 - 1/2	-
TrueSeal Polypropylene	Push-to-Connect	Polypropylene	0° F (-18° C)	+225° F (+107° C)	150	10	1/4 - 1/2	-
TrueSeal Kynar	Push-to-Connect	Kynar	0° F (-18° C)	+275° F (+135° C)	300	21	1/4 - 1/2	-
Fast & Tite Polypropylene	Compression	Polypropylene	0° F (-18° C)	+212° F (+100° C)	300	21	1/4 - 5/8	-
Fast & Tite Nylon	Compression	Nylon	-40° F (-40° C)	+200° F (+93° C)	300	21	1/4 - 5/8	-
Par-Barb Polypropylene	Barb	Polypropylene	0° F (-18° C)	+212° F (+100° C)	125	9	1/8 - 3/4	-
Par-Barb Nylon	Barb	Nylon	-40° F (-40° C)	+200° F (+93° C)	125	9	1/8 - 1 1/2	-
LIQUIfit Ball Valves	Push-to-Connect	Polypropylene	+35° F (1° C)	+200° F (+93° C)	150	10	1/4 - 3/8	-
TrueSeal Ball Valves	Push-to-Connect	Polypropylene	0° F (-18° C)	+225° F (+107° C)	150	10	1/4 - 3/8	-
Par-Barb Ball Valves	Barb	Polypropylene	+35° F (1° C)	+200° F (+93° C)	150	10	1/4 - 3/8	-
Check Valves	Push-to-Connect	Acetal	+34° F (+1° C)	+150° F (+65° C)	150	10	1/4 - 3/8	-

Cartridges

Carstick	Push-to-Connect	Polymer	-4° F (-20° C)	+175° F (+79° C)	290	20	1/8 - 3/8	4 - 8
PLM/PLS	Push-to-Connect	Brass/ Stainless	-4° F (-20° C)	+175° F (+79° C)	435	30	-	4 - 14
LIQUIfit	Push-to-Connect	Polymer	+ 35° F (+1° C)	+200° F (+93° C)	230	16	1/4 - 1/2	4 - 12
TrueSeal	Push-to-Connect	Acetal	-20° F (-29° C)	+180° F (+82° C)	150	10	1/4 - 1/2	-
SAE Encapsulated	Push-to-Connect	Brass	-40° F (-40° C)	+200° F (+93° C)	250	17	1/4 - 5/8	-

Transportation Push-to-Connect

PTC Brass Fittings	Push-to-Connect	Brass	-40° F (-40° C)	+200° F (+93° C)	250	17	5/32 - 3/4	-
PTC/PTCR Composite Fittings	Push-to-Connect	Composite	-40° F (-40° C)	+200° F (+93° C)	250	17	1/4 - 3/4	-
Metric Prestomatic	Push-to-Connect	Brass	-40° F (-40° C)	+200° F (+93° C)	250	17	-	4 - 16
Parker Safe Lock			-40° F (-40° C)	+239° F (+115° C)	72	4.9		

⚠ WARNING These products can expose you to chemicals including NICKEL, CARBON BLACK, TITANIUM DIOXIDE, or LEAD, which are known to the state of California to

Product	Type	Body Material	Temperature		Maximum Pressure		Tubing Size	
			MIN.	MAX.	PSI	BAR	IN.	MM

Transportation Compression

NTA	Compression	Brass	-40° F (-40° C)	+200° F (+93° C)	150	10	3/16 - 3/4	-
Transmission	Compression	Brass	-40° F (-40° C)	+220° F (+104° C)	150	10	1/8 - 5/32	-
Air Brake - AB	Compression	Brass	-65° F (-54° C)	+250° F (+121° C)	400	27	1/4 - 3/4	-
Air Brake Hose Ends	Compression	Brass	-50° F (-45° C)	+212° F (+100° C)	225	15	3/8 - 1/2	-
Vibra-Lok Buna N Sleeve	Compression	Brass	-30° F (-34° C)	+275° F (+135° C)	On Condition	On Condition	1/8 - 3/4	-
Vibra-Lok Fluorocarbon Sleeve	Compression	Brass	-15° F (-26° C)	+450° F (+232° C)	On Condition	On Condition	1/8 - 3/4	-
Truck Valves	Shut Off	Brass	-30° F (-34° C)	+250° F (+121° C)	150	10	3/8 - 3/4	-
Lanyard Valve	Manual Release	Brass	-40° F (-40° C)	+200° F (+93° C)	150	10	-	-

Transportation Cartridges & Manifolds

SAE Encapsulated Cartridge	Push-to-Connect	Brass	-40° F (-40° C)	+200° F (+93° C)	250	17	5/32 - 3/4	-
Presto Manifold	Push-to-Connect	Glass Filled Nylon	-40° F (-40° C)	+200° F (+93° C)	150	10	1/4 - 1/2	-

Industrial Compression Style

Compression	Compression	Brass	-65° F (-54° C)	+250° F (+121° C)	2800	193	1/8 - 7/8	
Compress-Align	Compression	Brass	-65° F (-54° C)	+250° F (+121° C)	2800	193	1/8 - 1	
Metric Compression	Compression	Brass	-40° F (-40° C)	+482° F (+250° C)	3335	230		4 - 22
Poly-Tite	Compression	Brass	0° F (-18° C)	+150° F (+65° C)	150	10	1/4 - 1/2	
Hi-Duty	Compression	Brass	-65° F (-54° C)	+250° F (+121° C)	4300	296	1/8 - 5/8	

Industrial Flare Fittings

45° Flare	Flare	Brass	-65° F (-54° C)	+250° F (+121° C)	2800	193	1/8 - 7/8	
Inverted Flare	Flare	Brass	-65° F (-54° C)	+250° F (+121° C)	2800	193	1/8 - 3/4	
Access Valves	Flare	Brass	-20° F (-29° C)	+200° F (+93° C)	500	34	1/8 - 1/2	

Industrial Barbed Fittings

Dubl-Barb	Barbed	Brass	-65° F (-54° C)	(1/4-3/8) - +90° F (+32° C) (1/2) - +75° F (+24° C)	(1/4 - 3/8) 150 (1/2) 100	(1/4 - 3/8) 10 (1/2) 7		
Hose Barbs	Barbed	Brass	-40° F (-40° C)	+160° F (+71° C)	150	10	1/4 - 1	

Industrial Adapters

Pipe	Threaded	Brass	-65° F (-54° C)	+250° F (+121° C)	1,000	69	1/8 - 1	
ISO Port Adapters		Brass		Dependent on Tubing or Hose End Connection				
Garden Hose		Brass	+35° F (+2° C)	+100° F (+38° C)	75	5		

NOTE: DO NOT ALLOW MEDIA TO FREEZE OR PRODUCT DAMAGE MAY OCCUR. REFER TO USER RESPONSIBILITY ON PAGE 0.

⚠ WARNING These products can expose you to chemicals including NICKEL, CARBON BLACK, TITANIUM DIOXIDE, or LEAD, which are known to the state of California to

Product	Type	Body Material	Temperature		Maximum Pressure		Tubing Size	
			MIN.	MAX.	PSI	BAR	IN.	MM

Industrial Ball Valves

500 Series	Female/Female	Brass	0° F (-18° C)	+350° F (+176° C)	600	41		
501 Series	Female/Male	Brass	0° F (-18° C)	+350° F (+176° C)	600	41		
502 Series	Panel Mounted	Brass	0° F (-18° C)	+350° F (+176° C)	600	41		
506 Series	Straight Thread	Brass	0° F (-18° C)	+350° F (+176° C)	600	41		
509 Series	Solder Ends	Brass						
510 Series	Male/Female Straight Thread	Brass	0° F (-18° C)	+350° F (+176° C)	600	41		
520 Series	Female/Female	Brass	0° F (-18° C)	+350° F (+176° C)	600	41		
525 Series	Female/Female	Brass	-40° F (-40° C)	+350° F (+176° C)	600	41		
533 Series	3-Way Diversion	Brass	-20° F (-29° C)	+350° F (+176° C)	400	27		
540 Series	4-Way	Brass	-20° F (-29° C)	+350° F (+176° C)	400	27		
590/591 Series	Right Angle	Brass	-50° F (-45° C)	+350° F (+176° C)	250	17		
500HB Series	Hose Barb	Brass	0° F (-18° C)	+350° F (+176° C)	150	10		
600 Series	Six Port Diversion	Brass	0° F (-18° C)	+250° F (+121° C)	150	10		
500CS/502CS Series	Female/Female	Carbon Steel	-20° F (-29° C)	+425° F (+218° C)	2,000 (1/4 - 1) 1,500 (1 1/4 - 2)	137 (1/4 - 1) 103 (1 1/4 - 2)		
506CS Series	Straight Thread	Carbon Steel	-20° F (-29° C)	+425° F (+218° C)	3,000	206		
500HP/506HP Series	High Pressure	Carbon Steel	-10° F (-23° C)	+210° F (+99° C)	6,000	413		
501SS	Male/ Female	Stainless Steel	0° F (-18° C)	+400° F (+204° C)	2,000	137		
502SS	Female/Female	Stainless Steel	0° F (-18° C)	+400° F (+204° C)	2,000 (1/4 - 1) 1,500 (1 1/4 - 2)	137 (1/4 - 1) 103 (1 1/4 - 2)		
708 Series	Male/Female	Brass	-35° F (-37° C)	+300° F (+148° C)	500	34		
709 Series	Female/Female	Brass	-35° F (-37° C)	+300° F (+148° C)	500	34		
200 Series	Female/Female	Chrome Plated Brass	0° F (-18° C)	+200° F (+93° C)	200	13		
608 Series	Male/Female	Brass	0° F (-18° C)	+200° F (+93° C)	450	31		
609 Series	Female/Female	Brass	0° F (-18° C)	+200° F (+93° C)	450	31		
Mini Ball Valves		Nylon	-4° F (-20° C)	+175° F (+79° C)	145	10		

Plug Valves

607 Series	Male/Male	Brass	-40° F (-40° C)	+175° F (+79° C)	250	17		
608 Series	Male/Female	Brass	-40° F (-40° C)	+175° F (+79° C)	250	17		
609 Series	Female/Female	Brass	-40° F (-40° C)	+175° F (+79° C)	250	17		

Needle Valves/Drain Cocks/ Ground Plug Shutoff

Needle Valves	Shutoff	Brass	-45° F (-42° C)	+250° F (+121° C)	150	10		
Drain Cocks	External/Internal	Brass	-65° F (-54° C)	+250° F (+121° C)	150	10		
Ground Plug Shutoff	Shutoff	Brass	+32° F (0° C)	+125° F (+51° C)	30	2		

WARNING These products can expose you to chemicals including NICKEL, CARBON BLACK, TITANIUM DIOXIDE, or LEAD, which are known to the state of California to

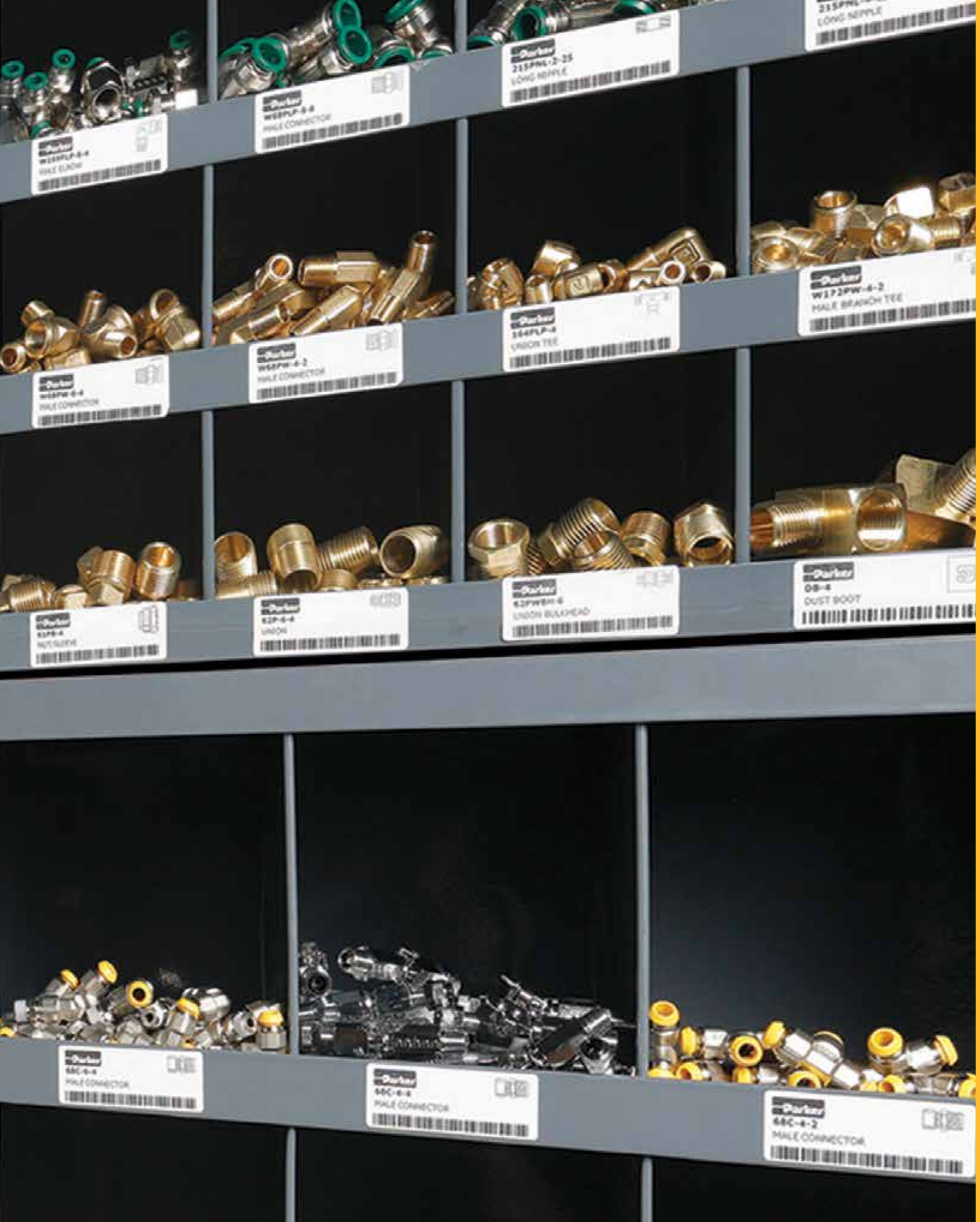



Pneumatic: Push-to-Connect

Section A

Prestolok PLP Metal Push-to-Connect Fittings	Prestolok PLM Metal Push-to-Connect Fittings
Prestolok PLP Composite Push-to-Connect Fittings	Prestolok PLS Stainless Steel Push-to-Connect Fittings
Oscillating Elbows	



Pneumatic: Integrated Fittings

Section B

Compact Flow Controls	Stainless Steel	Quick Exhaust Valve
Miniature Flow Controls	Flow Controls	Blocking Valves
Swivel Outlet Flow Controls	In-Line Check Valves	Slow Start Valves
Plug-In Flow Controls	Stainless Steel Check Valves	Threshold Sensor Fittings
In-Line Flow Controls	Piloted Operated Check Valves	Mini Ball Valves
Metal Flow Controls	Pneumatic Slide Valves	



Water & Beverage: Thermoplastic Fittings and Valves

Section C

LIQUIfit Fittings	Fast & Tite® Fittings	Thermoplastic Ball Valves
TrueSeal™ Fittings	Par-Barb® Fittings	



Cartridges

Section D

Cartridges	LIQUIfit® Cartridges	PLM/PLS Cartridges
Carstick® Cartridges	TrueSeal™ Cartridges	SAE Encapsulated Cartridges



Transportation Push-to-Connect

Section E

PTC/PTCR Composite Fittings	Metric Prestomatic Fittings
PTC Brass Fittings	Parker Safe Lock



Transportation Compression Fittings & Valves

Section F

Air Brake-NTA® Fittings	Air Brake – AB Fittings	Vibra-Lok Fittings
Transmission Fittings	Air Brake Hose Ends Fittings	Truck Valves & Lanyard Valve



Industrial Compression Style Fittings

Section G

Compression Fittings	Brass Metric Compression	Hi-Duty Flareless Tube Fittings
Compress-Align® Fittings	Poly-Tite Fittings	



Industrial Flare Fittings

Section H

45° Flare Fittings	Inverted Flare Fittings	Access Valves
--------------------	-------------------------	---------------

⚠️ WARNING: These products can expose you to chemicals including NICKEL, CARBON BLACK, TITANIUM DIOXIDE, or LEAD, which are known to the state of California to

Industrial Barbed Fittings	Section I
Dubl-Barb® Fittings	Hose Barb Fittings



Industrial Adapters	Section J	
Pipe Fittings	Nickel Plated Metric Adapters	Garden Hose Fittings
Metric Adapters	ISO Port Adapters	



Industrial Valves	Section K
Ball Valves Brass Series 500	Ball Valves Stainless Steel Series 501SS
Ball Valves Brass Series 501	Ball Valves Stainless Steel Series 502SS
Ball Valves Brass Series 502	Ball Valves Micro Series 708/709
Ball Valve Brass Series 506	Ball Valves Mini Series 200/608/609
Ball Valves Brass Series 509	Ball Valves Polypropylene
Ball Valves Brass Series 510	Plug Valves Series PV
Ball Valves Brass Series 520	Ball Valves Rotary Actuator Series ACT
Ball Valves Brass Series 525	Ball Valve Series BVGC
Ball Valves Brass Series 533	Ball Valve Series BVGL
3-Way Diversion / Series 540 4-Way	Ball Valve Series BVGLOCK
Ball Valves Brass Series 590/591	Ball Valve Series MBVG
Ball Valves Brass Series 500HB	Axial Valves
Ball Valves Brass Series 600	Replacement Componentry
Ball Valves Carbon Steel Series 500CS/502CS	Ball Valve Stem Extensions Series STX
Ball Valves Carbon Steel Series 506CS	Needle Valves
Ball Valves Carbon Steel Series 500HP, 506HP	Drain Cocks/Ground Plug Shutoff



Accessories	Section L	
Blow Guns	Silencers	Bins, Bags & Copper Tubing



Tube Fabricating Equipment	Section M	
Tube Cutters	Metric Tube Benders	Flaring Tools
Kloskut Tube Cutters	Tube Benders, Spring Type	In-Ex® Tube Deburring Tool
Tube Benders, Lever Type		



General Technical	Section N
--------------------------	-----------

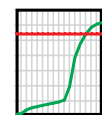

WARNING These products can expose you to chemicals including NICKEL, CARBON BLACK, TITANIUM DIOXIDE, or LEAD, which are known to the state of California to



Pneumatic: Push to Connect

Prestolok PLP Metal
Push-to-Connect Fittings

Prestolok PLP Composite
Push-to-Connect Fittings

Oscillating Elbows

Prestolok PLM Metal
Push-to-Connect Fittings

Prestolok PLS
Stainless Steel
Push-to-Connect Fittings



For more product information visit:
www.parker.com/automation-fittings



GOODYEAR
RUBBER PRODUCTS, INC.

+1.727.342.5087

También puede enviarnos un correo electrónico a
ventas@goodyearrubberproducts.com



Prestolok PLP Metal Push-to-Connect Fittings

Prestolok PLP push-to-connect metal fittings with its wide variety configurations allows you to find the perfect product to meet your needs, optimizing the use of your equipment.

Product Features:

- Stainless steel grab ring
- Nickel-plated brass body
- Nitrile seal
- Polyacetal release button
- Corrosion resistance
- NPT threads

Markets:

- Industrial
- Automotive
- Climate Control
- Welding
- Packaging

Applications:

- Air
- Oil
- Inert Gases
- Vacuum

Specifications:

Pressure Range Up to 300 PSI (20.6 bar) depending on tubing

Temperature Range 0° to +200° F (-17.7° to 93.3° C)

Note: Vacuum applications are dependent upon temperature and type of tubing used

Compatible Tubing:

- Polyethylene
- Polypropylene
- Semi Rigid Nylon
- Rigid Nylon
- Polyurethane 95 Durometer Shore A

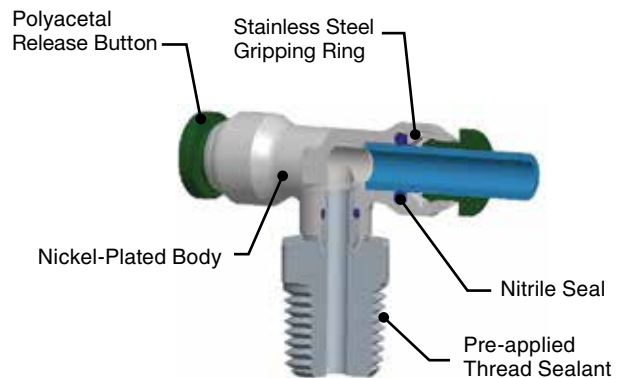

Assembly Instructions

1. Cut tubing squarely – maximum of 15° angle allowable.
2. Check that port or mating part is clean and free of debris.
3. Mark tubing to appropriate tube insertion length. (see Tube Insertion Chart on page N22)
4. Insert tubing until it bottoms
5. Pull on tubing to verify it is fully inserted
6. To disassemble, simply press release button, hold against body and pull tubing out of fitting.

⚠️ WARNING: These products can expose you to chemicals including LEAD which is known to the state of California to cause cancer.

■ Threaded Fittings

W68PLP

Male Connector
NPTF
p. A6



66PLP

Female Connector
NPTF
p. A6



68PLP

Male Connector
Straight
p. A7



PLPHBF4-B

Male Connector
BSPP
p. A7



68PLPR

Male Connector
Round Body
NPTF
p. A7



W169PLP

Male Elbow
Swivel - NPTF
p. A8



W169PLPNS

Male Elbow
NPTF
p. A8



W171PLP

Male Run Tee
Swivel - NPTF
p. A8



W172PLP

Male Branch Tee
Swivel - NPTF
p. A9



■ Tube to Tube Fittings

164PLP

Union Tee
p. A7



165PLP

Union Elbow
p. A8



62PLP

Union
p. A6



■ Bulkhead Unions

62PLPBH

Bulkhead Union
p. A6



66PLPBH

Female Bulkhead
Union
p. A6



⚠ WARNING These products can expose you to chemicals including LEAD which is known to the state of California to cause cancer.

[Click here for CADs, Product Specifications or to Configure Parts Online](#)

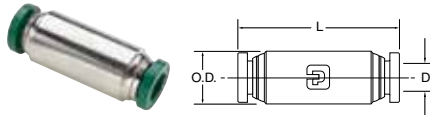

62PLP Union

PART NO.	TUBE SIZE IN	O.D.	L	FLOW DIA. D
62PLP-2	1/8	.375	1.40	.094
62PLP-3	3/16	.437	1.41	.156
62PLP-5/32	5/32	.375	1.41	.125
62PLP-4	1/4	.500	1.43	.188
62PLP-5	5/16	.562	1.65	.250
62PLP-6	3/8	.625	1.66	.312
62PLP-8	1/2	.750	1.82	.375

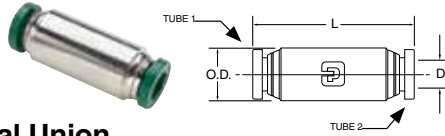

62PLP Unequal Union

PART NO.	TUBE 1 SIZE IN	TUBE 2 SIZE IN	O.D.	L	FLOW DIA. D
62PLP-5/32-2	5/32	1/8	.375	1.41	.094
62PLP-4-2	1/4	1/8	.500	1.43	.094
62PLP-4-5/32	1/4	5/32	.500	1.43	.125
62PLP-4-6	1/4	3/8	.625	1.66	.188
62PLP-6-8	3/8	1/2	.750	1.82	.312

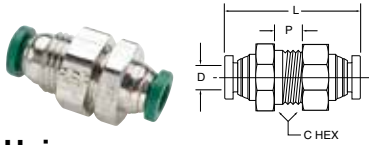

62PLPBH Bulkhead Union

PART NO.	TUBE SIZE IN	BULKHEAD HOLE DIA. B	C HEX	P MAX.	L	D
62PLPBH-2	1/8	7/16	9/16	.39	1.40	.094
62PLPBH-5/32	5/32	7/16	9/16	.39	1.41	.125
62PLPBH-4	1/4	9/16	11/16	.29	1.43	.188
62PLPBH-5	5/16	5/8	3/4	.60	1.65	.250
62PLPBH-6	3/8	3/4	7/8	.54	1.66	.312
62PLPBH-8	1/2	7/8	1	.66	2.04	.375

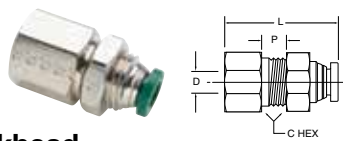

66PLPBH Female Bulkhead

PART NO.	TUBE SIZE IN	PIPE THD NPTF	C HEX	P MAX.	L	FLOW DIA. D	BKHD HOLE DIA.
66PLPBH-5/32-4	5/32	1/4	11/16	.19	1.39	.125	1/2
66PLPBH-4-4	1/4	1/4	11/16	.24	1.35	.188	9/16
66PLPBH-6-6	3/8	3/8	1	.22	1.47	.312	7/8
66PLPBH-8-6	1/2	3/8	1	.35	1.56	.344	7/8

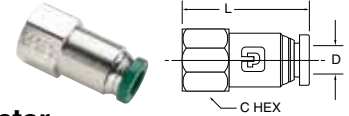

66PLP Female Connector

PART NO.	TUBE SIZE IN	PIPE THREAD NPTF	C HEX	L	FLOW DIA. D
66PLP-2-2	1/8	1/8	9/16	1.17	.094
66PLP-2-4	1/8	1/4	11/16	1.34	.094
66PLP-3-2	3/16	1/8	9/16	1.13	.156
66PLP-5/32-2	5/32	1/8	9/16	1.17	.125
66PLP-5/32-4	5/32	1/4	11/16	1.38	.125
66PLP-4-2	1/4	1/8	9/16	1.17	.188
66PLP-4-4	1/4	1/4	11/16	1.38	.188
66PLP-5-2	5/16	1/8	9/16	1.25	.250
66PLP-5-4	5/16	1/4	11/16	1.45	.250
66PLP-6-4	3/8	1/4	11/16	1.46	.312
66PLP-6-6	3/8	3/8	13/16	1.51	.312

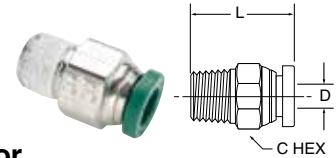

W68PLP Male Connector

PART NO.	TUBE SIZE IN	PIPE THD NPTF	C HEX	L	FLOW DIA. D
W68PLP-2-1	1/8	1/16	3/8	.79	.094
W68PLP-2-2	1/8	1/8	7/16	.79	.094
W68PLP-2-4	1/8	1/4	9/16	1.02	.094
W68PLP-3-2	3/16	1/8	7/16	.85	.156
W68PLP-3-4	3/16	1/4	9/16	1.01	.156
W68PLP-5/32-1	5/32	1/16		.88	.940
W68PLP-5/32-2	5/32	1/8	7/16	.80	.125
W68PLP-5/32-4	5/32	1/4	9/16	1.03	.125
W68PLP-4-1	1/4	1/16	1/2	1.07	.141
W68PLP-4-2	1/4	1/8	1/2	.89	.188
W68PLP-4-4	1/4	1/4	9/16	1.00	.188
W68PLP-4-6	1/4	3/8	3/4	1.04	.188
W68PLP-5-2	5/16	1/8	9/16	1.18	.250
W68PLP-5-4	5/16	1/4	9/16	1.04	.250
W68PLP-5-6	5/16	3/8	11/16	1.04	.250
W68PLP-6-2	3/8	1/8	5/8	1.21	.250
W68PLP-6-4	3/8	1/4	5/8	1.08	.312
W68PLP-6-6	3/8	3/8	11/16	1.02	.312
W68PLP-6-8	3/8	1/2	7/8	1.28	.312
W68PLP-8-4	1/2	1/4	13/16	1.44	.344
W68PLP-8-6	1/2	3/8	13/16	1.24	.344
W68PLP-8-8	1/2	1/2	7/8	1.35	.375
68PLP-5/32-4LT*	5/32	1/4-28	7/16	.88	.093

*SAE-LTThreads

WARNING These products can expose you to chemicals including LEAD which is known to the state of California to cause cancer.

[Click here for CADs, Product Specifications or to Configure Parts Online](#)

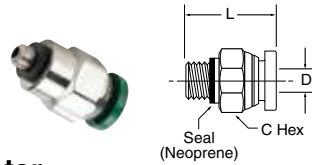

68PLP-X-0 Male Connector

PART NO.	TUBE SIZE IN	PIPE THREAD NPTF	C HEX	L	FLOW DIA. D
68PLP-2-0	1/8	10X32	3/8	.92	.094
68PLP-5/32-0	5/32	10X32	3/8	.90	.090
68PLP-4-0	1/4	10X32	1/2	.96	.094

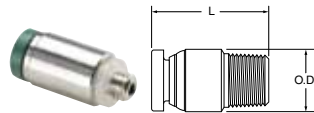

68PLPR Round Body Male Connector

PART NO.	TUBE SIZE IN	THREAD SIZE NPTF	INTERNAL HEX BROACH	BODY DIA. O.D.	L	FLOW DIA.
68PLPR-2-0*	1/8	10-32	3/32	3/8"	.89	.094
68PLPR-5/32-0*	5/32	10-32	3/32	3/8"	.91	.094
68PLPR-4-0*	1/4	10-32	3/32	1/2"	.95	.094
W68PLPR-5/32-1	5/32	1/16	1/8	3/8"	.87	.125
W68PLPR-5/32-2	5/32	1/8	1/8	7/16"	.79	.125
W68PLPR-4-1	1/4	1/16	5/32	1/2"	1.06	.156
W68PLPR-4-2	1/4	1/8	3/16	1/2"	.88	.188
W68PLPR-4-4	1/4	1/4	3/16	5/8"	.99	.188

*10-32 seal is neoprene

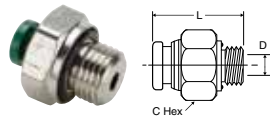

PLPHBF4-B Male Connector BSPP

PART NO.	TUBE SIZE IN	PIPE THD BSPP	C HEX	L	FLOW DIA. D
68PLP-4-2G	1/4	1/8-28	11/16	1.13	.188
68PLP-4-4G	1/4	1/4-19	3/4	1.13	.188
68PLP-4-6G	1/4	3/8-19	7/8	1.08	.188
68PLP-6-4G	3/8	1/4-19	3/4	1.26	.31
68PLP-6-6G	3/8	3/8-19	3/4	1.26	.31
68PLP-6-8G	3/8	1/2-19	7/8	1.26	.31
68PLP-8-6G	1/2	3/8-19	7/8	1.36	.45
68PLP-8-8G	1/2	1/2-14	1-1/16	1.36	.45

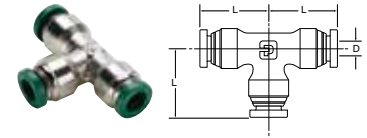

164PLP Union Tee

PART NO.	TUBE SIZE IN	L	FLOW DIA. D
164PLP-2	1/8	.74	.094
164PLP-3	3/16	.82	.156
164PLP-5/32	5/32	.77	.125
164PLP-4	1/4	.85	.188
164PLP-5	5/16	.97	.250
164PLP-6	3/8	1.01	.250
164PLP-8	1/2	1.15	.375

WARNING These products can expose you to chemicals including LEAD which is known to the state of California to cause cancer.

[Click here for CADs, Product Specifications or to Configure Parts Online](#)

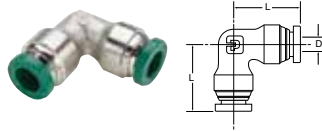

165PLP Union Elbow

PART NO.	TUBE SIZE IN	L	FLOW DIA. D
165PLP-2	1/8	.74	.094
165PLP-5/32	5/32	.77	.125
165PLP-4	1/4	.85	.188
165PLP-5	5/16	.97	.250
165PLP-6	3/8	1.01	.312
165PLP-8	1/2	1.15	.375

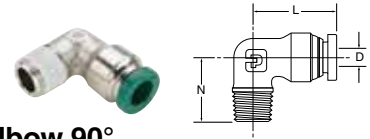

W169PLPNS Male Elbow 90°

PART NO.	TUBE IN	PIPE THD NPTF	L	N	FLOW DIA. D
W169PLPNS-2-2	1/8	1/8	.74	.67	.094
W169PLPNS5/32-2	5/32	1/8	.77	.67	.125
W169PLPNS5/32-4	5/32	1/4	.77	.87	.125
W169PLPNS-4-2	1/4	1/8	.85	.67	.188
W169PLPNS-4-4	1/4	1/4	.85	.87	.188
W169PLPNS-5-2	5/16	1/8	.97	.75	.234
W169PLPNS-5-4	5/16	1/4	.97	.94	.250
W169PLPNS-6-4	3/8	1/4	1.01	.94	.312
W169PLPNS-6-6	3/8	3/8	1.01	1.01	.312
W169PLPNS-6-8	3/8	1/2	1.01	1.27	.312
W169PLPNS-8-6	1/2	3/8	1.15	1.00	.375
W169PLPNS-8-8	1/2	1/2	1.15	1.27	.375
169PLPNS-5/32-4LT	5/32	1/4-28	.60	.48	.090

* SAE-LT Threads

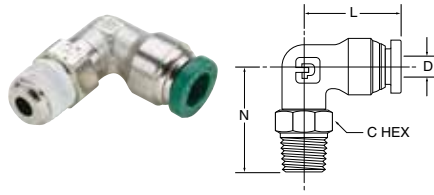

W169PLP Male Elbow Swivel 90°

PART NO.	TUBE SIZE IN	PIPE THREAD NPTF	C HEX	L	N	FLOW DIA. D
W169PLP-2-1	1/8	1/16	3/8	.74	.93	.160
W169PLP-2-2	1/8	1/8	7/16	.74	.92	.094
169PLP-2-0*	1/8	10-32	3/8	.74	.74	.080
W169PLP-2-4	1/8	1/4	9/16	.74	1.10	.094
W169PLP-3-2	3/16	1/8	7/16	.82	.92	.156
W169PLP-5/32-1	5/32	1/16	3/8	.84	.93	.160
W169PLP-5/32-2	5/32	1/8	7/16	.77	.92	.125
W169PLP-5/32-4	5/32	1/4	9/16	.77	1.10	.125
169PLP-5/32-0*	5/32	10-32	3/8	.85	.74	.080
W169PLP-4-1	1/4	1/16	3/8	.84	.93	.160
W169PLP-4-2	1/4	1/8	7/16	.85	.92	.156
W169PLP-4-4	1/4	1/4	9/16	.85	1.10	.156
W169PLP-4-6	1/4	3/8	11/16	.85	1.19	.156
169PLP-4-0*	1/4	10-32	3/8	.85	.74	.080
W169PLP-5-2	5/16	1/8	9/16	.97	1.02	.250
W169PLP-5-4	5/16	1/4	9/16	.97	1.24	.250
W169PLP-6-2	3/8	1/8	9/16	1.01	1.02	.250
W169PLP-6-4	3/8	1/4	9/16	1.01	1.24	.250
W169PLP-6-6	3/8	3/8	11/16	1.01	1.24	.250
W169PLP-6-8	3/8	1/2	7/8	1.01	1.48	.250
W169PLP-8-4	1/2	1/4	9/16	1.15	1.28	.312
W169PLP-8-6	1/2	3/8	11/16	1.15	1.31	.312
W169PLP-8-8	1/2	1/2	7/8	1.15	1.52	.312

*10-32 seal is neoprene

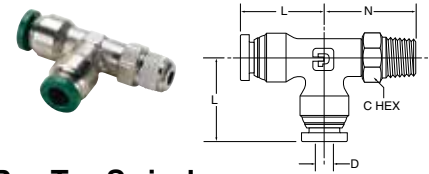

W171PLP Male Run Tee Swivel

PART NO.	TUBE SIZE IN	PIPE THREAD NPTF	C HEX	L	N	FLOW DIA. D
W171PLP-2-2	1/8	1/8	7/16	.74	.92	.094
W171PLP-5/32-2	5/32	1/8	7/16	.77	.92	.125
W171PLP-4-2	1/4	1/8	7/16	.85	.92	.156
W171PLP-4-4	1/4	1/4	9/16	.85	1.10	.156
W171PLP-4-6	1/4	3/8	11/16	.85	1.24	.156
W171PLP-5-2	5/16	1/8	9/16	.97	1.02	.250
W171PLP-5-4	5/16	1/4	9/16	.97	1.24	.250
W171PLP-6-4	3/8	1/4	9/16	1.01	1.24	.250
W171PLP-6-6	3/8	3/8	11/16	1.01	1.24	.250
W171PLP-8-6	1/2	3/8	11/16	1.15	1.31	.312
W171PLP-8-8	1/2	1/2	7/8	1.15	1.52	.312

WARNING These products can expose you to chemicals including LEAD which is known to the state of California to cause cancer.

[Click here for CADs, Product Specifications or to Configure Parts Online](#)

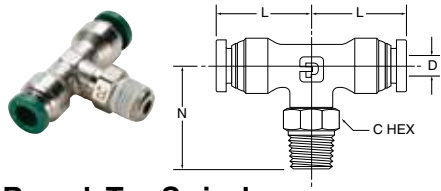

W172PLP Male Branch Tee Swivel

PART NO.	TUBE SIZE IN	PIPE THREAD NPTF	C HEX	L	N	FLOW DIA. D
W172PLP-2-2	1/8	1/8	7/16	.74	.92	.094
W172PLP-3-2	3/16	1/8	7/16	.82	.92	.156
W172PLP-5/32-2	5/32	1/8	7/16	.77	.92	.125
172PLP-4-0	1/4	10-32	3/8	.84	.80	.250
W172PLP-4-2	1/4	1/8	7/16	.85	.92	.156
W172PLP-4-4	1/4	1/4	9/16	.85	1.10	.156
W172PLP-4-6	1/4	3/8	11/16	.85	1.10	.156
W172PLP-5-2	5/16	1/8	9/16	.97	1.02	.250
W172PLP-5-4	5/16	1/4	9/16	.97	1.24	.250
W172PLP-6-4	3/8	1/4	9/16	1.01	1.24	.250
W172PLP-6-6	3/8	3/8	11/16	1.01	1.24	.250
W172PLP-6-8	3/8	1/2	7/8	1.00	1.48	.250
W172PLP-8-4	1/2	1/4	9/16	1.15	1.30	.312
W172PLP-8-6	1/2	3/8	11/16	1.15	1.31	.312
W172PLP-8-8	1/2	1/2	7/8	1.15	1.52	.312

WARNING These products can expose you to chemicals including LEAD which is known to the state of California to cause cancer.



Prestolok PLP Composite Push-to-Connect Fittings

Prestolok push-to-connect composite fittings with its wide variety configurations allows you to find the perfect product to meet your needs, optimizing the use of your equipment.

Product Features:

- Stainless steel grab ring
- Glass-reinforced nylon 6.6 body
- Nitrile D-seal
- Nylon release button
- Corrosion and chemical resistance
- NPT, BSPT, BSPP, and metric threads
- Silicone Free

Compatible Tubing:

- Semi-rigid nylon
- Polyurethane 95 Durometer Shore A*
- Nylon
- Fluoropolymer
- Polyethylene

Markets:

- Pneumatic
- Industrial
- Robotic
- Automation
- Printing
- Packaging
- Textile

Applications:

- Air
- Cutting Fluids
- Inert Gases
- Vacuum

Specifications:

Pressure Range	Up to 290 PSI (19.9 bar) depending on tubing
	Up to 260 PSI (17.9 bar) depending on tubing (3/16" size only)
Temperature Range	-4° to +175° F (-20° to +79.4° C)
	5° to +155° F (-15° to +68.3° C) (3/16" size only)
Vacuum Capability	28" Hg

*Tube Support Required

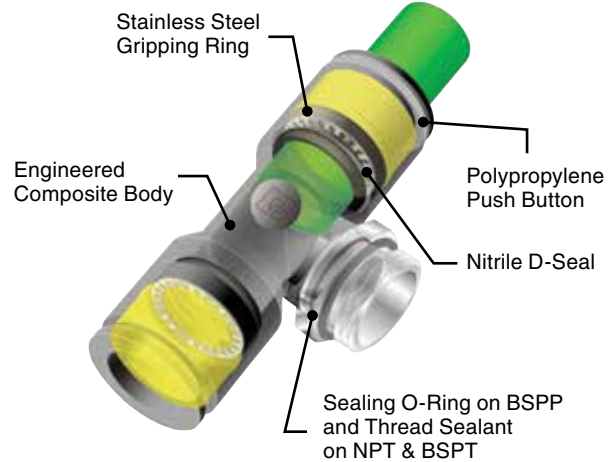

Assembly Instructions

1. Cut tubing squarely maximum of 15° angle allowable.
2. Check that port or mating part is clean and free of debris.
3. Mark tubing to appropriate tube insertion length. (see Tube Insertion Chart on page N22)
4. Insert tubing until it bottoms
5. Pull on tubing to verify it is fully inserted
6. To disassemble, simply press release button, hold against body and pull tubing out of fitting.

■ Threaded Fittings

W369PLP

Male Elbow
NPT, BSPT
p. A15, A16



W369PLPX

Extended Male Elbow
NPT, BSPT
p. A17



W379PLP

45° Male Elbow
NPT, BSPT
p. A17, A18



W372PLP

Male Branch Tee
NPT, BSPT
p. A18, A19



372PLP

Male Branch Tee
BSPP
p. A20



W371PLP

Male Run Tee
NPT, BSPT
p. A20, A21



W368PLP

Male Y Connector
NPT, BSPT
p. A22



W68LF

Male Connector
NPT, BSPT
p. A13, A14



68LFR

Male Connector
UNF, Straight
p. A14



66LF

Female Connector
NPT, BSPP
p. A13



377PLP

Female Branch Tee
NPT
p. A20



370PLP

Female Elbow
NPT, BSPP
p. A23



68LF

Male Connector
BSPP
p. A15



369PLP

Male Elbow
BSPP
p. A16



369PLPX

Extended Male Elbow – BSPP
p. A17



379PLP

45° Male Elbow
BSPP
p. A18



371PLP

Male Run Tee
BSPP
p. A21



368PLP

Male Y Connector
BSPP
p. A22



W368PLPD

Double Y Male Connector
BSPT
p. A23



W369PLPO

Oscillating Compact Elbow
NPT, BSPT
p. A36



369PLPO

Oscillating Compact Elbow
BSPP
p. A36



■ Tube to Tube Fittings

32PLP

Union
p. A26



365PLP

Union Elbow
p. A26, A27



364PLP

Union Tee
p. A27



362PLP

Union Y
p. A27



362PLPD

Double Y
p. A28



24PLP

Multiple Tee
p. A28



24PLPD

Double Multiple Tee
p. A29



347PLP

Cross
p. A29



32PLPRC

Connector for 2 Tubes
p. A33



32PLPDRC

Connector for 3 Tubes
p. A33



■ Bulkhead Unions

32PLPBH

Bulkhead Union
p. A28



365PLPBH

Bulkhead Elbow
p. A28



32PLPBHP

Plug-in Bulkhead Union
p. A34



■ **Standpipes**

W68PLPSP

Male Standpipe
NPT
p. A21



W68PLPSPX

Male Standpipe
BSPT
p. A21



68PLPSP

Male Standpipe
BSPP
p. A22



■ **Plug-In Fittings**

369PLPSP

Plug-In Elbow
p. A29



369PLPSPX

Extended Plug-In
Elbow
p. A30



379PLPSP

Plug-In 45° Male
Elbow
p. A30



372PLPSP

Plug-In Branch Tee
p. A30



371PLPSP

Plug-In Run Tee
p. A30, A31



362PLPSP

Plug-In Y
p. A31



362PLPDSP

Double Plug-In Y
p. A31



37PLP

Tube Reducer
p. A32



32PLPSP

Tube Expander
p. A32



32PLPSP

Tube Converter
p. A32



322PLPSP

Barbed Connector
p. A32, A33



■ **Modular Fittings**

369PLPBJ

Single Banjo
BSPP
p. A24



369PLPBJB

Single Banjo Body
p. A24



32PLPDJB

Double Banjo Body
p. A24



369PLPTJB

Twin Banjo Body
p. A24



68BJB

Single Banjo Bolt
p. A24



68BJBD

Double Banjo Bolt
p. A25



68BJBT

Triple Banjo Bolt
p. A25



66BJB

Female Banjo Bolt
p. A25



376PLPBJ

Banjo with Female
Bolt
p. A25



369PLPTJ

Twin Banjo
p. A25



32PLPDJ

Double Banjo
p. A25



W369PLPBJ

Single Banjo
NPT, BSPT
p. A23



W369PLPTJ

Twin Banjo
NPT
p. A25



■ **Accessories**

63PLP

Double Male Union
p. A31



639PLP

Plug
p. A32



Clip

p. A33



3151

End Cap
p. A33



AQRT

Release Tool
p. A34



3110-3330

End Cap
p. A34



[Click here for CADs, Product Specifications or to Configure Parts Online](#)

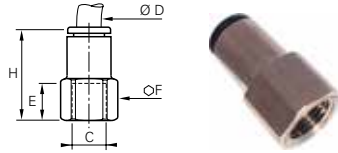

66LF Female Connector BSPP

PART NO.	TUBE SIZE MM	THREAD BSPP	E MM	F MM	H MM
66LF-4M-M5	4	M5X0.8	6.5	8	19.5
66LF-4M-2G	4	1/8	9.5	13	22.5
66LF-4M-4G	4	1/4	13.5	16	26.5
66LF-6M-2G	6	1/8	9.5	13	24.5
66LF-6M-4G	6	1/4	13.5	16	28.5
66LF-8M-2G	8	1/8	9.5	13	29.0
66LF-8M-4G	8	1/4	13.5	16	33.0
66LF-8M-6G	8	3/8	14.0	19	34.0
66LF-10M-4G	10	1/4	13.5	16	36.0
66LF-10M-6G	10	3/8	14.0	19	36.0
66LF-10M-8G	10	1/2	19.5	24	41.5
66LF-12M-4G	12	1/4	14.0	19	39.5
66LF-12M-6G	12	3/8	14.0	19	40.0
66LF-12M-8G	12	1/2	19.5	24	45.5
66LF-14M-6G	14	3/8	14.0	22	42.5
66LF-16M-8G	16	1/2	15.0	27	49.0

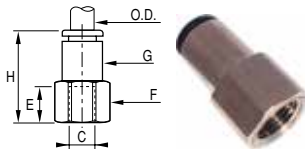

66LF Female Connector NPT

PART NO.	TUBE SIZE IN	THREAD NPT	F MM	G IN	H IN	E IN
66LF-2-2	1/8	1/8	13	.43	.87	.37
66LF-2-4	1/8	1/4	16	.43	1.05	.55
66LF-4M-2	5/32 (4MM)	1/8	13	.35	.89	.37
66LF-4M-4	5/32 (4MM)	1/4	16	.33	1.06	.55
66LF-4-2	1/4	1/8	13	.42	.98	.37
66LF-4-4	1/4	1/4	16	.42	1.16	.55
66LF-8M-2	5/16 (8MM)	1/8	13	.53	1.14	.37
66LF-8M-4	5/16 (8MM)	1/4	16	.53	1.32	.55
66LF-6-2	3/8	1/8	16	.61	1.22	.37
66LF-6-4	3/8	1/4	16	.61	1.40	.55
66LF-6-6	3/8	3/8	22	.61	1.52	.65
66LF-8-4	1/2	1/4	20	.84	1.73	.47
66LF-8-6	1/2	3/8	22	.85	1.81	.65
66LF-8-8	1/2	1/2	24	.85	1.93	.77

W68LF Male Connector NPT

PART NO.	TUBE SIZE IN	C NPT	F1 MM	F2 IN	H IN	K IN
W68LF-2-1	1/8	1/16	10	.07	.413	.433
W68LF-2-2	1/8	1/8	11	.07	.283	.472
W68LF-2-4	1/8	1/4	14	.07	.315	.591
W68LF-4M-2	5/32 (4MM)	1/8	11	.11	.334	.472
W68LF-4M-4	5/32 (4MM)	1/4	14	.11	.275	.590
W68LF-4-2	1/4	1/8	11	.16	.472	.472
W68LF-4-4	1/4	1/4	14	.16	.374	.590
W68LF-4-6	1/4	3/8	18	.19	.295	.767
W68LF-8M-2	5/16 (8MM)	1/8	13	.19	.787	.551
W68LF-8M-4	5/16 (8MM)	1/4	14	.25	.661	.590
W68LF-8M-6	5/16 (8MM)	3/8	18	.25	.464	.767
W68LF-6-2	3/8	1/8	16	.16	.894	.689
W68LF-6-4	3/8	1/4	16	.28	.807	.689
W68LF-6-6	3/8	3/8	18	.28	.689	.767
W68LF-6-8	3/8	1/2	22	.28	.610	.945
W68LF-8-4	1/2	1/4	22	.25	1.100	.945
W68LF-8-6	1/2	3/8	22	.28	1.100	.945
W68LF-8-8	1/2	1/2	22	.28	1.100	.945

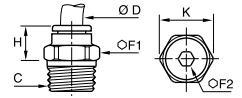

[Click here for CADs, Product Specifications or to Configure Parts Online](#)

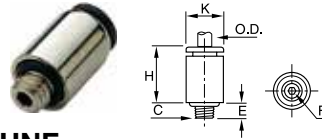

68LFR Male Connector UNF

PART NO.	TUBE SIZE IN	C UNF	E IN	F MM	H IN	K IN
68LFR-2-0	1/8	10-32	.13	2.0	.49	.32
68LFR-4M-0	5/32 (4MM)	10-32	.13	2.0	.54	.34
68LFR-4-0	1/4	10-32	.13	2.0	.64	.46
68LFR-4-M5	1/4	M5	.14	2.5	.65	.41
68LFR-4-M7	1/4	M7	.18	4.0	.65	.41

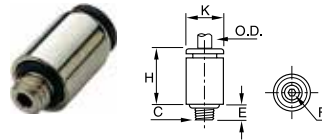

68LFR Male Connector Metric Straight Thread

PART NO.	TUBE SIZE MM	C UNF	E MM	F MM	H MM	K MM
68LFR-4M-M7	4	M7X1	4.6	3	14	9.95
68LFR-4M-M5	4	M5X0.8	3.5	2.5	14.5	8.50
68LFR-6M-M7	6	M7X1	4.6	3	16	9.90

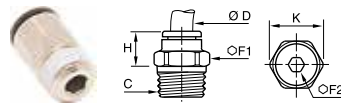

W68LF Male Connector BSPT

PART NO.	TUBE SIZE IN	C BSPT	F1 MM	F2 MM	H IN	K IN
W68LF-2-2R	1/8	1/8	10	2	.335	.433
W68LF-5/32-2R	5/32	1/8	10	3	.370	.430
W68LF-5/32-4R	5/32	1/4	14	3	.260	.590
W68LF-3-2R	3/16	1/8	11	3	.610	.510
W68LF-3-4R	3/16	1/4	14	3	.590	.650
W68LF-4-2R	1/4	1/8	11	4	.472	.472
W68LF-4-4R	1/4	1/4	14	4	.374	.591
W68LF-5-2R	5/16	1/8	13	5	.790	.550
W68LF-5-4R	5/16	1/4	14	6	.670	.590
W68LF-5-6R	5/16	3/8	17	6	.510	.730
W68LF-5-8R	5/16	1/2	21	6	.470	.910
W68LF-6-4R	3/8	1/4	16	7	.807	.689
W68LF-6-6R	3/8	3/8	17	7	.650	.728
W68LF-6-8R	3/8	1/2	21	7	.551	.906
W68LF-8-4R	1/2	1/4	22	6	1.060	.945
W68LF-8-6R	1/2	3/8	22	7	1.020	.945
W68LF-8-8R	1/2	1/2	24	7	.807	1.020

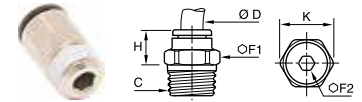

W68LF Male Connector Metric to NPT

PART NO.	TUBE SIZE MM	C NPT	F1 MM	F2 IN	H IN	K IN
W68LF-4M-2	4	1/8	11	3	.33	.47
W68LF-4M-4	4	1/4	14	3	.28	.59
W68LF-6M-2	6	1/8	11	4	.45	.47
W68LF-6M-4	6	1/4	14	4	.33	.59
W68LF-8M-2	8	1/8	13	5	.79	.55
W68LF-8M-4	8	1/4	14	6	.66	.59
W68LF-8M-6	8	3/8	18	6	.46	.77
W68LF-10M-4	10	1/4	16	7	.79	.69
W68LF-10M-6	10	3/8	18	8	.65	.77
W68LF-10M-8	10	1/2	22	8	.55	.95
W68LF-12M-6	12	3/8	19	9	.95	.83
W68LF-12M-8	12	1/2	22	10	.77	.95

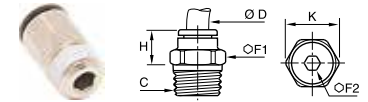

W68LF Male Connector Metric to BSPT

PART NO.	TUBE SIZE MM	C BSPT	F1 MM	F2 MM	H MM	K MM
W68LF-4M-2R	4	1/8	10	3	9.5	11.0
W68LF-4M-4R	4	1/4	14	3	6.5	15.0
W68LF-4M-6R	4	3/8	17	3	8.0	18.5
W68LF-6M-2R	6	1/8	11	4	11.5	11.0
W68LF-6M-4R	6	1/4	14	4	8.5	15.0
W68LF-6M-6R	6	3/8	17	4	8.5	18.5
W68LF-6M-8R	6	1/2	21	4	9.0	23.0
W68LF-8M-2R	8	1/8	13	5	20.0	14.0
W68LF-8M-4R	8	1/4	14	6	17.0	15.0
W68LF-8M-6R	8	3/8	17	6	13.0	18.5
W68LF-8M-8R	8	1/2	21	6	12.0	23.0
W68LF-10M-2R	10	1/8	16	5	22.5	17.5
W68LF-10M-4R	10	1/4	16	7	20.0	17.5
W68LF-10M-6R	10	3/8	17	8	16.5	18.5
W68LF-10M-8R	10	1/2	21	8	14.0	23.0
W68LF-12M-4R	12	1/4	19	7	26.5	21.0
W68LF-12M-6R	12	3/8	19	9	24.0	21.0
W68LF-12M-8R	12	1/2	21	9	19.5	23.0
W68LF-14M-6R	14	3/8	22	9	28.5	24.0
W68LF-14M-8R	14	1/2	24	10	23.5	26.0

[Click here for CADs, Product Specifications or to Configure Parts Online](#)

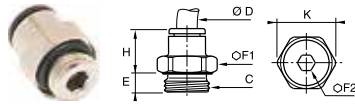

68LF Male Connector Metric to BSPP

PART NO.	TUBE SIZE MM	C BSPP	E MM	F1 MM	F2 MM	H MM	K MM
68LF-3M-M3	3	M3X0.5	2.50	8	-	12.5	8.5
68LF-3M-M5	3	M5X0.8	3.50	8	2.5	12.5	8.5
68LF-4M-M3	4	M3X0.5	2.50	8	-	14.5	8.5
68LF-4M-M5	4	M5X0.8	3.50	8	2.5	14.0	8.5
68LF-4M-M7	4	M7X1	5.00	10	2.5	14.0	11.0
68LF-4M-2G	4	1/8	4.50	13	3.0	11.5	14.0
68LF-4M-4G	4	1/4	5.50	16	3.0	10.5	17.5
68LF-6M-M5	6	M5X0.8	3.50	10	2.5	16.0	11.0
68LF-6M-M7	6	M7X1	5.00	10	3.0	16.0	11.0
68LF-6M-M10	6	M10X1	5.00	13	4.0	13.0	14.0
68LF-6M-M12	6	M12X1.5	5.50	15	4.0	13.0	16.0
68LF-6M-2G	6	1/8	4.50	13	4.0	13.0	14.0
68LF-6M-4G	6	1/4	5.50	16	4.0	12.5	17.5
68LF-6M-6G	6	3/8	5.50	20	4.0	13.0	22.0
68LF-6M-8G	6	1/2	7.50	24	4.0	20.0	26.0
68LF-8M-M10	8	M10X1	5.00	13	5.0	21.0	14.0
68LF-8M-M12	8	M12X1.5	5.50	15	5.0	21.0	16.0
68LF-8M-2G	8	1/8	4.50	13	5.0	20.5	14.0
68LF-8M-4G	8	1/4	5.50	16	6.0	19.5	17.5
68LF-8M-6G	8	3/8	5.50	20	6.0	18.0	22.0
68LF-8M-8G	8	1/2	7.50	24	6.0	16.5	26.0
68LF-10M-4G	10	1/4	5.50	16	7.0	23.0	17.5
68LF-10M-6G	10	3/8	5.50	20	8.0	19.5	22.0
68LF-10M-8G	10	1/2	7.50	24	8.0	18.5	26.0
68LF-12M-4G	12	1/4	5.50	19	7.0	27.5	21.0
68LF-12M-6G	12	3/8	5.50	20	9.0	27.0	22.0
68LF-12M-8G	12	1/2	7.00	24	10.0	22.5	26.0
68LF-14M-6G	14	3/8	5.50	22	9.0	29.5	24.0
68LF-14M-8G	14	1/2	7.00	24	11.0	28.0	26.0

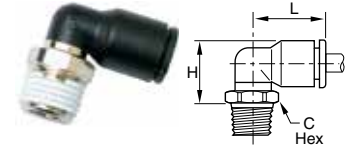

W369PLP Male Elbow - NPT

PART NO.	TUBE SIZE IN	THREAD NPT / UNF	C HEX MM	L	H
369PLP-2-0	1/8	10-32	8	.57	.52
W369PLP-2-1	1/8	1/16	10	.57	.53
W369PLP-2-2	1/8	1/8	11	.57	.53
W369PLP-2-4	1/8	1/4	14	.57	.55
369PLP-4M-0	5/32 (4MM)	10-32	8	.55	.53
W369PLP-4M-2	5/32 (4MM)	1/8	11	.55	.53
W369PLP-4M-4	5/32 (4MM)	1/4	14	.55	.55
W369PLP-3-2	3/16	1/8	11	.85	.67
369PLP-4-0	1/4	10-32	11	.71	.63
W369PLP-4-2	1/4	1/8	11	.71	.67
W369PLP-4-4	1/4	1/4	14	.71	.63
W369PLP-4-6	1/4	3/8	18	.71	.65
W369PLP-8M-2	5/16 (8MM)	1/8	11	.91	.75
W369PLP-8M-4	5/16 (8MM)	1/4	14	.91	.71
W369PLP-8M-6	5/16 (8MM)	3/8	18	.91	.73
W369PLP-6-2	3/8	1/8	15	1.08	.91
W369PLP-6-4	3/8	1/4	15	1.08	.91
W369PLP-6-6	3/8	3/8	18	1.08	.87
W369PLP-6-8	3/8	1/2	22	1.08	.91
W369PLP-8-4	1/2	1/4	20	1.38	1.22
W369PLP-8-6	1/2	3/8	20	1.38	1.22
W369PLP-8-8	1/2	1/2	24	1.38	1.12



W369PLP Male Elbow - BSPT

PART NO.	TUBE SIZE IN	THREAD BSPT	C HEX MM	L	H
W369PLP-2-2R	1/8	1/8	10	.57	.53
W369PLP-4M-2R	5/32 (4M)	1/8	10	.55	.53
W369PLP-4M-4R	5/32 (4M)	1/4	14	.55	.55
W369PLP-3-2R	3/16	1/8	11	.85	.67
W369PLP-4-2R	1/4	1/8	10	.71	.67
W369PLP-4-4R	1/4	1/4	14	.71	.63
W369PLP-8M-2R	5/16 (8M)	1/8	10	.91	.75
W369PLP-8M-4R	5/16 (8M)	1/4	14	.91	.71
W369PLP-8M-6R	5/16 (8M)	3/8	17	.91	.71
W369PLP-8M-8R	5/16 (8M)	1/2	21	.91	.77
W369PLP-6-4R	3/8	1/4	15	1.04	.87
W369PLP-6-6R	3/8	3/8	17	1.04	.87
W369PLP-8-4R	1/2	1/4	20	1.38	1.22
W369PLP-8-6R	1/2	3/8	20	1.38	1.22
W369PLP-8-8R	1/2	1/2	24	1.38	1.12

[Click here for CADs, Product Specifications or to Configure Parts Online](#)

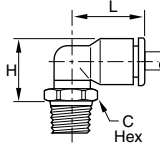

W369PLP Male Elbow - NPT

PART NO.	TUBE SIZE MM	THREAD NPT	C HEX MM	H	L
W369PLP-4M-2	4	1/8	11	.53	.55
W369PLP-4M-4	4	1/4	14	.55	.55
W369PLP-6M-2	6	1/8	11	.61	.63
W369PLP-6M-4	6	1/4	14	.63	.63
W369PLP-8M-2	8	1/8	11	.75	.91
W369PLP-8M-4	8	1/4	14	.71	.91
W369PLP-8M-6	8	3/8	18	.73	.91
W369PLP-10M-4	10	1/4	15	.91	1.04
W369PLP-10M-6	10	3/8	18	.87	1.04
W369PLP-10M-8	10	1/2	22	.91	1.04
W369PLP-12M-6	12	3/8	18	.98	1.22
W369PLP-12M-8	12	1/2	22	1.02	1.22

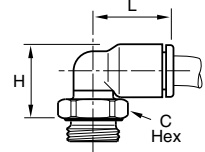

369PLP Male Elbow - BSPP

PART NO.	TUBE SIZE MM	BSPP / METRIC	C HEX MM	H	L
369PLP-3M-M3	3	M3X0.5	8	15.0	14.5
369PLP-3M-M5	3	M5X0.8	8	13.5	14.5
369PLP-4M-M3	4	M3X0.5	8	15.0	14.5
369PLP-4M-M5	4	M5X0.8	8	13.5	14.0
369PLP-4M-2G	4	1/8	13	13.0	14.0
369PLP-4M-4G	4	1/4	16	13.0	14.0
369PLP-6M-M5	6	M5X0.8	8	15.5	16.0
369PLP-6M-M7	6	M7X1	10	17.5	16.0
369PLP-6M-M10	6	M10X1	13	15.0	14.0
369PLP-6M-M12	6	M12X1.5	15	15.0	16.0
369PLP-6M-2G	6	1/8	13	15.0	16.0
369PLP-6M-4G	6	1/4	16	15.0	16.0
369PLP-6M-6G	6	3/8	20	15.5	16.0
369PLP-6M-8G	6	1/2	24	16.0	16.0
369PLP-8M-M10	8	M10X1	13	20.5	23.0
369PLP-8M-M12	8	M12X1.5	15	19.5	23.0
369PLP-8M-2G	8	1/8	13	20.5	23.0
369PLP-8M-4G	8	1/4	16	18.5	23.0
369PLP-8M-6G	8	3/8	20	18.5	23.0
369PLP-8M-8G	8	1/2	24	19.0	23.0
369PLP-10M-4G	10	1/4	16	23.5	26.5
369PLP-10M-6G	10	3/8	20	22.0	26.5
369PLP-10M-8G	10	1/2	24	22.0	26.5
369PLP-12M-4G	12	1/4	16	26.5	31.0
369PLP-12M-6G	12	3/8	20	25.0	31.0
369PLP-12M-8G	12	1/2	24	25.0	31.0
369PLP-14M-6G	14	3/8	20	32.5	35.5
369PLP-14M-8G	14	1/2	24	27.0	35.5
369PLP-16M-6G	16	3/8	27	54.5	39
369PLP-16M-8G	16	1/2	27	54.5	39

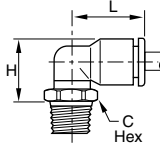

W369PLP Male Elbow - BSPT

PART NO.	TUBE SIZE MM	THREAD BSPT	C HEX MM	H	L
W369PLP-4M-2R	4	1/8	10	13.5	14.0
W369PLP-4M-4R	4	1/4	14	14.0	14.0
W369PLP-4M-6R	4	3/8	17	13.5	14.0
W369PLP-6M-2R	6	1/8	10	15.5	16.0
W369PLP-6M-4R	6	1/4	14	16.0	16.0
W369PLP-6M-6R	6	3/8	17	16.0	16.0
W369PLP-6M-8R	6	1/2	21	16.5	16.0
W369PLP-8M-2R	8	1/8	10	19.0	23.0
W369PLP-8M-4R	8	1/4	14	18.0	23.0
W369PLP-8M-6R	8	3/8	17	18.0	23.0
W369PLP-8M-8R	8	1/2	21	19.5	23.0
W369PLP-10M-2R	10	1/8	15	23.0	26.5
W369PLP-10M-4R	10	1/4	15	22.0	26.5
W369PLP-10M-6R	10	3/8	17	22.0	26.5
W369PLP-10M-8R	10	1/2	21	22.0	26.5
W369PLP-12M-4R	12	1/4	15	25.0	31.0
W369PLP-12M-6R	12	3/8	17	25.0	31.0
W369PLP-12M-8R	12	1/2	21	25.0	31.0
W369PLP-14M-6R	14	3/8	20	30.5	35.5
W369PLP-14M-8R	14	1/2	24	28.5	35.5
W369PLP-16M-6R	16	3/8	27	53	39.0
W369PLP-16M-8R	16	1/2	27	53	39.0

[Click here for CADs, Product Specifications or to Configure Parts Online](#)

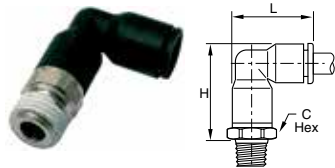

W369PLPX Extended Male Elbow - NPT

PART NO.	TUBE SIZE IN	THREAD NPT / UNF	C HEX MM	H	L
369PLPX-2-0	1/8	10-32	8	.91	.75
W369PLPX-2-2	1/8	1/8	11	.91	.75
W369PLPX-2-4	1/8	1/4	14	.93	.75
369PLPX-4M-0	5/32 (4MM)	10-32	8	.91	.75
W369PLPX-4M-2	5/32 (4MM)	1/8	11	.91	.75
W369PLPX-4M-4	5/32 (4MM)	1/4	14	.93	.75
369PLPX-4-0	1/4	10-32	11	1.10	.93
369PLPX-4-M7	1/4	M7	9	1.17	.93
W369PLPX-4-2	1/4	1/8	11	1.12	.93
W369PLPX-4-4	1/4	1/4	14	1.08	.93
W369PLPX-4-6	1/4	3/8	17	1.12	.93
W369PLPX-8M-2	5/16 (8MM)	1/8	13	1.32	1.16
W369PLPX-8M-4	5/16 (8MM)	1/4	14	1.28	1.16
W369PLPX-6-2	3/8	1/8	17	1.40	1.34
W369PLPX-6-4	3/8	1/4	17	1.41	1.33
W369PLPX-6-6	3/8	3/8	18	1.45	1.33

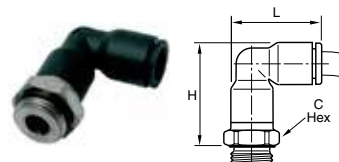

369PLPX Extended Male Elbow - BSPP

PART NO.	TUBE SIZE MM	BSPP / METRIC	C HEX MM	H
369PLPX-4M-M5	4	M5X0.8	8	23.0
369PLPX-4M-M7	4	M7X1	10	22.5
369PLPX-4M-2G	4	1/8	13	22.5
369PLPX-4M-4G	4	1/4	16	22.5
369PLPX-6M-M5	6	M5X0.8	10	27.5
369PLPX-6M-M7	6	M7X1	10	26.0
369PLPX-6M-2G	6	1/8	13	27.0
369PLPX-6M-4G	6	1/4	16	27.0
369PLPX-8M-2G	8	1/8	13	36.0
369PLPX-8M-4G	8	1/4	16	33.0
369PLPX-8M-6G	8	3/8	20	33.0
369PLPX-10M-4G	10	1/4	16	40.5
369PLPX-10M-6G	10	3/8	20	40.5
369PLPX-10M-8G	10	1/2	24	40.5
369PLPX-12M-4G	12	1/4	19	44.5
369PLPX-12M-6G	12	3/8	20	42.0
369PLPX-12M-8G	12	1/2	24	42.0
369PLPX-14M-6G	14	3/8	22	51.0
369PLPX-14M-8G	14	1/2	24	48.5

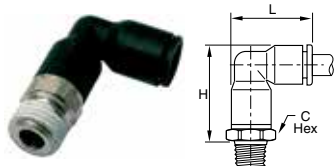

W369PLPX Extended Male Elbow - BSPT

PART NO.	TUBE SIZE MM	THREAD BSPT	C HEX MM	H	L
W369PLPX-4M-2R	4	1/8	10	23.0	19.0
W369PLPX-4M-4R	4	1/4	14	23.5	19.0
W369PLPX-6M-2R	6	1/8	10	27.0	22.5
W369PLPX-6M-4R	6	1/4	14	27.5	22.5
W369PLPX-8M-2R	8	1/8	13	34.5	29.5
W369PLPX-8M-4R	8	1/4	14	32.5	29.5
W369PLPX-8M-6R	8	3/8	17	33.0	29.5
W369PLPX-10M-4R	10	1/4	15	39.5	34.5
W369PLPX-10M-6R	10	3/8	17	39.5	34.5
W369PLPX-10M-8R	10	1/2	21	39.5	34.5
W369PLPX-12M-4R	12	1/4	19	45.5	40.5
W369PLPX-12M-6R	12	3/8	19	45.5	40.5
W369PLPX-12M-8R	12	1/2	21	45.5	40.5
W369PLPX-14M-6R	14	3/8	21	51.5	46.5
W369PLPX-14M-8R	14	1/2	21	51.5	46.5



W379PLP Male Elbow 45° - NPT

PART NO.	TUBE SIZE IN	THREAD NPT / UNF	C HEX MM	H	L
379PLP-2-0	1/8	10-32	8	.91	.49
W379PLP-2-2	1/8	1/8	11	.81	.49
W379PLP-4-2	1/4	1/8	11	.98	.57
W379PLP-4-4	1/4	1/4	14	.98	.57
W379PLP-6-4	3/8	1/4	17	1.36	.91
W379PLP-6-6	3/8	3/8	18	1.36	.91

[Click here for CADs, Product Specifications or to Configure Parts Online](#)

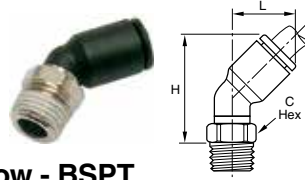

W379PLP 45° Male Elbow - BSPT

PART NO.	TUBE SIZE MM	BSPT	C HEX MM	H	L
W379PLP-4M-2R	4	1/8	10	24.5	13.0
W379PLP-6M-2R	6	1/8	10	28.0	14.5
W379PLP-6M-4R	6	1/4	14	30.0	14.5
W379PLP-8M-2R	8	1/8	10	33.5	19.5
W379PLP-8M-4R	8	1/4	14	33.5	19.5
W379PLP-8M-6R	8	3/8	17	33.5	19.5
W379PLP-10M-4R	10	1/4	15	38.5	23.0
W379PLP-10M-6R	10	3/8	17	39.0	23.0
W379PLP-10M-8R	10	1/2	21	40.5	23.0
W379PLP-12M-4R	12	1/4	15	44.0	26.0
W379PLP-12M-6R	12	3/8	17	44.0	26.0
W379PLP-12M-8R	12	1/2	21	46.0	26.0

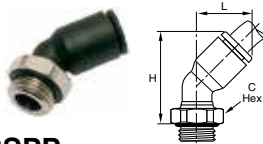

379PLP 45° Male Elbow - BSPP

PART NO.	TUBE SIZE MM	BSPP / M5	C HEX MM	H	L
379PLP-4M-M5	4	M5X0.8	8	23.0	13.0
379PLP-4M-2G	4	1/8	13	25.0	13.0
379PLP-6M-M5	6	M5X0.8	8	30.0	14.5
379PLP-6M-2G	6	1/8	13	28.5	14.5
379PLP-6M-4G	6	1/4	16	29.5	14.5
379PLP-8M-2G	8	1/8	13	36.0	19.5
379PLP-8M-4G	8	1/4	16	34.5	19.5
379PLP-8M-6G	8	3/8	20	34.5	19.5
379PLP-10M-4G	10	1/4	16	40.5	23.0
379PLP-10M-6G	10	3/8	20	39.0	23.0
379PLP-10M-8G	10	1/2	24	41.0	23.0
379PLP-12M-4G	12	1/4	16	46.0	26.0
379PLP-12M-6G	12	3/8	20	44.5	26.0
379PLP-12M-8G	12	1/2	24	46.0	26.0

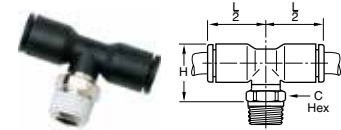

W372PLP Male Branch Tee - NPT

PART NO.	TUBE SIZE IN	THREAD NPT / UNF	C HEX MM	L/2	H
372PLP-2-0	1/8	10-32	8	.57	.61
W372PLP-2-1	1/8	1/16	10	.57	.61
W372PLP-2-2	1/8	1/8	11	.57	.61
W372PLP-2-4	1/8	1/4	14	.57	.63
372PLP-4M-0	5/32 (4MM)	10-32	8	.55	.71
W372PLP-4M-4	5/32 (4MM)	1/4	14	.55	.63
W372PLP-3-2	3/16	1/8	11	.85	.67
W372PLP-4-2	1/4	1/8	11	.71	.67
W372PLP-4-4	1/4	1/4	14	.71	.63
W372PLP-4-6	1/4	3/8	18	.71	.65
W372PLP-5-2	5/16	1/8	11	.91	.87
W372PLP-5-4	5/16	1/4	14	.91	.83
W372PLP-5-6	5/16	3/8	18	.91	.85
W372PLP-6-2	3/8	1/8	15	1.04	.99
W372PLP-6-4	3/8	1/4	15	1.04	.99
W372PLP-6-6	3/8	3/8	18	1.04	.95
W372PLP-6-8	3/8	1/2	22	1.04	.98
W372PLP-8-4	1/2	1/4	20	1.38	1.22
W372PLP-8-6	1/2	3/8	20	1.38	1.22
W372PLP-8-8	1/2	1/2	24	1.38	1.21

[Click here for CADs, Product Specifications or to Configure Parts Online](#)

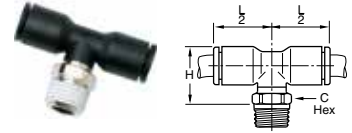
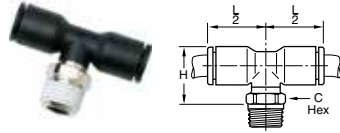

W372PLP Male Branch Tee - BSPT

PART NO.	TUBE SIZE IN	THREAD BSPT	C HEX MM	L/2	H
W372PLP-2-2R	1/8	1/8	10	.55	.61
W372PLP-4M-2R	5/32 (4MM)	1/8	10	.55	.61
W372PLP-4M-4R	5/32 (4MM)	1/4	14	.55	.63
W372PLP-3-2R	3/16	1/8	11	.85	.67
W372PLP-3-4R	3/16	1/4	14	.85	.67
W372PLP-4-2R	1/4	1/8	10	.71	.67
W372PLP-4-4R	1/4	1/4	14	.71	.63
W372PLP-8M-2R	5/16 (8MM)	1/8	10	.91	.87
W372PLP-8M-4R	5/16 (8MM)	1/4	14	.91	.83
W372PLP-8M-6R	5/16 (8MM)	3/8	17	.91	.83
W372PLP-6-4R	3/8	1/4	15	1.04	.95
W372PLP-6-6R	3/8	3/8	17	1.04	.95
W372PLP-8-4R	1/2	1/4	20	1.38	1.24
W372PLP-8-6R	1/2	3/8	20	1.38	1.22

W372PLP Male Branch Tee - BSPT

PART NO.	TUBE SIZE MM	BSPT	C HEX MM	H	L/2
W372PLP-4M-2R	4	1/8	10	15.5	14.0
W372PLP-4M-4R	4	1/4	14	16.0	14.0
W372PLP-6M-2R	6	1/8	10	17.5	16.0
W372PLP-6M-4R	6	1/4	14	18.0	16.0
W372PLP-8M-2R	8	1/8	10	22.0	23.0
W372PLP-8M-4R	8	1/4	14	21.0	23.0
W372PLP-8M-6R	8	3/8	17	21.0	23.0
W372PLP-10M-4R	10	1/4	15	24.0	26.5
W372PLP-10M-6R	10	3/8	17	24.0	26.5
W372PLP-10M-8R	10	1/2	21	24.0	26.5
W372PLP-12M-4R	12	1/4	15	27.0	31.0
W372PLP-12M-6R	12	3/8	17	27.0	31.0
W372PLP-12M-8R	12	1/2	21	27.0	31.0
W372PLP-14M-6R	14	3/8	20	30.5	35.5
W372PLP-14M-8R	14	1/2	24	28.5	35.5
W372PLP-16M-6R	16	3/8	27	53.0	38.5
W372PLP-16M-8R	16	1/2	27	53.0	38.5

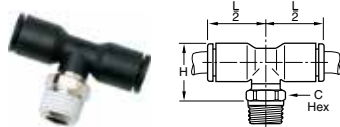

W372PLP Male Branch Tee - NPT

PART NO.	TUBE SIZE MM	NPT	C HEX MM	H	L/2
W372PLP-4M-2	4	1/8	11	.61	.55
W372PLP-4M-4	4	1/4	14	.63	.55
W372PLP-6M-2	6	1/8	11	.69	.63
W372PLP-6M-4	6	1/4	14	.71	.63
W372PLP-8M-2	8	1/8	11	.87	.91
W372PLP-8M-4	8	1/4	14	.83	.91
W372PLP-8M-6	8	3/8	18	.85	.91
W372PLP-10M-4	10	1/4	15	.98	1.04
W372PLP-10M-6	10	3/8	18	.95	1.04
W372PLP-10M-8	10	1/2	22	.98	1.04
W372PLP-12M-6	12	3/8	18	1.06	1.22
W372PLP-12M-8	12	1/2	22	.98	1.22

[Click here for CADs, Product Specifications or to Configure Parts Online](#)

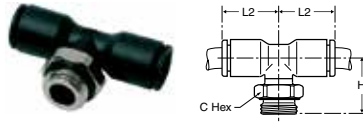

372PLP Male Branch Tee - BSPP

PART NO.	TUBE SIZE MM	BSPP / M5	C HEX MM	H	L/2
372PLP-4M-M5	4	M5X0.8	8	17.5	14.0
372PLP-4M-2G	4	1/8	13	15.0	14.0
372PLP-4M-4G	4	1/4	16	15.0	14.0
372PLP-6M-M5	6	M5X0.8	8	19.5	16.0
372PLP-6M-2G	6	1/8	13	17.0	16.0
372PLP-6M-4G	6	1/4	16	17.0	16.0
372PLP-8M-2G	8	1/8	13	23.5	23.0
372PLP-8M-4G	8	1/4	16	21.5	23.0
372PLP-8M-6G	8	3/8	20	21.5	23.0
372PLP-10M-4G	10	1/4	16	26.0	26.5
372PLP-10M-6G	10	3/8	20	24.0	26.5
372PLP-10M-8G	10	1/2	24	24.0	26.5
372PLP-12M-4G	12	1/4	16	29.0	31.0
372PLP-12M-6G	12	3/8	20	27.0	31.0
372PLP-12M-8G	12	1/2	24	27.0	31.0
372PLP-14M-6G	14	3/8	20	32.5	35.5
372PLP-14M-8G	14	1/2	24	27.0	35.5
372PLP-16M-6G	16	3/8	27	54.5	38.5
372PLP-16M-8G	16	1/2	27	54.5	38.5

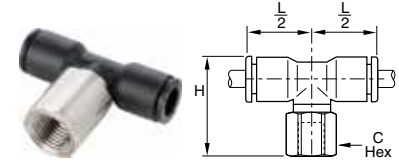

377PLP Female Branch Tee - NPT

PART NO.	TUBE SIZE IN	THREAD NPT / UNF	C HEX MM	L/2	H
377PLP-2-2	1/8	1/8	13	.57	.99
377PLP-4M-2	5/32 (4MM)	1/8	13	.55	.91
377PLP-4M-4	5/32 (4MM)	1/4	16	.55	1.08
377PLP-4-2	1/4	1/8	13	.71	1.02
377PLP-4-4	1/4	1/4	16	.71	1.18
377PLP-8M-2	5/16 (8MM)	1/8	13	.91	1.24
377PLP-8M-4	5/16 (8MM)	1/4	16	.91	1.40
377PLP-6-4	3/8	1/4	16	1.04	1.60
377PLP-8-6	1/2	3/8	22	1.38	1.88

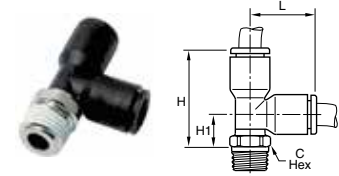

W371PLP Male Run Tee - NPT

PART NO.	TUBE SIZE IN	THREAD NPT / UNF	C HEX MM	L	H	H1
371PLP-2-0	1/8	10-32	8	.57	.92	.35
W371PLP-2-1	1/8	1/16	10	.57	.93	.35
W371PLP-2-2	1/8	1/8	11	.57	.93	.35
371PLP-4M-0	5/32 (4MM)	10-32	8	.57	1.02	.45
W371PLP-4M-2	5/32 (4MM)	1/8	11	.57	.93	.53
W371PLP-4M-4	5/32 (4MM)	1/4	14	.57	.94	.37
W371PLP-3-2	3/16	1/8	11	.85	1.31	.45
W371PLP-4-2	1/4	1/8	11	.69	1.16	.45
W371PLP-4-4	1/4	1/4	14	.69	1.12	.41
W371PLP-4-6	1/4	3/8	18	.69	1.14	.43
W371PLP-8M-2	5/16 (8MM)	1/8	11	.91	1.38	.49
W371PLP-8M-4	5/16 (8MM)	1/4	14	.91	1.34	.45
W371PLP-8M-6	5/16 (8MM)	3/8	18	.91	1.36	.47
W371PLP-6-2	3/8	1/8	15	1.04	1.63	.60
W371PLP-6-4	3/8	1/4	15	1.04	1.63	.60
W371PLP-6-6	3/8	3/8	18	1.04	1.60	.55
W371PLP-6-8	3/8	1/2	22	1.04	1.63	.59
W371PLP-8-4	1/2	1/4	20	1.38	2.17	.79
W371PLP-8-6	1/2	3/8	20	1.38	2.17	.79
W371PLP-8-8	1/2	1/2	24	1.38	2.07	.79

[Click here for CADs, Product Specifications or to Configure Parts Online](#)

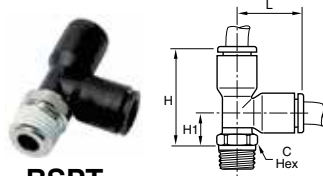

W371PLP Male Run Tee - BSPT

PART NO.	TUBE SIZE MM	THREAD BSPT	C HEX MM	H	H1	L
W371PLP-4M-2R	4	1/8	10	23.5	9.0	14.5
W371PLP-4M-4R	4	1/4	14	24.0	9.5	14.5
W371PLP-6M-2R	6	1/8	10	27.5	10.0	17.5
W371PLP-6M-4R	6	1/4	14	28.0	10.5	17.5
W371PLP-8M-2R	8	1/8	10	35.0	12.0	23.0
W371PLP-8M-4R	8	1/4	14	34.0	11.0	23.0
W371PLP-8M-6R	8	3/8	17	34.0	11.0	23.0
W371PLP-10M-4R	10	1/4	15	40.5	14.0	26.5
W371PLP-10M-6R	10	3/8	17	40.5	14.0	26.5
W371PLP-10M-8R	10	1/2	21	40.5	14.0	26.5
W371PLP-12M-4R	12	1/4	15	46.5	15.5	31.0
W371PLP-12M-6R	12	3/8	17	46.5	15.5	31.0
W371PLP-12M-8R	12	1/2	21	46.5	15.5	31.0
W371PLP-14M-8R	14	1/2	24	52.5	17.5	35.5
W371PLP-16M-6R	16	3/8	27	38.5	78	39.5
W371PLP-16M-8R	16	1/2	27	38.5	78	39.5

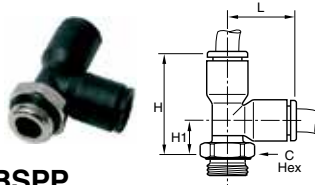

371PLP Male Run Tee - BSPP

PART NO.	TUBE SIZE MM	BSPP / M5	C HEX MM	H	H1	L
371PLP-4M-M5	4	M5X0.8	8	26.0	11.5	14.5
371PLP-4M-2G	4	1/8	13	23.0	8.5	14.5
371PLP-4M-4G	4	1/4	16	23.0	8.5	14.5
371PLP-6M-M5	6	M5X0.8	8	29.5	12.5	17.5
371PLP-6M-2G	6	1/8	13	27.0	10.0	17.5
371PLP-6M-4G	6	1/4	16	27.0	10.0	17.5
371PLP-8M-2G	8	1/8	13	36.5	14.0	23.0
371PLP-8M-4G	8	1/4	16	34.5	12.0	23.0
371PLP-8M-6G	8	3/8	20	34.5	12.0	23.0
371PLP-10M-4G	10	1/4	16	42.0	15.5	26.5
371PLP-10M-6G	10	3/8	20	40.5	14.0	26.5
371PLP-10M-8G	10	1/2	24	40.5	14.0	26.5
371PLP-12M-4G	12	1/4	16	48.0	17.0	31.0
371PLP-12M-6G	12	3/8	20	46.5	15.5	31.0
371PLP-12M-8G	12	1/2	24	46.5	15.5	31.0
371PLP-14M-6G	14	3/8	20	56.5	21.5	35.5
371PLP-14M-8G	14	1/2	24	51.0	16.0	35.5
371PLP-16M-6G	16	3/8	27	38.5	79.5	41
371PLP-16M-8G	16	1/2	27	38.5	79.5	41

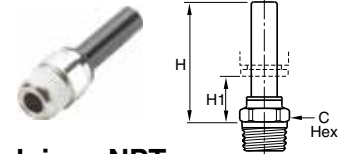

W68PLPSP Male Standpipe - NPT

PART NO.	TUBE SIZE IN	THREAD NPT / UNF	C HEX MM	H	H1
68PLPSP-4M-0	5/32 (4MM)	10-32	8	1.24	
W68PLPSP-4M-2	5/32 (4MM)	1/8	11	1.02	.57
W68PLPSP-4M-4	5/32 (4MM)	1/4	14	1.04	.59
W68PLPSP-4-2	1/4	1/8	11	1.18	.61
W68PLPSP-4-4	1/4	1/4	14	1.12	.57
W68PLPSP-8M-2	5/16 (8MM)	1/8	11	1.16	.43
W68PLPSP-8M-4	5/16 (8MM)	1/4	14	1.12	.39
W68PLPSP-6-2	3/8	1/8	15	1.47	.81
W68PLPSP-6-4	3/8	1/4	15	1.42	.67
W68PLPSP-6-6	3/8	3/8	17	1.42	.61
W68PLPSP-8-6	1/2	3/8	17	1.44	.37
W68PLPSP-8-8	1/2	1/2	21	1.46	.39

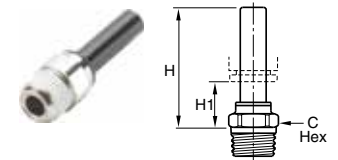

W68PLPSP Male Standpipe - BSPT

PART NO.	TUBE SIZE MM	BSPT	C HEX MM	H	H1
W68PLPSP-4M-2R	4	1/8	10	26.0	14.0
W68PLPSP-4M-4R	4	1/4	14	26.5	14.5
W68PLPSP-6M-2R	6	1/8	10	28.0	14.0
W68PLPSP-6M-4R	6	1/4	14	28.5	14.5
W68PLPSP-8M-2R	8	1/8	10	29.5	11.0
W68PLPSP-8M-4R	8	1/4	14	28.5	10.0
W68PLPSP-10M-4R	10	1/4	15	36.0	15.5
W68PLPSP-10M-6R	10	3/8	17	36.0	15.5
W68PLPSP-10M-8R	10	1/2	21	36.0	15.5
W68PLPSP-12M-6R	12	3/8	17	36.5	12.0
W68PLPSP-12M-8R	12	1/2	21	36.5	12.0

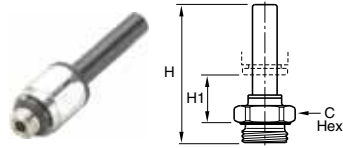

68PLPSP Male Standpipe - BSPP

PART NO.	TUBE SIZE MM	BSPP	C HEX MM	H	H1
68PLPSP-4M-M5	4	M5X0.8	8	31.0	16.0
68PLPSP-4M-2G	4	1/8	13	30.0	13.5
68PLPSP-4M-4G	4	1/4	16	31.0	13.5
68PLPSP-6M-2G	6	1/8	13	32.0	13.5
68PLPSP-6M-4G	6	1/4	16	33.0	13.5
68PLPSP-8M-2G	8	1/8	13	35.5	12.5
68PLPSP-8M-4G	8	1/4	16	34.5	10.5
68PLPSP-8M-6G	8	3/8	20	34.5	10.5
68PLPSP-10M-4G	10	1/4	16	43.5	17.5
68PLPSP-10M-6G	10	3/8	20	41.5	15.5
68PLPSP-10M-8G	10	1/2	24	41.5	15.5
68PLPSP-12M-6G	12	3/8	20	42.0	12.0
68PLPSP-12M-8G	12	1/2	24	43.5	12.0
68PLPSP-14M-6G	14	3/8	20	46.5	14.0
68PLPSP-14M-8G	14	1/2	24	48.0	13.5



W368PLP Male Y Connector - BSPT

PART NO.	TUBE SIZE MM	BSPT	C HEX MM	H	L	N
W368PLP-4M-2R	4	1/8	10	32.5	17.5	9.0
W368PLP-4M-4R	4	1/4	14	33.0	17.5	9.0
W368PLP-6M-2R	6	1/8	10	39.5	21.5	1.0
W368PLP-6M-4R	6	1/4	14	40.0	21.5	1.0
W368PLP-8M-2R	8	1/8	13	56.5	28.0	14.5
W368PLP-8M-4R	8	1/4	14	55.5	28.0	14.5
W368PLP-8M-6R	8	3/8	16	48.5	28.0	14.5
W368PLP-10M-4R	10	1/4	14	60.0	39.0	20.0
W368PLP-10M-6R	10	3/8	16	60.5	39.0	20.0
W368PLP-10M-8R	10	1/2	24	61.0	39.0	20.0
W368PLP-12M-6R	12	3/8	19	66.0	39.0	20.0
W368PLP-12M-8R	12	1/2	21	66.0	39.0	20.0

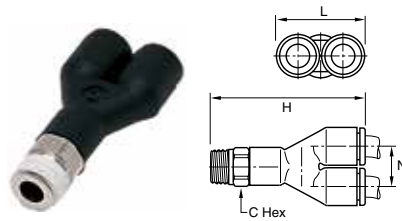

W368PLP Male Y Connector - NPT

PART NO.	TUBE SIZE IN	THREAD NPT	C HEX MM	H	L	N
W368PLP-4M-2	5/32 (4MM)	1/8	11	1.28	.69	.35
W368PLP-4M-4	5/32 (4MM)	1/4	14	1.30	.69	.35
W368PLP-4-2	1/4	1/8	11	1.61	.87	.45
W368PLP-4-4	1/4	1/4	14	1.56	.87	.45
W368PLP-6-4	3/8	1/4	17	2.24	1.30	.67
W368PLP-6-6	3/8	3/8	18	2.28	1.30	.67



368PLP Male Y Connector - BSPP

PART NO.	TUBE SIZE MM	BSPP / M5	C HEX MM	H	L	N
368PLP-4M-M5	4	M5X0.8	8	32.5	17.5	9.0
368PLP-4M-2G	4	1/8	13	32.0	17.5	9.0
368PLP-4M-4G	4	1/4	16	32.0	17.5	9.0
368PLP-6M-M5	6	M5X0.8	10	39.5	21.5	11.0
368PLP-6M-2G	6	1/8	13	39.0	21.5	11.0
368PLP-6M-4G	6	1/4	16	39.0	21.5	11.0
368PLP-8M-2G	8	1/8	13	56.0	28.0	14.5
368PLP-8M-4G	8	1/4	16	55.0	28.0	14.5
368PLP-8M-6G	8	3/8	19	54.0	28.0	14.5
368PLP-10M-4G	10	1/4	16	63.5	33.0	17.0
368PLP-10M-6G	10	3/8	20	63.5	33.0	17.0
368PLP-10M-8G	10	1/2	20	65.0	33.0	17.0
368PLP-12M-6G	12	3/8	19	68.0	39.0	20.0
368PLP-12M-8G	12	1/2	24	70.0	39.0	20.0

[Click here for CADs, Product Specifications or to Configure Parts Online](#)

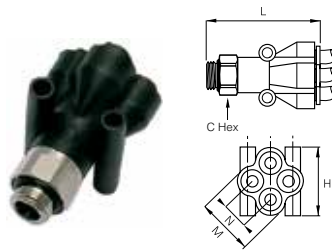

W368PLPD Double Y Male Connector - BSPT

PART NO.	TUBE SIZE MM	BSPT	C HEX MM	H	L	M	N	MOUNTING HOLE DIA
W368PLPD-4M-2R	4	1/8	13	25.5	41.5	21.0	10.0	3.7
W368PLPD-4M-4R	4	1/4	16	25.5	43.5	21.0	10.0	3.7
W368PLPD-6M-2R	6	1/8	19	31.5	54.5	26.5	12.0	3.7
W368PLPD-6M-4R	6	1/4	19	31.5	57.5	26.5	12.0	3.7

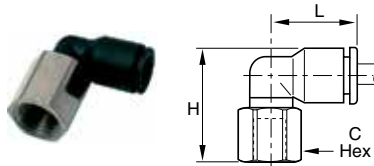

370PLP Female Elbow Swivel - NPT

PART NO.	TUBE SIZE IN	THREAD NPT	C HEX MM	L	H
370PLP-2-2	1/8	1/8	13	.57	.91
370PLP-4M-2	5/32 (4MM)	1/8	13	.55	.91
370PLP-4M-4	5/32 (4MM)	1/4	16	.55	1.08
370PLP-4-2	1/4	1/8	13	.71	1.02
370PLP-4-4	1/4	1/4	16	.71	1.18
370PLP-8M-2	5/16 (8MM)	1/8	13	.91	1.12
370PLP-8M-4	5/16 (8MM)	1/4	16	.91	1.28
370PLP-6-2	3/8	1/8	16	1.04	1.52
370PLP-6-4	3/8	1/4	16	1.04	1.52
370PLP-8-6	1/2	3/8	22	1.38	1.88

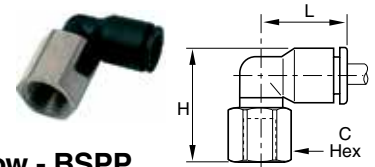

370PLP Female Elbow - BSPP

PART NO.	TUBE SIZE MM	BSPP	C HEX MM	H	L
370PLP-4M-2G	4	1/8	13	23.0	14.0
370PLP-4M-4G	4	1/4	16	27.0	14.0
370PLP-6M-2G	6	1/8	13	25.0	16.0
370PLP-6M-4G	6	1/4	16	29.0	16.0
370PLP-8M-2G	8	1/8	13	28.0	23.0
370PLP-8M-4G	8	1/4	16	32.0	23.0
370PLP-8M-6G	8	3/8	19	33.0	23.0
370PLP-10M-4G	10	1/4	16	34.5	26.5
370PLP-10M-6G	10	3/8	19	35.0	26.5
370PLP-10M-8G	10	1/2	24	41.0	26.5
370PLP-12M-4G	12	1/4	16	38.0	30.5
370PLP-12M-6G	12	3/8	19	38.5	30.5
370PLP-12M-8G	12	1/2	24	43.5	30.5

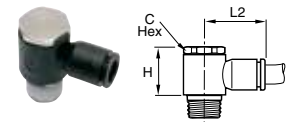

W369PLPBJ Banjo - NPT

PART NO.	TUBE SIZE IN	THREAD NPT / UNF	C HEX MM	H	L2
369PLPBJ-2-0	1/8	10-32		.79	.65
369PLPBJ-4M-0	5/32 (4MM)	10-32		.79	.65
W369PLPBJ-4M-2	5/32 (4MM)	1/8	13	.73	.73
369PLPBJ-4-0	1/4	10-32		.79	.73
W369PLPBJ-4-2	1/4	1/8	13	.73	.83
W369PLPBJ-4-4	1/4	1/4	17	.89	.91
W369PLPBJ-4-6	1/4	3/8	21	1.04	1.12
W369PLPBJ-6-4	3/8	1/4	17	.89	1.12
W369PLPBJ-6-6	3/8	3/8	21	1.04	1.20

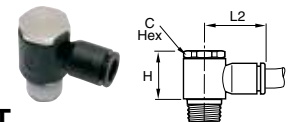

W369PLPBJ Banjo - BSPT

PART NO.	TUBE SIZE MM	BSPT	C HEX MM	H	L2
W369PLPBJ-6M-2R	6	1/8	13	18.5	20.0
W369PLPBJ-6M-4R	6	1/4	17	22.5	22.0
W369PLPBJ-8M-2R	8	1/8	13	18.5	25.0
W369PLPBJ-8M-4R	8	1/4	17	22.5	27.0
W369PLPBJ-10M-4R	10	1/4	17	22.5	29.0
W369PLPBJ-10M-6R	10	3/8	21	26.5	31.0
W369PLPBJ-12M-4R	12	1/4	21	26.5	34.5
W369PLPBJ-12M-6R	12	3/8	21	26.5	34.5

Click here for CADs, Product Specifications or to Configure Parts Online

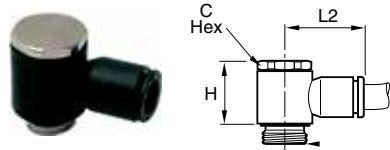

369PLPBJ Banjo - BSPP

PART NO.	TUBE SIZE MM	BSPP / METRIC	C HEX MM	H	L2
369PLPBJ-3M-M3*	3	M3X0.5		13.0	16.0
369PLPBJ-4M-M5*	4	M5X0.8		13.0	16.0
369PLPBJ-4M-2G	4	1/8	13	17.0	18.5
369PLPBJ-6M-M5*	6	M5X0.8		13.0	18.5
369PLPBJ-6M-2G	6	1/8	13	17.0	20.0
369PLPBJ-6M-4G	6	1/4	17	21.0	22.0
369PLPBJ-8M-2G	8	1/8	13	16.5	25.0
369PLPBJ-8M-4G	8	1/4	17	21.0	27.0
369PLPBJ-8M-6G	8	3/8	20	24.5	29.0
369PLPBJ-10M-4G	10	1/4	17	21.0	29.0
369PLPBJ-10M-6G	10	3/8	20	24.5	31.0
369PLPBJ-10M-8G	10	1/2	25	27.5	36.5
369PLPBJ-12M-6G	12	3/8	20	24.5	34.5
369PLPBJ-12M-8G	12	1/2	25	27.5	36.5

*With screwdriver slot

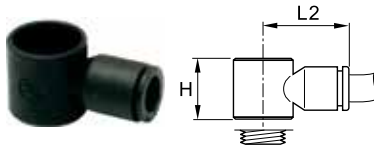

369PLPBJB Banjo Bodies

PART NO.	TUBE SIZE MM	BSPP / M5	H	L2
369PLPBJB-4M-M5	4	M5X0.8	13.0	16.0
369PLPBJB-4M-2G	4	1/8	14.5	18.5
369PLPBJB-6M-M5	6	M5X0.8	13.0	18.5
369PLPBJB-6M-2G	6	1/8	14.5	20.0
369PLPBJB-6M-4G	6	1/4	18.0	22.0
369PLPBJB-8M-2G	8	1/8	14.5	25.0
369PLPBJB-8M-4G	8	1/4	18.0	27.0
369PLPBJB-8M-6G	8	3/8	21.5	29.0
369PLPBJB-10M-4G	10	1/4	18.0	29.0
369PLPBJB-10M-6G	10	3/8	21.5	31.0
369PLPBJB-12M-6G	12	3/8	21.5	34.5

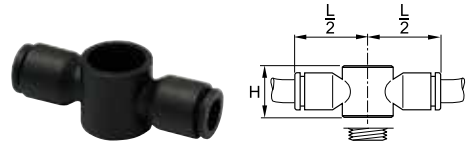

32PLPDJB Double Banjo Bodies

PART NO.	TUBE SIZE MM	BSPP / M5	H	L/2
32PLPDJB-6M-2G	6	1/8	14.4	20.0
32PLPDJB-6M-4G	6	1/4	18.0	26.0
32PLPDJB-8M-4G	8	1/4	18.0	27.0

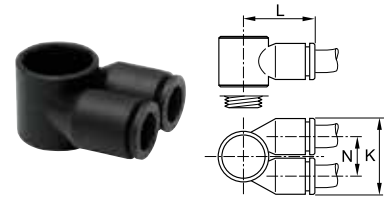

369PLPTJB Twin Banjo Bodies

PART NO.	TUBE SIZE MM	BSPP / M5	K	L	N
369PLPTJB-4M-4G	4	1/4	28.0	25.0	14.5
369PLPTJB-6M-2G	6	1/8	22.5	20.5	12.0
369PLPTJB-6M-4G	6	1/4	28.0	25.0	14.5
369PLPTJB-6M-6G	6	3/8	33.0	28.5	17.0
369PLPTJB-8M-4G	8	1/4	28.0	26.0	14.5
369PLPTJB-8M-6G	8	3/8	33.0	29.5	17.0

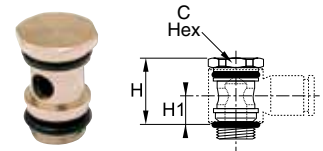

68BJB Single Banjo Bolt

PART NO.	BSPP / M5	C HEX MM	H	H1
68BJB-M5*	M5X0.8		17.0	7.5
68BJB-2G	1/8	13	17.0	7.5
68BJB-4G	1/4	17	21.0	9.5
68BJB-6G	3/8	20	24.5	11.0

*With screwdriver slot

[Click here for CADs, Product Specifications or to Configure Parts Online](#)

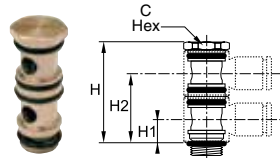

68BJBD Double Banjo Bolt

PART NO.	BSPP / M5	C HEX MM	H	H1	H2
68BJBD-M5*	M5X0.8		24.5	7.5	18.5
68BJBD-2G	1/8	13	31.0	7.5	22.0
68BJBD-4G	1/4	17	39.0	9.5	27.5
68BJBD-6G	3/8	20	46.0	11.0	32.5

*With screwdriver slot

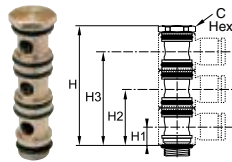

68BJBT Triple Banjo Bolt

PART NO.	BSPP	C HEX MM	H	H1	H2	H3
68BJBT-2G	1/8	13	45.5	7.5	22.0	36.0
68BJBT-4G	1/4	17	54.0	9.5	27.5	45.5
68BJBT-6G	3/8	20	67.5	11.0	32.5	54.0

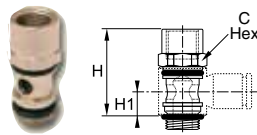

66BJB Female Threaded Banjo Bolt

PART NO.	1 BSPP / M5	2 BSPP / M5	C HEX MM	H	H1
66BJB-2G	1/8	1/8	13	24.5	7.5
66BJB-4G	1/4	1/4	17	33.0	9.5
66BJB-6G	3/8	3/8	20	37.5	11.0
66BJB-8G	1/2	1/2	25	42.0	11.5

*With screwdriver slot

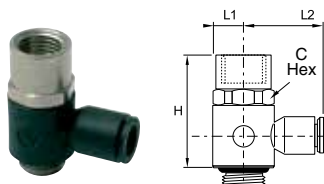

376PLPBJ Banjo with Female Bolt

PART NO.	TUBE SIZE MM	BSPP / M5	C HEX MM	H	L1	L2
376PLPBJ-4M-2G	4	1/8	13	25.5	7.0	18.5
376PLPBJ-6M-4G	6	1/4	17	33.0	9.0	22.0
376PLPBJ-8M-6G	8	3/8	20	37.5	11	29.0

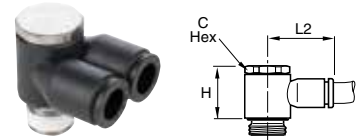

W369PLPTJ Twin Banjo - NPT

PART NO.	TUBE SIZE IN	THREAD NPT / UNF	C HEX MM	H	L2
369PLPTJ-4M-0	5/32 (4MM)	10-32		.63	.61
W369PLPTJ-4M-2	5/32 (4MM)	1/8	13	.73	.73
W369PLPTJ-4-2	1/4	1/8	13	.73	.73
W369PLPTJ-4-4	1/4	1/4	17	.89	1.04
W369PLPTJ-6-4	3/8	1/4	21	1.04	1.22
W369PLPTJ-6-6	3/8	3/8	21	1.04	1.22

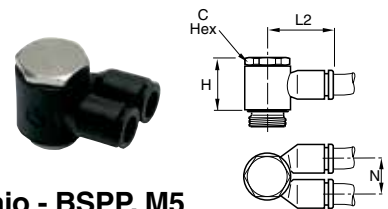

369PLPTJ Twin Banjo - BSPP, M5

PART NO.	TUBE SIZE MM	BSPP / M5	C HEX MM	H	L2	N
369PLPTJ-4M-M5	4	M5X0.8		13.0	16.0	9.0
369PLPTJ-4M-2G	4	1/8	13	16.5	18.5	11.5
369PLPTJ-6M-2G	6	1/8	13	16.5	18.5	11.5
369PLPTJ-6M-4G	6	1/4	17	21.0	27.0	14.5
369PLPTJ-8M-4G	8	1/4	17	21.0	27.0	14.5
369PLPTJ-8M-6G	8	3/8	20	24.5	31.0	17.0
369PLPTJ-10M-6G	10	3/8	20	24.5	31.0	17.0

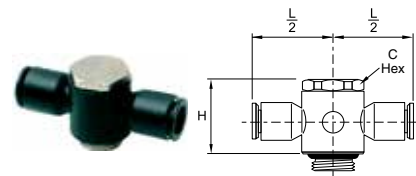

32PLPDJ Double Banjo - BSPP, M5

PART NO.	TUBE SIZE MM	BSPP / M5	C HEX MM	H	L/2
32PLPDJ-4M-M5	4	M5X0.8		13.0	16.0
32PLPDJ-6M-2G	6	1/8	13	17.0	20.0
32PLPDJ-6M-4G	6	1/4	17	21.0	26.5
32PLPDJ-8M-4G	8	1/4	17	21.0	27.0
32PLPDJ-8M-6G	8	3/8	20	24.5	30.5

[Click here for CADs, Product Specifications or to Configure Parts Online](#)

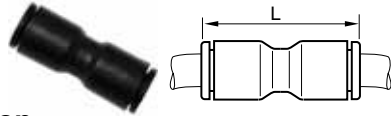

32PLP Equal Union

PART NO.	TUBE SIZE IN	L
32PLP-2	1/8	.97
32PLP-3	3/16	1.44
32PLP-4	1/4	1.16
32PLP-6	3/8	1.65
32PLP-8	1/2	2.17

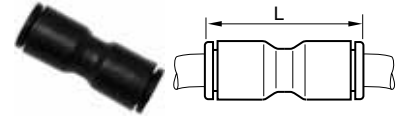

32PLP Converter

PART NO.	TUBE SIZE IN	TUBE SIZE MM	L
32PLP-6M-4	1/4	6	1.18
32PLP-10M-6	3/8	10	1.99
32PLP-12M-8	1/2	12	2.25

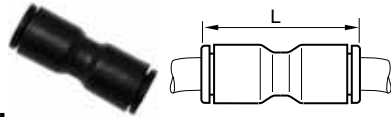

32PLP Unequal Union

PART NO.	1 TUBE SIZE IN	2 TUBE SIZE IN	L
32PLP-4M-2	5/32 (4M)	1/8	0.96
32PLP-4M-4	5/32 (4M)	1/4	1.16
32PLP-4-2	1/4	1/8	1.32
32PLP-4-8M	1/4	5/16 (8M)	1.44
32PLP-6-4	3/8	1/4	1.61
32PLP-6-8	3/8	1/2	2.17



365PLP Union Elbow

PART NO.	TUBE SIZE IN	L
365PLP-2	1/8	.71
365PLP-3	3/16	1.07
365PLP-4	1/4	.93
365PLP-6	3/8	1.33
365PLP-8	1/2	1.38

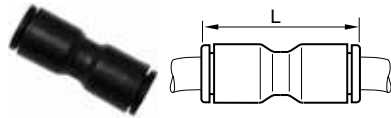

32PLP Union

PART NO.	TUBE SIZE MM	L
32PLP-3M	3	25.0
32PLP-4M	4	25.0
32PLP-6M	6	28.5
32PLP-8M	8	38.0
32PLP-10M	10	42.0
32PLP-12M	12	50.5
32PLP-14M	14	56.0
32PLP-16M	16	60.5

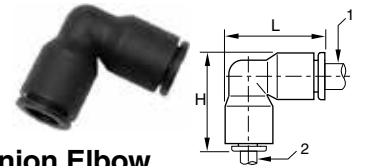

365PLP Unequal Union Elbow

PART NO.	1 TUBE SIZE IN	2 TUBE SIZE IN	L	H
365PLP-2-4	1/8	1/4	.93	.93
365PLP-4M-4	5/32 (4M)	1/4	.93	.93
365PLP-6-4	3/8	1/4	1.33	1.30
365PLP-6-8	3/8	1/2	1.81	1.81

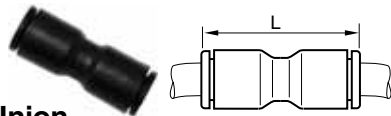

32PLP Unequal Union

PART NO.	1 TUBE SIZE MM	2 TUBE SIZE MM	L
32PLP-3M-4M	3	4	25.0
32PLP-6M-4M	6	4	28.0
32PLP-8M-4M	8	4	28.0
32PLP-8M-6M	8	6	38.0
32PLP-10M-6M	10	6	42.0
32PLP-10M-8M	10	8	42.0
32PLP-12M-8M	12	8	50.5
32PLP-12M-10M	12	10	50.5
32PLP-12M-14M	12	14	56.0
32PLP-12M-16M	16	12	61.0



365PLP Union Elbow

PART NO.	TUBE SIZE MM	L
365PLP-4M	4	19.0
365PLP-6M	6	22.5
365PLP-8M	8	29.5
365PLP-10M	10	34.5
365PLP-12M	12	40.5
365PLP-14M	14	46.5
365PLP-16M	16	52.0

[Click here for CADs, Product Specifications or to Configure Parts Online](#)



365PLP Unequal Union Elbow

PART NO.	1 TUBE SIZE MM	2 TUBE SIZE MM	L
365PLP-4M-6M	4	6	22.5
365PLP-6M-8M	6	8	29.5
365PLP-8M-10M	8	10	34.5
365PLP-10M-12M	10	12	40.5



364PLP Unequal Union Tee

PART NO.	1 TUBE SIZE MM	2 TUBE SIZE MM	H	L/2
364PLP-4M-6M	4	6	22.5	17.5
364PLP-6M-4M	6	4	22.5	17.5
364PLP-6M-8M	6	8	29.5	23.0
364PLP-8M-6M	8	6	29.5	23.0
364PLP-8M-10M	8	10	34.5	26.5
364PLP-10M-12M	10	12	34.5	26.5
364PLP-10M-8M	10	8	40.5	31.0
364PLP-12M-10M	12	10	40.5	31.0
364PLP-14M-8M	14	8	46.0	35.5
364PLP-16M-12M	16	12	39.0	

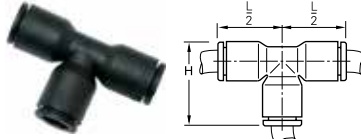

364PLP Union Tee

PART NO.	TUBE SIZE IN	L/2	H
364PLP-2	1/8	.57	.75
364PLP-3	3/16	.85	1.07
364PLP-4	1/4	.71	.92
364PLP-6	3/8	1.02	1.34
364PLP-8	1/2	1.38	1.81



362PLP Union Y

PART NO.	1 TUBE SIZE IN	2 TUBE SIZE IN	L	H	N
362PLP-2	1/8	1/8	1.12	.69	.35
362PLP-2-4	1/8	1/4	1.42	.87	.45
362PLP-4M-4	5/32 (4MM)	1/4	1.42	.87	.45
362PLP-4	1/4	1/4	1.42	.87	.45
362PLP-4-6	1/4	3/8	2.02	1.30	.67
362PLP-6	3/8	3/8	2.09	1.30	.67
362PLP-8	1/2	1/2	2.64	1.77	.91

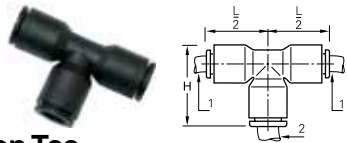

364PLP Unequal Union Tee

PART NO.	1 TUBE SIZE IN	2 TUBE SIZE IN	L/2	H
364PLP-2-4	1/8	1/4	.71	.93
364PLP-4M-4	5/32 (4MM)	1/4	.71	.93
364PLP-4-2	1/4	1/8	.73	.93
364PLP-4-4M	1/4	5/32 (4MM)	.73	.93
364PLP-4-6	1/4	3/8	.96	1.32
364PLP-6-4	3/8	1/4	1.00	1.28
364PLP-6-8	3/8	1/2	1.38	1.81
364PLP-8-4	1/2	1/4	1.38	1.81
364PLP-8-6	1/2	3/8	1.38	1.81

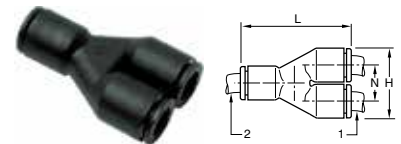

362PLP Union Y

PART NO.	1 TUBE SIZE MM	2 TUBE SIZE (M)	H	L	N
362PLP-4M	4	4	17.5	28.5	9.0
362PLP-6M	6	6	21.5	35.0	11.0
362PLP-8M	8	8	28.0	45.0	14.5
362PLP-10M	10	10	33.0	53.0	17.0
362PLP-4M-6M	4	6	17.5	33.0	9.0
362PLP-6M-8M	6	8	22.5	41.0	11.5
362PLP-8M-10M	8	10	28.0	47.0	14.5
362PLP-10M-12M	10	12	33.0	57.0	17.0

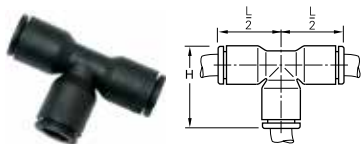

364PLP Union Tee

PART NO.	TUBE SIZE MM	H	L/2
364PLP-3M	3	19.0	14.5
364PLP-4M	4	19.0	14.5
364PLP-6M	6	23.5	18.0
364PLP-8M	8	29.5	23.0
364PLP-10M	10	34.5	26.5
364PLP-12M	12	40.5	31.0
364PLP-14M	14	46.0	35.5
364PLP-16M	16	52.0	39.0

[Click here for CADs, Product Specifications or to Configure Parts Online](#)

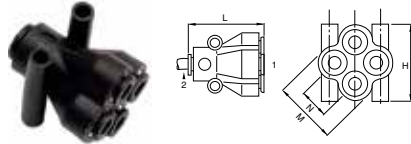

362PLPD Double Y Connector

PART NO.	1 TUBE SIZE IN	2 TUBE SIZE IN	H	L	M	N	MOUNTING HOLE DIA.
362PLPD-4M-4	5/32 (4MM)	1/4	1.00	1.18	.83	.39	.15

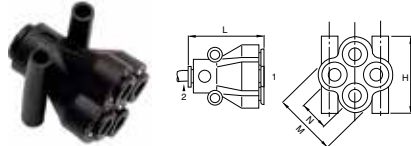

362PLPD Double Y Connector

PART NO.	1 TUBE SIZE MM	2 TUBE SIZE MM	H	L	M	N	MOUNTING HOLE DIA.
362PLPD-4M	4	4	25.5	30.5	21.0	10.0	3.7
362PLPD-6M	6	6	31.5	37.5	26.5	12.0	3.7
362PLPD-4M-6M	4	6	25.5	30.5	21.0	10.0	3.7
362PLPD-6M-8M	6	8	31.5	38.0	26.5	12.0	3.7



32PLPBH Bulkhead Union

PART NO.	TUBE SIZE IN	C HEX MM	K MAX	L1	L2	BULKHEAD THREAD	BULKHEAD HOLE DIA.
32PLPBH-2	1/8	13	.22	.37	.61	M10 X 1	12MM
32PLPBH-4	1/4	16	.35	.37	.81	M15 X 1	16MM
32PLPBH-6	3/8	22	.57	.51	1.18	M18 X 1.5	24MM
32PLPBH-8	1/2	29	.81	.67	1.61	M25 X 1.5	26MM

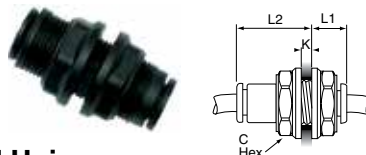

32PLPBH Bulkhead Union

PART NO.	TUBE SIZE MM	C HEX MM	K MAX	L1	L2	BULKHEAD THREAD	BULKHEAD HOLE DIA.
32PLPBH-4M	4	13	5.5	15.0	10.0	M12 X 1	12MM
32PLPBH-6M	6	15	8.5	18.0	10.5	M14 X 1	14MM
32PLPBH-8M	8	18	14.5	25.0	13.5	M16 X 1	16MM
32PLPBH-10M	10	22	14.5	27.5	15.5	M22 X 1.5	22MM
32PLPBH-12M	12	26	18.5	33.0	18.0	M24 X 1.5	24MM
32PLPBH-14M	14	29	20.5	37.5	20.5	M26 X 1.5	26MM

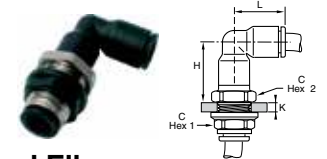

365PLPBH Equal Bulkhead Elbow

PART NO.	TUBE SIZE IN	C1 HEX	C2 HEX	K MAX	H	L	BULKHEAD THREAD	BHD HOLE DIA.
365PLPBH-2	1/8	13	13	.28	.71	.57	M10 X 1	10MM
365PLPBH-4M	5/32(4MM)		13	.26	.83	.67	M12 X 1	12MM
365PLPBH-4	1/4	18	17	.32	.87	.71	M15 X 1	15MM
365PLPBH-8M	5/16(8MM)		18	.31	1.22	.94	M16 X 1	16MM
365PLPBH-6	3/8	22	22	.33	1.08	1.00	M18 X 1.5	18MM
365PLPBH-8	1/2	29	27	.41	1.54	1.38	M25 X 1.5	25MM

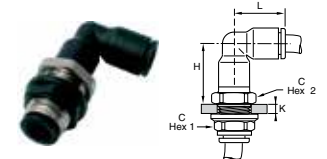

365PLPBH Equal Bulkhead Elbow

PART NO.	TUBE SIZE MM	C1 HEX	C2 HEX	K MAX	H	L	BULKHEAD THREAD	BULKHEAD HOLE DIA.
365PLPBH-4M	4	13	13	6.5	21.0	17.0	M12 X 1	12MM
365PLPBH-6M	6	15	15	7.0	24.5	19.5	M14 X 1	14MM
365PLPBH-8M	8	18	18	8.0	31.0	24.0	M16 X 1	16MM
365PLPBH-10M	10	22	22	8.5	36.0	28.0	M22 X 1.5	22MM
365PLPBH-12M	12	26	26	8.5	42.0	33.0	M24 X 1.5	24MM

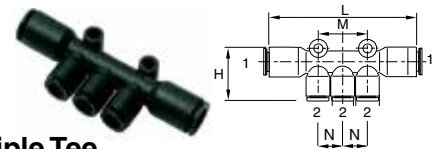

24PLP Multiple Tee

PART NO.	1 TUBE SIZE IN	2 TUBE SIZE IN	H	L	M	N	MTG HOLE DIA.
24PLP-4-4M	1/4	5/32(4MM)	0.97	2.81	.90	.45	.17
24PLP-4-4	1/4	1/4	1.22	3.14	1.21	.61	.17
24PLP-6-4	3/8	1/4	1.34	3.21	1.22	.61	.17

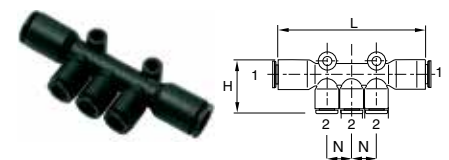

24PLP Multiple Tee

PART NO.	1 TUBE SIZE MM	2 TUBE SIZE (M)	H	L	N	MOUNTING HOLE DIA.
24PLP-6M-4M	6	4	24.5	74	11.5	4.2
24PLP-8M-4M	8	4	24.5	74	11.5	4.2
24PLP-8M-6M	8	6	24.5	74	11.5	4.2
24PLP-10M-6M	10	6	36.0	81	15.5	4.2
24PLP-10M-8M	10	8	36.0	81	15.5	4.2

[Click here for CADs, Product Specifications or to Configure Parts Online](#)

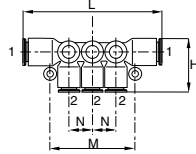

24PLPD Double Multiple Tee

PART NO.	1 TUBE SIZE IN	2 TUBE SIZE IN	H	L	M	N	MOUNTING HOLE DIA.
24PLPD-4-4M	1/4	5/32(4MM)	.73	2.84	1.69	.45	.17
24PLPD-4-4	1/4	1/4	.73	2.84	1.69	.45	.17
24PLPD-6-4	3/8	1/4	.91	3.31	2.05	.57	.17

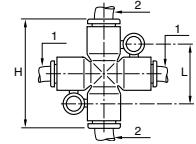

347PLP Unequal Cross

PART NO.	1 TUBE SIZE MM	2 TUBE SIZE MM	H	L	MOUNTING HOLE DIA.
347PLP-4M-6M	4	6	36	20.0	4.2
347PLP-6M-4M*	6	4	36	20.0	4.2
347PLP-6M-8M	6	8	46	22.5	4.2
347PLP-8M-6M*	8	6	46	22.5	4.2

*This model provides 3 outlines of "TUBE1" and 1 outlet of "TUBE 2".

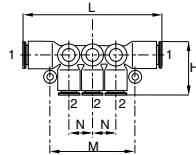

24PLPD Double Multiple Tee

PART NO.	1 TUBE SIZE MM	2 TUBE SIZE MM	H	L	M	N	MOUNTING HOLE DIA.
24PLPD-6M-4M	6	4	18.5	72.0	43.0	11.5	4.2
24PLPD-8M-4M	8	4	18.5	73.0	43.0	11.5	4.2
24PLPD-8M-6M	8	6	18.5	73.0	43.0	11.5	4.2
24PLPD-10M-6M	10	6	23.0	84.0	52.0	14.5	4.2
24PLPD-10M-8M	10	8	23.5	84.0	52.0	14.5	4.2

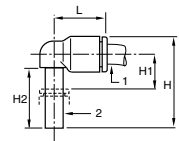

369PLPSP Plug-In Elbow

PART NO.	1 TUBE SIZE IN	2 TUBE SIZE IN	H	H1	H2	L
369PLPSP-2	1/8	1/8	.92	.31	.64	.57
369PLPSP-4M-4	5/32(4MM)	1/4	1.08	.30	.71	.71
369PLPSP-4	1/4	1/4	1.20	.43	.83	.73
369PLPSP-4-6	1/4	3/8	1.52	.35	.96	.98
369PLPSP-6	3/8	3/8	1.52	.35	.96	1.02
369PLPSP-8	1/2	1/2	2.00	.51	1.12	1.38

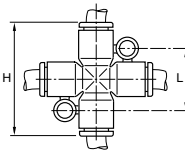

347PLP Equal Cross

PART NO.	TUBE SIZE IN	H	L	MOUNTING HOLE DIA.
347PLP-4	1/4	1.40	.79	.17

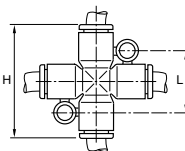

347PLP Equal Cross

PART NO.	TUBE SIZE MM	H	L	MOUNTING HOLE DIA.
347PLP-4M	4	36	20.0	4.2
347PLP-6M	6	36	20.0	4.2
347PLP-8M	8	46	22.5	4.2

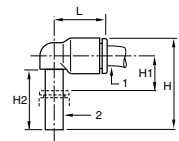

369PLPSP Plug-In Elbow

PART NO.	1 TUBE SIZE MM	2 TUBE SIZE MM	H	H1	H2	L
369PLPSP-4M	4	4	23.0	6.0	15.5	14.0
369PLPSP-6M	6	6	26.5	7.0	17.0	16.0
369PLPSP-8M	8	8	33.5	8.0	21.5	23.0
369PLPSP-10M	10	10	39.0	9.5	24.5	23.5
369PLPSP-12M	12	12	44.5	10.0	27.5	31.0
369PLPSP-4M-6M	4	6	26.5	7.0	17.0	16.0
369PLPSP-6M-4M	6	4	24.5	7.0	15.5	16.0
369PLPSP-6M-8M	6	8	33.5	8.0	21.5	22.0
369PLPSP-8M-10M	8	10	39.0	8.5	24.5	26.5
369PLPSP-10M-12M	10	12	44.5	10.0	27.5	31.0

[Click here for CADs, Product Specifications or to Configure Parts Online](#)



369PLPSPX Extended Plug-In Elbow

PART NO.	1 TUBE SIZE IN	2 TUBE SIZE IN	H	H1	H2	L
369PLPSPX-2	1/8	1/8	1.26	.65	.98	.57
369PLPSPX-4	1/4	1/4	1.56	.77	1.18	.71
369PLPSPX-6	3/8	3/8	2.19	1.02	1.63	1.02



372PLPSP Plug-In Branch Tee

PART NO.	1 TUBE SIZE IN	2 TUBE SIZE IN	H	H1	H2	L/2
372PLPSP-2	1/8	1/8	.95	.26	.59	.57
372PLPSP-4	1/4	1/4	.98	.43	.77	.73
372PLPSP-6	3/8	3/8	1.61	.35	.96	.98
372PLPSP-8	1/2	1/2	2.01	.51	1.12	1.38



369PLPSPX Extended Plug-In Elbow

PART NO.	1 TUBE SIZE MM	2 TUBE SIZE MM	H	H1	H2	L
369PLPSPX-4M	4	4	32.5	15.5	25.0	14.0
369PLPSPX-6M	6	6	38.5	19.0	29.0	16.0
369PLPSPX-8M	8	8	49.0	23.5	37.0	23.0
369PLPSPX-10M	10	10	56.0	26.5	41.5	26.5
369PLPSPX-12M	12	12	62.5	28.0	45.5	31.0
369PLPSPX-4M-6M	4	6	38.5	19.0	29.0	16.0
369PLPSPX-6M-8M	6	8	49.0	23.5	37.0	23.0
369PLPSPX-8M-10M	8	10	56.0	26.5	41.5	26.5
369PLPSPX-10M-12M	10	12	62.5	28.0	45.5	31.0

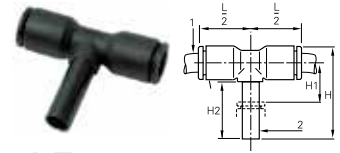

372PLPSP Plug-In Branch Tee

PART NO.	1 TUBE SIZE MM	2 TUBE SIZE MM	H	H1	H2	L/2
372PLPSP-4M	4	4	23.0	6.0	15.5	14.5
372PLPSP-6M	6	6	26.5	7.0	17.0	16.0
372PLPSP-8M	8	8	33.5	8.0	21.5	23.0
372PLPSP-10M	10	10	39.0	9.5	24.5	26.5
372PLPSP-12M	12	12	44.5	10.0	27.5	31.0
372PLPSP-4M-6M	4	6	26.5	7.0	17.0	16.0
372PLPSP-6M-8M	6	8	33.5	8.0	21.5	23.0
372PLPSP-8M-10M	8	10	39.0	9.5	24.5	26.5
372PLPSP-10M-12M	10	12	44.5	10.0	27.5	31.0

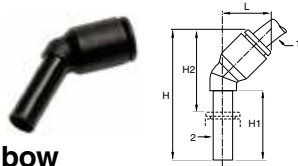

379PLPSP 45° Plug-In Elbow

PART NO.	1 TUBE SIZE IN	2 TUBE SIZE IN	H	H1	H2	L
379PLPSP-2	1/8	1/8	1.14	.59	.69	.47
379PLPSP-4	1/4	1/4	1.44	.71	.87	.57
379PLPSP-6	3/8	3/8	2.00	.96	1.16	.91

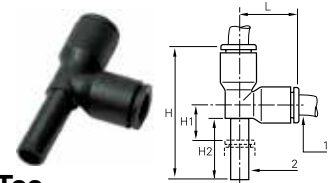

371PLPSP Plug-In Run Tee

PART NO.	1 TUBE SIZE IN	2 TUBE SIZE IN	H	H1	H2	L
371PLPSP-4	1/4	1/4	1.69	.43	.83	.73
371PLPSP-6	3/8	3/8	2.23	.33	.96	1.00
371PLPSP-8	1/2	1/2	2.86	.51	1.12	1.38

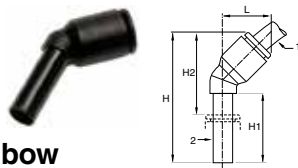

379PLPSP 45° Plug-In Elbow

PART NO.	1 TUBE SIZE MM	2 TUBE SIZE MM	H	H1	H2	L
379PLPSP-4M	4	4	33.5	19.0	21.0	13.0
379PLPSP-6M	6	6	39.0	21.0	25.0	14.5
379PLPSP-8M	8	8	44.0	21.5	25.5	19.5
379PLPSP-10M	10	10	53.0	27.0	32.5	23.0
379PLPSP-12M	12	12	58.5	27.5	34.0	26.5

[Click here for CADs, Product Specifications or to Configure Parts Online](#)

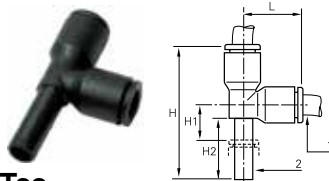

371PLPSP Plug-In Run Tee

PART NO.	1 TUBE SIZE MM	2 TUBE SIZE MM	H	H1	H2	L
371PLPSP-4M	4	4	33.0	6.0	15.5	14.5
371PLPSP-6M	6	6	38.5	7.0	17.0	17.5
371PLPSP-8M	8	8	49.0	8.0	21.5	23.0
371PLPSP-10M	10	10	57.0	10.5	24.5	26.5
371PLPSP-12M	12	12	65.5	10.5	27.5	31.0
371PLPSP-4M-6M	4	6	10.5	7.0	17.0	17.5
371PLPSP-6M-8M	6	8	13.5	8.0	21.5	23.0
371PLPSP-8M-10M	8	10	16.0	10.5	24.5	26.5
371PLPSP-10M-12M	10	12	19.0	10.5	27.5	31.0

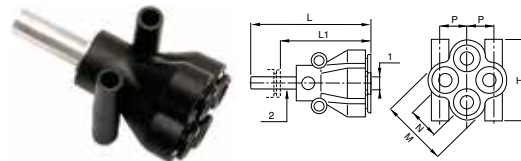

362PLPDSP Plug-In Multiple Y

PART NO.	1 TUBE SIZE MM	2 TUBE SIZE MM	H	L	L1	M	N
362PLPDSP-4M-6M	4	6	25.5	45.0	31.0	21.0	10.0
362PLPDSP-4M-8M	4	8	25.5	49.5	31.0	21.0	10.0
362PLPDSP-6M-8M	6	8	31.5	59.5	41.0	26.5	12.0

*Aluminum tail piece

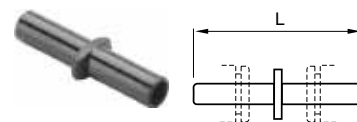

63PLP Double Male Union

PART NO.	TUBE SIZE IN	L
63PLP-4	1/4	1.52
63PLP-6	3/8	2.03

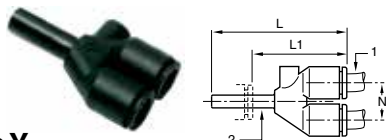

362PLPSP Plug-In Y

PART NO.	1 TUBE SIZE IN	2 TUBE SIZE IN	L	L1	N
362PLPSP-2	1/8	1/8	1.36	1.00	.35
362PLPSP-4	1/4	1/4	1.60	1.02	.45
362PLPSP-6	3/8	3/8	2.23	1.42	.67

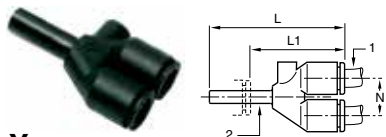

362PLPSP Plug-In Y

PART NO.	1 TUBE SIZE MM	2 TUBE SIZE MM	L	L1	N
362PLPSP-4M	4	4	34.0	21.5	9.0
362PLPSP-6M	6	6	39.5	25.5	11.0
362PLPSP-8M	8	8	50.5	32.0	14.5
362PLPSP-10M	10	10	57.5	36.0	17.0
362PLPSP-12M	12	12	66.0	41.0	20.0
362PLPSP-4M-6M	4	6	35.5	21.5	9.0
362PLPSP-6M-8M	6	8	44.0	25.5	11.0
362PLPSP-8M-10M	8	10	53.5	32.0	14.5
362PLPSP10M-12M	10	12	60.0	35.0	17.0

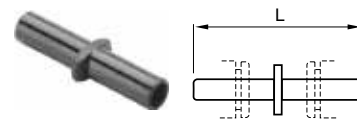

63PLP Double Male Union

PART NO.	TUBE SIZE MM	L
63PLP-4M	4	34 1/2
63PLP-6M	6	38 1/2
63PLP-8M	8	41
63PLP-10M	10	51 1/2
63PLP-12M	12	60
63PLP-14M	14	69 1/2

Click here for CADs, Product Specifications or to Configure Parts Online

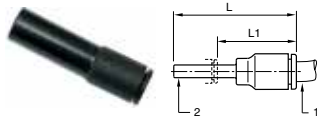

37PLP Tube Reducer

PART NO.	1 TUBE SIZE IN	2 TUBE SIZE IN	L	L1
37PLP-2-4M	1/8	5/32 (4M)	1.79	1.32
37PLP-2-3	1/8	3/16	1.79	1.14
37PLP-2-4	1/8	1/4	1.79	1.22
37PLP-4M-3	5/32 (4MM)	3/16	1.48	.83
37PLP-4M-4	5/32 (4MM)	1/4	1.48	.91
37PLP-4M-6	5/32 (4MM)	3/8	1.61	.81
37PLP-3-8M	3/16	5/16 (8M)	1.79	1.06
37PLP-3-4	3/16	1/4	1.79	1.22
37PLP-4-8M	1/4	5/16 (8M)	1.61	.89
37PLP-4-6	1/4	3/8	1.61	.81
37PLP-4-8	1/4	1/2	1.97	.98
37PLP-8M-6	5/16 (8MM)	3/8	1.93	1.12
37PLP-8M-8	5/16 (8MM)	1/2	2.01	1.02
37PLP-6-8	3/8	1/2	2.01	1.04

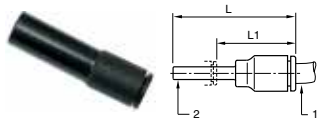

37PLP Tube Reducer

PART NO.	1 TUBE SIZE MM	2 TUBE SIZE MM	L	L1
37PLP-4M-6M	4	6	37.5	23.5
37PLP-4M-8M	4	8	37.5	19.0
37PLP-6M-8M	6	8	36.0	20.5
37PLP-4M-10M	4	10	44.0	22.5
37PLP-6M-10M	6	10	38.0	17.5
37PLP-8M-10M	8	10	49.0	28.5
37PLP-10M-12M	10	12	56.5	33.5
37PLP-6M-12M	6	12	46.0	23.0
37PLP-8M-12M	8	12	49.0	24.5
37PLP-10M-14M	10	14	58.5	33.5
37PLP-12M-14M	12	14	58.5	33.5
37PLP-6M-14M	6	14	48.0	23.0
37PLP-8M-14M	8	14	48.0	23.0

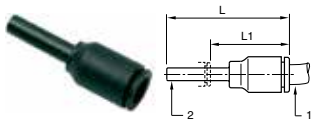

32PLPSP Tube Expander

PART NO.	1 TUBE SIZE IN	2 TUBE SIZE IN	L	L1
32PLPSP-4-2	1/4	1/8	1.61	1.16
32PLPSP-4-6M	1/4	6M	1.75	1.02
32PLPSP-4-4M	1/4	5/32 (4M)	1.61	1.14
32PLPSP-4-3	1/4	3/16	1.61	1.00
32PLPSP-6-4	3/8	1/4	1.58	1.00

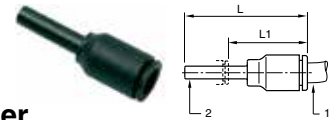

32PLPSP Tube Expander

PART NO.	1 TUBE SIZE MM	2 TUBE SIZE MM	L	L1
32PLPSP-6M-4M	6	4	35.0	23.0
32PLPSP-8M-6M	8	6	45.0	31.5
32PLPSP-10M-8M	10	8	42.5	21.0
32PLPSP-12M-10M	12	10	49.0	24.5

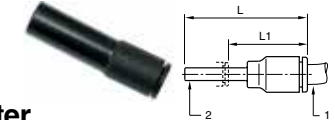

32PLPSP Tube Converter

PART NO.	1 TUBE SIZE MM	2 TUBE SIZE IN	L	L1
32PLPSP-4M-2	4M	1/8	1.61	1.16
32PLPSP-8M-4	8M	1/4	1.58	1.00



639PLP Plug Inch

PART NO.	TUBE SIZE	L
639PLP-2	1/8	1.30
639PLP-3	3/16	1.36
639PLP-4	1/4	1.44
639PLP-6	3/8	1.67
639PLP-8	1/2	1.91

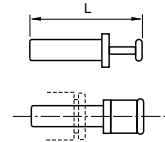

639PLP Plug Metric

PART NO.	TUBE SIZE	L
639PLP-3M	3	25
639PLP-4M	4	30
639PLP-6M	6	33
639PLP-8M	8	33
639PLP-10M	10	42
639PLP-12M	12	45
639PLP-14M	14	49
639PLP-16M*	16	57

* Nickel Plated Brass

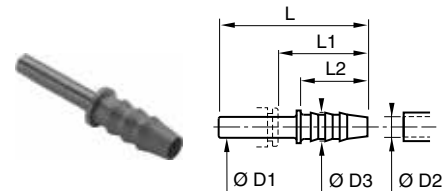

322PLPSP Barbed Connector

PART NO.	OD 1	OD 2	OD 3	L	L1	L2
322PLPSP-4M-2	5/32(4MM)	.120	.20	1.46	.98	.67
322PLPSP-4M-5M	5/32(4MM)	.200	.28	1.46	.98	.67
322PLPSP-4-3*	1/4	3/16		1.65	1.00	
322PLPSP-8M-4	5/16(8MM)	.250	.34	1.55	.83	.67
322PLPSP-8M-8M	5/16(8MM)	.320	.39	1.75	1.02	.87
322PLPSP-6-8M	3/8	.320	.39	1.97	1.16	.87
322PLPSP-8-6*	1/2	.375	.57	2.28	1.34	.87

*Nickel-plated brass. Dimensions for OD2 are I.D. of the tube.

[Click here for CADs, Product Specifications or to Configure Parts Online](#)

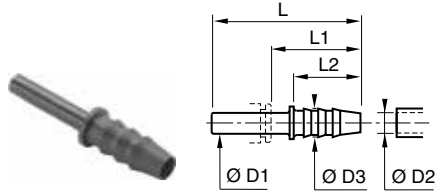

322PLPSP Barbed Connector

PART NO.	Ø D1	Ø D2	Ø D3	L	L1	L2
322PLPSP-4M-3M	4	3.2	5.0	37.0	25.0	17.0
322PLPSP-4M-5M	4	5.0	7.0	37.0	25.0	17.0
322PLPSP-6M-5M	6	5.0	7.0	39.0	25.0	17.0
322PLPSP-8M-6M	8	6.3	8.5	39.5	21.0	17.0
322PLPSP-8M-8M	8	8.0	10.0	44.5	26.0	22.0
322PLPSP-10M-6M	10	6.3	8.0	45.0	24.5	17.0
322PLPSP-10M-8M	10	8.0	10.0	50.0	29.5	22.0
322PLPSP-12M-8M	12	8.0	10.0	50.0	26.0	22.0
322PLPSP-12M-10M	12	10.0	12.0	48.5	25.5	22.5
322PLPSP-12M-12M	12	12.5	14.5	57.0	34.0	22.5
322PLPSP-14M-12M	14	12.5	14.5	59.5	34.5	22.5

*Nickel-plated brass. Dimensions for OD2 are I.D. of the tube.

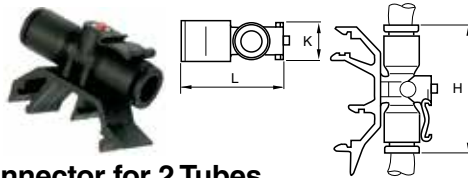

32PLPRC Connector for 2 Tubes

PART NO.	TUBE SIZE IN	H	K	L
32PLPRC-4	1/4	1.44	.47	1.18

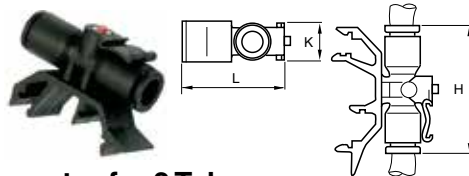

32PLPRC Connector for 2 Tubes

PART NO.	TUBE SIZE MM	H	K	L
32PLPRC-4M	4	36.5	11.0	39.5
32PLPRC-6M	6	36.5	11.0	39.5
32PLPRC-8M	8	46.0	13.0	44.5

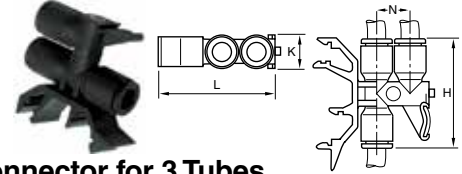

32PLPDRC Connector for 3 Tubes

PART NO.	TUBE SIZE MM	H	K	L	N
32PLPDRC-4M	4	36.5	11.0	39.5	
32PLPDRC-6M	6	36.5	11.0	39.5	
32PLPDRC-8M	8	46.0	13.0	14.5	



Clip Strips for Tubing and Fittings

PART NO.	D TUBE	LF3000 TO BE CLIPPED	H MM	K MM	N MM	NO. PER STRIP
CLIP 04 00	5/32, 4MM	-	9	13.5	10.5	8
CLIP 06 00	1/4, 3/16, 6MM	-	10.5	13	10.5	8
CLIP 08 00	5/16, 8MM	5/32, 4MM	12.5	10.5	12	7
CLIP 10 00	3/8, 10MM	1/4, 6MM	14	12	15	6
CLIP 12 00	1/2, 12MM		16.5	14	16.5	5
CLIP 14 00	14MM	5/16, 8MM	18	16	20.5	4

Clip strips come complete with screws of .375 inches in length.

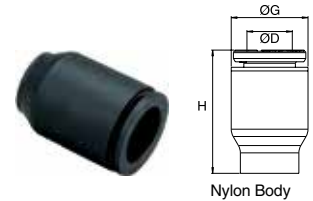

3151 End Caps

PART NO.	D IN	G MM	H MM
3151 53 00	1/8	.33	.55
3151 04 00	5/32	.33	.55
3151 56 00	1/4	.41	.64
3151 08 00	5/16	.53	.86
3151 60 00	3/8	.53	.86

3151 End Caps

PART NO.	D MM	G MM	H MM
3151 04 00	4	8.5	14.7
3151 06 00	6	10.5	16.9
3151 08 00	8	13.5	21.9
3151 10 00	10	16	22.2
3151 12 00	12	19	27.7

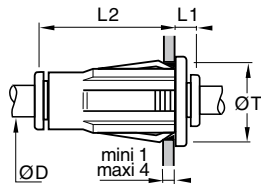

Minimum distance between fittings.
Diameter of fixing hole.

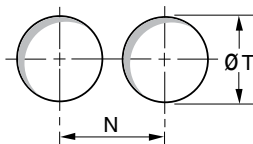

32PLPBHP Plug-in Bulkhead Union

PART NO.	TUBE SIZE IN	L1	L2	ØT
32PLPBHP-4	1/4	.26	1.240	.75
32PLPBHP-8M	5/16 (8MM)	.30	1.280	.87
32PLPBHP-6	3/8	.30	1.630	1.12

Fixing Hole

D	5/32	1/4	5/16	3/8	1/2	
T	inches	5/8"	3/4"	7/8"	1 1/8"	1 1/4"
	mm	15.87	19.05	22.22	28.57	31.75
N	in	.89	1.00	1.08	1.34	1.50

Tolerance T: +0.3 -0.1

Installation

1. Mark out the fixing hole
2. Make hole in panel
3. Simply push the fitting into place
4. To complete the installation
5. To identify circuits simply remove the black release button and replace with colored one

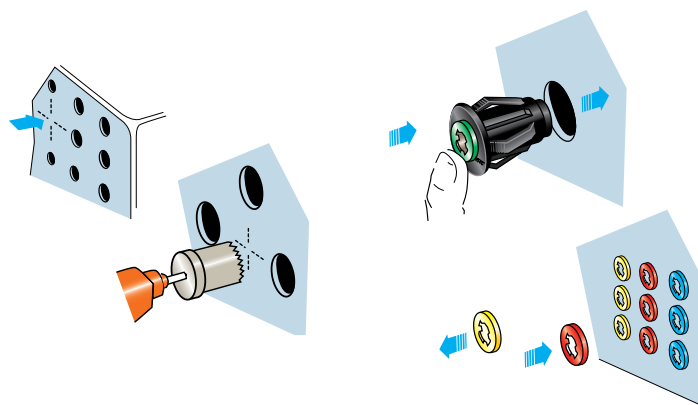

AQRT - Quick Release Tool

Makes disconnection of tube adapters and tubing a breeze.



3110 - 3330 Caps Manual Release Button - Inch

TUBE O.D.	WHITE PART NO.	BLACK PART NO.	GREEN PART NO.	RED PART NO.	BLUE PART NO.	YELLOW PART NO.
1/8	3110 53 00	-	3110 53 02	3110 53 03	3110 53 04	3110 53 05
5/32	3110 04 00	3330 04 01	3110 04 02	3110 04 03	3110 04 04	3110 04 05
3/16	3330 55 00	3330 55 01	3330 55 02	3330 55 03	3330 55 04	3330 55 05
1/4	3110 56 00	3330 56 01	3110 56 02	3110 56 03	3110 56 04	3110 56 05
5/16	3110 08 00	-	3110 08 02	3110 08 03	3110 08 04	3110 08 05
3/8	3110 60 00	-	-	-	3110 60 04	3110 60 05
1/2	3110 62 00	3330 62 01	3110 62 02	3110 62 03	3110 62 04	3110 62 05



3110 - 3330 Caps Manual Release Button - Metric

TUBE MM	WHITE PART NO.	BLACK PART NO.	GREEN PART NO.	RED PART NO.	BLUE PART NO.	YELLOW PART NO.
4	3110 04 00	3330 04 01	3110 04 02	3110 04 03	3110 04 04	3110 04 05
6	3110 06 00	3330 06 01	3110 06 02	3110 06 03	3110 06 04	3110 06 05
8	3110 08 00	-	3110 08 02	3110 08 03	3110 08 04	3110 08 05
10	3110 10 00	-	3110 10 02	3110 10 03	3110 10 04	3110 10 05
12	3110 12 00	-	3110 12 02	3110 12 03	3110 12 04	3110 12 05
14	3110 14 00	-	3110 14 02	3110 14 03	3110 14 04	3110 14 05

In all sizes of the LF3000 fittings, except 3/16, the push button is an integral part of the design which makes it non-removable, and comes standard in black. For identification of the circuits, colored caps (p/n 3110) fit over the black push button.

On the 3/16 sizes, the buttons are removable and can be replaced with a button of another color (p/n 3330).

Six colors are available which allow color coding of the fitting, in association with tubes of the same color.

Oscillating Elbows



Parker's oscillating fittings are designed to satisfy the requirements of industrial automation and robotics. The oscillating fitting features low-friction washers enabling the fitting to rotate in conjunction with the stroke of the cylinder piston.

Product Features:

- Glass reinforced nylon 6.6 body
- Nylon collar
- Stainless Steel gripping ring
- Nitrile D seal
- Nitrile o-ring
- Nickel-plated brass threads

Markets:

- Robotics
- Pneumatics
- Textile
- Packaging
- Semi-conductors

Applications:

- Air
- Cutting Fluids
- Inert Gases

Specifications:

Pressure Range Up to 290 PSI (19.9 bar)
depending on tubing

Temperature Range -4° to +175° F (-20° to +79.4° C)

Compatible Tubing:

- Semi-rigid nylon
- Polyurethane 95 Durometer Shore A
- Nylon
- Fluoropolymer

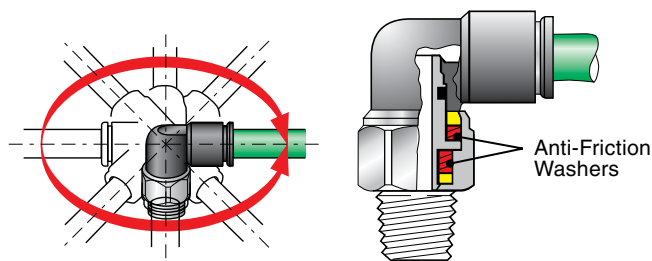

O.D. TUBE INCH & MM	5/32 & 4	1/4 & 6	8	10	12
"MAXIMUM ROTATION SPEED IN RADIAN/SECOND"	190	160	120	90	80

Assembly Instructions

1. Cut tubing squarely – maximum of 15° angle allowable.
2. Check that port or mating part is clean and free of debris.
3. Mark tubing to appropriate tube insertion length. (see Tube Insertion Chart on page N22)
4. Insert tubing until it bottoms
5. Pull on tubing to verify it is fully inserted
6. To disassemble, simply press release button, hold against body and pull tubing out of fitting.

⚠ WARNING These products can expose you to chemicals including LEAD which is known to the state of California to cause cancer.

Click here for CADs, Product Specifications or to Configure Parts Online

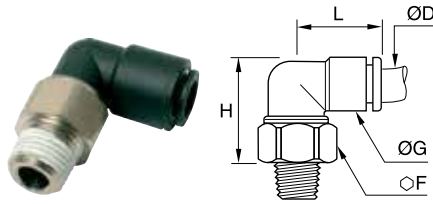

W369PLPO Oscillating Compact Elbow - NPT

PART NO.	TUBE SIZE IN	NPT	F	G	H	L
W369PLPO-4M-2	5/32(4MM)	1/8	12	.43	.85	.69
W369PLPO-4-2	1/4	1/8	14	.55	1.04	.81
W369PLPO-4-4	1/4	1/4	14	.55	1.04	.81

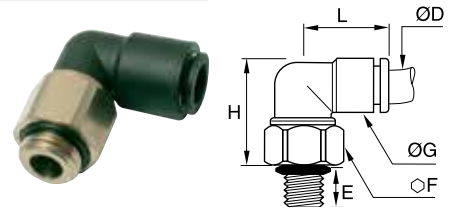

369PLPO Oscillating Compact Elbow - BSPP, M5

PART NO.	TUBE SIZE MM	M5/ BSPP	E	F	G	H	L
369PLPO-4M-M5	4	M5X0.8	3.0	12	11.0	24.5	17.5
369PLPO-4M-2G	4	1/8	5.0	13	11.0	23.0	17.5
369PLPO-6M-M5	6	M5X0.8	3.0	12	14.0	27.5	20.5
369PLPO-6M-2G	6	1/8	5.0	14	14.0	27.0	20.5
369PLPO-6M-4G	6	1/4	5.5	16	14.0	25.5	20.5
369PLPO-8M-2G	8	1/8	5.0	17	16.0	33.5	23.5
369PLPO-8M-4G	8	1/4	5.5	17	16.0	31.0	23.5
369PLPO-8M-6G	8	3/8	5.5	20	16.0	29.5	23.5
369PLPO-10M-4G	10	1/4	5.5	19	19.5	50.0	29.0
369PLPO-10M-6G	10	3/8	5.5	20	19.5	37.0	29.0
369PLPO-12M-4G	12	1/4	5.5	21	22.0	46.5	33.5
369PLPO-12M-6G	12	3/8	5.5	21	22.0	45.5	33.5

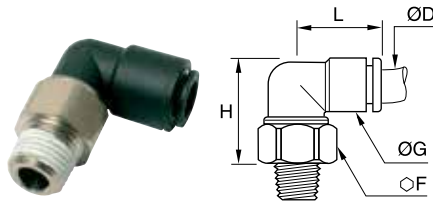

W369PLPO Oscillating Compact Elbow - BSPT

PART NO.	TUBE SIZE MM	BSPT	F	G	H	L
W369PLPO-4M-2R	4	1/8	12	11.0	22.0	17.5
W369PLPO-6M-2R	6	1/8	14	14.0	26.5	20.5
W369PLPO-6M-4R	6	1/4	14	14.0	23.5	20.5
W369PLPO-8M-2R	8	1/8	17	16.0	32.0	23.5
W369PLPO-8M-4R	8	1/4	17	16.0	29.0	23.5
W369PLPO-8M-6R	8	3/8	17	16.0	25.0	23.5
W369PLPO-10M-4R	10	1/4	19	19.5	37.5	29.0
W369PLPO-10M-6R	10	3/8	19	19.5	33.5	29.0
W369PLPO-12M-4R	12	1/4	21	22.0	44.5	33.5
W369PLPO-12M-6R	12	3/8	21	22.0	41.0	33.5

WARNING These products can expose you to chemicals including LEAD which is known to the state of California to cause cancer.



Prestolok PLM Metal Push-to-Connect Fittings

To meet your technical and environment requirements, Parker's Prestolok PLM fittings offers the robustness, reliability and resistance to industrial fluids for the most demanding environments.

Product Features:

- High phosphorous, FDA-compliant, chemical resistant, nickel-plated collet and body
- FKM seal
- Chemical, corrosion, and abrasion resistance
- NPT, BSPT, BSPP, and metric threads
- Silicone Free

Markets:

- Industrial
- Chemical
- Life Science
- Automation
- Food Processing

Applications:

- Food Fluids
- Harsh Detergents
- Cleaning In Cold/ Hot Water
- Steam
- Oils

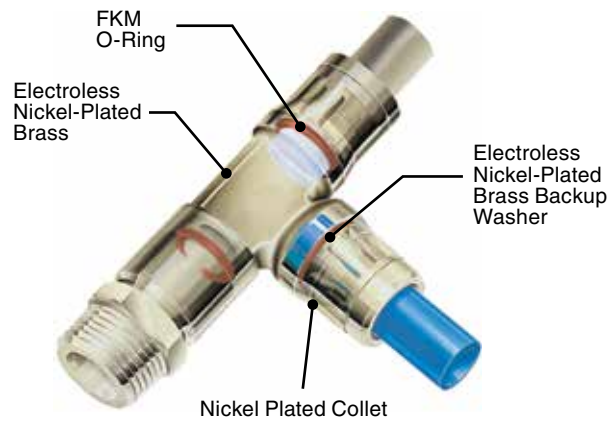

Specifications:

Pressure Range Vacuum to 435 psi (30 bar)
290 psi (19.9 bar) for 169PLM

Temperature Range -13° to +302° F (-25° to +150° C)

Note: Maximum pressure and temperature range depend on the type of tubing used.

Note: Maximum pressure and temperature range depend on the type of tubing used.

Compatible Tubing:

- Polyethylene
- Polyurethane 95 Durometer Shore A
- FEP
- Nylon

Assembly Instructions

1. Cut tubing squarely
maximum of 15° angle allowable.
2. Check that port or mating part is clean and free of debris.
3. Mark tubing to appropriate tube insertion length.
(see Tube Insertion Chart on page N22)
4. Insert tubing until it bottoms
5. Pull on tubing to verify it is fully inserted
6. To disassemble, simply press release button,
hold against body and pull tubing out of fitting.

⚠ WARNING These products can expose you to chemicals including LEAD which is known to the state of California to cause cancer.

■ Threaded Fittings

68PLM
Male Connector
NPT, BSPT
p. A39



68PLM
Male Connector
BSPP
p. A39



66PLM
Female Connector
BSPP
p. A39



68PLMSP
Male Standpipe
to BSPT
p. A40



68PLMSP
Male Standpipe
to BSPP
p. A40



169PLM
Male Elbow
NPT, BSPT
p. A40



169PLM
Male Elbow
BSPP
p. A41



169PLMX
Extended Male
Elbow – BSPT
p. A41



169PLMX
Extended Male
Elbow – BSPP
p. A41



171PLM
Male Run Tee
NPT, BSPT
p. A41, A42



171PLM
Male Run Tee
BSPP
p. A42



172PLM
Male Branch Tee
NPT, BSPT
p. A42



172PLM
Male Branch Tee
BSPP
p. A43



■ Tube to Tube Fittings

62PLM
Union
p. A43



165PLM
Union Elbow
p. A44



164PLM
Union Tee
p. A44



■ Bulkhead Unions

62PLMBH
Bulkhead Union
p. A43



66PLMBH
Female Bulkhead
p. A43



165PLMBH
Bulkhead Union
p. A44



■ Modular Fittings

169PLMBJ
Single Banjo
p. A45



■ Plug-In Fittings & Accessories

67PLM
Tube Reducer
p. A44



639PLM
Plug
p. A45



PLMC
Cartridge
p. A45



62PLMSP
Tube Expander
p. A45



62PLMSP
Tube Converter
p. A45



122PLMSP
Barbed Connector
p. A45



63PLM
Double Male Union
p. A45



⚠ WARNING These products can expose you to chemicals including LEAD which is known to the state of California to cause cancer.

[Click here for CADs, Product Specifications or to Configure Parts Online](#)

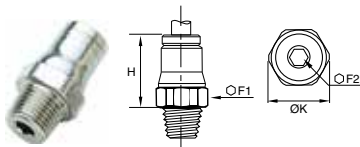

68PLM Male Connector Inch Tube to NPT/UNF

PART NO.	TUBE SIZE IN	NPT/UNF	F1 MM	F2 MM	H IN	K IN
68PLM-4M-0	5/32(4MM)	10-32	10	2.5	.61	.43
68PLM-4M-2	5/32(4MM)	1/8	11	3.0	.59	.47
68PLM-4M-4	5/32(4MM)	1/4	14	3.0	.59	.59
68PLM-4-0	1/4	10-32	13	2.5	.75	.55
68PLM-4-2	1/4	1/8	13	4.0	.67	.55
68PLM-4-4	1/4	1/4	14	4.0	.67	.59
68PLM-4-6	1/4	3/8	18	5.0	.67	.77
68PLM-6-2	3/8	1/8	18	4.0	.97	.77
68PLM-6-4	3/8	1/4	18	7.0	.95	.77
68PLM-6-6	3/8	3/8	18	8.0	.91	.77
68PLM-6-8	3/8	1/2	22	8.0	.95	.94
68PLM-8-6	1/2	3/8	22	9.0	.95	.94
68PLM-8-8	1/2	1/2	22	10.0	.95	.94

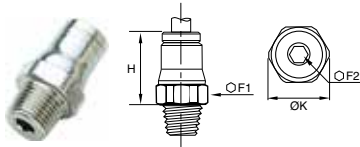

68PLM Male Connector Metric Tube to BSPT

PART NO.	TUBE SIZE MM	BSPT	F1 MM	F2 MM	H MM	K MM
68PLM-4M-2R	4	1/8	10	3	15.00	11.00
68PLM-4M-4R	4	1/4	14	3	15.00	15.00
68PLM-6M-2R	6	1/8	13	4	17.00	14.00
68PLM-6M-4R	6	1/4	14	4	17.00	15.00
68PLM-8M-2R	8	1/8	15	5	19.00	16.00
68PLM-8M-4R	8	1/4	15	6	18.00	16.00
68PLM-8M-6R	8	3/8	17	6	18.50	18.50
68PLM-10M-4R	10	1/4	18	7	23.00	19.50
68PLM-10M-6R	10	3/8	18	8	22.50	19.50
68PLM-10M-8R	10	1/2	22	8	22.50	24.00
68PLM-12M-4R	12	1/4	20	7	25.50	22.00
68PLM-12M-6R	12	3/8	20	9	24.00	22.00
68PLM-12M-8R	12	1/2	22	10	23.00	24.00
68PLM-14M-6R	14	3/8	22	9	27.00	24.00
68PLM-14M-8R	14	1/2	24	11	26.00	26.00

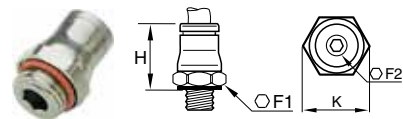

68PLM Male Connector Tube to UNF, BSPP or Metric

PART NO.	TUBE SIZE MM	BSPP/METRIC	F1 MM	F2 MM	H MM	K MM
68PLM-4M-M5	4	M5X0.8	10	2.50	15.50	11.00
68PLM-4M-M6	4	M6X1	13	3.00	14.50	14.00
68PLM-4M-2G	4	1/8	10	3.00	16.00	11.00
68PLM-4M-4G	4	1/4	16	3.00	14.50	17.50
68PLM-4M-M8	4	M8X1	11	3.00	14.50	12.00
68PLM-6M-M5	6	M5X0.8	13	2.50	19.00	14.00
68PLM-6M-2G	6	1/8	13	4.00	17.50	14.00
68PLM-6M-M10	6	M10X1	13	4.00	17.50	14.00
68PLM-6M-4G	6	1/4	16	4.00	17.00	17.50
68PLM-8M-2G	8	1/8	15	5.00	20.00	16.00
68PLM-8M-4G	8	1/4	16	6.00	18.00	17.50
68PLM-8M-6G	8	3/8	20	6.00	19.00	22.00
68PLM-10M-4G	10	1/4	18	7.00	25.00	19.50
68PLM-10M-6G	10	3/8	20	8.00	22.50	22.00
68PLM-10M-8G	10	1/2	24	8.00	22.50	26.00
68PLM-12M-4G	12	1/4	20	7.00	27.00	22.00
68PLM-12M-6G	12	3/8	20	9.00	26.00	22.00
68PLM-12M-8G	12	1/2	24	10.00	23.50	26.00
68PLM-14M-6G	14	3/8	22	9.00	28.00	24.00
68PLM-14M-8G	14	1/2	24	11.00	26.50	26.00

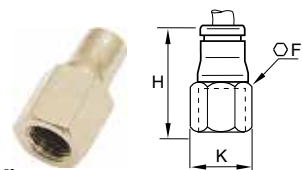

66PLM Female Connector Metric Tube to BSPP or M5

PART NO.	TUBE SIZE MM	BSPP/M5	F MM	H MM	K MM
66PLM-4M-M5	4	M5X0.8	10	22.00	11.00
66PLM-4M-2G	4	1/8	14	25.00	15.00
66PLM-4M-4G	4	1/4	17	29.00	18.50
66PLM-6M-2G	6	1/8	14	27.50	15.00
66PLM-6M-4G	6	1/4	17	31.50	18.50
66PLM-8M-2G	8	1/8	15	28.50	16.00
66PLM-8M-4G	8	1/4	17	32.50	18.50
66PLM-10M-6G	10	3/8	22	38.00	24.00
66PLM-12M-6G	12	3/8	22	39.00	24.00
66PLM-12M-8G	12	1/2	24	43.50	26.00

WARNING These products can expose you to chemicals including LEAD which is known to the state of California to cause cancer.

[Click here for CADs, Product Specifications or to Configure Parts Online](#)

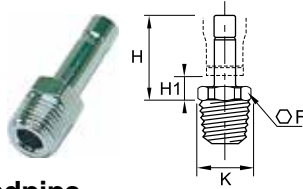

68PLMSP Male Stud Standpipe Metric Tube to BSPT

PART NO.	TUBE SIZE MM	BSPT	F MM	H MM	H1 MM	K MM
68PLMSP-4M-2R	4	1/8	10	21.00	7.00	11.00
68PLMSP-6M-2R	6	1/8	10	23.50	6.50	11.00
68PLMSP-6M-4R	6	1/4	10	23.50	6.50	15.00
68PLMSP-8M-2R	8	1/8	10	24.00	6.50	11.00
68PLMSP-8M-4R	8	1/4	14	24.00	6.50	15.00
68PLMSP-10M-4R	10	1/4	14	22.00	6.50	15.00
68PLMSP-10M-6R	10	3/8	17	30.00	7.50	18.50
68PLMSP-12M-6R	12	3/8	17	31.00	7.50	18.50
68PLMSP-12M-8R	12	1/2	22	38.00	7.50	24.00
68PLMSP-14M-8R	14	1/2	22	33.00	8.00	24.00

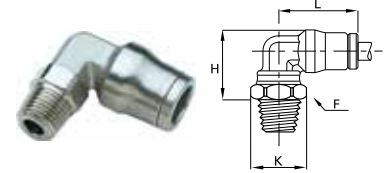

169PLM Male Elbow Inch Tube to NPT, UNF

PART NO.	TUBE SIZE IN	NPT/UNF	F MM	H IN	K IN	L IN
169PLM-4M-0	5/32(4MM)	10-32	10	0.71	0.43	.71
169PLM-4M-2	5/32(4MM)	1/8	11	.59	.47	.71
169PLM-4M-4	5/32(4MM)	1/4	14	.67	.60	.71
169PLM-4-2	1/4	1/8	11	.69	.47	.87
169PLM-4-4	1/4	1/4	14	.75	.60	.87
169PLM-4-6	1/4	3/8	18	.75	.77	.87
169PLM-6-4	3/8	1/4	15	.93	.63	1.14
169PLM-6-6	3/8	3/8	18	1.02	.77	1.14
169PLM-6-8	3/8	1/2	22	1.06	.94	1.14
169PLM-8-6	1/2	3/8	18	1.14	.77	1.22
169PLM-8-8	1/2	1/2	22	1.14	.94	1.22

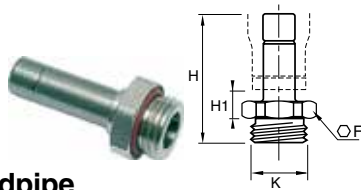

68PLMSP Male Standpipe Metric Tube to BSPP or M5

PART NO.	TUBE SIZE MM	BSPP/M5	F MM	H MM	H1 MM	K MM
68PLMSP-4M-M5	4	M5X0.8	13	25.50	7.00	14.00
68PLMSP-4M-2G	4	1/8	16	26.50	7.00	17.50
68PLMSP-4M-4G	4	1/4	8	25.00	7.50	8.70
68PLMSP-6M-2G	6	1/8	13	28.00	6.50	14.00
68PLMSP-6M-4G	6	1/4	16	29.00	6.50	17.50
68PLMSP-8M-2G	8	1/8	13	28.50	6.50	14.00
68PLMSP-8M-4G	8	1/4	16	29.50	6.50	17.50
68PLMSP-8M-6G	8	3/8	20	30.50	7.50	22.00
68PLMSP-10M-4G	10	1/4	16	34.50	6.50	17.50
68PLMSP-10M-6G	10	3/8	20	35.50	7.50	22.00
68PLMSP-10M-8G	10	1/2	24	37.00	7.50	26.00
68PLMSP-12M-6G	12	3/8	20	36.50	7.50	22.00
68PLMSP-12M-8G	12	1/2	24	38.00	7.50	26.00
68PLMSP-14M-8G	14	1/2	24	40.00	8.00	26.00

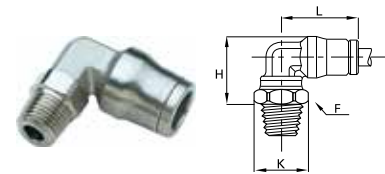

169PLM Male Elbow Metric Tube to BSPT

PART NO.	TUBE SIZE MM	BSPT	F MM	H MM	K MM	L MM
169PLM-4M-2R	4	1/8	11	15.00	12.00	18.00
169PLM-4M-4R	4	1/4	14	17.00	15.00	18.00
169PLM-6M-2R	6	1/8	11	17.50	12.00	21.50
169PLM-6M-4R	6	1/4	14	19.00	15.00	21.50
169PLM-8M-2R	8	1/8	11	19.50	12.00	23.50
169PLM-8M-4R	8	1/4	14	21.00	15.00	23.50
169PLM-8M-6R	8	3/8	17	21.00	18.50	23.50
169PLM-10M-4R	10	1/4	15	23.50	16.00	29.00
169PLM-10M-6R	10	3/8	17	25.50	18.50	29.00
169PLM-12M-4R	12	1/4	15	26.00	16.00	31.00
169PLM-12M-6R	12	3/8	17	28.50	18.50	31.00
169PLM-12M-8R	12	1/2	21	28.50	23.00	31.00
169PLM-14M-6R	14	3/8	19	29.00	21.00	34.00
169PLM-14M-8R	14	1/2	24	30.00	26.00	34.00

WARNING These products can expose you to chemicals including LEAD which is known to the state of California to cause cancer.

[Click here for CADs, Product Specifications or to Configure Parts Online](#)

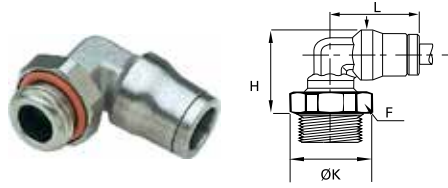

169PLM Male Elbow Tube to BSPP, Metric

PART NO.	TUBE SIZE MM	BSPP/METRIC	F MM	H MM	K MM	L MM
169PLM-4M-M5	4	M5X0.8	10	18.00	11.00	18.00
169PLM-4M-2G	4	1/8	13	17.00	14.00	18.00
169PLM-4M-M6	4	M6X1	10	18.00	11.00	18.00
169PLM-4M-4G	4	1/4	16	17.50	17.50	18.00
169PLM-4M-M8	4	M8X1	11	18.00	12.00	18.00
169PLM-6M-M5	6	M5X0.8	10	20	14	22
169PLM-6M-2G	6	1/8	13	19.00	14.00	21.50
169PLM-6M-M10	6	M10X1	13	19.00	14.00	21.50
169PLM-6M-4G	6	1/4	16	19.50	17.50	21.50
169PLM-8M-2G	8	1/8	13	20.50	14.00	23.50
169PLM-8M-4G	8	1/4	16	21.50	17.50	23.50
169PLM-8M-6G	8	3/8	20	21.50	22.00	23.50
169PLM-10M-4G	10	1/4	16	27.00	17.50	29.00
169PLM-10M-6G	10	3/8	20	25.50	22.00	29.00
169PLM-12M-4G	12	1/4	16	29.50	17.50	31.00
169PLM-12M-6G	12	3/8	20	28.50	22.00	31.00
169PLM-12M-8G	12	1/2	24	28.50	26.00	31.00
169PLM-14M-6G	14	3/8	20	29.00	22.00	34.00
169PLM-14M-8G	14	1/2	24	29.50	26.00	34.00



169PLMX Extended Male Elbow Metric Tube to BSPP or M5

PART NO.	TUBE SIZE MM	BSPP/M5	F MM	H MM	K MM	L MM
169PLMX-4M-M5	4	M5X0.8	10	27.50	11.00	18.00
169PLMX-4M-2G	4	1/8	13	25.50	14.00	18.00
169PLMX-6M-2G	6	1/8	13	31.00	14.00	18.00
169PLMX-6M-4G	6	1/4	16	30.50	17.50	21.50
169PLMX-8M-2G	8	1/8	14	33.50	15.00	23.50
169PLMX-8M-4G	8	1/4	16	34.00	17.50	23.50
169PLMX-10M-4G	10	1/4	18	42.00	19.50	29.00
169PLMX-10M-6G	10	3/8	20	41.00	22.00	29.00
169PLMX-12M-4G	12	1/4	20	47.00	22.00	31.00
169PLMX-12M-6G	12	3/8	20	46.00	22.00	31.00
169PLMX-14M-8G	14	1/2	24	49.00	26.00	34.00

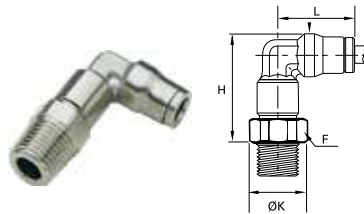

169PLMX Extended Male Elbow Metric Tube to BSPT

PART NO.	TUBE SIZE MM	BSPT	F MM	H MM	K MM	L MM
169PLMX-4M-2R	4	1/8	10	24.50	11.00	18.00
169PLMX-6M-2R	6	1/8	13	29.50	14.00	21.50
169PLMX-6M-4R	6	1/4	14	30.50	15.00	21.50
169PLMX-8M-2R	8	1/8	14	32.50	15.00	23.50
169PLMX-8M-4R	8	1/4	14	34.00	15.00	23.50
169PLMX-10M-4R	10	1/4	18	39.00	19.50	29.00

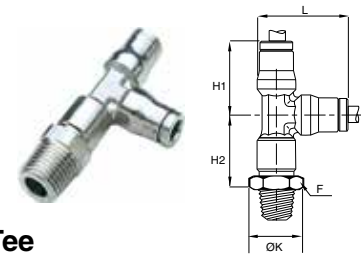

171PLM Male Run Tee Inch Tube to Tube to NPT, UNF

PART NO.	TUBE SIZE IN	NPT/UNF	F MM	H1 IN	H2 IN	K IN	L IN
171PLM-4M-2	5/32(4MM)	1/8	11	.71	.77	.47	.91
171PLM-4-4	1/4	1/4	14	.87	.97	.59	1.12
171PLM-6-4	3/8	1/4	18	1.14	1.20	.77	1.48
171PLM-6-6	3/8	3/8	18	1.14	1.28	.77	1.48
171PLM-6-8	3/8	1/2	22	1.14	1.28	.94	1.48
171PLM-8-6	1/2	3/8	22	1.22	1.46	.94	1.61

WARNING: These products can expose you to chemicals including LEAD which is known to the state of California to cause cancer.

[Click here for CADs, Product Specifications or to Configure Parts Online](#)

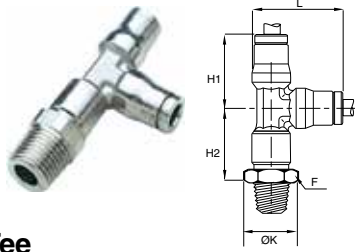

**171PLM Male Run Tee
Metric Tube to Tube to BSPT**

PART NO.	TUBE SIZE MM	BSPT	F MM	H1 MM	H2 MM	K MM	L MM
171PLM-4M-2R	4	1/8	10	18.00	19.50	11.00	23.00
171PLM-6M-2R	6	1/8	13	21.50	23.50	14.00	28.00
171PLM-6M-4R	6	1/4	14	21.50	24.50	15.00	28.00
171PLM-8M-2R	8	1/8	14	23.50	25.00	15.00	31.00
171PLM-8M-4R	8	1/4	14	23.50	26.50	15.00	31.00
171PLM-10M-4R	10	1/4	18	29.00	30.50	19.50	37.50
171PLM-10M-6R	10	3/8	18	29.00	32.50	19.50	37.50
171PLM-12M-6R	12	3/8	21	31.00	36.50	23.00	40.50
171PLM-14M-8R	14	1/2	22	34.00	40.00	24.00	45.00

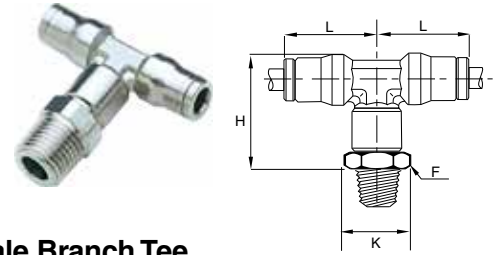

**172PLM Male Branch Tee
Inch Tube to NPT to Tube**

PART NO.	TUBE SIZE IN	NPT/UNF	F MM	H IN	K IN	L IN
172PLM-4M-0	5/32(4MM)	10-32	10.00	1.00	.47	.71

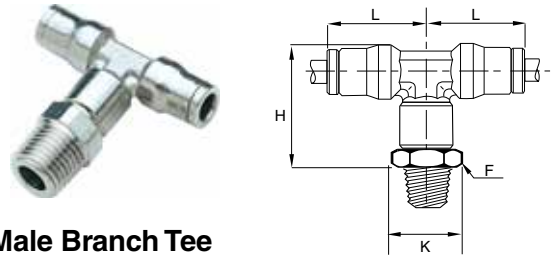

**172PLM Male Branch Tee
Metric Tube to BSPT**

PART NO.	TUBE SIZE MM	BSPT	F MM	H MM	K MM	L MM
172PLM-4M-2R	4	1/8	10	24.50	11.00	18.00
172PLM-6M-2R	6	1/8	13	29.50	14.00	21.50
172PLM-6M-4R	6	1/4	14	30.50	15.00	21.50
172PLM-8M-2R	8	1/8	14	32.50	15.00	23.50
172PLM-8M-4R	8	1/4	14	34.00	15.00	23.50
172PLM-10M-4R	10	1/4	18	39.00	19.50	29.00
172PLM-10M-6R	10	3/8	18	41.00	19.50	29.00
172PLM-12M-6R	12	3/8	21	46.50	23.00	31.00
172PLM-14M-8R	14	1/2	22	50.50	24.00	34.00

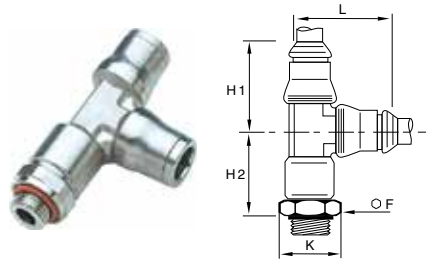

**171PLM Male Run Tee
Tube to Tube to BSPP or M5**

PART NO.	TUBE SIZE MM	BSPP/M5	F MM	H1 MM	H2 MM	K MM	L MM
171PLM-4M-M5	4	M5X0.8	10	18.00	22.50	11.00	23.00
171PLM-6M-2G	6	1/8	13	21.50	25.00	14.00	28.00
171PLM-6M-4G	6	1/4	16	21.50	24.50	17.50	28.00
171PLM-8M-2G	8	1/8	14	23.50	26.50	15.00	31.00
171PLM-8M-4G	8	1/4	16	23.50	26.50	17.50	31.00
171PLM-10M-4G	10	1/4	18	29.00	33.00	19.50	37.50
171PLM-12M-6G	12	3/8	21	31.00	36.50	23.00	40.50
171PLM-14M-8G	14	1/2	24	34.00	38.50	26.00	45.00

WARNING These products can expose you to chemicals including LEAD which is known to the state of California to cause cancer.

[Click here for CADs, Product Specifications or to Configure Parts Online](#)

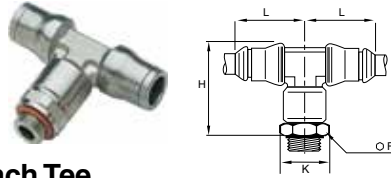

**172PLM Male Branch Tee
Tube to BSPP or M5**

PART NO.	TUBE SIZE MM	BSPP/M5	F MM	H MM	K MM	L MM
172PLM-4M-M5	4	M5X0.8	10	27.50	11.00	18.00
172PLM-4M-2G	4	1/8	13	25.50	14.00	18.00
172PLM-6M-2G	6	1/8	13	31.00	14.00	21.50
172PLM-6M-4G	6	1/4	16	30.50	17.50	21.50
172PLM-8M-2G	8	1/8	14	33.50	15.00	23.50
172PLM-8M-4G	8	1/4	16	34.00	17.50	23.50
172PLM-10M-4G	10	1/4	18	42.00	19.50	29.00
172PLM-12M-6G	12	3/8	21	46.00	23.00	31.00
172PLM-14M-8G	14	1/2	24	49.00	26.00	34.00

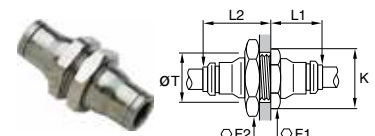

**62PLMBH Bulkhead Connector
Inch Tube to Tube**

PART NO.	TUBE SIZE IN	F1 MM	F2 MM	K IN	L1 IN	L2 IN	T IN
62PLMBH-4	1/4	16	17	.69	.67	.89	.59
62PLMBH-6	3/8	22	27	.95	.87	1.10	.85
62PLMBH-8	1/2	24	24	1.16	.89	1.14	1.04

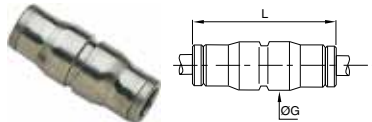

**62PLM Straight Union
Inch Tube to Tube**

PART NO.	TUBE SIZE IN	G IN	L IN
62PLM-4	1/4	.49	1.44
62PLM-6	3/8	.67	1.87
62PLM-8	1/2	.79	1.89

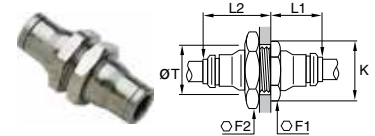

**62PLMBH Bulkhead Connector
Metric Tube to Tube**

PART NO.	TUBE SIZE MM	F1 MM	F2 MM	K MM	L1 MM	L2 MM	T MM
62PLMBH-4M	4MM(5/32)	13	14	14.00	14.00	20.00	12.50
62PLMBH-6M	6	16	17	17.50	17.00	22.00	15.00
62PLMBH-8M	8MM(5/16)	18	19	19.50	18.50	23.50	17.00
62PLMBH-10M	10	22	27	24.00	21.50	26.50	21.00
62PLMBH-12M	12	24	24	26.00	23.00	27.00	23.00
62PLMBH-14M	14	27	27	29.50	25.50	29.50	25.00

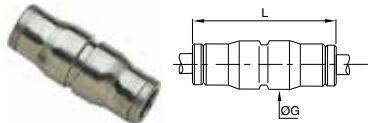

**62PLM Straight Union
Metric Tube to Tube**

PART NO.	TUBE SIZE MM	G MM	L MM
62PLM-4M	4MM(5/32)	10.00	30.50
62PLM-6M	6	12.00	36.50
62PLM-8M	8MM(5/16)	15.00	37.50
62PLM-10M	10	17.50	47.50
62PLM-12M	12	19.50	50.00
62PLM-14M	14	21.50	52.50

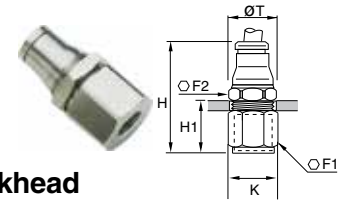

**66PLMBH Female Bulkhead
Connector Metric Tube to BSPP**

PART NO.	TUBE SIZE MM	BSPP	F1 MM	F2 MM	H MM	H1 MM	K MM	T MM
66PLMBH-4M-2G	4	1/8	14	14	30.50	11.00	15.00	13
66PLMBH-6M-2G	6	1/8	17	17	32.50	11.00	18.50	15
66PLMBH-6M-4G	6	1/4	17	17	37.00	15.00	18.50	15
66PLMBH-8M-2G	8	1/8	19	19	34.00	10.50	21.00	17
66PLMBH-8M-4G	8	1/4	19	19	38.00	14.50	21.00	17
66PLMBH-10M-6G	10	3/8	22	27	42.50	16.00	24.00	21
66PLMBH-12M-6G	12	3/8	24	24	43.00	16.00	26.00	23
66PLMBH-12M-8G	12	1/2	27	24	48.50	21.50	29.50	23

WARNING These products can expose you to chemicals including LEAD which is known to the state of California to cause cancer.

[Click here for CADs, Product Specifications or to Configure Parts Online](#)

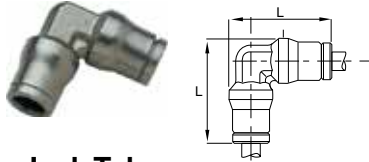

165PLM Union Elbow Inch Tube

PART NO.	TUBE SIZE IN	L IN
165PLM-4	1/4	1.12
165PLM-6	3/8	1.48
165PLM-8	1/2	1.61

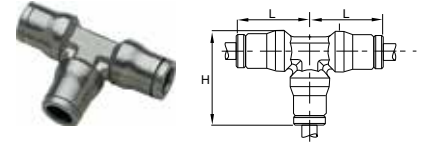

164PLM Union Tee Inch Tube

PART NO.	TUBE SIZE IN	H IN	L IN
164PLM-4	1/4	1.12	.87
164PLM-6	3/8	1.48	1.14
164PLM-8	1/2	1.61	1.22

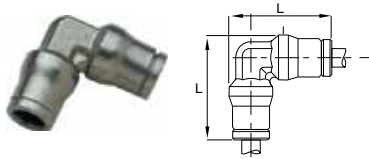

165PLM Union Elbow Metric Tube

PART NO.	TUBE SIZE MM	L MM
165PLM-4M	4MM(5/32)	23.00
165PLM-6M	6	28.00
165PLM-8M	8MM(5/16)	31.00
165PLM-10M	10	37.50
165PLM-12M	12	40.50
165PLM-14M	14	45.00

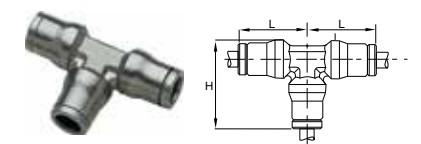

164PLM Union Tee Metric Tube

PART NO.	TUBE SIZE MM	H MM	L MM
164PLM-4M	4MM(5/32)	23.00	18.00
164PLM-6M	6	28.00	21.50
164PLM-8M	8MM(5/16)	31.00	23.50
164PLM-10M	10	37.50	29.00
164PLM-12M	12	40.50	31.00
164PLM-14M	14	45.00	34.00

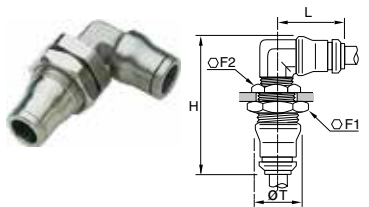

165PLMBH Bulkhead Elbow Metric Tube

PART NO.	TUBE SIZE MM	F1 MM	F2 MM	H MM	L MM	T MM
165PLMBH-4M	4	13	14	35.00	18.00	12.50
165PLMBH-6M	6	16	17	40.50	21.50	15.00
165PLMBH-8M	8	18	19	44.00	23.50	17.00
165PLMBH-10M	10	22	27	51.00	29.00	21.00
165PLMBH-12M	12	24	24	55.00	31.00	23.00
165PLMBH-14M	14	27	27	59.00	34.00	25.00

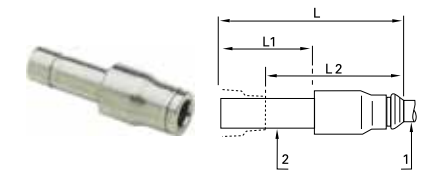

67PLM Plug-In Reducer Metric

PART NO.	TUBE 1 SIZE MM	TUBE 2 SIZE MM	L MM	L1 MM	L2 MM
67PLM-4M-6M	4	6	34.50	19.00	17.50
67PLM-4M-8M	4	8	35.50	20.00	18.00
67PLM-6M-8M	6	8	37.00	20.00	19.50
67PLM-6M-10M	6	10	43.50	25.00	21.00
67PLM-8M-10M	8	10	44.00	25.00	21.50
67PLM-8M-12M	8	12	45.00	26.00	21.50
67PLM-10M-12M	10	12	50.00	26.00	26.50
67PLM-12M-14M	12	14	53.00	28.00	28.50

WARNING These products can expose you to chemicals including LEAD which is known to the state of California to cause cancer.

[Click here for CADs, Product Specifications or to Configure Parts Online](#)

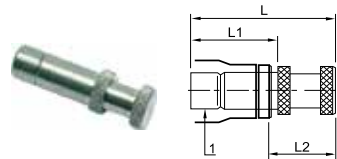

639PLM Plug Metric

PART NO.	TUBE 1 SIZE MM	L MM	L1 MM	L2 MM
639PLM-4M	4	25.50	17.00	11.50
639PLM-6M	6	30.50	19.50	13.50
639PLM-8M	8	33.00	20.00	16.00
639PLM-10M	10	40.00	25.00	18.00
639PLM-12M	12	43.00	26.00	20.00
639PLM-14M	14	47.00	28.00	22.50

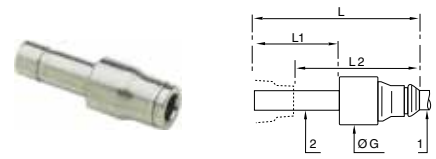

62PLMSP Plug-In Expander Metric

PART NO.	TUBE 1 SIZE MM	TUBE 2 SIZE MM	G MM	L MM	L1 MM	L2 MM
62PLMSP-4-6	6	4	17	42	22	28

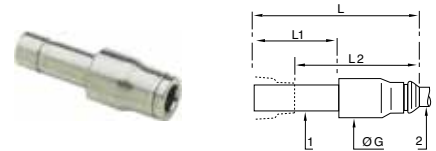

62PLMSP Plug-In Metric/Inch Adapter

PART NO.	TUBE 1 SIZE MM	TUBE 2 SIZE IN	G MM	L MM	L1 MM	L2 MM
62PLMSP-4-6M	6	1/4	12.50	38.00	19.00	20.50
62PLMSP-6-10M	10	3/8	17.00	49.50	25.00	27.00
62PLMSP-8-12M	12	1/2	20.00	51.00	26.00	27.50

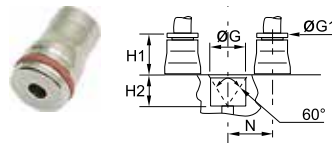

PLMC Cartridge

PART NO.	TUBE SIZE MM	G +.1 - 0	H1 MM	H2 MM	N MM
PLMC-4M	4	10.00	9.00	8.50	11.00
PLMC-6M	6	12.00	11.00	8.50	13.50
PLMC-8M	8	15.00	12.50	8.50	16.00
PLMC-10M	10	17.50	14.50	10.50	20.00
PLMC-12M	12	19.50	15.00	10.50	22.50
PLMC-14M	14	21.50	16.50	12.00	25.00

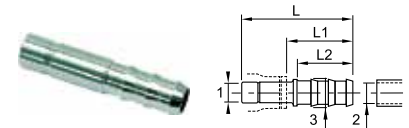

122PLMSP Plug-In Barbed Connector Metric

PART NO.	TUBE 1 SIZE MM	TUBE 2 SIZE MM	TUBE 3 SIZE MM	L MM	L1 MM	L2 MM
122PLMSP-4M-3M	4	3.20	5.00	40.50	27.00	22.50
122PLMSP-4M-5M	4	5.00	7.00	40.50	27.00	22.50
122PLMSP-6M-5M	6	5.00	7.00	43.00	27.00	22.50
122PLMSP-8M-6M	8	6.30	8.30	42.00	25.00	22.50
122PLMSP-8M-8M	8	8.00	10.00	44.00	27.00	22.50
122PLMSP-10M-6M	10	6.30	8.30	47.50	25.50	22.50
122PLMSP-10M-8M	10	8.00	10.00	47.50	25.50	22.50
122PLMSP-12M-8M	12	8.00	10.00	48.50	25.50	22.50
122PLMSP-12M10M	12	10.00	12.00	48.50	25.50	22.50
122PLMSP-12M12M	12	12.50	14.50	57.00	34.00	29.50
122PLMSP-14M12M	14	12.50	14.50	57.50	33.00	29.50
122PLMSP-14M14M	14	14.00	16.00	59.50	35.00	29.50

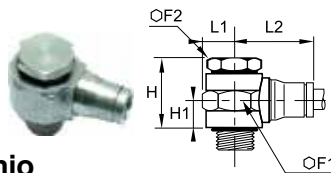

169PLMBJ Single Banjo Metric Tube to BSPP or M5

PART NO.	TUBE SIZE MM	BSPP/M5	F1 MM	F2 MM	H MM	H1 MM	L1 MM	L2 MM
169PLMBJ-4M-M5	4	M5X0.8	10	8	14.50	6.50	6.00	18.50
169PLMBJ-4M-2G	4	G1/8	17	14	23.00	9.50	10.00	20.50
169PLMBJ-6M-M5	6	M5X0.8	10	8	15.00	7.00	6.00	22.50
169PLMBJ-6M-2G	6	G1/8	17	14	23.00	9.50	10.00	23.50
169PLMBJ-6M-4G	6	G1/4	22	17	22.00	9.00	13.00	25.50
169PLMBJ-8M-2G	8	G1/8	17	14	23.00	9.50	10.00	26.00
169PLMBJ-8M-4G	8	G1/4	22	17	22.00	9.00	13.00	27.50
169PLMBJ-10M-6G	10	G3/8	22	22	33.00	14.00	13.00	32.00



63PLM Double Male Union Metric

PART NO.	TUBE SIZE MM	L MM	L1 MM
63PLM-4M	4	31.00	14.00
63PLM-6M	6	36.50	17.00
63PLM-8M	8	37.50	17.50
63PLM-10M	10	47.50	22.50
63PLM-12M	12	49.50	23.50
63PLM-14M	14	53.00	25.00

WARNING These products can expose you to chemicals including LEAD which is known to the state of California to cause cancer.



Prestolok PLS Stainless Steel Push-to-Connect Fittings

Parker's Prestolok PLS fittings are ideal for conveying corrosive fluids in aggressive environments. Prestolok PLS fittings provide corrosion resistance and a hygienic external design.

Product Features:

- Stainless steel 316L collet
- Stainless steel 316L body
- FKM seal
- Stainless steel 316L backup washer
- Chemical, corrosion, and abrasion resistance
- Hygienic design reduces retention zones for
- Easy cleaning
- NPT, BSPT, BSPP, and metric threads
- Silicone Free

Markets:

- Petrochemical
- Life Science
- Pulp and Paper
- Food Processing
- Wash Down

Applications:

- Food Fluids
- Chemicals
- Cleaning Agents

Specifications:

Pressure Range Vacuum to 435 psi (30 bar)
290 psi (19.9 bar) for 169PLS

Temperature Range -13° to +302° F (-25° to +150° C)

Vacuum Capability 28" Hg

Note: Maximum pressure and temperature range depend on the type of tubing used.

Compatible Tubing:

- Semi-rigid nylon
- Polyethylene
- Polyurethane 95 Durometer Shore A
- Stainless Steel (grooved)
- Copper (grooved)
- FEP

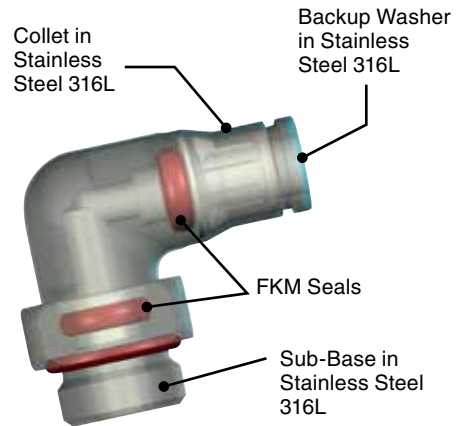

Assembly Instructions

1. Cut tubing squarely – maximum of 15° angle allowable.
2. Check that port or mating part is clean and free of debris.
3. Mark tubing to appropriate tube insertion length. (see Tube Insertion Chart on page N22)
4. Insert tubing until it bottoms
5. Pull on tubing to verify it is fully inserted
6. To disassemble, simply press release button, hold against body and pull tubing out of fitting.

■ Threaded Fittings

68PLS

Male Connector
NPT, BSPT
p. A48



68PLS

Male Connector
BSPP
p. A48



169PLS

Male Elbow
NPT, BSPT
p. A50



169PLS

Male Elbow
BSPP
p. A50



169PLSX

Extended Male
Elbow – NPT, BSPT
p. A51



169PLSX

Extended Male
Elbow – BSPP
p. A51



■ Tube to Tube Fittings

62PLS

Union
p. A51



165PLS

Union Elbow
p. A52



164PLS

Union Tee
p. A52



■ Bulkhead Union

62PLSBH

Bulkhead Union
p. A52



■ Standpipes

68PLSSP

Male Standpipe
NPT, BSPT
p. A49



68PLSSP

Male Standpipe
BSPP
p. A49



■ Plug-In Fittings & Accessories

67PLS

Tube Reducer
p. A53



639PLS

Plug
p. A53



PLSC

Cartridge
p. A53



[Click here for CADs, Product Specifications or to Configure Parts Online](#)

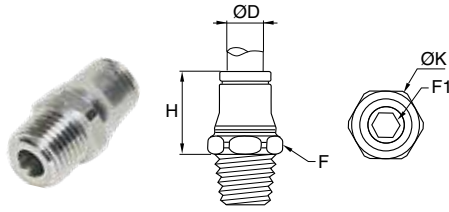

68PLS Male Connector - Inch Tube to NPT, UNF

PART NO.	TUBE SIZE IN	NPT / UNF	F MM	F1 MM	H IN	K IN
68PLS-4M-0	5/32(4MM)	10-32	10	2.5	.59	.43
68PLS-3-2	3/16	1/8	10	3	.61	.43
68PLS-4-2	1/4	1/8	13	4	.75	.55
68PLS-4-4	1/4	1/4	14	4	.69	.59
68PLS-6-4	3/8	1/4	19	6	.98	.83
68PLS-6-6	3/8	3/8	19	7	.94	.83
68PLS-8-4	1/2	1/4	22	7	1.02	.94
68PLS-8-6	1/2	3/8	22	8	.98	.94
68PLS-8-8	1/2	1/2	22	10	.98	.94

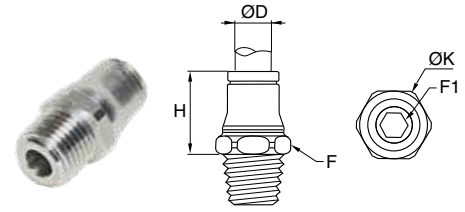

68PLS Male Connector - Metric Tube to BSPT

PART NO.	TUBE SIZE MM	BSPT	F MM	F1 MM	H MM	K MM
68PLS-4M-2R	4	1/8	10	3	14.50	11.00
68PLS-4M-4R	4	1/4	14	3	14.50	15.00
68PLS-6M-2R	6	1/8	13	4	18.00	14.00
68PLS-6M-4R	6	1/4	14	4	16.50	15.00
68PLS-8M-2R	8	1/8	15	5	20.50	16.50
68PLS-8M-4R	8	1/4	15	5	19.00	16.50
68PLS-8M-6R	8	3/8	17	6	19.00	18.50
68PLS-10M-4R	10	1/4	19	6	24.00	21.00
68PLS-10M-6R	10	3/8	19	7	22.50	21.00
68PLS-12M-4R	12	1/4	22	7	25.00	24.00
68PLS-12M-6R	12	3/8	22	8	24.00	24.00
68PLS-12M-8R	12	1/2	22	10	23.00	24.00

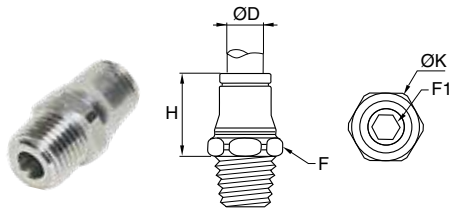

68PLS Male Connector - Metric Tube to NPT

PART NO.	TUBE SIZE MM	NPT	F MM	F1 MM	H MM	K MM
68PLS-4M-2	4MM(5/32)	1/8	11	3	14.50	12.00
68PLS-6M-2	6	1/8	13	4	18.00	14.00
68PLS-6M-4	6	1/4	14	4	16.50	15.00
68PLS-8M-2	8MM(5/16)	1/8	15	5	19.00	16.50
68PLS-8M-4	8MM(5/16)	1/4	15	6	18.00	16.50
68PLS-10M-4	10	1/4	19	6	24.00	21.00
68PLS-10M-6	10	3/8	19	7	22.50	21.00
68PLS-12M-4	12	1/4	22	7	25.00	24.00
68PLS-12M-6	12	3/8	22	8	24.00	24.00
68PLS-12M-8	12	1/2	22	10	23.00	24.00

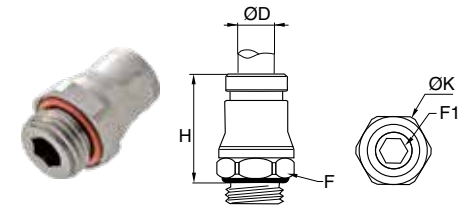

68PLS Male Connector - Metric Tube to BSPP, M5

PART NO.	TUBE SIZE MM	BSPP / M5	F MM	F1 MM	H MM	K MM
68PLS-4M-M5	4	M5X0.8	10	2.5	16.00	11.00
68PLS-4M-2G	4	1/8	13	3	15.00	14.00
68PLS-6M-M5	6	M5X0.8	13	2.5	20.50	14.00
68PLS-6M-2G	6	1/8	13	4	18.00	14.00
68PLS-6M-4G	6	1/4	17	4	18.00	18.50
68PLS-8M-2G	8	1/8	15	5	19.00	16.50
68PLS-8M-4G	8	1/4	17	5	20.50	18.50
68PLS-8M-6G	8	3/8	21	6	20.00	23.00
68PLS-10M-4G	10	1/4	18	7	25.00	19.50
68PLS-10M-6G	10	3/8	21	7	25.00	23.00
68PLS-12M-4G	12	1/4	21	7	27.00	23.00
68PLS-12M-6G	12	3/8	21	9	26.50	23.00

[Click here for CADs, Product Specifications or to Configure Parts Online](#)

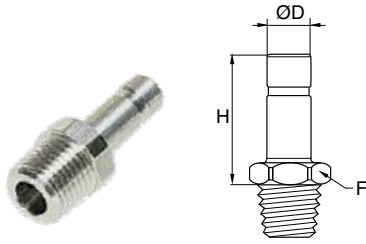

68PLSSP Male Standpipe - Inch Tube to NPT

PART NO.	TUBE SIZE IN	NPT	F IN	H IN
68PLSSP-4-2	1/4	1/8	0.39	1.02
68PLSSP-4-4	1/4	1/4	0.55	1.06
68PLSSP-6-4	3/8	1/4	0.75	1.26
68PLSSP-6-6	3/8	3/8	0.75	1.26
68PLSSP-8-4	1/2	1/4	0.75	1.42
68PLSSP-8-6	1/2	3/8	0.75	1.46
68PLSSP-8-8	1/2	1/2	0.87	1.46

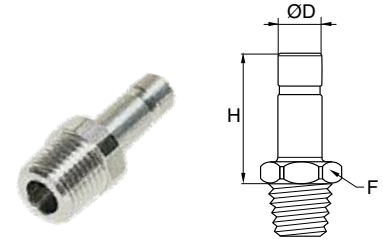

68PLSSP Male Standpipe - Metric Tube to BSPT

PART NO.	TUBE SIZE MM	BSPT	F MM	H MM
68PLSSP-4M-2R	4	1/8	10	21
68PLSSP-6M-2R	6	1/8	10	23
68PLSSP-6M-4R	6	1/4	14	24
68PLSSP-8M-2R	8	1/8	10	24
68PLSSP-8M-4R	8	1/4	14	25
68PLSSP-10M-4R	10	1/4	14	30
68PLSSP-10M-6R	10	3/8	17	30
68PLSSP-12M-4R	12	1/4	14	31
68PLSSP-12M-6R	12	3/8	17	31
68PLSSP-12M-8R	12	1/2	22	32

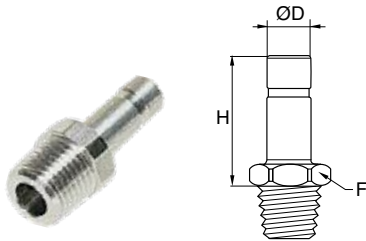

68PLSSP Male Standpipe - Metric Tube to NPT

PART NO.	TUBE SIZE MM	NPT	F MM	H MM
68PLSSP-4M-2	4MM(5/32)	1/8	11	21
68PLSSP-6M-2	6	1/8	11	23
68PLSSP-6M-4	6	1/4	14	24
68PLSSP-8M-2	8MM(5/16)	1/8	14	24
68PLSSP-8M-4	8MM(5/16)	1/4	14	25
68PLSSP-10M-4	10	1/4	14	30
68PLSSP-10M-6	10	3/8	17	30

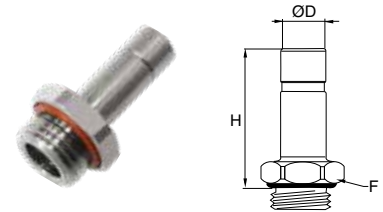

68PLSSP Male Standpipe - Metric Tube to BSPP, M5

PART NO.	TUBE SIZE MM	BSPP / M5	F MM	H MM
68PLSSP-4M-M5	4	M5X0.8	7	23.50
68PLSSP-4M-2G	4	1/8	13	22.00
68PLSSP-6M-2G	6	1/8	13	24.00
68PLSSP-6M-4G	6	1/4	17	24.00
68PLSSP-8M-2G	8	1/8	13	25.00
68PLSSP-8M-4G	8	1/4	17	27.00
68PLSSP-8M-6G	8	3/8	21	27.00
68PLSSP-10M-4G	10	1/4	17	32.00
68PLSSP-10M-6G	10	3/8	21	27.00
68PLSSP-12M-4G	12	1/4	17	33.00
68PLSSP-12M-6G	12	3/8	21	33.00

[Click here for CADs, Product Specifications or to Configure Parts Online](#)

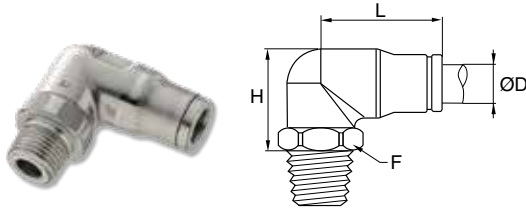

169PLS Male Elbow - Inch Tube to NPT, UNF

PART NO.	TUBE SIZE IN	NPT / UNF	F MM	H IN	L IN
169PLS-4M-0	5/32(4MM)	10-32	10	.98	.77
169PLS-4-2	1/4	1/8	13	.85	.91
169PLS-4-4	1/4	1/4	14	.85	.91
169PLS-6-4	3/8	1/4	17	1.12	1.20
169PLS-6-6	3/8	3/8	19	1.12	1.20
169PLS-8-4	1/2	1/4	22	1.34	1.30
169PLS-8-6	1/2	3/8	22	1.34	1.30
169PLS-8-8	1/2	1/2	22	1.34	1.30

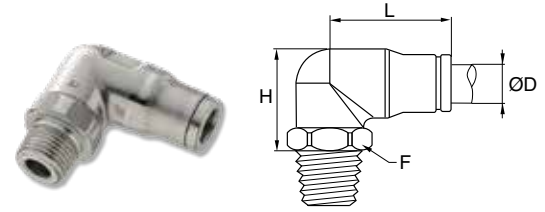

169PLS Male Elbow - Metric Tube to BSPT

PART NO.	TUBE SIZE MM	BSPT	F MM	H MM	L MM
169PLS-4M-2R	4	1/8	13	18.00	19.00
169PLS-4M-4R	4	1/4	14	18.00	19.00
169PLS-6M-2R	6	1/8	13	20.00	24.00
169PLS-6M-4R	6	1/4	14	20.00	23.00
169PLS-8M-2R	8	1/8	13	24.50	32.00
169PLS-8M-4R	8	1/4	14	23.50	24.00
169PLS-8M-6R	8	3/8	19	23.00	25.00
169PLS-10M-4R	10	1/4	17	27.00	31.00
169PLS-10M-6R	10	3/8	19	26.00	31.00
169PLS-12M-4R	12	1/4	22	31.50	33.00
169PLS-12M-6R	12	3/8	22	32.50	33.00
169PLS-12M-8R	12	1/2	22	27.50	33.00

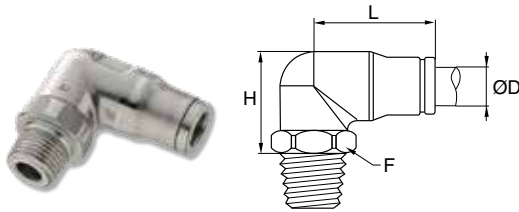

169PLS Male Elbow - Metric Tube to NPT

PART NO.	TUBE SIZE MM	NPT	F MM	H MM	L MM
169PLS-6M-2	6	1/8	13	20.00	22.50
169PLS-6M-4	6	1/4	14	20.00	22.50
169PLS-8M-2	8MM(5/16)	1/8	13	25.00	24.00
169PLS-8M-4	8MM(5/16)	1/4	14	24.00	24.00
169PLS-10M-4	10	1/4	17	27.50	27.50
169PLS-10M-6	10	3/8	19	28.50	26.50
169PLS-12M-4	12	1/4	22	31.50	32.50
169PLS-12M-6	12	3/8	22	32.50	32.50
169PLS-12M-8	12	1/2	22	27.50	32.50

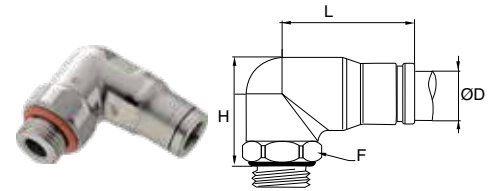

169PLS Male Elbow - Metric Tube to BSPP

PART NO.	TUBE SIZE MM	BSPP	F MM	H MM	L MM
169PLS-4M-2G	4	1/8	10	22	19
169PLS-4M-4G	4	1/4	17	20	19
169PLS-6M-2G	6	1/8	13	24	24
169PLS-6M-4G	6	1/4	17	22	24
169PLS-8M-2G	8	1/8	13	25	25
169PLS-8M-4G	8	1/4	17	25	25
169PLS-8M-6G	8	3/8	21	23	25
169PLS-10M-4G	10	1/4	18	29	31
169PLS-10M-6G	10	3/8	21	27	31
169PLS-12M-4G	12	1/4	17	33	33
169PLS-12M-6G	12	3/8	21	33	33
169PLS-12M-8G	12	1/2	24	30	33

[Click here for CADs, Product Specifications or to Configure Parts Online](#)

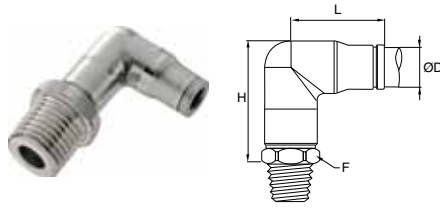

169PLSX Extended Male Elbow - Metric Tube to NPT

PART NO.	TUBE SIZE MM	NPT	F MM	H MM	L MM
169PLSX-6M-2	6	1/8	13	29	22.5
169PLSX-6M-4	6	1/4	14	29	22.5
169PLSX-8M-2	8	1/8	14	34	24
169PLSX-8M-4	8	1/4	14	34	24
169PLSX-10M-4	10	1/4	19	39.5	30
169PLSX-10M-6	10	3/8	19	39.5	30

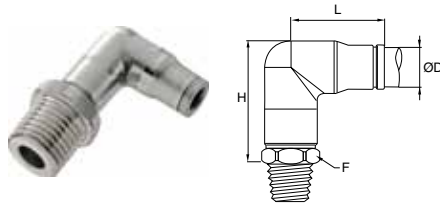

169PLSX Extended Male Elbow - Metric Tube to BSPT

PART NO.	TUBE SIZE MM	BSPT	F MM	H MM	L MM
169PLSX-4M-2R	4	1/8	10	25	19.00
169PLSX-6M-2R	6	1/8	13	30	24.00
169PLSX-6M-4R	6	1/4	14	30	24.00
169PLSX-8M-2R	8	1/8	14	34	24.90
169PLSX-8M-4R	8	1/4	14	34	24.90
169PLSX-10M-4R	10	1/4	19	39	31.00
169PLSX-10M-6R	10	3/8	19	39	31.00

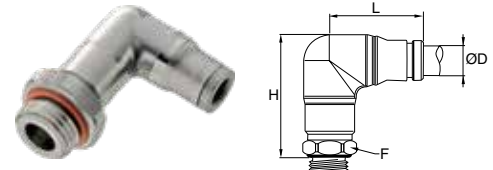

169PLSX Extended Male Elbow - Metric Tube to BSPP, M5

PART NO.	TUBE SIZE MM	BSPP / M5	F MM	H MM	L MM
169PLSX-4M-M5	4	M5X0.8	10	27.00	19
169PLSX-4M-2G	4	1/8	13	27.00	19
169PLSX-4M-4G	4	1/4	17	27.00	19
169PLSX-6M-M5	6	M5X0.8	13	33.00	24
169PLSX-6M-2G	6	1/8	13	33.00	24
169PLSX-6M-4G	6	1/4	17	32.00	24
169PLSX-8M-2G	8	1/8	14	35.00	25
169PLSX-8M-4G	8	1/4	17	35.00	25
169PLSX-8M-6G	8	3/8	21	34.50	25
169PLSX-10M-4G	10	1/4	18	43.00	31
169PLSX-10M-6G	10	3/8	21	42.00	31

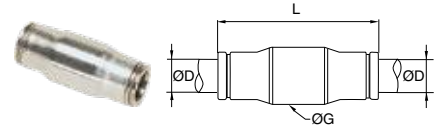

62PLS Union - Inch Tube

PART NO.	TUBE SIZE IN	G IN	H IN
62PLS-3	3/16	.39	1.18
62PLS-4	1/4	.47	1.38
62PLS-6	3/8	.69	1.81
62PLS-8	1/2	.79	1.89

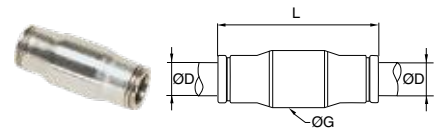

62PLS Union - Metric Tube

PART NO.	TUBE SIZE MM	G MM	H MM
62PLS-4M	4MM(5/32)	10.00	30.00
62PLS-6M	6	12.00	37.00
62PLS-8M	8MM(5/16)	15.00	38.00
62PLS-10M	10	17.00	49.00
62PLS-12M	12	19.50	49.50

[Click here for CADs, Product Specifications or to Configure Parts Online](#)

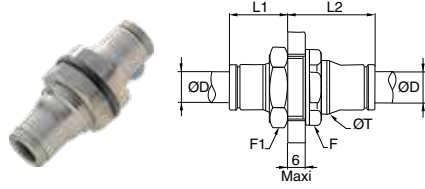

62PLSBH Bulkhead Union - Inch Tube

PART NO.	TUBE SIZE IN	F MM	F1 MM	L1 IN	L2 IN	T IN
62PLSBH-3	3/16	17	13	.59	.83	.49
62PLSBH-4	1/4	19	17	.67	.89	.59
62PLSBH-6	3/8	27	22	.87	1.08	.82
62PLSBH-8	1/2	27	27	.94	1.14	.98

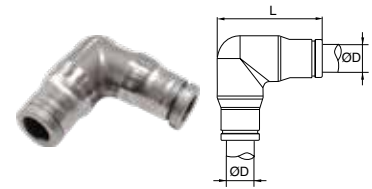

165PLS Union Elbow - Metric Tube

PART NO.	TUBE SIZE MM	L MM
165PLS-4M	4MM(5/32)	24.00
165PLS-6M	6	30.00
165PLS-8M	8MM(5/16)	32.20
165PLS-10M	10	39.00
165PLS-12M	12	43.00

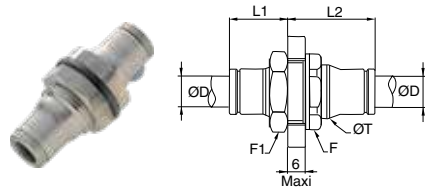

62PLSBH Bulkhead Union - Metric Tube

PART NO.	TUBE SIZE MM	F MM	F1 MM	L1 MM	L2 MM	T MM
62PLSBH-4M	4MM(5/32)	14	13	15	18	13
62PLSBH-6M	6	17	17	19	21	15
62PLSBH-8M	8MM(5/16)	19	19	20	22	17
62PLSBH-10M	10	22	22	24	26	21
62PLSBH-12M	12	24	24	25	26	23

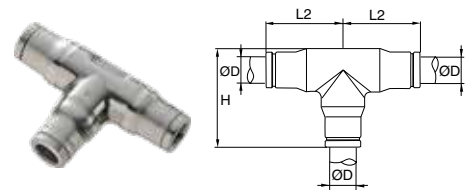

164PLS Union Tee - Inch Tube

PART NO.	TUBE SIZE IN	H IN	L2 IN
164PLS-4	1/4	1.06	.83
164PLS-6	3/8	1.48	1.12
164PLS-8	1/2	1.61	1.22

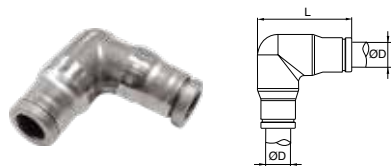

165PLS Union Elbow - Inch Tube

PART NO.	TUBE SIZE IN	L IN
165PLS-4	1/4	1.14
165PLS-6	3/8	1.56
165PLS-8	1/2	1.61

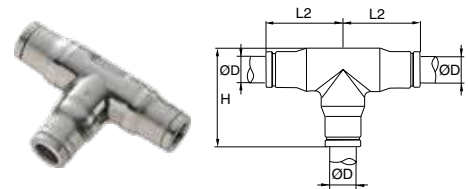

164PLS Union Tee - Metric Tube

PART NO.	TUBE SIZE MM	H MM	L2 MM
164PLS-4M	4MM(5/32)	24	19
164PLS-6M	6	30	24
164PLS-8M	8MM(5/16)	32	25
164PLS-10M	10	39	31
164PLS-12M	12	43	33

[Click here for CADs, Product Specifications or to Configure Parts Online](#)

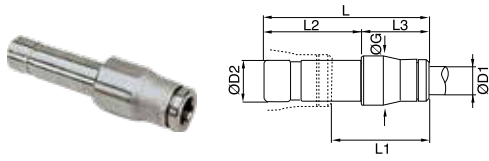

67PLS Tube Reducer - Metric

PART NO.	TUBE 1 SIZE MM	TUBE 2 SIZE MM	G MM	L MM	L1 MM	L2 MM	L3 MM
67PLS-4M-6M	4	6	10	35	19.0	19	16
67PLS-4M-8M	4	8	10	34	17.0	20	14
67PLS-6M-8M	6	8	12	42	24.0	23	19
67PLS-6M-10M	6	10	12	42	19.0	25	17
67PLS-8M-10M	8	10	15	45	22.5	25	19
67PLS-8M-12M	8	12	15	43	20.0	26	17
67PLS-10M-12M	10	12	17	51	23.0	26	25

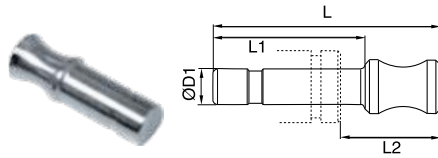

639PLS Plug - Metric

PART NO.	TUBE 1 SIZE MM	L MM	L1 MM	L2 MM
639PLS-4M	4	25.40	17.00	11.10
639PLS-6M	6	30.40	19.50	13.50
639PLS-8M	8	33.00	20.00	14.40
639PLS-10M	10	40.00	25.00	17.00
639PLS-12M	12	43.00	26.00	18.70

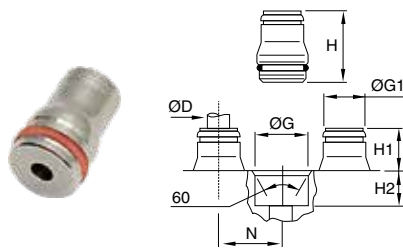

PLSC Cartridge - Metric

PART NO.	TUBE SIZE MM	G +.1 - 0 MM	G1 MM	H MM	H1 MM	H2 MM	N MM
PLSC-4M	4	9.80	8	18.00	9.50	8.50	11.00
PLSC-6M	6	12.10	10	20.00	11.50	8.50	13.50
PLSC-8M	8	14.80	13	22.00	13.50	8.50	16.00
PLSC-10M	10	17.50	15	25.50	15.00	10.50	20.00



Pneumatic: Integrated Fittings

Compact Flow Controls

Miniature Flow Controls

Swivel Outlet Flow Controls

Plug-In Flow Controls

In-Line Flow Controls

Metal Flow Controls

Stainless Steel
Flow Controls

In-Line Check Valves

Stainless Steel Check Valves

Piloted Operated Check Valves

Pneumatic Slide Valves

Quick Exhaust Valve

Blocking Valves

Threshold Sensor Fittings

Mini Ball Valves



GOODYEAR
RUBBER PRODUCTS, INC.

+1.727.342.5087

También puede enviarnos un correo electrónico a
ventas@goodyearrubberproducts.com

■ Compact Flow Controls

FCC731

Meter Out
BSPT, BSPP
p. B8



FCCI731

Meter In
BSPT, BSPP
p. B8



FCCB731

Bi-Directional
BSPT, BSPP
p. B9



FCKC731

Meter Out
Knobless
BSPP
p. B9



FCKCI731

Meter In Knobless
BSPP
p. B10



FCKCB731

Bi-Directional
Knobless
BSPP
p. B10



FCK701C

Knobless
Compression Metal
BSPP
p. B10



FCCS731

Meter Out
BSPP
p. B15



FCMS731

Meter Out Miniature
BSPP
p. B15



FCMSI731

Meter In Miniature
BSPP
p. B16



FCCS731

Meter Out
BSPP
p. B16



■ Miniature Flow Controls

FCM731

Meter Out
BSPT, BSPP
p. B12



FCMI731

Meter In
BSPT, BSPP
p. B12, B13



FCMB731

Bi-Directional
BSPP
p. B13



FCMK731

Meter Out
Knobless
p. B13



■ Plug-In Flow Controls

FCMSP731

Meter Out
Miniature
p. B18



FCMSPI731

Meter In
Miniature
p. B18



FCMSPI731

Meter In
Miniature
p. B18



FCCSP731

Meter Out
Compact
p. B18



FCCSPI731

Meter In
Compact
p. B18



■ In-Line Flow Controls

FC832

In-Line
p. B20



FCB832

Bi-Directional
p. B20



FCPM832

Panel Mountable
p. B21



FC836

Threaded In-Line
BSPP
p. B21



■ Metal Flow Controls

FC705

Meter Out
p. B23



FC701

Meter Out
BSPP
p. B23



FCI701

Meter In
BSPP
p. B23



FC708

Meter Out
p. B23



FC702

Meter Out
BSPP
p. B23



FCI702

Meter In
BSPP
p. B23



⚠ WARNING These products can expose you to chemicals including NICKEL or LEAD, which are known to the state of California to cause cancer and LEAD.

■ **Stainless Steel Flow Controls**

7810
Meter Out
BSPP
p. B25



7812
Bi-Directional
BSPP
p. B25



7810, 7815
Meter Out
NPT
p. B25



7812, 7817
Bi-Directional NPT
p. B25



7835
Meter Out NPT
p. B25



■ **Check Valves**

32PLCK
In-Line
p. B27



W68PLCK
Meter Out
BSPT
p. B27



W68PLCKI
Meter In
BSPT
p. B27



68PLCK
Meter Out
BSPP
p. B28



68PLCKI
Meter In
BSPP
p. B28



VC
Check Valve
p. B28



■ **Stainless Steel Check Valves**

4890
Unidirectional
BSPP
p. B30



4895
Unidirectional
NPT
p. B30



4891
Male x Female
BSPP
p. B30



4892
Female x Male
BSPP
p. B30



■ **Pilot Operated Check Valves**

7892
BSPP
p. B32



7894
Regulator &
Exhaust BSPP
p. B32



■ **Pneumatic Slide Valves**

0660
Female NPT
p. B34



0661
Male x Female
NPT
p. B34



0669
Female BSPP
p. B34



■ **Manually Operated 3-Way Venting Valves**

7805/7806
p. B39



7800/7801
p. B39



⚠ **WARNING** These products can expose you to chemicals including NICKEL or LEAD, which are known to the state of California to cause cancer and LEAD.

■ Quick Exhaust

7970
BSPP
p. B35



7982
NPT
p. B35



■ Blocking Valves

FC601
Lock Out
BSPT, BSPP
p. B37



FC602
Lock Out
p. B37



FC608
Lock Out
BSPT, BSPP
p. B37



■ Threshold Sensor

PSBJ731
Pneumatic
5/32 Pilot
p. B41



PSBJ731
Pneumatic
4mm Pilot
p. B41



PSPJ731
Pneumatic
10-32 Pilot
p. B41



PSBJ708
Pneumatic
M5 Pilot
p. B41



PSPE731
Pneumatic /
Electric
BSPP
p. B41



■ Mini Ball Valve

MVV309
Push-to-
Connect Ports
p. B43



MV308
Male BSPP
p. B43



MV309
Push-to-Connect
Ports, Vented
p. B43



MVV308
Male BSPP, Vented
p. B43



MVV308
Male NPT, Vented
p. B43



⚠ WARNING These products can expose you to chemicals including NICKEL or LEAD, which are known to the state of California to cause cancer and LEAD.

Compact Flow Controls



Parker's compact flow controls ensure excellent performance of flow and are perfectly suited for reduced spaces due to their small size.

Product Features:

- Glass reinforced nylon 6.6 body
- Stainless steel gripping ring
- Nickel-plated brass adjustment screw
- Nickel-plated brass locking nut
- Nickel-plated brass threads
- Nitrile D seal
- NPT
- BSPT
- BSPP
- Metric threads

Markets:

- Factory/Process Automation
- Life Science
- Food Processing
- Water And Beverage
- Petrochemical

Applications:

- Packaging
- Filling
- Dispensing
- Bottling
- Pneumatic Circuits

Specifications:

Pressure Range 15 to 145 psi (1.0 to 9.9 bar)

Temperature Range +32° to +158° F (0 to +70° C)

Compatible Tubing:

- Semi-rigid nylon
- Polyurethane 95 Durometer Shore A
- Nylon
- Fluoropolymer

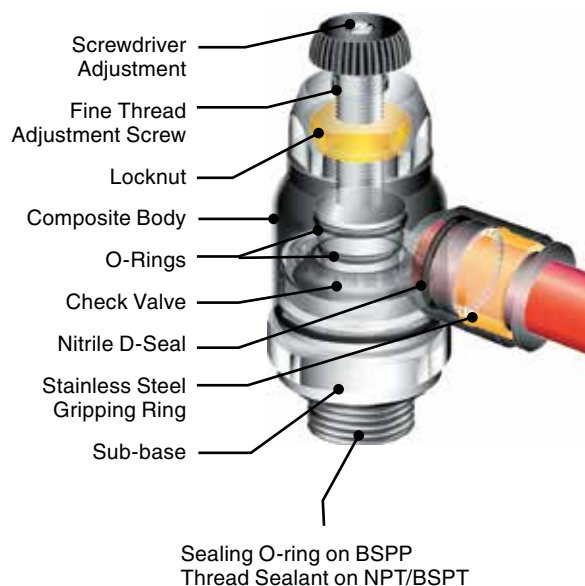

Assembly Instructions

1. Cut tubing squarely – maximum of 15° angle allowable.
2. Check that port or mating part is clean and free of debris.
3. Mark tubing to appropriate tube insertion length. (see Tube Insertion Chart on page N22)
4. Insert tubing until it bottoms
5. Pull on tubing to verify it is fully inserted
6. To disassemble, simply press release button, hold against body and pull tubing out of fitting.

⚠ WARNING These products can expose you to chemicals including NICKEL or LEAD, which are known to the state of California to cause cancer, and LEAD.

[Click here for CADs, Product Specifications or to Configure Parts Online](#)

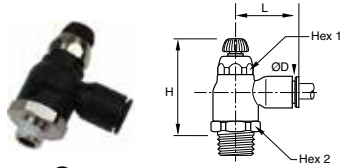

FCC731 Compact Meter Out

PART NO.	TUBE SIZE IN	NPT	HEX 1	HEX 2	H OPEN	H CLOSED	L
FCC731-4M-2	5/32(4MM)	1/8	.63	.39	1.67	1.44	.85
FCC731-4M-4	5/32(4MM)	1/4	.63	.39	1.67	1.44	.85
FCC731-4-2	1/4	1/8	.63	.39	1.67	1.44	.85
FCC731-4-4	1/4	1/4	.63	.39	1.67	1.44	.85
FCC731-6-4	3/8	1/4	.91	.67	2.03	1.71	1.22
FCC731-6-6	3/8	3/8	.91	.67	2.03	1.71	1.22
FCC731-6-8	3/8	1/2	.67	.91	2.03	1.71	1.22
FCC731-8-8	1/2	1/2	.67	.91	2.03	1.71	1.22

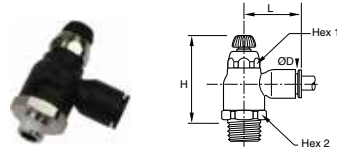

FCC731 Compact Meter Out - BSPT

PART NO.	TUBE SIZE MM	BSPT	HEX 1	HEX 2	H CLOSED	H OPEN	L
FCC731-6M-2R	6	1/8	16	10	36.5	42.5	22.0
FCC731-8M-2R	8	1/8	19	14	40.0	45.0	27.0
FCC731-8M-4R	8	1/4	19	14	40.0	45.0	27.0
FCC731-10M-4R	10	1/4	23	17	43.5	51.5	31.5
FCC731-10M-6R	10	3/8	23	17	43.5	51.5	31.5
FCC731-10M-8R	10	1/2	23	17	43.5	51.5	31.5
FCC731-12M-4R	12	1/4	23	17	43.5	51.5	35.0
FCC731-12M-6R	12	3/8	23	17	43.5	51.5	35.0
FCC731-12M-8R	12	1/2	23	17	43.5	51.5	35.0

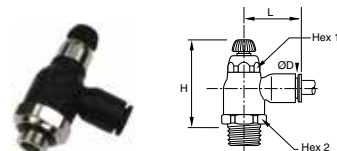

FCC731 Compact Meter Out - BSPP

PART NO.	TUBE SIZE MM	BSPP	HEX 1	HEX 2	H CLOSED	H OPEN	L
FCC731-4M-2G	4	1/8	10	16	38.0	44.0	22.0
FCC731-6M-2G	6	1/8	10	16	38.0	44.0	22.0
FCC731-6M-4G	6	1/4	10	16	36.5	42.5	22.0
FCC731-8M-2G	8	1/8	14	19	41.5	48.0	28.0
FCC731-8M-4G	8	1/4	14	19	41.5	48.0	28.0
FCC731-8M-6G	8	3/8	14	19	41.5	48.0	28.0
FCC731-10M-4G	10	1/4	17	23	45.5	53.5	31.5
FCC731-10M-6G	10	3/8	17	23	45.5	54.0	31.5
FCC731-12M-6G	12	3/8	17	23	45.5	54.0	35.0
FCC731-12M-8G	12	1/2	17	24	45.5	54.0	35.0

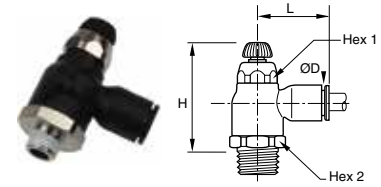

FCCI731 Compact Meter In Flow Control

PART NO.	TUBE SIZE IN	NPT	HEX 1	HEX 2	H OPEN	H CLOSED	L
FCCI731-4M-2	5/32(4MM)	1/8	.63	.39	1.67	1.44	.85
FCCI731-4M-4	5/32(4MM)	1/4	.63	.39	1.67	1.44	.85
FCCI731-4-2	1/4	1/8	.63	.39	1.67	1.44	.85
FCCI731-4-4	1/4	1/4	.63	.39	1.67	1.44	.85

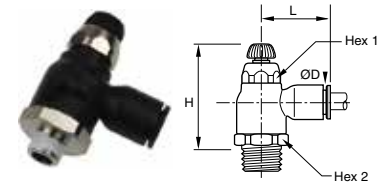

FCCI731 Compact Meter In Flow Control - BSPT

PART NO.	TUBE SIZE MM	BSPT	HEX 1	HEX 2	H CLOSED	H OPEN	L
FCCI731-10M-4R	10	1/4	23	17	43.5	51.5	31.5
FCCI731-10M-8R	10	1/2	23	17	43.5	51.5	31.5

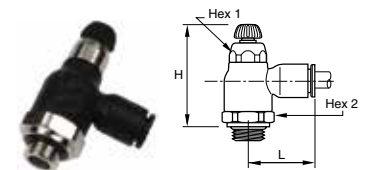

FCCI731 Compact Meter In Flow Control - BSPP

PART NO.	TUBE SIZE MM	BSPP	HEX 1	HEX 2	H CLOSED	H OPEN	L
FCCI731-4M-2G	4	1/8	10	16	38.0	44.0	22.0
FCCI731-6M-2G	6	1/8	10	16	38.0	44.0	22.0
FCCI731-6M-4G	6	1/4	10	16	36.5	42.5	22.0
FCCI731-8M-2G	8	1/8	14	19	41.5	48.0	28.0
FCCI731-8M-4G	8	1/4	14	19	41.5	48.0	28.0
FCCI731-8M-6G	8	3/8	14	19	41.5	48.0	28.0
FCCI731-10M-4G	10	1/4	17	23	45.5	53.5	31.5
FCCI731-10M-6G	10	3/8	17	23	45.5	54.0	31.5
FCCI731-12M-8G	12	1/2	17	24	45.5	54.0	35.0

WARNING These products can expose you to chemicals including NICKEL or LEAD, which are known to the state of California to cause cancer and LEAD.

[Click here for CADs, Product Specifications or to Configure Parts Online](#)

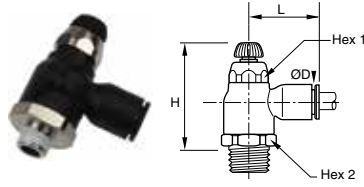

FCCB731 Compact Bi-Directional Flow Control

PART NO.	TUBE SIZE IN	NPT	HEX 1	HEX 2	H OPEN	H CLOSED	L
FCCB731-4M-2	5/32(4MM)	1/8	.63	.39	1.67	1.44	.85
FCCB731-4-2	1/4	1/8	.63	.39	1.67	1.44	.85
FCCB731-4-4	1/4	1/4	.63	.39	1.67	1.44	.85

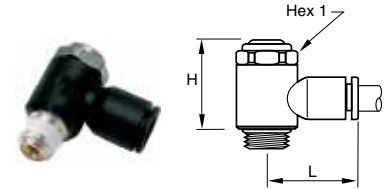

FCKC731 Knobless Meter Out Flow Control

ART NO.	TUBE SIZE IN	NPT / UNF	HEX 1 MM	H	L
FCKC731-2-0	1/8	10-32		.69	.65
FCKC731-2-2	1/8	1/8	13	.79	.75
FCKC731-4M-0	5/32(4MM)	10-32		.69	.65
FCKC731-4M-2	5/32(4MM)	1/8	13	.79	.75
FCKC731-4-0	1/4	10-32		.69	.77
FCKC731-4-2	1/4	1/8	13	.79	.85
FCKC731-4-4	1/4	1/4	17	1.04	.89
FCKC731-8M-2	5/16(8MM)	1/8	13	.79	1.02
FCKC731-8M-4	5/16(8MM)	1/4	17	1.04	1.06
FCKC731-6-4	3/8	1/4	17	1.04	1.14
FCKC731-6-6	3/8	3/8	20	1.14	1.36

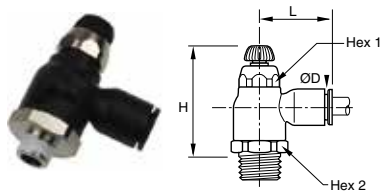

FCCB731 Compact Bi-directional Flow Control - BSPT

PART NO.	TUBE SIZE MM	BSPT	HEX 1	HEX 2	H CLOSED	H OPEN	L
FCCB731-4M-2R	4	1/8	16	10	36.5	42.5	22.0
FCCB731-6M-2R	6	1/8	16	10	36.5	42.5	22.0
FCCB731-6M-4R	6	1/4	16	10	36.5	42.5	22.0
FCCB731-8M-2R	8	1/8	19	14	40.0	45.0	27.0
FCCB731-8M-4R	8	1/4	19	14	40.0	45.0	27.0
FCCB731-8M-6R	8	3/8	19	14	40.0	45.0	27.0

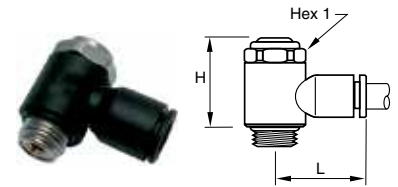

FCKC731 Knobless Compact Flow Control - BSPP

PART NO.	TUBE SIZE MM	BSPP / M5	HEX 1	H	L
FCKC731-4M-M5	4	M5X0.8	8.0	17.5	17.0
FCKC731-4M-2G	4	1/8	13.0	25.0	19.0
FCKC731-6M-M5	6	M5X0.8	8.0	17.5	19.0
FCKC731-6M-2G	6	1/8	13.0	25.0	21.0
FCKC731-6M-4G	6	1/4	17.0	26.5	22.0
FCKC731-8M-2G	8	1/8	13.0	25.0	26.0
FCKC731-8M-4G	8	1/4	17.0	26.5	27.0
FCKC731-8M-6G	8	3/8	20.0	37.5	29.0
FCKC731-10M-4G	10	1/4	17.0	26.5	29.0
FCKC731-10M-6G	10	3/8	20.0	37.5	31.0
FCKC731-10M-8G	10	1/2	23.0	43.0	37.0
FCKC731-12M-6G	12	3/8	20.0	37.5	6.8
FCKC731-12M-8G	12	1/2	23.0	43.0	37.0

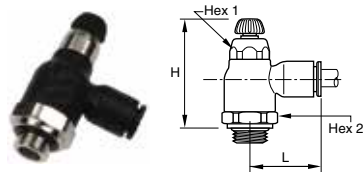

FCCB731 Compact Bi-directional Flow Control - BSPP

PART NO.	TUBE SIZE MM	BSPP	HEX 1	HEX 2	H CLOSED	H OPEN	L
FCCB731-4M-2G	4	1/8	10	16	38.0	44.0	22.0
FCCB731-6M-2G	6	1/8	10	16	38.0	44.0	22.0
FCCB731-6M-4G	6	1/4	10	16	36.5	42.5	22.0
FCCB731-8M-2G	8	1/8	14	19	41.5	48.0	28.0
FCCB731-8M-4G	8	1/4	14	19	41.5	48.0	28.0
FCCB731-8M-6G	8	3/8	14	19	41.5	48.0	28.0

WARNING These products can expose you to chemicals including NICKEL or LEAD, which are known to the state of California to cause cancer and LEAD.

[Click here for CADs, Product Specifications or to Configure Parts Online](#)

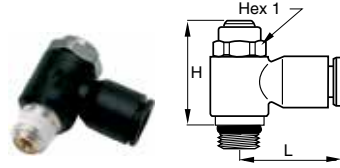

FCKCI731 Knobless Meter In Flow Control

PART NO.	TUBE SIZE IN	NPT / UNF	HEX 1 MM	H	L
FCKCI731-4M-2	5/32(4MM)	1/8	13	.79	.75
FCKCI731-4-2	1/4	1/8	13	.79	.85

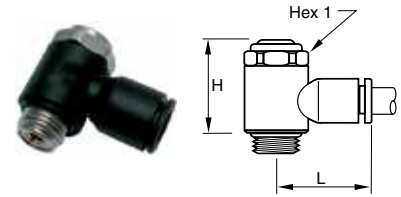

FCKCB731 Knobless Bi-directional Flow Control - BSPP

PART NO.	TUBE SIZE MM	BSPP / M5	HEX 1	H	L
FCKCB731-4M-M5	4	M5X0.8	8	17.5	17.0
FCKCB731-4M-2G	4	1/8	13	25.0	19.0
FCKCB731-6M-M5	6	M5X0.8	8	17.5	19.0
FCKCB731-6M-2G	6	1/8	13	25.0	21.0
FCKCB731-6M-4G	6	1/4	17	26.5	22.0
FCKCB731-8M-2G	8	1/8	13	25.0	26.0
FCKCB731-8M-4G	8	1/4	17	26.5	27.0
FCKCB731-8M-6G	8	3/8	20	37.5	29.0

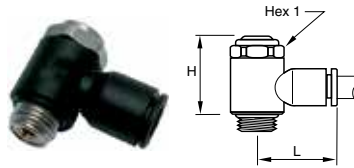

FCKCI731 Knobless Compact Meter In Flow Control-BSPP

PART NO.	TUBE SIZE MM	BSPP / M5	HEX 1	H	L
FCKCI731-4M-M5	4	M5X0.8	8.0	17.5	17.0
FCKCI731-4M-2G	4	1/8	13.0	25.0	19.0
FCKCI731-6M-M5	6	M5X0.8	8.0	17.5	19.0
FCKCI731-6M-2G	6	1/8	13.0	25.0	21.0
FCKCI731-6M-4G	6	1/4	17.0	26.5	22.0
FCKCI731-8M-2G	8	1/8	13.0	25.0	26.0
FCKCI731-8M-4G	8	1/4	17.0	26.5	27.0
FCKCI731-8M-6G	8	3/8	20.0	37.5	29.0
FCKCI731-10M-4G	10	1/4	17.0	26.5	29.0
FCKCI731-10M-6G	10	3/8	20.0	37.5	31.0

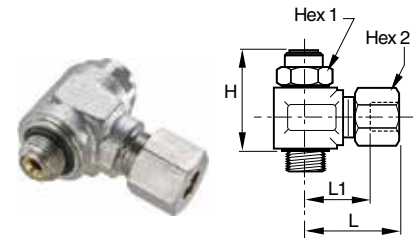

FCK701C Knobless Compression Metal Flow Control - BSPP

PART NO.	TUBE SIZE MM	BSPP	HEX 1	HEX 2	H	L	L1
FCK701C-4M-2G	4	1/8	13	10	26.0	25.5	14.5
FCK701C-6M-2G	6	1/8	13	13	26.0	25.5	14.5
FCK701C-6M-4G	6	1/4	17	13	31.5	28.5	17.5
FCK701C-8M-2G	8	1/8	13	14	26.0	29.5	15.5
FCK701C-8M-4G	8	1/4	17	14	31.5	31.0	17.0
FCK701C-10M-4G	10	1/4	17	19	31.5	35.0	19.0
FCK701C-10M-6G	10	3/8	20	19	44.5	37.5	19.0
FCK701C-10M-8G	10	1/2	23	19	50.0	37.5	19.0
FCK701C-12M-8G	12	1/2	23	22	50.0	38.0	21.5

WARNING These products can expose you to chemicals including NICKEL or LEAD, which are known to the state of California to cause cancer and LEAD.

Miniature Flow Controls



Parker's miniature flow controls ensure excellent performance of flow and are perfectly suited for reduced spaces due to their small size.

Product Features:

- Glass reinforced nylon 6.6 body
- Stainless steel gripping ring
- Nickel-plated brass adjustment screw
- Nickel-plated brass locking nut
- Nickel-plated brass threads
- Nitrile D seal
- NPT, BSPT, BSPP, Metric threads

Markets:

- Factory/Process Automation
- Life Science
- Food Processing
- Water And Beverage
- Petrochemical

Applications:

- Packaging
- Filling
- Dispensing
- Bottling
- Pneumatic Circuits

Specifications:

Pressure Range 15 to 145 psi (1.0 to 9.9 bar)

Temperature Range +32° to +158° F (0 to +70° C)

Compatible Tubing:

- Semi-rigid nylon
- Polyurethane 95 Durometer Shore A
- Nylon
- Fluoropolymer

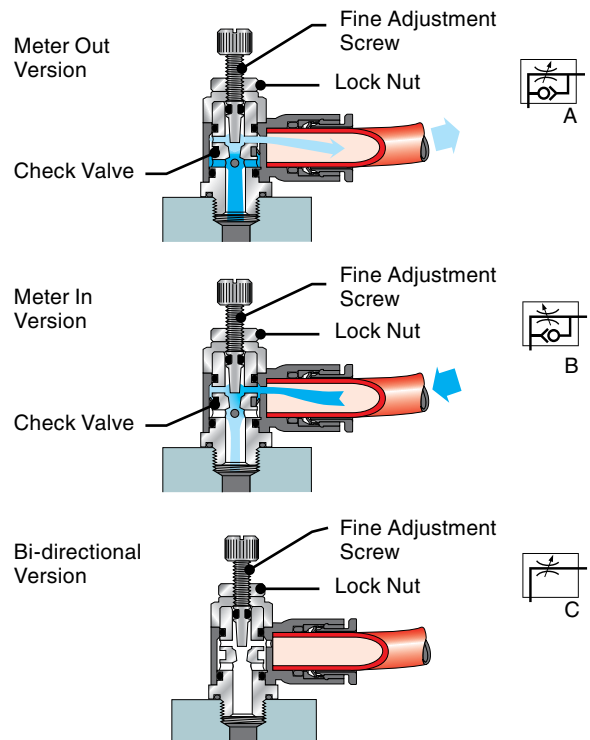

Assembly Instructions

1. Cut tubing squarely – maximum of 15° angle allowable.
2. Check that port or mating part is clean and free of debris.
3. Mark tubing to appropriate tube insertion length. (see Tube Insertion Chart on page N22)
4. Insert tubing until it bottoms
5. Pull on tubing to verify it is fully inserted
6. To disassemble, simply press release button, hold against body and pull tubing out of fitting.

WARNING: These products can expose you to chemicals including NICKEL or LEAD, which are known to the state of California to cause cancer and LEAD.

[Click here for CADs, Product Specifications or to Configure Parts Online](#)

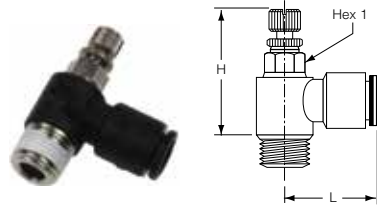

FCM731 Miniature Meter Out Flow Control

PART NO.	TUBE SIZE IN	NPT	HEX 1 MM	H OPEN	H CLOSED	L
FCM731-2-0	1/8	10-32	6	1.14	.91	.67
FCM731-2-2	1/8	1/8	7	1.41	1.26	.69
FCM731-5/32-0	5/32	10-32	6	1.02	.93	.67
FCM731-5/32-2	5/32	1/8	7	1.16	1.06	.71
FCM731-4-0	1/4	10-32	6	1.02	.93	.73
FCM731-4-2	1/4	1/8	7	1.16	1.06	.75
FCM731-4-4	1/4	1/4	8	1.28	1.18	.77

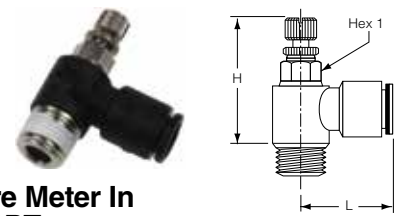

FCM731 Miniature Meter In Flow Control - BSPT

PART NO.	TUBE SIZE MM	BSPT	HEX 1	H CLOSED	H OPEN	L
FCM731-4M-2R	4	1/8	7	25.0	27.5	18.0
FCM731-6M-2R	6	1/8	7	25.0	27.5	18.5
FCM731-6M-4R	6	1/4	8	27.5	30.0	19.0
FCM731-8M-2R	8	1/8	13	28.5	33.0	26.0
FCM731-8M-4R	8	1/4	16	31.0	35.0	27.5

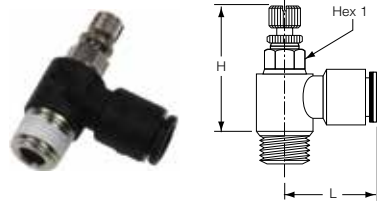

FCM731 Miniature Meter In Flow Control

PART NO.	TUBE SIZE IN	NPT	HEX 1 MM	H OPEN	H CLOSED	L
FCM731-2-0	1/8	10-32	6	1.14	.91	.67
FCM731-5/32-0	5/32	10-32	6	1.02	.93	.67
FCM731-5/32-2	5/32	1/8	7	1.16	1.06	.71
FCM731-4-0	1/4	10-32	6	1.02	.93	.73
FCM731-4-2	1/4	1/8	7	1.16	1.06	.75
FCM731-4-4	1/4	1/4	8	1.28	1.18	.77

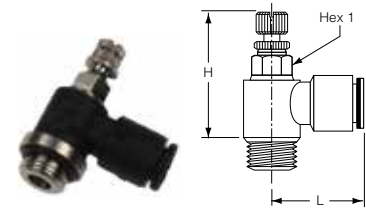

FCM731 Miniature Meter Out Flow Control - BSPP

PART NO.	TUBE SIZE MM	BSPP	HEX 1	H CLOSED	H OPEN	L
FCM731-3M-M3	3	M3X0.5	6	23.5	26.0	17.0
FCM731-3M-M5	3	M5X0.8	6	23.5	26.0	17.0
FCM731-4M-M3	4	M3X0.5	6	23.5	26.0	16.5
FCM731-4M-M5	4	M5X0.8	6	23.5	26.0	17.0
FCM731-4M-2G	4	1/8	7	27.0	29.5	18.0
FCM731-6M-M5	6	M5X0.8	6	23.5	26.0	18.0
FCM731-6M-2G	6	1/8	7	27.0	29.5	18.5
FCM731-6M-4G	6	1/4	8	30.0	32.5	19.0
FCM731-8M-2G	8	1/8	13	26.5	31.0	26.0
FCM731-8M-4G	8	1/4	16	29.0	34.0	27.5
FCM731-8M-6G	8	3/8	20	36.0	42.0	29.0

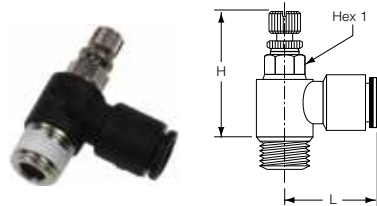

FCM731 Miniature Meter Out Flow Control - BSPT

PART NO.	TUBE SIZE MM	BSPT	HEX 1	H CLOSED	H OPEN	L
FCM731-4M-2R	4	1/8	7	25.0	27.5	18.0
FCM731-6M-2R	6	1/8	7	25.0	27.5	18.5
FCM731-6M-4R	6	1/4	8	27.5	30.0	19.0
FCM731-6M-6R	6	3/8	17	31.5	34.0	19.0
FCM731-8M-2R	8	1/8	13	28.5	33.0	26.0
FCM731-8M-4R	8	1/4	16	31.0	35.0	27.5
FCM731-8M-6R	8	3/8	20	36.0	42.0	29.0

WARNING These products can expose you to chemicals including NICKEL or LEAD, which are known to the state of California to cause cancer and LEAD.

[Click here for CADs, Product Specifications or to Configure Parts Online](#)

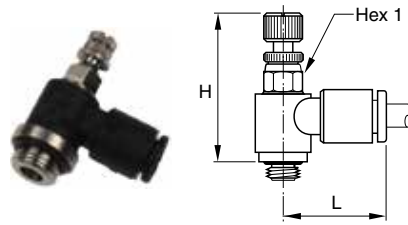

FCMI731 Miniature Meter In Flow Control - BSPP

PART NO.	TUBE SIZE MM	BSPP	HEX 1	H CLOSED	H OPEN	L
FCMI731-3M-M3	3	M3X0.5	6	23.5	26.0	17.0
FCMI731-3M-M5	3	M5X0.8	6	23.5	26.0	17.0
FCMI731-4M-M5	4	M5X0.8	6	23.5	26.0	17.0
FCMI731-4M-2G	4	1/8	7	27.0	29.5	18.0
FCMI731-6M-M5	6	M5X0.8	6	23.5	26.0	18.0
FCMI731-6M-2G	6	1/8	7	27.0	29.5	18.5
FCMI731-6M-4G	6	1/4	8	30.0	32.5	19.0
FCMI731-8M-2G	8	1/8	13	26.5	31.0	26.0
FCMI731-8M-4G	8	1/4	16	29.0	34.0	27.5
FCMI731-8M-6G	8	3/8	20	36.0	42.0	29.0

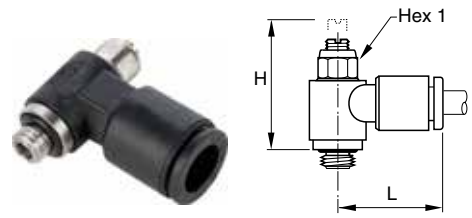

FCMK731 Knobless Mini Meter Out Flow Control

PART NO.	TUBE SIZE IN	NPT	HEX 1 MM	H OPEN	H CLOSED	L
FCMK731-2-0	1/8	10-32	6	.79	.65	.65
FCMK731-2-2	1/8	1/8	6	.85	.71	.71
FCMK731-5/32-0	5/32	10-32	6	.79	.65	.65
FCMK731-5/32-2	5/32	1/8	6	.85	.71	.71
FCMK731-4-0	1/4	10-32	6	.79	.65	.65
FCMK731-4-2	1/4	1/8	6	.85	.71	.73
FCMK731-4-4	1/4	1/4	6	.97	.83	.73

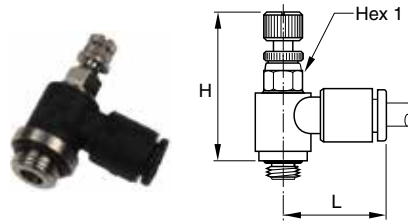

FCMB731 Miniature Bi-directional Flow Control - BSPP

PART NO.	TUBE SIZE MM	BSPP	HEX 1	H CLOSED	H OPEN	L
FCMB731-4M-M5	4	M5X0.8	6	23.5	26.0	16.5
FCMB731-4M-2G	4	1/8	7	27.0	29.5	17.0
FCMB731-6M-M5	6	M5X0.8	6	23.5	26.0	18.0
FCMB731-6M-2G	6	1/8	7	27.0	29.5	18.0
FCMB731-6M-4G	6	1/4	8	30.0	32.5	18.5

WARNING These products can expose you to chemicals including NICKEL or LEAD, which are known to the state of California to cause cancer and LEAD.

Swivel Outlet Flow Controls



Parker's swivel outlet flow controls are designed to allow a vertical or angled tube exit where access is restricted.

Product Features:

- Glass reinforced nylon 6.6 body
- Stainless steel gripping ring
- Nickel-plated brass adjustment screw
- Nickel-plated brass locking nut
- Nickel-plated brass threads
- Nitrile D seal
- NPT, BSPT, BSPP, Metric threads

Markets:

- Factory/Process Automation
- Life Science
- Food Processing
- Water And Beverage
- Petrochemical

Applications:

- Packaging
- Filling
- Dispensing
- Bottling
- Pneumatic Circuits

Specifications:

Pressure Range 15 to 145 psi (1.0 to 9.9 bar)

Temperature Range +32° to +158° F (0 to +70° C)

Compatible Tubing:

- Semi-rigid nylon
- Polyurethane 95 Durometer Shore A
- Nylon
- Fluoropolymer

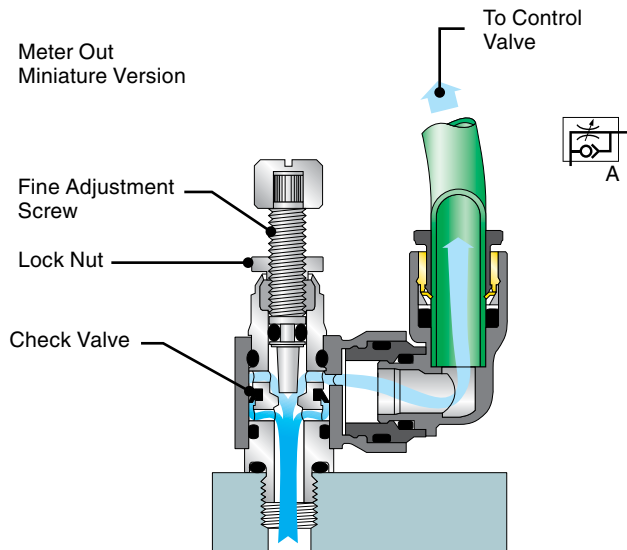

Assembly Instructions

1. Cut tubing squarely – maximum of 15° angle allowable.
2. Check that port or mating part is clean and free of debris.
3. Mark tubing to appropriate tube insertion length. (see Tube Insertion Chart on page N22)
4. Insert tubing until it bottoms
5. Pull on tubing to verify it is fully inserted
6. To disassemble, simply press release button, hold against body and pull tubing out of fitting.

⚠ WARNING These products can expose you to chemicals including NICKEL or LEAD, which are known to the state of California to cause cancer and LEAD.

[Click here for CADs, Product Specifications or to Configure Parts Online](#)

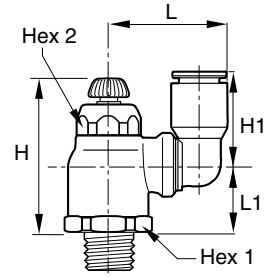

FCCS731 Compact Swivel Outlet Flow Control

PART NO.	TUBE SIZE IN	NPT	HEX 1 MM	HEX 2 MM	H CLOSED	H OPEN	H1	L	L1
FCCS731-4-2	1/4	1/8	19	10	1.87	2.09	.63	.93	.65
FCCS731-4-4	1/4	1/4	19	14	1.79	1.99	.73	1.00	.89
FCCS731-6-4	3/8	1/4	23	17	1.93	2.20	1.04	1.34	.97
FCCS731-6-6	3/8	3/8	23	17	1.93	2.20	1.04	1.34	.97

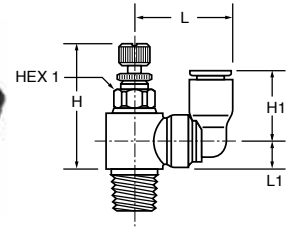

FCMS731 Mini Swivel Outlet Flow Control

PART NO.	TUBE SIZE IN	NPT	HEX 1 MM	H CLOSED	H OPEN	H1	L	L1
FCMS731-4M-0	5/32 (4MM)	10-32	6	.96	1.08	.55	0.73	0.26
FCMS731-4M-2	5/32 (4MM)	1/8	8	1.08	1.20	.55	0.73	0.33

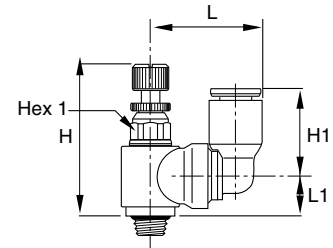

FCMS731 Miniature Swivel Outlet - BSPP

PART NO.	TUBE SIZE MM	BSPP	HEX 1	H CLOSED	H OPEN	H1	L	L1
FCMS731-4M-M5	4	M5X0.8	6	24.5	27.5	14.5	19.5	6.5
FCMS731-4M-2G	4	1/8	7	27.5	31.0	14.5	20.0	8.5
FCMS731-6M-M5	6	M5X0.8	6	24.5	27.5	16.0	21.5	6.5
FCMS731-6M-2G	6	1/8	7	27.5	31.0	16.0	22.0	8.5

WARNING These products can expose you to chemicals including NICKEL or LEAD, which are known to the state of California to cause cancer and LEAD.

[Click here for CADs, Product Specifications or to Configure Parts Online](#)

FCMSI731 Miniature Swivel Outlet Meter In - BSPP

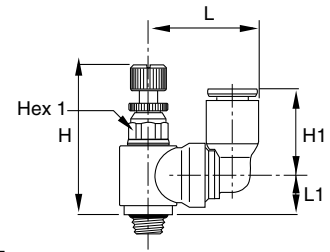

PART NO.	TUBE SIZE MM	BSPP	HEX 1	H CLOSED	H OPEN	H1	L	L1
FCMSI731-4M-M5	4	M5X0.8	6	24.5	27.5	14.5	19.5	6.5
FCMSI731-6M-M5	6	M5X0.8	6	24.5	27.5	16.0	21.5	6.5
FCMSI731-6M-2G	6	1/8	7	27.5	31.0	16.0	22.0	8.5

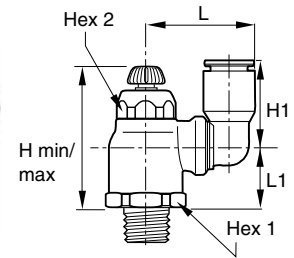

FCCS731 Compact Swivel Outlet - BSPP

PART NO.	TUBE SIZE MM	BSPP	HEX 1	HEX 2	H CLOSED	H OPEN	H1	L	L1
FCCS731-6M-2G	6	1/8	16	10	38.0	44.0	16.0	23.5	18.0
FCCS731-6M-4G	6	1/4	16	10	36.5	42.5	16.0	23.5	16.5
FCCS731-8M-2G	8	1/8	19	14	41.5	48.0	23.0	28.0	19.0
FCCS731-8M-4G	8	1/4	19	14	41.5	48.0	23.0	28.0	19.5
FCCS731-8M-6G	8	3/8	19	14	41.5	48.0	23.0	28.0	17.5
FCCS731-10M-4G	10	1/4	23	17	45.5	53.5	26.5	35.0	21.0
FCCS731-10M-6G	10	3/8	23	17	45.5	54.0	26.5	35.0	21.5
FCCS731-12M-6G	12	3/8	23	17	45.5	54.0	31.0	38.0	21.5
FCCS731-12M-8G	12	1/2	23	17	45.5	54.0	31.0	38.0	21.0

WARNING These products can expose you to chemicals including NICKEL or LEAD, which are known to the state of California to cause cancer and LEAD.

Plug-In Flow Controls



Parker's Plug-in flow controls can be directly mounted into existing fittings and allow very compact installations. They are particularly suited for mounting in manifolds using cartridges.

Product Features:

- Glass reinforced nylon 6.6 body
- Stainless steel gripping ring
- Nickel-plated brass adjustment screw
- Nickel-plated brass locking nut
- Nickel-plated tailpiece
- Nitrile D seal

Markets:

- Factory/Process Automation
- Life Science
- Food Processing
- Water And Beverage
- Petrochemical

Applications:

- Packaging
- Filling
- Dispensing
- Bottling
- Pneumatic Circuits

Specifications:

Pressure Range 15 to 145 psi (1.0 to 9.9 bar)

Temperature Range +32° to +158° F (0 to +70° C)

Compatible Tubing:

- Semi-rigid nylon
- Polyurethane 95 Durometer Shore A
- Nylon
- Fluoropolymer

Miniature

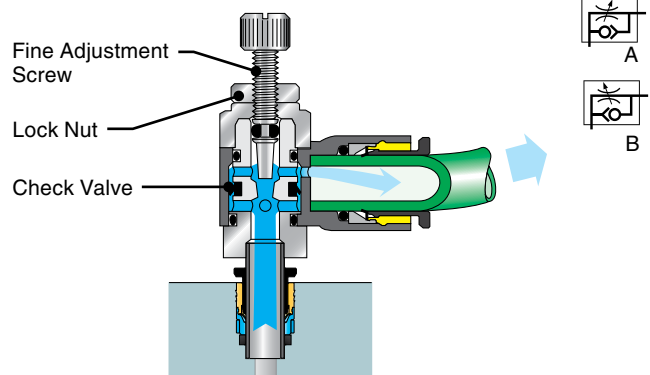

Compact

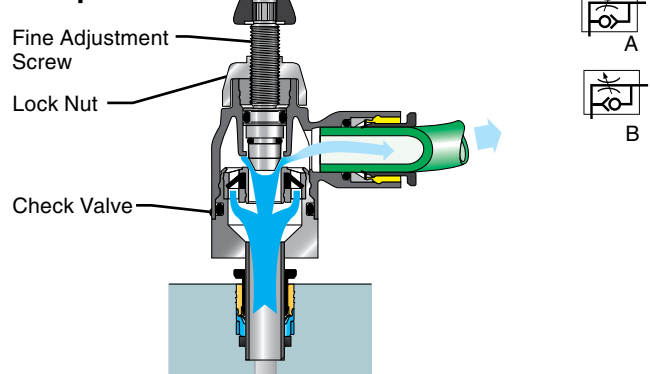

Assembly Instructions

1. Cut tubing squarely – maximum of 15° angle allowable.
2. Check that port or mating part is clean and free of debris.
3. Mark tubing to appropriate tube insertion length. (see Tube Insertion Chart on page N22)
4. Insert tubing until it bottoms
5. Pull on tubing to verify it is fully inserted
6. To disassemble, simply press release button, hold against body and pull tubing out of fitting.

⚠ WARNING These products can expose you to chemicals including NICKEL or LEAD, which are known to the state of California to cause cancer and LEAD.

[Click here for CADs, Product Specifications or to Configure Parts Online](#)

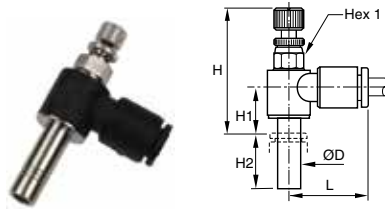

FCMSPI731 Plug-In Mini Meter In Flow Control

PART NO.	TUBE SIZE IN	HEX 1 MM	H OPEN	H CLOSED	H1	H2	L
FCMSPI731-2	1/8	6	1.04	.94	.12	.59	0.67
FCMSPI731-4	1/4	7	1.18	1.08	.12	.73	0.73

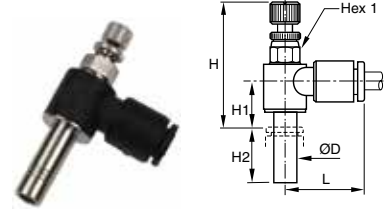

FCMSPI731 Plug-In Mini Meter In Flow Control

PART NO.	TUBE SIZE MM	HEX 1	H CLOSED	H OPEN	H1	H2	L
FCMSPI731-4M (5/32)	4	6	25.5	28.0	9.5	15.5	17.0
FCMSPI731-6M	6	7	27.5	29.0	10.5	17.0	18.5

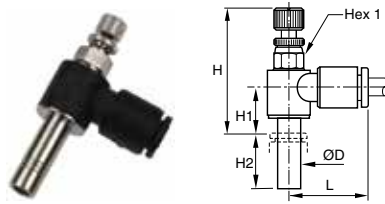

FCMSPI731 Plug-In Mini Meter In Flow Control

PART NO.	TUBE SIZE IN	HEX 1 MM	H OPEN	H CLOSED	H1	H2	L
FCMSPI731-2	1/8	6	1.04	.94	.12	0.59	0.67
FCMSPI731-4	1/4	7	1.18	1.08	.12	0.73	0.73

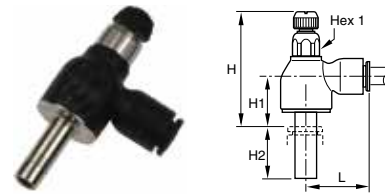

FCCSP731 Plug-In Compact Meter Out Flow Control

PART NO.	TUBE SIZE MM	HEX 1	H CLOSED	H OPEN	H1	H2	L
FCCSP731-6M	6	10	35.0	41.0	14.0	17.0	22.0
FCCSP731-8M	8	14	39.5	46.5	16.0	21.5	28.0
FCCSP731-12M	12	17	43.0	51.0	17.0	27.0	31.5

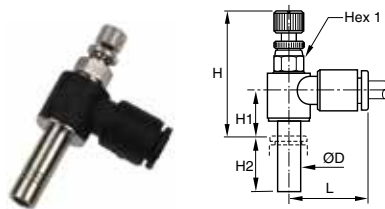

FCMSPI731 - Plug-In Miniature Meter Out Flow Control

PART NO.	TUBE SIZE MM	HEX 1	H CLOSED	H OPEN	H1	H2	L
FCMSPI731-4M (5/32)	4	6	25.5	28.0	9.5	15.5	17.0
FCMSPI731-6M	6	7	27.5	29.0	10.5	17.0	18.5

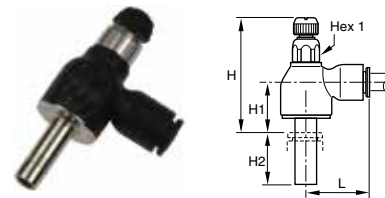

FCCSP731 Plug-In Compact Meter-In Flow Control

PART NO.	TUBE SIZE MM	HEX 1	H CLOSED	H OPEN	H1	H2	L
FCCSP731-6M	6	10	35.0	41.0	14.0	17.0	22.0
FCCSP731-8M	8	14	39.5	46.5	16.0	21.5	28.0
FCCSP731-12M	12	17	43.0	51.0	17.0	27.0	31.5

WARNING These products can expose you to chemicals including NICKEL or LEAD, which are known to the state of California to cause cancer and LEAD.

In-Line Flow Controls



Parker's In-Line flow controls are unidirectional. An arrow on the body indicates the direction of controlled flow. They can be used individually or stacked together using joining clips.

Product Features:

- Glass reinforced nylon 6.6 body
- Stainless steel gripping ring
- Nickel-plated brass adjustment screw
- Nickel-plated brass locking nut
- Nickel-plated threads
- Nitrile D seal
- Panel mountable

Markets:

- Factory/Process Automation
- Life Science
- Food Processing
- Water And Beverage
- Petrochemical

Applications:

- Packaging
- Filling
- Dispensing
- Bottling
- Pneumatic Circuits

Specifications:

Pressure Range 15 to 145 psi (1.0 to 9.9 bar)

Temperature Range +32° to +158° F (0 to +70° C)

Compatible Tubing:

- Semi-rigid nylon
- Polyurethane 95 Durometer Shore A
- Nylon
- Fluoropolymer

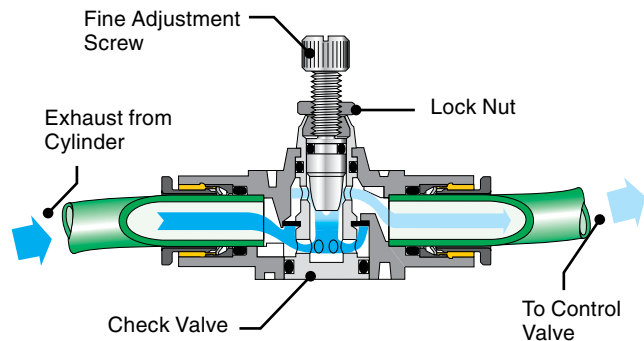

Assembly Instructions

1. Cut tubing squarely – maximum of 15° angle allowable.
2. Check that port or mating part is clean and free of debris.
3. Mark tubing to appropriate tube insertion length. (see Tube Insertion Chart on page N22)
4. Insert tubing until it bottoms
5. Pull on tubing to verify it is fully inserted
6. To disassemble, simply press release button, hold against body and pull tubing out of fitting.

⚠ WARNING These products can expose you to chemicals including NICKEL or LEAD, which are known to the state of California to cause cancer and LEAD.

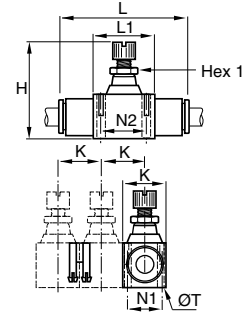

FC832 In-Line Flow Control

PART NO.	TUBE SIZE IN	HEX 1 MM	H CLOSED	H OPEN	K	L	L1	N1	N2	T
FC832-4	1/4	8	1.54	1.74	.66	2.00	.90	.43	.66	.12
FC832-6	3/8	14	2.03	2.38	.94	2.87	1.29	.62	1.01	1.60
FC832-8	1/2	14	2.24	2.63	1.09	3.35	1.37	.78	1.07	.16

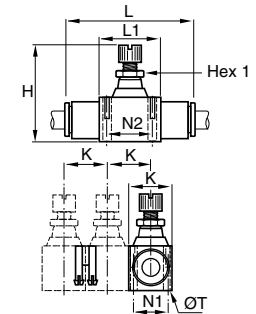

FCB832 In-Line Bi-directional Flow Control

PART NO.	TUBE SIZE IN	HEX 1 MM	H CLOSED	H OPEN	K	L	L1	N1	N2	T
FCB832-4	1/4	8	1.54	1.74	.66	2.00	.90	.43	.66	.12

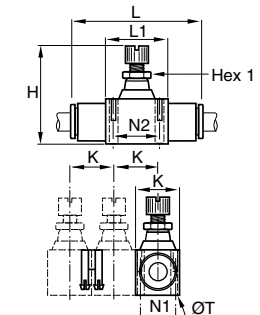

FC832 In-Line Flow Control

PART NO.	TUBE SIZE MM	HEX 1	H CLOSED	H OPEN	K	L	L1	N1	N2	T
FC832-4M	4	5	29.5	33.5	12	15	12	8	11	2.2
FC832-6M	6	8	40.5	44.5	17.0	51.0	23.0	11.0	17.0	3.2
FC832-8M (5/16)	8	11	44.0	50.0	18.5	60.5	26.0	12.5	20.0	3.2
FC832-10M	10	14	52.0	61.0	24.0	76.0	33.0	16.0	26.0	4.2
FC832-12M	12	14	57.5	67.5	28.0	86.0	35.0	20.0	27.5	4.2

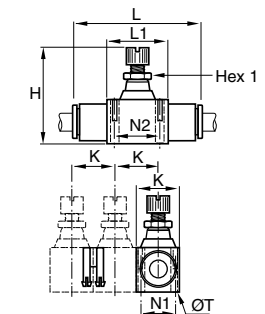

FCB832 In-Line Bi-directional Flow Control

PART NO.	TUBE SIZE MM	HEX 1	H CLOSED	H OPEN	K	L	L1	N1	N2	T
FCB832-4M (5/32)	4	5	29.5	33.5	12.0	36.0	15.0	8.0	11.0	2.2
FCB832-6M	6	8	40.0	44.5	17.0	51.0	23.0	11.0	17.0	3.2
FCB832-8M (5/16)	8	11	44.0	50.0	18.5	60.5	26.0	12.5	20.0	3.2

WARNING These products can expose you to chemicals including NICKEL or LEAD, which are known to the state of California to cause cancer and LEAD.

[Click here for CADs, Product Specifications or to Configure Parts Online](#)

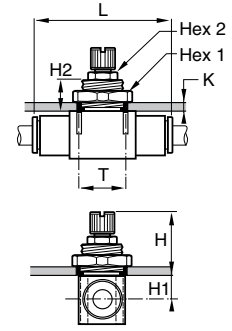

FCPM832 In-Line Panel Mountable Flow Control

PART NO.	TUBE SIZE MM	HEX 1	HEX 2	H CLOSED	H OPEN	K	L	H1	H2	T
FCPM832-4M	4	14		21.5	25.5	6.0	36.0	6.5	11.0	10.5
FCPM832-6M	6	19		27.5	32.5	7.0	51.0	7.5	13.5	16.5
FCPM832-8M	8	24	11	28.5	34.5	7.0	60.5	9.0	13.5	18.5
FCPM832-10M	10	30	14	29.5	38.5	7.0	76.0	11.5	13.5	24.5
FCPM832-12M	12	32	14	32.0	42.0	8.0	86.0	12.5	15.5	27.5

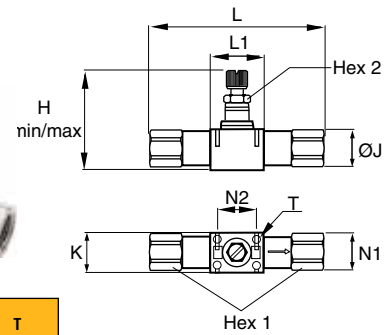

FC836 Threaded In-Line Flow Control

PART NO.	NPT	HEX 1 MM	HEX 2 MM	H CLOSED	H OPEN	K	L	L1	N1	N2	T
FC836-2	1/8	13	8.00	1.56	1.75	.67	2.70	.91	.43	.67	.12
FC836-4	1/4	16	11.00	1.73	1.97	.73	3.27	1.02	.49	.79	.12
FC836-6	3/8	22	14.00	2.05	2.40	.94	3.82	1.30	.63	1.02	.16
FC836-8	1/2	24	14.00	2.26	2.66	1.10	4.76	1.38	.79	1.08	.16

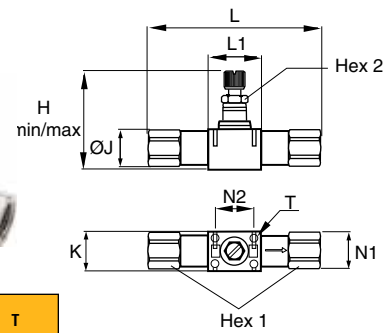

FC836 Threaded In-Line Flow Control - BSPP

PART NO.	BSPP	HEX 1	HEX 2	H CLOSED	H OPEN	K	L	N1	N2	T
FC836-2G	1/8	13	8	39.5	44.5	17.0	68.5	11.0	17.0	3.2
FC836-4G	1/4	16	11	44.0	50.0	18.5	83.0	12.5	20.0	3.2
FC836-6G	3/8	19	14	52.0	61.0	24.0	97.0	16.0	26.0	4.2
FC836-8G	1/2	24	14	57.5	67.5	28.0	121.0	20.0	27.5	4.2

WARNING These products can expose you to chemicals including NICKEL or LEAD, which are known to the state of California to cause cancer and LEAD.

Metal Flow Controls



Parker's Metal flow controls are suited for use in severe conditions (temperatures, sparks, abrasion, etc.). Adjustment can be made with a screwdriver and locking by use of a wrench.

Product Features:

- Treated brass body
- Stainless steel gripping ring
- Electroless-nickel-plated brass adjustment screw
- Nickel-plated brass locking nut
- Nickel-plated threads
- Nitrile D seal

Markets:

- Factory/Process Automation
- Petrochemical
- Automotive Process

Applications:

- Robotics
- Packaging
- Textile

Specifications:

Pressure Range 15 to 145 psi (1.0 to 9.9 bar)

Temperature Range +32° to +158° F (0 to +70° C)

Compatible Tubing:

- Semi-rigid nylon
- Polyurethane 95 Durometer Shore A
- Nylon
- Fluoropolymer

Meter Out Version

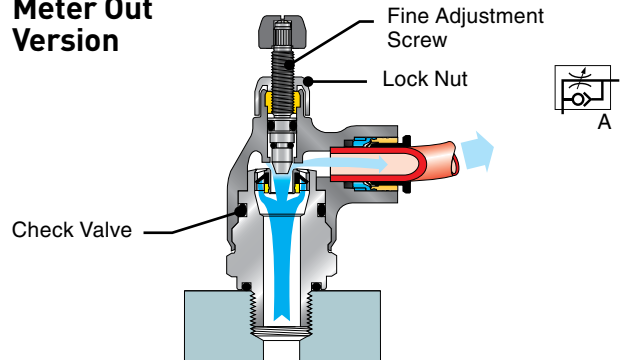

Meter In Version

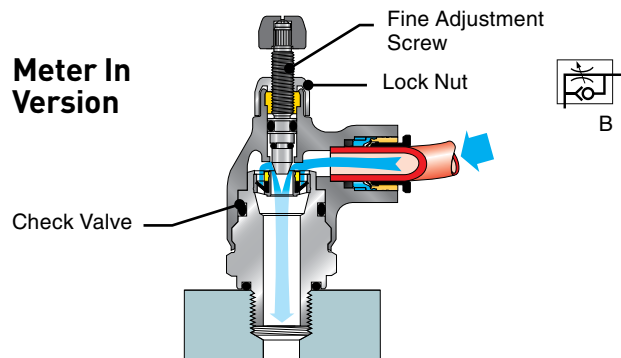

Assembly Instructions

1. Cut tubing squarely – maximum of 15° angle allowable.
2. Check that port or mating part is clean and free of debris.
3. Mark tubing to appropriate tube insertion length. (see Tube Insertion Chart on page N22)
4. Insert tubing until it bottoms
5. Pull on tubing to verify it is fully inserted
6. To disassemble, simply press release button, hold against body and pull tubing out of fitting.

⚠ WARNING These products can expose you to chemicals including NICKEL or LEAD, which are known to the state of California to cause cancer and LEAD.

[Click here for CADs, Product Specifications or to Configure Parts Online](#)

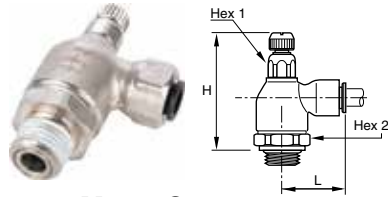

FC705 Push-to-Connect Meter Out Metal Flow Control

PART NO.	TUBE SIZE IN	NPT	HEX 1 MM	HEX 2 MM	H CLOSED	H OPEN	L
FC705-4-2	1/4	1/8	19	10	1.79	2.01	0.97
FC705-4-4	1/4	1/4	19	10	1.79	2.01	0.97
FC705-6-4	3/8	1/4	19	14	1.91	2.11	1.14
FC705-6-6	3/8	3/8	25	17	2.15	2.40	1.40

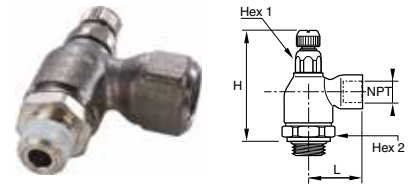

FC708 Threaded Port Meter Out Flow Control

PART NO.	NPT	HEX 1 MM	HEX 2 MM	H CLOSED	H OPEN	L
FC708-2	1/8	19	10	1.79	2.01	.89
FC708-4	1/4	19	14	1.91	2.11	1.28
FC708-6	3/8	25	17	2.15	2.40	1.36
FC708-8	1/2	25	17	2.15	2.40	1.50

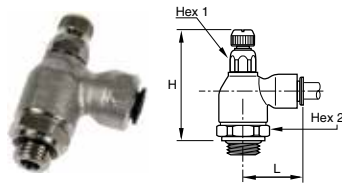

FC701 Push-to-Connect Meter Out Metal Flow Control - BSPP

PART NO.	TUBE SIZE MM	BSPP	HEX 1	HEX 2	H CLOSED	H OPEN	L
FC701-4M-2G	4	1/8	10	19	47.0	53.0	21.0
FC701-6M-2G	6	1/8	10	19	47.0	53.0	24.5
FC701-6M-4G	6	1/4	10	19	47.5	53.0	24.5
FC701-8M-2G	8	1/8	14	19	50.0	55.0	29.0
FC701-8M-4G	8	1/4	14	19	50.0	56.0	29.0
FC701-8M-6G	8	3/8	17	25	56.0	62.0	30.5
FC701-10M-4G	10	1/4	14	19	50.0	56.0	35.0
FC701-10M-6G	10	3/8	17	25	56.0	62.0	35.0
FC701-12M-6G	12	3/8	17	25	56.0	62.0	38.0
FC701-12M-8G	12	1/2	17	25	55.0	62.0	38.0
FC701-14M-8G	14	1/2	17	25	55.0	62.0	41.0

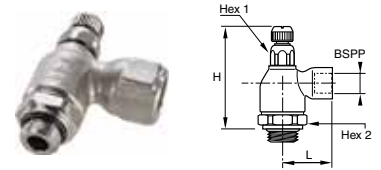

FC702 Threaded Port Meter Out Metal Flow Control - BSPP

PART NO.	BSPP	HEX 1	HEX 2	H CLOSED	H OPEN	L
FC702-2G	1/8	10	19	47.0	52.5	22.5
FC702-4G	1/4	14	19	50.5	55.5	32.0
FC702-6G	3/8	17	25	56.0	62.0	34.5
FC702-8G	1/2	17	25	55.0	62.0	37.5

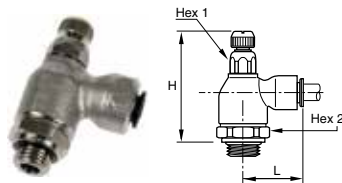

FCI701 Push-to-Connect Meter In Metal Flow Control - BSPP

PART NO.	TUBE SIZE MM	BSPP	HEX 1	HEX 2	H CLOSED	H OPEN	L
FCI701-4M-2G	4	1/8	10	19	47.0	53.0	21.0
FCI701-6M-2G	6	1/8	10	19	47.0	53.0	24.5
FCI701-6M-4G	6	1/4	10	19	47.5	53.0	24.5
FCI701-8M-2G	8	1/8	14	19	50.0	55.0	29.0
FCI701-8M-4G	8	1/4	14	19	50.0	56.0	29.0
FCI701-8M-6G	8	3/8	17	25	56.0	62.0	30.5

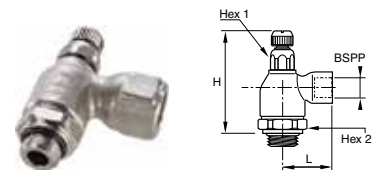

FCI702 Threaded Port Meter In Metal Flow Control - BSPP

PART NO.	BSPP	HEX 1	HEX 2	H CLOSED	H OPEN	L
FCI702-2G	1/8	10	19	47.0	52.5	22.5
FCI702-4G	1/4	14	19	50.5	55.5	32.0

WARNING These products can expose you to chemicals including NICKEL or LEAD, which are known to the state of California to cause cancer and LEAD.

Stainless Steel Flow Controls



Parker's Stainless Steel Flow Controls are used to regulate the speed of a cylinder rod as well as flow in environments with high mechanical or chemical constraints.

Product Features:

- Suitable for corrosive environments
- Excellent mechanical and chemical resistance
- 100% leak tested in production
- Smooth external surfaces to facilitate cleaning
- Suitable for food applications

Markets:

- Factory/Process Automation
- Life Science
- Food Processing
- Water And Beverage
- Petrochemical

Applications:

- Packaging
- Filling
- Dispensing
- Bottling,
- Pneumatic Circuits
- Semi-Conductors

Specifications:

Pressure Range 15 to 145 psi (1.0 to 9.9 bar)

Temperature Range +32° to +158° F (0 to +70° C)

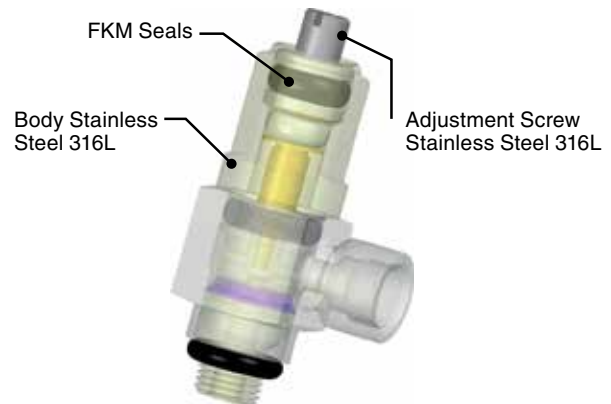

Assembly Instructions

1. Cut tubing squarely – maximum of 15° angle allowable.
2. Check that port or mating part is clean and free of debris.
3. Mark tubing to appropriate tube insertion length. (see Tube Insertion Chart on page N22)
4. Insert tubing until it bottoms
5. Pull on tubing to verify it is fully inserted
6. To disassemble, simply press release button, hold against body and pull tubing out of fitting.

Operation

Exhaust Model with External Adjustment

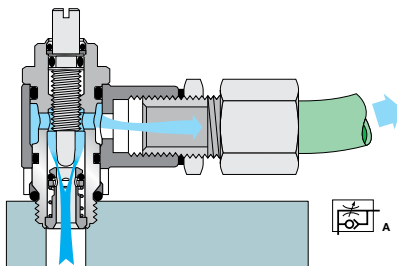

Bi-Directional Model with External Adjustment

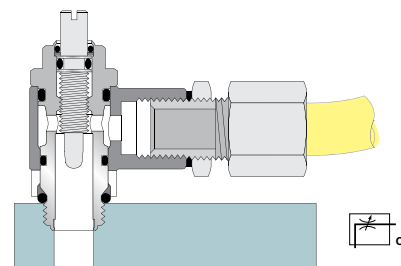

WARNING These products can expose you to chemicals including NICKEL or LEAD, which are known to the state of California to cause cancer and LEAD.

[Click here for CADs, Product Specifications or to Configure Parts Online](#)

**7810, 7812, 7815, 7817 Threaded Port Knobless
Stainless Steel Flow Control - NPT, UNF**

PART NO. METER OUT	PART NO. BI-DIRECTIONAL	C	E	E1	F	H	J	L	WT. OZ.
7810 20 20	7812 20 20	10-32	.16	.16	8	.94	.35	.43	.95
7815 11 11	7817 11 11	1/8	.20	.31	13	1.50	.59	.67	1.23
7815 14 14	7817 14 14	1/4	.31	.47	17	1.38	.71	.94	1.69
7815 18 18	7817 18 18	3/8	.28	.55	20	1.89	.87	1.06	2.08
7815 22 22	7817 22 22	1/2	.31	.59	23	2.52	1.10	1.22	2.68

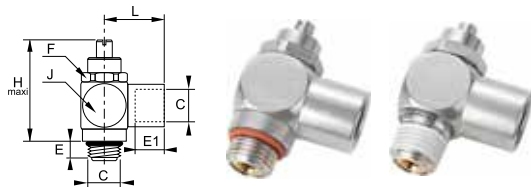

**7810, 7812, Threaded Port Knobless
Stainless Steel Flow Control - BSPP Metric**

PART NO. METER OUT	PART NO. BI-DIRECTIONAL	C	E	E1	F	H	J	L	WT. KG.
7810 19 19	7812 19 19	M5X0.8	4	4	8	24	10	11	.027
7810 10 10	7812 10 10	G1/8	5	8	13	38	15	17	.035
7810 13 13	7812 13 13	G1/4	8	12	17	40	18	24	.048
7810 17 17	7812 17 17	G3/8	7	12	20	53	22	24	.059
7810 21 21	7812 21 21	G1/2	8	15	23	69	28	31	.076

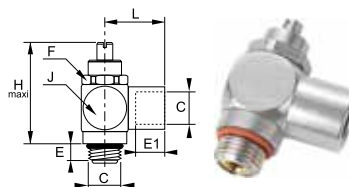

**7835 Push-to-Connect Knobless
Stainless Steel Flow Control Tube to NPT**

PART NO. METER OUT	ØD	C	F MM	H	J	L	WT. OZ.
7835 56 11	1/4	1/8	13	1.30	.59	.87	1.69
7835 60 18	3/8	3/8	20	1.89	.87	1.26	2.68

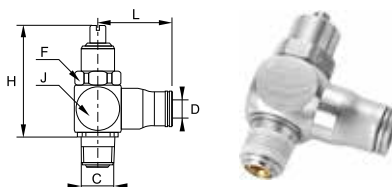

WARNING These products can expose you to chemicals including NICKEL or LEAD, which are known to the state of California to cause cancer and LEAD.

In-Line Check Valves



Parker's In-Line Check Valves allows air to pass in one direction while blocking flow in the other direction. The body of the fitting contains an arrow to indicate the direction of flow.

Product Features:

- Nylon/Nickel-plated brass body
- VC – Acetal body
- Stainless steel gripping ring
- Nickel-plated brass threads
- Nitrile O-ring
- EPDM O-ring (VC)

Markets:

- Factory/Process Automation
- Packaging
- Petrochemical
- Pneumatics
- Semi-Conductor

Applications:

- Robotics
- Packaging
- Textile
- Machine Tools
- Pneumatic Systems
- Vacuum

Specifications:

Pressure Range	15 to 145 psi (1.0 to 9.9 bar)
Temperature Range	+34° to +150° F (+1.1° to 65.5° C)
Cracking Pressure	PLCK – 7 PSI (0.4 bar), VC – 1/3 PSI (0.02 bar)

Compatible Tubing:

- Semi-rigid nylon
- Polyurethane 95 Durometer Shore A
- Nylon
- Fluoropolymer

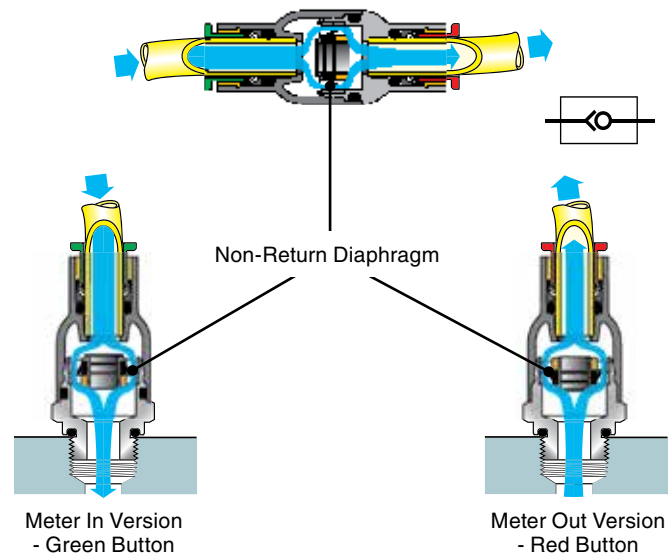

Assembly Instructions

1. Cut tubing squarely – maximum of 15° angle allowable.
2. Check that port or mating part is clean and free of debris.
3. Mark tubing to appropriate tube insertion length. (see Tube Insertion Chart on page N22)
4. Insert tubing until it bottoms
5. Pull on tubing to verify it is fully inserted
6. To disassemble, simply press release button, hold against body and pull tubing out of fitting.

⚠ WARNING These products can expose you to chemicals including NICKEL or LEAD, which are known to the state of California to cause cancer and LEAD.

[Click here for CADs, Product Specifications or to Configure Parts Online](#)

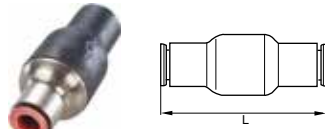

32PLCK In-Line Check Valve

PART NO.	TUBE SIZE IN	L
32PLCK-4	1/4	1.61
32PLCK-6	3/8	2.50

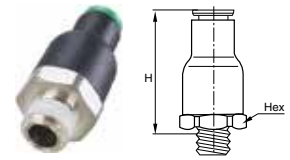

W68PLCKI Male Check Valve Meter In

PART NO.	TUBE SIZE IN	NPT / UNF	HEX MM	H
68PLCKI-4M-0	5/32	10-32	9	1.26
W68PLCKI-4M-2	5/32	1/8	16	1.12
W68PLCKI-4-2	1/4	1/8	19	1.42
W68PLCKI-4-4	1/4	1/4	19	1.42
W68PLCKI-6-4	3/8	1/4	23	1.65
W68PLCKI-6-6	3/8	3/8	23	1.65

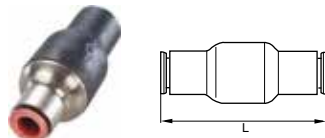

32PLCK In-Line Check Valve

PART NO.	TUBE SIZE MM	L
32PLCK-4M (5/32)	4	38.5
32PLCK-6M	6	41.0
32PLCK-8M (5/16)	8	51.5
32PLCK-10M	10	63.5
32PLCK-12M	12	66.5

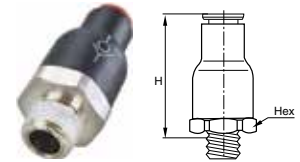

W68PLCK Male Check Valve Meter Out - BSPT

PART NO.	TUBE SIZE MM	BSPT	HEX 1	H
W68PLCK-4M-2R	4	1/8	16	28.5
W68PLCK -6M-2R	6	1/8	16	30.5
W68PLCK -6M-4R	6	1/4	16	30.5
W68PLCK -8M-2R	8	1/8	19	36.0
W68PLCK -8M-4R	8	1/4	19	36.0
W68PLCK -12M-6R	12	3/8	23	42.0

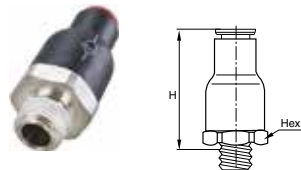

W68PLCK Male Check Valve

PART NO.	TUBE SIZE IN	NPT / UNF	HEX MM	H
W68PLCK-4M-2	5/32	1/8	16	1.12
W68PLCK-4-2	1/4	1/8	19	1.42
W68PLCK-4-4	1/4	1/4	19	1.42
W68PLCK-6-4	3/8	1/4	23	1.65
W68PLCK-6-6	3/8	3/8	23	1.65

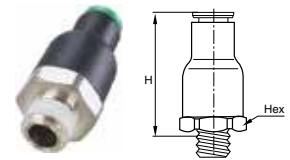

W68PLCKI Male Check Valve Meter In - BSPT

PART NO.	TUBE SIZE MM	BSPT	HEX 1	H
W68PLCKI-4M-2R	4	1/8	16	28.5
W68PLCKI -6M-2R	6	1/8	16	30.5
W68PLCKI -6M-4R	6	1/4	16	30.5
W68PLCKI -8M-2R	8	1/8	19	36.0
W68PLCKI -8M-4R	8	1/4	19	36.0

WARNING These products can expose you to chemicals including NICKEL or LEAD, which are known to the state of California to cause cancer and LEAD.

Click here for CADs, Product Specifications or to Configure Parts Online

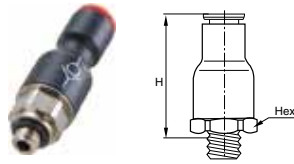

68PLCK Male Check Valve Meter Out - BSPP

PART NO.	TUBE SIZE MM	BSPP	HEX 1	H
68PLCK-4M-M5	4	M5X0.8	9	32.0
68PLCK-6M-2G	6	1/8	16	30.5
68PLCK-6M-4G	6	1/4	16	30.5
68PLCK-8M-2G	8	1/8	19	36.0
68PLCK-8M-4G	8	1/4	19	36.0

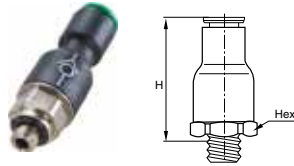

68PLCKI Male Check Valve Meter In - BSPP

PART NO.	TUBE SIZE MM	BSPP	HEX 1	H
68PLCKI-6M-2G	6	1/8	16	30.5
68PLCKI-8M-2G	8	1/8	19	36.0
68PLCKI-8M-4G	8	1/4	19	36.0
68PLCKI-12M-6G	12	3/8	23	42.0
68PLCKI-12M-8G	12	1/2	23	44.0

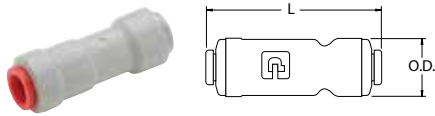

VC – Check Valve

PART NO.	TUBE SIZE IN	L	O.D.
A4VC4-MG	1/4	2.00	.66
A5VC5-MG	5/16	2.10	.70
A6VC6-MG	3/8	2.15	.80
A8VC8-MG	1/2	2.68	.91

WARNING These products can expose you to chemicals including NICKEL or LEAD, which are known to the state of California to cause cancer and LEAD.



Stainless Steel Check Valves

Parker's Stainless Steel Check Valves are ideally suited to harsh environments and for conveying industrial fluids. These check valves allow fluids to flow in one direction and prevent them from flowing in the other.

Product Features:

- 316L Stainless Steel Body & Poppet
- 302 Stainless Steel Spring
- FKM Seals
- Smooth external surfaces contribute to equipment cleanliness
- Suitable for use in corrosive environments

Markets:

- Factory/Process Automation
- Life Science
- Food Processing
- Water And Beverage
- Petrochemical

Applications:

- Pneumatics
- Machine Tools
- Processing
- Chemical
- Printing

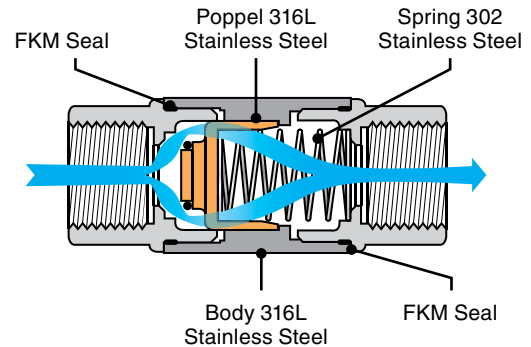

Specifications:

Pressure Range 7 to 580 PSI (0.4 to 39.9 bar)

Cracking Pressure 3.6 PSI (0.2 bar)

Temperature Range -4° to +356° F (-20° to +180° C)

Flow Characteristics

MODEL	WATER FLOW AT 90 PSI	KV
1/8	.67 SCFM	1.60
1/4	.70 SCFM	1.69
3/8	1.26 SCFM	3.01
1/2	1.29 SCFM	3.10
3/4	2.33 SCFM	5.59
1	3.27 SCFM	7.86

WARNING These products can expose you to chemicals including NICKEL or LEAD, which are known to the state of California to cause cancer and LEAD.

Click here for CADs, Product Specifications or to Configure Parts Online

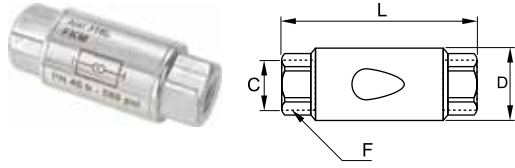

4890 Unidirectional Female - BSPP

PART NO.	C	DN	D MM	F MM	L MM	WT. KG.
4890 10 10	G1/8	10	22	17	50	.084
4890 13 13	G1/4	10	22	17	50	.074
4890 17 17	G3/8	15	30	22	67	.182
4890 21 21	G1/2	15	30	25	71	.196
4890 27 27	G3/4	20	42	32	84	.288
4890 34 34	G1	25	42	38	90	.416

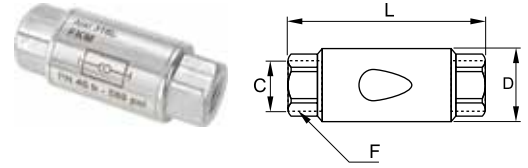

4895 Unidirectional Female - NPT

PART NO.	C	DN	D MM	F MM	L MM	WT. KG.
4895 11 11	1/8	10	22	18	50	.084
4895 14 14	1/4	10	22	18	54	.080
4895 18 18	3/8	15	30	22	73	.198
4895 22 22	1/2	15	30	25	77	.213

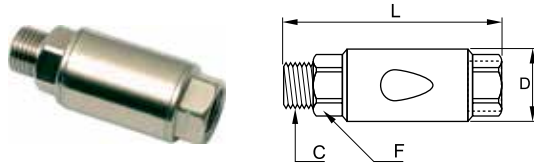

4891 Unidirectional Male to Female - BSPP

PART NO.	C	DN	D MM	F MM	L MM	WT. KG.
4891 10 10	G1/8	10	22	17	56	.086
4891 13 13	G1/4	10	22	17	58	.082
4891 17 17	G3/8	15	30	22	75	.190
4891 21 21	G1/2	15	30	25	79	.280
4891 27 27	G3/4	20	42	32	98	.302
4891 34 34	G1	25	42	38	104	.424

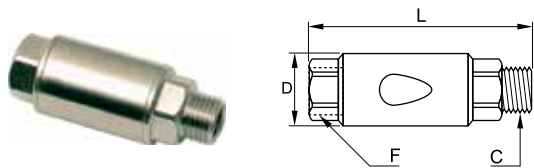

4892 Unidirectional Female to Male - BSPP

PART NO.	C	DN	D MM	F MM	L MM	WT. KG.
4892 10 10	G1/8	10	22	17	56	.086
4892 13 13	G1/4	10	22	17	58	.082
4892 17 17	G3/8	15	30	22	75	.190
4892 21 21	G1/2	15	30	25	79	.280
4892 27 27	G3/4	20	42	32	98	.302
4892 34 34	G1	25	42	38	104	.424

WARNING These products can expose you to chemicals including NICKEL or LEAD, which are known to the state of California to cause cancer and LEAD.



Pilot Operated Check Valves

Parker's Pilot Operated Check Valves are designed to protect installations. If the compressed air supply is removed they lock the air supply to the cylinder, maintaining it in position.

Product Features:

- Orientable and adjustable through 3 axis
- Can be integrated into any installation configuration
- Vent saves time on restart after maintenance operations
- Multi-purpose fitting
 - Piloted non-return valve
 - Flow control regulator
 - Manual exhaust

Markets:

- Factory/Process Automation
- Food Processing
- Pneumatics
- Automotive

Applications:

- Pneumatics
- Machine Tools
- Processing
- Packaging
- Assembly

Specifications:

Pressure Range 14 to 145 PSI (0.9 to 9.9 bar)

Cracking Pressure 4.3 PSI (0.2 bar)

Temperature Range +23° to +140° F (-5° to 60° C)

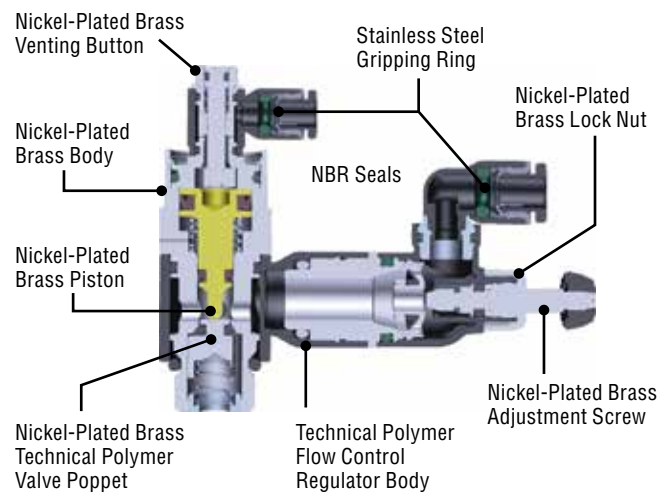

Assembly Instructions

1. Cut tubing squarely – maximum of 15° angle allowable.
2. Check that port or mating part is clean and free of debris.
3. Mark tubing to appropriate tube insertion length. (see Tube Insertion Chart on page N22)
4. Insert tubing until it bottoms
5. Pull on tubing to verify it is fully inserted
6. To disassemble, simply press release button, hold against body and pull tubing out of fitting.

⚠ WARNING These products can expose you to chemicals including NICKEL or LEAD, which are known to the state of California to cause cancer, and LEAD.

Operation

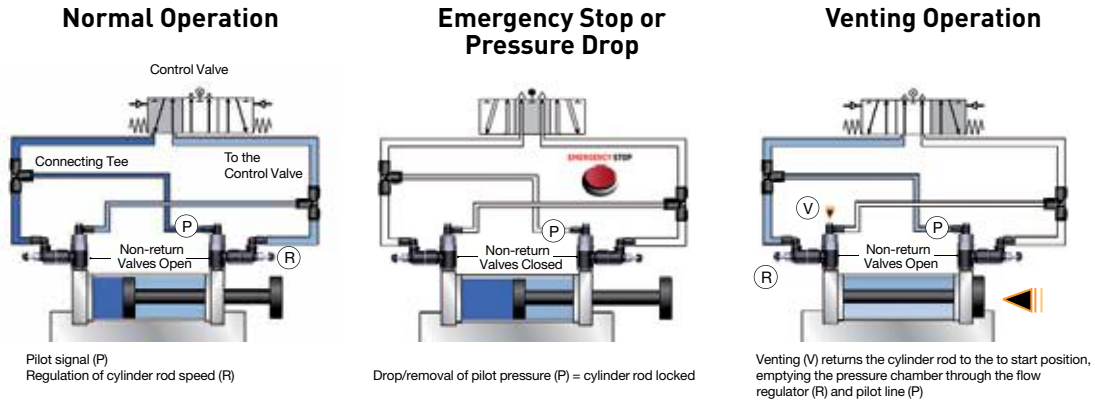

7892 Piloted Non-Return Valve - BSPP

PART NO.	D MM	C	E MM	F MM	G MM	H MM	H1 MM	H2 MM	L MM	WT. KG.
7892 06 10	6	G1/8	6	13	14	42	30	7	21	.028
7892 06 13	6	G1/4	9	17	18.5	45	32	9	23	.049
7892 08 10	8	G1/8	6	13	14	42	29	9	25	.029
7892 08 13	8	G1/4	9	17	18.5	45	32	9	27	.051
7892 08 17	8	G3/8	6	20	22.5	57	41	11	28	.093
7892 10 17	10	G3/8	6	20	22.5	57	41	11	31	.094
7892 10 21	10	G1/2	10	24	28	63	47	16	36	.172
7892 12 21	12	G1/2	10	24	28	63	47	16	36	.162

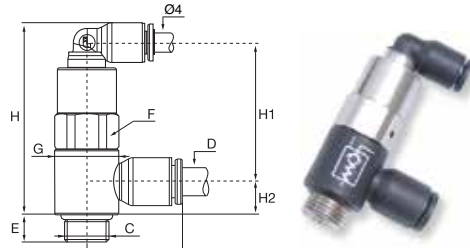

7894 Piloted Non-Return Valve with Flow Regulator and Exhaust - BSPP

PART NO.	D MM	C	E MM	F1 MM	F2 MM	G MM	H MM	H1 MM	H2 MM	H3 MM	L MIN	L MAX	L MM	WT. KG.
7894 06 10	6	G1/8	6	13	8	14	46	7	24	31	48.5	51	16	.049
7894 06 13	6	G1/4	9	17	10	18.5	49	11	18	31	59.5	65	17	.081
7894 08 10	8	G1/8	6	13	8	14	46	7	27	31	48.5	51	22	.050
7894 08 13	8	G1/4	9	17	10	18.5	49	11	23	31	59.5	65	23	.084
7894 08 17	8	G3/8	6	20	14	22.5	69	13	21	40	67.5	73	23	.148
7894 10 17	10	G3/8	6	20	14	22.5	69	13	29	40	67.5	73	26	.152
7894 10 21	10	G1/2	10	24	17	28	76	12.5	26	47	74	81	26	.234
7894 12 21	12	G1/2	10	24	17	28	76	12.5	27	47	74	81	30	.236

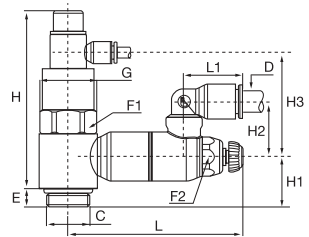

WARNING These products can expose you to chemicals including NICKEL or LEAD, which are known to the state of California to cause cancer and LEAD.

Pneumatic Slide Valves



Parker's Slide Valves may be used to effect an immediate isolation of the air line by venting the system to atmosphere. By moving the sleeve in one direction, the air is free to pass through the slide valve to the system. By moving it in the opposite direction, the supply is shut off and the downstream air is allowed to exhaust to the atmosphere.

Product Features:

- Lightweight due to use of aluminum
- Nitrile Seals
- Immediate identification of the venting system by the color (red)
- Uni-directional use ensures the downstream circuit is vented
- Operated in the plane of the tube

Markets:

- Factory/Process Automation
- Food Processing
- Packaging

Applications:

- Pneumatics
- Conveyors
- Packaging
- Textile
- Plastics Engineering

Specifications:

Pressure Range Up to 230 PSI (15.8 bar)

Temperature Range +15° to +175° F (-9.4° to +79.4° C)

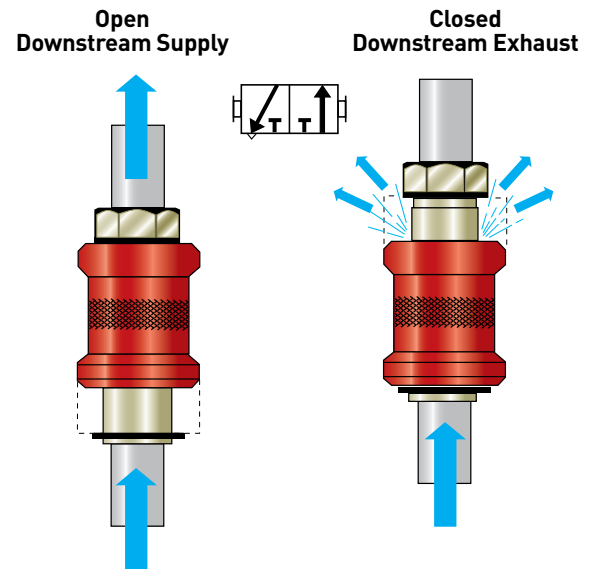

⚠ WARNING These products can expose you to chemicals including NICKEL or LEAD, which are known to the state of California to cause cancer and LEAD.

Click here for CADs, Product Specifications or to Configure Parts Online

0660 Female Slide Valve - NPT

PART NO.	C	DN	F	G	L	WT. OZ.
0660 04 11	1/8	.16	.55	.98	1.89	2.12
0660 07 14	1/4	.27	.67	1.18	2.28	3.71
0660 10 18	3/8	.39	.87	1.38	2.68	6.18
0660 14 22	1/2	.55	1.06	1.57	3.15	9.53

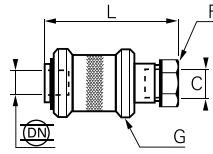

0661 Male to Female Slide Valve - NPT

PART NO.	C	DN	F	G	L	WT. OZ.
0661 04 11	1/8	.16	.55	.98	2.19	2.47
0661 07 14	1/4	.27	.67	1.18	2.75	4.59
0661 10 18	3/8	.39	.87	1.38	3.21	7.59
0661 14 22	1/2	.55	1.06	1.57	3.75	11.30

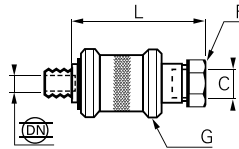

0669 Female Slide Valve - BSPP

PART NO.	C	DN	F MM	G MM	L MM	WT. KG.
0669 02 19	M5X0.8	2	10	14	30.5	.045
0669 04 10	G1/8	4	14	25	48	.051
0669 07 13	G1/4	7	19	30	58	.084
0669 10 17	G3/8	10	22	35	68	.153
0669 14 21	G1/2	14	27	40	80	.227
0669 19 27	G3/4	19	32	50	83	.242

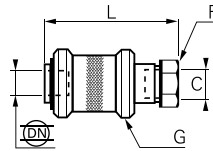

WARNING These products can expose you to chemicals including NICKEL or LEAD, which are known to the state of California to cause cancer and LEAD.

Quick Exhaust Valve



Parker's Quick Exhaust Valve increases the return speed of the cylinder rod by allowing the exhaust to pass directly to atmosphere.

Product Features:

- Nickel plated brass body
- Nylon seal
- Polyurethane piston
- Reduction in cycle times: return speed improved
- Excellent exhaust capacity
- Ideal for applications in restrictive environments

Markets:

- Factory/Process Automation
- Packaging
- Industrial
- Pulp & Paper

Applications:

- Pneumatics
- Conveyors
- Packaging
- Textile
- Plastics Engineering

Specifications:

Pressure Range 10 to 150 PSI (0.6 to 10.3 bar)

Temperature Range 0° to +160° F (-17.7 to +71.1° C)

7970 Quick Exhaust Valve Threaded Ports - BSPP

PART NO.	C	F	H	H1	L	WT.OZ.
7970 19 19	M5 x 0.8	10	24.8	15.6	4	.029
7970 10 10	G1/8	14	42	28	8	.084
7970 13 13	G1/4	19	53	34.5	11	.148
7970 17 17	G3/8	21	58	36	12	.153
7970 21 21	G1/2	26	71	44	14	.316
7970 27 27	G3/4	32	86	52	18	.449
7970 34 34	G1	38	94	56	19	.531

7982 Quick Exhaust Valve Threaded Ports - NPT

PART NO.	C	F	H	H1	L	WT. OZ.
7982 11 11	1/8	14	1.69	1.10	.28	2.97
7982 14 14	1/4	19	2.11	1.38	.37	5.18
7982 18 18	3/8	20	2.19	1.42	.35	5.64
7982 22 22	1/2	26	2.83	1.77	.55	11.29

Operation:

Mounted on Cylinder

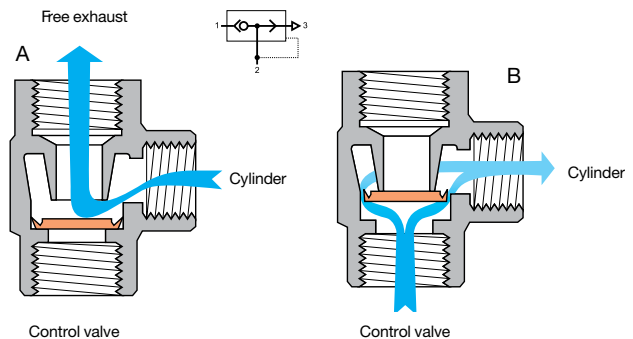

Installation Diagram

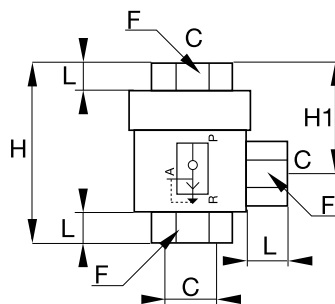
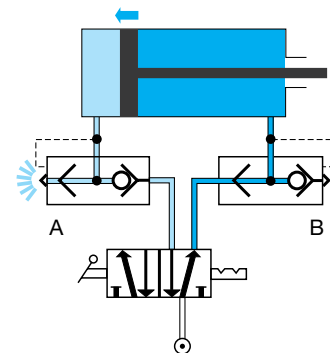

WARNING These products can expose you to chemicals including NICKEL or LEAD, which are known to the state of California to cause cancer and LEAD.

Blocking Valves



Parker's Blocking Valves prevents damage to work and equipment in the event of a loss of pressure. Blocking valves which are mounted in pairs on a cylinder lock the piston by simultaneously cutting off the supply and exhaust.

Product Features:

- Treated brass body
- Stainless steel gripping ring
- Nickel-plated brass threads
- NBR seals
- Silicone free

Markets:

- Factory/Process Automation
- Packaging
- Petrochemical
- Automotive Process

Applications:

- Robotics
- Packaging
- Textile
- Machine Tools

Compatible Tubing:

- Semi-rigid nylon
- Polyurethane 95 Durometer Shore A
- Nylon
- Fluoropolymer

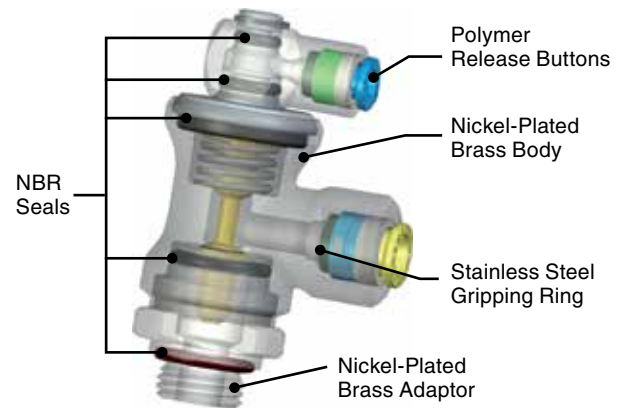

Specifications:

Pressure Range 15 to 145 PSI (1.0 to 9.9 bar)

Temperature Range -4° to +160° F (-20° to +71.1° C)

Leak Rate <3.2CCM

Number of Cycles >10 Million at 68°F and 1 HZ

Assembly Instructions

1. Cut tubing squarely – maximum of 15° angle allowable.
2. Check that port or mating part is clean and free of debris.
3. Mark tubing to appropriate tube insertion length. (see Tube Insertion Chart on page N22)
4. Insert tubing until it bottoms
5. Pull on tubing to verify it is fully inserted
6. To disassemble, simply press release button, hold against body and pull tubing out of fitting.

Operation

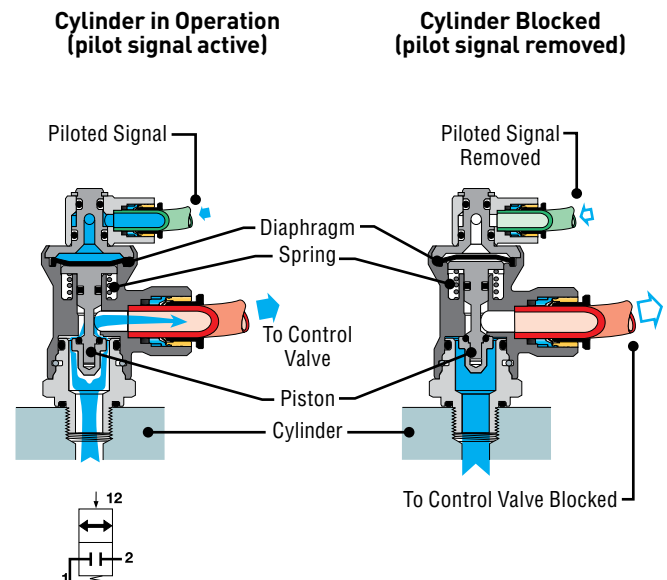

WARNING These products can expose you to chemicals including NICKEL or LEAD, which are known to the state of California to cause cancer, and LEAD.

[Click here for CADs, Product Specifications or to Configure Parts Online](#)

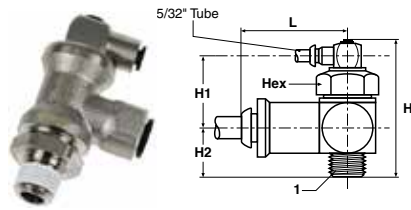

FC601 Push-to-Connect Lock Out Valves

PART NO.	TUBE SIZE IN	NPT	HEX MM	H	H1	H2	L
FC601-4-2	1/4	1/8	21	2.03	1.24	.79	1.10
FC601-4-4	1/4	1/4	21	2.03	1.24	.79	1.10
FC601-6-6	3/8	3/8	24	2.19	1.14	1.04	1.38
FC601-8-8	1/2	1/2	24	2.19	1.14	1.04	1.69

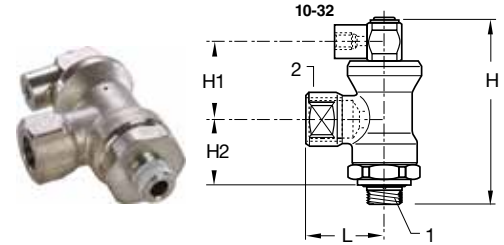

FC602 Threaded Port Lock Out Valves

PART NO.	1 NPT	2 NPT	HEX MM	H	H1	H2	L
FC602-2	1/8	1/8	21	2.03	1.24	.79	1.04
FC602-4	1/4	1/4	21	2.03	1.24	.79	1.04
FC602-6	3/8	3/8	24	2.19	1.14	1.04	1.34
FC602-8	1/2	1/2	24	2.19	1.14	1.04	1.57

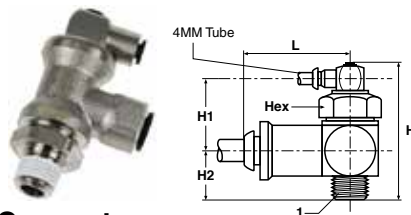

FC601 Push-to-Connect Lock-Out Valve - BSPT

PART NO.	TUBE SIZE MM	BSPT	HEX	H	H1	H2	L
FC601-6M-2R	6	1/8	21	53	24.5	21.0	28.0
FC601-6M-4R	6	1/4	21	53	24.5	21.0	28.0
FC601-8M-4R	8	1/4	21	53	24.5	21.0	28.0
FC601-8M-6R	8	3/8	24	56	25.0	23.0	34.5
FC601-10M-6R	10	3/8	24	56	25.0	23.0	35.0
FC601-12M-8R	12	1/2	24	56	25.0	23.0	37.5

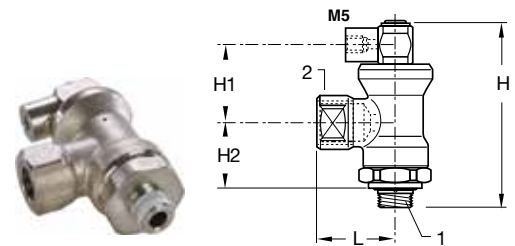

FC608 Threaded Port Lock-Out Valve - BSPT

PART NO.	BSPT 1	BSPT 2	HEX	H	H1	H2	L
FC608-4R-2R	1/8	1/4	21	51.5	31.5	20.0	26.5
FC608-4R-4R	1/4	1/4	21	51.5	31.5	20.0	26.5
FC608-6R-6R	3/8	3/8	24	55.5	29.0	26.5	34.0
FC608-8R-8R	1/2	1/2	24	55.5	29.0	26.5	40.0

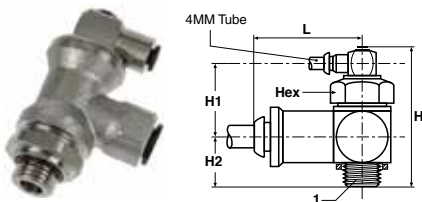

FC601 Push-to-Connect Lock-Out Valve - BSPP

PART NO.	TUBE SIZE MM	BSPP	HEX	H	H1	H2	L
FC601-6M-2G	6	1/8	21	53	24.5	21.0	28.0
FC601-6M-4G	6	1/4	21	53	24.5	21.0	28.0
FC601-8M-4G	8	1/4	21	53	24.5	21.0	28.0
FC601-8M-6G	8	3/8	24	56	25.0	23.0	34.5
FC601-10M-6G	10	3/8	24	56	25.0	23.0	35.0
FC601-12M-8G	12	1/2	24	56	25.0	23.0	37.5

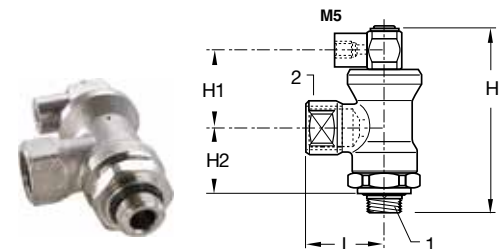

FC608 Threaded Port Lock-Out Valve - BSPP

PART NO.	BSPP 1	BSPP 2	HEX	H	H1	H2	L
FC608-4G-2G	1/8	1/4	21	53	24.5	21.0	28.0
FC608-4G-4G	1/4	1/4	21	53	24.5	21.0	28.0
FC608-6G-6G	3/8	3/8	24	56	25.0	23.0	34.0
FC608-8G-8G	1/2	1/2	24	56	25.0	23.0	41.0

WARNING These products can expose you to chemicals including NICKEL or LEAD, which are known to the state of California to cause cancer and LEAD.

Manually-Operated Valves



Parker Legris' manually-operated valves offer a reliable and durable system for opening and closing the circuit when the system has to be switched frequently. They provide a significant reduction in the time needed to work on pneumatic circuits.

Product Features:

Manual Switch-Operated Valves

- Downstream control supply provided by simply moving the lever
- 2 models available to provide the best solution for the system:
 - 3/2: opening, closing, venting
- Compact and ergonomic (can be positioned through 360°)
- Silicone-Free

Markets:

- Factory/Process Automation
- Packaging
- Industrial
- Pulp & Paper

Applications:

- Robotics
- Conveyors
- Textile
- Plastics Engineering
- Printing
- Pneumatics
- Packaging

Specifications:

Compatible Fluids	Compressed air
Working Pressure	230 psi (15.8 bar)
Working Temperature	15° to 175° F (-10° to 80° C)

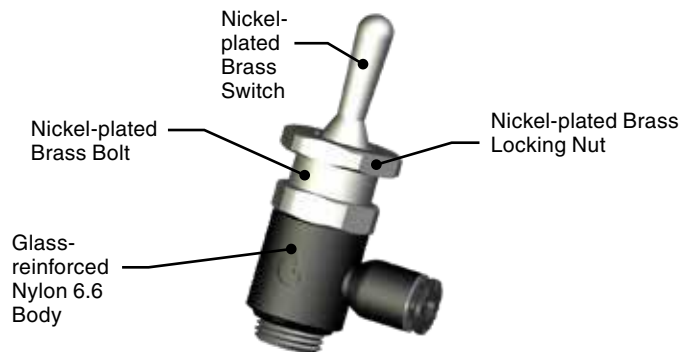

Operation

Switch-Operated Valves

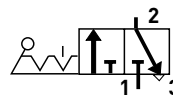

Open

Closed

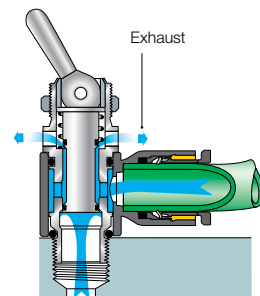
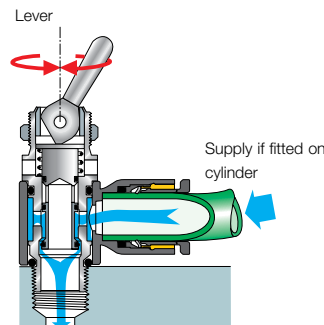

Supply if fitted on control valve

WARNING These products can expose you to chemicals including NICKEL or LEAD, which are known to the state of California to cause cancer and LEAD.

[Click here for CADs, Product Specifications or to Configure Parts Online](#)

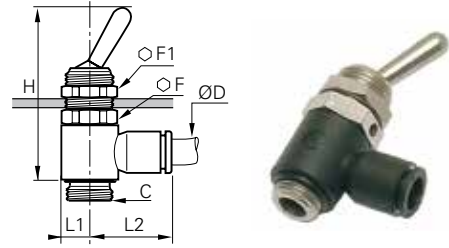
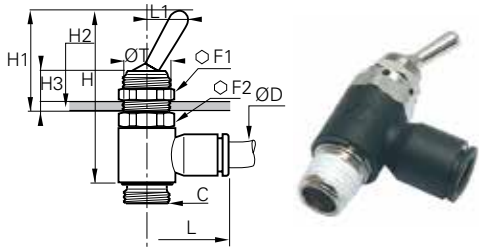

7805/7806 Manually Operated 3-Way Venting Valve Fractional Inch Tube to NPT

PART NO. SUPPLY (1)	ØD IN	C NPT	F1 MM	F2 MM	H IN	H1 IN	H2 IN	H3 IN	L IN	L1 IN	ØT IN	W OZ
7805 04 11	5/32	1/8	14	14	1.69	.98	.18	.30	.75	.43	.49	.95
7805 56 11	1/4	1/8	14	14	1.69	.98	.18	.30	.85	.43	.49	1.02
7805 56 14	1/4	1/4	14	17	1.99	.98	.18	.30	.89	.43	.49	1.55
7805 60 14	3/8	1/4	14	17	1.99	.98	.18	.30	1.14	.43	.49	1.69

PART NO. SUPPLY (2)	ØD IN	C NPT	F1 MM	F2 MM	H IN	H1 IN	H2 IN	H3 IN	L IN	L1 IN	ØT IN	W OZ
7806 04 11	5/32	1/8	14	14	1.69	.98	.18	.30	.75	.43	.49	.95
7806 56 11	1/4	1/8	14	14	1.69	.98	.18	.30	.85	.43	.49	1.02
7806 56 14	1/4	1/4	14	17	1.99	.98	.18	.30	.89	.43	.49	1.55
7806 60 14	3/8	1/4	14	17	1.99	.98	.18	.30	1.14	.43	.49	1.69

7800/7801 Manually Operated 3-Way Venting Valve Metric Tube to BSPP or Metric

PART NO. SUPPLY (1)	ØD MM	C BSPP	F MM	F1 MM	H MM	L1 MM	L2 MM	W KG
7800 04 19	4	M5X0.8	8	-	32	5	16	.020
7800 04 10	4	G1/8	14	14	42.5	7	18.5	.027
7800 06 19	6	M5X0.8	8	-	32	5	19	.022
7800 06 10	6	G1/8	14	14	42.5	7	20	.029
7800 06 13	6	G1/4	17	17	51	9	22	.044
7800 08 10	8	G1/8	14	14	42.5	7	25	.030
7800 08 13	8	G1/4	17	17	51	9	27	.045

PART NO. SUPPLY (2)	ØD MM	C BSPP	F MM	F1 MM	H MM	L1 MM	L2 MM	W KG
7801 04 19	4	M5X0.8	8	-	32	5	16	.020
7801 04 10	4	G1/8	14	14	42.5	7	18.5	.027
7801 06 19	6	M5X0.8	8	-	32	5	19	.022
7801 06 10	6	G1/8	14	14	42.5	7	20	.029
7801 06 13	6	G1/4	17	17	51	9	22	.044
7801 08 10	8	G1/8	14	14	42.5	7	25	.030

WARNING These products can expose you to chemicals including NICKEL or LEAD, which are known to the state of California to cause cancer and LEAD.

Threshold Sensor Fittings



Parker's Threshold Sensor Fitting detects the pressure drop when a cylinder reaches the end of its stroke. They produce a pneumatic or electrical output signal when the pressure drop in the exhaust chamber of the cylinder goes below their back pressure threshold.

Product Features:

- Polymer body
- Brass screw
- NBR seal

Markets:

- Factory/Process Automation
- Packaging
- Pneumatics
- Semi-Conductor

Applications:

- Robotics
- Packaging
- Textile
- Machine Tools
- Pneumatic Systems

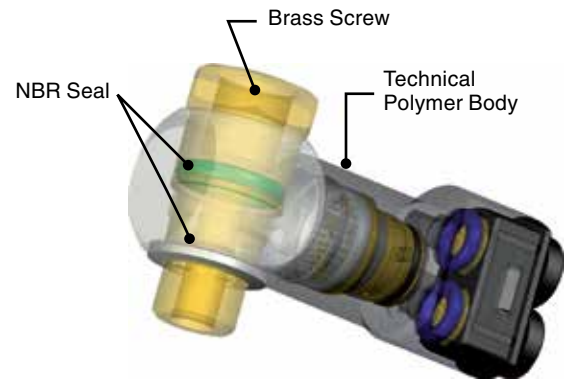

Specifications:

Model PSBJ,PSPJ

Pressure Range 45 to 115 PSI (3.1 to 7.9 bar)

Temperature Range +5° to +140° F (-15° to +60° C)

Breaking Pressure 8.5 PSI (0.5 bar)

Response Time 3 MS

Model PSPE

Pressure Range 45 to 115 PSI (3.1 to 7.9 bar)

Breaking Pressure 8.5 PSI (0.5 bar)

Current Rating 5A/250VAC – 5W/48VDC

Compatible Tubing:

- Semi-rigid nylon
- Polyurethane 95 Durometer Shore A
- Nylon
- Fluoropolymer

Operation

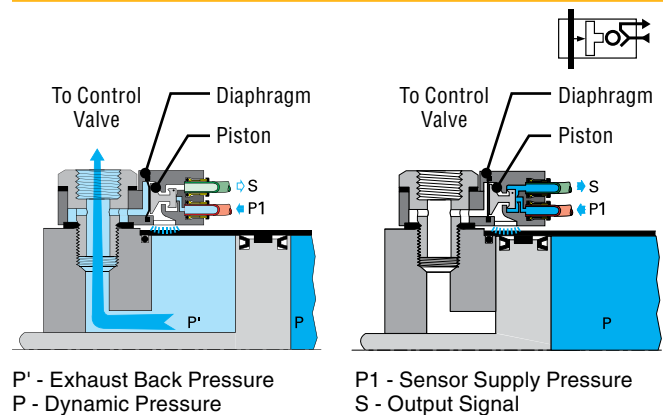

WARNING These products can expose you to chemicals including NICKEL or LEAD, which are known to the state of California to cause cancer and LEAD.

[Click here for CADs, Product Specifications or to Configure Parts Online](#)

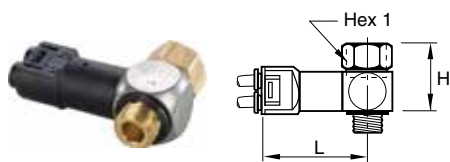

PSBJ731 Pneumatic Threshold Sensor - 5/32 Pilot

PART NO.	NPT / UNF	HEX MM	H	L
PSBJ731-0	10-32	5/16	.62	1.70
PSBJ731-2	1/8	9/16	.90	1.74
PSBJ731-4	1/4	5/8	1.09	1.81
PSBJ731-6	3/8	7/8	1.13	1.91
PSBJ731-8	1/2	1	1.17	2.05

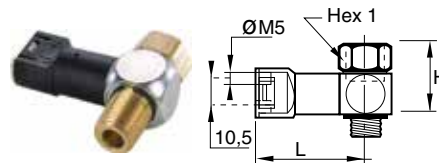

PSBJ708 Pneumatic Threshold Sensor - M5 Pilot

PART NO.	BSPP	HEX 1	H	L
PSBJ708-2G	1/8	14	23	40.5
PSBJ708-4G	1/4	17	28	42.5

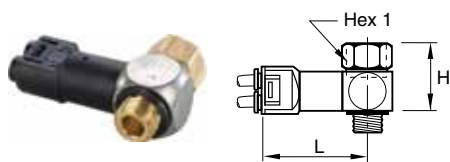

PSBJ731 Pneumatic Threshold Sensor - 4mm Pilot

PART NO.	BSPP	HEX 1	H	L
PSBJ731-M5	M5X0.8	8	16	43.5
PSBJ731-2G	1/8	14	23	44.5
PSBJ731-4G	1/4	17	28	46.5
PSBJ731-6G	3/8	22	29	49.0
PSBJ731-8G	1/2	27	30	52.5

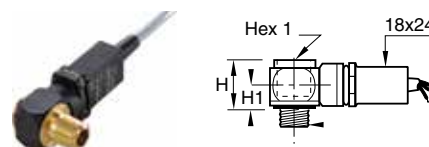

PSPE731 Pneumatic / Electric Threshold Sensor - BSPP

PART NO.	BSPP	HEX 1	H	H1	L
PSPE731-M5	M5X0.8	8	20	10	49
PSPE731-2G	1/8	6	20	10	52
PSPE731-4G	1/4	8	20	10	54
PSPE731-6G	3/8	10	22	12	57

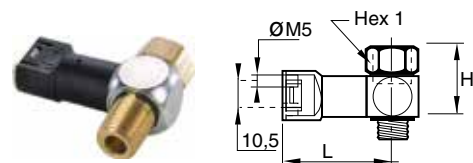

PSPJ731 Pneumatic Threshold Sensor - 10-32 Pilot

PART NO.	NPT	HEX 1 MM	H	L
PSPJ731-2	1/8	9/16	.90	1.58
PSPJ731-4	1/4	5/8	1.09	1.66
PSPJ731-6	3/8	7/8	1.13	1.76

WARNING These products can expose you to chemicals including NICKEL or LEAD, which are known to the state of California to cause cancer and LEAD.

Mini Ball Valves



Parker's Mini Ball Valves enable in-line opening and closing of a pneumatic circuit. Handles are color coded and marked with the corresponding pneumatic symbol, in order to enable immediate identification by the user.

Product Features:

- Nylon body
- Brass stem
- Stainless steel gripping ring
- NBR stem seal
- NBR o-ring
- Nylon Handle
- Lightweight and compact

Markets:

- Factory/Process Automation
- Packaging
- Petrochemical
- Pneumatics
- Semi-Conductor

Applications:

- Robotics
- Packaging
- Textile
- Machine Tools
- Pneumatic Systems
- Vacuum

Specifications:

Pressure Range	145 PSI (9.9 bar)
Temperature Range	-4° to 175° F (-20° to +79.4° C)
Vacuum Capability	28" Hg

Compatible Tubing:

- Semi-rigid nylon
- Polyurethane 95 Durometer Shore A
- Nylon
- Fluoropolymer

Operation

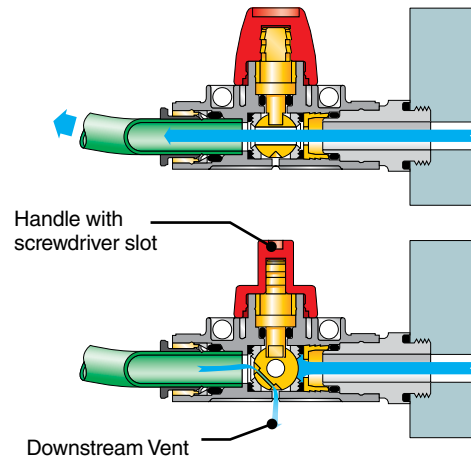

WARNING These products can expose you to chemicals including NICKEL or LEAD, which are known to the state of California to cause cancer and LEAD.

[Click here for CADs, Product Specifications or to Configure Parts Online](#)

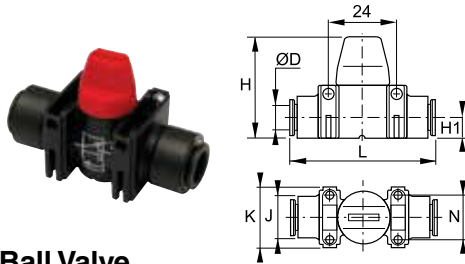

MVV309 Mini Ball Valve
Vented Push-To-Connect Ports

PART NO.	TUBE SIZE IN	H	H1	J	K	L	N
MVV309-4	1/4	1.46	.30	.59	.87	2	.64
MVV309-6	3/8	1.69	.43	.79	1.18	2.6	.87
METRIC							
MVV309-4M (5/32)	4	37.00	7.50	15.00	22.00	51	16.20
MVV309-6M	6	37.00	7.50	15.00	22.00	52	16.20
MVV309-8M (5/16)	8	37.00	7.50	15.00	22.00	52	16.20
MVV309-10M	10	43.00	11.00	20.00	30.00	66	22.00
MVV309-12M	12	43.00	11.00	20.00	30.00	66	22.00

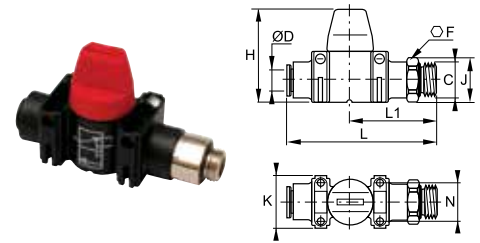

MVV308 Mini Ball Valve
Vented BSSP to Push-To-Connect Port

PART NO.	TUBE SIZE MM	BSSP	F	H	J	K	L	L1	N
MVV308-6M-2G	6	G1/8	13	37	14.00	22	62	37	16.20
MVV308-8M-4G	8	G1/4	16	37	17.50	22	61	35	16.20
MVV308-10M-6G	10	G3/8	20	43	22.00	30	74	41	22.00

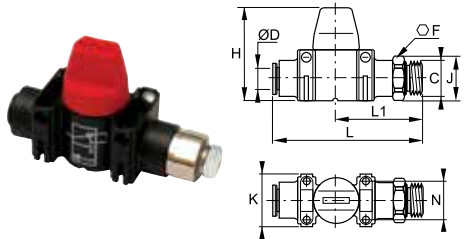

MV309 Mini Ball Valve
Push-To-Connect Ports

PART NO.	TUBE SIZE IN	H	H1	J	K	L	N
MV309-4	1/4	1.46	.30	.59	.87	2.05	.64
MV309-6	3/8	1.69	.43	.79	1.18	2.60	.64
METRIC							
MV309-4M (5/32)	4	37.00	7.50	15.00	22.00	51.00	16.20
MV309-6M	6	37.00	7.50	15.00	22.00	52.00	16.20
MV309-8M (5/16)	8	37.00	7.50	15.00	22.00	52.00	16.20
MV309-10M	10	43.00	11.00	20.00	30.00	66.00	16.20
MV309-12M	12	43.00	11.00	20.00	30.00	66.00	16.20

MVV308 Mini Ball Valve
Vented NPT to Push-To-Connect Port

PART NO.	TUBE SIZE IN	NPT	F	H	J	K	L	L1	N
MVV308-5/32-2	5/32	1/8	13	1.46	.55	.87	2.44	1.46	.64
MVV308-4-2	1/4	1/8	13	1.46	.55	.87	2.44	1.46	.64
MVV308-4-4	1/4	1/4	14	1.46	.59	.87	2.44	1.38	.64
MVV308-5-4	5/16	1/4	14	1.46	.59	1.18	2.40	1.61	.64
MVV308-6-4	3/8	1/4	16	1.69	.69	1.18	2.40	1.65	.87
MVV308-6-6	3/8	3/8	18	1.69	.77	1.18	2.91	1.65	.87

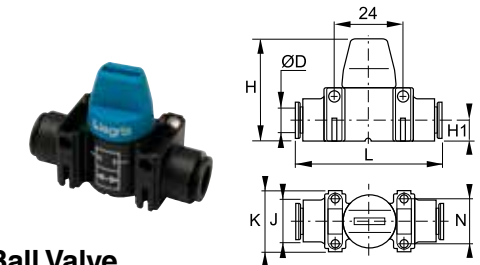

MV308 Mini Ball Valve
BSSP to Push-To-Connect Port

PART NO.	TUBE SIZE MM	BSSP	F	H	J	K	L	L1	N
MV308-6M-2G	6	G1/8	13	37	14	22	62	37	16.20
MV308-10M-6G	10	G3/8	20	43	22	30	74	41	16.20
MV308-12M-8G	12	G1/2	24	43	26	30	75	42	16.20

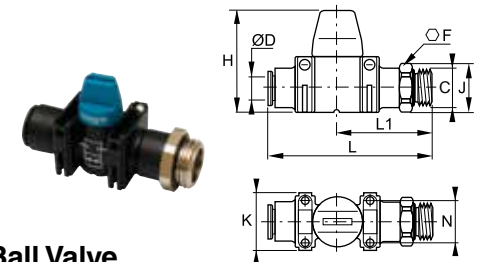

WARNING These products can expose you to chemicals including NICKEL or LEAD, which are known to the state of California to cause cancer and LEAD.



Water & Beverage: Thermoplastic Fittings and Valves

LIQUIfit Fittings

TrueSeal™ Fittings

Fast & Tite® Fittings

Par-Barb® Fittings



For more product information visit:
www.parker.com/water

GOODYEAR
RUBBER PRODUCTS, INC.

 +1.727.342.5087

También puede enviarnos un correo electrónico a
ventas@goodyearrubberproducts.com





GOODYEAR
RUBBER PRODUCTS, INC.

+1.727.342.5087

También puede enviarnos un correo electrónico a
ventas@goodyearrubberproducts.com

LIQUIfit Fittings



Parker's LIQUIfit Fittings offer an innovative alternative for water applications. These fittings ensure reliable and compact connection for liquid transfer applications.

Product Features:

- Stainless steel grab ring
- Bio-sourced nylon 11
- EPDM D – seal
- FDA compliant, NSF/ANSI 51 and NSF/ANSI 61
- Silicone free
- 100% leak tested in production
- Date coding to guarantee quality and traceability

Markets:

- Water Filtration
- Beverage Dispensing
- Life Science
- Bottling
- Semi-Conductor

Applications:

- Water
- Beverages
- Food
- CO₂
- Vacuum

Specifications:

Pressure Range Up to 230 PSI (16 bar)

Temperature Range +35° to +200° F (+1.7° to +93.3° C)

Note: The working specification depends on the type and wall thickness of the tube, the type of fluid, fluid Temperature and ambient temperature

Compatible Tubing:

- Polyethylene

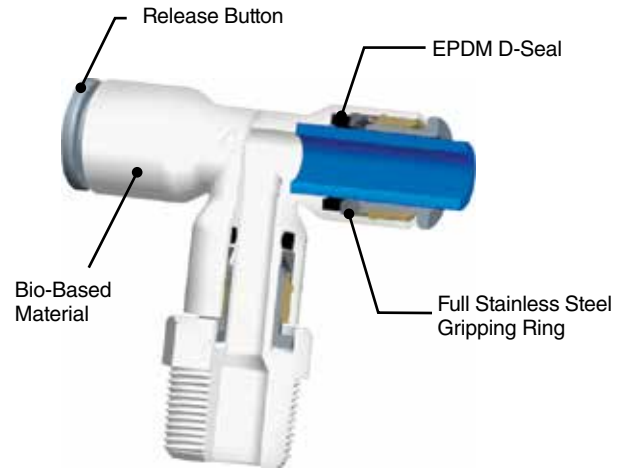

Assembly Instructions

1. Cut tubing squarely – maximum of 15° angle allowable.
2. Check that port or mating part is clean and free of debris.
3. Mark tubing to appropriate tube insertion length. (see Tube Insertion Chart on page N22)
4. Insert tubing until it bottoms
5. Pull on tubing to verify it is fully inserted
6. To disassemble, simply press release button, hold against body and pull tubing out of fitting.

WARNING These products can expose you to chemicals including CARBON BLACK, or LEAD, which are known to the state of California to cause cancer.

Threaded Fittings

6505

Male Connector
BSPT, NPTF
p. C7



6315

Female Connector
NPTF, BSPT
p. C7



6579

Male Elbow
NPTF, BSPT
p. C8



6325

Faucet Connector
UNS
p. C8



6521

Male Standpipe
NPTF, BSPT
p. C8



6509

Male Elbow Swivel
NPTF, BSPT
p. C8, C9



6508

Branch Tee Swivel
NPTF, BSPT
p. C9



AS

Angle Stop Fitting
p. C9



6503

Run Tee Swivel
NPTF, BSPT
p. C9, C10



6548

Male Y Connector
NPTF
p. C13



Tube to Tube Fittings

6306

Union
p. C10



6304

Union Tee
p. C10



6302

Union Elbow
p. C11



6340

Union Y
p. C11



6307

Cross
p. C13



Bulkhead Union

6316

Bulkhead Union
p. C7



Plug-In Fittings

6366

Tube Reducer
p. C11



6388

Plug-In Branch Tee
p. C12



6382

Plug-In Elbow
p. C12



6383

Plug-In Run Tee
p. C12, C13



6380

Plug-In 45° Elbow
p. C13



WARNING These products can expose you to chemicals including CARBON BLACK, or LEAD, which are known to the state of California to cause cancer.

■ **Ball Valves**

VME
Male Elbow
p. C14



VUC
Union Connector
p. C14



VFE
Female Elbow
p. C15



VEU
Elbow Union
p. C15



VMC
Male Connector
p. C15



VFC
Female Connector
p. C15



VUCPB
Valve Union
Connector
p. C16



BVC
Ball Valve Clip
p. C16



VAS
Valve Angle Stop
p. C16



■ **Accessories**

6351
End Cap
p. C12



6326
Plug
p. C13



6322
Barbed Connector
p. C13



 **WARNING** These products can expose you to chemicals including CARBON BLACK, or LEAD, which are known to the state of California to cause cancer.

[Click here for CADs, Product Specifications or to Configure Parts Online](#)

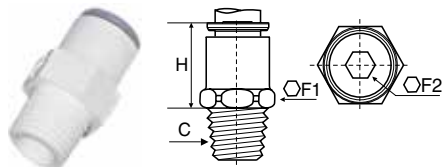

6505 Male Connector Inch Tube to NPTF

PART NO.	TUBE SIZE IN	C NPTF	F1	F2	H
6505 56 11WP2	1/4	1/8	1/2	5/32	.67
6505 56 14WP2	1/4	1/4	9/16	5/32	.67
6505 56 18WP2	1/4	3/8	3/4	1/4	.85
6505 60 11WP2	3/8	1/8	3/4	5/32	.87
6505 60 14WP2	3/8	1/4	3/4	1/4	.87
6505 60 18WP2	3/8	3/8	3/4	1/4	.87
6505 60 22WP2	3/8	1/2	15/16	1/4	1.06
6505 62 18WP2	1/2	3/8	15/16	3/8	1.10
6505 62 22WP2	1/2	1/2	15/16	3/8	1.10

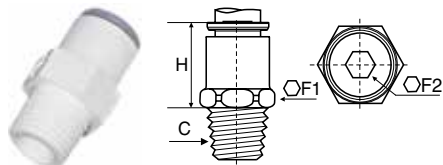

6505 Male Connector Metric Tube to BSPT

PART NO.	TUBE SIZE MM	C BSPT	F1	F2	H
6505 04 10WP2	4	1/8	11	3	18.00
6505 04 13WP2	4	1/4	14	3	18.00
6505 06 10WP2	6	1/8	11	4	18.00
6505 06 13WP2	6	1/4	14	4	18.00
6505 08 10WP2	8	1/8	17	6	20.00
6505 08 13WP2	8	1/4	17	6	20.00
6505 08 17WP2	8	3/8	17	6	20.00
6505 10 13WP2	10	1/4	17	7	21.50
6505 10 17WP2	10	3/8	19	7	21.50
6505 10 21WP2	10	1/2	22	7	21.50
6505 12 17WP2	12	3/8	19	9	24.50
6505 12 21WP2	12	1/2	22	9	24.50

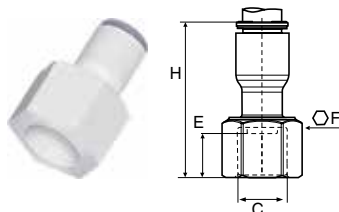

6315 Female Connector Inch Tube to NPTF

PART NO.	TUBE SIZE IN	C NPTF	E	F	H
6315 56 14WP2	1/4	1/4	14	11/16	1.18
6315 60 18WP2	3/8	3/8	14	3/16	1.42

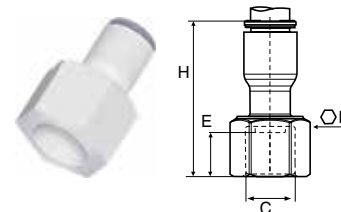

6315 Female Connector Metric Tube to BSPT

PART NO.	TUBE SIZE MM	C BSPT	E	F	H
6315 06 10WP2	6	1/8	11	13	32.00
6315 06 13WP2	6	1/4	14	16	33.00
6315 08 13WP2	8	1/4	14	16	33.50
6315 08 17WP2	8	3/8	14	20	36.00

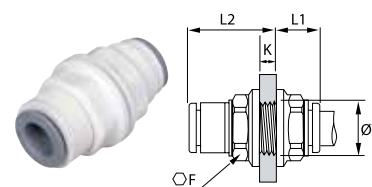

6316 Bulkhead Union Inch Tube

PART NO.	TUBE SIZE IN	F	K MAX	L1	L2	T MIN
6316 04 00WP2	5/32	.51	.22	.41	.61	.41
6316 56 00WP2	1/4	.59	.33	.39	.79	.49
6316 08 00WP2	5/16	.71	.57	.41	1.06	.61
6316 60 00WP2	3/8	.87	.57	.49	1.16	.73
6316 62 00WP2	1/2	1.41	.81	.67	1.59	1.00

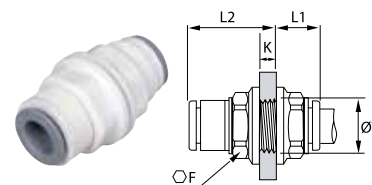

6316 Bulkhead Union Metric Tube

PART NO.	TUBE SIZE MM	F	K MAX	L1	L2	T MIN
6316 04 00WP2	4	13	5.50	10.50	15.50	10.50
6316 06 00WP2	6	15	8.50	10.00	20.00	12.50
6316 08 00WP2	8	18	14.50	10.50	27.00	15.50
6316 10 00WP2	10	22	14.50	13.00	30.00	18.50
6316 12 00WP2	12	26	18.50	15.50	35.00	22.50

WARNING These products can expose you to chemicals including CARBON BLACK, or LEAD, which are known to the state of California to cause cancer.

[Click here for CADs, Product Specifications or to Configure Parts Online](#)

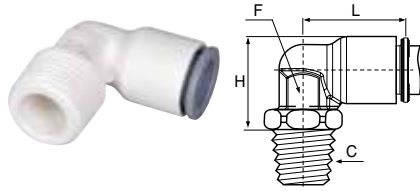

6579 Fixed Elbow Inch Tube to NPTF

PART NO.	TUBE SIZE IN	C NPTF	F	H	L
6579 56 11WP2	1/4	1/8	3/8	.54	.71
6579 56 14WP2	1/4	1/4	3/8	.54	.71
6579 56 18WP2	1/4	3/8	3/8	.54	.71
6579 60 14WP2	3/8	1/4	1/2	.77	1.02
6579 60 18WP2	3/8	3/8	1/2	.77	1.02

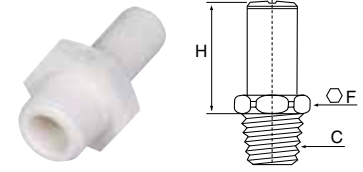

6521 Stem Adapter Inch Tube to NPTF

PART NO.	TUBE SIZE IN	C NPTF	F	H
6521 56 11WP2	1/4	1/8	1/2	.75
6521 56 14WP2	1/4	1/4	1/2	.75
6521 56 18WP2	1/4	3/8	3/4	.77
6521 60 14WP2	3/8	1/4	3/4	.98
6521 60 18WP2	3/8	3/8	3/4	.98
6521 62 18WP2	1/2	3/8	15/16	1.22
6521 62 22WP2	1/2	1/2	15/16	1.28

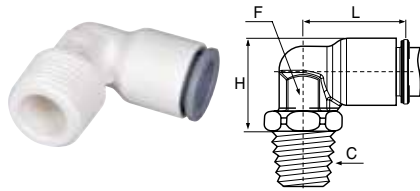

6579 Fixed Elbow Metric Tube to BSPT

PART NO.	TUBE SIZE MM	C BSPT	F	H	L
6579 06 10WP2	6	1/8	10	14	19
6579 06 13WP2	6	1/4	10	14	19
6579 06 17WP2	6	3/8	10	14	19

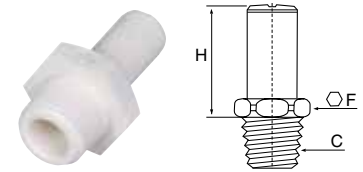

6521 Stem Adapter Metric Tube to BSPT

PART NO.	TUBE SIZE MM	C BSPT	F	H
6521 06 10WP2	6	1/8	13	19
6521 06 13WP2	6	1/4	14	19
6521 06 17WP2	6	3/8	17	19
6521 08 10WP2	8	1/8	19	23
6521 08 13WP2	8	1/4	19	23
6521 08 17WP2	8	3/8	19	23
6521 10 13WP2	10	1/4	19	25
6521 10 17WP2	10	3/8	19	25
6521 10 21WP2	10	1/2	22	25
6521 12 17WP2	12	3/8	22	28
6521 12 21WP2	12	1/2	22	28

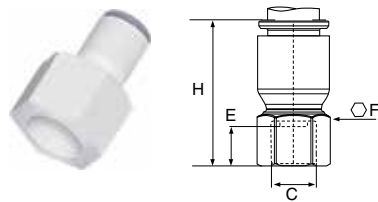

6325 Faucet Connector Inch Tube to UNS

PART NO.	TUBE SIZE IN	C UNS	E	F	H
6325 56 133WP2	1/4	7/16-24	27	9/16	1.22
6325 60 133WP2	3/8	7/16-24	27	9/16	1.26

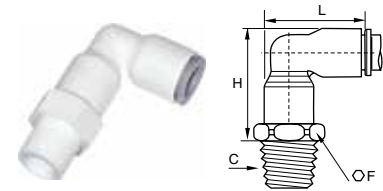

6509 Swivel Elbow Inch Tube to NPTF

PART NO.	TUBE SIZE IN	C NPTF	F	H	L
6509 56 11WP2	1/4	1/8	1/2	1.10	.93
6509 56 14WP2	1/4	1/4	9/16	1.10	.93
6509 56 18WP2	1/4	3/8	3/4	1.12	.93
6509 60 14WP2	3/8	1/4	3/4	1.50	1.34
6509 60 18WP2	3/8	3/8	3/4	1.50	1.34
6509 62 18WP2	1/2	3/8	15/16	1.99	1.83
6509 62 22WP2	1/2	1/2	15/16	1.99	1.83

WARNING These products can expose you to chemicals including CARBON BLACK, or LEAD, which are known to the state of California to cause cancer.

[Click here for CADs, Product Specifications or to Configure Parts Online](#)

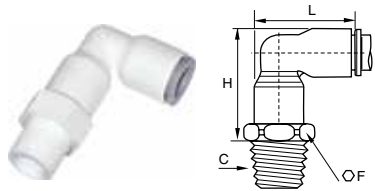

6509 Swivel Elbow Metric Tube to BSPT

PART NO.	TUBE SIZE MM	C BSPT	F	H	L
6509 06 10WP2	6	1/8	13	28	24.00
6509 06 13WP2	6	1/4	14	28	24.00
6509 06 17WP2	6	3/8	17	28	24.00
6509 08 10WP2	8	1/8	19	34	29.50
6509 08 13WP2	8	1/4	19	34	29.50
6509 08 17WP2	8	3/8	19	34	29.50
6509 10 13WP2	10	1/4	19	38	34.50
6509 10 17WP2	10	3/8	19	38	34.50
6509 10 21WP2	10	1/2	22	38	34.50
6509 12 17WP2	12	3/8	22	44	40.00
6509 12 21WP2	12	1/2	22	44	40.00

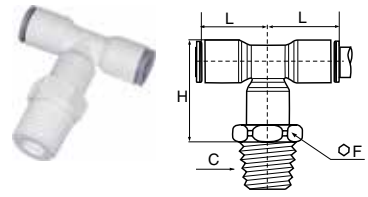

6508 Swivel Branch Tee Metric Tube to BSPT

PART NO.	TUBE SIZE MM	C BSPT	F	H	L
6508 06 10WP2	6	1/8	13	28.00	18.00
6508 06 13WP2	6	1/4	14	28.00	18.00
6508 06 17WP2	6	3/8	17	28.00	18.00
6508 08 10WP2	8	1/8	19	34.00	23.00
6508 08 13WP2	8	1/4	19	34.00	23.00
6508 08 17WP2	8	3/8	19	34.00	23.00
6508 10 13WP2	10	1/4	19	38.00	26.50
6508 10 17WP2	10	3/8	19	38.00	26.50
6508 10 21WP2	10	1/2	22	38.00	26.50
6508 12 17WP2	12	3/8	22	44.00	31.00
6508 12 21WP2	12	1/2	22	44.00	31.00

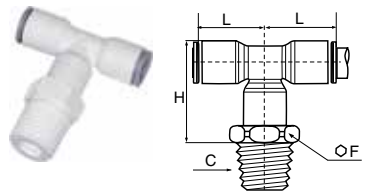

6508 Swivel Branch Tee Inch Tube to NPTF

PART NO.	TUBE SIZE IN	C NPTF	F	H	L
6508 56 11WP2	1/4	1/8	1/2	1.10	.71
6508 56 14WP2	1/4	1/4	9/16	1.10	.71
6508 56 18WP2	1/4	3/8	3/4	1.10	.71
6508 60 14WP2	3/8	1/4	3/4	1.50	1.02
6508 60 18WP2	3/8	3/8	3/4	1.50	1.02
6508 62 18WP2	1/2	3/8	15/16	1.97	1.40
6508 62 22WP2	1/2	1/2	15/16	2.00	1.40

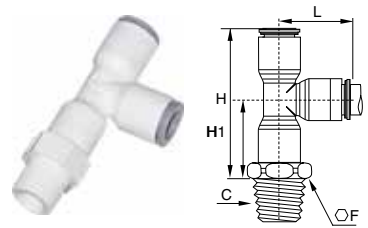

6503 Swivel Run Tee Inch Tube to NPTF

PART NO.	TUBE SIZE IN	C NPTF	F	H	H1	L
6503 56 11WP2	1/4	1/8	1/2	1.60	.88	.71
6503 56 14WP2	1/4	1/4	9/16	1.60	.88	.71
6503 56 18WP2	1/4	3/8	3/4	1.63	.90	.71
6503 60 14WP2	3/8	1/4	3/4	1.63	1.18	1.02
6503 60 18WP2	3/8	3/8	3/4	1.63	1.18	1.02
6503 62 18WP2	1/2	3/8	15/16	2.29	1.55	1.40
6503 62 22WP2	1/2	1/2	15/16	2.99	1.59	1.40

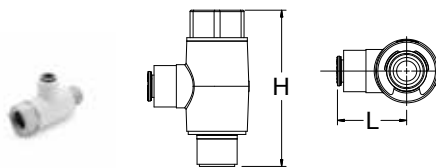

AS Angle Stop Fitting

PART NO.	TUBE SIZE IN	MALE THD.	FEMALE THD.	UNEF THD.	H	L
LFPP4AS6	1/4	3/8	3/8	9/16-24	2.17	.96

WARNING These products can expose you to chemicals including CARBON BLACK, or LEAD, which are known to the state of California to cause cancer.

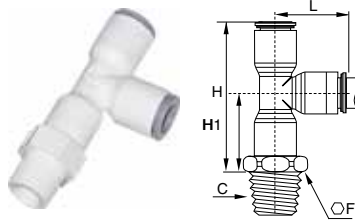
[Click here for CADs, Product Specifications or to Configure Parts Online](#)

6503 Swivel Run Tee Metric Tube to BSPT

PART NO.	TUBE SIZE MM	C BSPT	F	H	H1	L
6503 06 13WP2	6	1/4	14	40.00	22.00	18.50
6503 08 10WP2	8	1/8	19	50.00	27.00	23.00
6503 08 13WP2	8	1/4	19	50.00	27.00	23.00
6503 08 17WP2	8	3/8	19	50.00	27.00	23.00
6503 12 17WP2	12	3/8	22	65.50	34.50	31.00
6503 12 21WP2	12	1/2	22	65.50	34.50	31.00

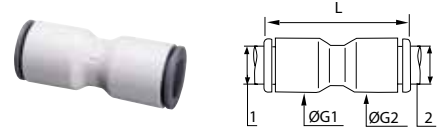

6306 Union Connector Metric Tube

PART NO.	TUBE 1 SIZE MM	TUBE 2 SIZE MM	G1	G2	L
6306 04 00WP2	4	4	8.50	8.50	26.50
6306 06 00WP2	6	6	10.50	10.50	30.00
6306 08 00WP2	8	8	13.50	13.50	37.00
6306 10 00WP2	10	10	16.00	16.00	42.00
6306 12 00WP2	12	12	19.00	19.00	50.50
6306 04 06WP2	4	6	8.50	10.50	29.00
6306 04 08WP2	4	8	13.50	13.50	37.00
6306 06 08WP2	6	8	13.50	13.50	37.00
6306 06 10WP2	6	10	16.00	16.00	42.00
6306 08 10WP2	8	10	16.00	16.00	42.00
6306 08 12WP2	8	12	19.00	19.00	50.00
6306 10 12WP2	10	12	19.00	19.00	50.00

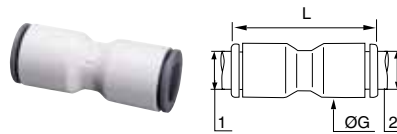

6306 Union Connector Inch Tube

PART NO.	TUBE 1 SIZE IN	TUBE 2 SIZE IN	G	L
6306 56 00WP2	1/4	1/4	.43	1.18
6306 08 00WP2	5/16	5/16	.53	1.46
6306 60 00WP2	3/8	3/8	.63	1.65
6306 62 00WP2	1/2	1/2	.87	2.24
6306 56 60WP2	1/4	3/8	.63	1.61
6306 56 08WP2	1/4	5/16	.53	1.46
6306 08 60WP2	5/16	3/8	.63	1.65
6306 08 62WP2	5/16	1/2	.87	2.16
6306 60 62WP2	3/8	1/2	.87	2.20

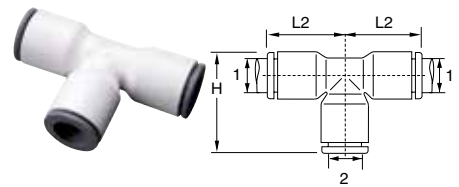

6304 Union Tee Inch Tube

PART NO.	TUBE 1 SIZE IN	TUBE 2 SIZE IN	H	L2
6304 04 00WP2	5/32	5/32	.79	.61
6304 56 00WP2	1/4	1/4	.94	.71
6304 08 00WP2	5/16	5/16	1.14	.89
6304 60 00WP2	3/8	3/8	1.34	1.02
6304 62 00WP2	1/2	1/2	1.85	1.42
6304 60 56WP2	3/8	1/4	1.34	1.02
6304 62 60WP2	1/2	3/8	1.85	1.42

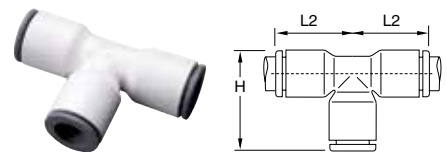

6304 Union Tee Metric Tube

PART NO.	TUBE SIZE MM	H	L2
6304 04 00WP2	4	20.00	15.50
6304 06 00WP2	6	23.00	18.00
6304 08 00WP2	8	29.00	22.50
6304 10 00WP2	10	34.50	26.50
6304 12 00WP2	12	40.00	31.00

WARNING These products can expose you to chemicals including CARBON BLACK, or LEAD, which are known to the state of California to cause cancer.

[Click here for CADs, Product Specifications or to Configure Parts Online](#)

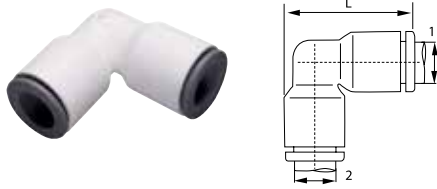

6302 Union Elbow Inch Tube

PART NO.	TUBE 1 SIZE IN	TUBE 2 SIZE IN	L
6302 04 00WP2	5/32	5/32	.75
6302 56 00WP2	1/4	1/4	.94
6302 08 00WP2	5/16	5/16	1.16
6302 60 00WP2	3/8	3/8	1.34
6302 62 00WP2	1/2	1/2	1.83
6302 56 08WP2	1/4	5/16	1.16
6302 08 60WP2	5/16	3/8	1.34
6302 56 60WP2	3/8	1/4	1.30
6302 60 62WP2	3/8	1/2	1.83

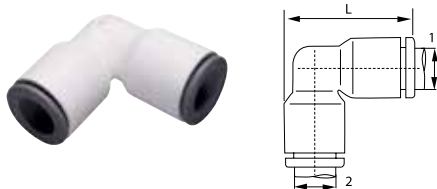

6302 Union Elbow Metric Tube

PART NO.	TUBE 1 SIZE MM	TUBE 2 SIZE MM	L
6302 04 00WP2	4	4	19.50
6302 06 00WP2	6	6	24.00
6302 08 00WP2	8	8	29.50
6302 10 00WP2	10	10	34.50
6302 12 00WP2	12	12	40.50
6302 04 06WP2	4	6	24.00
6302 06 08WP2	6	8	29.50
6302 08 10WP2	8	10	34.50
6302 10 12WP2	10	12	40.50

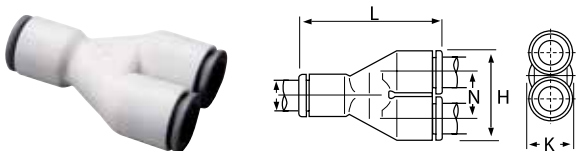

6340 Union Y Connector Inch Tube

PART NO.	TUBE SIZE IN	H	K	L	N
6340 04 00WP2	5/32	.69	.33	1.18	.35
6340 56 00WP2	1/4	.87	.43	1.42	.45
6340 08 00WP2	5/16	1.10	.53	1.75	.57
6340 60 00WP2	3/8	1.30	.63	2.08	.67
6340 62 00WP2	1/2	1.77	.87	2.64	.91

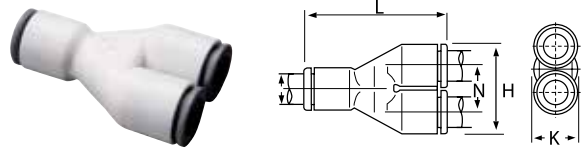

6340 Union Y Connector Metric Tube

PART NO.	TUBE SIZE MM	H	K	L	N
6340 04 00WP2	4	17.50	8.50	30.00	9.00
6340 06 00WP2	6	21.50	10.50	36.50	11.00
6340 08 00WP2	8	28.00	13.50	44.50	14.50
6340 10 00WP2	10	33.00	16.00	53.00	17.00
6340 12 00WP2	12	39.00	19.00	60.50	20.00

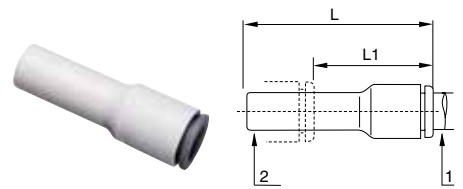

6366 Reducer Inch Tube to Stem

PART NO.	TUBE 1 SIZE IN	TUBE 2 SIZE IN	L	L1
6366 56 08WP2	1/4	5/16	1.61	.89
6366 56 60WP2	1/4	3/8	1.61	.81
6366 08 60WP2	5/16	3/8	1.91	1.14
6366 08 62WP2	5/16	1/2	1.91	.87
6366 60 62WP2	3/8	1/2	2.01	1.18

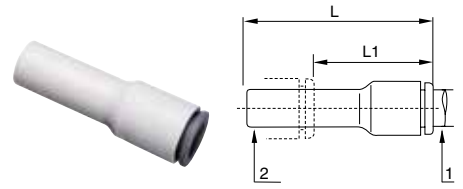

6366 Reducer Metric Tube to Stem

PART NO.	TUBE 1 SIZE MM	TUBE 2 SIZE MM	L	L1
6366 04 06WP2	4	6	38.00	23.50
6366 04 08WP2	4	8	38.00	19.00
6366 06 08WP2	6	8	38.00	20.00
6366 06 10WP2	6	10	39.00	17.50
6366 08 10WP2	8	10	48.50	28.50
6366 08 12WP2	8	12	48.50	24.50
6366 10 12WP2	10	12	52.00	33.50
6366 10 14WP2	10	14	53.00	33.50
6366 12 14WP2	12	14	55.50	33.50

WARNING These products can expose you to chemicals including CARBON BLACK, or LEAD, which are known to the state of California to cause cancer.

[Click here for CADs, Product Specifications or to Configure Parts Online](#)

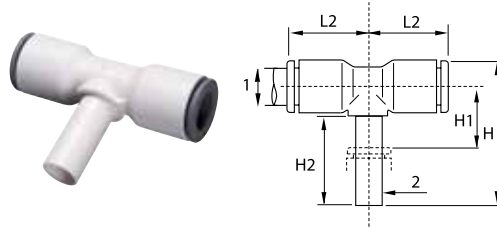

6388 Plug-In Tee Inch Tube to Stem

PART NO.	TUBE 1 SIZE IN	TUBE 2 SIZE IN	H	H1	H2	L2
6388 56 00WP2	1/4	1/4	1.20	.43	.79	.71
6388 08 00WP2	5/16	5/16	1.32	.31	.85	.90
6388 60 00WP2	3/8	3/8	1.65	.49	.98	.98
6388 62 00WP2	1/2	1/2	2.01	.51	1.14	1.26

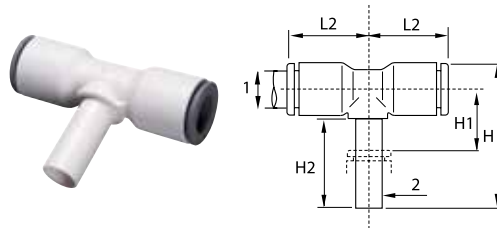

6388 Plug-In Tee Metric Tube to Stem

PART NO.	TUBE 1 SIZE MM	TUBE 2 SIZE MM	H	H1	H2	L2
6388 04 00WP2	4	4	25.00	6.00	15.50	15.00
6388 06 00WP2	6	6	28.50	7.00	17.00	16.00
6388 08 00WP2	8	8	33.50	8.00	21.50	23.00
6388 10 00WP2	10	10	41.00	9.50	24.50	26.50

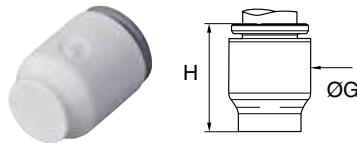

6351 End Stop Inch Tube

PART NO.	TUBE SIZE IN	G	H
6351 04 00WP2	5/32	.33	.59
6351 56 00WP2	1/4	.43	.63
6351 08 00WP2	5/16	.53	.85
6351 60 00WP2	3/8	.63	.88

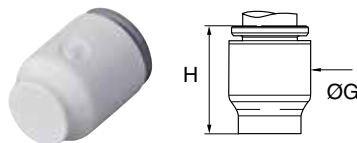

6351 End Stop Metric Tube

PART NO.	TUBE SIZE MM	G	H
6351 04 00WP2	4	8.50	15.00
6351 06 00WP2	6	10.50	17.00
6351 08 00WP2	8	13.50	21.50
6351 10 00WP2	10	16.00	22.00
6351 12 00WP2	12	19.00	27.50

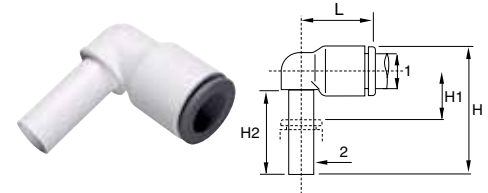

6382 Plug-In Elbow Inch Tube to Stem

PART NO.	TUBE 1 SIZE IN	TUBE 2 SIZE IN	H	H1	H2	L
6382 56 00WP2	1/4	1/4	1.20	.43	.71	.71
6382 08 00WP2	5/16	5/16	1.32	.31	.85	.88
6382 60 00WP2	3/8	3/8	1.53	.35	.96	1.04
6382 56 60WP2	1/4	3/8	1.93	.51	1.12	1.42
6382 60 56WP2	3/8	1/4	1.26	.43	.71	1.04

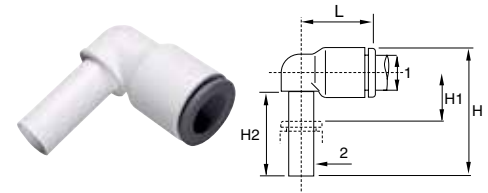

6382 Plug-In Elbow Metric Tube to Stem

PART NO.	TUBE 1 SIZE MM	TUBE 2 SIZE MM	H	H1	H2	L
6382 04 00WP2	4	4	23.00	6.00	15.50	15.00
6382 06 00WP2	6	6	26.50	7.00	17.00	17.00
6382 08 00WP2	8	8	33.00	8.00	21.50	22.50
6382 10 00WP2	10	10	39.00	9.50	24.50	26.50
6382 12 00WP2	12	12	44.50	10.00	27.00	31.00
6382 04 06WP2	4	6	26.50	7.00	17.00	16.50
6382 06 04WP2	6	4	25.00	7.00	15.50	17.00
6382 06 08WP2	6	8	33.50	8.00	21.50	22.50
6382 08 10WP2	8	10	39.00	9.50	24.50	26.00
6382 10 12WP2	10	12	44.50	10.00	27.00	30.00

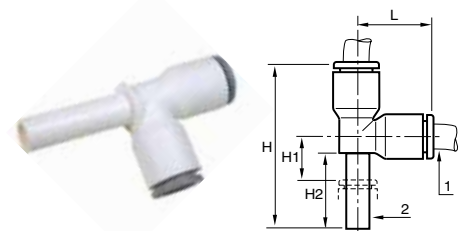

6383 Plug-In Run Tee Inch Tube to Stem

PART NO.	TUBE 1 SIZE IN	TUBE 2 SIZE IN	H	H1	H2	L
6383 56 00WP2	1/4	1/4	1.20	.43	.71	.71
6383 60 00WP2	3/8	3/8	2.24	.43	.96	1.04
6383 62 00WP2	1/2	1/2	1.93	.71	1.12	1.42

WARNING These products can expose you to chemicals including CARBON BLACK, or LEAD, which are known to the state of California to cause cancer.

[Click here for CADs, Product Specifications or to Configure Parts Online](#)

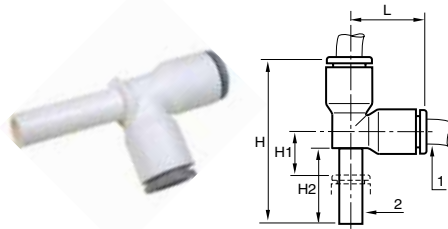

6383 Plug-In Run Tee Metric Tube to Stem

PART NO.	TUBE 1 SIZE MM	TUBE 2 SIZE MM	H	H1	H2	L
6383 04 00WP2	4	4	33.00	6.00	15.50	15.00
6383 06 00WP2	6	6	38.50	7.00	17.00	18.00
6383 08 00WP2	8	8	49.00	8.00	21.50	23.00
6383 10 00WP2	10	10	57.00	10.50	25.50	26.50

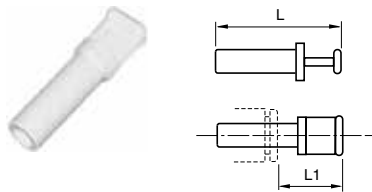

6326 Plug Inch

PART NUMBER	STEM SIZE IN	L	L1
6326 56 00WP2	1/4	1.44	.87
6326 08 00WP2	5/16	1.38	.69
6326 60 00WP2	3/8	1.67	.87
6326 62 00WP2	1/2	1.91	.85

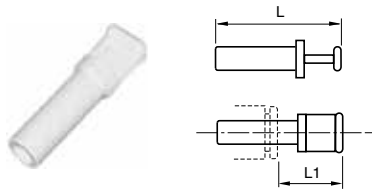

6326 Plug Metric

PART NUMBER	STEM SIZE MM	L	L1
6326 04 00WP2	4	30	15.5
6326 06 00WP2	6	33	16.5
6326 08 00WP2	8	33	17.5
6326 10 00WP2	10	42	21.0
6326 12 00WP2	12	45	22.0

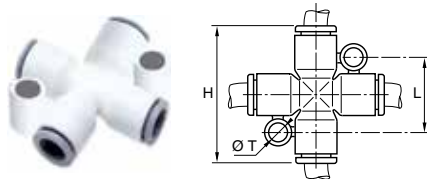

6307 Cross Metric

PART NUMBER	TUBE SIZE MM	H	L	T
6307 06 00WP2	6	46	22.5	4.2
6307 08 00WP2	8	46	22.5	4.2

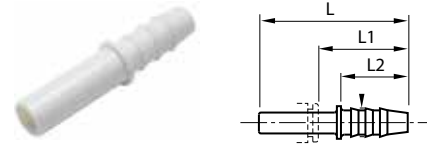

6322 Stem to Hose Barb Inch

PART NUMBER	STEM SIZE IN	HOSE BARB	L	L1	L2
6322 56 56WP2	1/4	1/4	1.65	1.00	.67
6322 60 56WP2	3/8	1/4	1.97	1.16	.87
6322 60 08WP2	3/8	5/16	1.97	1.16	.87
6322 60 60WP2	3/8	3/8	1.97	1.16	.87
6322 62 60WP2	1/2	3/8	2.05	1.30	1.07

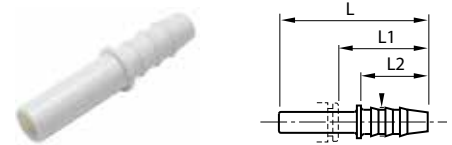

6322 Stem to Hose Barb Metric

PART NUMBER	STEM SIZE MM	HOSE BARB	L	L1	L2
6322 06 04WP2	6	4	37.0	25.0	17
6322 08 06WP2	8	6	39.5	21.0	17
6322 10 07WP2	10	7	50.0	29.5	22

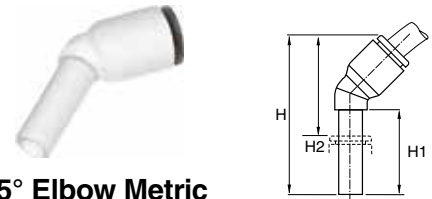

6380 Plug-in 45° Elbow Metric

PART NUMBER	TUBE SIZE MM	STEM SIZE MM	H	H1	H2
6380 04 00WP2	4	4	33.5	19.0	13.0
6380 06 00WP2	6	6	39.0	21.0	14.5
6380 08 00WP2	8	8	44.0	21.5	19.5
6380 10 00WP2	10	10	53.0	27.0	23.0
6380 12 00WP2	12	12	58.5	27.5	26.5

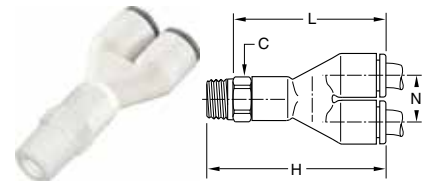

6548 Swivel Y Connector Inch Tube to NPTF

PART NUMBER	TUBE SIZE IN	NPTF	C HEX	L	H	N
6548 56 11WP2	1/4	1/8	1/2	1.59	.88	.45
6548 56 14WP2	1/4	1/4	1/2	1.59	.88	.45
6548 56 18WP2	1/4	3/8	3/4	1.62	.88	.45
6548 60 14WP2	3/8	1/4	3/4	2.24	1.30	.66
6548 60 18WP2	3/8	3/8	3/4	2.24	1.30	.66
6548 62 18WP2	1/2	3/8	15/16	2.80	1.78	.91
6548 62 22WP2	1/2	1/2	15/16	2.84	1.78	.91

WARNING These products can expose you to chemicals including CARBON BLACK, or LEAD, which are known to the state of California to cause cancer.

LIQUIfit Polypropylene Ball Valves

This range of valves offers an innovative solution in the treatment of water and the handling of beverages while protecting health. LIQUIfit's corrosion-resistant, all plastic design makes them ideal for water filtration units, coffee and beverage machines and a wide variety of other fluid applications. The polypropylene material meets all FDA and NSF-51 requirements for food contact.

Assembly Instructions:

1. Inspect the mating threads for debris or damage. Remove any old fluoropolymer tape or sealant on previously used threads. If threads are damaged, replace with new adapter before proceeding.
2. Apply 2 to 3 wraps of fluoropolymer tape, or an NSF/ FDA approved silicone sealant. Do not use Plumbers Putty or Pipe Dope. These chemically react with plastic materials and could cause a failure.
3. Align ball valve onto mating thread to ensure cross threading does not occur.
4. Screw ball valve onto mating thread 3 to 5 turns. This should be sufficient to properly seal the threads.
5. Pressurize system and check for leaks.

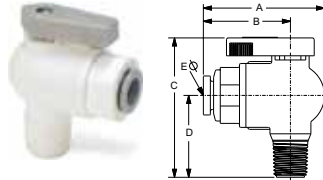

VME - Valve Male Elbow

PART NO.	NOM. TUBE O.D.	NPTF THREAD SIZE	A	B	C	D	ØE THRU HOLE MIN.
LFPP4VME2	1/4	1/8	1.74	1.21	2.00	1.10	.19
LFPP4VME4	1/4	1/4	1.74	1.21	2.18	1.28	.19
LFPP4VME6	1/4	3/8	1.74	1.21	2.18	1.28	.19
LFPP4VME8	1/4	1/2	1.74	1.21	2.37	1.47	.19
LFPP6VME2	3/8	1/8	1.85	1.32	2.00	1.10	.25
LFPP6VME4	3/8	1/4	1.85	1.32	2.18	1.28	.25
LFPP6VME6	3/8	3/8	1.85	1.32	2.18	1.28	.25
LFPP6VME8	3/8	1/2	1.85	1.32	2.37	1.47	.25
LFPP8VME8	1/2	1/2	2.73	1.74	2.38	1.47	.37

Features/Benefits:

- Full-flow self-cleaning ball maintains the cleanliness of the circuit
- Sealing technology using EPDM D seal
- High temperature, scale-resistant Polysulfone ball
- Tube retention with gripping ring prevents pumping effect
- Push-in connection and disconnection
- FDA compliant

Specifications:

- Temperature range: +35° F to +200° F (+1° C to +93° C)
- O-ring seal material: EPDM
- NSF/ANSI 51 AND 61
- Pressure rated to 150 psi

Advantages:

- Reduce costs – Built-in LIQUIfit connection eliminates the need for a secondary fitting
- Save space – Low profile design allows for easy assembly and access where space is at a premium.

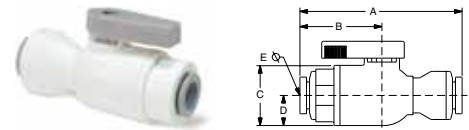

VUC - Valve Union Connector

PART NO.	1 TUBE SIZE	2 TUBE SIZE	A	B	C	D	ØE THRU HOLE MIN.
LFPP4VUC4	1/4	1/4	2.23	1.07	1.00	.50	.19
LFPP4VUC6	1/4	3/8	2.50	1.07	1.00	.50	.19
LFPP6VUC6	3/8	3/8	2.74	1.32	1.00	.50	.25
LFPP8VUC8	1/2	1/2	3.50	1.74	1.04	.52	.37

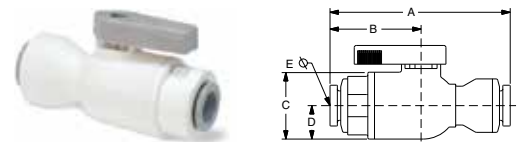

VUC - Valve Union Connector Metric

PART NO.	1 TUBE SIZE	2 TUBE SIZE	A	B	C	D	ØE THRU HOLE MIN.
LFPP6MVUC6M	6	6	2.24	.27	.36	.13	.19
LFPP8MVUC8M	8	8	2.35	.27	.36	.13	.25
LFPP10MVUC10M	10	10	2.73	.33	.36	.13	.33
LFPP12MVUC12M	12	12	3.46	.43	.36	.13	.37

NOTE: PPL refers to Polypropylene. FCB refers to Fluorocarbon.

WARNING These products can expose you to chemicals including CARBON BLACK, or LEAD, which are known to the state of California to cause cancer.

[Click here for CADs, Product Specifications or to Configure Parts Online](#)

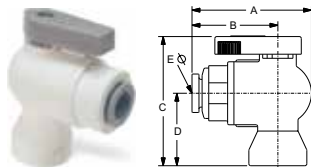

VFE - Valve Female Elbow

PART NO.	NOM. TUBE O.D.	NPTF THREAD SIZE	A	B	C	D	ØE THRU HOLE MIN.
LFPP4VFE2	1/4	1/8	1.74	1.21	1.82	.92	.19
LFPP4VFE4	1/4	1/4	1.74	1.21	2.05	1.15	.19
LFPP4VFE6	1/4	3/8	1.74	1.21	2.18	1.28	.19
LFPP6VFE2	3/8	1/8	1.85	1.32	1.82	.92	.25
LFPP6VFE4	3/8	1/4	1.85	1.32	2.05	1.15	.25
LFPP6VFE6	3/8	3/8	1.85	1.32	2.18	1.28	.25

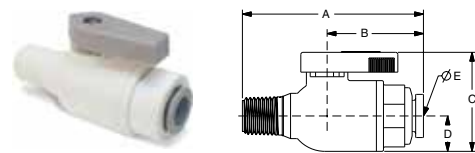

VMC - Valve Male Connector

PART NO.	NOM. TUBE O.D.	NPTF THREAD SIZE	A	B	C	D	ØE THRU HOLE MIN.
LFPP4VMC2	1/4	1/8	2.22	1.21	1.40	.50	.19
LFPP4VMC4	1/4	1/4	2.40	1.21	1.40	.50	.19
LFPP4VMC6	1/4	3/8	2.40	1.21	1.40	.50	.19
LFPP4VMC8	1/4	1/2	2.59	1.21	1.40	.50	.19
LFPP6VMC2	3/8	1/8	2.33	1.32	1.40	.50	.25
LFPP6VMC4	3/8	1/4	2.51	1.32	1.40	.50	.25
LFPP6VMC6	3/8	3/8	2.51	1.32	1.40	.50	.25
LFPP6VMC8	3/8	1/2	2.70	1.32	1.40	.50	.25
LFPP8VMC8	1/2	1/2	3.14	1.74	1.40	.50	.37

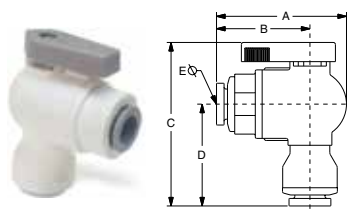

VEU - Valve Elbow Union

PART NO.	1 TUBE SIZE	2 TUBE SIZE	A	B	C	D	ØE THRU HOLE MIN.
LFPP4VEU4	1/4	1/4	1.75	1.22	2.33	1.42	.19
LFPP4VEU6	1/4	3/8	1.75	1.22	2.33	1.42	.19
LFPP6VEU4	3/8	1/4	1.83	1.30	2.32	1.40	.19
LFPP6VEU6	3/8	3/8	1.85	1.32	2.34	1.44	.25

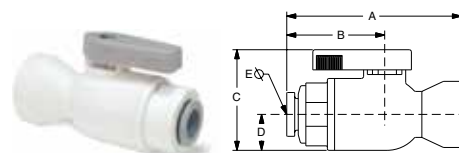

VFC - Valve Female Connector

PART NO.	NOM. TUBE O.D.	NPTF THREAD SIZE	A	B	C	D	ØE THRU HOLE MIN.
LFPP4VFC2	1/4	1/8	2.04	1.21	1.40	.50	.19
LFPP4VFC4	1/4	1/4	2.27	1.21	1.40	.50	.19
LFPP4VFC6	1/4	3/8	2.40	1.21	1.40	.50	.19
LFPP6VFC2	3/8	1/8	2.15	1.32	1.40	.50	.25
LFPP6VFC4	3/8	1/4	2.38	1.32	1.40	.50	.25
LFPP6VFC6	3/8	3/8	2.51	1.32	1.40	.50	.25

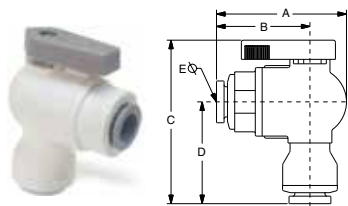

VEU - Valve Elbow Union Metric

PART NO.	1 TUBE SIZE	2 TUBE SIZE	A	B	C	D	ØE THRU HOLE MIN.
LFPP6MVEU6M	6	6	.41	.27	.55	.31	.19
LFPP8MVEU8M	8	8	.41	.28	.56	.33	.25
LFPP10MVEU10M	10	10	.48	.33	.61	.38	.33

NOTE: PPL refers to Polypropylene. FCB refers to Fluorocarbon.

WARNING These products can expose you to chemicals including CARBON BLACK, or LEAD, which are known to the state of California to cause cancer.

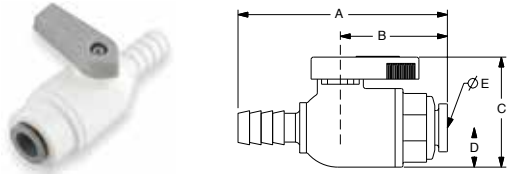

VUCPB - Valve Union Connector Barbed x Tube

PART NO.	HOSE ID	TUBE OD	OD	A	B	C	D	ØE THRU HOLE MIN.
LFPP4VUCPB4	1/4	1/4	.31	2.40	1.08	1.42	.50	.15
LFPP6VUCPB6	3/8	3/8	.43	2.63	1.32	1.42	.50	.19

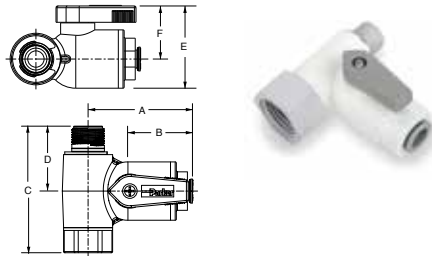

VAS - Valve Angle Stop

PART NO.	TUBE O.D.	MALE THD.	FEMALE THD.	A	B	C	D	E	F
LFPP4VAS6	1/4	3/8	3/8	1.79	1.11	2.17	1.11	1.40	.90
LFPP4VAS8	1/4	3/8	1/2	1.79	1.11	2.40	1.11	1.40	.90
LFPP6VAS6	3/8	3/8	3/8	2.03	1.35	2.17	1.11	1.40	.90
LFPP6VAS8	3/8	3/8	1/2	2.03	1.35	2.40	1.11	1.40	.90

Do not use thread sealant. Do not over tighten.

VAS Assembly Instructions:

1. Shut off water supply at brass/chrome supply valve. Disconnect riser from brass/chrome supply valve. Ensure that the sealing gasket is fully seated into the Angle Stop Valve female thread.



2. Install Angle Stop Adapter Valve on supply valve. Connect the riser to the Angle Stop Adapter Valve.



3. Fully insert tubing into the side of the valve. Open valves and check for leaks.



BVC Ball Valve Clip

BV-Clip Shown below holding VUCPB and VME

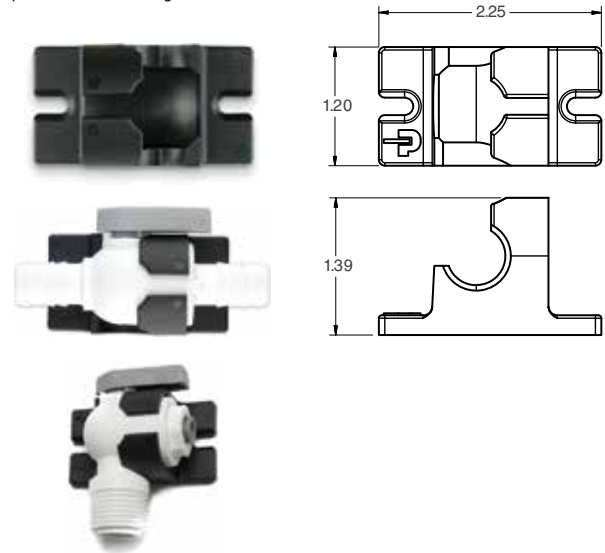

WARNING These products can expose you to chemicals including CARBON BLACK, or LEAD, which are known to the state of California to cause cancer.

TrueSeal™ Fittings



Parker's TrueSeal Fittings are lightweight, field attachable and connect to tubing without the use of tools. These all plastic push-to-connect fittings are manufactured from FDA compliant materials.

Product Features:

- Acetal and Black Polypropylene (EPDM seals and metal gripping collet standard)
- White Polypropylene (EPDM seals and plastic gripping collet standard)
- Black Kynar (Fluorocarbon (FKM) seals and black kynar metal gripping collet standard)
- Gripping ring with stainless steel bite edge or with an engineered thermoplastic bite edge
- FDA compliant, NSF/ANSI 51
- Gray acetal NSF/ANSI 61

Markets:

- Food
- Potable Water
- Chemical
- Filtration

Applications:

- Air
- Water
- Soft Drinks
- Beer
- Wine
- Dyes

Specifications:

Pressure Range

Acetal and Kynar: 1/4", 5/16", 3/8" Vacuum to 300 PSI (20.7 bar)
1/2" Vacuum to 250 PSI (17.2 bar)

Polypropylene: 1/4", 3/8", 1/2" Vacuum to 150 PSI (10.3 bar)

*Vacuum rating to 28 inches of Hg at room temperature

Temperature Range

Acetal: -20° to +180° F (-28.9° to +82.2° C)

Polypropylene: 0° to +225° F (-17.8° to +107.2° C)

Kynar: 0° to +275° F (-17.8° to +135° C)

Compatible Tubing:

- Polyethylene
- Polypropylene**
- Nylon**
- Vinyl*
- Fluoropolymer**
- Polyurethane*
- *Kynar®

* Registered trademark of The Arkema Group.

** Metal gripper required (-MG & -HBLK suffix)

+ Tube Support required.

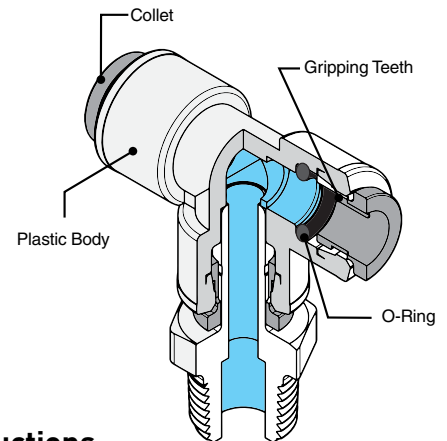

Assembly Instructions

1. Cut tubing square and clean.
(Use a Parker plastic tube cutter, Part No. PTC.)
2. Mark from end of tube length of insertion (see table below).
3. Push tube into the fitting until it bottoms out.
4. To remove, depress collet and pull tubing out.

For Threaded Connections:

5. Inspect the mating threads for debris or damage. Remove any old fluoropolymer tape or sealant on previously used threads. If threads are damaged, replace with new adapter before proceeding.
6. Apply 1 to 2 wraps of Teflon tape to the male pipe threads, or an NSF/FDA approved silicon sealant. Do not use plumbers putty or pipe dope. These chemically react with plastic materials and could cause a failure.
7. Screw together until finger tight (approximately three turns)
8. To ensure seal continue 1 to 2 more turns past finger tight.
9. Total number of turns from start to finish need not exceed 5 turns.

TUBE SIZE	O.D. TOLERANCE	INSERTION DEPTH
5/32	±.005	9/16
1/4	±.005	11/16
5/16	±.005	13/16
3/8	±.005	3/4
1/2	±.005	7/8

Threaded Fittings

MC

Male Connector
NPTF
p. C19



FA

Faucet Adapter
UNS
p. C20



MES

Male Elbow Swivel
NPTF
p. C20



MRS

Male Run Tee
Swivel – NPTF
p. C20



MTS

Male Branch Tee
Swivel
NPTF
p. C21



FC

Female Connector
NPTF
p. C22



TMC

Male Standpipe
NPTF
p. C22



ME

Male Elbow
NPTF
p. C23



FF

45° Female Flare
p. C24



ST

Straight Thread
p. C24



FE

Female Elbow
NPTF
p. C25



Tube to Tube Fittings

EU

Union Elbow
p. C19



TU

Union Tee
p. C19



UC

Union
p. C21



WY

Union Y
p. C21



CU

Cross
p. C24



Bulkhead Union

BU

Bulkhead Union
p. C22



Plug-In Fittings

TEU

Tube Elbow Union
p. C23



RD

Tube Reducer
p. C23



Check Valves

VC

Check Valve
p. C27



MCVC

Kynar Check Valve
p. C27



Accessories

TCB

Barbed Connector
p. C24



TFA

Faucet Adapter
p. C24



TAF

Faucet Adapter
p. C24



CAP

Cap
p. C24



TPL

Plug
p. C25



TEB

Barbed Connector
p. C25



TSC

Cartridge
p. C26



SC

Safety Clip
p. C30



TS

Tube Support
p. C30



AQRT

Release Tool
p. C30



Ball Valves

VME

Male Elbow
p. C28



VFE

Female Elbow
p. C28



VUC

Union Connector
p. C29



VFC

Female Connector
p. C29



VEU

Elbow Union
p. C29



VMC

Male Connector
p. C29



VTEU

Elbow Union
p. C30



[Click here for CADs, Product Specifications or to Configure Parts Online](#)

MC - Male Connector

Tube-to-Pipe

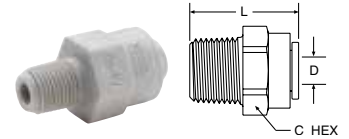

GRAY ACETAL EPDM SEAL	BLACK PPL EPDM SEAL	WHITE PPL EPDM SEAL	BLACK KYNAR FKM SEAL	NOM TUBE O. D.	NPTF THREAD SIZE	C HEX	L OVERALL LENGTH	FLOW DIA. D
A4MC2-MG	PPB4MC2-MG	PP4MC2	FB4MC2-HBLK	1/4	1/8	11/16	1.28	.175
A4MC4-MG	PPB4MC4-MG	PP4MC4	FB4MC4-HBLK	1/4	1/4	11/16	1.14	.175
A4MC6-MG	PPB4MC6-MG	PP4MC6	FB4MC6-HBLK	1/4	3/8	11/16	1.18	.175
A5MC2-MG			FB5MC2-HBLK	5/16	1/8	13/16	1.46	.175
A5MC4-MG			FB5MC4-HBLK	5/16	1/4	13/16	1.41	.188
A5MC6-MG				5/16	3/8	13/16	1.27	.188
A6MC2-MG			FB6MC2-HBLK	3/8	1/8	13/16	1.46	.175
A6MC4-MG	PPB6MC4-MG	PP6MC4	FB6MC4-HBLK	3/8	1/4	13/16	1.41	.250
A6MC6-MG	PPB6MC6-MG	PP6MC6	FB6MC6-HBLK	3/8	3/8	13/16	1.27	.250
A6MC8-MG			FB6MC8-HBLK	3/8	1/2	15/16	1.45	.250
A8MC6-MG	PPB8MC6-MG	PP8MC6	FB8MC6-HBLK	1/2	3/8	15/16	1.65	.360
A8MC8-MG	PPB8MC8-MG	PP8MC8	FB8MC8-HBLK	1/2	1/2	15/16	1.46	.375

For nonstandard plastic collet, remove -MG suffix.

EU - Elbow Union

Tube-to-Tube

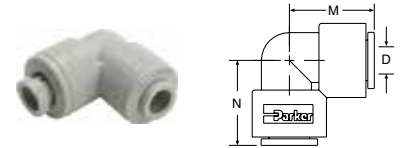

GRAY ACETAL EPDM SEAL	BLACK PPL EPDM SEAL	WHITE PPL EPDM SEAL	BLACK KYNAR FKM SEAL	NOM. TUBE O. D.	M	N	FLOW DIA. D
A4EU4-MG	PPB4EU4-MG	PP4EU4	FB4EU4-HBLK	1/4	.87	.87	.175
A5EU4-MG				5/16-1/4	1.052	.90	.175
A5EU5-MG			FB5EU5-HBLK	5/16	1.02	1.02	.188
A6EU4-MG		PP6EU4	FB6EU4-HBLK	3/8-1/4	1.02	.90	.212
A6EU5-MG				3/8-5/16	1.02	1.02	.175
A6EU6-MG	PPB6EU6-MG	PP6EU6	FB6EU6-HBLK	3/8	1.02	1.02	.250
A8EU6-MG	PPB8EU6-MG			1/2-3/8	1.20	1.20	.250
A8EU8-MG	PPB8EU8-MG	PP8EU8	FB8EU8-HBLK	1/2	1.20	1.20	.375

For nonstandard plastic collet, remove -MG suffix.

TU - Tee Union

Tube-to-Tube

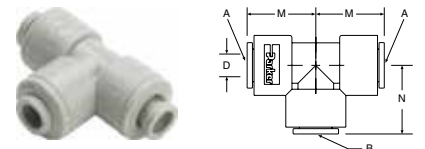

GRAY ACETAL EPDM SEAL	BLACK PPL EPDM SEAL	WHITE PPL EPDM SEAL	BLACK KYNAR FKM SEAL	NOM. TUBE O. D.		M	N	FLOW DIA. D
				TUBE A RUN	TUBE B STEM			
A4TU4-MG	PPB4TU4-MG	PP4TU4	FB4TU4-HBLK	1/4	1/4	.81	.85	.175
A5TU5-MG			FB5TU5-HBLK	5/16	5/16	1.02	1.02	.188
A6TU4-MG	PPB6TU4-MG	PP6TU4	FB6TU4-HBLK	3/8	1/4	1.02	1.03	.175
A6TU6-MG	PPB6TU6-MG	PP6TU6	FB6TU6-HBLK	3/8	3/8	1.02	1.02	.290
A8TU8-MG	PPB8TU8-MG	PP8TU8	FB8TU8-HBLK	1/2	1/2	1.20	1.20	.375

For nonstandard plastic collet, remove -MG suffix.

[Click here for CADs, Product Specifications or to Configure Parts Online](#)

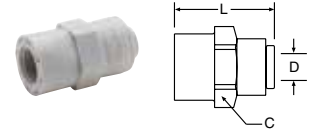

FA - Faucet Adapter

Tube-to-Faucet

GRAY ACETAL EPDM SEAL	BLACK PPL EPDM SEAL	WHITE PPL EPDM SEAL	BLACK KYNAR FKM SEAL	NOM. TUBE O.D.	UNS-2B THREAD SIZE	C HEX	L OVERALL LENGTH	FLOW DIA. D
A4FA7-MG	PPB4FA7-MG	PP4FA7	FB4FA7-HBLK	1/4	7/16-24	23/32	1.32	.190
A5FA7-MG				5/16	7/16-24	13/16	1.41	.190
A6FA7-MG	PPB6FA7-MG	PP6FA7	FB6FA7-HBLK	3/8	7/16-24	13/16	1.41	.190

For nonstandard plastic collet, remove -MG suffix.

MES - Male Elbow Swivel

Tube-to-Pipe

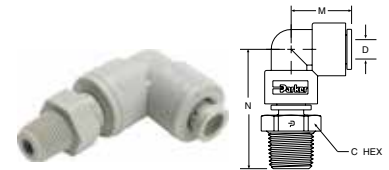

GRAY ACETAL EPDM SEAL	BLACK PPL EPDM SEAL	WHITE PPL EPDM SEAL	BLACK KYNAR FKM SEAL	NOM. TUBE O.D.	NPTF THREAD SIZE	C HEX	M	N	FLOW DIA. D
A4MES2-MG	PPB4MES2-MG	PP4MES2	FB4MES2-HBLK	1/4	1/8	9/16	.87	1.60	.175
A4MES4-MG	PPB4MES4-MG	PP4MES4	FB4MES4-HBLK	1/4	1/4	11/16	.87	1.71	.175
A4MES6-MG		PP4MES6	FB4MES6-HBLK	1/4	3/8	13/16	.90	1.91	.212
A5MES2-MG				5/16	1/8	9/16	1.02	1.78	.188
A5MES4-MG				5/16	1/4	11/16	1.02	1.90	.188
A5MES6-MG				5/16	3/8	13/16	1.02	1.90	.188
A6MES2-MG			FB6MES2-HBLK	3/8	1/8	9/16	1.02	1.65	.175
A6MES4-MG	PPB6MES4-MG	PP6MES4	FB6MES4-HBLK	3/8	1/4	13/16	1.02	1.90	.250
A6MES6-MG	PPB6MES6-MG	PP6MES6	FB6MES6-HBLK	3/8	3/8	13/16	1.02	1.90	.250
A8MES4-MG				1/2	1/4	13/16	1.20	2.10	.240
A8MES6-MG		PP8MES6		1/2	3/8	13/16	1.20	2.10	.375
A8MES8-MG		PP8MES8		1/2	1/2	1	1.20	2.32	.375

* Part consists of elbow union and tube stem adaptor.

Note: Assemblies with metal gripper collets are permanent. Assemblies with plastic collets can be taken apart.

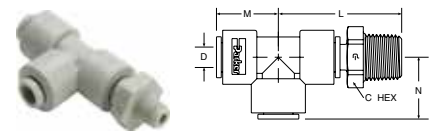

MRS - Male Run Tee Swivel

Tube-to-Pipe

GRAY ACETAL EPDM SEAL	BLACK PPL EPDM SEAL	WHITE PPL EPDM SEAL	BLACK KYNAR FKM SEAL	NOM. TUBE O.D.	NPTF THREAD SIZE	C HEX	L	M	N	D THRU HOLE MIN.
A4MRS2-MG	PPB4MRS2	PP4MRS2	FB4MRS2-HBLK	1/4	1/8	9/16	1.55	.81	0.85	.175
A4MRS4-MG	PPB4MRS4-MG	PP4MRS4	FB4MRS4-HBLK	1/4	1/4	11/16	1.67	.81	0.85	.175
A5MRS2-MG				5/16	1/8	9/16	1.78	1.02	1.02	.188
A5MRS4-MG				5/16	1/4	11/16	1.90	1.02	1.02	.188
A5MRS6-MG				5/16	3/8	13/16	1.90	1.02	1.02	.188
A6MRS4-MG	PPB6MRS4-MG	PP6MRS4	FB6MRS4-HBLK	3/8	1/4	13/16	1.90	1.02	1.02	.250
A6MRS6-MG	PPB6MRS6-MG	PP6MRS6	FB6MRS6-HBLK	3/8	3/8	13/16	1.90	1.02	1.02	.250
A8MRS4-MG				1/2	1/4	13/16	2.10	1.20	1.20	.240
A8MRS6-MG		PP8MRS6		1/2	3/8	13/16	2.10	1.20	1.20	.375
A8MRS8-MG		PP8MRS8		1/2	1/2	1	2.32	1.20	1.20	.375

*Part consists of tee union and tube stem adaptor.

Note: Assemblies with metal gripper collets are permanent. Assemblies with plastic collets can be taken apart.

[Click here for CADs, Product Specifications or to Configure Parts Online](#)

MTS - Male Tee Swivel

Tube-to-Pipe

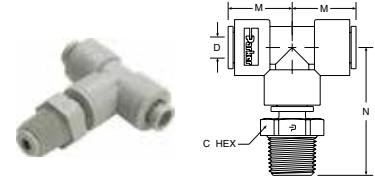

GRAY ACETAL EPDM SEAL	BLACK PPL EPDM SEAL	WHITE PPL EPDM SEAL	BLACK KYNAR FKM SEAL	NOM. TUBE O.D.	NPTF THREAD SIZE	C HEX	M	N	FLOW DIA. D
A4MTS2-MG	PPB4MTS2	PP4MTS2	FB4MTS2-HBLK	1/4	1/8	9/16	.81	1.60	.175
A4MTS4-MG	PPB4MTS4-MG	PP4MTS4	FB4MTS4-HBLK	1/4	1/4	11/16	.81	1.71	.175
A5MTS2-MG				5/16	1/8	9/16	1.02	1.78	.188
A5MTS4-MG				5/16	1/4	11/16	1.02	1.90	.188
A5MTS6-MG				5/16	3/8	13/16	1.02	1.90	.188
A6MTS2-MG			FB6MTS2-HBLK	3/8	1/8	9/16	1.02	1.75	.175
A6MTS4-MG	PPB6MTS4-MG	PP6MTS4	FB6MTS4-HBLK	3/8	1/4	13/16	1.02	1.90	.250
A6MTS6-MG	PPB6MTS6-MG	PP6MTS6	FB6MTS6-HBLK	3/8	3/8	13/16	1.02	1.90	.250
A8MTS4-MG				1/2	1/4	13/16	1.20	2.10	.240
A8MTS6-MG		PP8MTS6		1/2	3/8	13/16	1.20	2.10	.375
A8MTS8-MG		PP8MTS8		1/2	1/2	1	1.20	2.32	.375

* Part consists of tee union and tube stem adaptor.
 Note: Assemblies with metal gripper collets are permanent. Assemblies with plastic collets can be taken apart.

UC - Union Connector

Tube-to-Tube

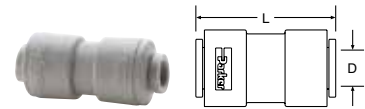

GRAY ACETAL EPDM SEAL	BLACK PPL EPDM SEAL	WHITE PPL EPDM SEAL	BLACK KYNAR FKM SEAL	NOM. TUBE O.D.	L OVERALL LENGTH	FLOW DIA. D
A4UC4-MG	PPB4UC4-MG	PP4UC4	FB4UC4-HBLK	1/4	1.49	.175
A5UC4-MG				5/16-1/4	1.70	.175
A5UC5-MG			FB5UC5-HBLK	5/16	1.70	.188
A6UC4-MG	PPB6UC4-MG	PP6UC4	FB6UC4-HBLK	3/8-1/4	1.70	.175
A6UC5-MG				3/8-5/16	1.70	.188
A6UC6-MG	PPB6UC6-MG	PP6UC6	FB6UC6-HBLK	3/8	1.70	.250
A8UC5-MG				1/2-5/16	1.90	.188
A8UC6-MG	PPB8UC6-MG	PP8UC6	FB8UC6-HBLK	1/2-3/8	1.90	.250
A8UC8-MG	PPB8UC8-MG	PP8UC8	FB8UC8-HBLK	1/2	1.91	.375

For nonstandard plastic collet, remove -MG suffix.

WY - "Y" Union

Tube-to-Tube

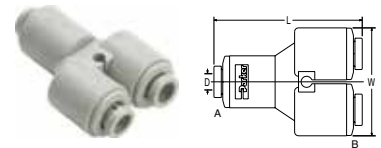

GRAY ACETAL EPDM SEAL	WHITE PPL EPDM SEAL	BLACK KYNAR FKM SEAL	NOM. TUBE O.D.		L	W	FLOW DIA. D
			INLET TUBE A RUN	OUTLET TUBE B STEM			
		FB4WY4-HBLK	1/4	1/4	2.100	1.43	.190
A5WY5-MG		FB5WY5-HBLK	5/16	5/16	2.250	1.75	.190
A6WY4-MG		FB6WY4-HBLK	3/8	1/4	2.100	1.43	.190
A6WY5-MG			3/8	5/16	2.200	1.75	.190
A6WY6-MG		FB6WY6-HBLK	3/8	3/8	2.175	1.75	.250
		FB8WY6-HBLK	1/2	3/8	2.370	1.93	.250
		FB8WY8-HBLK	1/2	1/2	2.370	1.93	.380

[Click here for CADs, Product Specifications or to Configure Parts Online](#)

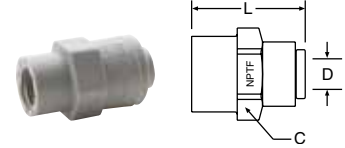

FC - Female Connector

Tube-to-Pipe

GRAY ACETAL EPDM SEAL	BLACK PPL EPDM SEAL	WHITE PPL EPDM SEAL	BLACK KYNAR FKM SEAL	NOM. TUBE O.D.	NPTF THREAD SIZE	C HEX	L OVERALL LENGTH	FLOW DIA. D
A4FC2-MG	PPB4FC2-MG	PP4FC2	FB4FC2-HBLK	1/4	1/8	11/16	1.20	.175
A4FC4-MG	PPB4FC4-MG	PP4FC4	FB4FC4-HBLK	1/4	1/4	23/32	1.32	.175
A5FC4-MG			FB5FC4-HBLK	5/16	1/4	13/16	1.41	.188
A5FC6-MG				5/16	3/8	1	1.50	.188
A6FC4-MG	PPB6FC4-MG	PP6FC4	FB6FC4-HBLK	3/8	1/4	13/16	1.41	.250
A6FC6-MG	PPB6FC6-MG	PP6FC6	FB6FC6-HBLK	3/8	3/8	1	1.50	.250
A6FC8-MG			FB6FC8-HBLK	3/8	1/2	1-1/8	1.52	.250
A8FC6-MG		PP8FC6	FB8FC6-HBLK	1/2	3/8	1-1/8	1.60	.375
A8FC8-MG		PP8FC8	FB8FC8-HBLK	1/2	1/2	1-1/8	1.75	.375

For nonstandard plastic collet, remove -MG suffix.

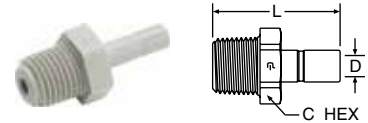

TMC - Tube Stem Adapter

Tube Stem-to-Pipe

GRAY ACETAL EPDM SEAL	BLACK PPL EPDM SEAL	WHITE PPL EPDM SEAL	BLACK KYNAR FKM SEAL	NOM. TUBE O.D.	NPTF THREAD SIZE	C HEX	L OVERALL LENGTH	FLOW DIA. D
A4TMC2	PPB4TMC2	PP4TMC2	FB4TMC2	1/4	1/8	9/16	1.44	.175
A4TMC4	PPB4TMC4	PP4TMC4	FB4TMC4	1/4	1/4	11/16	1.56	.175
A5TMC2				5/16	1/8	9/16	1.5	.188
A5TMC4			FB5TMC4	5/16	1/4	11/16	1.67	.188
A5TMC6				5/16	3/8	13/16	1.67	.188
A6TMC4	PPB6TMC4	PP6TMC4	FB6TMC4	3/8	1/4	13/16	1.70	.250
A6TMC6	PPB6TMC6	PP6TMC6	FB6TMC6	3/8	3/8	13/16	1.70	.250
A8TMC4				1/2	1/4	13/16	1.82	.240
A8TMC6		PP8TMC6	FB8TMC6	1/2	3/8	13/16	1.82	.375
A8TMC8		PP8TMC8	FB8TMC8	1/2	1/2	1	2.04	.375

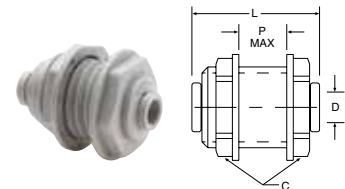

BU - Bulkhead Union

Tube-to-Tube

GRAY ACETAL EPDM SEAL	BLACK PPL EPDM SEAL	WHITE PPL EPDM SEAL	BLACK KYNAR FKM SEAL	NOM. TUBE O.D.	C1 HEX	C2 HEX	L OVERALL LENGTH	P MAX. WALL THICKNESS	FLOW DIA. D	BKHD HOLE DRILL SIZE
A4BU4-MG	PPB4BU4-MG	PP4BU4	FB4BU4-HBLK	1/4	15/16	15/16	1.50	.50	.175	7/8
A5BU5-MG			FB5BU5-HBLK	5/16	1-1/16	1-1/16	1.75	.62	.188	1
A6BU4-MG	PPB6BU4-MG	PP6BU4	FB6BU4-HBLK	3/8-1/4	1-1/16	1-1/16	1.75	.62	.175	1
A6BU6-MG	PPB6BU6-MG	PP6BU6	FB6BU6-HBLK	3/8	1-1/16	1-1/16	1.75	.62	.250	1
A8BU8-MG			FB8BU8-HBLK	1/2	1-1/4	1-1/4	2.04	.70	.375	1-1/8

For nonstandard plastic collet, remove -MG suffix.

[Click here for CADs, Product Specifications or to Configure Parts Online](#)

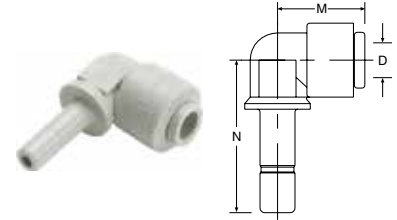

TEU - Tube Elbow Union

Tube-to-Tube Stem

GRAY ACETAL EPDM SEAL	BLACK PPL EPDM SEAL	WHITE PPL EPDM SEAL	BLACK KYNAR FKM SEAL	NOM. TUBE O.D.	TUBE STEM O.D.	M	N	FLOW DIA. D
A4TEU4-MG	PPB4TEU4-MG	PP4TEU4	FB4TEU4-HBLK	1/4	1/4	.84	1.21	.125
A4TEU6-MG			FB4TEU6-HBLK	1/4	3/8	.84	1.35	.125
A5TEU5-MG			FB5TEU5-HBLK	5/16	5/16	1.03	1.40	.188
A6TEU4-MG			FB6TEU4-HBLK	3/8	1/4	1.03	1.29	.125
A6TEU6-MG	PPB6TEU6	PP6TEU6	FB6TEU6-HBLK	3/8	3/8	1.03	1.64	.250
A8TEU8-MG	PPB8TEU8-MG	PP8TEU8	FB8TEU8-HBLK	1/2	1/2	1.21	1.64	.380

For nonstandard plastic collet, remove -MG suffix.

RD - Tube Reducer

Tube-to-Tube Stem

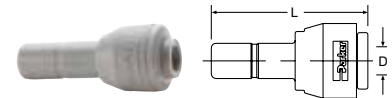

GRAY ACETAL EPDM SEAL	BLACK PPL EPDM SEAL	WHITE PPL EPDM SEAL	BLACK KYNAR FKM SEAL	NOM. TUBE O.D.	TUBE STEM O.D.	L	FLOW DIA. D
A4RD5-MG		PP4RD5		1/4	5/16	1.62	.18
A4RD6-MG	PPB4RD6-MG	PP4RD6	FB4RD6-HBLK	1/4	3/8	1.62	.18
A5RD6-MG				5/16	3/8	1.78	.25
A5RD8-MG				5/16	1/2	1.90	.25
A6RD8-MG			FB6RD8-HBLK	3/8	1/2	1.90	.25

For nonstandard plastic collet, remove -MG suffix.

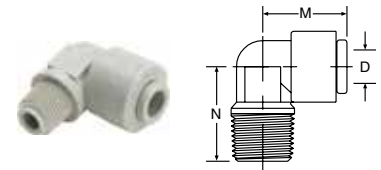

ME - Male Elbow

Tube-to-Pipe

GRAY ACETAL EPDM SEAL	BLACK PPL EPDM SEAL	WHITE PPL EPDM SEAL	BLACK KYNAR FKM SEAL	NOM. TUBE O.D.	NPTF THREAD SIZE	M	N	FLOW DIA. D
A4ME2-MG	PPB4ME2-MG	PP4ME2	FB4ME2-HBLK	1/4	1/8	.84	.94	.175
A4ME4-MG	PPB4ME4-MG	PP4ME4	FB4ME4-HBLK	1/4	1/4	.84	.94	.175
A4ME6-MG	PPB4ME6-MG	PP4ME6	FB4ME6-HBLK	1/4	3/8	.84	1.04	.175
A5ME4-MG			FB5ME4-HBLK	5/16	1/4	1.03	1.08	.175
A5ME6-MG				5/16	3/8	1.03	1.06	.188
A6ME4-MG		PP6ME4	FB6ME4-HBLK	3/8	1/4	1.03	1.08	.250
A6ME6-MG	PPB6ME6-MG	PP6ME6	FB6ME6-HBLK	3/8	3/8	1.03	1.06	.250

For nonstandard plastic collet, remove -MG suffix.

[Click here for CADs, Product Specifications or to Configure Parts Online](#)

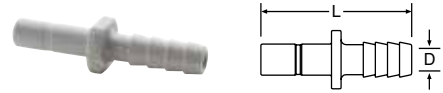

TCB - Tube-to-Barb Connector

GRAY ACETAL	BLACK PPL EPDM SEAL	WHITE POLYPROPYLENE	BLACK KYNAR FKM SEAL	TUBE STEM O.D.	TUBE I.D.	L OVERALL LENGTH	FLOW DIA. D
A4TCB4		PP4TCB4	FB4TCB4	1/4	1/4	1.67	.140
A6TCB4			FB6TCB4	3/8	1/4	1.82	.140
A6TCB6	PP6TCB6	PP6TCB6	FB6TCB6	3/8	3/8	1.98	.250
A8TCB6				1/2	3/8	2.10	.250
A8TCB8			FB8TCB8	1/2	1/2	2.10	.375

CU - Cross Union

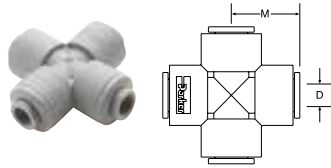

Tube-to-Tube

GRAY ACETAL EPDM SEAL	WHITE PPL EPDM SEAL	BLACK KYNAR FCB SEAL	NOM. TUBE O.D.	M	FLOW DIA. D
A4CU4-MG			1/4	.91	.175
A6CU6-MG			3/8	1.08	.250

For nonstandard plastic collet, remove -MG suffix.

TAF - Tube Faucet Adapter

(Male Thread)

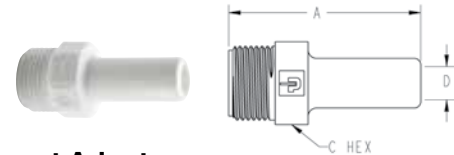

WHITE ACETAL	TUBE STEM O.D.	THREAD SIZE	A	C HEX	D MIN.
AW6TAF7-MG	3/8	7/16-24	1.41	.50	.22
AW6TAF8-MG	3/8	1/2-14 NPSM	1.65	.88	.22
AW6TAF9-MG	3/8	9/16-24	1.45	.63	.22

FF - 45° Female Flare

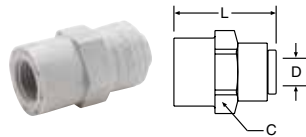

Tube-to-Flare

GRAY ACETAL EPDM SEAL	WHITE PPL EPDM SEAL	BLACK KYNAR FKM SEAL	NOM. TUBE O.D.	UNF-2B THREAD SIZE	C HEX	L OVERALL LENGTH	FLOW DIA. D
A4FF4-MG	PP4FF4	FB4FF4-HBLK	1/4	7/16-20	23/32	1.32	.190
A6FF4-MG		FB6FF4-HBLK	3/8	7/16-20	13/16	1.41	.190
A6FF6-MG	PP6FF6	FB6FF6-HBLK	3/8	5/8-18	1	1.50	.250

For nonstandard plastic collet, remove -MG suffix.

ST - Straight Thread

Tube-to-Male O-Ring Boss

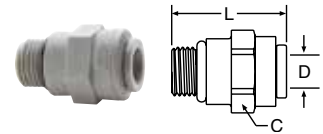

GRAY ACETAL EPDM SEAL	WHITE PPL EPDM SEAL	BLACK KYNAR FKM SEAL	NOM. TUBE O.D.	UNF-2B THD SIZE	C HEX	L OVERALL LENGTH	FLOW DIA. D
A6ST9-MG		FB6ST9-HBLK	3/8	9/16-18	13/16	1.39	.250

For nonstandard plastic collet, remove -MG suffix.

TFA - Tube Faucet Adapter

(Female Thread)

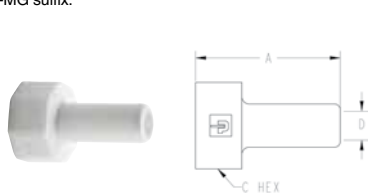

WHITE ACETAL	TUBE STEM O.D.	THREAD SIZE	A	C HEX	D MIN.
AW6TFA7-MG	3/8	7/16-24	1.25	.69	.17
AW6TFA8-MG	3/8	1/2-14 NPSM	1.45	1.06	.22
AW6TFA9-MG	3/8	9/16-24	1.25	.75	.22

CAP - Tube Cap



GRAY ACETAL EPDM SEAL	WHITE PPL EPDM SEAL	NATURAL KYNAR FKM SEAL	NOM. TUBE O.D.	L OVERALL LENGTH
A4CAP-MG	PP4CAP	FB4CAP-HBLK	1/4	.77
A6CAP-MG	PP6CAP		3/8	0.88

For nonstandard plastic collet, remove -MG suffix.

[Click here for CADs, Product Specifications or to Configure Parts Online](#)

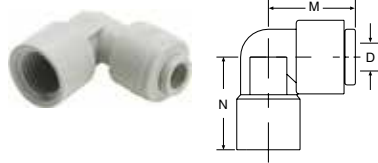

FE - Female Elbow

Tube-to-Pipe

GRAY ACETAL EPDM SEAL	WHITE PPL EPDM SEAL	BLACK KYNAR FKM SEAL	NOM. TUBE O.D.	NPTF THREAD SIZE	M	N	FLOW DIA. D
A4FE4-MG			1/4	1/4	.84	1.00	.18
A6FE4-MG			3/8	1/4	1.03	1.00	.25
A6FE6-MG			3/8	3/8	1.03	1.00	.25

For nonstandard plastic collet, remove -MG suffix.

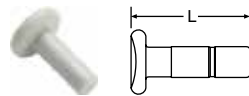

TPL - Plug

GRAY ACETAL	BLACK PPL	WHITE PPL	BLACK KYNAR	FITTING SIZE	L OVERALL LENGTH
A4TPL	PPB4TPL	PP4TPL	FB4TPL	1/4	0.88
A6TPL	PPB6TPL-MG	PP6TPL	FB6TPL	3/8	1.45
A8TPL	PPB8TPL	PP8TPL		1/2	1.50



TEB - Tube Elbow Barb Connector

GRAY ACETAL	WHITE POLYPROPYLENE	BLACK KYNAR	TUBE STEM O.D.	TUBE I.D.	M	N	FLOW DIA. D
A4TEB4	PP4TEB4	FB4TEB4	1/4	1/4	.89	1.00	.140
A6TEB4	PP6TEB4	FB6TEB4	3/8	1/4	1.335	1.055	.375
A6TEB6	PP6TEB6	FB6TEB6	3/8	3/8	1.34	1.21	.250
A8TEB8			1/2	1/2	1.30	1.30	.390



TSC - Cartridge Insert

PART NO. WITH EPDM SEAL	NOM. TUBE O.D.	A* DIAMETER ±002	B DIAMETER ±003	C DIAMETER ±003	D DIAMETER MAXIMUM	E DEPTH ±002	F DEPTH ±002	G DEPTH ±002	H* CENTERLINE OF PORTS MINIMUM
ATSC4-MG	1/4	.528	.421	.260	.19	.230	.435	.600	.670
ATSC6-MG	3/8	.632	.545	.385	.31	.280	.455	.705	.790
ATSC8-MG	1/2	.774	.668	.510	.41	.315	.510	.810	1.250

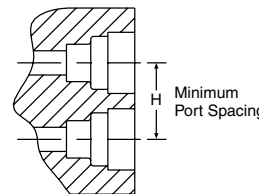
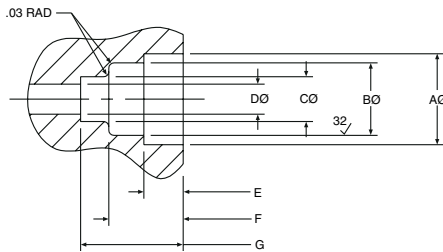

Parker TrueSeal™ Cartridge Inserts:

Allow you to machine or mold a tube connection into your equipment or components. By using cartridge inserts, you will reduce your material and assembly costs, reduce potential leak paths, and give your equipment a new, clean profile by eliminating the need for threaded connections. TSC Cartridge Inserts consist of 1 o-ring, 1 cartridge, and 1 collet.

*Cartridge inserts are rated at 150 PSI in ports dimensioned as above and having Noryl as the receiving material. Other materials may have different ratings and require different port dimensions. Consult the Fluid System Connectors Division when using polypropylene, unfilled polypropylene, ABS or Nylon.

NORYL® is a registered trademark of the General Electric Co.

Assembly Instructions:

1. Machine or mold the receiving orifice as per the above dimensions.
2. Place the cartridge insert squarely onto the prepared port opening making sure that the barbs of the cartridge are going into the hole and the lettering on the face of the cartridge is visible.
3. Using a rubber mallet or press, insert the cartridge into the first gland orifice until its face is flush with the top surface of the port.
4. Insert the o-ring into the cartridge and seat it evenly into the second gland orifice.
5. Insert the collet into the cartridge opening.
6. Insert tubing.

[Click here for CADs, Product Specifications or to Configure Parts Online](#)

TrueSeal Check Valves

Push-to-Connect check valves that ensures protection against reversal of flow. The valves have an arrow molded into the body to indicate the direction of flow. Valves are designed for connection with either thermoplastic or soft metal tubing and are intended for use with liquids only.

Materials of Construction

Body	Acetal
O-ring	EPDM
Metal Grip Edge	300 Stainless
Working Pressure	Up to 150 PSI (10.3 bar) depending on tubing being used
Temperature Range	+34° to +150° F (+1° to +65° C)
Cracking Pressure	1/3 PSI (0.02 bar)

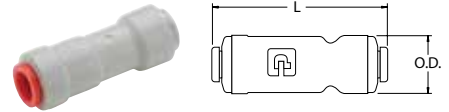

VC – Check Valve

PART NO.	TUBE SIZE	L	O.D.
A4VC4-MG	1/4	2.00	.66
A5VC5-MG	5/16	2.10	.70
A6VC6-MG	3/8	2.15	.80
A8VC8-MG	1/2	2.68	.91

PVDF Check Valves

Materials of Construction

Body	Kynar®
O-ring	Fluorocarbon
Metal Grip Edge	Stainless Steel
Working Pressure	Up to 300 PSI (20.7 bar)
Temperature Range	0° to +250° F (-17.8° to +121° C)



MCVC Kynar® Check Valves

PART NO.	TUBE O.D.	NPTF THREAD	L	C HEX	CRACKING PRESSURE PSI
FB6MCVC4-HBLK-05	3/8	1/4	1.40	13/16	.5
FB6MCVC4-HBLU-15	3/8	1/4	1.40	13/16	1.5
FB6MCVC4-HRED-30	3/8	1/4	1.40	13/16	3.0
FB6MCVC4-HGRN-40	3/8	1/4	1.40	13/16	4.0

Note: For check valve to function properly tubing needs to be installed

Polypropylene Ball Valves

For proven leak-free performance, specify Polypropylene Ball Valves. Their corrosion-resistant, all-plastic design makes them ideal for water filtration units, coffee and beverage machines and a wide variety of other fluid applications. Polypropylene material meets all FDA and NSF-51 requirements for food contact.

Features/Benefits:

- Precision molded, all-plastic design is leak free and corrosion resistant.
- Polypropylene material offers a wider chemical acceptance range, as well as a wide temperature range.
- Bi-directional flow maximizes productivity.
- Full flow design reduces pressure drop across the valve.
- Special o-ring seal ensures a reliable leak-tight connection.
- TrueSeal™ connection reduces potential leaks.

Specifications:

- Temperature range: +35° to +200°F (+2° to +93°C)
- O-ring seal material: EPDM
- NSF/ANSI 51 AND 61
- Pressure rated to 150 PSI (10.3 bar). Actual working pressures will be lower at elevated temperatures

Advantages:

- Reduce costs—Built-in TrueSeal™ connection eliminates the need for a secondary fitting.
- Save space—Low-profile design allows for easy assembly and access where space is at a premium.

VME - Valve Male Elbow

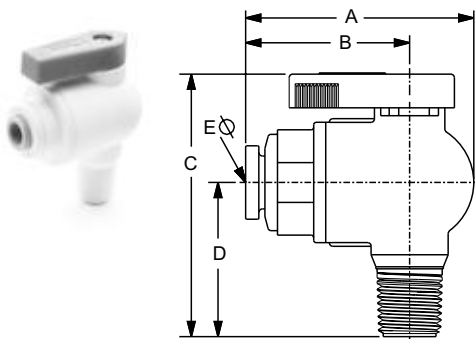

PART NUMBER	NOM. TUBE O.D.	NPTF THREAD SIZE	A	B	C	D	ØE THRU HOLE MIN.
PP4VME2-MG (+)	1/4	1/8	1.74	1.21	2.00	1.10	.19
PP4VME4-MG	1/4	1/4	1.74	1.21	2.18	1.28	.19
PP4VME6-MG	1/4	3/8	1.74	1.21	2.18	1.28	.19
PP4VME8-MG (+)	1/4	1/2	1.74	1.21	2.37	1.47	.19
PP6VME2-MG (+)	3/8	1/8	1.85	1.32	2.00	1.10	.25
PP6VME4-MG	3/8	1/4	1.85	1.32	2.18	1.28	.25
PP6VME6-MG	3/8	3/8	1.85	1.32	2.18	1.28	.25
PP6VME8-MG	3/8	1/2	1.85	1.32	2.37	1.47	.25

VFE - Valve Female Elbow

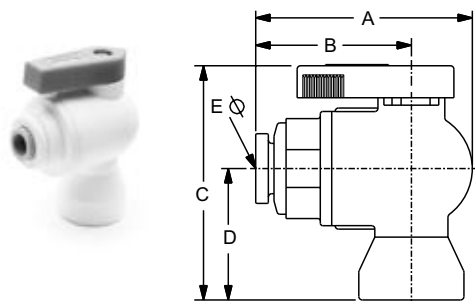

PART NUMBER	NOM. TUBE O.D.	NPTF THREAD SIZE	A	B	C	D	ØE THRU HOLE MIN.
PP4VFE2-MG (+)	1/4	1/8	1.74	1.21	1.82	.92	.19
PP4VFE4-MG	1/4	1/4	1.74	1.21	2.05	1.15	.19
PP4VFE6-MG	1/4	3/8	1.74	1.21	2.18	1.28	.19
PP6VFE2-MG (+)	3/8	1/8	1.85	1.32	1.82	.92	.25
PP6VFE4-MG	3/8	1/4	1.85	1.32	2.05	1.15	.25
PP6VFE6-MG	3/8	3/8	1.85	1.32	2.18	1.28	.25

(+) Non Standard.

[Click here for CADs, Product Specifications or to Configure Parts Online](#)

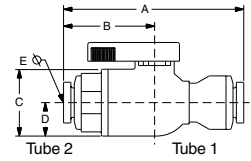

VUC - Valve Union Connector

BLACK POLYPROPYLENE	WHITE POLYPROPYLENE	1 TUBE SIZE	2 TUBE SIZE	A	B	C	D	ØE THRU HOLE MIN.
PPB4VUC4-MG	PP4VUC4-MG	1/4	1/4	2.55	1.22	1.0	.5	.19
	PP4VUC6-MG	1/4	3/8	2.55	1.22	1.0	.5	.19
	PP6VUC4-MG	3/8	1/4	2.57	1.30	1.0	.5	.19
PPB6VUC6-MG	PP6VUC6-MG	3/8	3/8	2.67	1.32	1.4	.5	.25

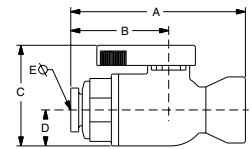

VFC - Valve Female Connector

BLACK POLYPROPYLENE	WHITE POLYPROPYLENE	NOM. TUBE O.D.	NPTF THREAD SIZE	A	B	C	D	ØE THRU HOLE MIN.
	PP4VFC2-MG	1/4	1/8	2.04	1.21	1.4	.5	.19
	PP4VFC4-MG	1/4	1/4	2.27	1.21	1.4	.5	.19
	PP4VFC6-MG	1/4	3/8	2.40	1.21	1.4	.5	.19
	PP6VFC2-MG	3/8	1/8	2.15	1.32	1.4	.5	.25
	PP6VFC4-MG	3/8	1/4	2.38	1.32	1.4	.5	.25
PPB6VFC6-MG	PP6VFC6-MG	3/8	3/8	2.51	1.32	1.4	.5	.25

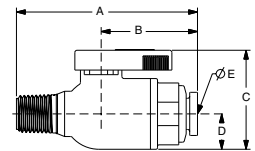
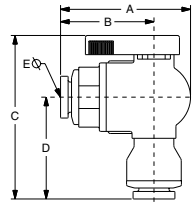

VEU - Valve Elbow Union

PART NUMBER	1 TUBE SIZE	2 TUBE SIZE	A	B	C	D	ØE THRU HOLE MIN.
PP4VEU4-MG	1/4	1/4	1.75	1.22	2.33	1.42	.19
PP4VEU6-MG	1/4	3/8	1.75	1.22	2.33	1.42	.11
PP6VEU4-MG	3/8	1/4	1.83	1.30	2.32	1.40	.19
PP6VEU6-MG	3/8	3/8	1.85	1.32	2.34	1.44	.25

VMC - Valve Male Connector

PART NUMBER	NOM. TUBE O.D.	NPTF THREAD SIZE	A	B	C	D	ØE THRU HOLE MIN.
PP4VMC2-MG (+)	1/4	1/8	2.22	1.21	1.4	.5	.19
PP4VMC4-MG	1/4	1/4	2.40	1.21	1.4	.5	.19
PP4VMC6-MG	1/4	3/8	2.40	1.21	1.4	.5	.19
PP4VMC8-MG (+)	1/4	1/2	2.59	1.21	1.4	.5	.19
PP6VMC2-MG (+)	3/8	1/8	2.33	1.32	1.4	.5	.25
PP6VMC4-MG	3/8	1/4	2.51	1.32	1.4	.5	.25
PP6VMC6-MG	3/8	3/8	2.51	1.32	1.4	.5	.25
PP6VMC8-MG (+)	3/8	1/2	2.70	1.32	1.4	.5	.25

[Click here for CADs, Product Specifications or to Configure Parts Online](#)

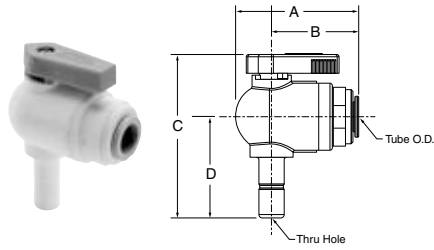

VTEU - Valve Tube Elbow Union

PART NUMBER	NOM. TUBE O.D.	STEM	A	B	C	D	ØE THRU HOLE MIN.
PP4VTEU6-MG	1/4	3/8	1.75	1.22	2.43	1.50	.17
PP6VTEU6-MG	3/8	3/8	1.83	1.30	2.43	1.50	.25



TS - Tube Supports

NYLON PART NO.	PPL PART NUMBER
N4TS3	P4TS3
N5TS3	P5TS3
N6TS4	P6TS4
N8TS6	P8TS6

To be used with soft durometer tubing.



SC - Safety Clip

(Patent No. 6,065,779)

PART NUMBER	PART NUMBER	FOR NOMINAL TUBE O.D.
SC-4	SC-4-B	1/4
SC-5	SC-5-B	5/16
SC-6	SC-6-B	3/8
SC-8	SC-8-B	1/2

AQRT - Quick Release Tool

Makes disconnection of tube adapters and tubing a breeze.



Fast & Tite® Fittings



Parker's Fast & Tite Fittings are a compression style fitting that installs in seconds without tools and provides a tight, sure, leak proof seal without clamps or adjustments. A unique grab ring for tube retention, coupled with a Nitrile o-ring creates a positive seal and assures good tube retention with only hand tight assembly.

Product Features:

- Available in white polypropylene, black polypropylene and white nylon
- 302 stainless steel grab ring
- Nitrile O-ring
- FDA compliant material
- NSF/ANSI-51

Markets:

- Water Filtration
- Beverage Dispensing
- Life Science
- Bottling
- Semi-Conductor

Applications:

- Water
- Beverages
- Food
- Cooling Systems

Compatible Tubing:

- Thermoplastic
- Soft Metal
- Glass

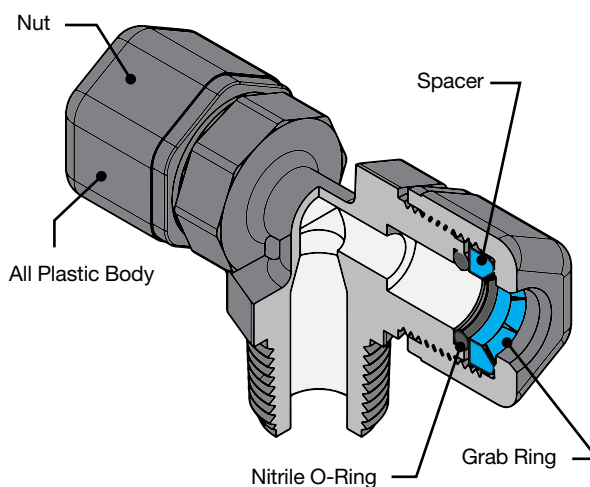

Specifications:

Air-Oil-Water Pressure in PSI (bar)

TUBE O. D. IN.	UP TO 75° F	76° TO 125° F	126° TO 175° F
1/4	300 (20.7)	300 (20.7)	300 (20.7)
5/16	300 (20.7)	300 (20.7)	300 (20.7)
3/8	250 (17.2)	250 (17.2)	150 (10.3)
1/2	200 (13.8)	200 (13.8)	150 (10.3)
5/8	150 (10.3)	100 (6.9)	50 (3.5)

Temperature Range

Nylon: -40° to +200° F (-40° to +93.3° C)

Polypropylene: 0° to +212° F (-17.8° to +100° C)

TUBE O. D. (IN.)	INSERTION LENGTH
1/4	5/8
5/16	5/8
3/8	13/16
1/2	7/8
5/8	1

Assembly Instructions

- Cut the tube squarely and remove any burrs.
- Mark from end of tube the length of insertion. If using a tube support, insert fully into tube before marking. (See insertion length table left)
- Loosen nut on fitting until three threads are visible. Fittings for glass tubes must be disassembled and the grab ring removed. If the fitting has been disassembled the components are to be placed in the following order: fitting body, o-ring, spacer, grab ring and nut. Assemble the nut until three threads are showing on the body before inserting tube.
- Moisten end of the tube with water. Push the tube Straight into fitting until it bottoms on the fitting's shoulder. Tighten nut by hand. Additional tightening should not be necessary, but 1/4 additional turn may be added if desired. Do not overtighten nut as the threads will strip and the fitting will not function properly. A proper assembly will not show the insertion mark extending beyond the nut. If the insertion mark is visible, then steps 1 thru 4 must be repeated.
- Whenever a Fast & Tite® fitting is assembled for service or reuse the stainless steel grab ring should be replaced for maximum tubing retention.

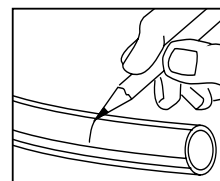
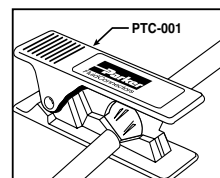

Note: Provide adequate fail-safe mechanisms such as leakage detection sensors, automatic shut-off controls or other industry and code appropriate fail-safe devices in the design of your water-handling appliance to protect against personal injury and property damage. Plastic fittings containing an o-ring have a finite life depending on the environment, media and severity of the application. Frequent inspections and replacement of the fitting when anomalies are found is recommended.

Threaded Fittings

MC

Male Connector
NPTF
p. C33



ME

Male Elbow
NPTF
p. C33



FE

Female Elbow
NPTF
p. C34



FC

Female Connector
NPTF
p. C34



MR

Male Run Tee
NPTF
p. C34



MT

Male Branch Tee
NPTF
p. C34



Tube to Tube Fittings

UC

Union
p. C33



EU

Union Elbow
p. C33



TU

Union Tee
p. C34



Bulkhead Unions

BU

Bulkhead Union
p. C34



Accessories

GR

Grab Ring
p. C35



NS

Nut & Spacer
p. C35



TS

Tube Support
p. C35



OR

O-Ring
p. C35



Ball Valves

VUC

Valve Union
Connector
p. C36



VMC

Valve Male
Connector
p. C36



VFC

Valve Female
Connector
p. C36



VFE

Valve Female
Elbow
p. C37



VME

Valve Male Elbow
p. C37



VEU

Valve Elbow Union
p. C37



[Click here for CADs, Product Specifications or to Configure Parts Online](#)

MC - Male Connector

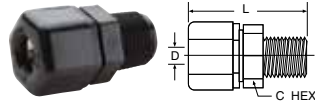

Tube to male pipe

WHITE PPL PART NO.	BLACK PPL PART NO.	WHITE NYLON PART NO.	NOM TUBE O.D.	NPTF THREAD SIZE	C HEX	L OVERALL LENGTH	FLOW DIA. D
W4MC2	P4MC2	N4MC2	1/4	1/8	11/16	1.28	.170
W4MC4	P4MC4	N4MC4	1/4	1/4	11/16	1.51	.170
W4MC6 *	P4MC6 *	N4MC6 *	1/4	3/8	11/16	.148	.170
W5MC2 *	P5MC2	N5MC2	5/16	1/8	11/16	1.38	.170
W5MC4 *	P5MC4	N5MC4	5/16	1/4	11/16	1.50	.250
W6MC2 *	P6MC2	N6MC2	3/8	1/8	13/16	1.50	.170
W6MC4	P6MC4	N6MC4	3/8	1/4	13/16	1.67	.250
W6MC6	P6MC6	N6MC6	3/8	3/8	13/16	1.67	.250
W6MC8 *	P6MC8	N6MC8	3/8	1/2	1	1.78	.250
W6MC12	P6MC12	N6MC12	3/8	3/4	1	1.84	.250
W8MC2 *	P8MC2	N8MC2	1/2	1/8	1	1.61	.170
W8MC4 *	P8MC4	N8MC4	1/2	1/4	1	1.74	.250
W8MC6	P8MC6	N8MC6	1/2	3/8	1	1.74	.375
W8MC8	P8MC8	N8MC8	1/2	1/2	1	1.87	.375
W8MC12 *	P8MC12	N8MC12	1/2	3/4	1	1.89	.375
W10MC2 *	P10MC2	N10MC2	5/8	1/8	1-1/8	1.75	.170
W10MC4 *	P10MC4	N10MC4	5/8	1/4	1-1/8	1.90	.250
W10MC6 *	P10MC6	N10MC6	5/8	3/8	1-1/8	1.90	.375
W10MC8 *	P10MC8	N10MC8	5/8	1/2	1-1/8	2.01	.500
W10MC12 *	P10MC12	N10MC12	5/8	3/4	1-1/8	2.04	.500

ME - Male Elbow

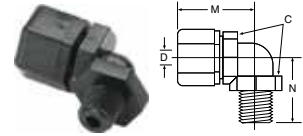

Tube to male pipe

WHITE PPL PART NUMBER	BLACK PPL PART NUMBER	WHITE NYLON PART NUMBER	NOM TUBE O.D.	NPTF THD SIZE	C HEX	M	N	FLOW DIA. D
W4ME2	P4ME2	N4ME2	1/4	1/8	3/4	1.06	0.81	.170
W4ME4	P4ME4	N4ME4	1/4	1/4	3/4	1.06	1.02	.170
W4ME6	P4ME6	N4ME6	1/4	3/8	3/4	1.06	1.02	.170
W5ME2 *	P5ME2	N5ME2	5/16	1/8	3/4	1.06	0.81	.193
W5ME4 *	P5ME4	N5ME4	5/16	1/4	3/4	1.06	1.02	.193
W5ME6 *	P5ME6	N5ME6	5/16	3/8	3/4	1.06	1.02	.193
W6ME4	P6ME4	N6ME4	3/8	1/4	7/8	1.28	1.12	.250
W6ME6	P6ME6	N6ME6	3/8	3/8	7/8	1.28	1.12	.250
W6ME8	P6ME8	N6ME8	3/8	1/2	1	1.28	1.34	.250
W6ME12 *	P6ME12	N6ME12	3/8	3/4	1-3/16	1.59	1.40	.250
W8ME4 *	P8ME4	N8ME4 *	1/2	1/4	1-1/16	1.48	1.22	.250
W8ME6	P8ME6	N8ME6	1/2	3/8	1-1/16	1.56	1.21	.375
W8ME8	P8ME8	N8ME8	1/2	1/2	1-1/16	1.56	1.34	.375
W8ME12 *	P8ME12 *	N8ME12 *	1/2	3/4	1-1/8	1.50	1.40	.375
W10ME8 *	P10ME8	N10ME8	5/8	1/2	1-3/16	1.72	1.40	.500

UC - Union Connector

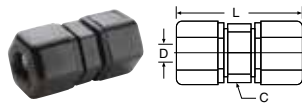

Tube to tube

WHITE PPL PART NUMBER	BLACK PPL PART NUMBER	WHITE NYLON PART NUMBER	NOM. TUBE O.D.	C HEX	L OVERALL LENGTH	FLOW DIA. D
W4UC4	P4UC4	N4UC4	1/4	11/16	1.62	.170
W5UC4 *	P5UC4	N5UC4	5/16-1/4	11/16	1.62	.170
W5UC5 *	P5UC5	N5UC5	5/16	11/16	1.62	.190
W6UC4	P6UC4	N6UC4	3/8-1/4	13/16	1.80	.170
W6UC5 *	P6UC5	N6UC5	3/8-5/16	13/16	1.80	.190
W6UC6	P6UC6	N6UC6	3/8	13/16	1.92	.250
W8UC6	P8UC6	N8UC6	1/2-3/8	1	1.95	.250
W8UC8	P8UC8	N8UC8	1/2	1	2.03	.375
W10UC6 *	P10UC6	N10UC6	5/8-3/8	1-1/8	2.19	.250
W10UC8 *	P10UC8	N10UC8	5/8-1/2	1-1/8	2.24	.375
W10UC10 *	P10UC10	N10UC10	5/8	1-1/8	2.40	.500

EU - Elbow Union

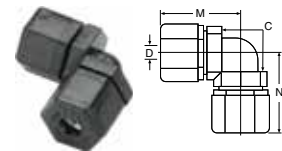

Tube to tube

WHITE PPL PART NUMBER	BLACK PPL PART NUMBER	WHITE NYLON PART NUMBER	NOM. TUBE O.D.	C HEX	M	N	FLOW DIA. D
W4EU4	P4EU4	N4EU4	1/4	3/4	1.06	1.06	.170
W5EU4 *	P5EU4	N5EU4	5/16-1/4	3/4	1.06	1.06	.170
W5EU5 *	P5EU5	N5EU5	5/16	3/4	1.06	1.06	.193
W6EU4	P6EU4	N6EU4	3/8-1/4	7/8	1.06	1.28	.170
W6EU5 *	P6EU5	N6EU5	3/8-5/16	7/8	1.06	1.28	.170
W6EU6	P6EU6	N6EU6	3/8	7/8	1.28	1.28	.250
W8EU6	P8EU6	N8EU6	1/2-3/8	1-1/16	1.37	1.56	.250
W8EU8	P8EU8	N8EU8	1/2	1-1/16	1.56	1.56	.375
W10EU10 *	P10EU10	N10EU10	5/8	1-3/16	1.72	1.72	.500

* Non-standard

BU - Bulkhead Union



Tube to tube

WHITE PPL PART NUMBER	BLACK PPL PART NO.	WHITE NYLON PART NO.	NOM TUBE O.D.	A REF.	C HEX	L OVERALL LENGTH	P MAX	FLOW DIA. D	BLKHD HOLE DRILL SIZE
W4BU4	P4BU4	N4BU4	1/4	1/4	13/16	2-11/64	3/8	.170	21/32
W5BU5*	P5BU5	N5BU5	5/16	1/4	13/16	2-11/64	3/8	.187	21/32
W6BU6	P6BU6	N6BU6	3/8	9/32	15/16	2-39/64	1/2	.250	25/32
W8BU8	P8BU8	N8BU8	1/2	5/16	1-5/32	2-3/4	1/2	.375	31/32

MR - Male Run Tee

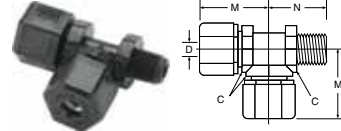

Tube to male pipe

WHITE PPL PART NUMBER	BLACK PPL PART NUMBER	WHITE NYLON PART NUMBER	NOM TUBE O.D.	NPTF THD SIZE	C HEX	M	N	FLOW DIA. D
W4MR2	P4MR2	N4MR2	1/4	1/8	11/16	1.09	0.89	.170
W6MR4	P6MR4	N6MR4	3/8	1/4	13/16	1.30	1.17	.250
W8MR6	P8MR6	N8MR6	1/2	3/8	1	1.46	1.28	.375
W10MR8*	P10MR8	N10MR8	5/8	1/2	1-1/8	1.68	1.50	.500

FE - Female Elbow

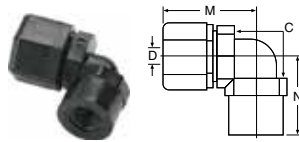

Tube to female pipe

WHITE PPL PART NUMBER	BLACK PPL PART NUMBER	WHITE NYLON PART NUMBER	NOM TUBE O.D.	NPTF THD SIZE	C HEX	M	N	FLOW DIA. D
W4FE2	P4FE2	N4FE2	1/4	1/8	11/16	1.10	0.84	.170
W4FE4	P4FE4	N4FE4	1/4	1/4	11/16	1.10	0.94	.170
W5FE2*	P5FE2	N5FE2	5/16	1/8	11/16	1.10	0.84	.193
W6FE4	P6FE4	N6FE4	3/8	1/4	13/16	1.30	1.06	.250
W6FE6	P6FE6	N6FE6	3/8	3/8	13/16	1.30	1.03	.250
W8FE6*	P8FE6	N8FE6	1/2	3/8	1	1.50	1.16	.375
W8FE8	P8FE8	N8FE8	1/2	1/2	1	1.50	1.27	.375
W10FE8*	P10FE8	N10FE8	5/8	1/2	1-1/8	1.70	1.34	.500

TU - Tee Union



Tube to tube

WHITE PPL PART NUMBER	BLACK PPL PART NUMBER	WHITE NYLON PART NUMBER	NOM. TUBE O.D.	C HEX	M	N	FLOW DIA. D
W4TU4	P4TU4	N4TU4	1/4	11/16	1.09	1.09	.170
W5TU5*	P5TU5	N5TU5	5/16	11/16	1.09	1.09	.187
W6TU6	P6TU6	N6TU6	3/8	13/16	1.30	1.30	.250
W8TU6*	P8TU6	N8TU6	1/2-3/8	1	1.46	1.39	.250
W8TU8	P8TU8	N8TU8	1/2	1	1.46	1.46	.375
W10TU6*	P10TU6	N10TU6	5/8-3/8	1-1/8	1.68	1.46	.250
W10TU10*	P10TU10	N10TU10	5/8	1-3/16	1.68	1.68	.500

FC - Female Connector



Tube to female pipe

WHITE PPL PART NUMBER	BLACK PPL PART NUMBER	WHITE NYLON PART NUMBER	NOM TUBE O.D.	NPTF THREAD SIZE	C HEX	L	FLOW DIA. D
W4FC2	P4FC2	N4FC2	1/4	1/8	11/16	1.31	.170
W4FC4	P4FC4	N4FC4	1/4	1/4	11/16	1.44	.170
W6FC4	P6FC4	N6FC4	3/8	1/4	13/16	1.61	.250
W6FC6	P6FC6	N6FC6	3/8	3/8	13/16	1.64	.250
W6FC8	P6FC8	N6FC8	3/8	1/2	13/16	1.75	.250
W8FC6*	P8FC6	N8FC6	1/2	3/8	1	1.70	.375
W8FC8	P8FC8	N8FC8	1/2	1/2	1	1.85	.375
W10FC8*	P10FC8	N10FC8	5/8	1/2	1-1/8	1.96	.500

MT - Male Branch Tee

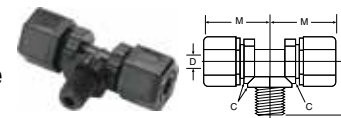

Tube to male pipe

WHITE PPL PART NUMBER	BLACK PPL PART NUMBER	WHITE NYLON PART NUMBER	NOM. TUBE O.D.	NPTF THD SIZE	C HEX	M	N	FLOW DIA. D
W4MT2	P4MT2	N4MT2	1/4	1/8	11/16	1.09	0.89	.170
W4MT4	P4MT4	N4MT4	1/4	1/4	11/16	1.09	1.06	.170
W5MT2*	P5MT2	N5MT2	5/16	1/8	11/16	1.09	0.89	.170
W5MT4*	P5MT4	N5MT4	5/16	1/4	11/16	1.09	1.06	.187
W6MT4	P6MT4	N6MT4	3/8	1/4	13/16	1.30	1.12	.250
W6MT6	P6MT6	N6MT6	3/8	3/8	13/16	1.30	1.10	.250
W8MT6	P8MT6	N8MT6	1/2	3/8	1	1.46	1.22	.375
W8MT8	P8MT8	N8MT8	1/2	1/2	1	1.46	1.43	.375
W10MT8*	P10MT8	N10MT8	5/8	1/2	1-1/8	1.68	1.41	.500

* Non-standard

[Click here for CADs, Product Specifications or to Configure Parts Online](#)

GR - Grab Ring



(Stainless or Plastic)

STAINLESS GRAB RING PART NUMBER	PLASTIC GRAB RING PART NUMBER	FOR NOM. TUBE O. D.
4GR	4GRP	1/4
5GR	5GRP	5/16
6GR	6GRP	3/8
8GR	8GRP	1/2
10GR	10GRP	5/8

NS - Nut and Spacer Sets



WHITE POLYPROPYLENE PART NO.	BLACK POLYPROPYLENE PART NO.	WHITE NYLON PARTNUMBER	FOR NOM. TUBE O. D.
W4NS	P4NS	N4NS	1/4
W5NS	P5NS	N5NS	5/16
W6NS	P6NS	N6NS	3/8
W8NS	P8NS	N8NS	1/2
W10NS	P10NS	N10NS	5/8

TS - Tube Support



POLYPROPYLENE PART NO.	NYLON PART NO.	FOR TUBE PART NO.
P4TS3	N4TS3	PV43
P5TS3	N5TS3	PV53
P6TS4	N6TS4	PV64
P8TS6	N8TS6	PV86
P10TS8	N10TS8	PV108

OR - O-Ring



FOR NOM. TUBE O. D.	NITRILE O-RING	FLUOROCARBON O-RING	EPDM O-RING
1/4	4OR	4OR-V	4OR-EPDM
5/16	5OR	5OR-V	5OR-EPDM
3/8	6OR	6OR-V	6OR-EPDM
1/2	8OR	8OR-V	8OR-EPDM
5/8	10OR	10OR-V	10OR-EPDM

Fast and Tite Ball Valves

This range of ball valves uses compression technology to create a sure and tight connection. Use Parker's Fast and Tite fittings for low pressure applications such as water filtration, beverage dispensing, or on vacuum lines. Manufactured from black polypropylene material, these valves meet FDA and NSF-51 requirements for food contact.

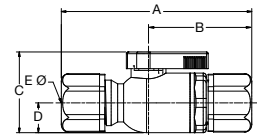

Features/Benefits:

- 302 Stainless Steel Grab Ring
- Nitrile O-ring
- FDA Compliant
- NSF/ANSI-51 Compliant

Specifications:

- Temperature Range: +35° F to +200° F (+1° C to +93° C)
- O-ring Seal Material: Nitrile
- NSF/ANSI 51
- Pressure Rated to 150PSI

Assembly Instructions:

1. Cut the tube squarely and remove any burrs.
2. Mark from end of tube the length of insertion. If using a tube support, insert fully into tube before marking. (See insertion length table left)
3. Loosen nut on fitting until three threads are visible. Fittings for glass tubes must be disassembled and the grab ring removed. If the fitting has been disassembled the components are to be placed in the following order: fitting body, o-ring, spacer, grab ring and nut. Assemble the nut until three threads are showing on the body before inserting tube.
4. Moisten end of the tube with water. Push the tube straight into fitting until it bottoms on the fitting's shoulder. Tighten nut by hand. Additional tightening should not be necessary, but 1/4 additional turn may be added if desired. Do not overtighten nut as the threads will strip and the fitting will not function properly. A proper assembly will not show the insertion mark extending beyond the nut. If the insertion mark is visible, then steps 1 thru 4 must be repeated.
5. Whenever a Fast & Tite® fitting is assembled for service or reuse the stainless steel grab ring should be replaced for maximum tubing retention.

Note: Provide adequate fail-safe mechanisms such as leakage detection sensors, automatic shut-off controls or other industry and code appropriate fail-safe devices in the design of your water-handling appliance to protect against personal injury and property damage. Plastic fittings containing an o-ring have a finite life depending on the environment, media and severity of the application. Frequent inspections and replacement of the fitting when anomalies are found is recommended.

VUC - Valve Union Connector

PART NO.	1 TUBE SIZE	2 TUBE SIZE	A	B	C	D	ØE THRU HOLE MIN.
FTPPB4VUC4	1/4	1/4	2.94	1.61	1.4	.5	.19
FTPPB4VUC6	1/4	3/8	3.07	1.61	1.4	.5	.19
FTPPB6VUC6	3/8	3/8	3.19	1.73	1.4	.5	.25
FTPPB8VUC8	1/2	1/2	3.27	1.80	1.4	.5	.38

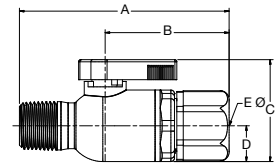

VMC - Valve Male Connector

PART NO.	1 TUBE SIZE	NPTF THD SIZE	A	B	C	D	ØE THRU HOLE MIN.
FTPPB4VMC4	1/4	1/4	2.81	1.61	1.4	.5	.19
FTPPB4VMC6	1/4	3/8	2.81	1.61	1.4	.5	.19
FTPPB6VMC4	3/8	1/4	2.93	1.73	1.4	.5	.19
FTPPB6VMC6	3/8	3/8	2.93	1.73	1.4	.5	.25
FTPPB8VMC6	1/2	3/8	3.00	1.79	1.4	.5	.25

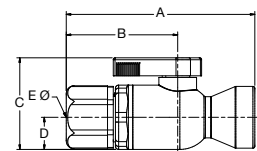

VFC - Valve Female Connector

PART NO.	1 TUBE SIZE	NPTF THD SIZE	A	B	C	D	ØE THRU HOLE MIN.
FTPPB4VFC4	1/4	1/4	2.78	1.61	1.4	.5	.19
FTPPB6VFC6	3/8	3/8	2.93	1.73	1.4	.5	.25
FTPPB8VFC6	1/2	3/8	3.00	1.8	1.4	.5	.25

[Click here for CADs, Product Specifications or to Configure Parts Online](#)

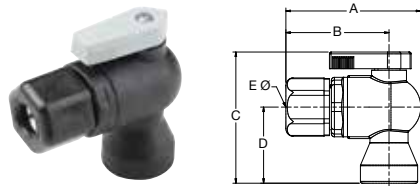

VFE - Valve Female Elbow

PART NO.	1 TUBE SIZE	NPTF THD SIZE	A	B	C	D	ØE THRU HOLE MIN.
FTPPB4VFE4	1/4	1/4	2.14	1.61	2.18	1.25	.19
FTPPB6VFE4	3/8	1/4	2.26	1.73	2.18	1.25	.19
FTPPB6VFE6	3/8	3/8	2.26	1.73	2.21	1.28	.25
FTPPB8VFE6	1/2	3/8	2.34	1.8	2.21	1.28	.25

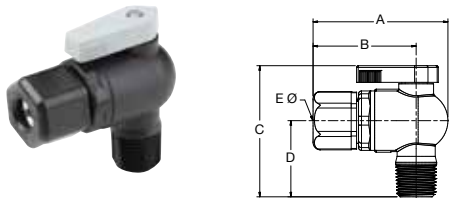

VME - Valve Male Elbow

PART NO.	1 TUBE SIZE	NPTF THD SIZE	A	B	C	D	ØE THRU HOLE MIN.
FTPPB4VME4	1/4	1/4	2.14	1.61	2.21	1.28	.19
FTPPB6VME4	3/8	1/4	2.26	1.73	2.21	1.28	.19
FTPPB6VME6	3/8	3/8	2.26	1.73	2.21	1.28	.25
FTPPB8VME8	1/2	1/2	2.34	1.8	2.4	1.47	.38

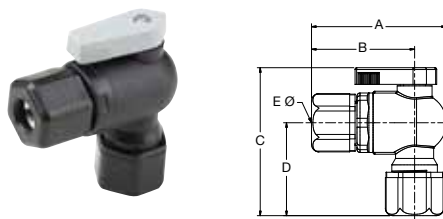

VEU - Valve Elbow Union

PART NO.	1 TUBE SIZE	2 TUBE SIZE	A	B	C	D	ØE THRU HOLE MIN.
FTPPB4VEU4	1/4	1/4	2.14	1.61	2.35	1.42	.19
FTPPB6VEU4	3/8	1/4	2.26	1.73	2.37	1.44	.19
FTPPB6VEU6	3/8	3/8	2.26	1.73	2.49	1.56	.25
FTPPB8VEU8	1/2	1/2	2.34	1.8	2.47	1.54	.38

Par-Barb® Fittings



Parker's Par-Barb Fittings are injection molded from high strength chemically inert, thermoplastic materials. The multiple barb design generates the maximum gripping and sealing power when combined with a hose clamp.

Product Features:

- Available in black polypropylene and white nylon
- FDA compliant material
- NSF/ANSI 51
- Uniprene washer
- Up to 1 1/2" sizes

Markets:

- Water
- Beverage Dispensing
- Bottling
- Semi-Conductor

Applications:

- Water
- Beverages
- Cooling Systems



Specifications:

Pressure Range Up to 125 psi PSI (8.6 bar)

Temperature Range

Nylon: -40° to +200° F (-40° to +93.3° C)

Polypropylene: 0° to +212° F (-12.2° to +100° C)

Compatible Tubing:

- Vinyl
- Polyurethane
- Rubber hose

⚠ WARNING These products can expose you to chemicals including NICKEL, CARBON BLACK, TITANIUM DIOXIDE, or LEAD, which are known to the state of California to

Threaded Fittings

325HB

Male Connector
NPTF
p. C41



326HB

Female Connector
NPTF
p. C41



372HB

Male Branch Tee
NPTF
p. C42



370HB

Female Elbow
NPTF
p. C42



329HB

Male Elbow
NPTF
p. C42



Tube to Tube Fittings

322HB

Union
p. C40



364HB

Union Tee
p. C40



365HB

Union Elbow
p. C40



362HB

Union Y
p. C42



Pipe Fittings

318P

Hex Plug
p. C40



309P

Bushing
p. C40



316P

Nipple
p. C41



Garden Hose Fittings

316GH

Garden Hose
Adapter
p. C43



325GH

Garden Hose
Connector
p. C43



Accessories

328HB

Hose Barb Stem
p. C43



31HB

Hose Barb
Swivel Nut
p. C43



325GHSV

Swivel Hose
Barb Stem
p. C43



31GH

Garden Hose Nut
p. C43



313GH

Garden Hose Cap
p. C43



30GH

Garden Hose Washer
p. C43



Ball Valves

VFC

Female Connector
p. C43



VFE

Female Elbow
p. C44



VMC

Male Connector
p. C44



VME

Male Elbow
p. C44



VUC

Union Connector
p. C44



VUCPB

Barb x Tuber
p. C44



BVC

Ball Valve Clip
p. C44



⚠ WARNING These products can expose you to chemicals including NICKEL, CARBON BLACK, TITANIUM DIOXIDE, or LEAD, which are known to the state of California to

Click here for CADs, Product Specifications or to Configure Parts Online



Union Connector 322HB

WHITE NYLON PART NO.	BLACK POLYPROPYLENE PART NO.	TUBE OR HOSE I.D. 1	TUBE OR HOSE I.D. 2	O.D. 1	O.D. 2	L	FLOW DIA. D
322HB-2N*	322HB-2PP*	1/8	1/8	.18	.18	.66	.09
322HB-3N	322HB-3PP	3/16	3/16	.25	.25	1.61	.12
322HB-4-2N	322HB-4-2PP	1/4	1/8	.31	.21	1.61	.08
322HB-4-3N	322HB-4-3PP	1/4	3/16	.31	.25	1.61	.13
322HB-4N	322HB-4PP	1/4	1/4	.31	.31	1.61	.16
322HB-5N	322HB-5PP	5/16	5/16	.37	.37	1.61	.22
322HB-6-4N	322HB-6-4PP	3/8	1/4	.43	.31	1.61	.15
322HB-6-5N	322HB-6-5PP	3/8	5/16	.43	.37	1.62	.22
322HB-6N	322HB-6PP	3/8	3/8	.43	.43	1.61	.25
322HB-8-4N	322HB-8-4PP	1/2	1/4	.55	.31	1.73	.15
322HB-8-6N	322HB-8-6PP	1/2	3/8	.55	.43	1.73	.25
322HB-8N	322HB-8PP	1/2	1/2	.56	.56	1.74	.38
322HB-10-6N	322HB-10-6PP	5/8	3/8	.66	.43	1.73	.25
322HB-10-8N	322HB-10-8PP	5/8	1/2	.66	.55	1.73	.37
322HB-10N	322HB-10PP	5/8	5/8	.67	.67	1.73	.47
322HB-12-8N	322HB-12-8PP	3/4	1/2	.81	.55	2.99	.38
322HB-12N	322HB-12PP	3/4	3/4	.80	.80	2.97	.58
322HB-16N		1	1	1.08	1.08	3.12	.82
322HB-20N		1-1/4	1-1/4	1.26	1.26	3.58	1.00
322HB-24N		1-1/2	1-1/2	1.51	1.51	3.58	1.25

*Note: 1/8" tube connections contain one barb.

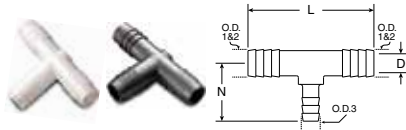

Union Tee 364HB

WHITE NYLON PART NO.	BLACK POLYPROPYLENE PART NO.	TUBE OR HOSE I.D. 1-2	TUBE OR HOSE I.D. 3	O.D. 1-2	O.D. 3	L	N	FLOW DIA. D
364HBM-2N*		1/8	1/8	.15	.15	1.19	.60	.08
364HB-3N	364HB-3PP	3/16	3/16	.25	.25	1.49	.75	.12
364HB-4N	364HB-4PP	1/4	1/4	.32	.32	1.92	.96	.16
364HB-4-6N		1/4	3/8	.32	.44	1.92	1.18	.16
364HB-5N	364HB-5PP	5/16	5/16	.36	.36	2.22	1.17	.22
364HB-6-3N	364HB-6-3PP	3/8	3/16	.43	.24	2.23	1.04	.09
364HB-6-4N	364HB-6-4PP	3/8	1/4	.44	.32	1.92	1.18	.16
364HB-6N	364HB-6PP	3/8	3/8	.43	.43	2.22	1.18	.25
364HB-6-8N	364HB-6-8PP	3/8	1/2	.43	.56	2.22	1.27	.25
364HB-8-6N	364HB-8-6PP	1/2	3/8	.55	.43	2.52	1.27	.25
364HB-8N	364HB-8PP	1/2	1/2	.56	.56	2.52	1.27	.37
364HB-10N	364HB-10PP	5/8	5/8	.66	.66	2.74	1.37	.46
364HB-12N		3/4	3/4	.81	.81	2.98	1.50	.58
364HB-16N		1	1	1.06	1.06	3.10	1.55	.81
364HB-20N		1-1/4	1-1/4	1.25	1.25	5.29	2.64	1.00
364HB-24N		1-1/2	1-1/2	1.51	1.51	5.48	2.74	1.25

*Note: 1/8" tube connections contain one barb.



Union Elbow 365HB

WHITE NYLON PART NO.	BLACK POLYPROPYLENE PART NO.	TUBE OR HOSE I.D. 1	TUBE OR HOSE I.D. 2	O.D. 1	O.D. 2	M	N	FLOW DIA. D
365HB-3N	365HB-3PP	3/16	3/16	.25	.25	.75	.75	.12
365HB-4N	365HB-4PP	1/4	1/4	.31	.31	1.13	1.13	.15
365HB-5N	365HB-5PP	5/16	5/16	.38	.37	1.19	1.19	.22
365HB-6N	365HB-6PP	3/8	3/8	.43	.43	1.26	1.26	.25
365HB-8-4N	365HB-8-4PP	1/2	1/4	.55	.31	1.26	1.24	.16
365HB-8-6N	365HB-8-6PP	1/2	3/8	.55	.43	1.26	1.27	.25
365HB-8N	365HB-8PP	1/2	1/2	.55	.55	1.26	1.26	.37
365HB-10N	365HB-10PP	5/8	5/8	.66	.66	1.37	1.37	.46
365HB-12N	365HB-12PP	3/4	3/4	.80	.80	1.48	1.48	.57
365HB-16N		1	1	1.07	1.07	1.50	1.50	.81
365HB-20N		1-1/4	1-1/4	1.25	1.25	2.63	2.63	1.00
365HB-24N		1-1/2	1-1/2	1.50	1.50	2.74	2.74	1.25



Hex Plug 318P

WHITE NYLON PART NO.	BLACK POLYPROPYLENE PART NO.	NPT PIPE THREAD	C HEX	L
318P-2N	318P-2PP	1/8	7/16	.62
318P-4N	318P-4PP	1/4	9/16	.75
318P-6N	318P-6PP	3/8	11/16	.74
318P-8N	318P-8PP	1/2	7/8	.87
318P-12N	318P-12PP	3/4	1-1/8	.86
318P-16N	318P-16PP	1	1-3/8	1.05
318P-20N	318P-20PP	1-1/4	1-1/2	1.44
318P-24N	318P-24PP	1-1/2	1-3/4	1.61



Reducer Bushing 309P

WHITE NYLON PART NO.	BLACK POLYPROPYLENE PART NO.	EXTERNAL NPT PIPE THREAD	INTERNAL NPT PIPE THREAD	C HEX	L
309P-4-2N	309P-4-2PP	1/4	1/8	9/16	.75
309P-6-2N	309P-6-2PP	3/8	1/8	11/16	.74
309P-6-4N	309P-6-4PP	3/8	1/4	11/16	.75
309P-8-2N	309P-8-2PP	1/2	1/8	7/8	.88
309P-8-4N	309P-8-4PP	1/2	1/4	7/8	.87
309P-8-6N	309P-8-6PP	1/2	3/8	7/8	.87
309P-12-2N	309P-12-2PP	3/4	1/8	1-1/8	.86
309P-12-4N	309P-12-4PP	3/4	1/4	1-1/8	.75
309P-12-6N	309P-12-6PP	3/4	3/8	1-1/8	.85
309P-12-8N	309P-12-8PP	3/4	1/2	1-1/8	.87

WARNING These products can expose you to chemicals including NICKEL, CARBON BLACK, TITANIUM DIOXIDE, or LEAD, which are known to the state of California to

[Click here for CADs, Product Specifications or to Configure Parts Online](#)



Hex Nipple 316P

WHITE NYLON PART NO.	BLACK POLYPROPYLENE PART NO.	NPT PIPE THREAD SIDE 1	NPT PIPE THREAD SIDE 2	C HEX	L	FLOW DIA. D
316P-2N	316P-2PP	1/8	1/8	7/16	.99	.22
316P-4-2N	316P-4-2PP	1/4	1/8	9/16	1.13	.22
316P-4N	316P-4PP	1/4	1/4	9/16	1.24	.31
316P-6-2N	316P-6-2PP	3/8	1/8	11/16	1.11	.22
316P-6-4N	316P-6-4PP	3/8	1/4	11/16	1.25	.31
316P-6N	316P-6PP	3/8	3/8	11/16	1.23	.43
316P-8-2N	316P-8-2PP	1/2	1/8	7/8	1.23	.22
316P-8-4N	316P-8-4PP	1/2	1/4	7/8	1.36	.31
316P-8-6N	316P-8-6PP	1/2	3/8	7/8	1.35	.43
316P-8N	316P-8PP	1/2	1/2	7/8	1.45	.59
316P-12-6N	316P-12-6PP	3/4	3/8	1-1/8	1.36	.43
316P-12-8N	316P-12-8PP	3/4	1/2	1-1/8	1.47	.59
316P-12N	316P-12PP	3/4	3/4	1-1/8	1.48	.74
316P-16N	316P-16PP	1	1	1-3/8	1.85	.98

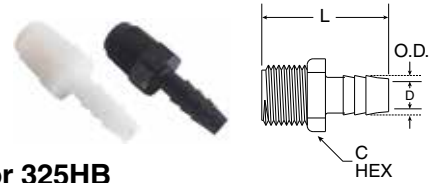

Male Connector 325HB

WHITE NYLON PART NO.	BLACK POLYPROPYLENE PART NO.	TUBE OR HOSE I.D.	NPT PIPE THD.	O.D.	C HEX	L	FLOW DIA. D
325HB-3-2N	325HB-3-2PP	3/16	1/8	.25	7/16	1.49	.12
325HB-3-4N	325HB-3-4PP	3/16	1/4	.25	9/16	1.61	.13
325HB-4-2N	325HB-4-2PP	1/4	1/8	.31	7/16	1.50	.15
325HB-4-4N	325HB-4-4PP	1/4	1/4	.31	9/16	1.60	.16
325HB-4-6N		1/4	3/8	.31	11/16	1.62	.16
325HB-4-8N	325HB-4-8PP	1/4	1/2	.31	7/8	1.73	.15
325HB-4-12N		1/4	3/4	.31	1-1/8	1.74	.16
325HB-5-2N		5/16	1/8	.37	7/16	1.50	.22
325HB-5-4N		5/16	1/4	.37	9/16	1.62	.22
325HB-5-6N	325HB-5-6PP	5/16	3/8	.37	11/16	1.60	.21
325HB-6-2N	325HB-6-2PP	3/8	1/8	.43	7/16	1.49	.25
325HB-6-4N	325HB-6-4PP	3/8	1/4	.43	9/16	1.62	.25
325HB-6-6N	325HB-6-6PP	3/8	3/8	.43	11/16	1.61	.25
325HB-6-8N	325HB-6-8PP	3/8	1/2	.43	7/8	1.73	.25
325HB-6-12N	325HB-6-12PP	3/8	3/4	.43	1-1/8	1.72	.25
325HB-8-4N	325HB-8-4PP	1/2	1/4	.55	9/16	1.61	.35
325HB-8-6N	325HB-8-6PP	1/2	3/8	.55	11/16	1.60	.37
325HB-8-8N	325HB-8-8PP	1/2	1/2	.55	7/8	1.73	.37
325HB-8-12N	325HB-8-12PP	1/2	3/4	.55	1-1/8	1.72	.37
325HB-10-6N	325HB-10-6PP	5/8	3/8	.66	11/16	1.61	.46
325HB-10-8N	325HB-10-8PP	5/8	1/2	.66	7/8	1.73	.46
325HB-10-12N	325HB-10-12PP	5/8	3/4	.67	1-1/8	1.82	.46
325HB-12-8N	325HB-12-8PP	3/4	1/2	.80	7/8	1.86	.62
325HB-12-12N	325HB-12-12PP	3/4	3/4	.80	1-1/8	1.85	.62
325HB-12-16N		3/4	1	.82	1-3/8	2.35	.59
325HB-12-20N		3/4	1-1/4	.86	1-1/2	3.47	.59
325HB-12-24N		3/4	1-1/2	.86	1-3/4	3.66	.59
325HB-16-8N		1	1/2	1.08	1-1/8	2.49	.77
325HB-16-12N		1	3/4	1.07	1-1/8	2.30	.81
325HB-16-16N		1	1	1.07	1-3/8	2.35	.81
325HB-16-20N		1	1-1/4	1.11	1-1/2	3.45	.78
325HB-16-24N		1	1-1/2	1.11	1-3/4	3.63	.78
325HB-20-20N		1-1/4	1-1/4	1.36	1-1/2	3.47	1.04
325HB-20-24N		1-1/4	1-1/2	1.36	1-3/4	3.64	1.04
325HB-24-20N		1-1/2	1-1/4	1.60	1-1/2	3.45	1.28
325HB-24-24N		1-1/2	1-1/2	1.61	1-3/4	3.63	1.28

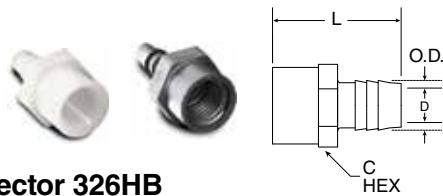

Female Connector 326HB

WHITE NYLON PART NO.	BLACK POLYPROPYLENE PART NO.	TUBE OR HOSE I.D.	NPT PIPE THREAD	O.D.	C HEX	L	FLOW DIA. D
326HB-3-2N	326HB-3-2PP	3/16	1/8	.25	5/8	1.29	.12
326HB-3-4N	326HB-3-4PP	3/16	1/4	.25	3/4	1.31	.13
326HB-4-2N	326HB-4-2PP	1/4	1/8	.31	5/8	1.51	.16
326HB-4-4N	326HB-4-4PP	1/4	1/4	.31	3/4	1.52	.15
326HB-4-6N	326HB-4-6PP	1/4	3/8	.31	1	1.73	.15
326HB-4-8N	326HB-4-8PP	1/4	1/2	.31	1-1/8	1.74	.15
326HB-6-2N	326HB-6-2PP	3/8	1/8	.44	5/8	1.51	.25
326HB-6-4N	326HB-6-4PP	3/8	1/4	.43	3/4	1.52	.25
326HB-6-6N	326HB-6-6PP	3/8	3/8	.43	1	1.73	.25
326HB-6-8N	326HB-6-8PP	3/8	1/2	.43	1-1/8	1.74	.25
326HB-8-4N	326HB-8-4PP	1/2	1/4	.55	3/4	1.52	.37
326HB-8-6N	326HB-8-6PP	1/2	3/8	.55	1	1.74	.37
326HB-8-8N	326HB-8-8PP	1/2	1/2	.56	1-1/8	1.74	.37
326HB-10-6N	326HB-10-6PP	5/8	3/8	.66	1	1.61	.46
326HB-10-8N	326HB-10-8PP	5/8	1/2	.66	1-1/8	1.73	.46
326HB-12-8N	326HB-12-8PP	3/4	1/2	.80	1-1/8	1.86	.62
326HB-12-12N	326HB-12-12PP	3/4	3/4	.80	1-1/8	1.85	.62

WARNING These products can expose you to chemicals including NICKEL, CARBON BLACK, TITANIUM DIOXIDE, or LEAD, which are known to the state of California to

[Click here for CADs, Product Specifications or to Configure Parts Online](#)



Male Branch Tee 372HB

WHITE NYLON PART NO.	BLACK POLYPROPYLENE PART NO.	TUBE OR HOSE I.D.	NPT PIPE THD.	O.D.	C HEX	L	N	FLOW DIA. D
372HB-3-2N		3/16	1/8	.25	7/16	1.94	1.06	.13
372HB-3-4N		3/16	1/4	.24	9/16	1.93	1.17	.13
372HB-4-2N	372HB-4-2PP	1/4	1/8	.32	7/16	1.92	1.06	.16
372HB-4-4N	372HB-4-4PP	1/4	1/4	.32	9/16	1.92	1.16	.16
372HB-4-6N	372HB-4-6PP	1/4	3/8	.32	11/16	1.92	1.18	.16
372HB-6-4N	372HB-6-4PP	3/8	1/4	.43	9/16	2.22	1.18	.25
372HB-6-6N	372HB-6-6PP	3/8	3/8	.43	11/16	2.22	1.17	.25
372HB-8-8N	372HB-8-8PP	3/8	1/2	.43	7/8	2.22	1.29	.25
372HB-8-4N	372HB-8-4PP	1/2	1/4	.55	9/16	2.52	1.17	.37
372HB-8-6N	372HB-8-6PP	1/2	3/8	.56	11/16	2.52	1.17	.37
372HB-8-8N	372HB-8-8PP	1/2	1/2	.55	7/8	2.52	1.30	.37
372HB-12-12N	372HB-12-12PP	3/4	3/4	.81	1-1/8	2.97	1.92	.58
372HB-16-8N		1	1/2	1.07	7/8	3.10	1.74	.81
372HB-16-12N		1	3/4	1.07	1-1/8	3.10	1.92	.81
372HB-16-16N		1	1	1.07	1-3/8	3.11	1.98	.81



Male Elbow 329HB

WHITE NYLON PART NO.	BLACK POLYPROPYLENE PART NO.	TUBE OR HOSE I.D.	NPT PIPE THD.	O.D.	C HEX	M	N	FLOW DIA. D
329HB-3-2N	329HB-3-2PP	3/16	1/8	.25	7/16	.76	1.06	.12
329HB-3-4N		3/16	1/4	.25	9/16	.76	1.17	.13
329HB-4-2N	329HB-4-2PP	1/4	1/8	.31	7/16	1.18	1.04	.16
329HB-4-4N	329HB-4-4PP	1/4	1/4	.31	9/16	1.18	1.16	.22
329HB-4-6N	329HB-4-6PP	1/4	3/8	.31	11/16	1.18	1.17	.15
329HB-4-8N	329HB-4-8PP	1/4	1/2	.32	7/8	1.18	1.30	.15
329HB-5-2N		5/16	1/8	.37	7/16	1.18	1.06	.22
329HB-6-2N	329HB-6-2PP	3/8	1/8	.43	7/16	1.18	1.05	.25
329HB-6-4N	329HB-6-4PP	3/8	1/4	.43	9/16	1.18	1.16	.25
329HB-6-6N	329HB-6-6PP	3/8	3/8	.43	11/16	1.17	1.17	.25
329HB-6-8N	329HB-6-8PP	3/8	1/2	.43	7/8	1.18	1.28	.25
329HB-8-4N	329HB-8-4PP	1/2	1/4	.55	9/16	1.27	1.16	.37
329HB-8-6N	329HB-8-6PP	1/2	3/8	.56	11/16	1.26	1.16	.37
329HB-8-8N	329HB-8-8PP	1/2	1/2	.55	7/8	1.25	1.29	.37
329HB-8-12N	329HB-8-12PP	1/2	3/4	.55	1-1/8	1.30	1.89	.37
329HB-10-6N		5/8	3/8	.67	11/16	1.27	1.18	.47
329HB-10-8N	329HB-10-8PP	5/8	1/2	.68	7/8	1.30	1.73	.48
329HB-10-12N	329HB-10-12PP	5/8	3/4	.69	1-1/8	1.32	1.92	.49
329HB-12-8N	329HB-12-8PP	3/4	1/2	.81	7/8	1.51	1.74	.58
329HB-12-12N	329HB-12-12PP	3/4	3/4	.81	1-1/8	1.50	1.91	.58
329HB-12-16N		3/4	1	.82	1-3/8	1.49	1.98	.58
329HB-12-20N		3/4	1-1/4	.86	1-1/2	1.52	2.39	.59
329HB-12-24N		3/4	1-1/2	.85	1-1/2	2.26	3.09	.59
329HB-16-8N		1	1/2	1.12	7/8	1.58	1.78	.86
329HB-16-12N		1	3/4	1.11	1-1/8	1.58	1.93	.86
329HB-16-16N		1	1	1.08	1-3/8	1.55	1.98	.81
329HB-16-20N		1	1-1/4	1.12	1-1/2	2.28	2.93	.84
329HB-16-24N		1	1-1/2	1.12	1-1/2	2.27	3.11	.84
329HB-20-20N		1-1/4	1-1/4	1.25	1-1/2	2.63	2.94	1.00
329HB-20-24N		1-1/4	1-1/2	1.36	1-1/2	2.63	3.11	1.08
329HB-24-20N		1-1/2	1-1/4	1.60	1-1/2	2.77	2.93	1.30
329HB-24-24N		1-1/2	1-1/2	1.60	1-1/2	2.77	3.10	1.30



Female Elbow 370HB

WHITE NYLON PART NO.	BLACK POLYPROPYLENE PART NO.	TUBE OR HOSE I.D.	NPT PIPE THD.	O.D.	C HEX	M	N	FLOW DIA. D
370HB-4-2N	370HB-4-2PP	1/4	1/8	.31	5/8	1.19	1.07	.16
370HB-4-4N	370HB-4-4PP	1/4	1/4	.31	3/4	1.18	1.08	.16
370HB-4-6N	370HB-4-6PP	1/4	3/8	.31	1	1.16	1.30	.16
370HB-4-8N	370HB-4-8PP	1/4	1/2	.31	1-1/8	1.18	1.30	.15
370HB-6-2N	370HB-6-2PP	3/8	1/8	.43	5/8	1.18	1.06	.25
370HB-6-4N	370HB-6-4PP	3/8	1/4	.44	3/4	1.18	1.06	.25
370HB-6-6N	370HB-6-6PP	3/8	3/8	.43	1	1.18	1.29	.25
370HB-6-8N	370HB-6-8PP	3/8	1/2	.43	1-1/8	1.18	1.29	.25
370HB-8-4N	370HB-8-4PP	1/2	1/4	.55	3/4	1.25	1.22	.37
370HB-8-6N	370HB-8-6PP	1/2	3/8	.55	1	1.25	1.44	.37
370HB-8-8N	370HB-8-8PP	1/2	1/2	.55	1-1/8	1.25	1.45	.37
370HB-8-12N	370HB-8-12PP	1/2	3/4	.55	1-3/8	1.26	1.72	.37
370HB-12-12N	370HB-12-12PP	3/4	3/4	.80	1-3/8	1.38	1.84	.59

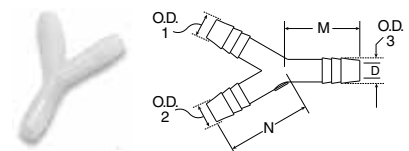

Union Y 362HB

WHITE NYLON PART NO.	TUBE OR HOSE I.D. 1 & 2	TUBE OR HOSE I.D. 3	O.D. 1 & 2	O.D. 3	M	N	FLOW DIA. D
362HB-4N	1/4	1/4	.31	.31	1.13	1.13	.16
362HB-6N	3/8	3/8	.43	.43	1.25	1.40	.25
362HB-8N	1/2	1/2	.55	.55	1.25	1.50	.38

WARNING These products can expose you to chemicals including NICKEL, CARBON BLACK, TITANIUM DIOXIDE, or LEAD, which are known to the state of California to

[Click here for CADs, Product Specifications or to Configure Parts Online](#)



Ball Nose Hose Barb Stem 328HB

WHITE NYLON PART NO.	BLACK POLYPROPYLENE PART NO.	TUBE OR HOSE I.D.	SWIVEL NUT NPT PIPE THREAD	O.D.	L	FLOW DIA. D
328HB-4BN	328HB-4BPP	1/4	1/4 *	.30	1.19	.19
328HB-4-8BN	328HB-4-8BPP	1/4	1/2 *	.30	1.29	.15
328HB-6BN	328HB-6BPP	3/8	3/8 *	.56	1.41	.25
328HB-8BN	328HB-8BPP	1/2	1/2 *	.67	1.30	.37

*Use with hose barb swivel nut (31HB-XX) for desired NPT thread.



Hose Barb Swivel Nut 31HB

WHITE NYLON PART NO.	BLACK POLYPROPYLENE PART NO.	NPT PIPE THREAD	C HEX	L
31HB-4N	31HB-4PP	1/4	3/4	.62
31HB-6N	31HB-6PP	3/8	7/8	.63
31HB-8N	31HB-8PP	1/2	1- 1/16	.75

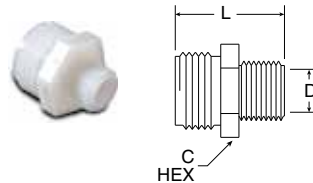

Male Garden Hose - Male Pipe Adapter 316GH

WHITE NYLON PART NO.	GARDEN HOSE THREAD	NPT PIPE THREAD	C HEX	L	FLOW DIA. D
316GH-12-6N	3/4	3/8	1- 1/8	1.33	.44
316GH-12-8N	3/4	1/2	1- 1/8	1.44	.59
316GH-12-12N	3/4	3/4	1- 1/8	1.48	.75

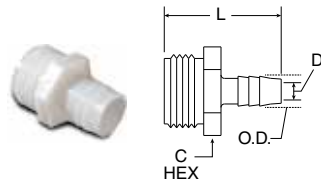

Male Garden Hose - Hose Barb 325GH

WHITE NYLON PART NO.	TUBE OR HOSE I.D.	GARDEN HOSE THREAD	O.D.	C HEX	L	FLOW DIA. D
325GH-4-12N	1/4	3/4	.31	1- 1/8	1.70	.16
325GH-6-12N	3/8	3/4	.44	1- 1/8	1.69	.25
325GH-8-12N	1/2	3/4	.55	1- 1/8	1.68	.38
325GH-10-12N	5/8	3/4	.64	1- 1/8	1.70	.47
325GH-12-12N	3/4	3/4	.81	1- 1/8	1.70	.62

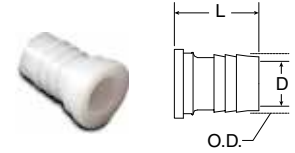

Garden Hose Swivel Hose Barb Stem 325GHSV

WHITE NYLON PART NO.	TUBE OR HOSE I.D.	GARDEN HOSE THREAD	O.D.	L	FLOW DIA. D
325GHSV-4-12BN*	1/4	3/4	.31	1.16	.16
325GHSV-6-12BN*	3/8	3/4	.44	1.17	.25
325GHSV-8-12BN*	1/2	3/4	.56	1.17	.38
325GHSV-10-12BN*	5/8	3/4	.64	1.18	.47
325GHSV-12-12BN*	3/4	3/4	.81	1.18	.62

*Use with Garden Hose washer (30GH-12) and Garden Hose Nut (31GH-12N)



Garden Hose Nut 31GH

WHITE NYLON PART NO.	GARDEN HOSE THREAD	L	DIA. N
31GH-12N	3/4	.74	1.38



Garden Hose Cap 313GH

WHITE NYLON PART NO.	GARDEN HOSE THREAD	L	DIA. N
313GH-12N**	3/4	.74	1.38

**Use with Garden Hose Washer (30GH-12)



Garden Hose Washer 30GH

WHITE TPE PART NO.	GARDEN HOSE THREAD	L
30GH-12	3/4	.13

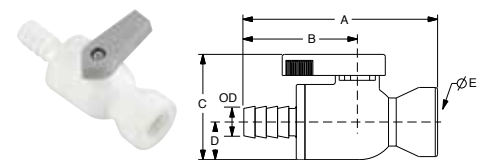

VFC - Valve Barbed Female Connector

PART NO.	HOSE I.D.	NPTF THD.	O.D.	A	B	C	D	ØE THRU HOLE MIN.
PBPP4VFC4	1/4	1/4	.31	2.76	1.60	1.41	.50	.15
PBPP6VFC6	3/8	3/8	.43	2.79	1.60	1.41	.50	.19

⚠ WARNING These products can expose you to chemicals including NICKEL, CARBON BLACK, TITANIUM DIOXIDE, or LEAD, which are known to the state of California to

[Click here for CADs, Product Specifications or to Configure Parts Online](#)

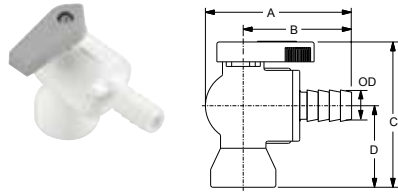

VFE - Valve Barbed Female Elbow

PART NO.	HOSE I.D.	NPTF THD.	O.D.	A	B	C	D	ØE THRU HOLE MIN.
PBPP4VFE4	1/4	1/4	.31	2.13	1.60	2.05	1.15	.15
PBPP6VFE4	3/8	1/4	.43	2.13	1.60	2.05	1.15	.15
PBPP6VFE6	3/8	3/8	.43	2.13	1.60	2.18	1.28	.19

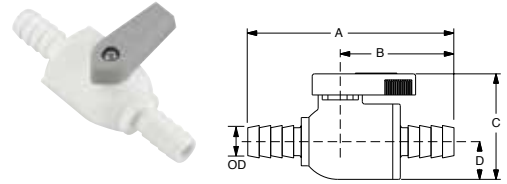

VUC - Valve Barbed Union Connector

PART NO.	HOSE I.D.	O.D.	A	B	C	D	ØE THRU HOLE MIN.
PBPP4VUC4	1/4	.31	2.91	1.60	1.42	.50	.15
PBPP6VUC6	3/8	.43	2.91	1.60	1.42	.50	.19
PBPP8VUC8	1/2	.55	2.91	1.60	1.42	.50	.25

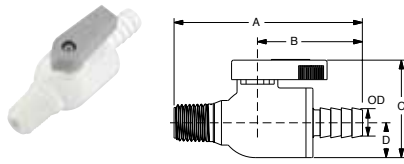

VMC - Valve Barbed Male Connector

PART NO.	HOSE I.D.	NPTF THD.	O.D.	A	B	C	D	ØE THRU HOLE MIN.
PBPP4VMC4	1/4	1/4	.31	2.79	1.60	1.42	.50	.15
PBPP6VMC6	3/8	3/8	.43	2.79	1.60	1.42	.50	.19

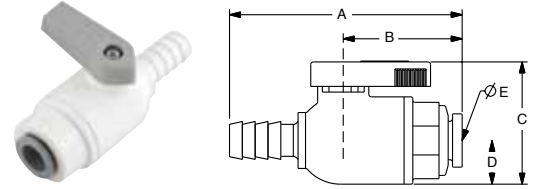

VUCPB - Valve Union Connector Barbed x Tube

PART NO.	HOSE ID	TUBE OD	OD	A	B	C	D	ØE THRU HOLE MIN.
LFPP4VUCPB4	1/4	1/4	.31	2.40	1.08	1.42	.50	.15
LFPP6VUCPB6	3/8	3/8	.43	2.63	1.32	1.42	.50	.19

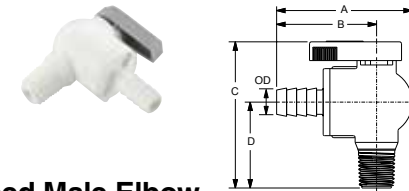

VME - Valve Barbed Male Elbow

PART NO.	HOSE I.D.	NPTF THD.	O.D.	A	B	C	D	ØE THRU HOLE MIN.
PBPP4VME4	1/4	1/4	.31	2.13	1.60	2.18	1.28	.15
PBPP6VME6	3/8	3/8	.43	2.13	1.60	2.18	1.28	.19

BVC Ball Valve Clip

BV-Clip Shown below holding VUCPB and VME

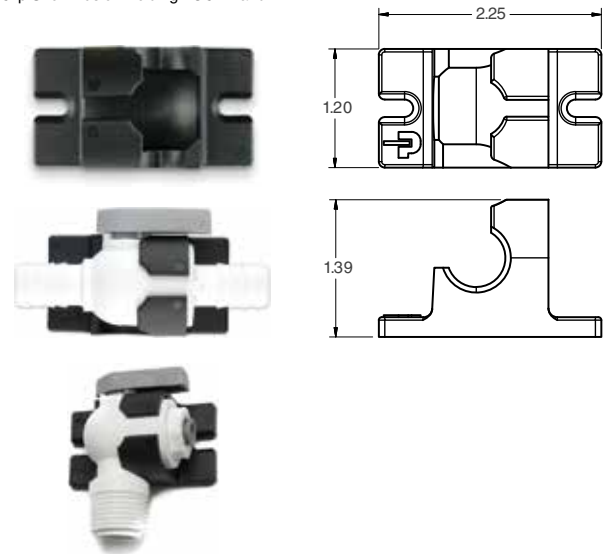

VEU - Parbarb Elbow Ball Valve

PART NO.	HOSE I.D.	O.D.	A	B	C	D	ØE THRU HOLE MIN.
PBPP4VEU4	1/4	.31	2.13	1.57	2.32	1.40	.15
PBPP6VEU6	3/8	.43	2.13	1.60	2.32	1.40	.25
PBPP8VEU8	1/2	.55	2.13	1.60	2.32	1.40	.25

WARNING These products can expose you to chemicals including NICKEL, CARBON BLACK, TITANIUM DIOXIDE, or LEAD, which are known to the state of California to



Cartridges

Carstick® Cartridges

LIQUIfit® Cartridges

TrueSeal™ Cartridges

PLM/PLS Cartridges

SAE Encapsulated Cartridges





GOODYEAR
RUBBER PRODUCTS, INC.

+1.727.342.5087

También puede enviarnos un correo electrónico a ventas@goodyearrubberproducts.com

Cartridges



Parker has developed a range of cartridges guaranteeing the integrity of the sealing system before and after assembly in non-threaded cavities. The compact design of the one-piece cartridges enables automation of your manufacturing process and improves the reliability of your system.

Product Features:

- Self-centering of the cartridge in the cavity
- Push-in connection
- Designed for automation assembly process
- SAE & NSF cartridges available

Markets:

- Industrial
- Pneumatic
- Filtration
- Semi-Conductor
- Life Science
- Automation
- Heavy Duty Truck

Applications:

- Air
- Water
- Beverage Dispensing
- Cab Controls
- Packaging
- Labeling

Specifications:

	Seals	Pressure	Temperature
Carstick	Nitrile	Up to 290 PSI (20 bar)	-4° to +175° F (-20° to +79.4° C)
PLM/PLS	FKM	Up to 435 PSI (30 bar)	-13° to +302° F (-25° to +150° C)
LIQUIfit	EPDM	Up to 230 PSI (15.9 bar)	35° to +200° F (+1.7° to +93.3° C)
TrueSeal	EPDM	Up to 150 PSI (10.3 bar)	-20° to +180° F (-28.9° to +82.2° C)
PTC	Nitrile	Up to 250 PSI (17.2 bar)	-40° to +200° F (-40° to +93.3° C)

⚠ WARNING These products can expose you to chemicals including NICKEL or LEAD, which are known to the state of California to cause cancer and LEAD.

■ Carstick Cartridges

3100

Carstick® Cartridge
Brass
p. D6



3100

Carstick® Cartridge
Nickel-Plated Brass
p. D6



■ Liquifit Cartridges

6300

LIQUIfit Cartridge
Brass
p. D8



6300

LIQUIfit Cartridge
Nickel-Plated Brass
p. D8



■ TrueSeal Cartridges

TSC

Cartridge Insert
p. D10



■ PLM/PLS Cartridges

PLMC

Cartridge
p. D11



PLSC

Cartridge
p. D11



■ SAE Encapsulated Cartridges

PTCCE

Encapsulated
p. D12



⚠ WARNING These products can expose you to chemicals including NICKEL or LEAD, which are known to the state of California to cause cancer and LEAD.

Carstick® Cartridges

Component Materials

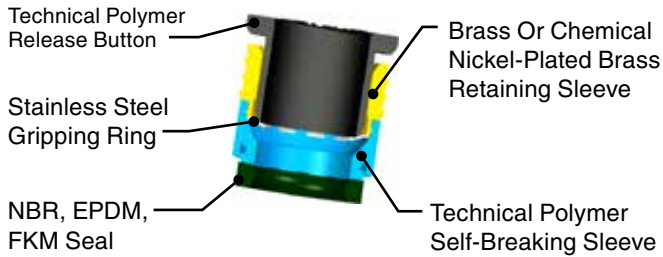

3100 Carstick® Cartridge Brass

PART NO.	OD	G	G1	H	L	KG
3100 04 00	4	8	11	10	554	.001
3100 06 00	6	10	14.5	11.5	629	.002
3100 08 00	8	13	15	15	794	.002
3100 10 00	10	15.5	19.5	17	930	.005
3100 12 00	12	19.5	21	19.5	1038	.010

50 cartridges per Carstick®

3100 Carstick® Cartridge Nickel-Plated Brass Inch

PART NO.	OD	G	G1	H	L	KG
3100 53 00 99	1/8	7	10	9	508	.002
3100 56 00 99	1/4	10.5	14.5	12	600	.003
3100 60 00 99	3/8	15.5	19	16.5	930	.006

50 cartridges per Carstick®
5/32" (4mm) and 5/16" (8mm) also available

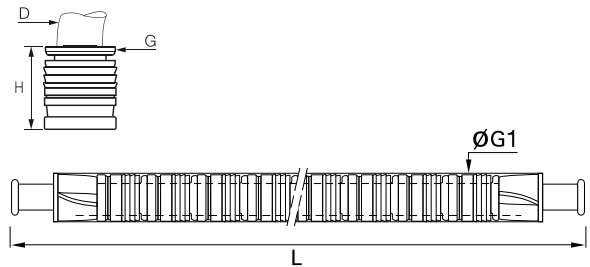
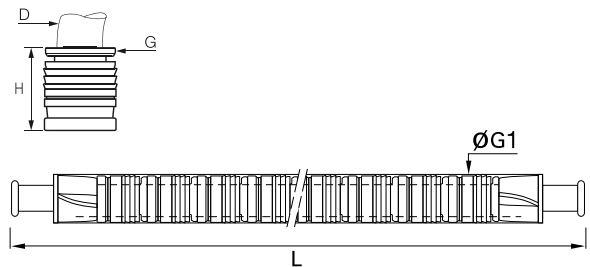

Installation

1. Self-centering of the cartridge in the cavity.
2. The seal protection is broken. The seal slides into the cavity. The cartridge is in place.
3. Tube connection.

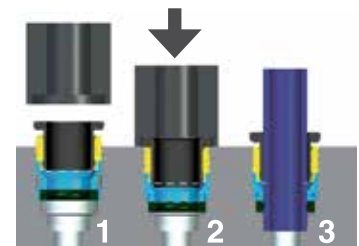

Assembly Tool: For details on the assembly tool, please contact us.

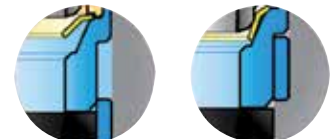

WARNING These products can expose you to chemicals including NICKEL or LEAD, which are known to the state of California to cause cancer, and LEAD.

Carstick® Cavity Dimensions

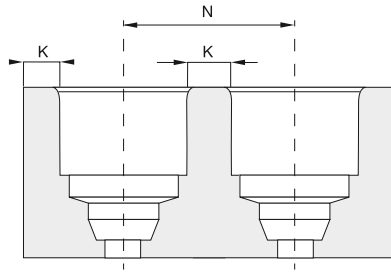
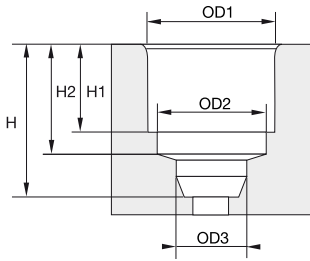

Please consult us for detailed drawings of cavity dimensions and tolerances. All our dimensions are in millimeters.

Carstick® & Quick Fitting Metric

CAVITY	OD3	H	H1	H2
4	4.1	10	6	8.15
6	6.1	12	7.5	9.65
8	8.15	15.5	9.9	12.45
10	10.25	19	11.7	14.35
12	12.17	22	13.9	16.75

Carstick® Inch

CAVITY	OD3	H	H1	H2
1/8	3.25	7.45	5.3	9.5
5/32 *	4.1	8.15	6	10
1/4	6.45	10.15	8	12.5
5/16 *	8.15	12.45	9.9	15.5
3/8	9.65	14.35	11.7	19
1/2	12.8	26.1	16.9	20.1

Polyamide Cavity

CAVITY	OD1	OD2	N*	K
4	8.25	7.05	9.8	1.5
6	10.2	9.15	12.2	2
8	12.15	10.85	14.2	2
10	14.8	13.2	16.8	2
12	17.5	15.5	20	2.5

CAVITY	OD1	OD2	N	K
1/8	7.05	6.02	8.6	1.5
5/32*	8.25	7.05	9.75	1.5
1/4	10.55	9.35	12.6	2
5/16*	12.15	10.85	14.2	2
3/8	14.8	13.1	16.8	2
1/2	19.86	17.82	24.85	2.5

Aluminum Cavity

CAVITY	OD1	OD2	N*	K
4	8.25	7.5	11.5	3
6	10.3	9.15	13.5	3
8	12.2	10.85	15.2	3
10	15.05	13.2	17.1	2
12	17.5	15.5	20	2.5

CAVITY	OD1	OD2	N	K
1/8	7.1	6.2	8.6	1.5
5/32*	8.25	7.05	11.25	3
1/4	10.6	9.35	12.65	2
5/16*	12.2	10.85	15.2	3
3/8	15.05	13.1	17.1	2

Brass Cavity

CAVITY	OD1	OD2	N*	K
4	8.25	7.05	10.25	2
6	10.25	9.1	12.25	2
8	12.2	10.85	14.25	2
10	15.05	13.2	17.1	2
12	17.65	15.5	20	2.5

CAVITY	OD1	OD2	N	K
1/8	7.1	6.2	8.6	1.5
5/32*	8.25	7.05	10.25	2
1/4	10.6	9.35	12.65	2
5/16*	12/2	10.85	14.25	2
3/8	10.05	13.1	17.1	2

* Carstick®

*5/32"=4mm and 5/16"=8mm

LIQUIfit[®] Cartridges



6300 LIQUIfit Cartridge Brass Metric

PART NO.	OD	G	G1	H	L	KG
6300 04 00	4	8	11	10	554	.002
6300 06 00	6	10	14.5	11.5	629	.002
6300 08 00	8	13	15	15	794	.003
6300 10 00	10	15.5	19.5	17	930	.005
6300 12 00	12	18.5	21	19.5	1038	.010

50 cartridges per Carstick[®]

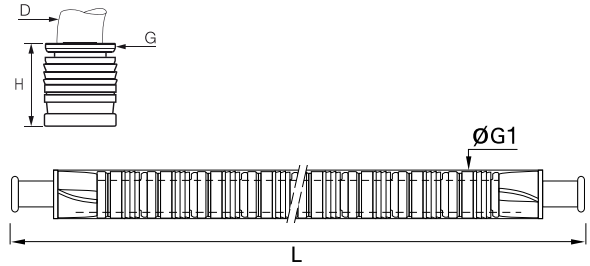

6300 LIQUIfit Cartridge Brass Inch

PART NO.	OD	G	G1	H	L	KG
6300 56 00	1/4	10.5	14.5	12.5	600	.002
6300 60 00	3/8	15.5	19	17	930	.005
6300 62 00	1/2	22	25	23	1038	.011

50 cartridges per Carstick[®]
5/32" (4mm) and 5/16" (8mm) also available

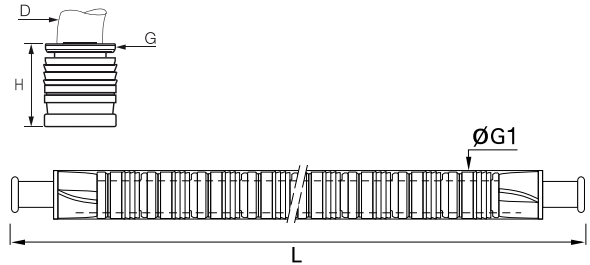

Installation

1. Self-centering of the cartridge in the cavity.
2. The seal protection is broken. The seal slides into the cavity. The cartridge is in place.
3. Tube connection.

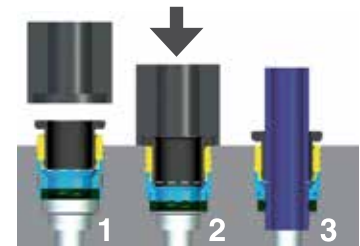

Assembly Tool: For details on the assembly tool, please contact us.



WARNING These products can expose you to chemicals including NICKEL or LEAD, which are known to the state of California to cause cancer and LEAD.

[Click here for CADs, Product Specifications or to Configure Parts Online](#)

LIQUIfit® Carstick® Cavity Dimensions

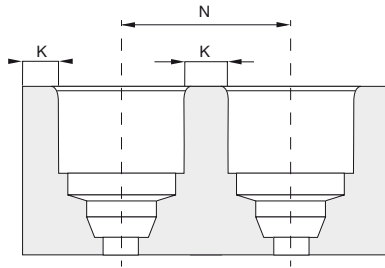
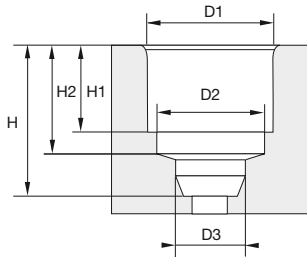

Please consult us for detailed drawings of cavity dimensions and tolerances. All our dimensions are in millimeters.

LIQUIfit® Carstick® Metric

CAVITY	OD3	H	H1	H2
4	4.1	10	6	8.15
6	6.1	12	7.5	9.65
8	8.15	15.5	9.9	12.45
10	10.25	19	11.7	14.35
12	12.17	22	13.9	16.75

LIQUIfit® Carstick® Inch

CAVITY	OD3	H	H1	H2
1/8	3.25	7.45	5.3	9.5
5/32*	4.1	8.15	6	10
1/4	6.45	10.15	8	12.5
5/16*	8.15	12.45	9.9	15.5
3/8	9.65	14.35	11.7	19

Polyamide Cavity

CAVITY	OD1	OD2	N*	K
4	8.25	7.05	9.8	1.5
6	10.2	9.15	12.2	2
8	12.15	10.85	14.2	2
10	14.8	13.2	16.8	2
12	17.5	15.5	20	2.5

CAVITY	OD1	OD2	N	K
1/8	7.05	6.02	8.6	1.5
5/32*	8.25	7.05	9.75	1.5
1/4	10.55	9.35	12.6	2
5/16*	12.15	10.85	14.2	2
3/8	14.8	13.1	16.8	2

Aluminum Cavity

CAVITY	OD1	OD2	N*	K
4	8.25	7.5	11.5	3
6	10.3	9.15	13.5	3
8	12.2	10.85	15.2	3
10	15.05	13.2	17.1	2
12	17.5	15.5	20	2.5

CAVITY	OD1	OD2	N	K
1/8	7.1	6.2	8.6	1.5
5/32*	8.25	7.05	11.25	3
1/4	10.6	9.35	12.65	2
5/16*	12.2	10.85	15.2	3
3/8	15.05	13.1	17.1	2

Brass Cavity

CAVITY	OD1	OD2	N*	K
4	8.25	7.05	10.25	2
6	10.25	9.1	12.25	2
8	12.2	10.85	14.25	2
10	15.05	13.2	17.1	2
12	17.65	15.5	20	2.5

CAVITY	OD1	OD2	N	K
1/8	7.1	6.2	8.6	1.5
5/32*	8.25	7.05	10.25	2
1/4	10.6	9.35	12.65	2
5/16*	12.2	10.85	14.25	2
3/8	10.05	13.1	17.1	2

*5/32"=4mm and 5/16"=8mm

TrueSeal™ Cartridges



TSC - Cartridge Insert

PART NUMBER WITH EPDM SEAL	NOM. TUBE O.D.	A* DIAMETER ±002	B DIAMETER ±003	C DIAMETER ±003	D DIAMETER MAXIMUM	E DEPTH ±002	F DEPTH ±002	G DEPTH ±002	H* CENTERLINE OF PORTS MINIMUM
ATSC4-MG	1/4	.528	.421	.260	.19	.230	.435	.600	.670
ATSC6-MG	3/8	.632	.545	.385	.31	.280	.455	.705	.790
ATSC8-MG	1/2	.774	.668	.510	.41	.315	.510	.810	1.250

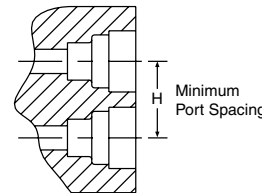
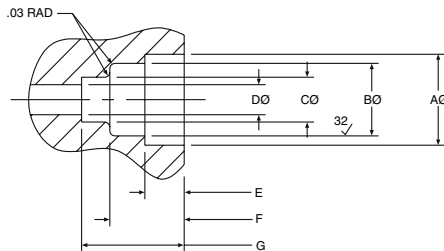

Parker TrueSeal™ Cartridge Inserts:

Allow you to machine or mold a tube connection into your equipment or components. By using cartridge inserts, you will reduce your material and assembly costs, reduce potential leak paths, and give your equipment a new, clean profile by eliminating the need for threaded connections. TSC Cartridge Inserts consist of 1 o-ring, 1 cartridge, and 1 collet.

*Cartridge inserts are rated at 150 PSI in ports dimensioned as above and having Noryl as the receiving material. Other materials may have different ratings and require different port dimensions. Consult the Fluid System Connectors Division when using polypropylene, unfilled polypropylene, ABS or Nylon.

Assembly Instructions:

1. Machine or mold the receiving orifice as per the above dimensions.
2. Place the cartridge insert squarely onto the prepared port opening making sure that the barbs of the cartridge are going into the hole and the lettering on the face of the cartridge is visible.
3. Using a rubber mallet or press, insert the cartridge into the first gland orifice until its face is flush with the top surface of the port.
4. Insert the o-ring into the cartridge and seat it evenly into the second gland orifice.
5. Insert the collet into the cartridge opening.
6. Insert tubing.

WARNING These products can expose you to chemicals including NICKEL or LEAD, which are known to the state of California to cause cancer and LEAD.

PLM/PLS Cartridges

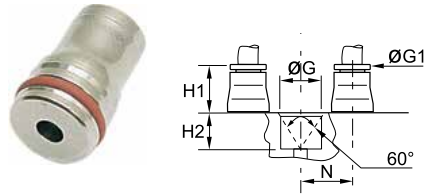

PLMC Cartridge

PART NO.	TUBE SIZE MM	G + .1 - 0	H1 MM	H2 MM	N MM
PLMC-4M	4	10.00	9.00	8.50	11.00
PLMC-6M	6	12.00	11.00	8.50	13.50
PLMC-8M	8	15.00	12.50	8.50	16.00
PLMC-10M	10	17.50	14.50	10.50	20.00
PLMC-12M	12	19.50	15.00	10.50	22.50
PLMC-14M	14	21.50	16.50	12.00	25.00

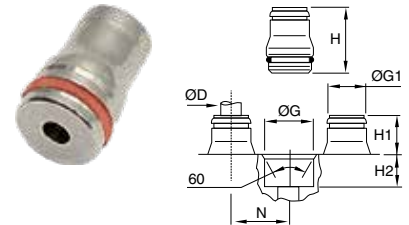

PLSC Cartridge - Metric

PART NO.	TUBE SIZE MM	G + .1 - 0 MM	G1 MM	H MM	H1 MM	H2 MM	N MM
PLSC-4M	4	9.80	8	18.00	9.50	8.50	11.00
PLSC-6M	6	12.10	10	20.00	11.50	8.50	13.50
PLSC-8M	8	14.80	13	22.00	13.50	8.50	16.00
PLSC-10M	10	17.50	15	25.50	15.00	10.50	20.00

WARNING These products can expose you to chemicals including NICKEL or LEAD, which are known to the state of California to cause cancer and LEAD.

SAE Encapsulated Cartridges

PTCCE SAE Encapsulated Cartridge

PART NO.	TUBE SIZE	CAVITY SIZE $\pm .002$	L	M	O.D.	FLOW DIA. D
PTCCE-4	1/4	.504	.63	.43	.56	.13
PTCCE-4-8	1/4	.775	.63	.5	.88	.13
PTCCE-6	3/8	.65	.69	.67	.73	.22
PTCCE-6-8	3/8	.775	.71	.5	.88	.22
PTCCE-8	1/2	.775	.91	.69	.88	.34

NOMINAL TUBE OD (IN)	D1 (MM) $\pm .05$	D1 (IN) $\pm .002$	L1 (MM) MIN	L1 (IN) MIN	R1 (MM) $\pm .05$	R1 (IN) $\pm .002$	R2 (MM) $\pm .05$	R2 (IN) $\pm .002$	C1 (MM) $\pm .05$	C1 (IN) $\pm .002$
1/4	12.8	.504	12.7	.5	.5	.02	.5	.02	.5	.02
3/8	16.5	.65	16.5	.65	.5	.02	.5	.02	.5	.02
1/2	19.7	.775	19.8	.78	.5	.02	.5	.02	.5	.02
5/8	23.5	.925	22.4	.88	.8	.03	.5	.02	.8	.03

Cavity material is to be 6061 T6 aluminum

Cavity Specifications

Dimensions are per the SAE Standard J2494-4. The SAE Encapsulated Cartridge is thoroughly tested to meet or exceed the performance requirements of D.O.T. FMVSS 571.106 and SAE J1131 when used in a 6061-T6 aluminum cavity per SAE J2494-4. Cavity dimensions specified by SAE J2494-4 need to be adjusted slightly for optimum performance in material other than 6061-T6.

Installation

Apply force evenly over the top surface of the cartridge body until the cartridge shoulder bottoms out on the top of the cavity. The amount of force required will vary depending on the cartridge size and the material of the cavity.

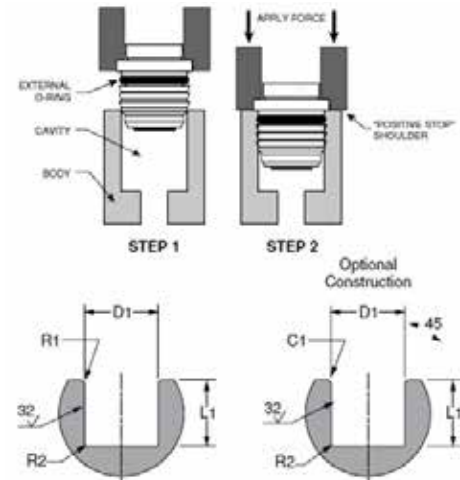
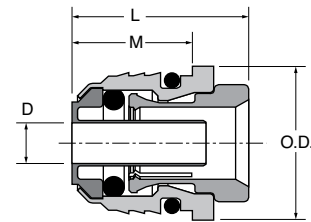

WARNING These products can expose you to chemicals including NICKEL or LEAD, which are known to the state of California to cause cancer and LEAD.



Transportation Push-to-Connect

PTC & PTCR Composite Fittings

PTC Brass Fittings

Metric Prestomatic Fittings

Parker Safe Lock



For more product information visit:
www.parker.com/dot

GOODYEAR
RUBBER PRODUCTS, INC.

 **+1.727.342.5087**

También puede enviarnos un correo electrónico a
ventas@goodyearrubberproducts.com



GOODYEAR
RUBBER PRODUCTS, INC.

+1.727.342.5087

También puede enviarnos un correo electrónico a ventas@goodyearrubberproducts.com

Threaded Fittings

169PTC

Male Elbow
NPT
p. E13



169PTCNSL

Male Elbow Long
NPT
p. E13



169PTCNS

Male Elbow Rigid
NPT
p. E13



171PTC

Run Tee Swivel
NPT
p. E14



171PTCNS

Run Tee Rigid
NPT
p. E14



172PTC

Branch Tee Swivel
NPT
p. E15



172PTCNS

Branch Tee Rigid
NPT
p. E16



179PTC

45° Male Elbow
Swivel – NPT
p. E15



179PTCNS

45° Male Elbow
Rigid – NPT
p. E15



189PTC

Dual Port Elbow
Positional –NPT
p. E15



68PTC / VS68PTC

Male Connector
NPT
p. E12



68PTC

Male Connector
Metric Straight
Thread
p. E12



VS369PTCR

Male Elbow
NPT
p. E7



369PTCR

Male Elbow Swivel
90° Metric Straight
Thread
p. E7



VS368PTCR

Male Y Connector
NPT
p. E8



VS371PTCR

Run Tee
NPT
p. E8



VS372PTCR

Branch Tee
NPT
p. E8



VS379PTCR

45° Male Elbow
NPT
p. E8



379PTCR

Male Elbow Swivel
45° Metric Straight
Thread
p. E9



170PTC

Female Elbow
Swivel – NPT
p. E14



170PTCNS

Female Elbow
Rigid – NPT
p. E14



66PTC

Female Connector
NPT
p. E12



370PTCR

Female Elbow
NPT
p. E7



377PTCR

Female Branch Tee
NPT
p. E8



169PTCNSL

Male Elbow Rigid
p. E14



F8UPMTB

Male Connector
p. E19



C8UPMTB

Male Elbow
p. E19



S8UPMTB

Branch Tee
p. E19



F2PMTB

Male Connector
NPT
p. E19



Tube to Tube Fittings

62PTC

Union
p. E12



164PTC

Union Tee
p. E13



165PTC

Union Elbow
p. E13



32PTC

Union
p. E7



362PTC

Union Y
p. E7



364PTC

Union Tee
p. E7



365PTC

Union Elbow
p. E8



HPMTB

Union
p. E19



JPMTB

Union Tee
p. E19



⚠ WARNING These products can expose you to chemicals including NICKEL or LEAD, which are known to the state of California to cause cancer and LEAD.

Bulkhead Unions

62PTCBHR
Retaining Ring
Bulkhead
p. E16



62PTCBH
Bulkhead Union
p. E16



165PTCBH
Elbow Union
Bulkhead
p. E17



169PTCBH
Male Elbow
Bulkhead
p. E17



Plug-In Fittings

37PTCSP
Adapter
p. E8



369PTCSP
Male Elbow
p. E9



371PTCSP
Run Tee
p. E9



372PTCSP
Branch Tee
p. E9



Accessories

ERHD
External Retainer
p. E16



ES
External Seal
p. E16



639PLP
Plug
p. E17



AQRT
Quick Release
Tool
p. E10, E17



PTCB
Collet Caps
p. E10, E17



Manifolds

24M
Presto Manifold
p. E9



Safe Lock Fittings

A613, A614
Safe Lock Straight
p. E21



A623, A624
Safe Lock Elbow
p. E21



68ALS
Brass Adapter
p. E21



WARNING These products can expose you to chemicals including NICKEL or LEAD, which are known to the state of California to cause cancer and LEAD.

PTC & PTCR Composite Fittings



Parker's PTC & PTCR fittings are composite push-to-connect fittings that meet SAE and D.O.T. specifications. Designed for all D.O.T truck and trailer applications, Parker PTC fittings reduce assembly time versus compression style fittings .

Product Features:

- Brass Collet
- Buna N O-ring or HNBR
- Stainless Steel Tube Support or Brass
- Meets D.O.T. FMVSS571.106
- Meets SAE J2494-3
- Composite Body – Strong, Lightweight, Compact and Impact Resistant
- Plug-in configurations

Markets:

- Heavy Duty Truck
- Trailer
- Mobile

Applications:

- Air Brakes
- Air Tanks
- Air Ride
- Sliders
- Tire Inflation
- Primary & Secondary Air Lines
- Cab Controls

Specifications:

Pressure Range Up to 250 PSI (17.2 bar)

Temperature Range -40° to +200° F (-40° to +93.3° C)

Compatible Tubing:

- SAE J844 Type A & B nylon tubing



Assembly Instructions

1. Cut tubing squarely – maximum of 15° angle allowable.
2. Check that port or mating part is clean and free of debris.
3. Mark tubing to appropriate tube insertion length. (see Tube Insertion Chart on page N22)
4. Insert tubing until it bottoms
5. Pull on tubing to verify it is fully inserted
6. To disassemble, simply press release button, hold against body and pull tubing out of fitting.

▲ WARNING These products can expose you to chemicals including LEAD which is known to the state of California to cause cancer.

[Click here for CADs, Product Specifications or to Configure Parts Online](#)

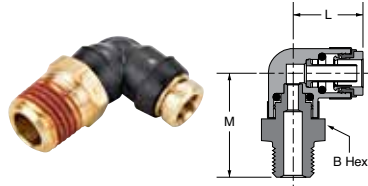

Male Elbow Swivel 90° VS369PTCR

PART NO.	TUBE SIZE	PIPE THREAD	B HEX	L	M
VS369PTCR-4-2	1/4	1/8	9/16	.74	1.00
VS369PTCR-4-4	1/4	1/4	9/16	.74	1.14
VS369PTCR-4-6	1/4	3/8	11/16	.74	1.14
VS369PTCR-6-2	3/8	1/8	3/4	1.01	1.24
VS369PTCR-6-4	3/8	1/4	3/4	1.01	1.45
VS369PTCR-6-6	3/8	3/8	3/4	1.01	1.28
VS369PTCR-6-8	3/8	1/2	7/8	1.01	1.49
VS369PTCR-8-4	1/2	1/4	15/16	1.13	1.42
VS369PTCR-8-6	1/2	3/8	15/16	1.13	1.42
VS369PTCR-8-8	1/2	1/2	15/16	1.13	1.61
VS369PTCR-10-6	5/8	3/8	1-1/16	1.36	1.61
VS369PTCR-10-8	5/8	1/2	1-1/16	1.36	1.80
VS369PTCR-12-8	3/4	1/2	1-3/16	1.47	1.91

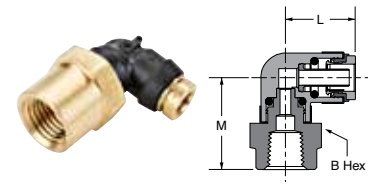

Female Elbow Swivel 90° 370PTCR

PART NO.	TUBE SIZE	PIPE THREAD	B HEX	L	M
370PTCR-4-2	1/4	1/8	9/16	.74	.94
370PTCR-4-4	1/4	1/4	11/16	.74	1.20
370PTCR-6-2	3/8	1/8	3/4	1.01	.75
370PTCR-6-4	3/8	1/4	3/4	1.01	1.04
370PTCR-6-6	3/8	3/8	3/4	1.01	1.19
370PTCR-8-6	1/2	3/8	3/4	1.13	1.24
370PTCR-8-8	1/2	1/2	15/16	1.13	1.49

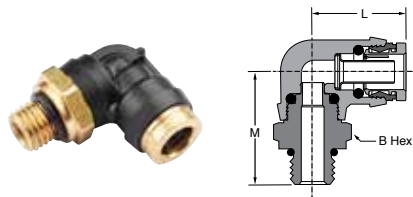

Male Elbow Swivel 90° Metric Straight Thread 369PTCR

PART NO.	TUBE SIZE	THREAD*	B HEX	L	M
369PTCR-4-MA12	1/4	MA12	11/16	0.74	1.13
369PTCR-4-MA16	1/4	MA16	7/8	0.74	1.16
369PTCR-4-MA22	1/4	MA22	1 1/16	0.74	1.28
369PTCR-6-MA12	3/8	MA12	3/4	1.01	1.22
369PTCR-6-MA16	3/8	MA16	7/8	1.01	1.29
369PTCR-6-MA22	3/8	MA22	1 1/16	1.01	1.28
369PTCR-8-MA12	1/2	MA12	15/16	1.13	1.39
369PTCR-8-MA16	1/2	MA16	15/16	1.13	1.41
369PTCR-8-MA22	1/2	MA22	1 1/16	1.13	1.4
369PTCR-10-MA12	5/8	MA12	1 1/16	1.36	1.63
369PTCR-10-MA16	5/8	MA16	1 1/16	1.36	1.58
369PTCR-10-MA22	5/8	MA22	1 1/16	1.36	1.57

*Per ISO 4039

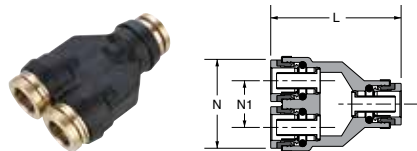

Union Y 362PTCR

PART NO.	TUBE SIZE	L	N	N1
362PTC-4	1/4	1.52	1.06	.50
362PTC-6	3/8	2.03	1.43	.68
362PTC-8	1/2	2.20	1.74	.84

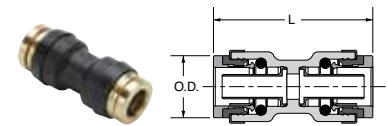

Union 32PTC

PART NO.	TUBE SIZE	TUBE SIZE 2	L	O.D.
32PTC-4	1/4		1.32	..53
32PTC-6	3/8		1.65	.73
32PTC-8	1/2		1.86	.88
32PTC-10	5/8		2.15	1.02
32PTC-12	3/4		2.50	1.17
32PTC-10-12	5/8	3/4		
32PTC-4-6M	1/4	6MM		
32PTC-6-4	3/8	1/4		
32PTC-8-6	1/2	3/8		

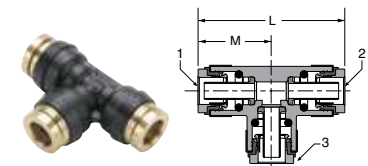

Union Tee 364PTC

PART NO.	TUBE SIZE 1	TUBE SIZE 2	TUBE SIZE 3	L	M
364PTC-4	1/4	1/4	1/4	1.42	.71
364PTC-6	3/8	3/8	3/8	2.03	.99
364PTC-8	1/2	1/2	1/2	2.29	1.13
364PTC-10	5/8	5/8	5/8	2.88	1.44
364PTC-6-6-4	3/8	3/8	1/4	2.03	1.01
364PTC-6-6-5/32	3/8	3/8	5/32	2.03	1.01
364PTC-4-4-6	1/4	1/4	3/8		
364PTC-4-6-4	1/4	3/8	1/4		

WARNING: These products can expose you to chemicals including LEAD which is known to the state of California to cause cancer.

[Click here for CADs, Product Specifications or to Configure Parts Online](#)

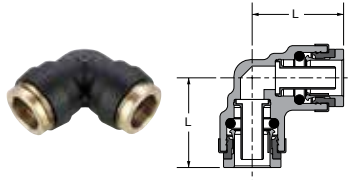

Union Elbow 365PTC

PART NO.	TUBE SIZE	L
365PTC-6	3/8	1.01
365PTC-8	1/2	1.13
365PTC-4	1/4	

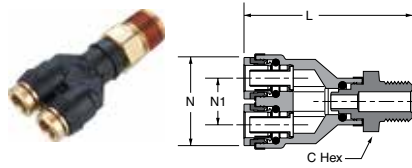

Union Y Male Connector VS368PTCR

PART NO.	TUBE SIZE	PIPE THREAD	L	C HEX	N	N1
VS368PTCR-4-2	1/4	1/8	1.96	9/16	1.03	.50
VS368PTCR-4-4	1/4	1/4	2.12	9/16	1.03	.50
VS368PTCR-6-4	3/8	1/4	2.56	3/4	1.41	.68

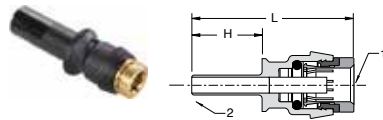

Plug-In Adapter 37PTCSP

PART NO.	TUBE SIZE 1	TUBE SIZE 2	H	L
37PTCSP-4-6	1/4	3/8	.90	1.71
37PTCSP-6-4	3/8	1/4	.76	1.66
37PTCSP-10-8	5/8	1/2	1.10	2.44

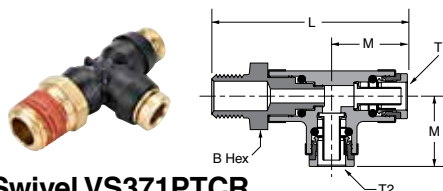

Male Run Tee Swivel VS371PTCR

PART NO.	TUBE SIZE 1	TUBE SIZE 2	PIPE THREAD	B HEX	L	M
VS371PTCR-4-2	1/4	1/4	1/8	9/16	1.80	.76
VS371PTCR-4-4	1/4	1/4	1/4	9/16	1.94	.76
VS371PTCR-6-4	3/8	3/8	1/4	3/4	2.25	.101
VS371PTCR-6-6	3/8	3/8	3/8	3/4	2.25	.101
VS371PTCR-8-4	1/2	1/2	1/4	15/16	2.59	1.15
VS371PTCR-8-6	1/2	1/2	3/8	15/16	2.59	1.15
VS371PTCR-8-8	1/2	1/2	1/2	15/16	2.78	1.15
371PTCR-4-6	1/4	1/4	3/8			
371PTCR-8-4-8	1/2	1/4	1/2			

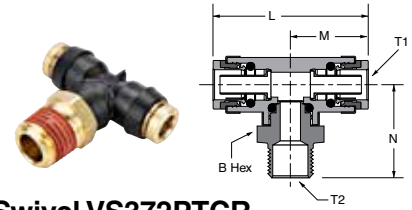

Male Branch Tee Swivel VS372PTCR

PART NO.	TUBE SIZE	PIPE THREAD	B HEX	L	M	N
VS372PTCR-4-2	1/4	1/4	1/8	1.52	.75	1.04
VS372PTCR-4-4	1/4	1/4	9/16	1.52	.76	1.18
VS372PTCR-6-2	3/8	3/8	3/4	2.03	1.01	1.16
VS372PTCR-6-4	3/8	3/8	1/4	2.03	1.01	1.27
VS372PTCR-6-6	3/8	3/8	3/4	2.02	1.01	1.27
VS372PTCR-8-4	1/2	1/2	1/4	2.30	1.15	1.42
VS372PTCR-8-6	1/2	1/2	3/8	2.30	1.15	1.42
VS372PTCR-8-8	1/2	1/2	1/2	2.30	1.15	1.61
VS372PTCR-10-8	5/8	5/8	1-1/16	2.88	1.44	1.80
VS372PTCR-4-6	1/4	3/8				
VS372PTCR-6-8	3/8	1/2				

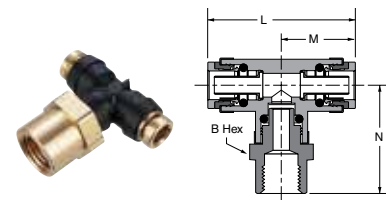

Female Branch Tee Swivel 377PTCR

PART NO.	TUBE SIZE	PIPE THREAD	B HEX	L	M	N
377PTCR-4-4	1/4	1/4	3/4	1.48	.74	1.27

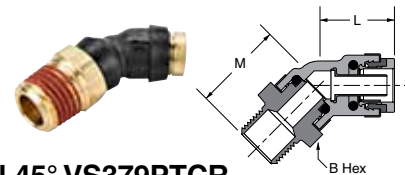

Male Elbow Swivel 45° VS379PTCR

PART NO.	TUBE SIZE	PIPE THREAD	B HEX	L	M
VS379PTCR-4-2	1/4	1/8	9/16	.68	.91
VS379PTCR-4-4	1/4	1/4	9/16	.68	1.05
VS379PTCR-6-2	3/8	1/8	3/4	.89	.97
VS379PTCR-6-4	3/8	1/4	3/4	.89	1.10
VS379PTCR-6-6	3/8	3/8	3/4	.89	1.11
VS379PTCR-6-8	3/8	1/2	7/8	.89	1.32
VS379PTCR-8-4	1/2	1/4	15/16	1.03	1.22
VS379PTCR-8-6	1/2	3/8	15/16	1.03	1.24
VS379PTCR-8-8	1/2	1/2	15/16	1.03	1.41
VS379PTCR-10-6	5/8	3/8	1-1/16	1.21	1.43
VS379PTCR-10-8	5/8	1/2	1-1/16	1.21	1.62
VS379PTCR-12-8	3/4	1/2	1-3/16	1.29	1.72
VS379PTCR-4-6	1/4	3/8			

WARNING These products can expose you to chemicals including LEAD which is known to the state of California to cause cancer.

[Click here for CADs, Product Specifications or to Configure Parts Online](#)

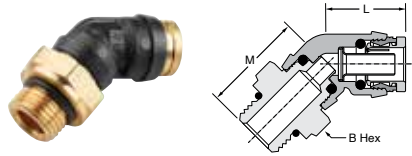

Male Elbow Swivel 45° Metric Straight Thread 379PTCR

PART NO.	TUBE SIZE	THREAD*	B HEX	L	M
379PTCR-4-MA12	1/4	MA12	1 1/16	0.68	1.05
379PTCR-4-MA16	1/4	MA16	7/8	0.68	1.07
379PTCR-4-MA22	1/4	MA22	1 1/16	0.68	1.19
379PTCR-6-MA12	3/8	MA12	3/4	0.89	1.09
379PTCR-6-MA16	3/8	MA16	7/8	0.89	1.16
379PTCR-6-MA22	3/8	MA22	1 1/16	0.89	1.16
379PTCR-8-MA12	1/2	MA12	15/16	1.03	1.21
379PTCR-8-MA16	1/2	MA16	15/16	1.03	1.21
379PTCR-8-MA22	1/2	MA22	1 1/16	1.03	1.21
379PTCR-10-MA12	5/8	MA12	1 1/16	1.21	1.45
379PTCR-10-MA16	5/8	MA16	1 1/16	1.21	1.4
379PTCR-10-MA22	5/8	MA22	1 1/16	1.21	1.4

*Per ISO 4039

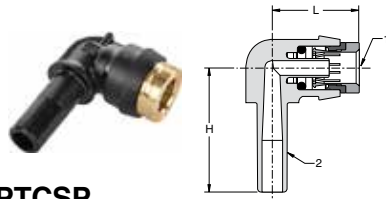

Plug-In Elbow 369PTCSP

PART NO.	TUBE SIZE 1	TUBE SIZE 2	H	L
369PTCSP-4-4	1/4	1/4	1.06	.74
369PTCSP-4-6	1/4	3/8	1.20	.74
369PTCSP-6-4	3/8	1/4	1.18	.96
369PTCSP-6-6	3/8	3/8	1.32	0.96
369PTCSP-6-8	3/8	1/2	1.52	.96
369PTCSP-8-4	1/2	1/4	1.16	1.12
369PTCSP-10-8	5/8	1/2	1.57	1.36
369PTCSP-8-6	1/2	3/8		
369PTCSP-8-8	1/2	1/2		
369PTC-10-10	5/8	5/8		

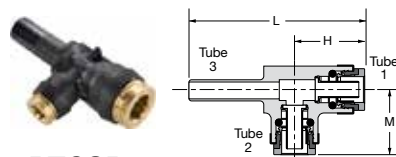

Plug-In Run Tee 371PTCSP

PART NO.	TUBE SIZE 1	TUBE SIZE 2	TUBE SIZE 3	H	L	M
371PTCSP-4-4	1/4	1/4	1/4	.78	1.84	.76
371PTCSP-4-6	1/4	1/4	3/8	.78	1.98	.76
371PTCSP-6-4	3/8	3/8	1/4	1.01	2.11	1.01
371PTCSP-6-6	3/8	3/8	3/8	1.01	2.25	1.01
371PTCSP-6-4-6	3/8	1/4	3/8	0.76	2.24	1.01
371PTCSP-8-4-8	1/2	1/4	1/2	0.96	2.58	1.15

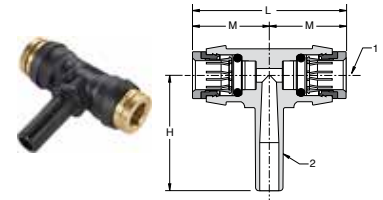

Plug-In Branch Tee 372PTCSP

PART NO.	TUBE SIZE 1	TUBE SIZE 2	H	L	M
372PTCSP-4-4	1/4	1/4	1.05	1.48	.74
372PTCSP-4-6	1/4	3/8	1.19	1.48	.74
372PTCSP-6-4	3/8	1/4	1.18	2.02	1.01
372PTCSP-6-6	3/8	3/8	1.32	2.02	1.01



Presto Manifold 24M

PART NO.	TUBE O.D. INLET	TUBE O.D. OUTLET	A	B	D	G	H	M	M1	N
24M-4-4	1/4	1/4	1.33	4.15	.21	2.75	.53	.90	.88	.89
24M-6-4	3/8	1/4	1.33	3.99	.21	2.75	.53	.90	.88	.89
24M-6-6	3/8	3/8	1.65	6.49	.22	4.55	.60	1.02	1.02	1.33
24M-8-8	1/2	1/2	1.65	6.49	.22	4.55	.60	1.02	1.02	1.33
24M-8-6446	1/2	3/8 - 1/4	1.65	6.51	.22	4.55	.64	1.02	1.02	1.17

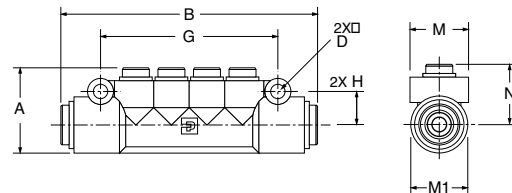

Assembly Instructions

1. Cut tubing squarely with Parker tube cutter PTC-001. Be certain that Manifold ports are clean and free of debris.
2. Insert tubing into port until it bottoms. Pull on tubing to verify that it is properly retained in the manifold.
3. To disassemble, simply hold release button against the manifold body and remove the tubing.
4. To reassemble, make certain that the Manifold ports are clean and free of debris and lubricate leading end of the tubing with light oil or petroleum jelly.

WARNING These products can expose you to chemicals including LEAD which is known to the state of California to cause cancer.

[Click here for CADs, Product Specifications or to Configure Parts Online](#)



AQRT - Quick Release Tool

Makes disconnection of tube adapters and tubing a breeze.



PTCB Collet Caps

	TUBE O.D.			
	1/4	3/8	1/2	5/8
WHITE PART NO.	4-PTCB-W	6-PTCB-W	8-PTCB-W	10-PTCB-W
BLACK PART NO.	4-PTCB-BL	6-PTCB-BL	8-PTCB-BL	10-PTCB-BL
GREEN PART NO.	4-PTCB-G	6-PTCB-G	8-PTCB-G	10-PTCB-G
RED PART NO.	4-PTCB-R	6-PTCB-R	8-PTCB-R	10-PTCB-R
BLUE PART NO.	4-PTCB-BU	6-PTCB-BU	8-PTCB-BU	10-PTCB-BU
YELLOW PART NO.	4-PTCB-Y	6-PTCB-Y	8-PTCB-Y	10-PTCB-Y
BROWN PART NO.	4-PTCB-BR	6-PTCB-BR	8-PTCB-BR	10-PTCB-BR
GREY PART NO.	4-PTCB-GR	6-PTCB-GR	8-PTCB-GR	10-PTCB-GR
ORANGE PART NO.	4-PTCB-O	6-PTCB-O	8-PTCB-O	10-PTCB-O
PURPLE PART NO.	4-PTCB-PU	6-PTCB-PU	8-PTCB-PU	10-PTCB-PU
DARK PURPLE PART NO.	4-PTCB-DPU	6-PTCB-DPU	8-PTCB-DPU	10-PTCB-DPU

⚠️ WARNING: These products can expose you to chemicals including LEAD which is known to the state of California to cause cancer.

PTC Brass Fittings



Parker's PTC Brass Fittings are robust, all brass push-to-connect fittings that meet SAE and D.O.T. specifications. Designed for all D.O.T truck and trailer applications, Parker PTC Brass fittings reduce assembly time versus compression style fittings by 90%.

Product Features:

- Brass Collet
- Buna N O-ring
- Stainless Steel Tube Support
- Meets D.O.T. FMVSS571.106
- Meets SAE J2494 & SAE J2494-3

Markets:

- Heavy Duty Truck
- Trailer
- Mobile

Applications:

- Air Brakes
- Air Tanks
- Air Ride
- Sliders
- Tire Inflation
- Primary & Secondary Air Lines

Specifications:

Pressure Range Up to 250 PSI (17.2 bar)

Temperature Range -40° to +200° F (-40° to +93.3° C)

Compatible Tubing:

- SAE J844 Type A & B nylon tubing

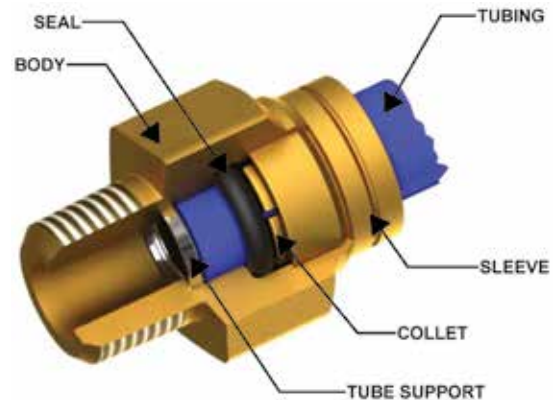

Assembly Instructions

1. Cut tubing squarely – maximum of 15° angle allowable.
2. Check that port or mating part is clean and free of debris.
3. Mark tubing to appropriate tube insertion length. (see Tube Insertion Chart on page N22)
4. Insert tubing until it bottoms
5. Pull on tubing to verify it is fully inserted
6. To disassemble, simply press release button, hold against body and pull tubing out of fitting.



Note:
5/32 and 3/16 units
have black button



Note:
Use VS prefix to order
with Vibra Seal

⚠ WARNING These products can expose you to chemicals including NICKEL or LEAD, which are known to the state of California to cause cancer and LEAD.

[Click here for CADs, Product Specifications or to Configure Parts Online](#)

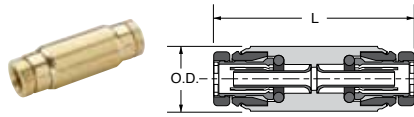

Union 62PTC

PART NO.	TUBE SIZE	TUBE SIZE 2	L	O. D.
62PTC-5/32*	5/32	5/32	1.35	.41
62PTC-3*	3/16	3/16	1.36	.44
62PTC-4	1/4	1/4	1.37	1/2
62PTC-6	3/8	3/8	1.77	3/4
62PTC-6-4	3/8	1/4	1.57	3/4
62PTC-4-5/32	1/4	5/32		
62PTC-8	1/2	1/2	1.92	7/8
62PTC-10	5/8	5/8	2.32	1

*5/32 and 3/16 with black button

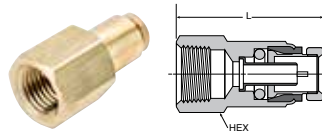

Male Connector 68PTC

PART NO.	TUBE SIZE	PIPE THREAD	HEX	L
68PTC-5/32-1*	5/32	1/16	7/8	.84
68PTC-5/32-2*	5/32	1/8	7/16	.92
68PTC-5/32-4*	5/32	1/4	9/16	1.02
68PTC-3-1*	3/16	1/16	7/16	.93
68PTC-3-2*	3/16	1/8	7/16	.85
68PTC-3-4*	3/16	1/4	9/16	1.02
68PTC-4-2	1/4	1/8	1/2	.98
68PTC-4-4	1/4	1/4	9/16	1.02
68PTC-4-6	1/4	3/8	11/16	.93
68PTC-6-2	3/8	1/8	11/16	1.27
68PTC-6-4	3/8	1/4	11/16	1.36
68PTC-6-6	3/8	3/8	11/16	1.16
68PTC-6-8	3/8	1/2	7/8	1.33
68PTC-8-4	1/2	1/4	7/8	1.49
68PTC-8-6	1/2	3/8	7/8	1.49
68PTC-8-8	1/2	1/2	7/8	1.49
68PTC-10-6	5/8	3/8	1	1.74
68PTC-10-8	5/8	1/2	1	1.81
68PTC-12-8	3/4	1/2	1-1/8	1.89
68PTC-12-12	3/4	3/4	1/4	1.89

*5/32 and 3/16 with black button
 **Add VS prefix to order with Vibra Seal

Female Connector 66PTC

PART NO.	TUBE SIZE	PIPE THREAD	L	HEX
66PTC-5/32-2*	5/32	1/8	1.16	9/16
66PTC-5/32-4*	5/32	1/4	1.33	11/16
66PTC-3-2*	3/16	1/8	1.17	9/16
66PTC-4-2	1/4	1/8	9/16	1.17
66PTC-4-4	1/4	1/4	11/16	1.37
66PTC-4-6	1/4	3/8		
66PTC-6-2	3/8	1/8	3/4	1.38
66PTC-6-4	3/8	1/4	3/4	1.59
66PTC-6-6	3/8	3/8	3/4	1.59
66PTC-8-4	1/2	1/4	7/8	1.61
66PTC-8-6	1/2	3/8	15/16	1.87
66PTC-8-8	1/2	1/2	15/16	1.87
66PTC-10-6	5/8	3/8		
66PTC-10-8	5/8	1/2		

*5/32 and 3/16 with black button

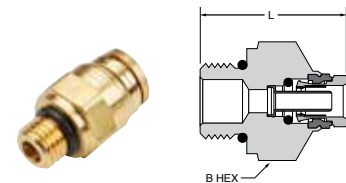

Male Connector Metric Straight Thread 68PTC

PART NO.	TUBE SIZE	THREAD*	B HEX	L
68PTC-4-MA12	1/4	MA12	11/16	1.14
68PTC-4-MA16	1/4	MA16	7/8	1.21
68PTC-4-MA22	1/4	MA22	1 1/16	1.21
68PTC-6-MA12	3/8	MA12	3/4	1.31
68PTC-6-MA16	3/8	MA16	7/8	1.23
68PTC-6-MA22	3/8	MA22	1 1/16	0.74
68PTC-8-MA12	1/2	MA12	7/8	1.37
68PTC-8-MA16	1/2	MA16	7/8	1.39
68PTC-8-MA22	1/2	MA22	1 1/16	0.91
68PTC-10-MA12	5/8	MA12	1	1.67
68PTC-10-MA16	5/8	MA16	1	1.61
68PTC-10-MA22	5/8	MA22	1 1/16	1.37

*Per ISO 4039

WARNING These products can expose you to chemicals including NICKEL or LEAD, which are known to the state of California to cause cancer and LEAD.

[Click here for CADs, Product Specifications or to Configure Parts Online](#)

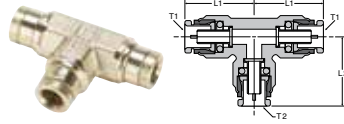

Union Tee 164PTC

PART NO.	TUBE 1 SIZE	TUBE 2 SIZE	L1	L2
164PTC-5/32*	5/32	5/32	.77	.77
164PTC-3*	3/16	3/16	.77	.77
164PTC-4	1/4	1/4	.85	.85
164PTC-6	3/8	3/8	.81	.81
164PTC-6-6-4	3/8	1/4	1.10	.90
164PTC-8	1/2	1/2	1.31	1.31
164PTC-10	5/8	5/8	1.57	1.57

*5/32 and 3/16 with black button

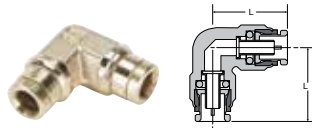

Union Elbow 165PTC

PART NO.	TUBE SIZE	L
165PTC-5/32*	5/32	.79
165PTC-3*	3/16	.77
165PTC-4	1/4	.80
165PTC-6	3/8	1.20
165PTC-8	1/2	1.22
165PTC-10	5/8	1.49

*5/32 and 3/16 with black button

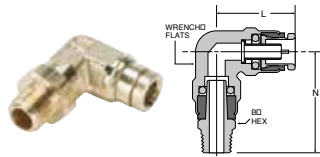

Male Elbow 90° 169PTC

PART NO.	TUBE SIZE	PIPE THREAD	L	N	WRENCH FLATS	B HEX
169PTC-4-2	1/4	1/8	.85	.96	1/2	9/16
169PTC-4-4	1/4	1/4	.85	1.22	1/2	9/16
169PTC-4-6	1/4	3/8	.85	1.22	1/2	11/16
169PTC-6-2	3/8	1/8	1.02	1.21	9/16	11/16
169PTC-6-4	3/8	1/4	1.02	1.33	9/16	11/16
169PTC-6-6	3/8	3/8	1.02	1.33	9/16	11/16
169PTC-6-8	3/8	1/2	1.02	1.33	9/16	7/8
169PTC-8-4	1/2	1/4	1.16	1.40	11/16	11/16
169PTC-8-6	1/2	3/8	1.16	1.42	11/16	11/16
169PTC-8-8	1/2	1/2	1.16	1.63	11/16	7/8
169PTC-10-6	5/8	3/8	1.47	1.41	7/8	7/8
169PTC-10-8	5/8	1/2	1.47	1.6	7/8	7/8

*Add VS prefix to order with Vibra Seal

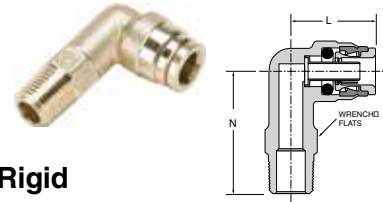

Male Elbow Long Rigid 90° 169PTCNSL

PART NO.	TUBE SIZE	PIPE THREAD	L	N	WRENCH FLATS
169PTCNSL-6-4	3/8	1/4	1.01	1.63	9/16
169PTCNSL-6-8	3/8	1/2	1.19	2.50	7/8
169PTCNSL-6-6	3/8	3/8	1.19	2.50	7/8
169PTCNSL-8-8	1/2	1/2	1.22	2.50	7/8

*Add VS prefix to order with Vibra Seal

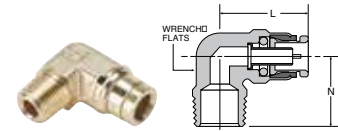

Male Elbow Rigid 90° 169PTCNS

PART NO.	TUBE SIZE	PIPE THREAD	L	N	WRENCH FLATS
169PTCNS-5/32-1*	5/32	1/16	.79	.62	.40
169PTCNS-5/32-2*	5/32	1/8	.84	.65	.40
169PTCNS-5/32-4*	5/32	1/4	.76	.85	.50
169PTCNS-3-2*	3/16	1/8	.77	.65	.40
169PTCNS-3-4*	3/16	1/4	.77	.85	.50
169PTCNS-4-2	1/4	1/8	.84	.72	1/2
169PTCNS-4-4	1/4	1/4	.85	.90	1/2
169PTCNS-4-6	1/4	3/8	.85	1.06	1/2
169PTCNS-6-2	3/8	1/8	1.05	.75	9/16
169PTCNS-6-4	3/8	1/4	1.05	.94	9/16
169PTCNS-6-6	3/8	3/8	1.02	.94	9/16
169PTCNS-6-8	3/8	1/2	1.06	1.26	11/16
169PTCNS-8-4	1/2	1/4	1.16	1.06	11/16
169PTCNS-8-6	1/2	3/8	1.16	1.06	11/16
169PTCNS-8-8	1/2	1/2	1.16	1.26	11/16
169PTCNS-10-6	5/8	3/8	1.49	1.05	7/8
169PTCNS-10-8	5/8	1/2	1.48	1.24	7/8
169PTCNS-12-8	3/4	1/2	1.61	1.44	1
169PTCNS-12-12	3/4	3/4	1.61	1.50	1
169PTCNS-12-12	3/4	3/4			

*5/32 and 3/16 with black button

**Add VS prefix to order with Vibra Seal

WARNING These products can expose you to chemicals including NICKEL or LEAD, which are known to the state of California to cause cancer, and LEAD.

Click here for CADs, Product Specifications or to Configure Parts Online

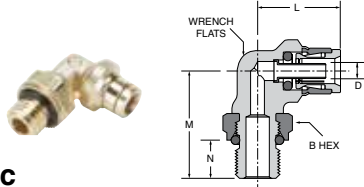

Male Elbow to Metric Adjustable 169PTCNSL

PART NO.	TUBE SIZE	METRIC THREAD	WRENCH FLATS (MM)	HEX (MM)	L	M	N
169PTCNSL-4-MI2	1/4	M12X1.5	10	17	.84	1.11	.37
169PTCNSL-4-M16	1/4	M16X1.5	11	24	.88	1.27	.34
169PTCNSL-4-M22	1/4	M22X1.5	19	30	.94	1.48	.37
169PTCNSL-6-M12	3/8	M12X1.5	16	17	1.00	1.15	.37
169PTCNSL-6-M16	3/8	M16X1.5	19	24	1.18	1.27	.37
169PTCNSL-8-M12	1/2	M12X1.5	16	17	1.21	1.31	.37
169PTCNSL-8-M16	1/2	M16X1.5	16	24	1.20	1.28	.41
169PTCNSL-8-M22	1/2	M22X1.5	19	30	1.20	1.48	.41

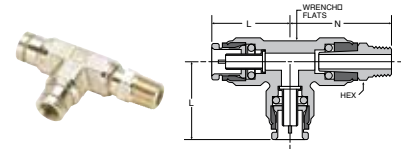

Male Run Tee Swivel 171PTC

PART NO.	TUBE SIZE	PIPE THREAD	L	N	HEX	WRENCH FLATS
171PTC-4-2	1/4	1/8	.82	1.01	9/16	1/2
171PTC-4-4	1/4	1/4	.82	1.23	9/16	1/2
171PTC-4-6	1/4	3/8	.82	1.23	11/16	1/2
171PTC-6-4	3/8	1/4	1.10	1.35	11/16	5/8
171PTC-6-6	3/8	3/8	1.10	1.38	11/16	5/8
171PTC-8-4	1/2	1/4	1.31	1.45	11/16	3/4
171PTC-8-6	1/2	3/8	1.31	1.48	11/16	3/4
171PTC-8-8	1/2	1/2	1.31	1.69	7/8	3/4

*Add VS prefix to order with Vibra Seal

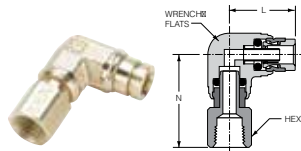

Female Elbow Swivel 90° 170PTC

PART NO.	TUBE SIZE	PIPE THREAD	L	N	HEX	WRENCH FLATS
170PTC-4-2	1/4	1/8	.85	1.06	9/16	1/4

*Add VS prefix to order with Vibra Seal

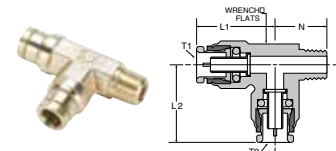

Male Run Tee Rigid 171PTCNS

PART NO.	TUBE 1 SIZE	TUBE 2 SIZE	PIPE THREAD	L1	L2	N	WRENCH FLATS
171PTCNS-5/32-2*	5/32	5/32	1/8	.76	.76	.75	7/16
171PTCNS-5/32-4*	5/32	5/32	1/4	.76	.76	.88	7/16
171PTCNS-3-2*	3/16	3/16	1/8	.77	.77	.75	7/16
171PTCNS-4-2	1/4	1/4	1/8	.91	.91	.77	15/32
171PTCNS-4-4	1/4	1/4	1/4	.88	.88	.91	15/32
171PTCNS-4-6-4	1/4	3/8	1/4	.88	1.10	.97	5/8
171PTCNS-6-4	3/8	3/8	1/4	1.10	1.10	.97	5/8
171PTCNS-6-4-4	3/8	1/4	1/4	1.10	.88	.97	5/8
171PTCNS-6-4-6	3/8	1/4	3/8	1.22	.97	.93	5/8
171PTCNS-6-6	3/8	3/8	3/8	1.10	1.10	.91	5/8
171PTCNS-6-8	3/8	3/8	1/2	1.09	1.17	1.26	5/8
171PTCNS-8-4	1/2	1/2	1/4	1.31	1.28	1.07	3/4

*5/32 and 3/16 with black button

**Add VS prefix to order with Vibra Seal

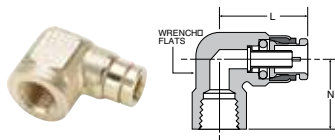

Female Elbow Rigid 90° 170PTCNS

PART NO.	TUBE SIZE	PIPE THREAD	L	N	WRENCH FLATS
170PTCNS-4-2	1/4	1/8	.84	.56	11/16
170PTCNS-4-4	1/4	1/4	.91	.67	11/16
170PTCNS-6-2	3/8	1/8	1.07	.51	9/16
170PTCNS-6-4	3/8	1/4	1.07	.84	9/16
170PTCNS-6-6	3/8	3/8	1.24	.69	7/8
170PTCNS-8-4	1/2	1/4	1.25	.75	11/16
170PTCNS-8-6	1/2	3/8	1.36	.80	11/16
170PTCNS-8-8	1/2	1/2	1.63	.97	1
170PTCNS-5/32-2	5/32	1/8			

WARNING: These products can expose you to chemicals including NICKEL or LEAD, which are known to the state of California to cause cancer and LEAD.

[Click here for CADs, Product Specifications or to Configure Parts Online](#)

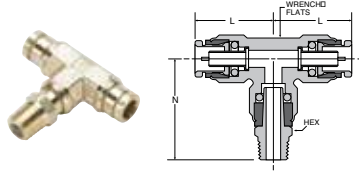

Male Branch Tee Swivel 172PTC

PART NO.	TUBE SIZE	PIPE THREAD	L	N	HEX	WRENCH FLATS
172PTC-4-2	1/4	1/8	.82	1.02	9/16	1/2
172PTC-4-4	1/4	1/4	.82	1.23	9/16	1/2
172PTC-6-2	3/8	1/8	1.10	1.34	11/16	5/8
172PTC-6-4	3/8	1/4	1.10	1.45	11/16	5/8
172PTC-6-6	3/8	3/8	1.10	1.48	11/16	5/8
172PTC-8-4	1/2	1/4	1.31	1.45	5/8	3/4
172PTC-8-6	1/2	3/8	1.31	1.48	11/16	3/4
172PTC-8-8	1/2	1/2	1.31	1.97	7/8	3/4

*5/32 and 3/16 with black button
 **Add VS prefix to order with Vibra Seal

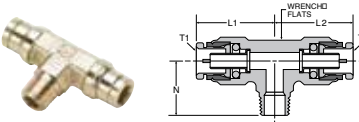

Male Branch Tee Rigid 172PTCNS

PART NO.	TUBE 1 SIZE	TUBE 2 SIZE	PIPE THREAD	L1	L2	N	WRENCH FLATS
172PTCNS-5/32-2"	5/32	1/8	.78	.75	7/16	.47	15/32
172PTCNS-5/32-4"	5/32	1/4	.78	.88	7/16	.47	15/32
172PTCNS-3-2"	3/16	1/8	.77	.75	7/16	.47	15/32
172PTCNS-4-2	1/4	1/4	1/8	.91	.91	.77	1/2
172PTCNS-4-4	1/4	1/4	1/4				
172PTCNS-6-4	3/8	3/8	1/4	1.10	1.10	.97	5/8
172PTCNS-6-4-4	3/8	1/4	1/4	1.10	.85	.97	5/8
172PTCNS-6-6	3/8	3/8	3/8	1.04	1.04	.91	5/8
172PTCNS-6-8	3/8	3/8	1/2	1.17	1.17	1.26	7/8
172PTCNS-8-6	1/2	1/2	3/8	1.31	1.31	1.07	3/4
172PTCNS-8-6-8	1/2	3/8	1/2	1.31	1.24	1.25	3/4
172PTCNS-8-8	1/2	1/2	1/2	1.31	1.31	1.25	3/4

*Add VS prefix to order with Vibra Seal

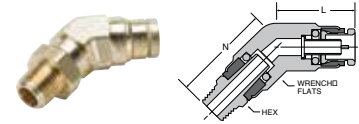

Male Elbow Swivel 45° 179PTC

PART NO.	TUBE SIZE	PIPE THREAD	L	N	HEX	WRENCH FLATS
179PTC-4-2	1/4	1/8	.76	.93	9/16	9/16
179PTC-4-4	1/4	1/4	.76	1.15	9/16	9/16
179PTC-6-2	3/8	1/8	.95	1.05	11/16	3/4
179PTC-6-4	3/8	1/4	.95	1.17	11/16	3/4
179PTC-6-6	3/8	3/8	.95	1.20	11/16	3/4
179PTC-8-4	1/2	1/4	1.15	1.70	13/16	13/16
179PTC-8-6	1/2	3/8	1.15	1.78	13/16	13/16
179PTC-8-8	1/2	1/2	1.15	1.93	7/8	13/16
179PTC-10-8	5/8	1/2				

*Add VS prefix to order with Vibra Seal

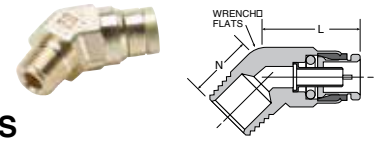

Male Elbow Rigid 45° 179PTCNS

PART NO.	TUBE SIZE	PIPE THREAD	L	N	WRENCH FLATS
179PTCNS-4-2	1/4	1/8	.74	.56	9/16
179PTCNS-4-4	1/4	1/4	.74	.69	9/16
179PTCNS-6-2	3/8	1/8	1.06	.60	9/16
179PTCNS-6-4	3/8	1/4	1.06	.69	9/16
179PTCNS-6-6	3/8	3/8	1.06	.85	9/16
179PTCNS-6-8	3/8	1/2			
179PTCNS-8-4	1/2	1/4	1.15	.75	13/16
179PTCNS-8-6	1/2	3/8	1.15	.75	13/16
179PTCNS-8-8	1/2	1/2	1.15	1.00	13/16
179PTCNS-10-6	5/8	3/8	1.20	.76	7/8
179PTCNS-10-8	5/8	1/2	1.21	.95	7/8
179PTCNS-12-8	3/4	1/2	1.33	1.19	1

*Add VS prefix to order with Vibra Seal

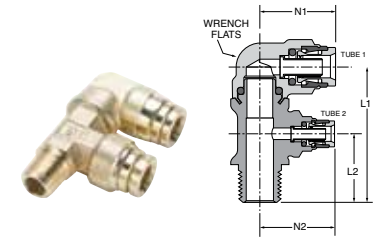

Dual Port 90 Male Elbow Positional 189PTC

PART NO.	TUBE 1 SIZE	TUBE 2 SIZE	PIPE THREAD	L1	L2	N1	N2	WRENCH FLATS
189PTC-6-4-6	3/8	1/4	3/8	2.12	1.05	1.21	1.19	11/16
189PTC-6-6-4	3/8	3/8	1/4	2.06	.98	1.12	1.20	9/16
189PTC-6-6-6	3/8	3/8	3/8	2.06	.98	1.12	1.20	9/16
189PTC-10-4-6	5/8	1/4	3/8	2.27	.99	1.47	1.13	7/8
189PTC-10-6-6	5/8	3/8	3/8	2.35	1.06	1.47	1.13	7/8
189PTC-8-4-8	1/2	1/4	1/2					
189PTC-8-6-6	1/2	3/8	3/8					
189PTC-8-6-8	1/2	3/8	1/2					
189PTC-10-4-8	5/8	1/4	1/2					
189PTC-10-6-8	5/8	3/8	1/2					
189PTC-10-10-8	5/8	5/8	1/2					

*Add VS prefix to order with Vibra Seal

WARNING These products can expose you to chemicals including NICKEL or LEAD, which are known to the state of California to cause cancer and LEAD.

Retaining Ring Bulkhead Unions

Retaining ring bulkhead unions feature a unique design that provides the user with an economical method to install and assemble a union connection through a bulkhead.

The retaining ring bulkhead unions feature a smaller envelope size than standard bulkhead union connectors and do not require a wrench to mount or assemble in cramped areas.

The external seal feature provides a moisture barrier and can also prevent external contamination from entering into an enclosed area.

To install, simply support the bulkhead union from behind and apply the external seal. Then push the external retainer against the external seal with an assembly tool and you have a reliable bulkhead connection in a confined area.

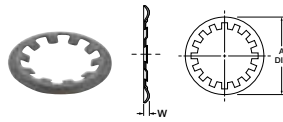
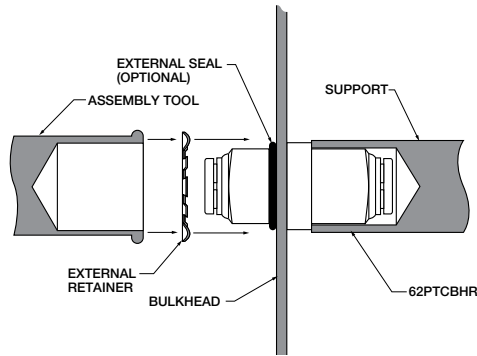

External Retainer ERHD*

PART NO.	TUBE SIZE	BULKHEAD UNION O.D.	A DIA.	W
ERHD-50	1/4	.500	.83	.05
ERHD-75	3/8	.750	1.08	.05
ERHD-87	1/2	.875	1.20	.05
ERHD-100	5/8	1.000	1.33	.06

*Material Carbon Spring Steel

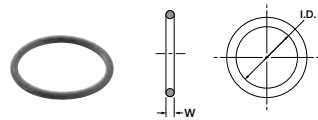

External Seal ES*

PART NO.	TUBE SIZE	BULKHEAD UNION O.D.	I.D.	W
2564-40001-L	1/4	.500	.489	.07
2564-60001	3/8	.750	.739	.07
2564-00253	1/2	.875	.864	.07

*Material is Nitrite (Buna N), 70 Durometer

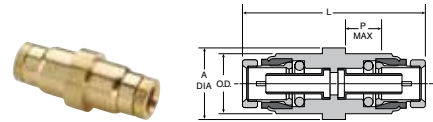

Retaining Ring Bulkhead 62PTCBHR

PART NO.	TUBE SIZE	O. D.	REC. HOLE SIZE	L	P MAX	A DIA.
62PTCBHR-4*	1/4	.500	.512	1.53	.26	.625
62PTCBHR-6	3/8	.750	.762	1.92	.36	.875
62PTCBHR-8	1/2	.875	.887	2.15	.43	1.000
62PTCBHR-10	5/8	1.000	1.012	2.32	.48	1.250

*Sleeve color may vary

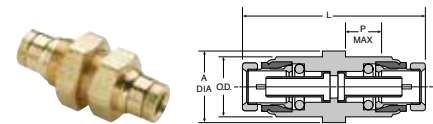

Bulkhead Union 62PTCBH

PART NO.	TUBE SIZE	O. D.	L	P MAX	HEX A	HEX B	A DIA.
62PTCBH-4*	1/4	.56	1.69	.25	11/16	3/4	9/16
62PTCBH-6	3/8	.88	1.93	.44	1-1/16	1-1/16	7/8
62PTCBH-8	1/2	1.00	2.02	.58	1-1/4	1-1/4	1
62PTCBH-10	5/8	1.12	2.40	.81	1-1/4	1-3/8	1-1/8

*Sleeve color may vary

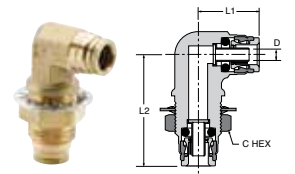

Union Bulkhead Elbow 165PTCBH

PART NO.	TUBE SIZE	L1	L2	C HEX	FLOW DIA. D	BULKHEAD HOLE DIA.
165PTCBH-8	1/2	1.20	2.51	1 1/4	.34	1

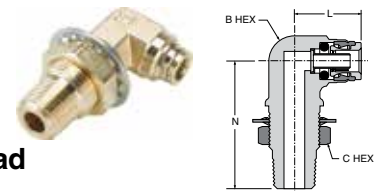

Male Elbow Bulkhead 169PTCBH

PART NO.	TUBE SIZE	PIPE THREAD	L	N	B HEX	C HEX	BULKHEAD HOLE DIA.
169PTCBH-6-8	3/8	1/2	1.19	2.50	1-1/4	7/8	1

WARNING These products can expose you to chemicals including NICKEL or LEAD, which are known to the state of California to cause cancer and LEAD.

[Click here for CADs, Product Specifications or to Configure Parts Online](#)

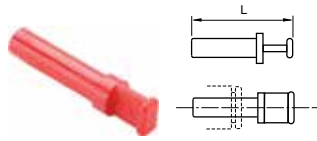

639PLP Plug

PART NO.	TUBE SIZE (IN)	L
639PLP-4	1/4	1.44
639PLP-6	3/8	1.67
639PLP-8	1/2	1.91



AQRT - Quick Release Tool

Makes disconnection of tube adapters and tubing a breeze.



PTCB Collet Caps

	TUBE O. D.			
	1/4	3/8	1/2	5/8
WHITE PART NO.	4-PTCB-W	6-PTCB-W	8-PTCB-W	10-PTCB-W
BLACK PART NO.	4-PTCB-BL	6-PTCB-BL	8-PTCB-BL	10-PTCB-BL
GREEN PART NO.	4-PTCB-G	6-PTCB-G	8-PTCB-G	10-PTCB-G
RED PART NO.	4-PTCB-R	6-PTCB-R	8-PTCB-R	10-PTCB-R
BLUE PART NO.	4-PTCB-BU	6-PTCB-BU	8-PTCB-BU	10-PTCB-BU
YELLOW PART NO.	4-PTCB-Y	6-PTCB-Y	8-PTCB-Y	10-PTCB-Y
BROWN PART NO.	4-PTCB-BR	6-PTCB-BR	8-PTCB-BR	10-PTCB-BR
GREY PART NO.	4-PTCB-GR	6-PTCB-GR	8-PTCB-GR	10-PTCB-GR
ORANGE PART NO.	4-PTCB-O	6-PTCB-O	8-PTCB-O	10-PTCB-O
PURPLE PART NO.	4-PTCB-PU	6-PTCB-PU	8-PTCB-PU	10-PTCB-PU
DARK PURPLE PART NO.	4-PTCB-DPU	6-PTCB-DPU	8-PTCB-DPU	10-PTCB-DPU

⚠️ WARNING These products can expose you to chemicals including NICKEL or LEAD, which are known to the state of California to cause cancer and LEAD.

Metric Prestomatic Fittings



Parker's Metric Prestomatic Fittings are robust, all brass push-to-connect fittings that meet DIN and D.O.T. specifications. Designed for all D.O.T truck and trailer applications, Parker Metric Prestomatic fittings reduce assembly time versus compression style fittings by 90%.

Product Features:

- Brass Collet
- Buna N O-ring
- Stainless Steel Tube Support
- Meets D.O.T. FMVSS571.106
- Meets DIN 74324

Markets:

- Heavy Duty Truck
- Trailer
- Mobile

Applications:

- Air Brakes
- Air Tanks
- Air Ride
- Sliders
- Tire Inflation
- Primary & Secondary Air Lines

Specifications:

Pressure Range Up to 250 PSI (17.2 bar)

Temperature Range -40° to +200° F (-40° to +93.3° C)

Compatible Tubing:

- DIN 73378 Virgin Nylon
- SAE J844 Type A & B nylon tubing

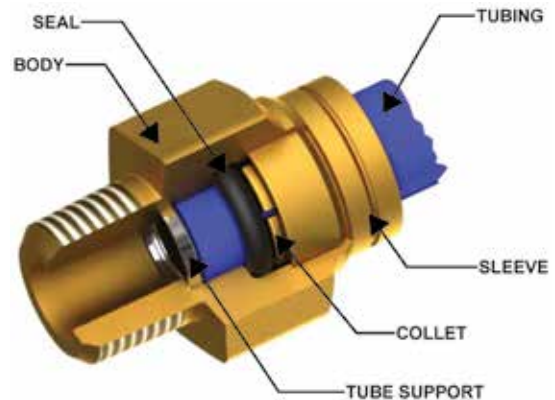

Assembly Instructions

1. Cut tubing squarely – maximum of 15° angle allowable.
2. Check that port or mating part is clean and free of debris.
3. Mark tubing to appropriate tube insertion length. (see Tube Insertion Chart on page N22)
4. Insert tubing until it bottoms
5. Pull on tubing to verify it is fully inserted
6. To disassemble, simply press release button, hold against body and pull tubing out of fitting.

⚠ WARNING These products can expose you to chemicals including NICKEL or LEAD, which are known to the state of California to cause cancer and LEAD.

[Click here for CADs, Product Specifications or to Configure Parts Online](#)

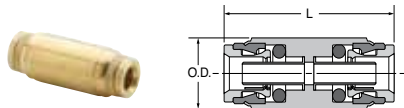

Union HPMTB

PART NO.	TUBE SIZE (MM)	L (MM)	O.D. (MM)
HPMTB6	6	45.2	15.9
HPMTB8	8	45.3	17.5
HPMTB10	10	51.7	22.2
HPMTB12	12	51.7	22.2

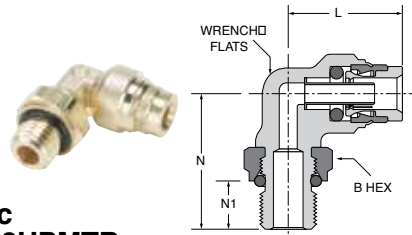

Male Elbow Metric Straight Thread C8UPMTB

PART NO.	TUBE SIZE (MM)	B METRIC THREAD	WRENCH FLATS (MM)	HEX (MM)	L (MM)	N (MM)	N1 (MM)
C8UPMTB6-M12	6	M12X1.5	10	17	24.8	28.2	9.5
C8UPMTB6-M16	6	M16X1.5	11	24	25.0	34.0	10.5

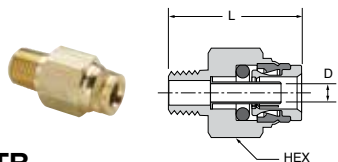

Male Connector F2PMTB

PART NO.	TUBE (MM)	PIPE THREAD	L (MM)	HEX (MM)	FLOW DIA. D(MM)
F2PMTB8-1/8	8	1/8	33.79	19	4.90
F2PMTB10-1/4	10	1/4	36.83	20	6.35

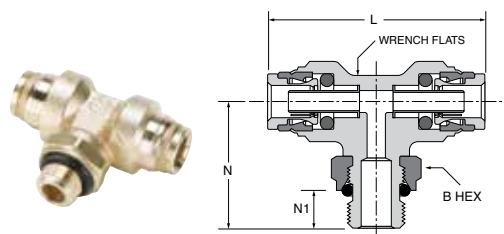

Male Branch Tee Swivel Metric Straight Thread S8UPMTB

PART NO.	TUBE SIZE (MM)	METRIC THREAD	WRENCH FLATS (MM)	HEX (MM)	L (MM)	N (MM)	N1 (MM)
S8UPMTB12-M16	12	M16X1.5	19	24	65.9	37.6	10.5

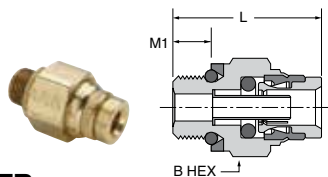

Male Connector Metric Straight Thread F8UPMTB

PART NO.	TUBE SIZE (mm)	METRIC THREAD	L (mm)	B HEX (MM)	M1 (MM)
F8UPMTB6-M10	6	M10X1	29.7	17	6.4
F8UPMTB6-M12	6	M12X1.5	29.1	17	7.5
F8UPMTB6-M22	6	M22X1.5	29.7	27	9.5
F8UPMTB8-M16	8	M16X1.5	31.0	22	10.0
F8UPMTB10-M16	10	M16X1.5	37.5	22	10.0
F8UPMTB10-M22	10	M22X1.5	31.1	27	9.5
F8UPMTB12-M12	12	M12X1.5	37.3	22	7.5
F8UPMTB12-M22	12	M22X1.5	33.4	27	9.5
F8UPMTB16-M22	16	M22X1.5	33.3	27	9.5

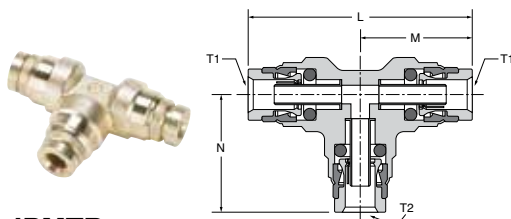

Union Tee JPMTB

PART NO.	TUBE 1 (MM)	TUBE 2 (MM)	L (MM)	M (MM)	N (MM)
JPMTB6	6	6	51.3	25.6	26.7
JPMTB12	12	12	63.3	31.7	35.0
JPMTB12-12-6	12	6	63.3	31.7	28.1

WARNING These products can expose you to chemicals including NICKEL or LEAD, which are known to the state of California to cause cancer and LEAD.



Parker Safe Lock

Parker Safe Lock push-to-connect fittings reduce assembly time and the exclusive locking mechanism minimizes leaks and installation failures.

Parker Safe Lock Product Features:

- Composite Body – Strong, Lightweight, Compact and Impact Resistant
- Fluorocarbon and Fluorosilicone O-ring
- Meets SAE J2044

Markets:

- Heavy Duty Truck
- Trailer
- Mobile

Applications:

- Engine Fuel, Coolant and Vapor Lines

Parker Brass Adapter Product Features:

- **Construction:** Corrosion resistant high temperature brass
- **Configuration:** Rigid male pipe
- **Industry Standard:** SAE J2044

Specifications:

Pressure Range -7.2 to +72 PSI (-0.4 to 4.9 bar)

Temperature Range -40° to +239° F (-40° to +115° C)

⚠ WARNING These products can expose you to chemicals including NICKEL or LEAD, which are known to the state of California to cause cancer and LEAD.

[Click here for CADs, Product Specifications or to Configure Parts Online](#)

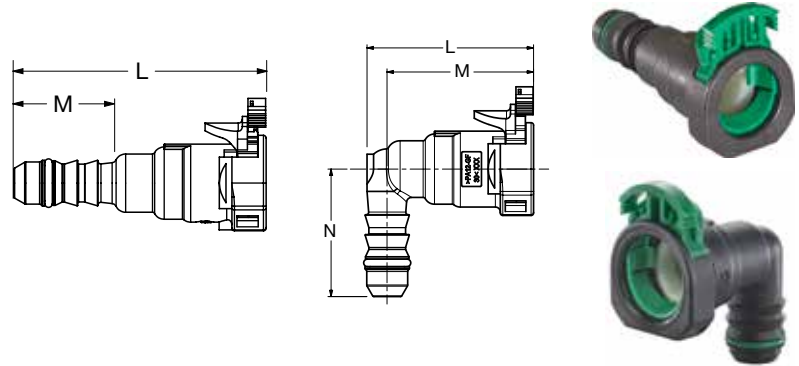

Parker Safe Lock A613, A614, A623, A624

END FORM	BARB TAIL	CONFIGURATION	PART NUMBER** AVAILABLE FROM FSC*	L (MM)	M (MM)	N (MM)
5/16"	5/16"	STRAIGHT	A614A50G06 02	49.40	19.50	N/A
		90 DEGREE	A624A50D06 02	29.50	19.50	25.70
10MM	3/8"	STRAIGHT	A613 52 08 00	55.00	19.00	N/A
		90 DEGREE	A623A52 08 00	34.40	19.00	32.00
3/8"	3/8"	STRAIGHT	A614M53 08 02	55.00	21.50	N/A
		90 DEGREE	A624M53 08 02	34.05	21.50	28.60
12MM	1/2"	STRAIGHT	A614A58 55 04	59.35	21.00	N/A
		90 DEGREE	A624A58 55 04	39.00	21.00	29.70
1/2"	1/2"	STRAIGHT	A614C56 55 05	59.15	21.00	N/A
		90 DEGREE	A624C56 55 05	39.00	21.00	29.70
5/8"	5/8"	STRAIGHT	A614D57 56 02 A	58.20	20.00	N/A
		90 DEGREE	624F57 56 02	39.10	20.00	30.10

*FSC is the Parker Fluid System Connectors Division. See back cover for contact information.
 **Safe Lock Connector part numbers contain spaces.



Parker Safe Lock Brass Adapter 68ALS

PART NUMBER AVAILABLE FROM FSC*	END FORM	THREAD SIZE	PART NUMBER AVAILABLE FROM FSC*	END FORM	THREAD SIZE
68ALS-5-4	5/16"	1/4"	68ALS-12M-8	12MM	1/2"
68ALS-6-4	3/8"	1/4"	68ALS-8-6	1/2"	3/8"
68ALS-6-6	3/8"	3/8"	68ALS-8-8	1/2"	1/2"
68ALS-12M-6	12MM	3/8"	68ALS-10-8	5/8"	1/2"

Adapters are available with Metric Straight Thread O-Rings and Electroless Nickel Plating Upon Request

WARNING These products can expose you to chemicals including NICKEL or LEAD, which are known to the state of California to cause cancer and LEAD.



Transportation Compression Fittings & Valves

Air Brake-NTA® Fittings

Transmission Fittings

Air Brake – AB Fittings

Air Brake Hose Ends Fittings

Vibra-Lok Fittings

Truck Valves & Lanyard Valve



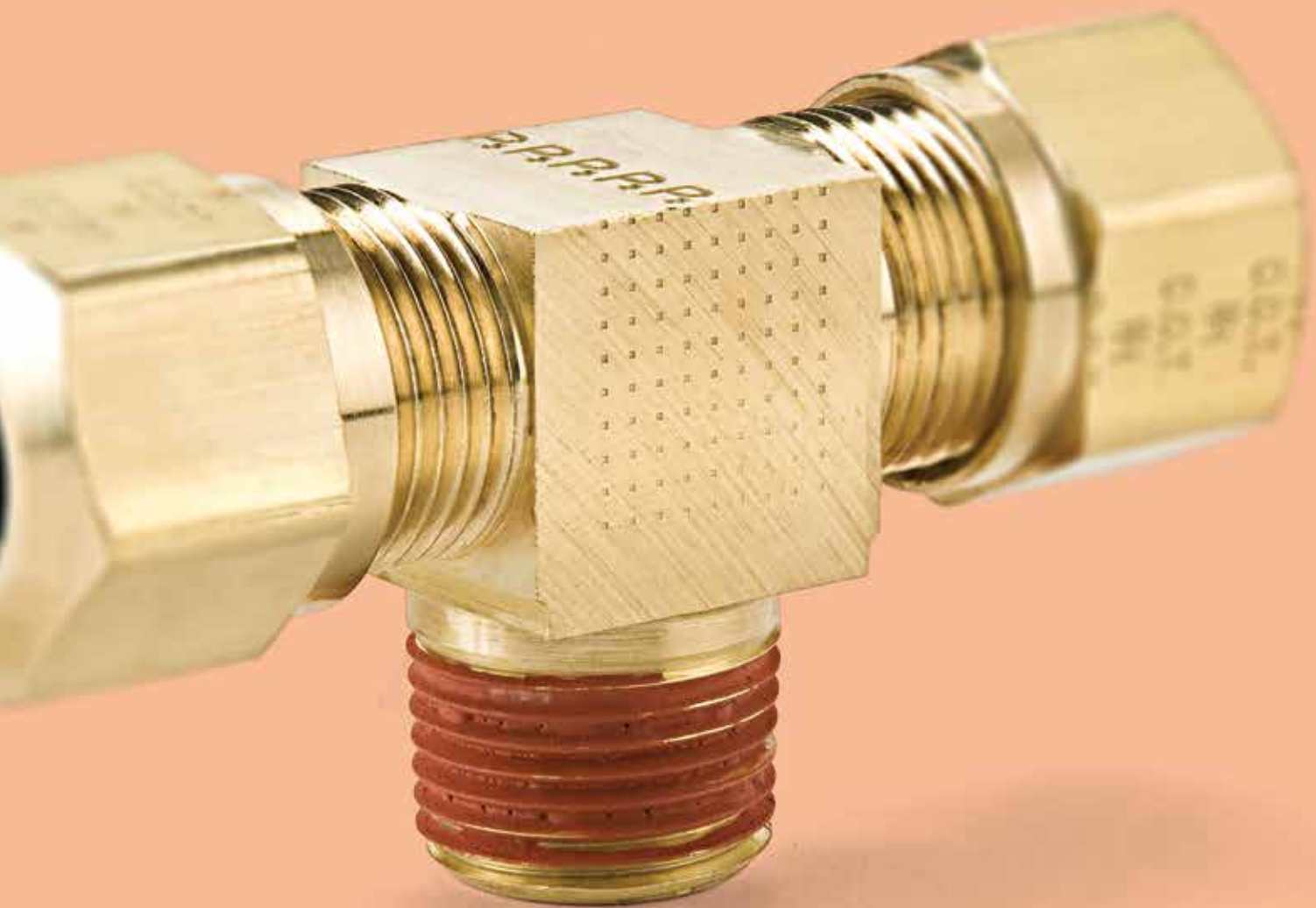

GOODYEAR
RUBBER PRODUCTS, INC.

+1.727.342.5087

También puede enviarnos un correo electrónico a ventas@goodyearrubberproducts.com

■ Air Brake-NTA® Fittings

60NTA
Sleeve
p. F7



61NTA
Nut
p. F7



62NTA
Union
p. F7



63NTA
Tube Support
p. F7



62ANBH
Bulkhead Union
p. F7



62NBH
Bulkhead Union
p. F7



62NFBH
Bulkhead Union
p. F7



66NBH
Bulkhead Union
p. F7



66NTA
Female Connector
NPTF
p. F8



VS68NTA
Male Connector
NPTF
p. F8



68NTA-X-MIX
Male Connector
p. F8



VS176NTA
Adapter
NPTF
p. F8



264NTA
Union Tee
p. F8



265NTA
Union Elbow
p. F8



VS269NTA
Male Elbow
NPTF
p. F9



270NTA
Female Elbow
NPTF
p. F9



VS271NTA
Male Run Tee
NPTF
p. F9



VS272NTA
Male Branch Tee
NPTF
p. F9



VS279NTA
45° Male Elbow
NPTF
p. F9



■ Transmission Fittings

60TF
Sleeve
p. F11



61TF
Nut
p. F11



62TF
Union
p. F11



68TF
Male Connector
NPTF
p. F11



269TF
Male Elbow
NPTF
p. F11



■ Air Brake – AB Fittings

60AB
Sleeve
p. F13



61AB
Nut
p. F13



62AB
Union
p. F13



62ABH
Bulkhead Union
p. F13



66AB
Female Connector
NPTF
p. F13



VS68AB
Male Connector
NPTF
p. F13



264AB
Union Tee
p. F13



265AB
Union Elbow
p. F13



VS269AB
Male Elbow
NPTF
p. F14



270AB
Female Elbow
NPTF
p. F14



VS271AB
Male Run Tee
NPTF
p. F14



VS272AB
Male Branch Tee
NPTF
p. F14



VS279AB
45° Male Elbow
NPTF
p. F14



207ACBH
Anchor Coupling
NPTF
p. F14



⚠ WARNING These products can expose you to chemicals including NICKEL, CARBON BLACK, or LEAD, which are known to the state of California to cause cancer.

■ Air Brake Hose Ends Fittings

56RBSG
Spring
p. F16



60RB
Sleeve
p. F16



61RB
Nut
p. F16



61RBSG
Spring Guard Nut
p. F16



62RB
Union
p. F16



66RBSV
Female Connector
NPTF
p. F16



67RBSG
Nut & Spring
p. F16



68RB
Male Connector
NPTF
p. F16



68RB
Male Connector
Body Only – NPTF
p. F16



68RBSG
Male Connector
NPTF
p. F16



76RB
Adapter
NPTF
p. F16



■ Vibra-Lok Fittings

60VL
Sleeve
p. F18



60VLV
Sleeve
p. F18



61VL
Nut
p. F18



62VL
Union
p. F18



66VL
Female Connector
NPTF
p. F19



68VL
Male Connector
NPTF
p. F19



685VLV
Male Connector
p. F19



164VL
Union Tee
p. F19



169VL
Male Elbow
NPTF
p. F19



682VL
Tank Fitting
NPTF
p. F19



1695VL
Male Elbow
p. F20



170VL
Female Elbow
NPTF
p. F20



171VL
Male Run Tee
NPTF
p. F20



172VL
Male Branch Tee
NPTF
p. F20



179VL
45° Male Elbow
NPTF
p. F20



■ Truck Valves & Lanyard Valve

V404P
Hose – Pipe
p. F22



V404PH
Hose – Pipe
p. F22



SV404P
Hose – Pipe
p. F22



V405P
Female – Male
p. F22



V408NTA
Tube – Pipe
p. F22



V409F
Flare – Pipe
p. F22



V410NTA
Tube – Pipe
p. F22



V412F
Tube – Flare
p. F22



LV91
Lanyard Valve
p. F22



⚠ **WARNING** These products can expose you to chemicals including NICKEL, CARBON BLACK, or LEAD, which are known to the state of California to cause cancer.

Air Brake-NTA® Fittings



Parker's NTA Fittings utilize a ribbed sleeve for compression and positive grip. Fittings meet SAE and D.O.T. specifications. Designed for all D.O.T truck and trailer applications. Electroless nickel plated bodies can be used with bio-diesel.

Product Features:

- Brass Body
- Meets D.O.T. FMVSS571.106 Performance
- Meets functional Requirements SAE J246 & SAE J1131
- Pre-applied Thread Sealant
- Nickel Plated Versions Available for Bio-diesel

Markets:

- Heavy Duty Truck
- Trailer
- Mobile

Applications:

- Air Brakes
- Air Tanks
- Air Ride
- Sliders
- Tire Inflation
- Primary & Secondary Air Lines
- Cab Controls

Specifications:

Pressure Range Up to 150 PSI (10.3 bar)

Temperature Range -40° to +200° F (-40° to +93.3° C)

Compatible Tubing:

- SAE J844 Type A & B nylon tubing

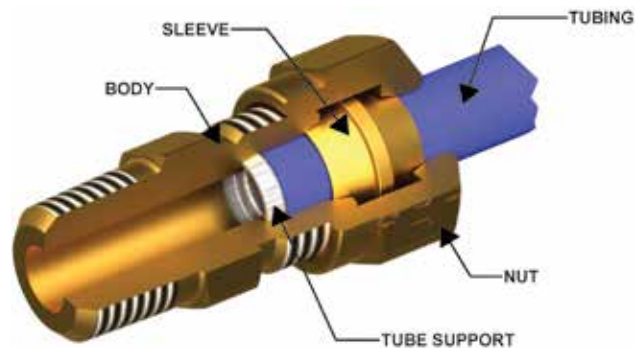

Assembly Instructions

1. Cut tubing squarely – maximum of 15° angle allowable.
2. Check that port or mating part is clean and free of debris.
3. Insert tubing until it bottoms on seat.
4. Tighten nut with wrench until one thread remains visible on the fitting body; (this will allow for a number of remakes) or, the nut should be screwed down finger tight, then wrench-tightened as indicated in the following table.

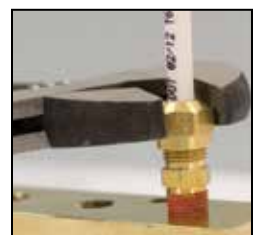

TUBE SIZE	ADDITIONAL NUMBER OF TURNS FROM HAND-TIGHT
3/16	2-1/2
1/4	3
3/8 & 1/2	4
5/8 & 3/4	3-1/2

WARNING These products can expose you to chemicals including NICKEL or LEAD, which are known to the state of California to cause cancer and LEAD.

[Click here for CADs, Product Specifications or to Configure Parts Online](#)

Sleeve 60NTA

REF. SAE 100115

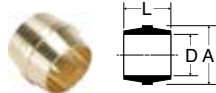

PART NO.	TUBE SIZE	A	D	L
60NTA-3*	3/16	.255	.194	.23
60NTA-4	1/4	.359	.256	.30
60NTA-6	3/8	.479	.384	.39
60NTA-8	1/2	.624	.509	.43
60NTA-10	5/8	.746	.634	.49
60NTA-12	3/4	.922	.760	.54

*Meets D.O.T. FMVSS 571.106 specification. No applicable SAE specification for this tube size.

Nut 61NTA

REF. SAE 100110

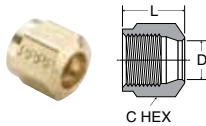

PART NO.	TUBE SIZE	STRAIGHT THREAD	C HEX	D	L
61NTA-3*	3/16	5/16-24	7/16	.194	.40
61NTA-4	1/4	7/16-24	9/16	.256	.45
61NTA-6	3/8	17/32-24	5/8	.384	.63
61NTA-8	1/2	11/16-20	13/16	.509	.72
61NTA-10	5/8	13/16-18	15/16	.634	.77
61NTA-12	3/4	1-18	1-1/8	.760	.81

*Meets D.O.T. FMVSS 571.106 specification. No applicable SAE specification for this tube size.

Union 62NTA

REF. SAE 100101 BA

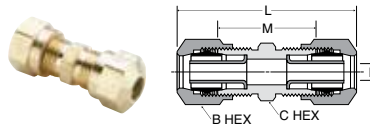

PART NO.	TUBE SIZE	STRAIGHT THREAD	B HEX	C HEX	L	M	FLOW DIA. D
62NTA-4	1/4	7/16-24	9/16	7/16	1.49	.83	.137
62NTA-6	3/8	17/32-24	5/8	9/16	2.00	1.08	.217
62NTA-8	1/2	11/16-20	13/16	11/16	2.32	1.29	.338
62NTA-10	5/8	13/16-18	15/16	13/16	2.39	1.41	.398
62NTA-12	3/4	1-18	1-1/8	1	2.60	1.58	.523

Stainless Steel Insert 63NTA

(FOR SAE J844 TUBING)

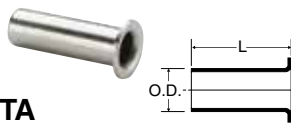

PART NO.	TUBE SIZE	L	O.D.
63NTA-4	1/4	.53	.163
63NTA-6	3/8	.64	.245
63NTA-8	1/2	.81	.370
63NTA-10	5/8	.86	.434
63NTA-12	3/4	1.04	.559

Bulkhead Union 62ANBH

(NTA® & AIR BRAKE)

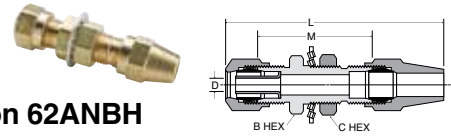

PART NO.	TUBE SIZE	STRAIGHT THREAD	B HEX	C HEX	L	M	FLOW DIA. D	BULKHEAD HOLE DIA.
62ANBH-4	1/4	7/16-24	9/16	9/16	2.28	1.38	.137	7/16
62ANBH-6	3/8	17/32-24	11/16	3/4	2.97	1.62	.217	17/32
62ANBH-8	1/2	11/16-20	13/16	1	3.36	1.88	.338	11/16

Bulkhead Union 62NBH

PART NO.	TUBE SIZE	STRAIGHT THREAD	B HEX	C HEX	L	M	FLOW DIA. D	BULKHEAD HOLE DIA.
62NBH-3*	3/16	5/16-24	7/16	7/16	1.80	1.21	.087	5/16
62NBH-4	1/4	7/16-24	9/16	9/16	2.04	1.38	.137	7/16
62NBH-6	3/8	17/32-24	11/16	3/4	2.54	1.62	.217	17/32
62NBH-8	1/2	11/16-20	13/16	1	2.92	1.88	.338	11/16
62NBH-10	5/8	13/16-18	15/16	1	2.99	2.01	.398	13/16

*Meets D.O.T. FMVSS 571.106 specification. No applicable SAE specification for this tube size.

Bulkhead Union 62NFBH

PART NO.	TUBE SIZE	FLARE SIZE	STGHT THD	B HEX	C HEX	L	M	FLOW DIA. D	BKHD HOLE DIA.
62NFBH-4	1/4	1/4	7/16-24	9/16	9/16	1.86	1.53	.137	7/16
62NFBH-6	3/8	3/8	17/32-24	3/4	3/4	2.24	1.78	.217	5/8
62NFBH-8	1/2	1/2	11/16-20	7/8	7/8	2.73	2.22	.338	3/4
62NFBH-10	5/8	5/8	13/16-18	1	1	2.68	2.21	.398	7/8
62NFBH-10-8	5/8	1/2	13/16-18	7/8	7/8	2.90	2.40	.398	3/4

Bulkhead Union 66NBH

PART NO.	TB SZ	PIPE THD	A STGHT THD	E STGHT THD	B HEX	C HEX	L	M	FLOW DIA. D	BKHD HOLE DIA.
66NBH-8-6	1/2	3/8	11/16-20	7/8-14	1-1/16	1-1/16	1.94	1.42	.338	7/8

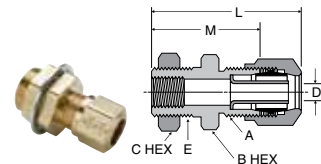

WARNING These products can expose you to chemicals including NICKEL or LEAD, which are known to the state of California to cause cancer and LEAD.

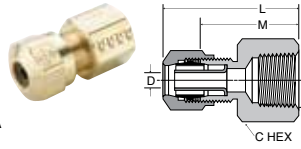

Female Connector 66NTA

REF. SAE 100103 BA

PART NO.	TUBE SIZE	PIPE THREAD	STRAIGHT THREAD	C HEX	L	M	FLOW DIA. D
66NTA-4-2	1/4	1/8	7/16-24	9/16	1.17	.84	.137
66NTA-4-4	1/4	1/4	7/16-24	11/16	1.40	1.07	.137
66NTA-6-2	3/8	1/8	17/32-24	9/16	1.46	1.00	.217
66NTA-6-4	3/8	1/4	17/32-24	11/16	1.64	1.18	.217
66NTA-6-6	3/8	3/8	17/32-24	7/8	1.64	1.18	.217
66NTA-8-6	1/2	3/8	11/16-20	7/8	1.79	1.27	.338
66NTA-8-8	1/2	1/2	11/16-20	1-1/16	1.96	1.44	.338
66NTA-10-6	5/8	3/8	13/16-18	7/8	1.80	1.31	.398
66NTA-10-8	5/8	1/2	13/16-18	1-1/16	1.99	1.50	.398

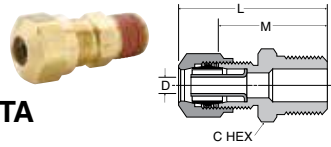

Male Connector VS68NTA

Ref. SAE 100102 BA

PART NO.	TUBE SIZE	PIPE THREAD	STRAIGHT THREAD	C HEX	L	M	FLOW DIA. D
VS68NTA-3-1*	3/16	1/16	5/16-24	3/8	1.16	.87	.087
VS68NTA-3-2*	3/16	1/8	5/16-24	7/16	1.15	.86	.087
VS68NTA-3-4*	3/16	1/4	5/16-24	9/16	1.35	1.05	.087
VS68NTA-4-2	1/4	1/8	7/16-24	7/16	1.22	.89	.137
VS68NTA-4-4	1/4	1/4	7/16-24	9/16	1.43	1.10	.137
VS68NTA-4-6	1/4	3/8	7/16-24	11/16	1.47	1.14	.137
VS68NTA-6-2	3/8	1/8	17/32-24	9/16	1.49	1.03	.217
VS68NTA-6-4	3/8	1/4	17/32-24	9/16	1.67	1.21	.217
VS68NTA-6-6	3/8	3/8	17/32-24	11/16	1.70	1.24	.217
VS68NTA-6-8	3/8	1/2	17/32-24	7/8	1.89	1.43	.217
VS68NTA-8-4	1/2	1/4	11/16-20	11/16	1.85	1.33	.338
VS68NTA-8-6	1/2	3/8	11/16-20	11/16	1.85	1.33	.338
VS68NTA-8-8	1/2	1/2	11/16-20	7/8	2.04	1.52	.338
VS68NTA-10-6	5/8	3/8	13/16-18	13/16	1.88	1.39	.398
VS68NTA-10-8	5/8	1/2	13/16-18	7/8	2.10	1.58	.398
VS68NTA-12-6	3/4	3/8	1-18	1	2.00	1.49	.440
VS68NTA-12-8	3/4	1/2	1-18	1	2.19	1.68	.523
VS68NTA-12-12	3/4	3/4	1-18	1-1/8	2.22	1.71	.523

*Meets D.O.T. FMVSS 571.106 specification. No applicable SAE specification for this tube size.

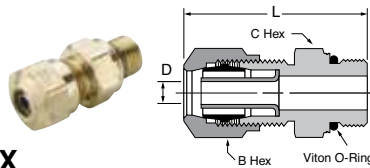

NTA® to Metric Adaptor 68NTA-X-MIX

PART NO.	TUBE SIZE	METRIC THREAD	B HEX	C HEX	L	D
68NTA-4-MI10	1/4	M10 X 1.0	9/16	9/16	1.33	.140

Note: Fluorocarbon o-ring is standard

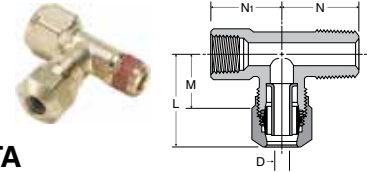

Adapter Tee VS176NTA

PART NO.	TUBE SIZE	PIPE THREAD	STRAIGHT THREAD	L	M	N	N1	FLOW DIA. D
VS176NTA-4-2	1/4	1/8	7/16-24	1.02	.69	.75	.66	.137

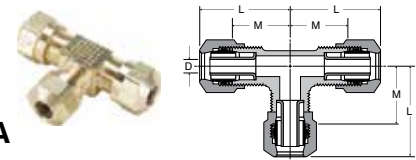

Union Tee 264NTA

REF. SAE 100401 BA

PART NO.	TUBE SIZE	STRAIGHT THREAD	L	M	FLOW DIA. D
264NTA-4	1/4	7/16-24	.95	.62	.137
264NTA-6	3/8	17/32-24	1.24	.78	.217
264NTA-8	1/2	11/16-20	1.45	.93	.338
264NTA-10	5/8	13/16-18	1.58	1.09	.398

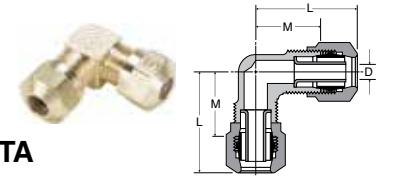

Union Elbow 265NTA

REF. SAE 100201 BA

PART NO.	TUBE SIZE	STRAIGHT THREAD	L	M	FLOW DIA. D
265NTA-4	1/4	7/16-24	.95	.62	.137
265NTA-6	3/8	17/32-24	1.25	.79	.217
265NTA-8	1/2	11/16-20	1.45	.93	.338
265NTA-10	5/8	13/16-18	1.58	1.09	.398

WARNING These products can expose you to chemicals including NICKEL or LEAD, which are known to the state of California to cause cancer and LEAD.

[Click here for CADs, Product Specifications or to Configure Parts Online](#)

Male Elbow VS269NTA

REF. SAE 100202 BA

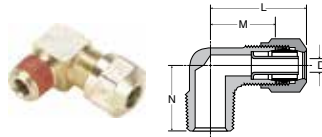

PART NO.	TUBE SIZE	PIPE THREAD	STRAIGHT THREAD	L	M	N	FLOW DIA. D
VS269NTA-3-2*	3/16	1/8	5/16-24	.90	.60	.67	.087
VS269NTA-3-4*	3/16	1/4	5/16-24	.91	.62	.87	.087
VS269NTA-4-2	1/4	1/8	7/16-24	.95	.62	.66	.137
VS269NTA-4-4	1/4	1/4	7/16-24	1.00	.68	.87	.137
VS269NTA-4-6	1/4	3/8	7/16-24	1.16	.73	.86	.137
VS269NTA-6-2	3/8	1/8	17/32-24	1.19	.73	.75	.217
VS269NTA-6-4	3/8	1/4	17/32-24	1.25	.79	.92	.217
VS269NTA-6-6	3/8	3/8	17/32-24	1.30	.84	.91	.217
VS269NTA-6-8	3/8	1/2	17/32-24	1.40	.94	1.10	.217
VS269NTA-8-4	1/2	1/4	11/16-20	1.38	.86	.99	.338
VS269NTA-8-6	1/2	3/8	11/16-20	1.44	.92	.99	.338
VS269NTA-8-8	1/2	1/2	11/16-20	1.55	1.03	1.18	.338
VS269NTA-10-6	5/8	3/8	13/16-18	1.49	1.00	1.05	.398
VS269NTA-10-8	5/8	1/2	13/16-18	1.58	1.09	1.24	.398
VS269NTA-10-12	5/8	3/4	13/16-18	1.76	1.25	1.32	.400
VS269NTA-12-8	3/4	1/2	1-18	1.70	1.19	1.33	.523
VS269NTA-12-12	3/4	3/4	1-18	1.77	1.26	1.32	.523

*Meets D.O.T. FMVSS 571.106 specification. No applicable SAE specification for this tube size.

Female Elbow 270NTA

REF. SAE 100203 BA

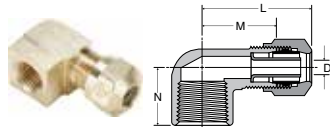

PART NO.	TUBE SIZE	PIPE THREAD	STRAIGHT THREAD	L	M	N	FLOW DIA. D
270NTA-3-2*	3/16	1/8	5/16-24	.96	.67	.52	.087
270NTA-4-2	1/4	1/8	7/16-24	1.02	.69	.52	.137
270NTA-4-4	1/4	1/4	7/16-24	1.11	.78	.71	.137
270NTA-6-2	3/8	1/8	17/32-24	1.29	.83	.59	.217
270NTA-6-4	3/8	1/4	17/32-24	1.35	.89	.77	.217
270NTA-6-6	3/8	3/8	17/32-24	1.39	.93	.77	.217
270NTA-8-6	1/2	3/8	11/16-20	1.55	1.03	.82	.338
270NTA-8-8	1/2	1/2	11/16-20	1.65	1.13	1.01	.338
270NTA-10-8	5/8	1/2	13/16-18	1.70	1.19	1.07	.398

*Meets D.O.T. FMVSS 571.106 specification. No applicable SAE specification for this tube size.

Male Run Tee VS271NTA

REF. SAE 100424 BA

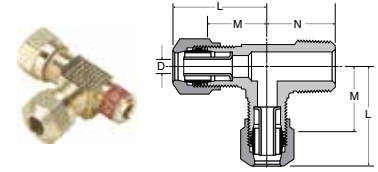

PART NO.	TUBE SIZE	PIPE THREAD	STRAIGHT THREAD	L	M	N	FLOW DIA. D
VS271NTA-4-2	1/4	1/8	7/16-24	.95	.62	.66	.137
VS271NTA-4-4	1/4	1/4	7/16-24	1.00	.68	.87	.137
VS271NTA-6-4	3/8	1/4	17/32-24	1.25	.79	.92	.217
VS271NTA-6-6	3/8	3/8	17/32-24	1.30	.84	.91	.217
VS271NTA-8-6	1/2	3/8	11/16-20	1.45	.93	.99	.338
VS271NTA-8-8	1/2	1/2	11/16-20	1.55	1.03	1.18	.338
VS271NTA-10-8	5/8	1/2	13/16-18	1.60	1.09	1.24	.398

Male Branch Tee VS272NTA

REF. SAE 100425 BA

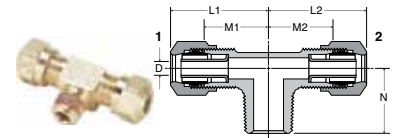

PART NO.	TB 1	TB 2	PIPE THD	STGHT THD	L1	L2	M1	M2	N	FLOW DIA. D
VS272NTA-3-2*	3/16	3/16	1/8	5/16-24	.90	.90	.61	.61	.66	.087
VS272NTA-4-2	1/4	1/4	1/8	7/16-24	.95	.95	.62	.62	.66	.137
VS272NTA-4-4	1/4	1/4	1/4	7/16-24	1.00	1.00	.68	.68	.87	.137
VS272NTA-6-2	3/8	3/8	1/8	17/32-24	1.18	1.18	.75	.75	.73	.217
VS272NTA-6-4	3/8	3/8	1/4	17/32-24	1.25	1.25	.91	.91	.92	.217
VS272NTA-6-4-4	3/8	1/4	1/4	7/16-24 17/32-24	.99	1.25	.67	.79	.91	.137
VS272NTA-6-6	3/8	3/8	3/8	17/32-24	1.27	1.27	.84	.84	.91	.217
VS272NTA-8-4	1/2	1/2	1/4	11/16-20	1.45	1.45	.93	.93	.99	.338
VS272NTA-8-6	1/2	1/2	3/8	11/16-20	1.45	1.45	.93	.93	.99	.338
VS272NTA-8-8	1/2	1/2	1/2	11/16-20	1.55	1.55	1.03	1.03	1.18	.338
VS272NTA-10-8	5/8	5/8	1/2	13/16-18	1.60	1.60	1.09	1.09	1.24	.398

*Meets D.O.T. FMVSS 571.106 specification. No applicable SAE specification for this tube size.

45° Elbow VS279NTA

REF. SAE 100302 BA

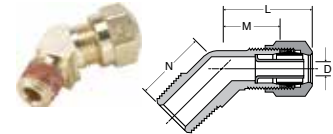

PART NO.	TUBE SIZE	PIPE THREAD	STRAIGHT THREAD	L	M	N	FLOW DIA. D
VS279NTA-4-2	1/4	1/8	7/16-24	.81	.49	.63	.137
VS279NTA-4-4	1/4	1/4	7/16-24	.93	.60	.85	.137
VS279NTA-6-2	3/8	1/8	17/32-24	1.17	.71	.68	.217
VS279NTA-6-4	3/8	1/4	17/32-24	1.17	.71	.85	.217
VS279NTA-6-6	3/8	3/8	17/32-24	1.21	.75	.94	.217
VS279NTA-6-8	3/8	1/2	17/32-24	1.24	.78	1.16	.217
VS279NTA-8-4	1/2	1/4	11/16-20	1.36	.84	.94	.338
VS279NTA-8-6	1/2	3/8	11/16-20	1.36	.84	.94	.338
VS279NTA-8-8	1/2	1/2	11/16-20	1.39	.87	1.16	.338
VS279NTA-10-6	5/8	3/8	13/16-18	1.43	.94	.98	.398
VS279NTA-10-8	5/8	1/2	13/16-18	1.42	.93	1.16	.398
VS279NTA-12-8	3/4	1/2	1-18	1.61	1.10	1.18	.523

WARNING These products can expose you to chemicals including NICKEL or LEAD, which are known to the state of California to cause cancer and LEAD.

Transmission Fittings



Parker's Transmission Fittings utilizes a specially designed slotted sleeve to help eliminate notch stress related to over-torque. Ideal for pressure protected pneumatic transmission applications. Electroless nickel plated bodies can be used with bio-diesel.

Product Features:

- Brass Body
- D.O.T. Approved with Staked in Tube Support
- 3/16" & 5/32" Tube sizes
- Slotted Sleeve
- Nickel Plated Versions Available for Bio-diesel

Markets:

- Heavy Duty Truck

Applications:

- Air Shift Transmissions
- Seat Controls
- Dash Controls

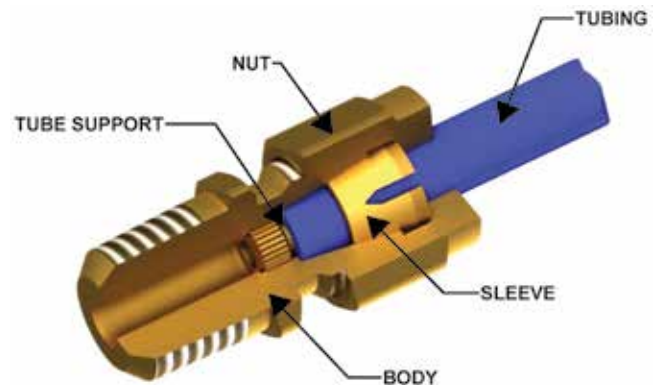

Specifications:

Pressure Range Up to 150 PSI (10.3 bar)

Temperature Range -40° to +200° F (-40° to +93.3° C)

Compatible Tubing:

- SAE J844 Type A & B nylon tubing

Assembly Instructions

1. Cut tubing squarely and remove burrs
2. Insert tubing into fitting until bottomed
3. Tighten nut 1 1/2 turns from finger tight



⚠ WARNING These products can expose you to chemicals including LEAD which is known to the state of California to cause cancer.

[Click here for CADs, Product Specifications or to Configure Parts Online](#)

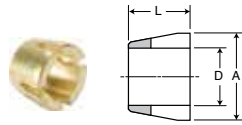

Sleeve 60TF

PART NO.	TUBE SIZE	A	D	L
60TF-2	1/8	.235	.130	0.17
60TF-5/32	5/32	.251	.165	0.18

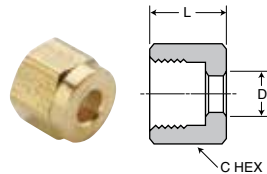

Nut 61TF

PART NO.	TUBE SIZE	D	L	STRT THD	C HEX
61TF-2	1/8	.133	.32	5/16-24	3/8
61TF-5/32	5/32	.163	.32	5/16-24	3/8

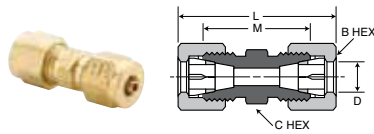

Union 62TF

PART NO.	TUBE SIZE	D	L	STRT THD	M	C HEX	B HEX
62TF-2	1/8	.109	1.04	5/16-24	.68	5/16	3/8
62TF-5/32	5/32	.068	1.04	5/16-24	.68	5/16	3/8

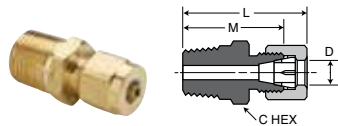

Male Connector 68TF

PART NO.	TUBE SIZE	PIPE THREAD	D	L	STRT THD	M	C HEX
68TF-2-1	1/8	1/16	.109	.96	5/16-24	.78	11/32
68TF-2-2	1/8	1/8	.109	.96	5/16-24	.78	7/16
68TF-5/32-1	5/32	1/16	.068	.84	5/16-24	.66	11/32
68TF-5/32-2	5/32	1/8	.068	.96	5/16-24	.78	7/16

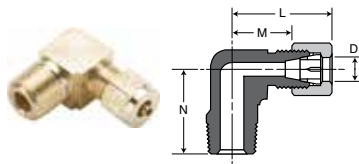

Male Elbow 269TF

PART NO.	TUBE SIZE	PIPE THREAD	D	L	STRT THD	M	N
269TF-2-2	1/8	1/8	.109	.79	5/16-24	.61	.66
269TF-5/32-2	5/32	1/8	.068	.79	5/16-24	.61	.66

WARNING These products can expose you to chemicals including LEAD which is known to the state of California to cause cancer.

Air Brake – AB Fittings



Parker's Air Brake - AB Fittings are economical compression style fittings for copper air brake lines. AB fittings meet the functional requirements of SAE and the performance requirements of D.O.T.

Product Features:

- Brass Body
- Meets D.O.T. FMVSS571.106 Performance
- Meets functional Requirements SAE J246
- Reusable
- Pre-applied Thread Sealant

Markets:

- Heavy Duty Truck
- Trailer
- Mobile

Applications:

- Copper Air Brake Lines
- Coolant Lines
- Fuel Lines

Specifications:

Pressure Range Up to 400 PSI (27.5 bar)

Temperature Range -65° to +250° F (-53.8° to +121.1° C)

Compatible Tubing:

- Copper Air Brake Tubing

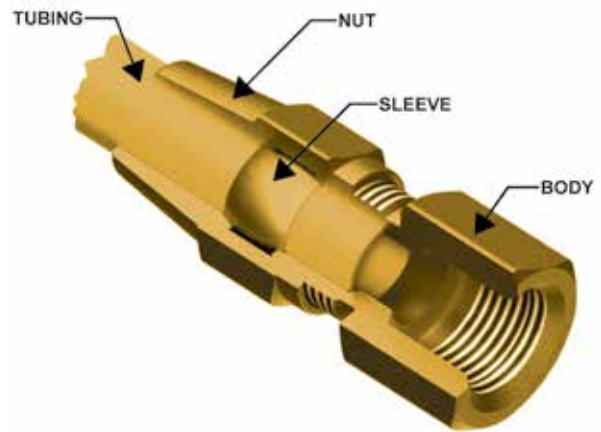

Assembly Instructions

1. Cut tubing squarely and remove burrs
2. Slide nut and sleeve onto tubing.
3. Insert tubing into fitting until bottomed on seat. The nut should be screwed down finger tight, then wrench tightened as indicated in the chart



TUBE SIZE	TURNS REQUIRED TO SEAL FROM HAND-TIGHT
1/4, 3/8, 1/2	2
5/8, 3/4	3

WARNING These products can expose you to chemicals including LEAD which is known to the state of California to cause cancer.

[Click here for CADs, Product Specifications or to Configure Parts Online](#)

Sleeve 60AB

REF. SAE 120115

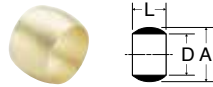

PART NO.	TUBE SIZE	A	D	L
60AB-4	1/4	.322	.255	.250
60AB-6	3/8	.461	.382	.310
60AB-8	1/2	.594	.507	.380
60AB-10	5/8	.734	.632	.440
60AB-12	3/4	.874	.758	.500

Nut 61AB

REF. SAE 120111

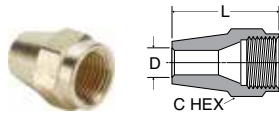

PART NO.	TUBE SIZE	STRAIGHT THREAD	C HEX	D	L
61AB-4	1/4	7/16-24	9/16	.256	.75
61AB-6	3/8	17/32-24	5/8	.384	1.13
61AB-8	1/2	11/16-20	13/16	.509	1.25
61AB-10	5/8	13/16-18	15/16	.634	1.38
61AB-12	3/4	1-18	1-1/8	.760	1.56

Union 62AB

REF. SAE 120101 BA

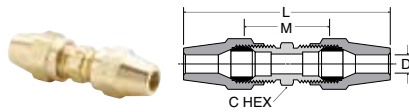

PART NO.	TUBE SIZE	STRAIGHT THREAD	C HEX	L	M	FLOW DIA. D
62AB-4	1/4	7/16-24	7/16	1.98	.83	.189
62AB-6	3/8	17/32-24	9/16	2.87	1.08	.314
62AB-8	1/2	11/16-20	11/16	3.21	1.29	.405
62AB-10	5/8	13/16-18	13/16	3.59	1.41	.531
62AB-12	3/4	1-18	1	4.08	1.59	.656

Bulkhead Union 62ABH

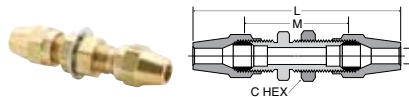

PART NO.	TUBE SIZE	STRAIGHT THREAD	C HEX	L	M	FLOW DIA. D	BULKHEAD HOLE DIA.
62ABH-4	1/4	7/16-24	9/16	2.53	1.38	.188	7/16
62ABH-6	3/8	17/32-24	3/4	3.41	1.62	.314	17/32
62ABH-8	1/2	11/16-20	1	3.80	1.88	.408	11/16

Female Connector 66AB

REF. SAE 120103 BA

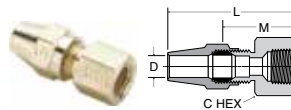

PART NO.	TUBE SIZE	PIPE THREAD	STRAIGHT THREAD	C HEX	L	M	FLOW DIA. D
66AB-4-2	1/4	1/8	7/16-24	9/16	1.42	.84	.188
66AB-4-4	1/4	1/4	7/16-24	11/16	1.65	1.07	.188
66AB-6-2	3/8	1/8	17/32-24	9/16	1.89	1.00	.314
66AB-6-4	3/8	1/4	17/32-24	11/16	2.07	1.18	.314
66AB-6-6	3/8	3/8	17/32-24	7/8	2.07	1.18	.314
66AB-8-6	1/2	3/8	11/16-20	7/8	2.23	1.27	.408
66AB-8-8	1/2	1/2	11/16-20	1-1/16	2.40	1.44	.408
66AB-10-6	5/8	3/8	13/16-18	7/8	2.40	1.31	.533
66AB-10-8	5/8	1/2	13/16-18	1-1/16	2.59	1.50	.533

Male Connector VS68AB

REF. SAE 120102 BA

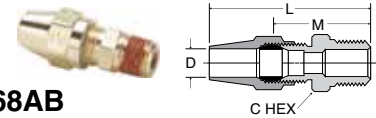

PART NO.	TUBE SIZE	PIPE THREAD	STRAIGHT THREAD	C HEX	L	M	FLOW DIA. D
VS68AB-4-2	1/4	1/8	7/16-24	7/16	1.47	.89	.189
VS68AB-4-4	1/4	1/4	7/16-24	9/16	1.68	1.10	.189
VS68AB-4-6	1/4	3/8	7/16-24	11/16	1.72	1.14	.189
VS68AB-6-2	3/8	1/8	17/32-24	9/16	1.92	1.03	.189
VS68AB-6-4	3/8	1/4	17/32-24	9/16	2.10	1.21	.314
VS68AB-6-6	3/8	3/8	17/32-24	11/16	2.13	1.24	.314
VS68AB-6-8	3/8	1/2	17/32-24	7/8	2.32	1.43	.314
VS68AB-8-4	1/2	1/4	11/16-20	11/16	2.29	1.33	.314
VS68AB-8-6	1/2	3/8	11/16-20	11/16	2.29	1.33	.408
VS68AB-8-8	1/2	1/2	11/16-20	7/8	2.48	1.52	.408
VS68AB-10-6	5/8	3/8	13/16-18	13/16	2.48	1.39	.408
VS68AB-10-8	5/8	1/2	13/16-18	7/8	2.67	1.58	.533
VS68AB-12-8	3/4	1/2	1-18	1	2.92	1.68	.533
VS68AB-12-12	3/4	3/4	1-18	1-1/8	2.95	1.71	.658

Union Tee 264AB

REF. SAE 120401 BA

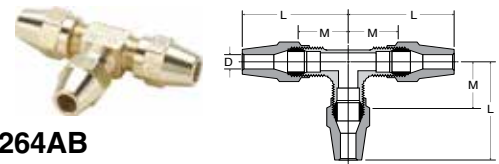

PART NO.	TUBE SIZE	STRAIGHT THREAD	L	M	FLOW DIA. D
264AB-4	1/4	7/16-24	1.20	.62	.189
264AB-6	3/8	17/32-24	1.67	.78	.314
264AB-8	1/2	11/16-20	1.89	.93	.408
264AB-10	5/8	13/16-18	2.18	1.09	.533

Union Elbow 265AB

REF. SAE 120201 BA

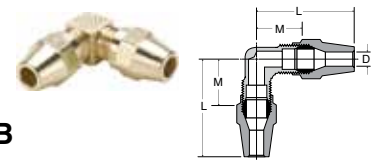

PART NO.	TUBE SIZE	STRAIGHT THREAD	L	M	FLOW DIA. D
265AB-4	1/4	7/16-24	1.20	.62	.189
265AB-6	3/8	17/32-24	1.68	.79	.314
265AB-8	1/2	11/16-20	1.89	.93	.408
265AB-10	5/8	13/16-18	2.18	1.09	.533

WARNING These products can expose you to chemicals including LEAD which is known to the state of California to cause cancer.

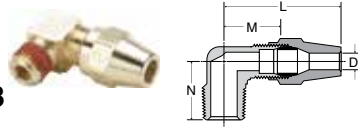

Male Elbow VS269AB

REF. SAE 120202 BA

PART NO.	TUBE SIZE	PIPE THREAD	STRAIGHT THREAD	L	M	N	FLOW DIA. D
VS269AB-4-2	1/4	1/8	7/16-24	1.20	.62	.66	.189
VS269AB-4-4	1/4	1/4	7/16-24	1.26	.68	.87	.189
VS269AB-4-6	1/4	3/8	7/16-24	1.31	.73	.86	.189
VS269AB-6-2	3/8	1/8	17/32-24	1.62	.73	.75	.189
VS269AB-6-4	3/8	1/4	17/32-24	1.68	.79	.92	.314
VS269AB-6-6	3/8	3/8	17/32-24	1.73	.84	.91	.314
VS269AB-6-8	3/8	1/2	17/32-24	1.83	.94	1.10	.314
VS269AB-8-4	1/2	1/4	11/16-20	1.82	.86	.99	.314
VS269AB-8-6	1/2	3/8	11/16-20	1.88	.93	.99	.408
VS269AB-8-8	1/2	1/2	11/16-20	1.99	1.03	1.18	.408
VS269AB-10-6	5/8	3/8	13/16-18	2.09	1.00	1.05	.408
VS269AB-10-8	5/8	1/2	13/16-18	2.18	1.09	1.24	.533
VS269AB-12-8	3/4	1/2	1-18	2.33	1.19	1.32	.533
VS269AB-12-12	3/4	3/4	1-18	2.50	1.26	1.32	.533

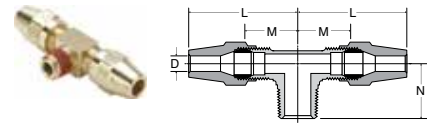

Male Branch Tee VS272AB

REF. SAE 120425 BA

PART NO.	TUBE SIZE	PIPE THREAD	STRAIGHT THREAD	L	M	N	FLOW DIA. D
VS272AB-4-2	1/4	1/8	7/16-24	1.20	.62	.66	.189
VS272AB-4-4	1/4	1/4	7/16-24	1.26	.68	.87	.189
VS272AB-6-2	3/8	1/8	17/32-24	1.61	.72	.75	.189
VS272AB-6-4	3/8	1/4	17/32-24	1.68	.79	.92	.314
VS272AB-6-6	3/8	3/8	17/32-24	1.73	.84	.91	.314
VS272AB-8-6	1/2	3/8	11/16-20	1.89	.93	.99	.408
VS272AB-8-8	1/2	1/2	11/16-20	1.99	1.03	1.18	.408
VS272AB-10-8	5/8	1/2	13/16-18	2.18	1.09	1.24	.533

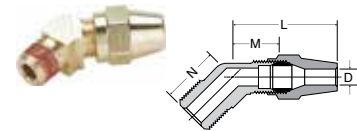

45° Elbow VS279AB

REF. SAE 120302 BA

PART NO.	TUBE SIZE	PIPE THREAD	STRAIGHT THREAD	L	M	N	FLOW DIA. D
VS279AB-4-2	1/4	1/8	7/16-24	1.07	.49	.63	.189
VS279AB-4-4	1/4	1/4	7/16-24	1.18	.60	.85	.189
VS279AB-6-2	3/8	1/8	17/32-24	1.60	.71	.68	.189
VS279AB-6-4	3/8	1/4	17/32-24	1.64	.71	.85	.314
VS279AB-6-6	3/8	3/8	17/32-24	1.64	.75	.94	.314
VS279AB-6-8	3/8	1/2	17/32-24	1.67	.78	1.16	.314
VS279AB-8-6	1/2	3/8	11/16-20	1.80	.84	.94	.408
VS279AB-8-8	1/2	1/2	11/16-20	1.83	.87	1.16	.408
VS279AB-10-6	5/8	3/8	13/16-18	2.03	.94	.98	.408
VS279AB-10-8	5/8	1/2	13/16-18	2.13	1.05	1.16	.533
VS279AB-12-8	3/4	1/2	1-18	2.34	1.10	1.18	.533

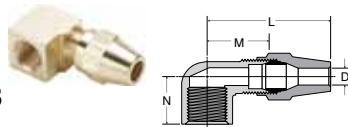

Female Elbow 270AB

REF. SAE 120203 BA

PART NO.	TUBE SIZE	PIPE THREAD	STRAIGHT THREAD	L	M	N	FLOW DIA. D
270AB-4-2	1/4	1/8	7/16-24	1.27	.69	.52	.189
270AB-4-4	1/4	1/4	7/16-24	1.36	.78	.71	.189
270AB-6-2	3/8	1/8	17/32-24	1.72	.83	.59	.314
270AB-6-4	3/8	1/4	17/32-24	1.78	.89	.77	.314
270AB-6-6	3/8	3/8	17/32-24	1.82	.93	.77	.314
270AB-8-6	1/2	3/8	11/16-20	1.99	1.03	.82	.408
270AB-8-8	1/2	1/2	11/16-20	2.09	1.13	1.01	.408
270AB-10-8	5/8	1/2	13/16-18	2.28	1.19	1.07	.533

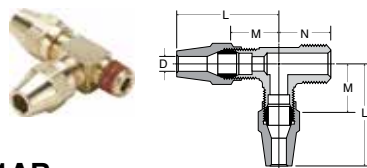

Male Run Tee VS271AB

REF. SAE 120424 BA

PART NO.	TUBE SIZE	PIPE THREAD	STRAIGHT THREAD	L	M	N	FLOW DIA. D
VS271AB-4-2	1/4	1/8	7/16-24	1.20	.62	.66	.189
VS271AB-4-4	1/4	1/4	7/16-24	1.26	.68	.87	.189
VS271AB-6-4	3/8	1/4	17/32-24	1.68	.79	.92	.314
VS271AB-6-6	3/8	3/8	17/32-24	1.73	.84	.91	.314
VS271AB-8-6	1/2	3/8	11/16-20	1.89	.93	.99	.408
VS271AB-8-8	1/2	1/2	11/16-20	1.99	1.03	1.18	.408
VS271AB-10-8	5/8	1/2	13/16-18	2.18	1.09	1.24	.533

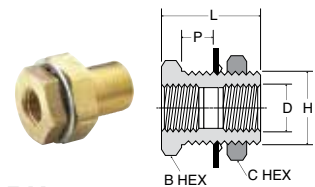

Anchor Coupling 207ACBH

PART NO.	FEMALE PIPE THREAD	STRAIGHT THREAD	MAX .BKHD P	B HEX	C HEX	L	BKHD HOLE DIA. H	FLOW DIA. D
207ACBH-2	1/8	5/8-18	.89	7/8	15/16	1.50	5/8	.339
207ACBHS-2	1/8	5/8-18	.35	7/8	15/16	.96	5/8	.339
207ACBH-4	1/4	3/4-16	.81	1	1-1/8	1.50	3/4	.441
207ACBHS-4	1/4	3/4-16	.26	1	1	.94	3/4	.441
207ACBH-6	3/8	1-14	.62	1-1/8	1-1/4	1.31	1	.571
207ACBH-8	1/2	1-1/8-14	.75	1-1/4	1-3/8	1.50	1-1/8	.703
207ACBH-12	3/4	1-5/16-12	.65	1-1/2	1-1/2	1.50	1-5/16	.906
207ACBH-16*	1	1-5/8-14	1.00	2	2	1.68	1-5/8	1.140

*Lock Washer not Available

WARNING These products can expose you to chemicals including LEAD which is known to the state of California to cause cancer.

Air Brake Hose Ends Fittings



Parker's Air Brake Hose Fittings are field attachable fittings for use with Parker 271 air brake hose. Easy to assemble and disassemble, these fittings meet D.O.T. requirements when used with SAE J1402 air brake hose.

Product Features:

- Brass Body
- Meets D.O.T. FMVSS571.106 when used with SAE J1402 air brake hose

Markets:

- Heavy Duty Truck
- Trailer

Applications:

- Air Lines Frame to Axle

Specifications:

Pressure Range Up to 400 PSI (27.5 bar)

Temperature Range -65° to +250° F (-53.8° to +121.1° C)

Compatible Tubing:

- Parker 271 air brake hose
- SAE J1402 air brake hose

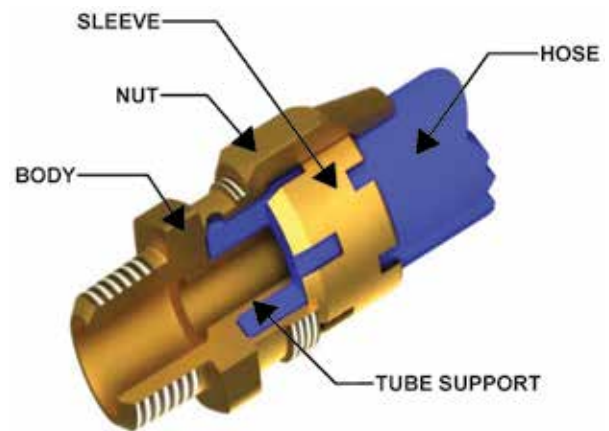

Assembly Instructions

1. Slide nut onto hose
2. Slide sleeve onto hose with tapered edge toward fitting body
3. Bottom hose into fitting
4. Tighten nut until it contacts body hex



Note: When reassembling fitting, body and nut should be inspected. Only reuse if parts are in proper condition. Sleeves should never be Reused.

⚠ WARNING These products can expose you to chemicals including NICKEL or LEAD, which are known to the state of California to cause cancer and LEAD.

Spring 56RBSG

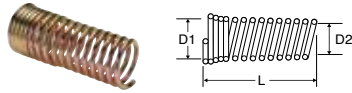

PART NO.	HOSE SIZE	L	D1	D2
56RBSG-6	3/8	2.75	.84	.78
56RBSG-8	1/2	3.00	1.03	.91

Air Brake Hose Nut & Attached Spring 67RBSG

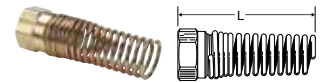

PART NO.	L
67RBSG-6	3.50
67RBSG-8	3.75

Sleeve 60RB

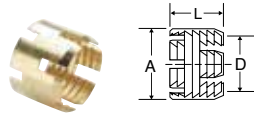

PART NO.	HOSE SIZE	L	A	D
60RB-6	3/8	.69	.90	.78
60RB-8	1/2	.69	1.03	.92

Male Connector 68RB

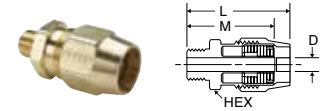

PART NO.	HOSE SIZE	STRAIGHT THREAD	PIPE THREAD	HEX	L	M	D
68RB-6-4	3/8	31/32-20	1/4	31/32	2.24	1.91	.281
68RB-6-6	3/8	31/32-20	3/8	31/32	2.24	1.91	.281
68RB-6-8	3/8	31/32-20	1/2	31/32	2.38	2.06	.281
68RB-8-6	1/2	1-3/32-20	3/8	1-1/8	2.24	1.91	.390
68RB-8-8	1/2	1-3/32-20	1/2	1-1/8	2.29	2.07	.390

Nut 61RB

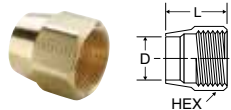

PART NO.	HOSE SIZE	STRAIGHT THREAD	HEX	L	D
61RB-6	3/8	31/32-20	1-1/16	1.12	.80
61RB-8	1/2	1-3/32-20	1-1/4	1.12	.93

Male Connector Body Only 68RB

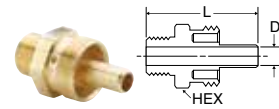

PART NO.	HOSE SIZE	STRAIGHT THREAD	PIPE THREAD	HEX	L	D
68RB-6-4B	3/8	31/32-20	1/4	31/32	1.91	.281
68RB-6-6B	3/8	31/32-20	3/8	31/32	1.91	.281
68RB-6-8B	3/8	31/32-20	1/2	31/32	2.06	.281
68RB-8-6B	1/2	1-3/32-20	3/8	1-1/8	1.91	.390
68RB-8-8B	1/2	1-3/32-20	1/2	1-1/8	2.07	.390

Spring Guard Nut 61RBSG

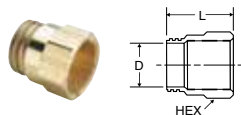

PART NO.	HOSE SIZE	STRAIGHT THREAD	HEX	L	D
61RBSG-6	3/8	31/32-20	1-1/16	1.22	.80
61RBSG-8	1/2	1-3/32-20	1-1/4	1.19	.92

Male Connector with Spring Guard 68RBSG

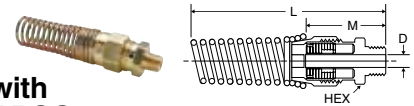

PART NO.	HOSE SIZE	PIPE THREAD	HEX	L	M	D
68RBSG-6-4	3/8	1/4	31/32	4.8	1.91	.281
68RBSG-6-6	3/8	3/8	31/32	4.8	1.91	.281
68RBSG-6-8	3/8	1/2	31/32	4.9	2.06	.281
68RBSG-8-6	1/2	3/8	1-1/8	5.0	1.91	.390
68RBSG-8-8	1/2	1/2	1-1/8	5.2	2.07	.390

Union 62RB

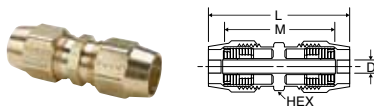

PART NO.	HOSE SIZE	STRAIGHT THREAD	HEX	L	M	D
62RB-6	3/8	31/32-20	31/32	2.98	2.56	.281
62RB-8	1/2	1-3/32-20	1-1/8	2.99	2.55	.390

Female Swivel Connector 66RBSV

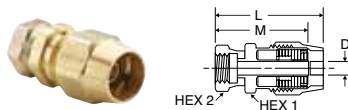

PART NO.	HOSE SIZE	STRAIGHT THREAD	HEX1	HEX2	L	M	D
66RBSV-6-3/4	3/8	3/4-20	31/32	7/8	2.30	2.09	.281
66RBSV-8-7/8	1/2	7/8-20	1-1/8	1"	2.36	2.14	.390

Adapter 76RB

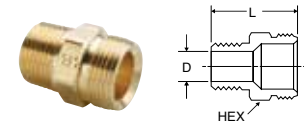

PART NO.	PIPE THREAD	STRAIGHT THREAD	HEX	L	D
76RB-3/4-4	1/4	3/4-20	3/4	1.06	.310
76RB-3/4-6	3/8	3/4-20	3/4	1.12	.422
76RB-7/8-6	3/8	7/8-20	7/8	1.25	.440
76RB-7/8-8	1/2	7/8-20	7/8	1.47	.500

WARNING: These products can expose you to chemicals including NICKEL or LEAD, which are known to the state of California to cause cancer and LEAD.

Vibra-Lok Fittings



Parker's Vibra-Lok Fittings provide a positive reliable seal under vibration conditions, mechanical shock or tube movement. The sleeve cushions the tubing, permitting the tubing to flex back and forth in the fitting. The seal design compensates for tube misalignment and tube surface defects.

Product Features:

- Brass Body
- Sleeves in Buna N and Fluorocarbon
- NPTF and SAE J1926 Straight Threads are Standard
- Excellent Vibration Resistance

Markets:

- Heavy Duty Truck
- Trailer
- Mobile

Applications:

- Oil, Fuel and Coolant Lines on engines

Specifications:

Pressure Range Dependent on condition and tube size, refer to pressure chart

-15° to +450° F (-26.1° to +232.2° C)
with Fluorocarbon Sleeve

Temperature Range

-30° to +275° F (-34.4° to +135° C)
with Buna N Sleeve

Compatible Tubing:

- Copper
- Aluminum
- Steel (Bundy)
- Stainless Steel
- Glass

Pressure Chart

CONDITION	TUBE O.D.	TUBE NOT BELLED	TUBE BELLED OR FLARED
STATIC PRESSURE	3/16"	500	1000
	1/4"	500	1000
	5/16"	450	900
	3/8"	350	700
	1/2"	200	500
MINOR SURGES AND/OR VIBRATIONS	3/16"	400	800
	1/4"	400	800
	5/16"	325	700
	3/8"	225	500
	1/2"	150	375
SEVERE VIBRATIONS OR SHOCK	3/16"	300	600
	1/4"	300	600
	5/16"	225	500
	3/8"	175	400
	1/2"	100	250
	5/8"		100

In high pressure applications and sizes larger than 1/2" O.D., the tube end should be belled or flared.

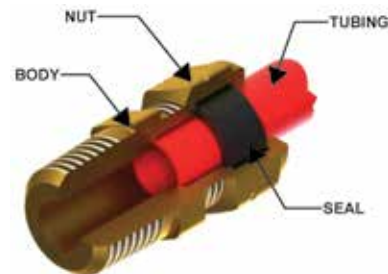

WARNING These products can expose you to chemicals including CARBON BLACK or LEAD, which are known to the state of California to cause cancer.

Assembly Instructions

1. Cut the tubing squarely removing burrs
2. Slip nut and sleeve over tube
3. Bottom tubing into fitting and tighten nut until stop is reached. The elastic sleeve ordinarily will extrude slightly around the tube at the end of the nut. This extrusion further aids in isolating the tube from the nut.



For Higher Pressure applications

4. Consult pressure chart to determine if tubing should be belled
5. Slip nut and sleeve over tube. The sleeve should be positioned near end of tubing just behind the surface to be belled
6. Bell tubing with standard 45° flaring tool or 90° punch. The size of bell should be approximately that shown.



Recommended Size of Bell

TUBE O.D.	BELL DIA. C
1/8	.190-.160
3/16	.255-.225
1/4	.318-.288
5/16	.381-.351
3/8	.444-.414
1/2	.569-.539
5/8	.694-.664
3/4	.819-.789
7/8	.944-.914

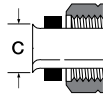

Tube Length Calculator

This table shows distance tube extends beyond face of Vibra-Lok fitting body on installation with bell on tubing and without bell on tubing.

O.D. OF TUBE	A WITH BELL	B WITHOUT BELL
1/8	3/16	3/16
3/16	3/16	7/32
1/4	3/16	1/4
5/16	3/16	1/4
3/8	3/16	1/4
1/2	3/16	11/32
5/8	3/16	TUBING SHOULD BE BELLED
3/4	3/16	
7/8	1/4	

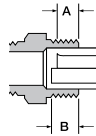

Sleeve 60VL

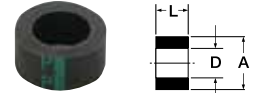

PART NO.	TUBE SIZE	A	D	L
60VL-2	1/8	.306	.100	.20
60VL-3	3/16	.359	.156	.20
60VL-4	1/4	.422	.219	.21
60VL-5	5/16	.484	.281	.24
60VL-6	3/8	.547	.344	.25
60VL-8	1/2	.688	.469	.36
60VL-10	5/8	.875	.594	.48
60VL-12	3/4	1.000	.720	.59

Sleeve (Fluorocarbon) 60VLV

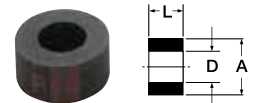

PART NO.	TUBE SIZE	A	D	L
60VLV-3	3/16	.359	.156	.20
60VLV-4	1/4	.422	.219	.21
60VLV-5	5/16	.484	.281	.24
60VLV-6	3/8	.547	.344	.25
60VLV-8	1/2	.688	.469	.36
60VLV-10	5/8	.875	.594	.48
60VLV-12	3/4	1.000	.720	.59

Nut 61VL

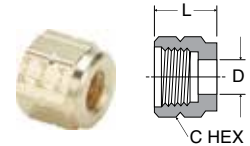

PART NO.	TUBE SIZE	STRAIGHT THREAD	C HEX	D	L
61VL-2	1/8	3/8-24	7/16	.156	.44
61VL-3	3/16	7/16-24	1/2	.218	.47
61VL-4	1/4	1/2-24	9/16	.281	.50
61VL-5	5/16	9/16-24	5/8	.344	.53
61VL-6	3/8	5/8-24	3/4	.406	.53
61VL-8	1/2	13/16-18	15/16	.531	.67
61VL-10	5/8	1-18	1-1/8	.656	.88
61VL-12	3/4	1-1/8-18	1-1/4	.781	.98

Union 62VL

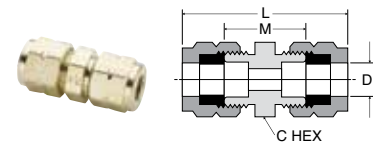

PART NO.	TUBE SIZE	C HEX	L	M	FLOW DIA. D
62VL-4	1/4	9/16	1.39	.77	.188
62VL-5	5/16	5/8	1.49	.81	.250
62VL-6	3/8	11/16	1.49	.80	.312
62VL-8	1/2	7/8	1.90	.94	.437

WARNING: These products can expose you to chemicals including CARBON BLACK or LEAD, which are known to the state of California to cause cancer.

[Click here for CADs, Product Specifications or to Configure Parts Online](#)

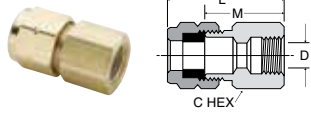

Female Connector 66VL

PART NO.	TUBE SIZE	PIPE THREAD	C HEX	L	M	FLOW DIA. D
66VL-4-2	1/4	1/8	9/16	1.09	.78	.188
66VL-5-4	5/16	1/4	11/16	1.32	.97	.250

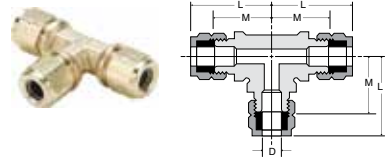

Union Tee 164VL

PART NO.	TUBE SIZE	BODY HEX	L	M	FLOW DIA. D
164VL-3	3/16	3/8	.98	.69	.160
164VL-4	1/4	1/2	1.06	.75	.190
164VL-5	5/16	15/32	1.22	.88	.250
164VL-8	1/2	13/16	1.64	1.16	.406

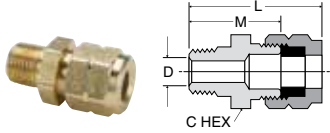

Male Connector 68VL

PART NO.	TUBE SIZE	PIPE THREAD	C HEX	L	M	FLOW DIA. D
68VL-2-2	1/8	1/8	7/16	1.12	.81	.093
68VL-3-2	3/16	1/8	1/2	1.10	.81	.125
68VL-4-2	1/4	1/8	9/16	1.15	.84	.188
68VL-4-4	1/4	1/4	9/16	1.34	1.03	.188
68VL-5-4	5/16	1/4	5/8	1.41	1.06	.250
68VL-6-2	3/8	1/8	11/16	1.22	.87	.235
68VL-6-4	3/8	1/4	11/16	1.41	1.06	.312
68VL-6-6	3/8	3/8	11/16	1.41	1.06	.312
68VL-8-6	1/2	3/8	7/8	1.64	1.16	.406
68VL-8-8	1/2	1/2	7/8	1.64	1.35	.406
68VL-10-8	5/8	1/2	1-1/16	2.10	1.44	.560
68VL-12-8	3/4	1/2	1-3/16	2.26	1.50	.530
68VL-12-12	3/4	3/4	1-3/16	2.26	1.50	.688

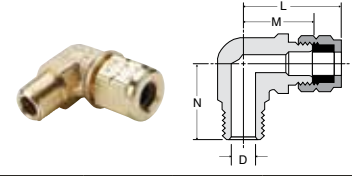

Male Elbow 169VL

PART NO.	TUBE SIZE	PIPE THREAD	L	M	N	FLOW DIA. D
169VL-3-2	3/16	1/8	.98	.69	.75	.156
169VL-4-2	1/4	1/8	1.00	.69	.78	.188
169VL-4-4	1/4	1/4	1.16	.84	1.00	.188
169VL-5-4	5/16	1/4	1.16	.81	1.00	.252
169VL-6-2	3/8	1/8	1.19	.84	.91	.235
169VL-6-4	3/8	1/4	1.19	.84	1.06	.312
169VL-6-6	3/8	3/8	1.29	.94	1.13	.312
169VL-8-6	1/2	3/8	1.48	1.00	1.06	.406
169VL-8-8	1/2	1/2	1.54	1.06	1.44	.406
169VL-10-8	5/8	1/2	1.92	1.28	1.47	.565

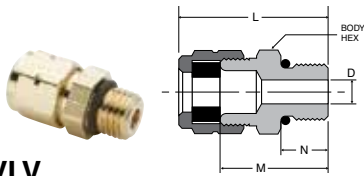

Male Connector 685VLV

PART NO.	TUBE SIZE	STRAIGHT THREAD	BODY HEX	L	M	N	D
685VLV-4-4	1/4	7/16-20	9/16	1.14	.83	.36	.18
685VLV-5-4	5/16	7/16-20	5/8	1.18	.83	.36	.18
685VLV-6-4	3/8	7/16-20	11/16	1.18	.83	.36	.18
685VLV-6-6	3/8	9/16-18	11/16	1.25	.90	.39	.30
685VLV-8-8	1/2	3/4-16	7/8	1.52	1.04	.44	.39
685VLV-10-10	5/8	7/8-14	1 1/16	1.84	1.20	.50	.50
685VLV-12-12	3/4	1 1/16-12	1 1/4	2.10	1.34	.59	.62

Note: Fluorocarbon seal & o-ring standard

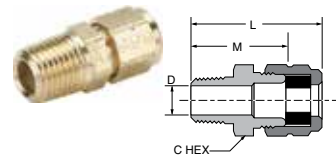

Straight Through Tank Fitting 682VL

PART NO.	TUBE SIZE	PIPE THREAD	C HEX	L	M	FLOW DIA. D
682VL-4-2	1/4	1/8	9/16	1.15	.84	.265
682VL-4-4	1/4	1/4	9/16	1.34	1.03	.265
682VL-5-4	5/16	1/4	5/8	1.41	1.06	.328
682VL-6-6	3/8	3/8	11/16	1.41	1.06	.406

WARNING These products can expose you to chemicals including CARBON BLACK, or LEAD, which are known to the state of California to cause cancer.

Click here for CADs, Product Specifications or to Configure Parts Online

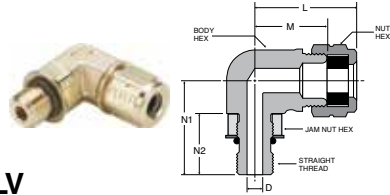

Male Elbow 1695VLV

PART NO.	TUBE SIZE	STRAIGHT THREAD	NUT HEX	BODY HEX	JAM NUT HEX	L	M	N1	N2	D
1695VLV-4-4	1/4	7/16-20	9/16	9/16	9/16	1.15	.84	1.07	.71	.18
1695VLV-5-4	5/16	7/16-20	5/8	9/16	9/16	1.16	.81	1.07	.71	.18
1695VLV-6-4	3/8	7/16-20	3/4	5/8	9/16	1.19	.84	1.10	.71	.18
1695VLV-6-6	3/8	9/16-18	3/4	5/8	11/16	1.29	.94	1.17	.78	.30
1695VLV-8-8	1/2	3/4-16	15/16	3/4	7/8	1.54	1.06	1.44	.89	.39
1695VLV-10-10	5/8	7/8-14	1 1/8	1.00	1.00	1.92	1.28	1.68	1.03	.50
1695VLV-12-12	3/4	1 1/16-12	1 1/4	1.00	1 1/4	2.04	1.28	1.82	1.17	.62

Note: Fluorocarbon seal & o-ring standard

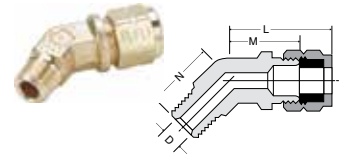

45° Elbow 179VL

PART NO.	TUBE SIZE	PIPE THREAD	L	M	N	FLOW DIA. D
179VL-4-2	1/4	1/8	1.06	.75	.69	.188
179VL-6-4	3/8	1/4	1.07	.72	.84	.315

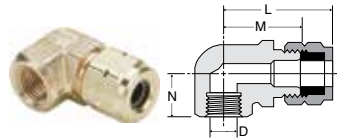

Female Elbow 170VL

PART NO.	TUBE SIZE	PIPE THREAD	L	M	N	FLOW DIA. D
170VL-4-2	1/4	1/8	.96	.65	.50	.188
170VL-5-4	5/16	1/4	1.16	.81	.70	.250

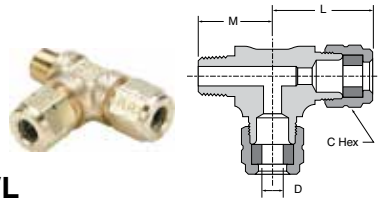

Male Run Tee 171VL

PART NO.	TUBE SIZE	PIPE THREAD	C HEX	L	M	FLOW DIA. D
171VL-4-2	1/4	1/8	9/16	1.03	.76	.188
171VL-4-4	1/4	1/4	9/16	1.12	1.03	.188

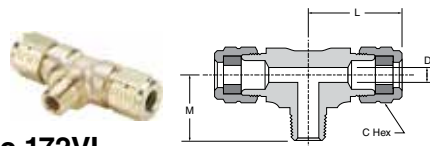

Male Branch Tee 172VL

PART NO.	TUBE SIZE	PIPE THREAD	C HEX	L	M	FLOW DIA. D
172VL-4-2	1/4	1/8	9/16	1.06	.75	.188

WARNING These products can expose you to chemicals including CARBON BLACK, or LEAD, which are known to the state of California to cause cancer.

Truck Valves & Lanyard Valve



Parker's Truck Valves have metal-to-metal seats with fine thread screwdown. Parker's Lanyard Valves' compact design is ideally suited for releasing condensate from air tanks.

Product Features:

Truck Valves

- Brass Body and Stem
- Flare, Hose, Tube and Pipe Connections
- Round and Pin Handles

Lanyard Valve

- Low Temperature Seal
- All Brass Body
- Manual Release

Markets:

- Heavy Duty Truck
- Trailer
- Mobile

Applications:

- Water
- Oil
- Coolant lines

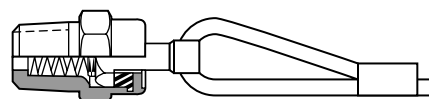

Truck Valve Specifications:

Pressure Range Up to 150 PSI (10.3 bar)

Temperature Range -30° to +250° F (-34.4° to +121.1° C)

Lanyard Valve Specifications:

Pressure Range Up to 150 PSI (10.3 bar)

Temperature Range -40° to +200° F (-40° to +93.3° C)

Lanyard Valve Operating Instructions

A pulling action exerted on the cable cocks the stem, allowing condensate to pass through the valve. Releasing the cable resets the stem which returns the valve to its closed position.

⚠ WARNING These products can expose you to chemicals including LEAD which is known to the state of California to cause cancer.

Truck Valve V404P

Hose to Male Pipe

Temperature Range: -30° to +250° F (-34.4° to +121.1° C)

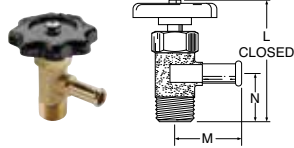

PART NO.	HOSE I.D.	PIPE THREAD	FLOW	L	M	N
V404P-6-6	3/8	3/8	.281	2.35	1.36	.94
V404P-10-6	5/8	3/8	.406	2.75	1.31	1.10

Truck Valve V404PH

Hose to Male Pipe with Pin Handle

Temperature Range: -30° to +250° F (-34.4° to +121.1° C)

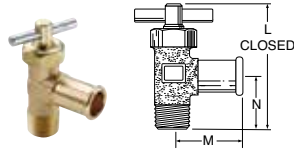

PART NO.	HOSE I.D.	PIPE THREAD	FLOW	L	M	N
V404PH-10-6	5/8	3/8	.406	2.47	1.31	1.10

Truck Valve SV404P

Hose to Male Pipe

Temperature Range: -30° to +250° F (-34.4° to +121.1° C)

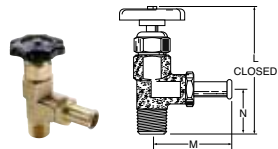

PART NO.	HOSE I.D.	PIPE THREAD	FLOW	L	M	N
SV404P-10-8	5/8	1/2	.468	3.71	2.31	1.34
SV404P-12-6	3/4	3/8	.438	3.73	2.31	1.34
SV404P-12-8	3/4	1/2	.562	3.73	2.31	1.34

Truck Valve V405P

Female Pipe to Male Pipe

Temperature Range: -30° to +250° F (-34.4° to +121.1° C)

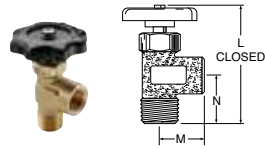

PART NO.	FEMALE PIPE THREAD	MALE PIPE THREAD	FLOW	L	M	N
V405P-6-6	3/8	3/8	.406	2.72	.91	1.19
V405P-6-8	3/8	1/2	.406	2.95	.91	1.31
V405P-8-8	1/2	1/2	.562	3.15	1.17	1.34

Truck Valve V408NTA

Tube to Male Pipe

Temperature Range: -30° to +250° F (-34.4° to +121.1° C)

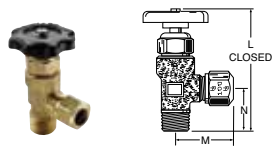

PART NO.	TUBE SIZE	PIPE THREAD	FLOW	L	M	N
V408NTA-8-8	1/2	1/2	.328	3.28	1.15	1.19

Truck Valve V409F

Flare to Male Pipe

Temperature Range: -30° to +250° F (-34.4° to +121.1° C)

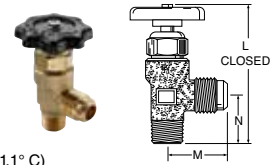

PART NO.	TUBE SIZE	PIPE THREAD	FLOW	L	M	N
V409F-8-6	1/2	3/8	.406	3.07	1.31	1.00
V409F-8-8	1/2	1/2	.406	3.28	1.31	1.19
V409F-10-8	5/8	1/2	.500	3.47	1.50	1.25
V409F-12-8	3/4	1/2	.562	3.70	2.31	1.34

Truck Valve V410NTA

Tube to Male Pipe

Temperature Range: -30° to +250° F (-34.4° to +121.1° C)

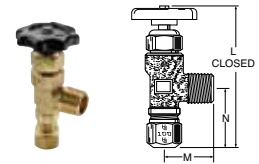

F PART NO.	TUBE SIZE	PIPE THREAD	FLOW	L	M	N
V410NTA-8-8	1/2	1/2	.328	3.58	1.38	1.31

Truck Valve V412F

Tube to Male Pipe

Temperature Range: -30° to +250° F (-34.4° to +121.1° C)

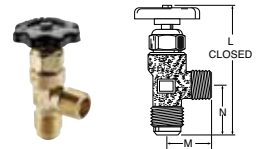

PART NO.	TUBE SIZE	PIPE THREAD	FLOW	L	M	N
V412F-10-8	5/8	1/2	.500	3.60	1.38	1.31

LV91HF-4-SUB

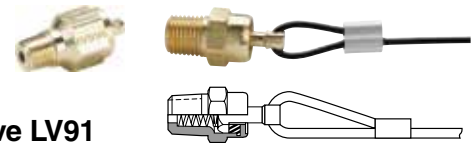

Lanyard Valve LV91

Temperature Range: -40° to +200° F (-40° to +93.3° C)

PART NO.	PIPE THREAD	CABLE LENGTH INCHES
LV91-4-036	1/4	36
LV91-4-048	1/4	48
LV91-4-060	1/4	60
LV91HF-4-SUB	1/4	--

WARNING: These products can expose you to chemicals including LEAD which is known to the state of California to cause cancer.



Industrial Compression Style Fittings

Compression Fittings

Compress-Align® Fittings

Brass Metric Compression

Poly-Tite Fittings

Hi-Duty Flareless Tube Fittings



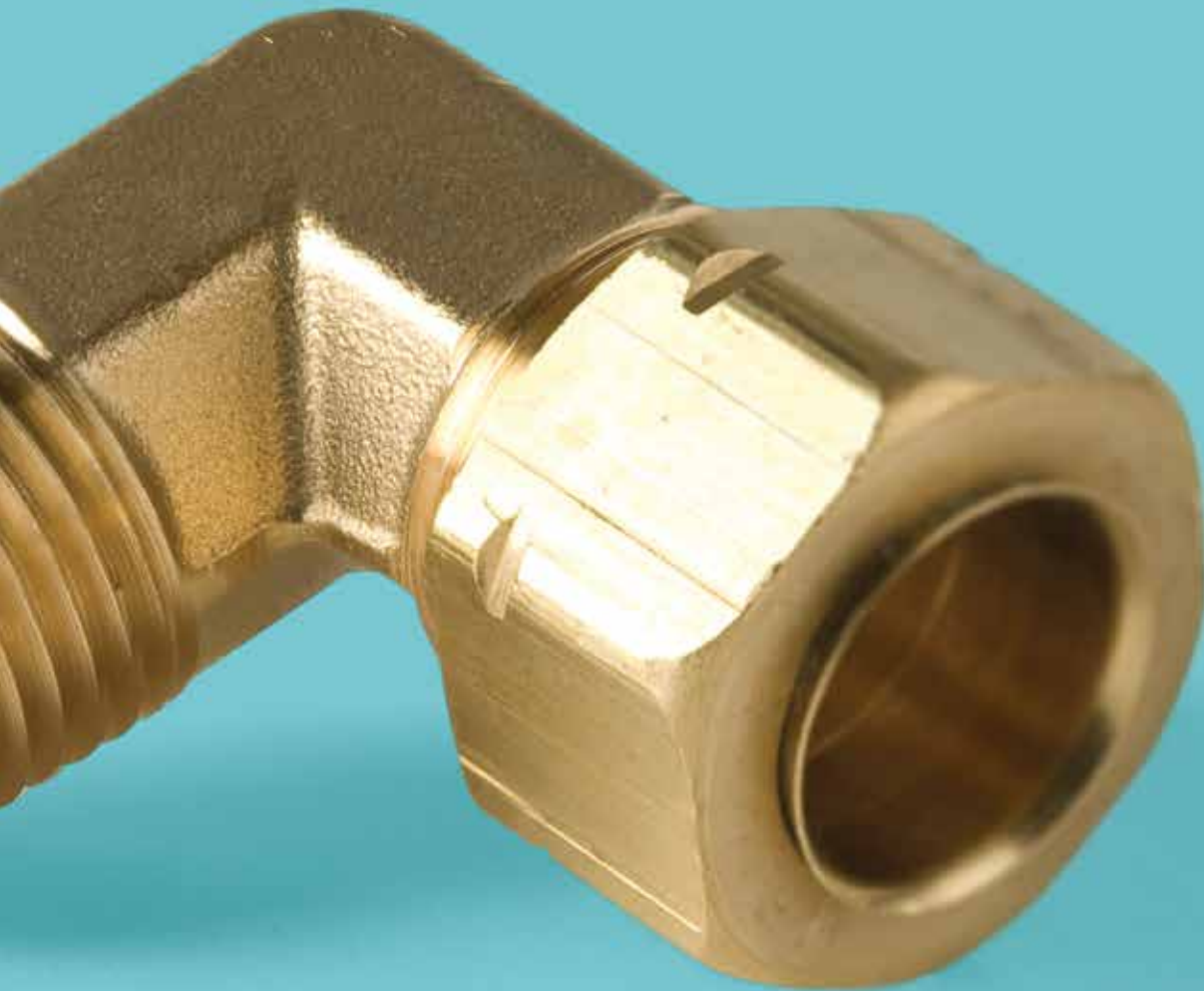

GOODYEAR
RUBBER PRODUCTS, INC.

+1.727.342.5087

También puede enviarnos un correo electrónico a
ventas@goodyearrubberproducts.com

■ Compression Fittings

60C
Sleeve
p. G8



60PT
Plastic Sleeve
p. G8



61C
Nut
p. G8



61CL
Long Nut
p. G8



62C
Union
p. G8



62CBH
Bulkhead Union
p. G9



63PT
Tube Support
p. G9, G13



66C
Female Connector
NPT
p. G9



68C
Male Connector
NPTF
p. G9



164C-264C
Union Tee
p. G10



165C-265C
Union Elbow
p. G10



169C-269C
Male Elbow
NPTF
p. G10



170C-270C
Female Elbow
NPT
p. G11



171C
Male Run Tee
NPTF
p. G11



172C
Male Branch Tee
NPTF
p. G11



176C
Adaptor
NPTF
p. G11



177C
Female Branch Tee
NPT
p. G11



179C
45° Male Elbow
NPTF
p. G11



639C
Seal Plug
p. G11



682C
Tank Fitting
NPTF
p. G11



■ Compress-Align® Fittings

59CA
Plug
p. G13



61CA
Nut/Sleeve
p. G13



62CA
Union
p. G13



62CABH
Bulkhead Union
p. G13



62PCA
Union
p. G13



62PCABH
Bulkhead Union
p. G13



63PT
Tube Support
p. G9, G13



66CA
Female Connector
NPT
p. G14



68CA
Male Connector
NPTF
p. G14



164CA-264CA
Union Tee
p. G14



165CA-265CA
Union Elbow
p. G14



169CA-269CA
Male Elbow
NPTF
p. G15



170CA-270CA
Female Elbow
NPT
p. G15



171CA
Male Run Tee
NPTF
p. G15



172CA
Male Branch Tee
NPTF
p. G15



176CA
Adaptor
NPTF
p. G16



177CA
Female Branch Tee
NPT
p. G16



179CA
45° Male Elbow
NPTF
p. G16



639CA
Seal Plug
p. G16



682CA
Tank Fitting
NPTF
p. G16



⚠ WARNING These products can expose you to chemicals including NICKEL or LEAD, which are known to the state of California to cause cancer and LEAD.

Brass Metric Compression Fittings

0105

Male Connector
NPT, BSPT
p. G18



0101

Male Elbow
BSPP, Straight
p. G18, G19



0114

Female Connector
BSPP
p. G20



0109

Male Elbow
NPT, BSPT
p. G20, G21



0199

Male Elbow
BSPP
p. G21



0108

Male Branch Tee
BSPT
p. G21



0103

Male Run Tee
BSPT
p. G22



0118

Single Banjo
p. G22, G23



0119

Double Banjo
p. G22, G23



0106

Union
p. G23



0116

Bulkhead Union
p. G23



0102

Union Elbow
p. G24



0104

Union Tee
p. G24



0107

Union Cross
p. G24



0142

Union Y
p. G24



0124

Metric Sleeve
p. G25



0111

Metric Sleeve
p. G25



0110

Metric Nut
p. G25



0110 60

Metric Nut
p. G25



0110 70

Metric Nut Sleeve
p. G27



0125

Metric End Plug
p. G27



0220

Metric Male Plug
p. G27



0168

Reducer
BSPP
p. G27



0127

Metric Tube
Support
p. G27



Poly-Tite Fittings

56PSG

Spring guard
p. G29



59P

Plug
p. G29



60P

Plastic Sleeve
p. G29



60PB

Brass Sleeve
p. G29



61P

Nut/Plastic Sleeve
p. G29



61PB

Nut/Brass Sleeve
p. G29



61PN

Nut Only
p. G29



61PSGN

Spring Guard Nut
p. G29



62P

Union
p. G29, G30



62PBH

Bulkhead Union
p. G30



62PCA

Union
p. G30



62PCABH

Bulkhead Union
p. G30



62PTBH

Bulkhead Union
p. G30



66P

Female Connector
NPT
p. G30



68P

Male Connector
NPTF
p. G31



97P

Tube Reducer
p. G31



391P

Coupler Body
p. G31



391PSS

Coupler Body
p. G31



392P

Bulkhead Body
p. G31



392PSS

Bulkhead Body
p. G31



393P

Through Insert
p. G31



WARNING: These products can expose you to chemicals including NICKEL or LEAD, which are known to the state of California to cause cancer and LEAD.

393PSS

Through Insert
p. G31



393PD

Shutoff Insert
p. G32



393PDSS

Shutoff Insert
p. G32



394P

Single Shutoff
p. G32



394PSS

Single Shutoff
p. G32



394PD

Double Shutoff
p. G32



394PDSS

Double Shutoff
p. G32



398P

Single Shutoff
p. G32



398PSS

Single Shutoff
p. G32



398PD

Double Shutoff
p. G33



398PDSS

Double Shutoff
p. G33



164P

Union Tee
p. G33



169P-269P

Male Elbow
NPTF
p. G33



169LP

Long Elbow
NPTF
p. G33



169PS

Male Elbow Swivel
NPTF
p. G33



170P

Female Elbow
NPT
p. G34



171P

Male Run Tee
NPTF
p. G34



172P

Male Branch Tee
NPTF
p. G34



177P

Female Branch Tee
NPT
p. G34



NV311P

Needle Valve
NPTF
p. G34



NV312P

Needle Valve
NPTF
p. G34



Hi-Duty Flareless Tube Fittings

62HDBH

Bulkhead Union
p. G36



61HD

Nut
p. G36



62HD

Union
p. G36



62HD

Reducing Union
p. G36



164HD

Union Tee
p. G36



165HD

Union Elbow
p. G36



66HD

Female Connector
NPT
p. G36



68HD

Male Connector
NPTF
p. G37



169HD

Male Elbow
NPTF
p. G37



170HD

Female Elbow
NPT
p. G37



171HD

Male Run Tee
NPTF
p. G37



172HD

Male Branch Tee
NPTF
p. G37



179HD

45° Male Elbow
NPTF
p. G37



177HD

Female Branch Tee
NPT
p. G38



59HD

Plug
p. G38



WARNING These products can expose you to chemicals including NICKEL or LEAD, which are known to the state of California to cause cancer and LEAD.



Compression Fittings

Parker's Compression Fittings provide users with an economical choice with numerous connection options for a wide variety of tube materials without the need for flaring, soldering or other tube preparation necessary to assemble.

Product Features:

- Meets functional requirements of SAE J-512
- UL Listed for flammable liquid
- Brass or acetal sleeve available
- No tube preparation
- Forged and extruded shapes

Markets:

- Industrial
- Packaging
- Pneumatic
- Printing

Applications:

- Air lines
- Lubrication Lines
- Cooling lines
- Industry
- Machinery
- Compressors
- Fluid transfer

Compatible Tubing:

- Copper
- Aluminum
- Thermoplastic tubing



Specifications:

Temperature Range: -65° to +200° F (- 53.8° to +93.3° C)

Pressure Range:

TUBE SIZE	PSI	bar	TUBE SIZE	PSI	bar
1/8	2800	193.0	1/2	750	51.7
3/16	1900	131.0	5/8	650	44.8
1/4	1400	96.5	3/4	550	37.9
5/16	1200	82.7	7/8	450	24.1
3/8	1000	68.9			

Note: Pressures listed in above table are with brass sleeve and copper tubing

Assembly Instructions

1. Slide nut then sleeve onto tubing. The thread end of the nut must face out.
2. Insert tube and bottom on the fitting shoulder
3. Assemble nut to body and tighten "hand tight". Then wrench tighten the number of turns indicated in the table.



FITTING SIZE	TUBE SIZE	TURNS REQUIRED TO SEAL FROM HAND-TIGHT	
		60C WITH SOFT METAL TUBING	60PT WITH THERMOPLASTIC TUBING
2	1/8	1-1/4	—
3	3/16	1-1/4	—
4	1/4	1-1/4	2
5	5/16	1-1/4	2
6	3/8	2-1/4	2
8	1/2	2-1/4	2
10	5/8	2-1/4	2
12	3/4	2-1/4	2
14	7/8	2-1/4	—

WARNING These products can expose you to chemicals including LEAD which is known to the state of California to cause cancer.

Sleeve 60C

REF. SAE 060115

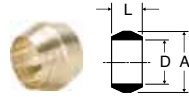

PART NO.	TUBE SIZE	A	D	L
60C-2	1/8	.187	.130	.19
60C-3	3/16	.266	.192	.22
60C-4	1/4	.344	.255	.25
60C-5	5/16	.406	.318	.25
60C-6	3/8	.469	.382	.25
60C-7	7/16	.531	.444	.31
60C-8	1/2	.594	.507	.38
60C-10	5/8	.719	.632	.38
60C-12	3/4	.875	.758	.44
60C-14	7/8	1.000	.883	.41

Long Nut 61CL

REF. SAE 060111

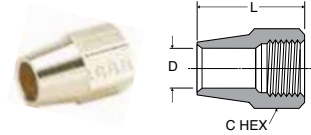

PART NO.	TUBE SIZE	STRAIGHT THREAD	C HEX	D	L
61CL-4	1/4	7/16-24	1/2	.255	.75
61CL-5	5/16	1/2-24	9/16	.318	.84
61CL-6	3/8	9/16-24	5/8	.382	.97
61CL-8	1/2	11/16-20	13/16	.507	1.06
61CL-10	5/8	13/16-18	15/16	.632	1.19
61CL-12	3/4	1-18	1-3/16	.758	1.38

Acetal Sleeve 60PT

PART NO.	PLASTIC TUBE WALL	TUBE WALL	A	D	L
60PT-4	1/4	.040	.375	.254	.19
60PT-5	5/16	.062	.438	.317	.19
60PT-6	3/8	.062	.500	.379	.19
60PT-8	1/2	.062	.631	.507	.25
60PT-10	5/8	.062	.747	.632	.22



Union 62C

REF. SAE 060101 BA

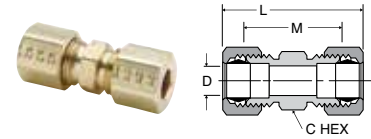

PART NO.	TUBE SIZE	STRAIGHT THREAD	C HEX	L	M	FLOW DIA. D
62C-2	1/8	5/16-24	5/16	1.05	.64	.094
62C-3	3/16	3/8-24	3/8	1.21	.72	.125
62C-4	1/4	7/16-24	7/16	1.33	.79	.188
62C-5	5/16	1/2-24	1/2	1.39	.85	.250
62C-6	3/8	9/16-24	9/16	1.52	.97	.312
62C-7	7/16	5/8-24	5/8	1.70	1.02	.312
62C-8	1/2	11/16-20	11/16	1.90	1.08	.406
62C-10	5/8	13/16-18	13/16	2.06	1.23	.500
62C-12	3/4	1-18	1	2.37	1.41	.562
62C-14	7/8	1-1/8-18	1-1/8	2.07	1.19	.766

Nut 61C

REF. SAE 060110



PART NO.	TUBE SIZE	STRAIGHT THREAD	C HEX	D	L
61C-2	1/8	5/16-24	3/8	.130	.38
61C-3	3/16	3/8-24	7/16	.192	.41
61C-4	1/4	7/16-24	1/2	.255	.44
61C-5	5/16	1/2-24	9/16	.318	.44
61C-6	3/8	9/16-24	5/8	.382	.47
61C-7	7/16	5/8-24	11/16	.444	.50
61C-8	1/2	11/16-20	13/16	.507	.62
61C-10	5/8	13/16-18	15/16	.632	.62
61C-12	3/4	1-18	1-3/16	.758	.69
61C-14	7/8	1-1/8-18	1-1/4	.890	.62

Union Reducers 62C

REF. SAE 060101 BA

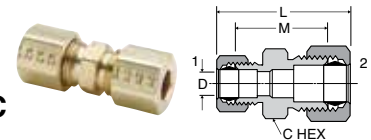

PART NO.	1 TUBE SIZE	2 TUBE SIZE	1 STRAIGHT THREAD	2 STRAIGHT THREAD	C HEX	L	M	FLOW DIA. D
62C-4-3	3/16	1/4	3/8-24	7/16-24	7/16	1.29	.78	.125
62C-6-4	1/4	3/8	7/16-24	9/16-24	9/16	1.46	.91	.188
62C-8-6	3/8	1/2	9/16-24	11/16-20	11/16	1.71	1.03	.312
62C-10-6	3/8	5/8	9/16-24	13/16-18	13/16	1.82	1.13	.312

WARNING: These products can expose you to chemicals including LEAD which is known to the state of California to cause cancer.

[Click here for CADs, Product Specifications or to Configure Parts Online](#)

Bulkhead Union 62CBH

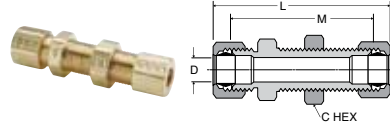

PART NO.	TUBE SIZE	STRAIGHT THREAD	C HEX	L	M	BULKHEAD HOLE DIA.	FLOW DIA. D
62CBH-4	1/4	7/16-24	9/16	2.29	1.75	7/16	.188
62CBH-6	3/8	9/16-24	11/16	2.42	1.88	9/16	.312

Male Connector 68C

REF. SAE 060102 BA

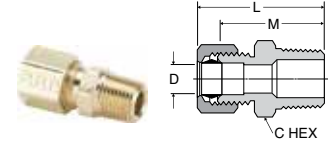

PART NO.	TUBE SIZE	PIPE THREAD	STRAIGHT THREAD	C HEX	L	M	FLOW DIA. D
68C-2-1	1/8	1/16	5/16-24	3/8	.99	.78	.095
68C-2-2	1/8	1/8	5/16-24	7/16	.97	.77	.094
68C-3-1	3/16	1/16	3/8-24	3/8	1.08	.84	.125
68C-3-2	3/16	1/8	3/8-24	7/16	1.08	.84	.125
68C-3-4	3/16	1/4	3/8-24	9/16	1.27	1.03	.125
68C-4-2	1/4	1/8	7/16-24	7/16	1.10	.86	.188
68C-4-4	1/4	1/4	7/16-24	9/16	1.30	1.06	.188
68C-4-6	1/4	3/8	7/16-24	11/16	1.27	1.03	.188
68C-4-8	1/4	1/2	7/16-24	7/8	1.55	1.31	.188
68C-5-2	5/16	1/8	1/2-24	1/2	1.15	.89	.234
68C-5-4	5/16	1/4	1/2-24	9/16	1.33	1.07	.250
68C-6-2	3/8	1/8	9/16-24	9/16	1.25	.97	.250
68C-6-4	3/8	1/4	9/16-24	9/16	1.42	1.14	.312
68C-6-6	3/8	3/8	9/16-24	11/16	1.44	1.16	.312
68C-6-8	3/8	1/2	9/16-24	7/8	1.53	1.25	.312
68C-7-4	7/16	1/4	5/8-24	5/8	1.50	1.17	.312
68C-8-4	1/2	1/4	11/16-20	11/16	1.60	1.20	.312
68C-8-6	1/2	3/8	11/16-20	11/16	1.60	1.20	.406
68C-8-8	1/2	1/2	11/16-20	7/8	1.71	1.31	.406
68C-10-6	5/8	3/8	13/16-18	13/16	1.73	1.31	.406
68C-10-8	5/8	1/2	13/16-18	7/8	1.90	1.48	.500
68C-10-12	5/8	3/4	13/16-18	1-1/16	1.98	1.56	.500
68C-12-8	3/4	1/2	1-18	1	2.05	1.60	.562
68C-12-12	3/4	3/4	1-18	1-1/16	2.08	1.63	.656
68C-14-12	7/8	3/4	1-1/8-18	1-1/8	1.76	1.41	.750

Brass Insert 63PT

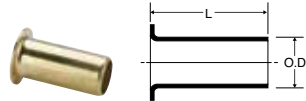

PART NO.	TUBE O.D.	TUBE WALL	L	O.D.
63PT-2-16	1/8	.016	.46	.080
63PT-2-23	1/8	.023	.45	.073
63PT-3-25	3/16	.025	.45	.135
63PT-3-40	3/16	.040	.52	.095
63NTA-4*	1/4		.53	.163
63PT-4-62	1/4	.062	.33	.110
63PT-5-40	5/16	.040	.50	.232
63PT-5-62	5/16	.062	.53	.187
63NTA-6*	3/8		.64	.245
63NTA-8*	1/2		.81	.370
63PT-10-62	5/8	.062	.72	.483

* Denotes 304 stainless steel

Female Connector 66C

REF. SAE 060103 BA

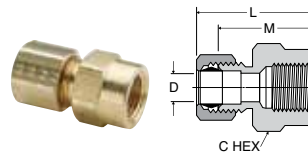

PART NO.	TUBE SIZE	PIPE THREAD	STRAIGHT THREAD	C HEX	L	M	FLOW DIA. D
66C-2-2	1/8	1/8	5/16-24	9/16	.95	.75	.094
66C-3-2	3/16	1/8	3/8-24	9/16	1.02	.78	.125
66C-3-4	3/16	1/4	3/8-24	11/16	1.20	.96	.125
66C-4-2	1/4	1/8	7/16-24	9/16	1.02	.78	.188
66C-4-4	1/4	1/4	7/16-24	11/16	1.24	1.00	.188
66C-5-2	5/16	1/8	1/2-24	9/16	1.07	.81	.250
66C-5-4	5/16	1/4	1/2-24	11/16	1.29	1.03	.250
66C-6-2	3/8	1/8	9/16-24	9/16	1.06	.78	.312
66C-6-4	3/8	1/4	9/16-24	11/16	1.34	1.06	.312
66C-6-6	3/8	3/8	9/16-24	13/16	1.34	1.06	.312
66C-6-8	3/8	1/2	9/16-24	1	1.54	1.27	.312
66C-7-6	7/16	3/8	5/8-24	13/16	1.43	1.09	.312
66C-8-4	1/2	1/4	11/16-20	11/16	1.49	1.09	.406
66C-8-6	1/2	3/8	11/16-20	13/16	1.52	1.12	.406
66C-8-8	1/2	1/2	11/16-20	1	1.71	1.31	.406
66C-10-8	5/8	1/2	13/16-18	1	1.80	1.38	.500

⚠ WARNING These products can expose you to chemicals including LEAD which is known to the state of California to cause cancer.

Union Tee 164C-264C

REF. SAE 060401 BA

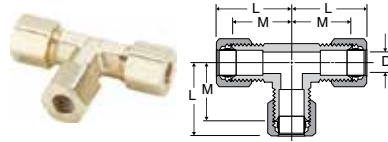

PART NO.	TUBE SIZE	STRAIGHT THREAD	L	M	FLOW DIA. D
164C-2	1/8	5/16-24	.82	.61	.094
264C-3	3/16	3/8-24	.84	.60	.125
164C-4	1/4	7/16-24	.86	.63	.188
264C-4	1/4	7/16-24	.84	.60	.188
164C-5	5/16	1/2-24	.98	.71	.250
164C-6	3/8	9/16-24	1.03	.74	.312
164C-8	1/2	11/16-20	1.34	.93	.406
164C-10	5/8	13/16-18	1.54	1.08	.500
164C-12	3/4	1.00-18	1.65	1.17	.563

Union Tee 164C-264C Combination Sizes

REF. SAE 060401 BA

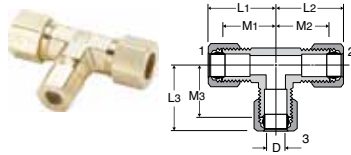

PART NO.	1 TUBE SIZE	2 TUBE SIZE	3 TUBE SIZE	L1	L2	L3	M1	M2	M3	FLOW DIA. D
164C-6-4-4	3/8	1/4	1/4	1.03	.96	.96	.75	.72	.72	.188
164C-6-6-4	3/8	3/8	1/4	1.03	.96	.96	.75	.75	.72	.188
164C-8-8-6	1/2	1/2	3/8	1.34	1.16	1.16	.94	.94	.88	.312

Union Elbow 165C-265C

REF. SAE 060201 BA

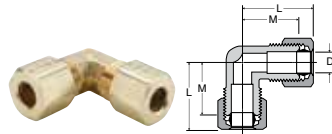

PART NO.	TUBE SIZE	STRAIGHT THREAD	L	M	FLOW DIA. D
165C-2	1/8	5/16-24	.82	.61	.094
165C-3	3/16	3/8-24	.87	.61	.125
165C-4	1/4	7/16-24	.88	.61	.188
265C-4	1/4	7/16-24	.84	.60	.188
165C-5	5/16	1/2-24	.95	.71	.250
165C-6	3/8	9/16-24	1.03	.74	.312
165C-7	7/16	5/3-24	1.16	.82	.312
165C-8	1/2	11/16-20	1.34	.93	.406
165C-10	5/8	13/16-18	1.48	1.05	.500
165C-12	3/4	1-18	1.65	1.17	.563

Male Elbow 169C-269C

REF. SAE 060202 BA

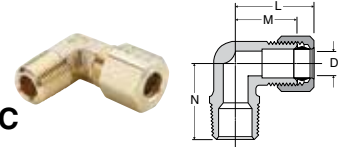

PART NO.	TUBE SIZE	PIPE THREAD	STRAIGHT THREAD	L	M	N	FLOW DIA. D
169C-2-1	1/8	1/16	5/16-24	.81	.60	.67	.095
269C-2-2	1/8	1/8	5/16-24	.80	.60	.67	.094
169C-3-1	3/16	1/16	3/8-24	.85	.61	.67	.126
169C-3-2	3/16	1/8	3/8-24	.84	.61	.69	.125
269C-3-2	3/16	1/8	3/8-24	.84	.60	.67	.125
169C-3-4	3/16	1/4	3/8-24	.86	.64	.93	.125
169C-4-2	1/4	1/8	7/16-24	.86	.61	.74	.188
269C-4-2	1/4	1/8	7/16-24	.84	.60	.73	.188
169C-4-4	1/4	1/4	7/16-24	.86	.62	.94	.188
269C-4-4	1/4	1/4	7/16-24	.84	.60	.79	.188
169C-4-6	1/4	3/8	7/16-24	.93	.68	1.00	.188
169C-5-2*	5/16	1/8	1/2-24	.88	.61	.74	.234
269C-5-2*	5/16	1/8	1/2-24	.86	.60	.73	.250
169C-5-4	5/16	1/4	1/2-24	.95	.71	.93	.250
269C-5-4	5/16	1/4	1/2-24	.93	.67	.82	.250
169C-5-6	5/16	3/8	1/2-24	1.01	.75	1.00	.250
169C-6-2*	3/8	1/8	9/16-24	1.03	.74	.74	.234
269C-6-2*	3/8	1/8	9/16-24	.97	.69	.75	.220
169C-6-4	3/8	1/4	9/16-24	1.03	.74	.93	.312
269C-6-4	3/8	1/4	9/16-24	1.01	.73	.92	.312
169C-6-6	3/8	3/8	9/16-24	1.03	.75	1.00	.312
269C-6-6	3/8	3/8	9/16-24	1.12	.84	.97	.312
169C-6-8	3/8	1/2	9/16-24	1.22	.94	1.27	.312
269C-7-6	7/16	3/8	5/8-24	1.16	.82	.98	.312
169C-8-4*	1/2	1/4	11/16-20	1.34	.94	1.00	.312
169C-8-6	1/2	3/8	11/16-20	1.34	.93	1.11	.406
169C-8-8	1/2	1/2	11/16-20	1.48	1.00	1.37	.406
169C-10-8	5/8	1/2	13/16-18	1.48	1.06	1.31	.500
169C-12-8	3/4	1/2	1-18	1.64	1.18	1.49	.562
169C-12-12	3/4	3/4	1-18	1.70	1.27	1.58	.562

* For these parts the pipe thread through hole is smaller than the through hole on the flare end.

WARNING: These products can expose you to chemicals including LEAD which is known to the state of California to cause cancer.

[Click here for CADs, Product Specifications or to Configure Parts Online](#)

Female Elbow 170C-270C

REF. SAE 060203 BA

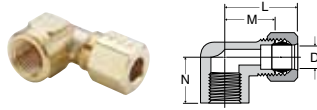

PART NO.	TUBE SIZE	PIPE THREAD	STRAIGHT THREAD	L	M	N	FLOW DIA. D
170C-2-2	1/8	1/8	5/16-24	.89	.69	.56	.094
170C-3-2	3/16	1/8	3/8-24	.98	.69	.56	.125
170C-4-2	1/4	1/8	7/16-24	.93	.69	.56	.188
270C-4-2	1/4	1/8	7/16-24	.91	.67	.54	.188
170C-4-4	1/4	1/4	7/16-24	1.02	.78	.67	.188
170C-6-4	3/8	1/4	9/16-24	1.06	.79	.73	.312
170C-6-6	3/8	3/8	9/16-24	1.22	.89	.69	.312
170C-7-4	7/16	1/4	5/8-24	1.27	.93	.73	.312
170C-8-6	1/2	3/8	11/16-20	1.34	1.00	.69	.406
170C-8-8	1/2	1/2	11/16-20	1.56	1.15	.97	.408
170C-12-12	3/4	3/4	1-18	2.06	1.58	1.58	.563

Adapter Tee 176C

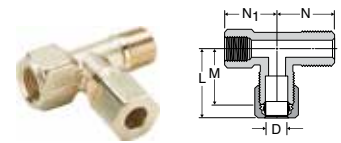

PART NO.	TUBE SIZE	PIPE THREAD	STRAIGHT THREAD	L	M	N	N1	FLOW DIA. D
176C-4-2	1/4	1/8	7/16-24	.93	.69	.75	.66	.188

Female Branch Tee 177C

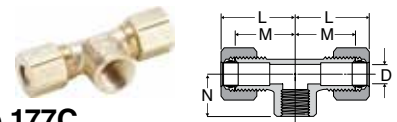

PART NO.	TUBE SIZE	PIPE THREAD	STRAIGHT THREAD	L	M	N	FLOW DIA. D
177C-4-2	1/4	1/8	7/16-24	.86	.63	.53	.188

45° Elbow 179C

Compression to male pipe

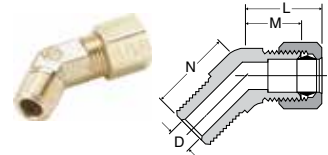

PART NO.	TUBE SIZE	PIPE THREAD	STRAIGHT THREAD	L	M	N	FLOW DIA. D
179C-4-2	1/4	1/8	7/16-24	.90	.66	.56	.188
179C-4-4	1/4	1/4	7/16-24	.80	.56	.84	.188
179C-6-2	3/8	1/8	9/16-24	.90	.63	.65	.234
179C-6-4	3/8	1/4	9/16-24	.90	.63	.84	.312
179C-6-6	3/8	3/8	9/16-24	.97	.75	.95	.312
179C-8-6	1/2	3/8	11/16-20	1.15	.81	.95	.406

Male Run Tee 171C

REF. SAE 060424 BA

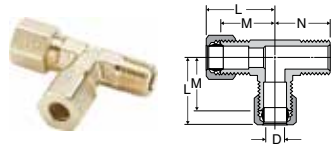

PART NO.	TUBE SIZE	PIPE THREAD	STRAIGHT THREAD	L	M	N	FLOW DIA. D
171C-2-2	1/8	1/8	5/16-24	.82	.61	.67	.094
171C-3-2	3/16	1/8	3/8-24	.86	.61	.67	.125
171C-4-2	1/4	1/8	7/16-24	.90	.64	.75	.188
171C-4-4	1/4	1/4	7/16-24	.93	.69	.92	.188
171C-6-4	3/8	1/4	9/16-24	1.09	.81	1.03	.312

Seal Plug 639C

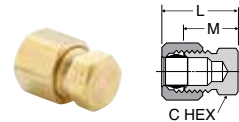

PART NO.	TUBE SIZE	STRAIGHT THREAD	C HEX	L	M
639C-4	1/4	7/16-24	7/16	.74	.50

Male Branch Tee 172C

REF. SAE 060425 BA

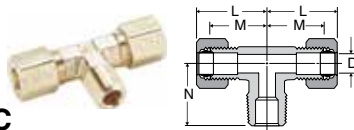

PART NO.	TUBE SIZE	PIPE THREAD	STRAIGHT THREAD	L	M	N	FLOW DIA. D
172C-2-2	1/8	1/8	5/16-24	.82	.61	.67	.094
172C-3-2	3/16	1/8	3/8-24	.86	.61	.67	.125
172C-4-2	1/4	1/8	7/16-24	.86	.61	.74	.188
172C-4-4	1/4	1/4	7/16-24	.93	.69	.92	.188
172C-6-2	3/8	1/8	9/16-24	1.03	.75	.75	.234
172C-6-4	3/8	1/4	9/16-24	1.09	.77	.92	.312
172C-6-6	3/8	3/8	9/16-24	1.09	.81	1.00	.312
172C-8-6	1/2	3/8	11/16-20	1.34	.93	1.10	.406

Straight Through Tank Fitting 682C

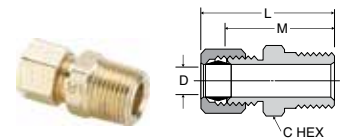

PART NO.	TUBE SIZE	PIPE THREAD	STRAIGHT THREAD	C HEX	L	M	FLOW DIA. D
682C-3-2	3/16	1/8	3/8-24	7/16	1.06	.84	.195
682C-6-6	3/8	3/8	9/16-24	11/16	1.44	1.16	.387
682C-8-8	1/2	1/2	11/16-20	7/8	1.90	1.31	.516

WARNING These products can expose you to chemicals including LEAD which is known to the state of California to cause cancer.



Compress-Align® Fittings

Parker's Compress-Align Fittings are pre-assembled with a captive sleeve, always oriented for a faster installation. The design of the captive sleeve aligns to seal even out-of-round tubing.

Product Features:

- Self-aligning captive sleeve
- 2-piece fitting – Less inventory
- Visible inspection before and after installation
- 1/8" – 1" Sizes
- No flaring, soldering or other tube preparation
- Forged and extruded shapes

Markets:

- Industrial
- Packaging
- Pneumatic
- Printing
- Chemical

Applications:

- Air lines
- Lubrication Lines
- Cooling lines
- Industry
- Machinery
- Chemical Dispensing
- Compressors
- Fluid transfer

Compatible Tubing:

- Copper, Aluminum
- Thermoplastic tubing
- TFE, FEA, PFA

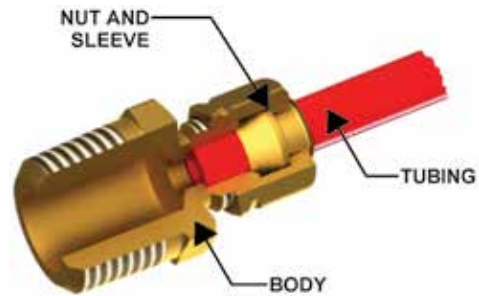

Assembly Instructions

With nut finger tight on fitting body, insert tubing until it bottoms in the Fitting. Complete the seal with one wrench turn for all sizes.



Specifications:

Temperature Range: -65° to +200° F (-53.8° to +93.3° C)

Pressure Range:

TUBE SIZE	PSI	bar	TUBE SIZE	PSI	bar
1/8	2800	193.0	1/2	750	51.7
3/16	1900	131.0	5/8	650	44.8
1/4	1400	96.5	3/4	550	37.9
5/16	1200	82.7	7/8	450	31.0
3/8	1000	68.9	1	350	24.1

WARNING These products can expose you to chemicals including LEAD which is known to the state of California to cause cancer.

[Click here for CADs, Product Specifications or to Configure Parts Online](#)

Plug 59CA

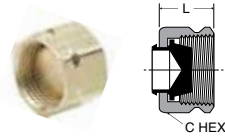

PART NO.	TUBE SIZE	STRAIGHT THREAD	C HEX	L
59CA-4	1/4	7/16-24	1/2	.40
59CA-6	3/8	9/16-24	5/8	.45
59CA-8	1/2	11/16-20	13/16	.50

Nut and Sleeve Assembly 61CA

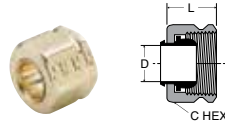

PART NO.	TUBE SIZE	STRAIGHT THREAD	C HEX	D	L
61CA-2	1/8	5/16-24	3/8	.130	.36
61CA-3	3/16	3/8-24	7/16	.194	.38
61CA-4	1/4	7/16-24	1/2	.255	.40
61CA-5	5/16	1/2-24	9/16	.318	.45
61CA-6	3/8	9/16-24	5/8	.382	.45
61CA-8	1/2	11/16-20	13/16	.507	.50
61CA-10	5/8	13/16-18	15/16	.632	.53
61CA-12	3/4	1-18	1-3/16	.760	.56
61CA-14	7/8	1-1/8-18	1-3/8	.885	.68
61CA-16	1	1-1/4-18	1-1/2	1.012	.63

Union 62CA

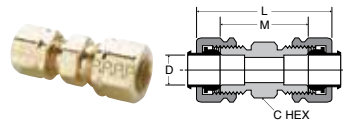

PART NO.	SIZE	STRAIGHT THREAD	C HEX	L	M	FLOW DIA. D
62CA-2	1/8	5/16-24	5/16	1.12	.64	.094
62CA-3	3/16	3/8-24	3/8	1.19	.72	.125
62CA-4	1/4	7/16-24	7/16	1.26	.79	.188
62CA-5	5/16	1/2-24	1/2	1.32	.85	.250
62CA-6	3/8	9/16-24	9/16	1.42	.97	.312
62CA-8	1/2	11/16-20	11/16	1.53	1.08	.406
62CA-10	5/8	13/16-18	13/16	1.71	1.23	.500
62CA-12	3/4	1-18	1	2.20	1.41	.562
62CA-14	7/8	1-1/8-18	1-1/8	2.08	1.19	.766

Union Reducers 62CA

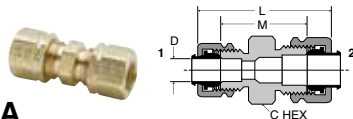

PART NO.	1 TUBE SIZE	2 TUBE SIZE	1 STRAIGHT THREAD	2 STRAIGHT THREAD	C HEX	L	M	FLOW DIA. D
62CA-4-3	3/16	1/4	3/8-24	7/16-24	7/16	1.25	.78	.125
62CA-6-4	1/4	3/8	7/16-24	9/16-24	9/16	1.37	.91	.188
62CA-8-6	3/8	1/2	9/16-24	11/16-20	11/16	1.48	1.03	.312
62CA-10-6	3/8	5/8	9/16-24	13/16-18	13/16	1.59	1.13	.312

Bulkhead Union 62CABH

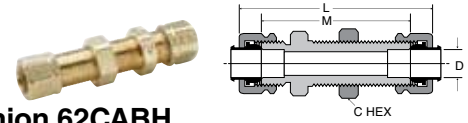

PART NO.	TUBE SIZE	STRAIGHT THREAD	C HEX	L	M	BULKHEAD HOLE DIA.	FLOW DIA. D
62CABH-4	1/4	7/16-24	9/16	2.22	1.75	7/16	.188
62CABH-6	3/8	9/16-24	11/16	2.32	1.88	9/16	.312

Union 62PCA

(Poly-Tite to Compress-Align)

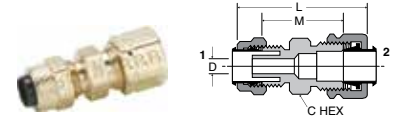

PART NO.	TUBE SIZE	1 STRAIGHT THREAD	2 STRAIGHT THREAD	C HEX	L	M	FLOW DIA. D
62PCA-4	1/4	3/8-24	7/16-24	7/16	1.24	.89	.125
62PCA-5	5/16	7/16-24	1/2-24	1/2	1.26	.92	.144
62PCA-6	3/8	1/2-24	9/16-24	9/16	1.32	.98	.204

Bulkhead Union 62PCABH

(Poly-Tite to Compress-Align)

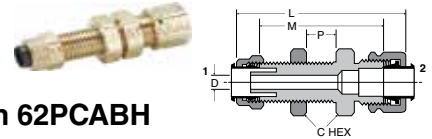

PART NO.	TUBE SIZE	1 STR THD	2 STR THD	C HEX	P MAX	L	M	FLOW BKHD DIA.	FLOW DIA. D
62PCABH-4	1/4	3/8-24	7/16-24	9/16	.38	1.80	1.45	3/8	.125
62PCABH-6	3/8	1/2-24	9/16-24	11/16	.47	1.98	1.64	1/2	.204

Brass Insert 63PT

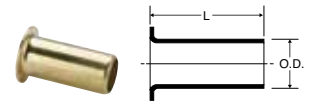

PART NO.	TUBE SIZE	TUBE WALL	L	O.D.
63PT-2-16	1/8	.016	.46	.080
63PT-2-23	1/8	.023	.45	.073
63PT-3-25	3/16	.025	.45	.135
63PT-3-40	3/16	.040	.52	.095
63NTA-4*	1/4		.53	.163
63PT-4-62	1/4	.062	.33	.110
63PT-5-40	5/16	.040	.50	.232
63PT-5-62	5/16	.062	.53	.187
63NTA-6*	3/8		.64	.245
63NTA-8*	1/2		.81	.370
63PT-10-62	5/8	.062	.72	.483

* Denotes 304 stainless steel

⚠ WARNING These products can expose you to chemicals including LEAD which is known to the state of California to cause cancer.

[Click here for CADs, Product Specifications or to Configure Parts Online](#)

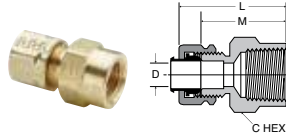

Female Connector 66CA

PART NO.	TUBE SIZE	PIPE THREAD	STRAIGHT THREAD	C HEX	L	M	FLOW DIA. D
66CA-2-2	1/8	1/8	5/16-24	9/16	.99	.75	.094
66CA-3-2	3/16	1/8	3/8-24	9/16	1.01	.78	.125
66CA-3-4	3/16	1/4	3/8-24	11/16	1.19	.96	.125
66CA-4-2	1/4	1/8	7/16-24	9/16	1.02	.78	.188
66CA-4-4	1/4	1/4	7/16-24	11/16	1.24	1.00	.188
66CA-5-2	5/16	1/8	1/2-24	9/16	1.05	.81	.250
66CA-5-4	5/16	1/4	1/2-24	11/16	1.27	1.03	.250
66CA-6-2	3/8	1/8	9/16-24	9/16	1.00	.78	.312
66CA-6-4	3/8	1/4	9/16-24	11/16	1.28	1.06	.312
66CA-6-6	3/8	3/8	9/16-24	13/16	1.29	1.06	.312
66CA-6-8	3/8	1/2	9/16-24	1	1.49	1.27	.312
66CA-8-4	1/2	1/4	11/16-20	11/16	1.32	1.09	.406
66CA-8-6	1/2	3/8	11/16-20	13/16	1.35	1.12	.406
66CA-8-8	1/2	1/2	11/16-20	1	1.54	1.31	.406
66CA-10-8	5/8	1/2	13/16-18	1	1.62	1.38	.500

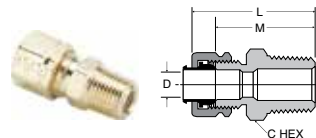

Male Connector 68CA

PART NO.	TUBE SIZE	PIPE THREAD	STRAIGHT THREAD	C HEX	L	M	FLOW DIA. D
68CA-2-1	1/8	1/16	5/16-24	3/8	1.02	.78	.095
68CA-2-2	1/8	1/8	5/16-24	7/16	1.01	.77	.094
68CA-3-1	3/16	1/16	3/8-24	3/8	1.07	.84	.125
68CA-3-2	3/16	1/8	3/8-24	7/16	1.07	.84	.125
68CA-3-4	3/16	1/4	3/8-24	9/16	1.26	1.03	.125
68CA-4-2	1/4	1/8	7/16-24	7/16	1.10	.86	.188
68CA-4-4	1/4	1/4	7/16-24	9/16	1.31	1.06	.188
68CA-4-6	1/4	3/8	7/16-24	11/16	1.28	1.03	.188
68CA-4-8	1/4	1/2	7/16-24	7/8	1.56	1.31	.188
68CA-5-2	5/16	1/8	1/2-24	1/2	1.13	.89	.234
68CA-5-4	5/16	1/4	1/2-24	9/16	1.35	1.07	.250
68CA-6-2	3/8	1/8	9/16-24	9/16	1.19	.97	.250
68CA-6-4	3/8	1/4	9/16-24	9/16	1.36	1.14	.312
68CA-6-6	3/8	3/8	9/16-24	11/16	1.43	1.16	.312
68CA-6-8	3/8	1/2	9/16-24	7/8	1.52	1.25	.312
68CA-8-4	1/2	1/4	11/16-20	11/16	1.45	1.22	.312
68CA-8-6	1/2	3/8	11/16-20	11/16	1.43	1.20	.406
68CA-8-8	1/2	1/2	11/16-20	7/8	1.54	1.31	.406
68CA-10-6	5/8	3/8	13/16-18	13/16	1.55	1.31	.406
68CA-10-8	5/8	1/2	13/16-18	7/8	1.72	1.48	.500
68CA-10-12	5/8	3/4	13/16-18	1-1/16	1.80	1.56	.500
68CA-12-8	3/4	1/2	1-18	1	1.99	1.60	.562
68CA-12-12	3/4	3/4	1-18	1-1/16	2.02	1.63	.656
68CA-14-12	7/8	3/4	1-1/8-18	1-1/8	1.85	1.41	.750
68CA-16-12	1	3/4	1-1/4-18	1-1/4	1.83	1.39	.750
68CA-16-16	1	1	1-1/4-18	1-3/8	2.02	1.58	.875

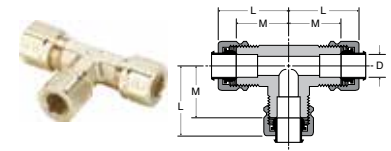

Union Tee 164CA-264CA

PART NO.	TUBE SIZE	STRAIGHT THREAD	L	M	FLOW DIA. D
164CA-2	1/8	5/16-24	.84	.61	.093
264CA-3	3/16	3/8-24	.83	.60	.125
164CA-4	1/4	7/16-24	.84	.63	.188
264CA-4	1/4	7/16-24	.84	.60	.188
164CA-5	5/16	1/2-24	.95	.71	.250
164CA-6	3/8	9/16-24	.96	.74	.312
164CA-8	1/2	11/16-20	1.15	.93	.406
164CA-10	5/8	13/16-18	1.32	1.08	.500
164CA-12	3/4	1.00-18	1.56	1.17	.562

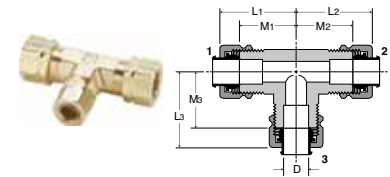

Union Tee 164CA combination sizes

PART NO.	1 TUBE SIZE	2 TUBE SIZE	3 TUBE SIZE	L1	L2	L3	M1	M2	M3	FLOW DIA. D
164CA-6-4-4	3/8	1/4	1/4	.97	.96	.96	.75	.72	.72	.188
164CA-6-6-4	3/8	3/8	1/4	.97	.97	.96	.75	.75	.72	.188
164CA-8-8-6	1/2	1/2	3/8	1.17	1.17	1.10	.94	.94	.88	.312

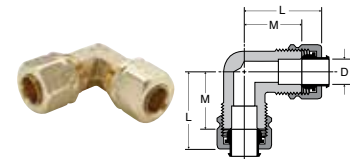

Union Elbow 165CA-265CA

PART NO.	TUBE SIZE	STRAIGHT THREAD	L	M	FLOW DIA. D
165CA-2	1/8	5/16-24	.84	.61	.094
165CA-3	3/16	3/8-24	.84	.61	.125
165CA-4	1/4	7/16-24	.84	.61	.188
265CA-4	1/4	7/16-24	.84	.60	.188
165CA-5	5/16	1/2-24	.94	.71	.250
165CA-6	3/8	9/16-24	.96	.74	.312
165CA-8	1/2	11/16-20	1.15	.93	.406
165CA-10	5/8	13/16-18	1.29	1.05	.500
165CA-12	3/4	1-18	1.56	1.17	.562
165CA-16	1	1-1/4-18	1.63	1.19	.877

WARNING These products can expose you to chemicals including LEAD which is known to the state of California to cause cancer.

[Click here for CADs, Product Specifications or to Configure Parts Online](#)

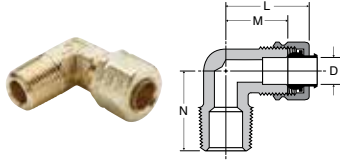

**Male Elbow
169CA-269CA**

PART NO.	TUBE SIZE	PIPE THREAD	STRAIGHT THREAD	L	M	N	FLOW DIA. D
169CA-2-1	1/8	1/16	5/16-24	.84	.60	.67	.095
269CA-2-2	1/8	1/8	5/16-24	.84	.60	.67	.094
169CA-3-1	3/16	1/16	3/8-24	.84	.61	.67	.126
169CA-3-2	3/16	1/8	3/8-24	.84	.61	.69	.125
269CA-3-2	3/16	1/8	3/8-24	.83	.60	.67	.125
169CA-3-4	3/16	1/4	3/8-24	.87	.64	.93	.125
169CA-4-2	1/4	1/8	7/16-24	.84	.61	.74	.188
269CA-4-2	1/4	1/8	7/16-24	.84	.60	.73	.188
169CA-4-4	1/4	1/4	7/16-24	.86	.62	.94	.188
269CA-4-4	1/4	1/4	7/16-24	.84	.60	.79	.188
169CA-4-6	1/4	3/8	7/16-24	.92	.68	1.00	.188
169CA-5-2 *	5/16	1/8	1/2-24	.84	.61	.74	.234
269CA-5-2 *	5/16	1/8	1/2-24	.84	.60	.73	.250
169CA-5-4	5/16	1/4	1/2-24	.94	.71	.93	.250
269CA-5-4	5/16	1/4	1/2-24	.91	.67	.82	.250
169CA-5-6	5/16	3/8	1/2-24	.99	.75	1.00	.250
169CA-6-2 *	3/8	1/8	9/16-24	.96	.74	.74	.234
269CA-6-2 *	3/8	1/8	9/16-24	.96	.69	.75	.220
169CA-6-4	3/8	1/4	9/16-24	.96	.74	.93	.312
269CA-6-4	3/8	1/4	9/16-24	.95	.73	.92	.312
169CA-6-6	3/8	3/8	9/16-24	.97	.75	1.00	.312
269CA-6-6	3/8	3/8	9/16-24	1.06	.84	.97	.312
169CA-6-8	3/8	1/2	9/16-24	1.16	.94	1.27	.312
169CA-8-4 *	1/2	1/4	11/16-20	1.17	.94	1.00	.312
169CA-8-6	1/2	3/8	11/16-20	1.15	.93	1.11	.406
169CA-8-8	1/2	1/2	11/16-20	1.23	1.00	1.37	.406
169CA-10-6 *	5/8	3/8	13/16-18	1.30	1.06	1.15	.406
169CA-10-8	5/8	1/2	13/16-18	1.30	1.06	1.31	.500
169CA-12-8	3/4	1/2	1-18	1.57	1.18	1.49	.562
169CA-12-12	3/4	3/4	1-18	1.66	1.27	1.58	.562
169CA-16-12 *	1	3/4	1-1/4-18	1.63	1.19	1.60	.875

* For these parts the pipe thread through hole is smaller than the through hole on the tube end.

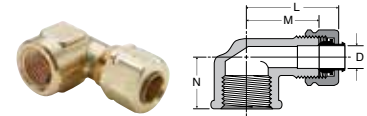

**Female Elbow
170CA-270CA**

PART NO.	TUBE SIZE	PIPE THREAD	STRAIGHT THREAD	L	M	N	FLOW DIA. D
170CA-2-2	1/8	1/8	5/16-24	.93	.69	.56	.094
170CA-3-2	3/16	1/8	3/8-24	.98	.69	.56	.125
170CA-4-2	1/4	1/8	7/16-24	.98	.69	.56	.188
270CA-4-2	1/4	1/8	7/16-24	.91	.67	.54	.188
170CA-4-4	1/4	1/4	7/16-24	1.02	.78	.67	.188
170CA-6-4	3/8	1/4	9/16-24	1.09	.79	.73	.312
170CA-6-6	3/8	3/8	9/16-24	1.16	.89	.69	.312
170CA-8-6	1/2	3/8	11/16-20	1.23	1.00	.69	.406
170CA-8-8	1/2	1/2	11/16-20	1.38	1.15	.97	.408
170CA-12-12	3/4	3/4	1-18	1.97	1.58	1.58	.563

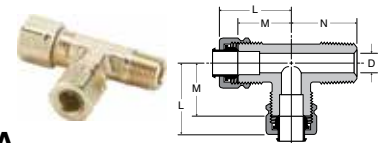

Male Run Tee 171CA

PART NO.	TUBE SIZE	PIPE THREAD	STRAIGHT THREAD	L	M	N	FLOW DIA. D
171CA-2-2	1/8	1/8	5/16-24	.84	.61	.67	.094
171CA-3-2	3/16	1/8	3/8-24	.83	.61	.67	.125
171CA-4-2	1/4	1/8	7/16-24	.88	.64	.75	.188
171CA-4-4	1/4	1/4	7/16-24	.93	.69	.92	.188
171CA-6-4	3/8	1/4	9/16-24	1.03	.81	1.03	.312

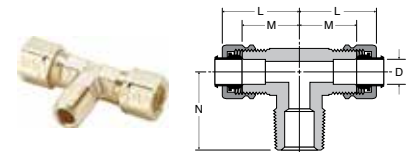

Male Branch Tee 172CA

PART NO.	TUBE SIZE	PIPE THREAD	STRAIGHT THREAD	L	M	N	FLOW DIA. D
172CA-2-2	1/8	1/8	5/16-24	.84	.61	.67	.093
172CA-3-2	3/16	1/8	3/8-24	.83	.61	.67	.125
172CA-4-2	1/4	1/8	7/16-24	.84	.61	.74	.188
172CA-4-4	1/4	1/4	7/16-24	.93	.69	.92	.188
172CA-6-2	3/8	1/8	9/16-24	.97	.75	.75	.234
172CA-6-4	3/8	1/4	9/16-24	.99	.77	.92	.312
172CA-6-6	3/8	3/8	9/16-24	1.07	.81	1.00	.312
172CA-8-6	1/2	3/8	11/16-20	1.15	.93	1.10	.406
172CA-12-12	3/4	3/4	1-18	1.67	1.27	1.50	.562

WARNING These products can expose you to chemicals including LEAD which is known to the state of California to cause cancer.

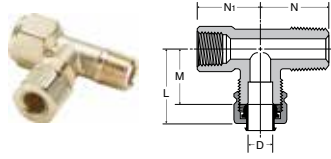

Adapter Tee 176CA

PART NO.	TUBE SIZE	PIPE THREAD	STRAIGHT THREAD	L	M	N	N1	FLOW DIA. D
176CA-4-2	1/4	1/8	7/16-24	.92	.69	.75	.66	.188

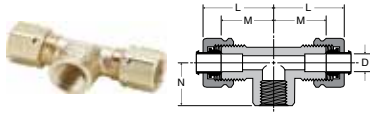

Female Branch Tee 177CA

PART NO.	TUBE SIZE	PIPE THREAD	STRAIGHT THREAD	L	M	N	FLOW DIA. D
177CA-4-2	1/4	1/8	7/16-24	.86	.63	.53	.188

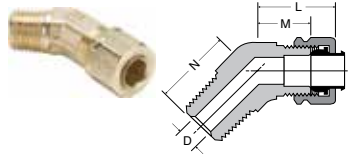

45° Elbow 179CA

PART NO.	TUBE SIZE	PIPE THREAD	STRAIGHT THREAD	L	M	N	FLOW DIA. D
179CA-4-2	1/4	1/8	7/16-24	.89	.66	.56	.188
179CA-4-4	1/4	1/4	7/16-24	.80	.56	.84	.188
179CA-6-2	3/8	1/8	9/16-24	.85	.63	.65	.234
179CA-6-4	3/8	1/4	9/16-24	.85	.63	.84	.312
179CA-6-6	3/8	3/8	9/16-24	.97	.75	.95	.312
179CA-8-6	1/2	3/8	11/16-20	1.03	.81	.95	.406

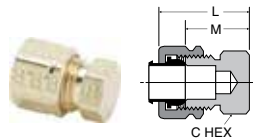

Seal Plug 639CA

PART NO.	TUBE SIZE	STRAIGHT THREAD	C HEX	L	M
639CA-4	1/4	7/16-24	7/16	.74	.50

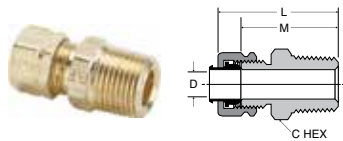

Straight Through Tank Fitting 682CA

PART NO.	TUBE SIZE	PIPE THREAD	STRAIGHT THREAD	C HEX	L	M	FLOW DIA. D
682CA-3-2	3/16	1/8	3/8-24	7/16	1.07	.84	.194

WARNING These products can expose you to chemicals including LEAD which is known to the state of California to cause cancer.

Brass Metric Compression Fittings



Parker's Metric Compression Fittings provide users with an economical choice with numerous connection options for a wide variety of tube materials without the need for flaring, soldering or other tube preparation necessary to assemble.

Product Features:

- 4mm – 28mm tube sizes
- NPT, BSPT, BSPP, Metric Threads
- NBR seal
- Silicone free

Markets:

- Factory/Process Automation
- Automotive Process
- Packaging
- Pneumatic
- Printing

Applications:

- Air lines
- Lubrication Lines
- Cooling lines
- Water
- Machinery
- Compressors
- Fluid transfer

Compatible Tubing:

- Copper
- Aluminum
- Thermoplastic tubing

Specifications:

Temperature Range: -40° to +250° F (-40° to +121.1° C)

Pressure Range:

TUBE SIZE MM	PSI	bar	TUBE SIZE MM	PSI	bar
4	3335	229.9	14	652	44.9
6	2175	149.9	16	580	39.9
8	1450	99.9	18	536	36.9
10	1087	74.9	20	507	34.9
12	797	54.9	22	435	29.9

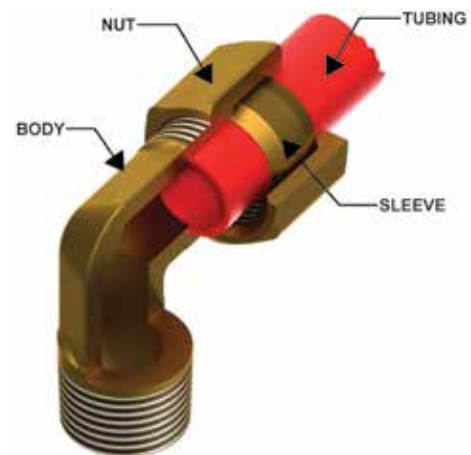

⚠️ WARNING These products can expose you to chemicals including LEAD which is known to the state of California to cause cancer.

[Click here for CADs, Product Specifications or to Configure Parts Online](#)

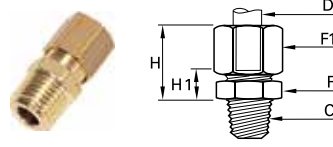

0105 Male Connector BSPT

PART NO.	OD	C	F	F1	H MAX	H1	KG
0105 04 10	4	R1/8	10	10	17	7	.012
0105 05 10	5	R1/8	11	12	17.5	7.5	.016
0105 05 13	5	R1/4	14	12	17.5	7.5	.022
0105 06 10	6	R1/8	11	13	18	7.5	.017
0105 06 13	6	R1/4	14	13	18	7.5	.024
0105 06 17	6	R3/8	17	13	18	8.5	.031
0105 08 10	8	R1/8	13	14	19.5	7	.020
0105 08 13	8	R1/4	14	14	19.5	7	.025
0105 08 17	8	R3/8	17	14	20.5	8	.032
0105 10 10	10	R1/8	17	19	24	9	.043
0105 10 13	10	R1/4	17	19	24	9	.047
0105 10 17	10	R3/8	17	19	24	9	.048
0105 10 21	10	R1/2	22	19	25	10	.067
0105 12 13	12	R1/4	19	22	24	9	.059
0105 12 17	12	R3/8	19	22	24	9	.060
0105 12 21	12	R1/2	22	22	25	10	.076
0105 14 13	14	R1/4	22	24	25	8	.068
0105 14 17	14	R3/8	22	24	25	8	.068
0105 14 21	14	R1/2	22	24	26	9	.080
0105 14 27	14	R3/4	27	24	27	10	.107
0105 15 17	15	R3/8	22	24	25	8	.065
0105 15 21	15	R1/2	22	24	26	9	.076
0105 16 13	16	R1/4	24	27	27	9.5	.092
0105 16 17	16	R3/8	24	27	27	9.5	.092
0105 16 21	16	R1/2	24	27	27	9.5	.099
0105 16 27	16	R3/4	27	27	28	10.5	.123
0105 18 21	18	R1/2	27	30	30	10.5	.127
0105 18 27	18	R3/4	27	30	30	10.5	.138
0105 20 21	20	R1/2	30	32	32	11	.148
0105 20 27	20	R3/4	30	32	32	11	.157
0105 22 21	22	R1/2	32	36	33	11	.187
0105 22 27	22	R3/4	32	36	33	11	.196
0105 22 34	22	R1	36	36	33	11	.227
0105 25 27	25	R3/4	36	41	36	11	.261
0105 25 34	25	R1	36	41	36	11	.278
0105 28 27	28	R3/4	41	42	36	11	.274
0105 28 34	28	R1	41	42	36	11	.283

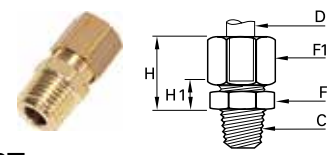

0105 Male Connector NPT

PART NO.	OD	C	F	F1	H MAX	H1	KG
0105 06 11	6	NPT1/8	11	13	18	7.5	.018
0105 06 14	6	NPT1/4	14	13	18	7.5	.027
0105 08 11	8	NPT1/8	13	14	21	7	.021
0105 08 14	8	NPT1/4	14	14	18.5	7	.026
0105 10 14	10	NPT1/4	17	19	24	9	.048
0105 10 18	10	NPT3/8	17	19	24	9	.048
0105 10 22	10	NPT1/2	22	19	25	10	.066

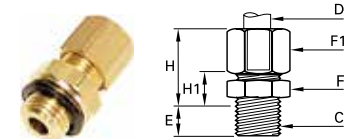

0101 Male Connector with Captive Sealing Washer Male BSWP

PART NO.	OD	C	E	F	F1	H MAX	H1	KG
0101 04 19	4	M5X0.8	5	10	10	16.5	8	.011
0101 04 10	4	G1/8	6.5	13	10	16.5	8	.016
0101 05 10	5	G1/8	6.5	13	12	17.5	8.5	.018
0101 06 10	6	G1/8	6.5	13	13	18	8.5	.020
0101 06 13	6	G1/4	8	17	13	18	9.5	.030
0101 08 10	8	G1/8	6.5	13	14	19	8.5	.021
0101 08 13	8	G1/4	8	17	14	19.5	9	.032
0101 08 17	8	G3/8	11	22	14	20	10.5	.044
0101 10 13	10	G1/4	8	17	19	24	11	.049
0101 10 17	10	G3/8	11	22	19	24	11.5	.061
0101 12 13	12	G1/4	8	19	22	24	11	.062
0101 12 17	12	G3/8	11	22	22	24	11.5	.069
0101 12 21	12	G1/2	12	27	22	24	12	.089
0101 14 17	14	G3/8	11	22	24	25	10.5	.074
0101 14 21	14	G1/2	12	27	24	25	11	.094
0101 15 17	15	G3/8	11	22	24	25	10.5	.071
0101 15 21	15	G1/2	12	27	24	25	11	.093
0101 16 17	16	G3/8	11	22	27	27	12	.092
0101 16 21	16	G1/2	12	27	27	27	12.5	.109
0101 18 21	18	G1/2	12	27	30	29.5	12.5	.128
0101 18 27	18	G3/4	13	32	30	29.5	13	.152
0101 20 27	20	G3/4	13	32	32	31	13	.164
0101 22 27	22	G3/4	13	32	36	32	13	.195
0101 22 34	22	G1	15	41	36	31	13.5	.259
0101 25 27	25	G3/4	13	36	41	35.5	13	.261
0101 25 34	25	G1	15	41	41	35.5	13	.169
0101 28 34	28	G1	15	41	42	35.5	13.5	.300

With pre-assembled captive polymer sealing washer

WARNING These products can expose you to chemicals including LEAD which is known to the state of California to cause cancer.

[Click here for CADs, Product Specifications or to Configure Parts Online](#)

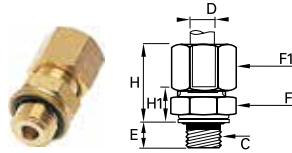

0101 Male Connector with Bi-Material Seal Male BSPP

PART NO.	OD	C	E	F	F1	H MAX	H1	KG
0101 04 10 39	4	G1/8	5.5	13	10	17.5	9	.016
0101 05 10 39	5	G1/8	5.5	13	12	18.5	9.5	.019
0101 06 10 39	6	G1/8	5.5	13	13	19	9.5	.020
0101 06 13 39	6	G1/4	7	17	13	19	10.5	.030
0101 08 10 39	8	G1/8	5.5	13	14	20	9.5	.022
0101 08 13 39	8	G1/4	7	17	14	20.5	10	.032
0101 08 17 39	8	G3/8	9.5	22	14	21.5	12	.045
0101 10 13 39	10	G1/4	7	17	19	25	12	.048
0101 10 17 39	10	G3/8	9.5	22	19	25.5	13	.062
0101 12 13 39	12	G1/4	7	19	22	25	12	.063
0101 12 17 39	12	G3/8	9.5	22	22	25	13	.071
0101 12 21 39	12	G1/2	10.5	27	22	25	13.5	.091
0101 14 17 39	14	G3/8	9.5	22	24	26.5	12	.075
0101 14 21 39	14	G1/2	10.5	27	24	26.5	12.5	.095
0101 15 17 39	15	G3/8	9.5	22	24	26.5	12	.073
0101 15 21 39	15	G1/2	10.5	27	24	26.5	12.5	.095
0101 16 17 39	16	G3/8	9.5	22	27	28.5	13.5	.092
0101 16 21 39	16	G1/2	10.5	27	27	28.5	14	.111
0101 18 21 39	18	G1/2	10.5	27	30	31	14	.129
0101 18 27 39	18	G3/4	11.5	32	30	31	14.5	.155
0101 20 27 39	20	G3/4	11.5	32	32	32.5	14.5	.164
0101 22 27 39	22	G3/4	11.5	32	36	32.5	14.5	.197
0101 22 34 39	22	G1	13	41	36	33	15.5	.259
0101 25 34 39	25	G1	13	41	41	37.5	15.5	.309
0101 28 34 39	28	G1	13	41	42	37.5	15.5	.301

Zinc plated steel with NBR seal

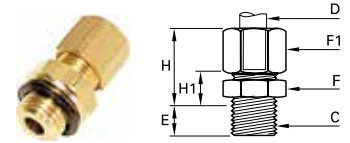

0101 Male Connector Metric Thread

PART NO.	OD	C	E	F	F1	H MAX	H1	KG
0101 04 55	4	M7X1	6.5	10	10	16.5	7.5	.012
0101 04 56	4	M8X1	6.5	11	10	16.5	7.5	.013
0101 05 56	5	M8X1	6.5	11	12	17.5	8	.016
0101 05 60	5	M10X1	6.5	14	12	17.5	8.5	.020
0101 06 60	6	M10X1	6.5	14	13	18	8.5	.021
0101 06 62	6	M10X1.5	6.5	14	13	18	8.5	.021
0101 08 65	8	M12X1	8	17	14	19.5	9	.029
0101 08 66	8	M12X1.25	8	17	14	19.5	9	.029
0101 08 68	8	M13X1.25	8	17	14	19.5	9	.030
0101 10 70	10	M14X1.25	8	17	19	24	11	.047
0101 10 71	10	M14X1.5	8	17	19	24	11	.047
0101 10 74	10	M16X1.25	9	19	19	24	11	.051
0101 10 75	10	M16X1.5	9	19	19	24	11	.051
0101 10 78	10	M18X1.5	9	22	19	24	11.5	.060
0101 12 74	12	M16X1.25	9	19	22	24	11	.061
0101 12 75	12	M16X1.5	9	19	22	24	11	.061
0101 12 78	12	M18X1.5	9	22	22	24	11.5	.070
0101 14 78	14	M18X1.5	9	22	24	25	10.5	.077
0101 14 80	14	M20X1.5	10	24	24	25	11	.084
0101 15 78	15	M18X1.5	9	22	24	25	10.5	.071
0101 16 80	16	M20X1.5	10	24	27	27	12.5	.102
0101 16 82	16	M22X1.5	10	27	27	27	12.5	.111
0101 18 82	18	M22X1.5	10	27	30	29.5	12.5	.129
0101 18 83	18	M24X1.5	11	30	30	29.5	13	.142

WARNING These products can expose you to chemicals including LEAD which is known to the state of California to cause cancer.

[Click here for CADs, Product Specifications or to Configure Parts Online](#)

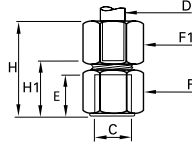

0114 Female Connector BSPP

PART NO.	OD	C	E	F	F1	H MAX	H1	KG
0114 04 10	4	G1/8	9.5	14	10	26	16.5	.020
0114 04 13	4	G1/4	13.5	17	10	30	20.5	.030
0114 05 10	5	G1/8	9.5	14	12	28	17	.023
0114 05 13	5	G1/4	13.5	17	12	31	21	.033
0114 06 10	6	G1/8	9.5	14	13	28	17	.025
0114 06 13	6	G1/4	13.5	17	13	32	21	.034
0114 06 17	6	G3/8	14	22	13	32	21.5	.051
0114 08 10	8	G1/8	9.5	14	14	29	16.5	.026
0114 08 13	8	G1/4	13.5	17	14	33	20.5	.036
0114 08 17	8	G3/8	14	22	14	34	21	.052
0114 10 13	10	G1/4	13.5	17	19	37	21.5	.052
0114 10 17	10	G3/8	14	22	19	37	22	.068
0114 10 21	10	G1/2	18.5	27	19	42	26.5	.099
0114 12 13	12	G1/4	13.5	19	22	36	20.5	.069
0114 12 17	12	G3/8	14	22	22	37	22	.078
0114 12 21	12	G1/2	18.5	27	22	42	26.5	.109
0114 14 13	14	G1/4	13.5	22	24	36	18.5	.085
0114 14 17	14	G3/8	14	22	24	38	21	.048
0114 14 21	14	G1/2	18.5	27	24	43	25.5	.113
0114 15 17	15	G3/8	14	22	24	38	21	.078
0114 15 21	15	G1/2	18.5	27	24	43	25.5	.109
0114 16 13	16	G1/4	13.5	24	27	36	18	.107
0114 16 17	16	G3/8	14	24	27	38	20.5	.106
0114 16 21	16	G1/2	18.5	27	27	44	26	.127
0114 18 17	18	G3/8	14	27	30	39	19.5	.140
0114 18 21	18	G1/2	18.5	27	30	45	26	.144
0114 18 27	18	G3/4	19.5	32	30	46	27	.165
0114 20 17	20	G3/8	14	30	32	38	18	.161
0114 20 21	20	G1/2	18.5	30	32	44.5	24	.173
0114 20 27	20	G3/4	19.5	32	32	47	26.5	.170
0114 22 27	22	G3/4	19.5	32	36	48	26.5	.204
0114 25 27	25	G3/4	19.5	36	41	50.5	26	.297

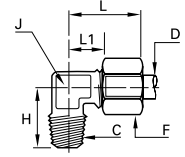

0109 Male Elbow BSPT

PART NO.	OD	C	F	H	J	L MAX	L1	KG
0109 04 10	4	R1/8	10	17	8	19	9.5	.016
0109 04 13	4	R1/4	10	20	10	19	11	.026
0109 05 10	5	R1/8	12	17.5	8	21	11	.019
0109 05 13	5	R1/4	12	21.5	10	22	12	.028
0109 06 10	6	R1/8	13	18	8	22	11	.021
0109 06 13	6	R1/4	13	21.5	10	22	12	.031
0109 08 10	8	R1/8	14	18.5	10	28	15	.028
0109 08 13	8	R1/4	14	22	10	28	15	.033
0109 08 17	8	R3/8	14	24	12	28	15	.044
0109 10 13	10	R1/4	19	25	12	30	14.5	.052
0109 10 17	10	R3/8	19	25.5	12	30	14.5	.060
0109 10 21	10	R1/2	19	32	19	36	21	.109
0109 12 13	12	R1/4	22	26	15	30	15	.074
0109 12 17	12	R3/8	22	27	15	30	15	.077
0109 12 21	12	R1/2	22	32	19	36	21	.116
0109 14 17	14	R3/8	24	30	19	35	18	.105
0109 14 21	14	R1/2	24	32	19	35	18	.112
0109 15 17	15	R3/8	24	30	19	35	18	.099
0109 15 21	15	R1/2	24	32	19	35	18	.106
0109 16 17	16	R3/8	27	30	19	39	21	.120
0109 16 21	16	R1/2	27	33.5	19	39	21	.130
0109 16 27	16	R3/4	27	36.5	23	41	23	.189
0109 18 21	18	R1/2	30	35.5	23	41	21.5	.182
0109 18 27	18	R3/4	30	36.5	23	41	21.5	.199
0109 20 21	20	R1/2	32	36.5	23	42	21.5	.181
0109 20 27	20	R3/4	32	38	23	42	21.5	.200
0109 22 27	22	R3/4	36	40	27	50	30	.288
0109 22 34	22	R1	36	44	27	50	30	.342
0109 25 34	25	R1	41	44	27	54	30	.367
0109 28 34	28	R1	42	48	32	54	30	.384

WARNING These products can expose you to chemicals including LEAD which is known to the state of California to cause cancer.

[Click here for CADs, Product Specifications or to Configure Parts Online](#)

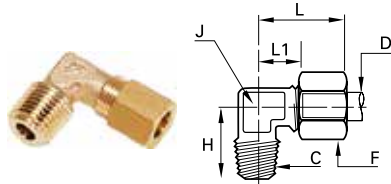

0109 Male Elbow NPT

PART NO.	OD	C	F	H	J	L MAX	L1	KG
0109 06 11	6	1/8	13	18	8	22	11	.021
0109 06 14	6	1/4	13	21.5	10	22	12	.030
0109 08 11	8	1/8	14	18.5	10	28	15	.028
0109 08 14	8	1/4	14	22	10	28	15	.033
0109 10 14	10	1/4	19	25	12	30	14.5	.053

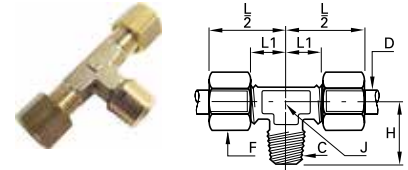

0108 Male Branch Tee Male BSPT

PART NO.	OD	C	F	H	J	L1	L2	KG
0108 04 10	4	R1/8	10	17	8	9.5	19	.025
0108 05 10	5	R1/8	12	17.5	8	11	21	.017
0108 06 10	6	R1/8	13	18	8	11	22	.032
0108 06 13	6	R1/4	13	21.5	10	16	27	.047
0108 08 10	8	R1/8	14	18.5	10	15	28	.045
0108 08 13	8	R1/4	14	22	10	15	28	.050
0108 08 17	8	R3/8	14	24	12	15	28	.061
0108 10 13	10	R1/4	19	25	12	14.5	30	.084
0108 10 17	10	R3/8	19	25.5	12	14.5	30	.090
0108 12 13	12	R1/4	22	26	15	15	30	.116
0108 12 17	12	R3/8	22	27	15	15	30	.117
0108 14 17	14	R3/8	24	30	19	18	35	.153
0108 14 21	14	R1/2	24	32	19	18	35	.168
0108 16 17	16	R3/8	27	30	19	21	39	.190
0108 16 21	16	R1/2	27	33.5	19	21	39	.203
0108 18 21	18	R1/2	30	35.5	23	21.5	41	.265
0108 18 27	18	R3/4	30	36.5	23	21.5	41	.292
0108 20 27	20	R3/4	32	38	23	21.5	42	.298
0108 22 27	22	R3/4	36	40	27	29	50	.435
0108 22 34	22	R1	36	44	27	29	50	.466

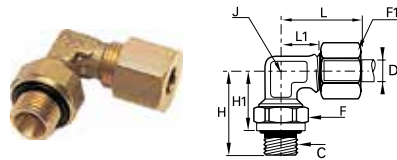

0199 Adjustable Male Elbow BSPP

PART NO.	OD	C	F	F1	H	H1	H1 MAX	J	L MAX	L1	KG
0199 04 10	4	G1/8	14	10	23	16	17	8	19	9.5	.023
0199 04 13	4	G1/4	19	10	30.5	22	23.5	10	19	11	.043
0199 06 10	6	G1/8	14	13	23	16	17	8	22	11	.027
0199 06 13	6	G1/4	19	13	30.5	22	23.5	10	22	12	.047
0199 08 10	8	G1/8	14	14	24	17	18	10	28	15	.033
0199 08 13	8	G1/4	19	14	30.5	22	23.5	10	28	15	.051
0199 08 17	8	G3/8	22	14	33.5	24	25.5	12	28	15	.065
0199 10 13	10	G1/4	19	19	31	22.5	24	12	30	14.5	.068
0199 10 17	10	G3/8	22	19	33.5	24	25.5	12	30	14.5	.079
0199 10 21	10	G1/2	27	19	40	29.5	31	19	37	22	.138
0199 14 17	14	G3/8	22	24	35.5	26	27.5	19	35	18	.119
0199 14 21	14	G1/2	27	24	40	29.5	31	19	35	18	.141
0199 18 21	18	G1/2	27	30	40	29	30.5	23	41	21.5	.187
0199 18 27	18	G3/4	32	30	43.5	32	33.5	23	41	21.5	.222
0199 22 27	22	G3/4	32	36	45.5	34	36	32	51	31	.382
0199 22 34	22	G1	41	36	54	40.5	43	32	51	31	.408
0199 28 34	28	G1	41	42	54	40.5	43	32	54	30	.420

The body will orientate for positioning purposes

WARNING These products can expose you to chemicals including LEAD which is known to the state of California to cause cancer.

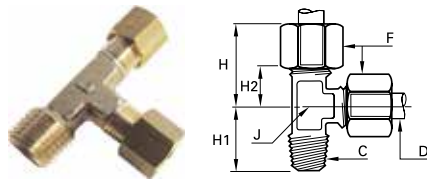

0103 Male Run Tee BSPT

PART NO.	OD	C	F	H MAX	H1	H2	J	KG
0103 04 10	4	R1/8	10	19	17	9.5	8	.025
0103 06 10	6	R1/8	13	22	18	11	8	.033
0103 06 13	6	R1/4	13	27	21.5	16	10	.048
0103 08 13	8	R1/4	14	28	22	15	10	.050
0103 08 17	8	R3/8	14	28	24	15	12	.061
0103 10 13	10	R1/4	19	30	25	14.5	12	.084
0103 12 13	12	R1/4	22	30	26	15	15	.114
0103 14 17	14	R3/8	24	35	30	18	19	.161
0103 14 21	14	R1/2	24	35	32	18	19	.169
0103 15 17	15	R3/8	24	35	30	18	19	.148
0103 15 21	15	R1/2	24	35	32	18	19	.158
0103 16 17	16	R3/8	27	39	30	21	19	.192
0103 18 21	18	R1/2	30	41	35.5	21.5	23	.269
0103 18 27	18	R3/4	30	41	36.5	21.5	23	.282
0103 20 27	20	R3/4	32	42	38	21.5	23	.298
0103 22 27	22	R3/4	36	50	40	29	27	.435
0108 22 34	22	R1	36	44	27	29	50	.466

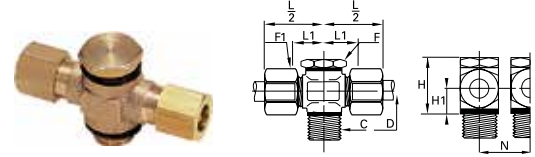

0119 Double Banjo with Captive Sealing Washer Male BSPP

PART NO.	OD	C	F	F1	H	H1	L1	L2	N	KG
0119 06 10	6	G1/8	14	13	24	9.5	14.5	25	17.5	.056
0119 08 13	8	G1/4	17	14	25	10	15.5	28	21	.074
0119 08 17	8	G3/8	22	14	32	13	18	30.5	26.5	.140
0119 10 13	10	G1/4	17	19	31	13	19	34	23	.156
0119 10 17	10	G3/8	22	19	32	13	19	34	26.5	.165
0119 12 13	12	G1/4	17	22	34	14.5	19	34	23	.180
0119 12 17	12	G3/8	22	22	35	14.5	19	34	26.5	.182
0119 14 13	14	G1/4	17	24	37	16	20.5	37.5	28	.246
0119 14 17	14	G3/8	22	24	38	16	20.5	37.5	28	.247
0119 14 21	14	G1/2	27	24	40	16	20.5	38	32.5	.219

Zinc plated steel with NBR seal. Thread with pre-assembled polymer washer

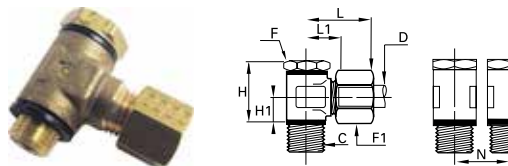

0118 Single Banjo with Captive Sealing Washer Male BSPP

PART NO.	OD	C	F	F1	H	H1	L1 MAX	L1	N	KG
0118 05 10	5	G1/8	14	12	24	9.5	25	14.5	17.5	.041
0118 05 13	5	G1/4	17	12	25	10	26	16	21	.058
0118 14 13	14	G1/4	17	24	37	16	37	20.5	28	.154
0118 14 17	14	G3/8	22	24	38	16	37	20.5	28	.195
0118 14 21	14	G1/2	27	24	40	16	38	20.5	32.5	.208
0118 15 17	15	G3/8	22	24	38	16	37	20.5	28	.190
0118 15 21	15	G1/2	27	24	40	16	38	20.5	32.5	.198
0118 16 21	16	G1/2	27	27	42	16	38	21	32.5	.221
0118 18 21	18	G1/2	27	30	46	19.5	43	24.5	36	.366
0118 20 27	20	G3/4	32	32	49	20	44	24.5	39	.403
0118 22 27	22	G3/4	32	36	53	22	45	24.5	39	.459

With pre-assembled captive polymer sealing washer

WARNING These products can expose you to chemicals including LEAD which is known to the state of California to cause cancer.

[Click here for CADs, Product Specifications or to Configure Parts Online](#)

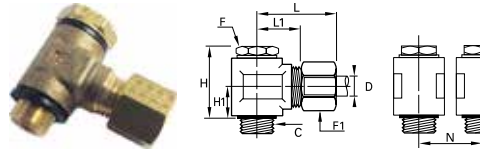

0118 Single Banjo with Bi-Material Seal Male BSPP

PART NO.	OD	C	F	F1	H	H1	L1 MAX	L1	N	KG
0118 04 10 39	4	G1/8	14	10	23	9.5	24	14.5	17.5	.038
0118 05 10 39	5	G1/8	14	12	23	9.5	25	14.5	17.5	.041
0118 05 13 39	5	G1/4	17	12	24	10	26	16	21	.064
0118 06 10 39	6	G1/8	14	13	23	9.5	25	14.5	17.5	.042
0118 06 13 39	6	G1/4	17	13	24	10	26	16	21	.057
0118 08 10 39	8	G1/8	14	14	23	9.5	28	15.5	17.5	.055
0118 08 13 39	8	G1/4	17	14	24	10	28	15.5	21	.058
0118 08 17 39	8	G3/8	22	14	31.5	13.5	30	18	26.5	.113
0118 10 13 39	10	G1/4	17	19	30	13	34	19	23	.118
0118 10 17 39	10	G3/8	22	19	31.5	13.5	34	19	26.5	.128
0118 12 13 39	12	G1/4	17	22	33	14.5	34	19	23	.128
0118 12 17 39	12	G3/8	22	22	34.5	15	34	19	26.5	.140
0118 14 13 39	14	G1/4	17	24	36	16	37	20.5	28	.189
0118 14 17 39	14	G3/8	22	24	37.5	16.5	37	20.5	28	.198
0118 14 21 39	14	G1/2	27	24	39	16.5	38	20.5	32.5	.205
0118 15 17 39	15	G3/8	22	24	37.5	16.5	37	20.5	28	.389
0118 15 21 39	15	G1/2	27	24	40	16.5	38	20.5	32.5	.202
0118 16 21 39	16	G1/2	27	27	40	16.5	38	21	32.5	.225
0118 18 21 39	18	G1/2	27	30	47	20	43	24.5	36	.369
0118 20 27 39	20	G3/4	32	32	50	20.5	44	24.5	39	.394
0118 22 27 39	22	G3/4	32	36	54	22.5	45	24.5	39	.462

Zinc plated steel with NBR seal

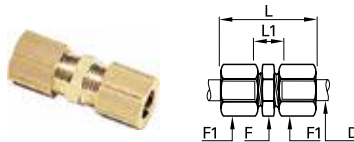

0106 Equal Tube-to-Tube Connector

PART NO.	OD	F	F1	L MAX	L1	KG
0106 04 00	4	10	10	28	10	.016
0106 05 00	5	11	12	31	11	.023
0106 06 00	6	11	13	32	11	.026
0106 08 00	8	13	14	36	10	.031
0106 10 00	10	17	19	42	13	.070
0106 12 00	12	19	22	42	13	.092
0106 14 00	14	22	24	45	11	.104
0106 15 00	15	22	24	45	11	.097
0106 16 00	16	24	27	48	13	.141
0106 18 00	18	27	30	53	14	.186
0106 20 00	20	30	32	56	14	.211
0106 22 00	22	32	36	60	14	.283
0106 25 00	25	36	41	64	14	.396
0106 28 00	28	41	42	64	14	.399

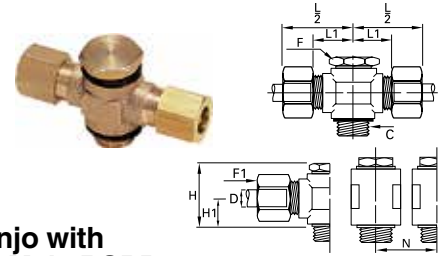

0119 Double Banjo with Bi-Material Seal Male BSPP

PART NO.	OD	C	F	F1	H	H1	L1	L2	N	KG
0119 04 10 39	4	G1/8	14	10	23	9.5	14.5	24	17.5	.050
0119 05 10 39	5	G1/8	14	12	23	9.5	14.5	25	17.5	.049
0119 05 13 39	5	G1/4	17	12	24	10	126	26	21	.072
0119 06 10 39	6	G1/8	14	13	23	9.5	14.5	25	17.5	.056
0119 06 13 39	6	G1/4	17	13	24	10	16	26	21	.071
0119 08 10 39	8	G1/8	14	14	23	9.5	15.5	28	17.5	.072
0119 08 13 39	8	G1/4	17	14	24	10	15.5	28	21	.080
0119 08 17 39	8	G3/8	22	14	31.5	13.5	18	30	26.5	.118
0119 10 13 39	10	G1/4	17	19	30	13	19	34	23	.156
0119 10 17 39	10	G3/8	22	19	31.5	13.5	19	34	26.5	.167
0119 12 13 39	12	G1/4	17	22	33	14.5	19	34	23	.180
0119 12 17 39	12	G3/8	22	22	34.5	15	19	34	26.5	.183
0119 14 13 39	14	G1/4	17	24	36	16	20.5	37	28	.248
0119 14 17 39	14	G3/8	22	24	37.5	16.5	20.5	37	28	.247
0119 14 21 39	14	G1/2	27	24	39	16.5	20.5	38	32.5	.262
0119 15 17 39	15	G3/8	22	24	37.5	16.5	20.5	37	28	.246
0119 15 21 39	15	G1/2	27	24	40	16.5	20.5	38	32.5	.251
0119 18 21 39	18	G1/2	27	30	47	20	24.5	43	36	.469
0119 20 27 39	20	G3/4	32	32	50	20.5	24.5	44	39	.638
0119 22 27 39	22	G3/4	32	36	54	22.5	24.5	45	39	.610

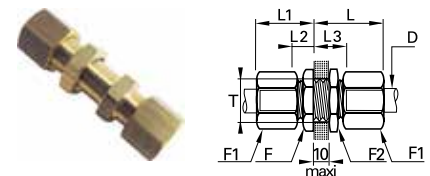

0116 Bulkhead Union

PART NO.	OD	F	F1	F2	L MAX	L1 MAX	L2	L3	OT MIN	KG
0116 04 00	4	10	10	13	27	17	7	17	8.3	.024
0116 05 00	5	13	12	14	28	18	7.5	17.5	10.3	.035
0116 06 00	6	13	13	14	28	19	7.5	17.5	10.3	.037
0116 08 00	8	14	14	17	29	20	7	17	12.3	.045
0116 10 00	10	19	19	22	33	25	9	19	16.5	.101
0116 12 00	12	22	22	22	33	25	9	19	18.5	.121
0116 14 00	14	24	24	24	35	25	8	18	20.5	.145
0116 15 00	15	24	24	24	35	25	8	18	20.5	.134
0116 16 00	16	27	27	27	36	28	9.5	19.5	22.5	.189
0116 18 00	18	27	30	30	40	30	10.5	20.5	24.5	.237
0116 20 00	20	32	30	32	41	31	11	21	27.5	.274
0116 22 00	22	36	36	36	42	32	11	21	30.5	.372
0116 25 00	25	36	41	38	46	36	11	21	33.5	.469

WARNING These products can expose you to chemicals including LEAD which is known to the state of California to cause cancer.

[Click here for CADs, Product Specifications or to Configure Parts Online](#)

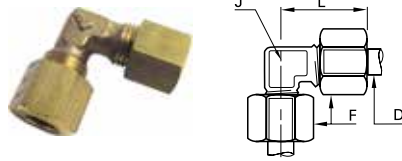

0102 Union Elbow

PART NO.	OD	F	J	L MAX	KG
0102 04 00	4	10	5	19	.016
0102 05 00	5	12	8	21	.024
0102 06 00	6	13	8	22	.027
0102 08 00	8	14	10	28	.038
0102 10 00	10	19	12	30	.073
0102 12 00	12	22	15	30	.098
0102 14 00	14	24	19	35	.133
0102 15 00	15	24	19	35	.122
0102 16 00	16	27	19	39	.164
0102 18 00	18	30	23	41	.231
0102 20 00	20	32	23	42	.233
0102 22 00	22	36	27	50	.371
0102 25 00	25	41	27	54	.446
0102 28 00	28	42	32	54.5	.478

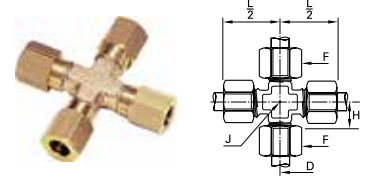

0107 Union Cross

PART NO.	OD	F	H	J	L2	KG
0107 04 00	4	10	9.5	8	19	.035
0107 05 00	5	12	11	8	21	.047
0107 06 00	6	13	11	8	22	.052
0107 08 00	8	14	15	11	28	.073
0107 10 00	10	19	14.5	14	30	.142
0107 12 00	12	22	15	15	35	.096
0107 14 00	14	24	18	20	35	.246
0107 15 00	15	24	18	20	35	.227
0107 16 00	16	27	21	20	39	.312
0107 18 00	18	30	21.5	25	41	.426
0107 20 00	20	32	21.5	25	42	.429
0107 22 00	22	36	29	27	50	.676
0107 25 00	25	41	29	27	50	.819

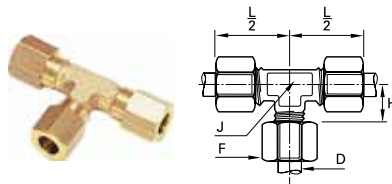

0104 Union Tee

PART NO.	OD	F	H	J	L 2	KG
0104 04 00	4	10	9.5	8	19	.028
0104 05 00	5	12	11	8	21	.036
0104 06 00	6	13	11	8	22	.040
0104 08 00	8	14	15	10	28	.055
0104 10 00	10	19	14.5	12	30	.105
0104 12 00	12	22	15	15	30	.142
0104 14 00	14	24	18	19	35	.190
0104 15 00	15	24	18	19	35	.175
0104 16 00	16	27	21	19	39	.239
0104 18 00	18	30	21.5	23	41	.330
0104 20 00	20	32	21.5	23	42	.330
0104 22 00	22	36	29	27	50	.518
0104 25 00	25	41	29	27	54	.630

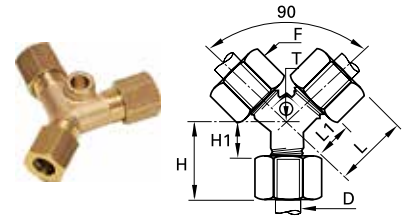

0142 Union Y with Mounting Boss

PART NO.	OD	F	H MAX	H1	L MAX	L1	ØT	KG
0142 04 00	4	10	16.5	7	26.5	17	4.2	.032
0142 06 00	6	13	19.5	8.5	28	17	4.2	.049
0142 08 00	8	14	21	8	30	17	6.2	.061
0142 10 00	10	19	24.5	9	37.5	22	6.2	.128
0142 12 00	12	22	26	11	38	23	6.2	.110
0142 14 00	14	24	28	11	41.5	24.5	6.2	.201
0142 15 00	15	24	28	11	41.5	24.5	6.2	.204
0142 16 00	16	27	30	12	43	25	6.2	.252
0142 18 00	18	30	31.5	12	50.5	31	10.2	.220
0142 25 00	25	41	39	14	59	34	10.2	.728

WARNING These products can expose you to chemicals including LEAD which is known to the state of California to cause cancer.

[Click here for CADs, Product Specifications or to Configure Parts Online](#)

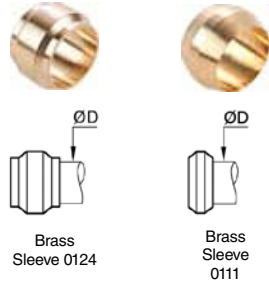

0124 Suffix 40, 0111 Sleeves

OD MM	PART NO.	WT	PART NO.	WT
4	0124 04 40	.001	0111 04 00	.001
5	0124 05 40	.001	0111 05 00	.001
6	0124 06 40	.001	0111 06 00	.001
8	0124 08 40	.002	0111 08 00	.002
10	0124 10 40	.003	0111 10 00	.002
12	0124 12 40	.004	0111 12 00	.003
14	0124 14 40	.004	0111 14 00	.003
15	0124 15 40	.004	0111 15 00	.003
16	0124 16 40	.006	0111 16 00	.004
18	0124 18 40	.007	-	-
20	0124 20 40	.009	-	-
22	0124 22 40	.012	-	-
25	0124 25 40	.017	-	-
28	0124 28 40	.017	-	-

Technical Specifications of Nuts

Tightening Torque

- Maximum kg = tightening torque for nut 0110 and sleeve 0124 on copper, brass or steel tube

OD MM	MAX KG. TORQUE
4	.7
5	.7
6	1.5
8	1.5
10	1.8
12	3
14	3.5
15	4
16	5
18	6
20	6
22	7
25	8
28	9

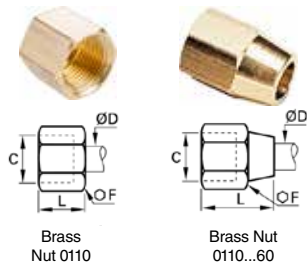

0110, 0110 Suffix 60 Nuts

OD MM	C	PART NO.	WT	PART NO.	WT
4	M8X1	0110 04 00	.005	0110 04 00 60	.006
5	M10X1	0110 05 00	.006	0110 05 00 60	.009
6	M10X1	0110 06 00	.008	0110 06 00 60	.011
8	M12X1	0110 08 00	.008	0110 08 00 60	.012
10	M16X1.5	0110 10 00	.019	0110 10 00 60	.027
12	M18X1.5	0110 12 00	.026	0110 12 00 60	.041
14	M20X1.5	0110 14 00	.029	-	-
15	M20X1.5	0110 15 00	.028	0110 15 00 60	.050
16	M22X1.5	0110 16 00	.043	0110 16 00 60	.072
18	M24X1.5	0110 18 00	.059	-	-
20	M27X1.5	0110 20 00	.057	-	-
22	M30X1.5	0110 22 00	.079	-	-
25	M33X1.5	0110 25 00	.121	-	-
28	M36X1.5	0110 28 00	.109	-	-

⚠ **WARNING** These products can expose you to chemicals including LEAD which is known to the state of California to cause cancer.

Complementary Brass Fittings – Assembly Configuration

The table and information given below illustrate the large number of options available with Parker Legris brass compression fittings. To these must be added the advantages specific to the original Parker Legris reducer shown on the previous page.



0110 BRASS			0110..60 BRASS		0110..40 STEEL	0110..70* POLYMER
	0124 BRASS	0111 BNA** BRAS	0124 BRASS	0111 BNA** BRAS	01 24...40 STEEL	
No olive required to assemble the plug						No olive required to assemble the tube
Brass plug: 0126	Copper, cold-rolled brass, polymer tube and barb connectors 0122 and 0165	Coiled annealed copper tube	Cold-rolled copper tube for vibration and side loading, etc.	Coiled annealed copper tube for vibration and side loading, etc.	Steel or copper tube: low/medium hydraulic pressure, lubricate before assembly	Polymer tube

*Assembly specifications for nut-olive 0110 ..70

This part functions as both olive and nut for flexible polymer tube assemblies:

1. Hand tighten the polymer nut-olive a few turns onto the body of the fitting; the knurling makes this easier.
2. Then introduce the polymer tube and push home into the body of the fitting.
3. Continue manually tightening the polymer nut-olive.
4. Finish tightening using a spanner until the nut body disengages and turns freely, which acts as a torque limiter.

N.B.: To avoid damaging the threads, do not insert the tube before hand tightening the nut-olive into the body of the fitting.

**Bureau de Normalisation de l'Automobile (French Automotive Bureau of Standards)

Recommended Tightening Torque

Tightening torque in daN.m = maximum tightening torque of a 0110 nut and 0124 olive with copper, brass or steel tube.

Nut 0110 and 0110..40

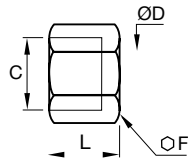

Nut 0110..60

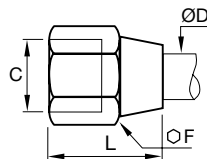

Ø D (MM)	F 0110	F 0110..60	MAX. DAN.M COPPER OR BRASS	F 0110..40	MAX. DAN.M STEEL
4	10	11	.7	10	1.5
5	12	12	.7	12	1.5
6	13	12	1.5	13	2.5
8	14	16	1.5	14	2.5
10	19	20	1.8	19	3
12	22	22	3	22	4.5
14	24	24	3.5	24	5.5
15	24	24	4	24	6
16	27	27	5	27	7
18	30	30	6	30	9
20	32	32	6	32	10
22	36	36	7	36	12
25	41	42	8	41	13
28	42		9		

WARNING These products can expose you to chemicals including LEAD which is known to the state of California to cause cancer.

[Click here for CADs, Product Specifications or to Configure Parts Online](#)

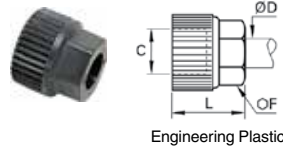

0110 Suffix 70 Nut Sleeve

OD MM	C	PART NO.	F MM	L MM	WT
4	M8X1	0110 04 00 70	8	13	.001
6	M10X1	0110 06 00 70	11	15	.002
8	M12X1	0110 08 00 70	13	16	.002
10	M16X1.5	0110 10 00 70	17	19	.004
12	M18X1.5	0110 12 00 70	19	19	.005
14	M20X1.5	0110 14 00 70	22	20	.007
16	M22X1.5	0110 16 00 70	24	21	.009

Plastic nut-sleeve should not be used on metal tubes.



0168 Reducer Male To Female BSPP

C1 BSPP	C2 BSPP	PART NO.	E MM	F MM	G MM	L MM	WT
G 1/8	M5X.8	0168 10 19 39	8	14	14	4.5	.010
G 1/4	M5X.8	0168 13 19 39	8	17	17	5	.012
G 1/4	G 1/8	0168 13 10 39	8	17	17	5	.020
G 3/8	G 1/8	0168 17 10 39	10	19	22	5	.028
G 3/8	G 1/4	0168 17 13 39	10	19	22	5	.035
G 1/2	G 1/8	0168 21 10 39	12	24	26	7.5	.039
G 1/2	G 1/4	0168 21 13 39	12	24	26	7.5	.056
G 1/2	G 3/8	0168 21 17 39	12	24	26	7.5	.062
G 3/4	G 1/4	0168 27 13 39	12	32	32	9.5	.067
G 3/4	G 3/8	0168 27 17 39	12	32	32	9.5	.097
G 3/4	G 1/2	0168 27 21 39	12	32	32	9.5	.116

0125 End Plug Metric

OD MM	C	PART NO.	F MM	L MM	L1 MM	WT
6	M10X1	0125 06 00	11	13.5	9.5	.009
8	M12X1	0125 08 00	14	14	9	.012
10	M16X1.5	0125 10 00	17	18	11	.025

The plug enables unused tubes to be blanked off. The male thread on the plug has the same pitch as the female thread on the nut of a standard Legris fitting. Therefore, the plug screwed into the nut blanks off the tube.

To reopen the passage, simply unscrew the plug and fit the required connector. No further treatment of the tube is required.

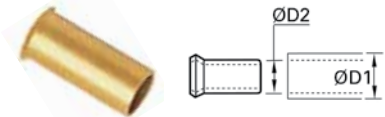
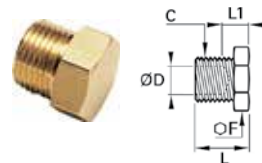

0127 Tube Support for Plastic Tube

OD1 MM	OD2 MM	PART NO.	WT
4	2	0127 04 00	.001
4	2.7	0127 04 27	.001
5	3	0127 05 03	.001
5	3.3	0127 05 00	.001
6	4	0127 06 00	.001
8	5.5	0127 08 55	.001
8	6	0127 08 00	.001
10	7	0127 10 07	.002
10	7.5	0127 10 75	.002
10	8	0127 10 00	.002
12	8	0127 12 08	.002
12	9	0127 12 09	.002
12	10	0127 12 00	.002
14	11	0127 14 11	.003
14	12	0127 14 00	.003
15	12	0127 15 12	.003
16	13	0127 16 13	.003
18	14	0127 18 14	.004
20	15	0127 20 15	.004
22	16	0127 22 16	.005
25	19	0127 25 19	.005

At high temperature and pressure or during oscillating movements, the use of tube supports prevents distortion of the tube and guarantees effective gripping and sealing.

0220 Male Plug BSPP

C BSPP	PART NUMBER	F MM	G MM	H1 MM	WT
G 1/8	0220 10 00 39	14	14	6.5	.005
G 1/4	0220 13 00 39	17	17	6.5	.016
G 3/8	0220 17 00 39	17	22	8	.021
G 1/2	0220 21 00 39	22	26	9	.045
G 3/4	0220 27 00 39	22	32	10	.053
G 1	0220 34 00 39	27	39.5	10.5	.067

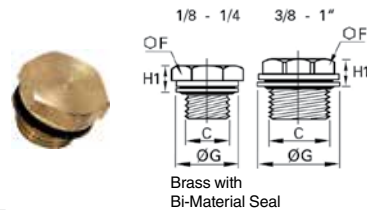

WARNING These products can expose you to chemicals including LEAD which is known to the state of California to cause cancer.



Poly-Tite Fittings

Parker's Poly-Tite Fittings are compact, pre-assembled compression style fittings designed for fast assembly. An exclusive acetal copolymer sleeve has superior resilience to resist creeping and stress caused from compression.

Product Features:

- Self aligning captive sleeve
- Built-in tube support
- Knurled nuts for hand tightening
- Plastic and brass sleeves available
- Chrome plated and stainless steel side latch couplers available

Markets:

- Dental
- Packaging
- Machine Tools
- Car Wash
- Printing

Applications:

- Pneumatic Systems
- Water Lines
- Dental Equipment

Specifications:

Pressure Range Up to 150 PSI (10.3 bar)

Temperature Range 0° to +150° F (-17.7° to +65.5° C)

O-rings Buna N on chrome plated couplers
Fluorocarbon on Stainless
Steel couplers

Compatible Tubing:

- Polyethylene
- Nylon
- Polypropylene
- Vinyl

Assembly Instructions

Polyethylene, polypropylene and vinyl tubing:

1. Cut tubing squarely—maximum of 15° angle allowable.
2. Check that port or mating part is clean and free of debris.
3. Insert tube end until it bottoms in the Poly-Tite fitting and tighten knurl/hex nut finger-tight — plus one wrench turn.

Tube Support O.D.

TUBE SIZE INCHES	* D1 TUBE SUPPORT O.D.
1/4	.168
5/16	.185
3/8	.248
1/2	.373

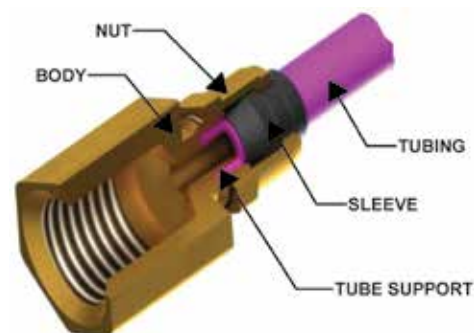
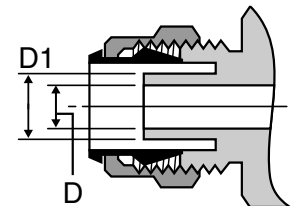

WARNING These products can expose you to chemicals including NICKEL or LEAD, which are known to the state of California to cause cancer and LEAD.

[Click here for CADs, Product Specifications or to Configure Parts Online](#)

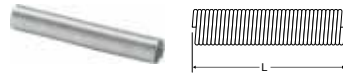

Spring Guard 56PSG

PART NO.	TUBE O.D.	L
56PSG-4	1/4	3.000
56PSG-6	3/8	3.000

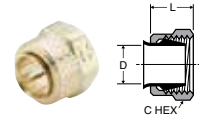

Nut and Brass Sleeve Assembly 61PB

PART NO.	TUBE SIZE	STRAIGHT THREAD	C HEX	D	L
61PB-4	1/4	3/8-24	7/16	.255	.38
61PB-5	5/16	7/16-24	1/2	.318	.34
61PB-6	3/8	1/2-24	9/16	.382	.38
61PB-8	1/2	11/16-20	3/4	.507	.44



Plastic Cap 59P

PART NO.	TUBE SIZE	A	L
59P-4	1/4	.247	.50
59P-6	3/8	.372	.56

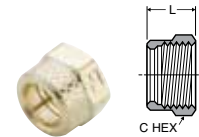

Nut 61PN

PART NO.	TUBE SIZE	STRAIGHT THREAD	C HEX	L
61PN-4	1/4	3/8-24	7/16	.38
61PN-5	5/16	7/16-24	1/2	.34
61PN-6	3/8	1/2-24	9/16	.38
61PN-8	1/2	11/16-20	3/4	.44

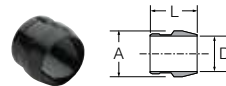

Acetal Plastic Sleeve 60P

PART NO.	TUBE SIZE	A	D	L
60P-4	1/4	.334	.261	.338
60P-5	5/16	.405	.321	.340
60P-6	3/8	.465	.381	.367
60P-8	1/2	.628	.514	.399

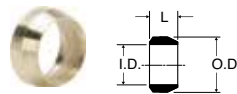

Sleeve 60PB

PART NO.	L	O.D.	I.D.
60PB-4	.187	.336	.255
60PB-5	.187	.400	.318
60PB-6	.218	.460	.382
60PB-8	.250	.620	.507



Nut only for use with Spring Guard 61PSGN

PART NO.	TUBE O.D.	L	C HEX
61PSGN-4	1/4	.625	.437
61PSGN-6	3/8	.656	.562

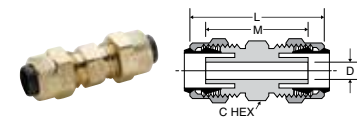

Union 62P

PART NO.	TUBE SIZE	STRAIGHT THREAD	C HEX	L	M	FLOW DIA. D
62P-4	1/4	3/8-24	3/8	1.17	.96	.125
62P-5	5/16	7/16-24	7/16	1.16	.96	.144
62P-6	3/8	1/2-24	1/2	1.23	.99	.204
62P-8	1/2	11/16-20	11/16	1.47	1.24	.323

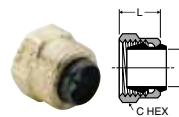

Nut and Plastic Sleeve Assembly 61P

PART NO.	TUBE SIZE	STRAIGHT THREAD	C HEX	D	L
61P-4	1/4	3/8-24	7/16	.261	.38
61P-5	5/16	7/16-24	1/2	.321	.34
61P-6	3/8	1/2-24	9/16	.380	.38
61P-8	1/2	11/16-20	3/4	.514	.44

WARNING These products can expose you to chemicals including NICKEL or LEAD, which are known to the state of California to cause cancer and LEAD.

[Click here for CADs, Product Specifications or to Configure Parts Online](#)

Union Reducer 62P

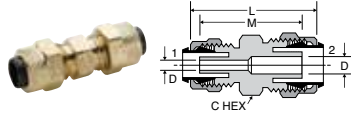

PART NO.	1 TUBE SIZE	2 TUBE SIZE	1 STRAIGHT THREAD	2 STRAIGHT THREAD	C HEX	L	M	FLOW DIA. D
62P-6-4	1/4	3/8	3/8-24	1/2-24	1/2	1.22	.99	.125

Bulkhead Union 62PTBH

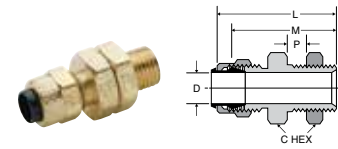

(Straight Through)

PART NO.	TUBE SIZE	STRAIGHT THREAD	C HEX	P MAX.	L	M	BULKHEAD HOLE DIA.	FLOW DIA. D
62PTBH-4	1/4	3/8-24	9/16	.31	1.19	.93	3/8	.260
62PTBH-5	5/16	7/16-24	5/8	.31	1.19	.93	7/16	.323
62PTBH-6	3/8	1/2-24	11/16	.34	1.26	.99	1/2	.387

Bulkhead Union 62PBH

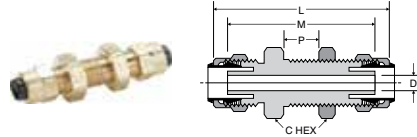

PART NO.	TUBE SIZE	STRAIGHT THREAD	C HEX	P MAX.	L	M	BULKHEAD HOLE DIA.	FLOW DIA. D
62PBH-4	1/4	3/8-24	9/16	.38	1.75	1.53	3/8	.125
62PBH-5	5/16	7/16-24	5/8	.38	1.71	1.52	7/16	.144
62PBH-6	3/8	1/2-24	11/16	.47	1.89	1.65	1/2	.204
62PBH-8	1/2	11/16-20	7/8	.63	2.28	2.05	11/16	.323

Female Connector 66P

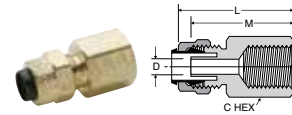

PART NO.	TUBE SIZE	PIPE THREAD	STRAIGHT THREAD	C HEX	L	M	FLOW DIA. D
66P-4-2	1/4	1/8	3/8-24	9/16	.97	.86	.125
66P-4-4	1/4	1/4	3/8-24	5/8	1.18	1.07	.125
66P-5-2	5/16	1/8	7/16-24	9/16	.97	.86	.144
66P-6-4	3/8	1/4	1/2-24	5/8	1.18	1.07	.204
66P-8-6	1/2	3/8	11/16-20	13/16	1.31	1.20	.323

Union 62PCA

(Tube to Compress-Align)

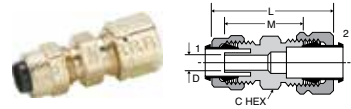

PART NO.	TUBE SIZE	1 STRAIGHT THREAD	2 STRAIGHT THREAD	C HEX	L	M	FLOW DIA. D
62PCA-4	1/4	3/8-24	7/16-24	7/16	1.25	.89	.125
62PCA-5	5/16	7/16-24	1/2-24	1/2	1.30	.92	.144
62PCA-6	3/8	1/2-24	9/16-24	9/16	1.37	.98	.204

Bulkhead Union 62PCABH

(Tube to Compress-Align)

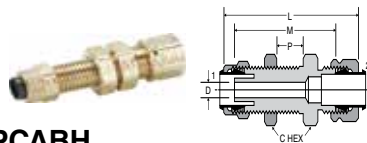

PART NO.	TUBE SIZE	1 STR THD	2 STR THD	C HEX	P MAX	L	M	BLKHD HOLE DIA.	FLOW DIA. D
62PCABH-4	1/4	3/8-24	7/16-24	9/16	.38	1.81	1.45	3/8	.125
62PCABH-6	3/8	1/2-24	9/16-24	11/16	.47	2.03	1.64	1/2	.204

WARNING These products can expose you to chemicals including NICKEL or LEAD, which are known to the state of California to cause cancer and LEAD.

[Click here for CADs, Product Specifications or to Configure Parts Online](#)

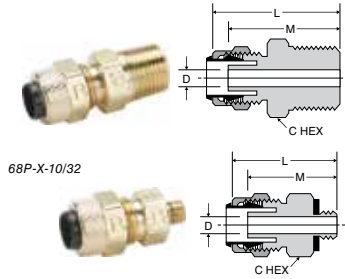

Male Connector 68P

PART NO.	TUBE SIZE	PIPE THREAD	STRAIGHT THREAD	C HEX	L	M	FLOW DIA. D
68P-4-1	1/4	1/16	3/8-24	3/8	1.06	.95	.125
68P-4-10X32	1/4	10-32	3/8-24	3/8	.86	.75	.094
68P-4-2	1/4	1/8	3/8-24	7/16	1.06	.95	.125
68P-4-4	1/4	1/4	3/8-24	9/16	1.25	1.14	.125
68P-4-6	1/4	3/8	3/8-24	11/16	1.28	1.17	.125
68P-5-2	5/16	1/8	7/16-24	7/16	1.05	.95	.144
68P-5-4	5/16	1/4	7/16-24	9/16	1.24	1.14	.144
68P-6-2	3/8	1/8	1/2-24	1/2	1.10	.98	.204
68P-6-4	3/8	1/4	1/2-24	9/16	1.29	1.17	.204
68P-6-6	3/8	3/8	1/2-24	11/16	1.29	1.17	.204
68P-8-4	1/2	1/4	11/16-20	11/16	1.46	1.29	.320
68P-8-6	1/2	3/8	11/16-20	11/16	1.37	1.29	.323

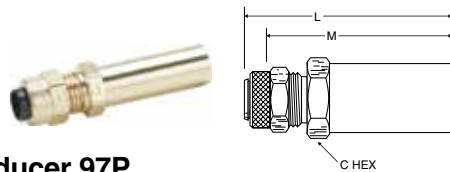

Tube End Reducer 97P

PART NO.	TUBE O.D.	L	M	C HEX
97P-4-6	3/8 X 1/4	1.718	1.625	.437
97P-6-8	1/2 X 3/8	1.875	1.781	.562

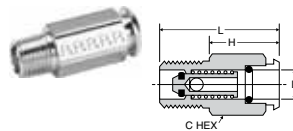

Pipe Coupler Body 391P

(Chrome Plated)

PART NO.	D-INSERT DIA.	PIPE THREAD	C HEX	H	L
391P-4-2	1/4	1/8	1/2	.91	1.29
391P-4-4	1/4	1/4	9/16	.73	1.29
391P-6-4	3/8	1/4	11/16	.85	1.41

Pipe Coupler Body 391PSS

(Stainless Steel)

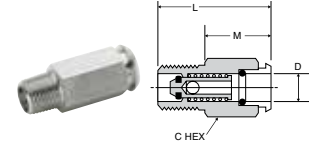

PART NO.	D INSERT DIA.	PIPE THREAD	L	C HEX	M
391PSS-4-2	1/4	1/8	1.271	.500	.900
391PSS-4-4	1/4	1/4	1.271	.562	.710
391PSS-6-4	3/8	1/4	1.40	.625	.840

Bulkhead Coupler Body 392P

(Chrome Plated)

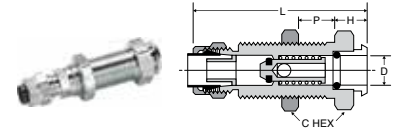

PART NO.	TUBE SIZE	D-INSERT DIA.	STRAIGHT THREAD	C HEX	P MAX.	H	L	BULKHEAD HOLE DIA.
392P-4-4	1/4	1/4	1/2-24	5/8	.84	.39	2.13	1/2
392P-6-6	3/8	3/8	11/16-24	13/16	.93	.37	2.01	11/16

Bulkhead Coupler Body 392PSS

(Stainless Steel)

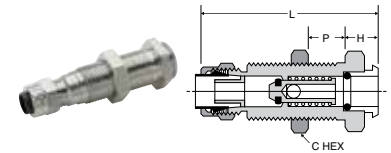

PART NO.	TUBE O.D.	BULKHEAD THREAD	L	C HEX	H	P MAX	BULKHEAD HOLE DIA.
392PSS-4-4	1/4	1/2-24	2.03	.625	.28	.84	1/2
392PSS-6-6	3/8	11/16-24	2.20	.812	.31	.93	11/16

Through Type Insert 393P

(Chrome Plated)

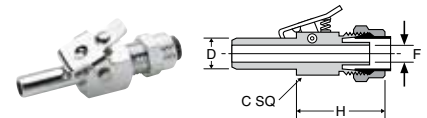

PART NO.	TUBE SIZE	D-INSERT DIA.	STRAIGHT THREAD	C SQUARE	H	FLOW DIA. F
393P-4-4	1/4	1/4	3/8-24	7/16	1.12	.125
393P-6-6	3/8	3/8	1/2-24	1/2	1.34	.203

Through Type Insert 393PSS

(Stainless Steel)

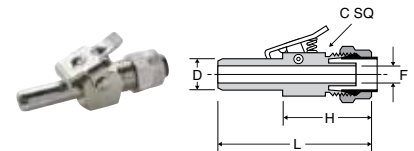

PART NO.	TUBE O.D.	D-INSERT DIA.	L	C SQUARE	H	FLOW DIA. F
393PSS-4-4	1/4	1/4	1.677	7/16	.99	.125
393PSS-6-6	3/8	3/8	2.030	1/2	1.27	.203

WARNING: These products can expose you to chemicals including NICKEL or LEAD, which are known to the state of California to cause cancer and LEAD.

Shutoff Type Insert 393PD

(Chrome Plated)

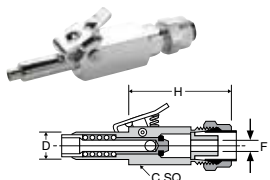

PART NO.	TUBE SIZE	D-INSERT DIA.	STRAIGHT THREAD	C SQUARE	H	FLOW DIA. F
393PD-4-4	1/4	1/4	3/8-24	7/16	1.61	.110
393PD-6-6	3/8	3/8	1/2-24	1/2	1.45	.187

Shut-Off Type Insert 393PDSS

(Stainless Steel)

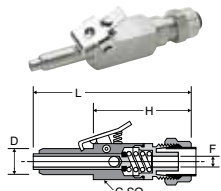

PART NO.	TUBE O.D.	D-INSERT DIA.	L	C SQUARE	H	FLOW DIA. F
393PDSS-4-4	1/4	1/4	2.46	.500	1.62	.116
393PDSS-6-6	3/8	3/8	2.60	.500	1.67	.157

Single End Shutoff Bulkhead Quick Coupler 394P

(Chrome Plated)

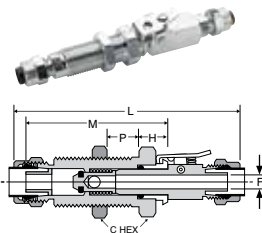

PART NO.	TUBE SIZE	STRAIGHT THREAD	C HEX	P MAX	H	L	M	BULKHEAD HOLE DIA.	FLOW DIA. F
394P-4-4	1/4	1/2-24	5/8	.84	.39	3.28	2.13	1/2	.125
394P-6-6	3/8	11/16-24	13/16	.93	.37	3.41	2.01	11/16	.203

Coupler Single End Shut-Off Bulkhead 394PSS

(Stainless Steel)

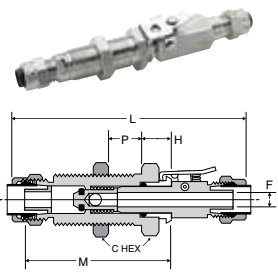

PART NO.	TUBE O.D.	BULKHEAD THREAD	L	M	C HEX	H	P MAX	FLOW DIA. F
394PSS-4-4	1/4	1/2-24	3.05	2.06	.625	.31	.84	.125
394PSS-6-6	3/8	11/16-24	3.50	2.23	.812	.34	.93	.203

Double End Shutoff Bulkhead Quick Coupler 394PD

(Chrome Plated)

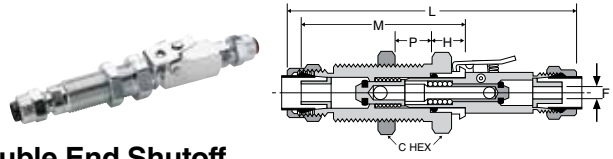

PART NO.	TUBE SIZE	STRAIGHT THREAD	C HEX	P MAX	H	L	M	BULKHEAD HOLE DIA.	FLOW DIA. F
394PD-4-4	1/4	1/2-24	5/8	.84	.39	3.77	2.13	1/2	.125
394PD-6-6	3/8	11/16-24	13/16	.93	.37	3.48	2.01	11/16	.204

Double End Shut-Off Bulkhead Quick Coupler 394PDSS

(Stainless Steel)

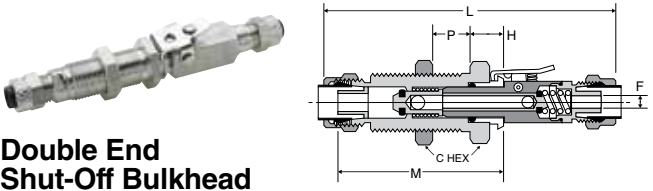

PART NO.	TUBE O.D.	BULKHEAD THREAD	L	M	C HEX	H	P MAX	FLOW DIA. F
394PDSS-4-4	1/4	1/2-24	3.69	2.67	.625	.32	.84	.125
394PDSS-6-6	3/8	11/16-24	3.91	2.24	.812	.34	.93	.203

Single End Shutoff Pipe Connector Quick Coupler 398P

(Chrome Plated)

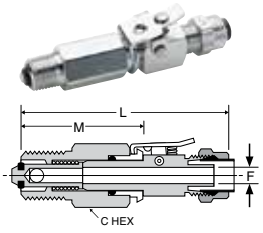

PART NO.	TUBE SIZE	PIPE THREAD	STRAIGHT THREAD	C HEX	L	M	FLOW DIA. F
398P-4-2	1/4	1/8	3/8-24	1/2	2.45	1.32	.125
398P-4-4	1/4	1/4	3/8-24	9/16	2.45	1.32	.125
398P-6-4	3/8	1/4	1/2-24	5/8	2.80	1.46	.203

Single End Shut-Off Connector Quick Coupler 398PSS

(Stainless Steel)

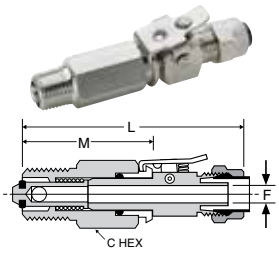

PART NO.	TUBE O.D.	PIPE THREAD	L	M	C HEX	FLOW DIA. F
398PSS-4-2	1/4	1/8	2.30	1.32	.500	.125
398PSS-4-4	1/4	1/4	2.30	1.32	.562	.125
398PSS-6-4	3/8	1/4	2.70	1.43	.625	.203

WARNING: These products can expose you to chemicals including NICKEL or LEAD, which are known to the state of California to cause cancer and LEAD.

[Click here for CADs, Product Specifications or to Configure Parts Online](#)

Double End Shutoff Pipe Connector Quick Coupler 398PD

(Chrome Plated)

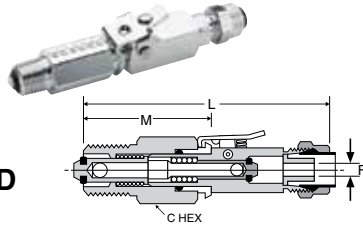

PART NO.	TUBE SIZE	PIPE THREAD	STRAIGHT THREAD	C HEX	L	M	FLOW DIA. F
398PD-4-2	1/4	1/8	3/8-24	1/2	2.93	1.31	.125
398PD-4-4	1/4	1/4	3/8-24	9/16	2.93	1.32	.125
398PD-6-4	3/8	1/4	1/2-24	5/8	2.88	1.43	.204

Double End Shut-Off Pipe Connector Quick Coupler 398PDSS

(Stainless Steel)

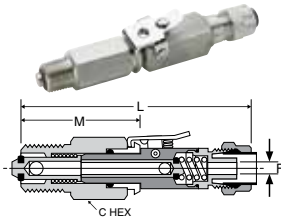

PART NO.	TUBE O. D.	PIPE THREAD	L	M	C HEX	FLOW DIA. D
398PDSS-4-2	1/4	1/8	2.93	1.31	.500	.125
398PDSS-4-4	1/4	1/4	2.93	1.31	.562	.125
398PDSS-6-4	3/8	1/4	3.10	1.43	.625	.125

Male Elbow 169P

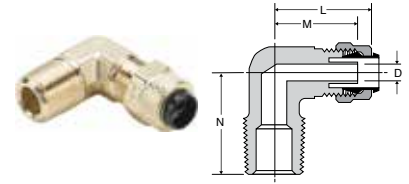

PART NO.	TUBE SIZE	PIPE THREAD	STRAIGHT THREAD	L	M	N	FLOW DIA. D
169P-4-1	1/4	1/16	3/8-24	.92	.58	.67	.130
169P-4-2	1/4	1/8	3/8-24	.84	.73	.75	.121
169P-4-4	1/4	1/4	3/8-24	.90	.79	.92	.125
169P-4-6	1/4	3/8	3/8-24	.93	.84	1.08	.125
169P-5-2	5/16	1/8	7/16-24	.87	.73	.68	.144
169P-6-2	3/8	1/8	1/2-24	.93	.81	.73	.203
169P-6-4	3/8	1/4	1/2-24	.98	.86	1.05	.203
169P-6-6	3/8	3/8	1/2-24	.98	.86	1.08	.203
169P-8-6	1/2	3/8	11/16-20	1.12	1.04	1.13	.323

Long Male Elbow 169LP

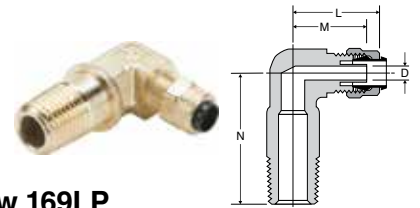

PART NO.	TUBE SIZE	PIPE THREAD	STRAIGHT THREAD	L	M	N	FLOW DIA. D
169LP-4-4	1/4	1/4	3/8-24	.90	.79	1.38	.125

Union Tee 164P

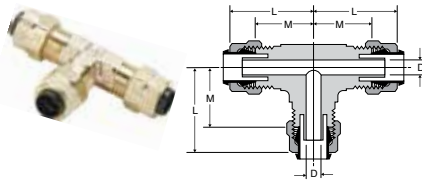

PART NO.	TUBE SIZE	STRAIGHT THREAD	L	M	FLOW DIA. D
164P-4	1/4	3/8-24	.84	.73	.125
164P-5	5/16	7/16-24	.83	.73	.144
164P-6	3/8	1/2-24	.98	.86	.203
164P-8	1/2	11/16-20	1.12	1.04	.323

Union Tee 164P combination size

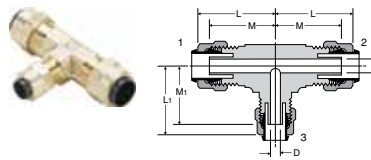

PART NO.	1 TUBE SIZE	2 TUBE SIZE	3 TUBE SIZE	L	L1	M	M1	FLOW DIA. D
164P-6-4	3/8	3/8	1/4	.98	.90	.86	.79	.125

Male Elbow Swivel 169PS

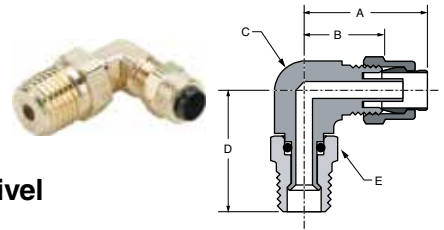

PART NO.	TUBE O. D.	PIPE THREAD	A	B	C HEX	D	E
169PS-4-2	1/4	1/8	.812	.594	.375	.862	.437
169PS-4-4	1/4	1/4	.906	.688	.562	1.218	.562
169PS-6-2	3/8	1/8	.875	.625	.437	.904	.437
169PS-6-4	3/8	1/4	.937	.685	.562	1.218	.562
169PS-6-6	3/8	3/8	.859	.602	.562	1.190	.687
169PS-8-6	1/2	3/8	1.031	.782	.500	1.218	.687

WARNING These products can expose you to chemicals including NICKEL or LEAD, which are known to the state of California to cause cancer, and LEAD.

[Click here for CADs, Product Specifications or to Configure Parts Online](#)

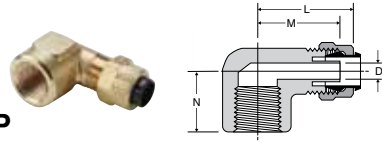

Female Elbow 170P

PART NO.	TUBE SIZE	PIPE THREAD	STRAIGHT THREAD	L	M	N	FLOW DIA. D
170P-4-2	1/4	1/8	3/8-24	.90	.79	.56	.125
170P-4-4	1/4	1/4	3/8-24	1.00	.89	.69	.125
170P-6-4	3/8	1/4	1/2-24	1.01	.89	.69	.204
170P-8-6	1/2	3/8	11/16-20	1.19	1.11	1.13	.323

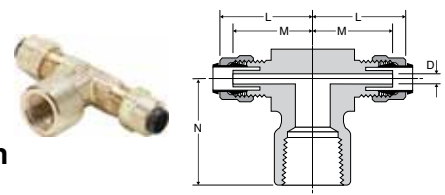

Female Branch Tee 177P

PART NO.	TUBE SIZE	PIPE THREAD	STRAIGHT THREAD	L	M	N	FLOW DIA. D
177P-4-2	1/4	1/8	3/8-24	.92	.81	.88	.125
177P-4-4	1/4	1/4	3/8-24	.92	.81	1.03	.125
177P-4-6	1/4	3/8	3/8-24	1.03	.92	1.13	.125

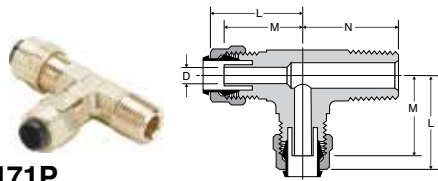

Male Run Tee 171P

PART NO.	TUBE SIZE	PIPE THREAD	STRAIGHT THREAD	L	M	N	FLOW DIA. D
171P-4-2	1/4	1/8	3/8-24	.84	.73	.72	.125
171P-4-4	1/4	1/4	3/8-24	.92	.81	.92	.125
171P-5-2	5/16	1/8	7/16-24	.83	.73	.72	.144
171P-6-4	3/8	1/4	1/2-24	.98	.86	1.03	.203
171P-8-6	1/2	3/8	11/16-20	1.12	1.04	1.13	.323

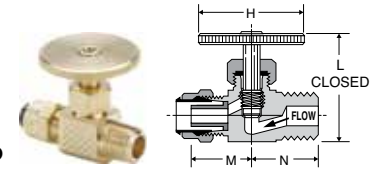

Needle Valve NV311P

PART NO.	TUBE SIZE	PIPE THREAD	H	L OPEN	L CLOSED	M	N
NV311P-4-2	1/4	1/8	1.06	1.36	1.16	.64	.63
NV311P-4-4	1/4	1/4	1.06	1.38	1.18	.64	.72
NV311P-6-4	3/8	1/4	1.06	1.38	1.18	.64	.72

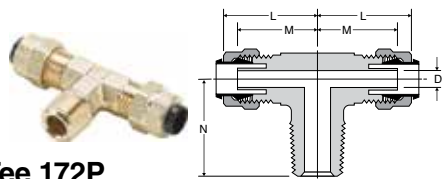

Male Branch Tee 172P

PART NO.	TUBE SIZE	PIPE THREAD	STRAIGHT THREAD	L	M	N	FLOW DIA. D
172P-4-2	1/4	1/8	3/8-24	.84	.73	.72	.125
172P-4-4	1/4	1/4	3/8-24	.92	.81	.92	.125
172P-5-2	5/16	1/8	7/16-24	.83	.73	.72	.144
172P-6-2	3/8	1/8	1/2-24	.88	.86	.74	.204
172P-6-4	3/8	1/4	1/2-24	.98	.86	1.03	.204
172P-8-6	1/2	3/8	11/16-20	1.12	1.04	1.13	.323

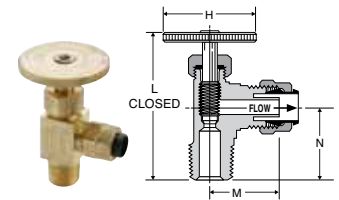

Angle Needle Valve NV312P

PART NO.	TUBE SIZE	PIPE THREAD	H	L OPEN	L CLOSED	M	N
NV312P-4-2	1/4	1/8	1.06	1.70	1.50	.63	.68
NV312P-4-4	1/4	1/4	1.06	2.07	1.82	.71	.86
NV312P-6-4	3/8	1/4	1.06	2.00	1.75	.74	.86

WARNING These products can expose you to chemicals including NICKEL or LEAD, which are known to the state of California to cause cancer and LEAD.



Hi-Duty Flareless Tube Fittings

Parker's Hi-Duty Fittings are preassembled with the sleeve machined onto the nut. During assembly the sleeve breaks away from the nut and creates a seal on the tubing. Rated to a much higher pressure rating than compression fittings, Hi-Duty will work with seamless steel tubing as well as copper, brass and thermoplastic tubing.

Product Features:

- All brass construction
- Two piece fitting
- Higher pressure rating
- Easy assembly

Markets:

- Mobile
- Industrial
- Compressors
- Lubrication

Applications:

- Lubrication Lines
- Coolant Lines
- Oil Lines
- Engines

Compatible Tubing:

- Copper
- Brass
- Seamless Steel
- Thermoplastic Tubing

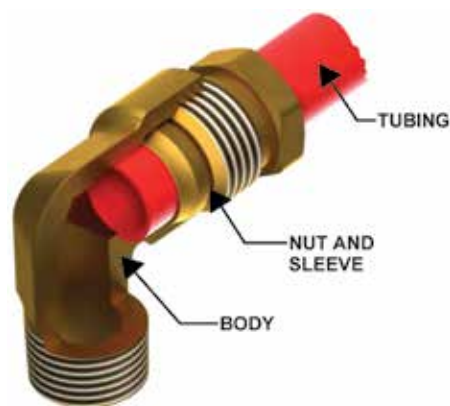

Specifications:

Temperature Range: -65° to +250° F (-53.8° to +121.1° C)

Pressure Range:

TUBE SIZE	PSI	bar	TUBE SIZE	PSI	bar
1/8	4300	296.4	3/8	1500	103.4
3/16	2850	196.5	1/2	1150	79.2
1/4	2100	144.7	5/8	1000	68.9
5/16	1800	124.1			

Assembly Instructions

1. Cut tube squarely and cleanly removing all burrs.
2. Grasp fitting. Do not remove nut.
3. Insert tube in fitting through nut until tube seats firmly against tube shoulder in body.
4. Grip tube firmly to prevent turning and tighten nut to finger-tight. Continue to tighten for one and three-quarter additional turns (one and one-half turns for 1/2" size fittings) for a positive, leak proof seal. During tightening a slight "give" will be felt. This "give" indicates the sleeve has been sheared from the nut. It is not necessary to tighten the nut all the way down.



⚠ WARNING These products can expose you to chemicals including LEAD which is known to the state of California to cause cancer.

[Click here for CADs, Product Specifications or to Configure Parts Online](#)

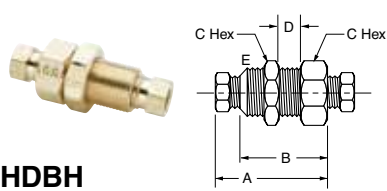

Bulkhead Union 62HDBH

PART NO.	TUBE SIZE	MIN. ORIFICE SIZE	A	B	C	D	E
62HDBH-2	1/8	.093	1.781	1.156	.562	.625	7/16-24
62HDBH-4	1/4	.187	1.968	1.156	.687	.625	9/16-24

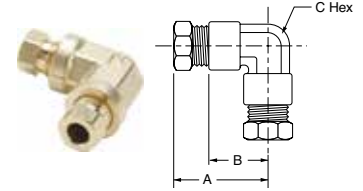

Union Elbow 165HD

PART NO.	TUBE SIZE	MIN. ORIFICE SIZE	A	B	C HEX
165HD-4	1/4	.187	1.084	.690	.552
165HD-6	3/8	.312	1.376	.970	.615
165HD-8	1/2	.437	1.546	1.060	.750

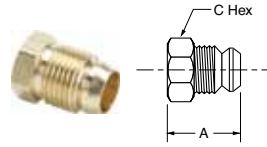

Nut/Sleeve 61HD

PART NO.	TUBE SIZE	PIPE THREAD	A	C
61HD-2	1/8	5/16-24	.656	.312
61HD-3	3/16	3/8-24	.687	.375
61HD-4	1/4	7/16-24	.734	.437
61HD-5	5/16	1/2-20	.765	.500
61HD-6	3/8	9/16-20	.843	.562
61HD-8	1/2	11/16-16	.921	.688
61HD-10	5/8	7/8-18	1.078	.875

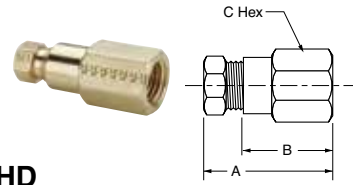

Female Connector 66HD

PART NO.	TUBE SIZE	PIPE THREAD	MIN. ORIFICE SIZE	A	B	C HEX
66HD-2-2	1/8	1/8	.093	1.312	1.000	.500
66HD-4-2	1/4	1/8	.187	1.406	1.000	.562
66HD-4-4	1/4	1/4	.187	1.593	1.187	.687
66HD-6-2	3/8	1/8	.312	1.531	1.125	.625
66HD-6-4	3/8	1/4	.312	1.718	1.312	.625
66HD-6-6	3/8	3/8	.312	1.750	1.343	.812

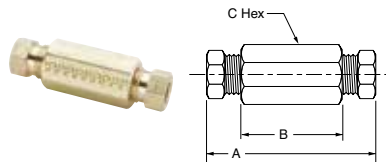

Union 62HD

PART NO.	TUBE SIZE	MIN. ORIFICE SIZE	A	B	C
62HD-2	1/8	.093	1.687	1.062	.375
62HD-3	3/16	.125	1.781	1.031	.437
62HD-4	1/4	.187	1.906	1.093	.562
62HD-6	3/8	.312	2.187	1.375	.625
62HD-8	1/2	.437	2.437	1.562	.812
62HD-10	5/8	.500	2.937	1.812	1.062

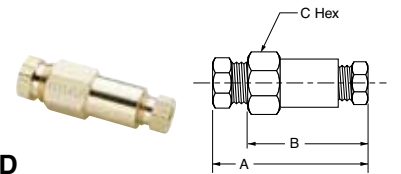

Reducing Union 62HD

PART NO.	TUBE SIZE	MIN. ORIFICE SIZE	A	B	C HEX
62HD-6-4	3/8 X 1/4	.187	2.000	1.187	.625
62HD-8-4	1/2 X 1/4	.187	2.125	1.281	.812
62HD-8-6	1/2 X 3/8	.312	2.656	1.406	.812

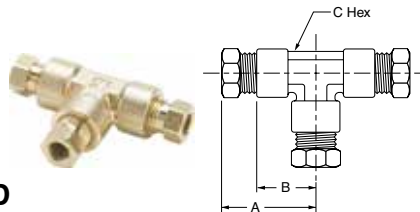

Union Tee 164HD

PART NO.	TUBE SIZE	MIN. ORIFICE SIZE	A	B	C HEX
164HD-4	1/4	.187	1.082	.687	.500
164HD-6	3/8	.312	1.357	.970	.562
164HD-8	1/2	.437	1.481	1.060	.750

WARNING These products can expose you to chemicals including LEAD which is known to the state of California to cause cancer.

[Click here for CADs, Product Specifications or to Configure Parts Online](#)

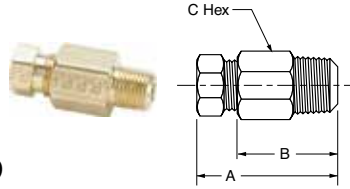

Male Connector 68HD

PART NO.	TUBE SIZE	PIPE THREAD	MIN. ORIFICE SIZE	A	B	C HEX
68HD-2-2	1/8	1/8	.093	1.062	.750	.437
68HD-3-2	3/16	1/8	.125	1.140	.765	.437
68HD-4-2	1/4	1/8	.187	1.343	.937	.562
68HD-4-4	1/4	1/4	.187	1.468	1.062	.562
68HD-4-6	1/4	3/8	.187	1.343	.937	.687
68HD-4-8	1/4	1/2	.187	1.531	1.125	.875
68HD-5-2	5/16	1/8	.218	1.406	1.000	.562
68HD-5-4	5/16	1/4	.218	1.500	1.093	.562
68HD-6-2	3/8	1/8	.218	1.531	1.125	.625
68HD-6-4	3/8	1/4	.312	1.656	1.250	.625
68HD-6-6	3/8	3/8	.312	1.531	1.125	.687
68HD-6-8	3/8	1/2	.312	1.531	1.125	.875
68HD-8-4	1/2	1/4	.312	1.813	1.375	.812
68HD-8-6	1/2	3/8	.406	1.750	1.312	.812
68HD-8-8	1/2	1/2	.437	1.812	1.375	.875
68HD-8-12	1/2	3/4	.437	1.625	1.187	1.062
68HD-10-6	5/8	3/8	.406	2.031	1.468	1.062
68HD-10-8	5/8	1/2	.500	2.156	1.593	1.062

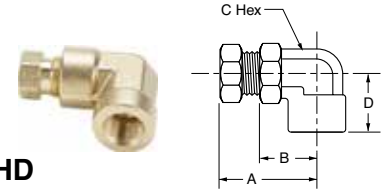

Female Elbow 170HD

PART NO.	TUBE SIZE	PIPE THREAD	MIN. ORIFICE SIZE	A	B	C HEX	D
170HD-2-2	1/8	1/8	.093	1.005	.690	.500	.750
170HD-4-2	1/4	1/8	.187	1.084	.687	.500	.750
170HD-4-4	1/4	1/4	.187	1.234	.843	.562	.875
170HD-6-2	3/8	1/8	.312	1.281	.875	.562	.937
170HD-6-4	3/8	1/4	.312	1.376	.970	.615	1.093
170HD-6-6	3/8	3/8	.312	1.526	1.120	.690	1.150
170HD-8-6	1/2	3/8	.437	1.481	1.062	.740	1.281

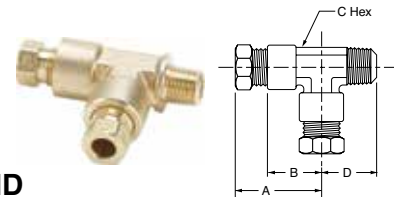

Male Run Tee 171HD

PART NO.	TUBE SIZE	PIPE THREAD	MIN. ORIFICE SIZE	A	B	C HEX	D
171HD-4-2	1/4	1/8	.187	1.144	.750	.500	.780
171HD-4-4	1/4	1/4	.187	1.207	.812	.500	.937
171HD-6-4	3/8	1/4	.312	1.376	.970	.562	1.000

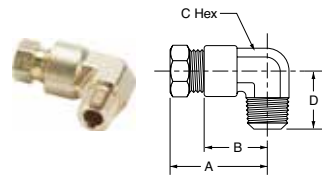

Male Elbow 169HD

PART NO.	TUBE SIZE	PIPE THREAD	MIN. ORIFICE SIZE	A	B	C HEX	D
169HD-2-2	1/8	1/8	.093	.975	.656	.438	.720
169HD-3-2	3/16	1/8	.125	1.056	.687	.437	.750
169HD-4-2	1/4	1/8	.187	1.084	.687	.500	.750
169HD-4-4	1/4	1/4	.187	1.144	.750	.500	.937
169HD-5-2	5/16	1/8	.218	1.144	.750	.562	.810
169HD-5-4	5/16	1/4	.250	1.206	.812	.562	1.000
169HD-6-2	3/8	1/8	.218	1.281	.875	.562	.875
169HD-6-4	3/8	1/4	.312	1.281	.875	.562	1.000
169HD-6-6	3/8	3/8	.312	1.376	.970	.615	1.031
169HD-6-8	3/8	1/2	.312	1.526	1.120	.687	1.310
169HD-8-4	1/2	1/4	.312	1.421	1.000	.678	1.062
169HD-8-6	1/2	3/8	.406	1.421	1.000	.678	1.062
169HD-8-8	1/2	1/2	.437	1.481	1.060	.740	1.420
169HD-10-6	5/8	3/8	.406	1.818	1.270	.875	1.340
169HD-10-8	5/8	1/2	.500	1.818	1.270	.875	1.480

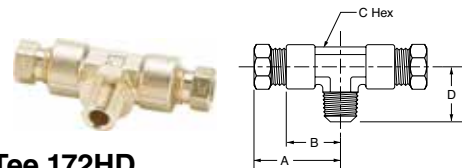

Male Branch Tee 172HD

PART NO.	TUBE SIZE	PIPE THREAD	MIN. ORIFICE SIZE	A	B	C HEX	D
172HD-4-2	1/4	1/8	.187	1.082	.687	.500	.780
172HD-4-4	1/4	1/4	.187	1.269	.875	.500	.937
172HD-6-6	3/8	3/8	.312	1.406	1.000	.562	1.125

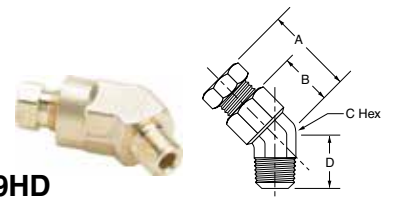

45° Male Elbow 179HD

PART NO.	TUBE SIZE	PIPE THREAD	MIN. ORIFICE SIZE	A	B	C HEX	D
179HD-4-2	1/4	1/8	.187	1.093	.687	.562	.750
179HD-6-4	3/8	1/4	.280	1.138	.710	.550	.850

WARNING These products can expose you to chemicals including LEAD which is known to the state of California to cause cancer.

[Click here for CADs, Product Specifications or to Configure Parts Online](#)

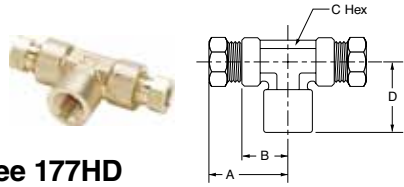

Female Branch Tee 177HD

PART NO.	TUBE SIZE	PIPE THREAD	MIN. ORIFICE SIZE	A	B	C HEX	D
177HD-4-2	1/4	1/8	.187	1.082	.687	.500	.750
177HD-4-4	1/4	1/4	.187	1.144	.750	.562	1.093
177HD-6-4	3/8	1/4	.312	1.376	.970	.562	1.093

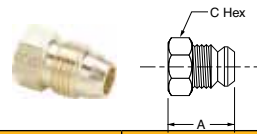

Plug 59HD

PART NO.	TUBE SIZE	A	C
59HD-4	1/4	.734	.437
59HD-6	3/8	.843	.625

WARNING These products can expose you to chemicals including LEAD which is known to the state of California to cause cancer.



Industrial Flare Fittings

45° Flare Fittings

Inverted Flared Fittings

Access Valves





GOODYEAR
RUBBER PRODUCTS, INC.

+1.727.342.5087

También puede enviarnos un correo electrónico a
ventas@goodyearrubberproducts.com

Flare to Male NPT

48F
Male Connector
p. H9



145F
Branch Tee
p. H10



149F-249F
Male Elbow
p. H10



151F
Run Tee
p. H11



159F-259F
45° Male Elbow
p. H11



256F
Adapter Tee
p. H12



481FHD
Male Connector
p. H14



2451FHD
Branch Tee
p. H15



2491FHD-2491F
Male Elbow
p. H15



2511FHD
Run Tee
p. H15



2591FHD
45° Male Elbow
p. H15



AVU1
Male Connector
p. H17



AVE1
Male Elbow
p. H17



AVT3
Run Tee
p. H17



AVC1
Cross
p. H17



Flare to Straight Thread

485F
Male Connector
p. H9



1495F
Male Elbow
p. H11



1595F
45° Male Elbow
p. H12



AVU1FI
Male Connector
p. H17



Flare to Solder

US5
Flare Adapter
p. H7



43F
Connector
p. H8



AVUSE
Extended
Copper Tube
p. H17



AVTS
Solder Tee
p. H17



AVUS3
3 Way Solder
p. H18



AVUS
Solder Connector
p. H18



Flare to Female NPT

46F
Female Connector
p. H9



150F
Female Elbow
p. H11



461FHD
Female Connector
p. H14



2501FHD
Female Elbow
p. H15



2521FHD
Branch Tee
p. H15



WARNING These products can expose you to chemicals including LEAD which is known to the state of California to cause cancer.

Flare to Flare

14FSV

Swivel Nut Connector
p. H7



42F

Union
p. H8



144F-244F

Union Tee
p. H10



155F

Union Elbow
p. H11



166FSV

Swivel Elbow
p. H12



660FHD

Union
p. H12



42IFHD

Union
p. H14



244IFHD

Union Tee
p. H14



255IFHD

Branch Tee
p. H15



AVU2

Union
p. H17



AVUR3

Female Connector
p. H17



AVUS4D

Swivel Connector
p. H18



AVTS4

Run Tee
p. H18



AVTS6

Branch Tee
p. H18



Flare to Metric Straight Thread

48F-X-MIX

Male Connector
p. H9



149F-X-MIX

Male Elbow
p. H11



159F-X-MIX

45° Male Elbow
p. H12



Bulkhead Union

AVU2BH

Bulkhead Union
p. H17



AVUS3BH

Bulkhead Union
p. H17



Adapter

1F

Refrigerant Drum
p. H7



661FHD

Reducer
p. H12



664FHD

Female Flare – Pipe
p. H12



88AC

Refrigerant Adapter
p. H18



880AC

Refrigerant Adapter
p. H18



881AC

Refrigerant Adapter
p. H18



Accessories

2GF

Flare Gasket
p. H7



3GF

Seal Bonnet
p. H7



14FL

Long Forged Nut
p. H7



14FS

Short Forged Nut
p. H7



14FSX

Short Forged Nut
p. H7



41FL

Long Nut
p. H8



41FS/41FX

Short Nut
p. H8



639F

Seal Plug
p. H12



640F

Cap Nut
p. H12



41IF

Inverted Flare Nut
p. H14



41IFS

Inverted Flare Nut Steel
p. H14



41IFF

Inverted Flare Piloted Nut
p. H14



640QSF

Seal Cap
p. H18



640QSFCR

Seal Cap with Core Remover
p. H18



CR

Core Remover
p. H18



VC

Valve Core
p. H18



⚠ WARNING These products can expose you to chemicals including LEAD which is known to the state of California to cause cancer.

45° Flare Fittings



Parker's Flare Fittings is an economical choice for a metal-to-metal seal that resists mechanical pullout. Meets functional requirements of SAE J512 and SAE J513.

Product Features:

- All brass construction
- Resists vibration with use of long nut
- UL listing
- Functional requirements of SAE J512 and J513

Markets:

- Refrigeration
- Heavy Duty Truck
- Mobile
- Industrial
- Heating
- Air Conditioning

Applications:

- Refrigerant Lines
- Propane
- Fuels
- Adapters
- Natural Gas

Compatible Tubing:

- Copper
- Brass
- Aluminum
- Welded Steel Hydraulic Tubing



Assembly Instructions

1. Cut tubing squarely and clean tube end thoroughly to remove burrs.
2. Place nut onto tube. Place threaded end of nut toward end of tube.
3. Flare tube end with flaring tool to provide 45° flare.
4. Clamp tube flare between nut and nose of fitting body by screwing nut on finger-tight. Tighten with a wrench an additional 1/4 to 1/2 turn past finger-tight for a metal-to-metal seal.

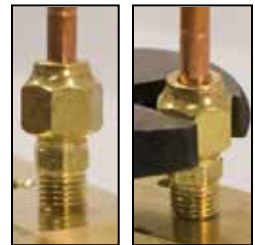

Specifications:

Temperature Range: -65° to +250° F (-53.8° to 121.1° C)

Pressure Range:

TUBE SIZE	PSI	bar	TUBE SIZE	PSI	bar
1/8	2800	193.0	3/8	1000	68.9
3/16	1900	131.0	1/2	750	51.7
1/4	1400	96.5	5/8	650	44.8
5/16	1200	82.7	3/4	550	37.9

WARNING These products can expose you to chemicals including LEAD which is known to the state of California to cause cancer.

[Click here for CADs, Product Specifications or to Configure Parts Online](#)

Refrigerant Drum Adapter 1F

Ref. SAE 010165

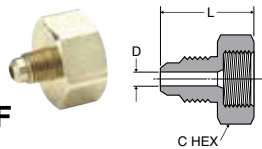

PART NO.	TUBE O. D.	PIPE THREAD	C HEX	L	FLOW DIA. D
1F-4-8	1/4	1/2	1-1/8	1.12	.189
1F-4-12*	1/4	3/4	1-1/4	1.12	.189
1F-6-12*	3/8	3/4	1-1/4	1.24	.282
1F-8-12*	1/2	3/4	1-1/4	1.37	.407

Gasket Furnished with each 1F adapter

Copper Flare Gasket 2GF

REF. SAE 010113

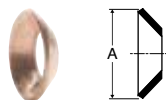

PART NO.	TUBE SIZE	A
2GF-3	3/16	.32
2GF-4	1/4	.36
2GF-5	5/16	.43
2GF-6	3/8	.56
2GF-8	1/2	.67
2GF-10	5/8	.78
2GF-12	3/4	.97

Seal Bonnet 3GF

REF. SAE 010114

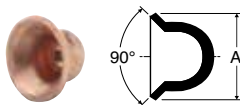

PART NO.	TUBE SIZE	A
3GF-3	3/16	.32
3GF-4	1/4	.37
3GF-5	5/16	.43
3GF-6	3/8	.56
3GF-8	1/2	.67
3GF-10	5/8	.78
3GF-12	3/4	.97

Long Forged Nut 14FL

REF. SAE 010167

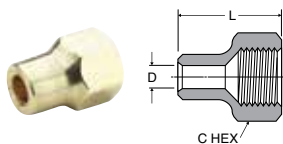

PART NO.	TUBE SIZE	STRAIGHT THREAD	C HEX	D	L
14FL-4	1/4	7/16-20	5/8	.257	.94
14FL-6	3/8	5/8-18	13/16	.382	1.06
14FL-8	1/2	3/4-16	15/16	.507	1.19
14FL-10	5/8	7/8-14	1-1/16	.632	1.44

Short Forged Nut 14FSX

REF. SAE 010166

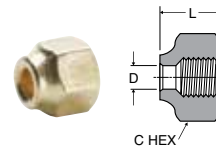

PART NO.	TUBE SIZE	STRAIGHT THREAD	C HEX	D	L
14FSX-4	1/4	7/16-20	5/8	.257	.63
14FSX-5	5/16	1/2-20	11/16	.320	.67
14FSX-6	3/8	5/8-18	13/16	.382	.74
14FSX-8	1/2	3/4-16	15/16	.507	.86
14FSX-10	5/8	7/8-14	1-1/16	.632	.97
14FSX-12	3/4	1-1/16-14	1-5/16	.757	1.17

Short Forged Reducing Nuts 14FS

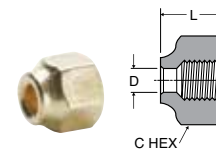

PART NO.	TUBE SIZE	STRAIGHT THREAD	C HEX	D	L
14FS-6-4	3/8 TO 1/4	5/8-18	13/16	.257	.74
14FS-8-6	1/2 TO 3/8	3/4-16	15/16	.382	.86
14FS-10-8	5/8 TO 1/2	7/8-14	1-1/16	.507	.99

Swivel Nut Valve Connector 14FSV

REF. SAE 010108

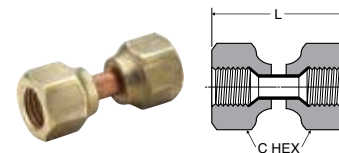

PART NO.	TUBE SIZE	STRAIGHT THREAD	C HEX	L MIN.
14FSV-4	1/4	7/16-20	5/8	1.31
14FSV-6	3/8	5/8-18	13/16	1.50
14FSV-8	1/2	3/4-16	15/16	1.75
14FSV-10	5/8	7/8-14	1-1/16	2.00

Flare Adapter US5

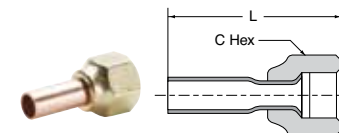

PART NO.	TUBE SIZE	STRAIGHT THREAD	C HEX	L
US5-4	1/4	7/16-20	5/8	1.50
US5-6	3/8	5/8-18	13/16	1.58
US5-8	1/2	3/4-16	15/16	1.80

WARNING These products can expose you to chemicals including LEAD which is known to the state of California to cause cancer.

Long Nut 41FL

REF. SAE 010111

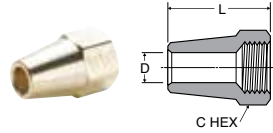

PART NO.	TUBE SIZE	STRAIGHT THREAD	C HEX	D	L
41FL-2	1/8	5/16-24	3/8	.133	.75
41FL-3	3/16	3/8-24	7/16	.195	.81
41FL-4	1/4	7/16-20	9/16	.257	.94
41FL-5	5/16	1/2-20	5/8	.320	1.12
41FL-6	3/8	5/8-18	3/4	.382	1.31
41FL-8	1/2	3/4-16	7/8	.507	1.62
41FL-10	5/8	7/8-14	1-1/16	.632	1.88
41FL-12	3/4	1-1/16-14	1-1/4	.757	2.19

Short Nut 41FS / Shorter Nut 41FX

REF. SAE 010110

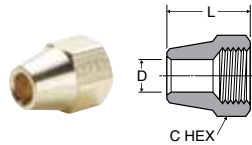

PART NO.	TUBE SIZE	STRAIGHT THREAD	C HEX	D	L
41FS-2	1/8	5/16-24	3/8	.132	.50
41FS-3	3/16	3/8-24	7/16	.195	.62
41FS-4	1/4	7/16-20	9/16	.257	.75
41FS-5	5/16	1/2-20	5/8	.320	.88
41FS-6	3/8	5/8-18	3/4	.382	1.00
41FX-6	3/8	5/8-18	3/4	.382	.91
41FS-8	1/2	3/4-16	7/8	.507	1.12
41FX-8	1/2	3/4-16	7/8	.507	1.00
41FS-10	5/8	7/8-14	1-1/16	.632	1.31
41FX-10	5/8	7/8-14	1-1/16	.632	1.06
41FX-12	3/4	1-1/16-14	1-1/4	.757	1.17
41FS-12	3/4	1-1/16-14	1-1/4	.757	1.50
41FS-14	7/8	1-1/4-12	1-1/2	.882	1.62

Union 42F

REF. SAE 010101 *THREAD PROTECTORS

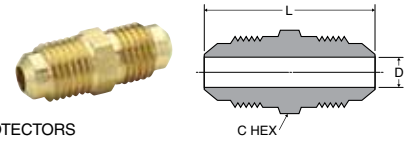

PART NO.	TUBE SIZE	STRAIGHT THREAD	C HEX	L	D
42F-2	1/8	5/16-24	5/16	.90	.079
42F-3	3/16	3/8-24	3/8	1.04	.125
42F-4	1/4	7/16-20	7/16	1.17	.189
42F-5	5/16	1/2-20	1/2	1.32	.220
42F-6	3/8	5/8-18	5/8	1.48	.282
42F-8	1/2	3/4-16	3/4	1.79	.407
42F-10	5/8	7/8-14	7/8	2.10	.501
42F-12*	3/4	1-1/16-14	1-1/16	2.42	.626
42F-14*	7/8	1-1/4-12	1-1/4	2.72	.751

Union Reducers 42F

REF. SAE 010101

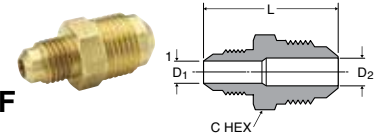

PART NO.	1 TUBE SIZE	2 TUBE SIZE	1 STRAIGHT THREAD	2 STRAIGHT THREAD	C HEX	L	FLOW DIA. D1	FLOW DIA. D2
42F-6-4	1/4	3/8	7/16-20	5/8-18	5/8	1.36	.189	.282
42F-6-5	5/16	3/8	1/2-20	5/8-18	5/8	1.42	.220	.282
42F-8-4	1/4	1/2	7/16-20	3/4-16	3/4	1.54	.189	.407
42F-8-6	3/8	1/2	5/8-18	3/4-16	3/4	1.67	.282	.407
42F-10-6	3/8	5/8	5/8-18	7/8-14	7/8	1.86	.282	.501
42F-10-8	1/2	5/8	3/4-16	7/8-14	7/8	1.98	.407	.501

Flare to Solder 43F

REF. SAE 010104

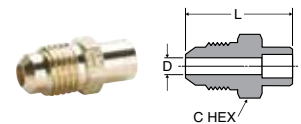

PART NO.	TUBE SIZE	SOLDER OD	STRAIGHT THREAD	C HEX	L	FLOW DIA. D
43F-4-4	1/4	1/4	7/16-20	7/16	.98	.189
43F-4-5	1/4	5/16	7/16-20	7/16	.98	.189
43F-4-6	1/4	3/8	7/16-20	1/2	.98	.189
43F-6-4	3/8	1/4	5/8-18	5/8	1.17	.189
43F-6-5	3/8	5/16	5/8-18	5/8	1.17	.252
43F-6-6	3/8	3/8	5/8-18	5/8	1.17	.282
43F-6-8	3/8	1/2	5/8-18	5/8	1.23	.282
43F-6-10	3/8	5/8	5/8-18	3/4	1.36	.282
43F-8-6	1/2	3/8	3/4-16	3/4	1.36	.314
43F-8-8	1/2	1/2	3/4-16	3/4	1.42	.407
43F-8-10	1/2	5/8	3/4-16	3/4	1.54	.407
43F-10-8	5/8	1/2	7/8-14	7/8	1.60	.440
43F-10-10	5/8	5/8	7/8-14	7/8	1.73	.501
43F-10-12*	5/8	3/4	7/8-14	7/8	1.86	.501
43F-12-12*	3/4	3/4	1-1/16-14	1-1/16	2.04	.626
43F-12-14*	3/4	7/8	1-1/16-14	1-1/16	2.17	.626

*Comes standard with thread protectors

⚠ WARNING These products can expose you to chemicals including LEAD which is known to the state of California to cause cancer.

[Click here for CADs, Product Specifications or to Configure Parts Online](#)

Female Connector 46F

REF. SAE 010103

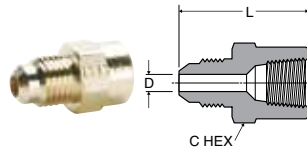

PART NO.	TUBE SIZE	PIPE THREAD	STRAIGHT THREAD	C HEX	L	FLOW DIA. D
46F-2-2	1/8	1/8	5/16-24	9/16	.91	.078
46F-3-2	3/16	1/8	3/8-24	9/16	.95	.125
46F-4-2	1/4	1/8	7/16-20	9/16	1.01	.189
46F-4-4	1/4	1/4	7/16-20	11/16	1.23	.189
46F-4-6	1/4	3/8	7/16-20	13/16	1.26	.189
46F-5-2	5/16	1/8	1/2-20	9/16	1.05	.220
46F-5-4	5/16	1/4	1/2-20	11/16	1.26	.220
46F-6-2	3/8	1/8	5/8-18	5/8	1.10	.282
46F-6-4	3/8	1/4	5/8-18	11/16	1.29	.282
46F-6-6	3/8	3/8	5/8-18	13/16	1.36	.282
46F-6-8	3/8	1/2	5/8-18	1	1.60	.282
46F-8-4	1/2	1/4	3/4-16	3/4	1.39	.407
46F-8-6	1/2	3/8	3/4-16	13/16	1.48	.407
46F-8-8	1/2	1/2	3/4-16	1	1.73	.407
46F-8-12*	1/2	3/4	3/4-16	1-1/4	1.79	.407
46F-10-6	5/8	3/8	7/8-14	7/8	1.57	.501
46F-10-8	5/8	1/2	7/8-14	1	1.80	.501
46F-10-12*	5/8	3/4	7/8-14	1-1/4	1.89	.501

Male Connector 48F

REF. SAE 010102

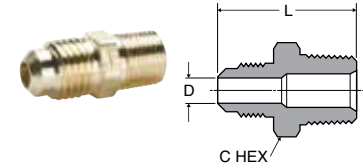

PART NO.	TUBE SIZE	PIPE THREAD	STRAIGHT THREAD	C HEX	L	FLOW DIA. D
48F-2-2	1/8	1/8	5/16-24	7/16	.91	.078
48F-3-2	3/16	1/8	3/8-24	7/16	.98	.125
48F-3-4	3/16	1/4	3/8-24	9/16	1.17	.125
48F-4-2	1/4	1/8	7/16-20	7/16	1.04	.189
48F-4-4	1/4	1/4	7/16-20	9/16	1.23	.189
48F-4-6	1/4	3/8	7/16-20	11/16	1.29	.189
48F-4-8	1/4	1/2	7/16-20	7/8	1.54	.189
48F-5-2	5/16	1/8	1/2-20	1/2	1.14	.220
48F-5-4	5/16	1/4	1/2-20	9/16	1.32	.220
48F-5-6	5/16	3/8	1/2-20	11/16	1.36	.220
48F-6-2	3/8	1/8	5/8-18	5/8	1.23	.220
48F-6-4	3/8	1/4	5/8-18	5/8	1.42	.282
48F-6-6	3/8	3/8	5/8-18	11/16	1.42	.282
48F-6-8	3/8	1/2	5/8-18	7/8	1.67	.282
48F-6-12*	3/8	3/4	5/8-18	1-1/16	1.79	.282
48F-8-4	1/2	1/4	3/4-16	3/4	1.60	.407
48F-8-6	1/2	3/8	3/4-16	3/4	1.60	.407
48F-8-8	1/2	1/2	3/4-16	7/8	1.79	.407
48F-8-12	1/2	3/4	3/4-16	1-1/16	1.92	.407
48F-10-4	5/8	1/4	7/8-14	7/8	1.79	.313
48F-10-6	5/8	3/8	7/8-14	7/8	1.79	.408
48F-10-8	5/8	1/2	7/8-14	7/8	1.98	.501
48F-10-12*	5/8	3/4	7/8-14	1-1/16	2.04	.501
48F-12-8*	3/4	1/2	1-1/16-14	1-1/16	2.17	.563
48F-12-12*	3/4	3/4	1-1/16-14	1-1/16	2.17	.626
48F-14-12*	7/8	3/4	1-1/4-12	1-1/4	2.35	.751

Flare to Metric Adaptor 48F-X-MIX

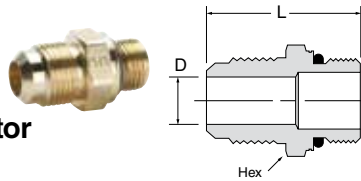

PART NUMBER	TUBE SIZE	METRIC THREAD	STRAIGHT THREAD TUBE	HEX	L	D
48F-8-M116	1/2	M16 X 1.5	3/4-16	7/8	1.60	.35
48F-10-M127	5/8	M27 X 2.0	7/8-14	1 1/4	1.87	.50
48F-12-M127*	3/4	M27 X 2.0	1 1/16-14	1 1/4	1.99	.63

Note: Fluorocarbon o-ring is standard

Flare to SAE Straight Thread 485F

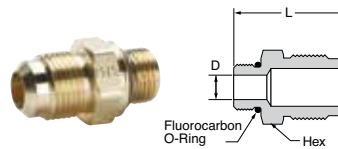

PART NO.	TUBE SIZE	STRAIGHT THREAD	STRAIGHT THREAD TUBE	HEX	L	FLOW DIA. D
485F-12-8*	3/4	3/4-16	1 1/16-14	1 1/16	1.80	.397
485F-12-12*	3/4	1 1/16-12	1 1/16-14	1 1/4	2.03	.615

*Comes standard with thread protectors

WARNING These products can expose you to chemicals including LEAD which is known to the state of California to cause cancer.

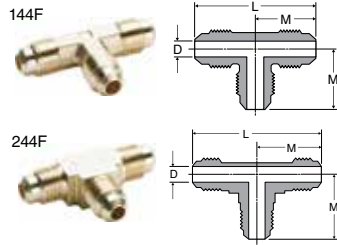

Union Tee 144F-244F

REF. SAE 010401

PART NO.	TUBE SIZE	STRAIGHT THREAD	L	M	FLOW DIA. D
144F-3	3/16	3/8-24	1.46	.73	.125
144F-4	1/4	7/16-20	1.72	.86	.189
244F-4	1/4	7/16-20	1.72	.86	.189
144F-5	5/16	1/2-20	1.82	.91	.220
144F-6	3/8	5/8-18	2.08	1.04	.282
144F-8	1/2	3/4-16	2.46	1.23	.407
144F-10	5/8	7/8-14	2.78	1.39	.501

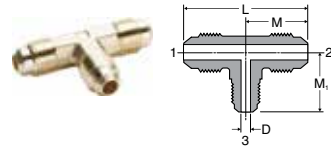

Union Tee 144F combination sizes

PART NO.	1 TUBE SIZE	2 TUBE SIZE	3 TUBE SIZE	L	M	M1	FLOW DIA. D
144F-6-6-4	3/8	3/8	1/4	2.08	1.04	.89	.189
144F-8-8-6	1/2	1/2	3/8	2.40	1.20	1.10	.282

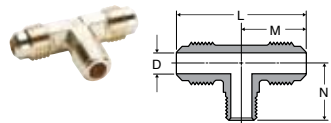

Male Branch Tee 145F

REF. SAE 010425

PART NO.	TUBE SIZE	PIPE THREAD	STRAIGHT THREAD	L	M	N	FLOW DIA. D
145F-2-2	1/8	1/8	5/16-24	1.26	.63	.69	.079
145F-4-2	1/4	1/8	7/16-20	1.58	.79	.76	.189
145F-4-4	1/4	1/4	7/16-20	1.78	.89	.92	.189
145F-5-4	5/16	1/4	1/2-20	1.90	.95	.96	.220
145F-6-4	3/8	1/4	5/8-18	1.96	.98	1.05	.282
145F-6-6	3/8	3/8	5/8-18	2.00	1.00	.98	.282
145F-6-8	3/8	1/2	5/8-18	2.28	1.14	1.26	.282
145F-8-6	1/2	3/8	3/4-16	2.40	1.20	1.10	.407
145F-8-8	1/2	1/2	3/4-16	2.46	1.23	1.36	.407
145F-10-8	5/8	1/2	7/8-14	2.78	1.39	1.36	.501

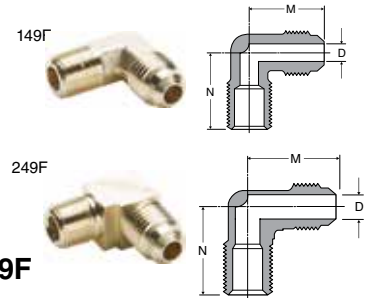

Male Elbow 149F-249F

REF. SAE 010202

PART NO.	TUBE SIZE	PIPE THREAD	STRAIGHT THREAD	M	N	FLOW DIA. D
149F-2-2	1/8	1/8	5/16-24	.63	.69	.079
149F-3-2	3/16	1/8	3/8-24	.75	.75	.125
249F-3-2	3/16	1/8	3/8-24	.73	.73	.125
149F-4-2	1/4	1/8	7/16-20	.79	.76	.189
249F-4-2	1/4	1/8	7/16-20	.79	.76	.189
149F-4-4	1/4	1/4	7/16-20	.89	.92	.189
249F-4-4	1/4	1/4	7/16-20	.89	.92	.189
149F-4-6	1/4	3/8	7/16-20	.92	1.01	.189
249F-4-6	1/4	3/8	7/16-20	.92	1.01	.189
149F-4-8	1/4	1/2	7/16-20	1.02	1.26	.189
149F-5-2	5/16	1/8	1/2-20	.90	.79	.220
249F-5-2	5/16	1/8	1/2-20	.89	.77	.220
149F-5-4	5/16	1/4	1/2-20	.95	.95	.220
249F-5-4	5/16	1/4	1/2-20	.95	.92	.220
149F-5-6	5/16	3/8	1/2-20	.98	1.01	.220
149F-6-2*	3/8	1/8	5/8-18	1.01	.90	.220
249F-6-2*	3/8	1/8	5/8-18	1.01	.89	.220
149F-6-4	3/8	1/4	5/8-18	1.01	1.05	.282
249F-6-4	3/8	1/4	5/8-18	.98	1.04	.282
149F-6-6	3/8	3/8	5/8-18	1.04	1.07	.282
249F-6-6	3/8	3/8	5/8-18	1.04	1.07	.282
149F-6-8	3/8	1/2	5/8-18	1.15	1.26	.282
249F-6-8	3/8	1/2	5/8-18	1.14	1.26	.282
149F-6-12*	3/8	3/4	5/8-18	1.25	1.38	.282
149F-8-4*	1/2	1/4	3/4-16	1.20	1.17	.314
149F-8-6	1/2	3/8	3/4-16	1.20	1.10	.407
249F-8-6	1/2	3/8	3/4-16	1.20	1.10	.407
149F-8-8	1/2	1/2	3/4-16	1.28	1.38	.407
249F-8-8	1/2	1/2	3/4-16	1.26	1.36	.407
149F-8-12*	1/2	3/4	3/4-16	1.38	1.38	.407
149F-10-4*	5/8	1/4	7/8-14	1.41	1.25	.314
149F-10-6*	5/8	3/8	7/8-14	1.41	1.25	.407
149F-10-8	5/8	1/2	7/8-14	1.40	1.39	.501
249F-10-8	5/8	1/2	7/8-14	1.39	1.36	.501
149F-10-12*	5/8	3/4	7/8-14	1.42	1.48	.501
149F-12-8**	3/4	1/2	1-1/16-14	1.60	1.48	.563
149F-12-12*	3/4	3/4	1-1/16-14	1.60	1.62	.626

* For these parts the pipe thread through hole is smaller than the through hole on the flare end.

*Comes standard with thread protectors

WARNING These products can expose you to chemicals including LEAD which is known to the state of California to cause cancer.

[Click here for CADs, Product Specifications or to Configure Parts Online](#)

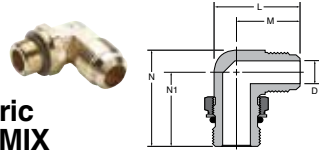

Flare Elbow to SAE Metric Straight Thread 149F-X-MIX

PART NUMBER	TUBE SIZE	METRIC THREAD	STRAIGHT THREAD TUBE	L	M	N	N1	D
149F-10-MI27	5/8	M27 X 2.0	7/8-14	1.95	1.46	2.12	1.63	.501

Note: Fluorocarbon o-ring is standard

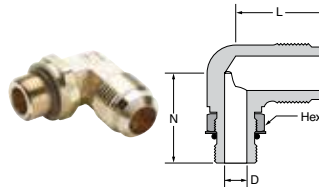

Flare Elbow to SAE Straight Thread 1495F

PART NO.	TUBE SIZE	STRAIGHT THREAD	STRAIGHT THREAD TUBE	HEX	L	N	FLOW DIA. D
1495F-12-8*	3/4	3/4-16	1 1/16-14	7/8	1.60	1.60	.398
1495F-12-12*	3/4	1-1/16-12	1 1/16-14	1 1/4	1.59	2.12	.616

Note: Fluorocarbon o-ring is standard

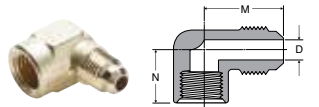

Female Elbow 150F

REF. SAE 010203

PART NO.	TUBE SIZE	PIPE THREAD	STRAIGHT THREAD	M	N	FLOW DIA. D
150F-4-2	1/4	1/8	7/16-20	.86	.50	.189
150F-4-4	1/4	1/4	7/16-20	.95	.67	.189
150F-5-4	5/16	1/4	1/2-20	1.01	.67	.220
150F-6-2	3/8	1/8	5/8-18	1.08	.48	.282
150F-6-4	3/8	1/4	5/8-18	1.07	.67	.282
150F-6-6	3/8	3/8	5/8-18	1.14	.67	.282
150F-6-8	3/8	1/2	5/8-18	1.23	.86	.282
150F-8-6	1/2	3/8	3/4-16	1.25	.69	.407
150F-8-8	1/2	1/2	3/4-16	1.36	.92	.407
150F-8-12	1/2	3/4	3/4-16	1.51	.92	.407
150F-10-8*	5/8	1/2	7/8-14	1.48	.98	.501
150F-10-12*	5/8	3/4	7/8-14	1.64	.98	.501

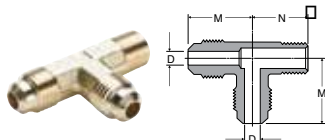

Male Run Tee 151F

REF. SAE 010424

PART NO.	TUBE SIZE	PIPE THREAD	STRAIGHT THREAD	M	N	FLOW DIA. D
151F-4-2	1/4	1/8	7/16-20	.86	.76	.189
151F-4-4	1/4	1/4	7/16-20	.89	.92	.189
151F-5-4	5/16	1/4	1/2-20	.95	.92	.220
151F-6-4	3/8	1/4	5/8-18	1.04	1.04	.282
151F-6-6	3/8	3/8	5/8-18	1.00	.98	.282
151F-6-8	3/8	1/2	5/8-18	1.16	1.26	.282
151F-8-6	1/2	3/8	3/4-16	1.20	1.10	.407
151F-8-8	1/2	1/2	3/4-16	1.23	1.36	.407
151F-10-8	5/8	1/2	7/8-14	1.39	1.36	.501

*Comes standard with thread protectors

WARNING These products can expose you to chemicals including LEAD which is known to the state of California to cause cancer.

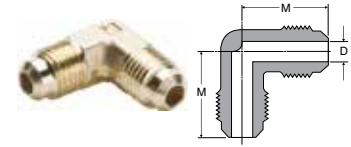

Union Elbow 155F

REF. SAE 010201

PART NO.	TUBE SIZE	STRAIGHT THREAD	M	FLOW DIA. D
155F-2	1/8	5/16-24	.64	.079
155F-3	3/16	3/8-24	.73	.125
155F-4	1/4	7/16-20	.86	.189
155F-5	5/16	1/2-20	.92	.220
155F-6	3/8	5/8-18	1.04	.282
155F-8	1/2	3/4-16	1.20	.407
155F-10	5/8	7/8-14	1.39	.501
155F-12*	3/4	1-1/16-14	1.64	.626

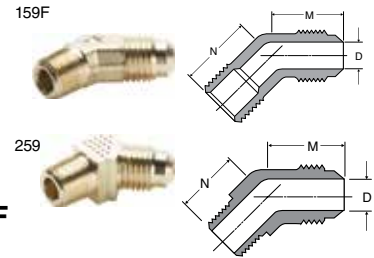

45° Elbow 159F-259F

REF. SAE 010302

PART NO.	TUBE SIZE	PIPE THREAD	STRAIGHT THREAD	M	N	FLOW DIA. D
159F-4-2	1/4	1/8	7/16-20	.78	.56	.189
259F-4-2	1/4	1/8	7/16-20	.65	.62	.189
159F-4-4	1/4	1/4	7/16-20	.75	.84	.189
259F-4-4	1/4	1/4	7/16-20	.73	.84	.189
159F-5-2	5/16	1/8	1/2-20	.76	.65	.220
159F-5-4	5/16	1/4	1/2-20	.75	.81	.220
159F-6-2*	3/8	1/8	5/8-18	.89	.67	.220
159F-6-4	3/8	1/4	5/8-18	.89	.86	.282
259F-6-4	3/8	1/4	5/8-18	.91	.86	.282
159F-6-6	3/8	3/8	5/8-18	.91	.93	.282
259F-6-6	3/8	3/8	5/8-18	.91	.93	.282
159F-8-4*	1/2	1/4	3/4-16	1.06	.95	.314
159F-8-6	1/2	3/8	3/4-16	1.06	.95	.407
259F-8-6	1/2	3/8	3/4-16	1.04	.93	.407
159F-8-8	1/2	1/2	3/4-16	1.12	1.16	.407
159F-10-6*	5/8	3/8	7/8-14	1.13	.95	.407
159F-10-8	5/8	1/2	7/8-14	1.21	1.16	.501
159F-12-8**	3/4	1/2	1-1/16-14	1.28	1.16	.560

* For these parts the pipe thread through hole is smaller than the through hole on the flare end.

45° Flare Elbow to SAE Metric Straight Thread 159F-X-MIX

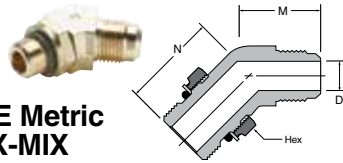

PART NUMBER	TUBE SIZE	METRIC THREAD	STRAIGHT THREAD TUBE	HEX	M	N	D
159F-8-MI16	1/2	M16 X 1.5	3/4-16	22MM	1.10	1.16	.36
159F-10-MI27	5/8	M27 X 2.0	7/8-14	1 1/4	1.21	1.50	.50

Note: Fluorocarbon o-ring is standard

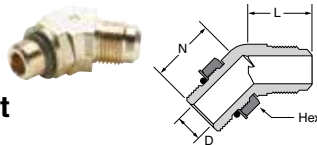

45° Flare to SAE Straight Thread 1595F

PART NO.	TUBE SIZE	STRAIGHT THREAD	STRAIGHT THREAD TUBE	HEX	L	N	FLOW DIA. D
1595F-8-8	1/2	3/4-16	3/4-16	7/8	1.00	1.16	.398
1595F-12-8*	3/4	3/4-16	1 1/16-14	7/8	1.41	1.30	.398
1595F-12-12*	3/4	1 1/16-12	1 1/16-14	1 1/4	1.41	1.45	.615

Note: Fluorocarbon o-ring is standard

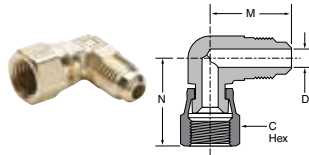

90° Swivel Elbow 166FSV

PART NO.	TUBE SIZE	STRAIGHT THREAD	C HEX	M	N	FLOW DIA. D
166FSV-4-4	1/4	7/16-20	9/16	.86	.93	.189
166FSV-6-6	3/8	5/8-18	3/4	1.04	1.12	.282
166FSV-8-8	1/2	3/4-16	7/8	1.20	1.29	.407
166FSV-10-10	5/8	7/8-14	1	1.39	1.50	.501
166FSV-12-12*	3/4	1-1/16-14	1-1/4	1.60	1.83	.626

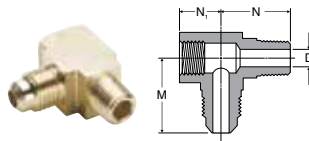

Adapter Tee 256F

PART NO.	TUBE SIZE	PIPE THREAD	STRAIGHT THREAD	M	N	N1	FLOW DIA. D
256F-4-2	1/4	1/8	7/16-20	.86	.77	.47	.220

Flared Seal Plug 639F

REF. SAE 010109

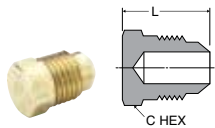

PART NO.	TUBE SIZE	STRAIGHT THREAD	C HEX	L
639F-4	1/4	7/16-20	7/16	.69
639F-5	5/16	1/2-20	1/2	.78
639F-6	3/8	5/8-18	5/8	.88
639F-8	1/2	3/4-16	3/4	1.06
639F-10	5/8	7/8-14	7/8	1.19

*Comes standard with thread protectors

†Should be used with 2GF flare gasket

WARNING These products can expose you to chemicals including LEAD which is known to the state of California to cause cancer.

Cap Nut 640F

REF. SAE 010112

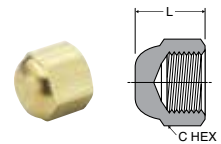

PART NO.	TUBE SIZE	STRAIGHT THREAD	C HEX	L
640F-3†	3/16	3/8-24	1/2	.47
640F-4†	1/4	7/16-20	9/16	.53
640F-5†	5/16	1/2-20	5/8	.62
640F-6†	3/8	5/8-18	3/4	.69
640F-8†	1/2	3/4-16	7/8	.84
640F-10†	5/8	7/8-14	1-1/16	.97

Flared Union-Female Flare to Female Flare 660FHD

REF. SAE 010107

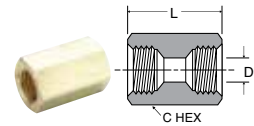

PART NO.	TUBE SIZE	STRAIGHT THREAD	C HEX	L	FLOW DIA. D
660FHD-4†	1/4	7/16-20	5/8	.98	.251
660FHD-6†	3/8	5/8-18	13/16	1.24	.376
660FHD-8†	1/2	3/4-16	15/16	1.43	.501
660FHD-10†	5/8	7/8-14	1-1/16	1.67	.626

Male Flare to Female Flare 661FHD

REF. SAE 010105

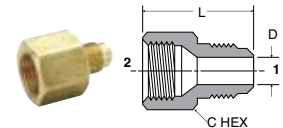

PART NO.	1 TUBE SIZE	2 TUBE SIZE	1 STRAIGHT THREAD	2 STRAIGHT THREAD	C HEX	L	FLOW DIA. D
661FHD-4-6†	1/4	3/8	7/16-20	5/8-18	13/16	1.20	.189
661FHD-4-8†	1/4	1/2	7/16-20	3/4-16	15/16	1.36	.189
661FHD-6-4†	3/8	1/4	5/8-18	7/16-20	5/8	1.10	.282
661FHD-6-8†	3/8	1/2	5/8-18	3/4-16	15/16	1.42	.282
661FHD-8-6†	1/2	3/8	3/4-16	5/8-18	13/16	1.39	.407
661FHD-8-10†	1/2	5/8	3/4-16	7/8-14	1-1/16	1.67	.407
661FHD-10-8†	5/8	1/2	7/8-14	3/4-16	15/16	1.60	.501
661FHD-10-12††	5/8	3/4	7/8-14	1-1/16-14	1-5/16	1.95	.501
661FHD-12-10††	3/4	5/8	1-1/16-14	7/8-14	1-1/16	1.86	.626

Female Flare to Male Pipe Thread 664FHD

REF. SAE 010106

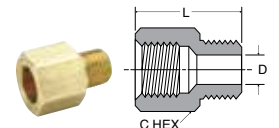

PART NO.	TUBE SIZE	PIPE THREAD	STRAIGHT THREAD	C HEX	L	FLOW DIA. D
664FHD-4-2†	1/4	1/8	7/16-20	5/8	.91	.220
664FHD-4-4†	1/4	1/4	7/16-20	5/8	1.01	.252
664FHD-6-4†	3/8	1/4	5/8-18	13/16	1.28	.345
664FHD-8-6†	1/2	3/8	3/4-16	15/16	1.31	.407



Inverted Flared Fittings

Parker's Inverted Flare Fittings offers a metal-to-metal seal that is internal to the fitting for tighter tube bends. These fittings are listed with UL and meets the functional requirements of SAE J512.

Product Features:

- All brass construction
- UL listed for flammable liquid and gas
- Meets functional requirements of SAE J512
- Steel nut for economy

Markets:

- Air Conditioning
- Marine
- Mobile
- Engines

Applications:

- Refrigerant Lines
- Brake Lines
- Fuel Lines

Compatible Tubing:

- Copper
- Brass
- Aluminum
- Welded Steel Hydraulic Tubing



Assembly Instructions

1. Cut tubing squarely and clean to remove burrs
2. Place nut onto tube. Place threaded end of nut toward end of tube.
3. Flare tube end with flaring tool to provide 45° flare
4. On thin wall copper, welded or brazed tubing, use double flare to prevent pinch-off or cracked flares
5. Clamp tube flare between nut and nose of fitting body by screwing nut on finger tight. Tighten nut with a wrench an additional 1/4 to 1/2 turn past finger tight for a metal-to-metal seal.



Specifications:

Temperature Range: -65° to +250° F (-53.8° to 121.1° C)

Pressure Range:

TUBE SIZE	PSI	bar	TUBE SIZE	PSI	bar
1/8	2800	193.0	3/8	1000	68.9
3/16	1900	131.0	1/2	750	51.7
1/4	1400	96.5	5/8	650	44.8
5/16	1200	82.7	3/4	550	37.9

⚠️ WARNING These products can expose you to chemicals including LEAD which is known to the state of California to cause cancer.

Nut 411F

REF. SAE 040110

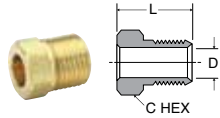

PART NO.	TUBE SIZE	STRAIGHT THREAD	C HEX	L	D
411F-2	1/8	5/16-28	5/16	.52	.133
411F-3	3/16	3/8-24	3/8	.56	.196
411F-4	1/4	7/16-24	7/16	.56	.259
411F-5	5/16	1/2-20	1/2	.62	.321
411F-6	3/8	5/8-18	5/8	.66	.384
411F-8	1/2	3/4-18	3/4	.74	.508

Female Connector 461FHD

REF. SAE 040103

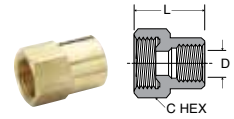

PART NO.	TUBE SIZE	PIPE THREAD	STRAIGHT THREAD	C HEX	L	FLOW DIA. D
461FHD-3-2	3/16	1/8	3/8-24	1/2	.76	.125
461FHD-4-2	1/4	1/8	7/16-24	17/32	.78	.189
461FHD-5-2	5/16	1/8	1/2-20	19/32	.79	.220
461FHD-6-4	3/8	1/4	5/8-18	3/4	1.04	.282
461FHD-8-6	1/2	3/8	3/4-18	29/32	1.10	.407

Steel Nut-Zinc 411FS

REF. SAE 040110

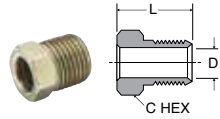

PART NO.	TUBE SIZE	STRAIGHT THREAD	C HEX	L	D
411FS-3	3/16	3/8-24	3/8	.56	.196
411FS-4	1/4	7/16-24	7/16	.56	.259
411FS-5	5/16	1/2-20	1/2	.62	.321
411FS-6	3/8	5/8-18	5/8	.66	.384
411FS-8	1/2	3/4-18	3/4	.74	.508
411FS-10	5/8	7/8-18	7/8	.80	.633

Male Connector 481FHD

REF. SAE 040102

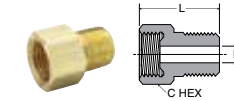

PART NO.	TUBE SIZE	PIPE THREAD	STRAIGHT THREAD	C HEX	L	FLOW DIA. D
481FHD-2-2	1/8	1/8	5/16-28	13/32	.63	.078
481FHD-3-2	3/16	1/8	3/8-24	15/32	.70	.125
481FHD-4-2	1/4	1/8	7/16-24	17/32	.74	.189
481FHD-4-4	1/4	1/4	7/16-24	9/16	.89	.189
481FHD-5-2	5/16	1/8	1/2-20	19/32	.79	.220
481FHD-5-4	5/16	1/4	1/2-20	19/32	.98	.220
481FHD-6-2	3/8	1/8	5/8-18	3/4	.89	.220
481FHD-6-4	3/8	1/4	5/8-18	3/4	1.03	.282
481FHD-6-6	3/8	3/8	5/8-18	3/4	1.03	.282
481FHD-8-4	1/2	1/4	3/4-18	29/32	1.07	.346
481FHD-8-6	1/2	3/8	3/4-18	29/32	1.07	.407
481FHD-8-8	1/2	1/2	3/4-18	29/32	1.26	.407
481FHD-10-8	5/8	1/2	7/8-18	1-1/16	1.32	.533
481FHD-12-12	3/4	3/4	1-1/16-16	1 1/4	1.38	.626

Piloted Nut 411FF for Single Flared Tubing

REF. SAE 040110

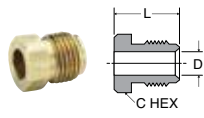

PART NO.	TUBE SIZE	STRAIGHT THREAD	C HEX	L	D
411FF-2	1/8	5/16-28	5/16	.52	.133
411FF-3	3/16	3/8-24	3/8	.56	.196
411FF-4	1/4	7/16-24	7/16	.56	.259
411FF-5	5/16	1/2-20	1/2	.62	.321
411FF-6	3/8	5/8-18	5/8	.66	.384
411FF-8	1/2	3/4-18	3/4	.74	.508

Union Tee 244IFHD

REF. SAE 040401

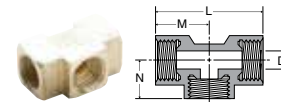

PART NO.	TUBE SIZE	STRAIGHT THREAD	L	M	N	FLOW DIA. D
244IFHD-3	3/16	3/8-24	1.10	.55	.39	.125
244IFHD-4	1/4	7/16-24	1.13	.56	.42	.189
244IFHD-5	5/16	1/2-20	1.26	.63	.45	.220
244IFHD-6	3/8	5/8-18	1.48	.74	.56	.282
244IFHD-8*	1/2	3/4-18	1.76	.88	.67	.407

*Does not meet SAE or UL.

Union 421FHD

REF. SAE 040101

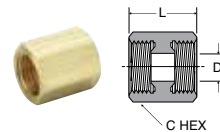

PART NO.	TUBE SIZE	STRAIGHT THREAD	C HEX	L	D
421FHD-2	1/8	5/16-28	13/32	.60	.078
421FHD-3	3/16	3/8-24	15/32	.63	.125
421FHD-4	1/4	7/16-24	17/32	.63	.189
421FHD-5	5/16	1/2-20	19/32	.71	.220
421FHD-6	3/8	5/8-18	3/4	.81	.282
421FHD-8	1/2	3/4-18	29/32	.92	.407

WARNING: These products can expose you to chemicals including LEAD which is known to the state of California to cause cancer.

[Click here for CADs, Product Specifications or to Configure Parts Online](#)

Male Branch Tee 245IFHD

REF. SAE 040425

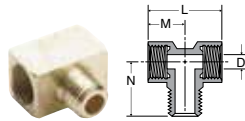

PART NO.	TUBE SIZE	PIPE THREAD	STRAIGHT THREAD	L	M	N	FLOW DIA. D
245IFHD-4-2	1/4	1/8	7/16-24	.85	.43	.64	.189
245IFHD-6-4	3/8	1/4	5/8-18	1.17	.58	.94	.282

Female Elbow 250IFHD

REF. SAE 040203

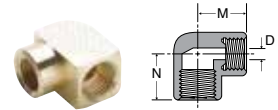

PART NO.	TUBE SIZE	PIPE THREAD	STRAIGHT THREAD	M	N	FLOW DIA. D
250IFHD-3-2	3/16	1/8	3/8-24	.50	.49	.125
250IFHD-4-2	1/4	1/8	7/16-24	.53	.53	.189
250IFHD-5-2	5/16	1/8	1/2-20	.59	.59	.220
250IFHD-6-4	3/8	1/4	5/8-18	.67	.68	.282

Male Elbow 249IFHD–249IF

REF. SAE 040202

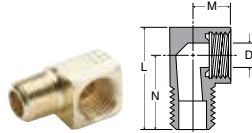

PART NO.	TUBE SIZE	PIPE THREAD	STRAIGHT THREAD	L	M	N	FLOW DIA. D
249IFHD-2-2	1/8	1/8	5/16-28	.79	.27	.58	.078
249IFHD-3-2	3/16	1/8	3/8-24	.85	.27	.61	.125
249IFHD-4-2†	1/4	1/8	7/16-24	.92	.33	.65	.189
249IFHD-4-4	1/4	1/4	7/16-24	1.10	.28	.82	.189
249IFHD-5-4	5/16	1/4	1/2-20	1.16	.45	.86	.220
249IFHD-6-2†	3/8	1/8	5/8-18	1.13	.53	.76	.220
249IF-6-4†	3/8	1/4	5/8-18	1.26	.45	.92	.282
249IFHD-6-4	3/8	1/4	5/8-18	1.32	.53	.95	.282
249IFHD-6-6	3/8	3/8	5/8-18	1.32	.50	.94	.282
249IFHD-8-4†	1/2	1/4	3/4-18	1.48	.59	1.02	.407
249IF-8-6†	1/2	3/8	3/4-18	1.42	.53	.99	.407
249IFHD-8-6†	1/2	3/8	3/4-18	1.48	.59	1.02	.407
249IFHD-8-8	1/2	1/2	3/4-18	1.67	.66	1.22	.407
249IFHD-10-6†	5/8	3/8	7/8-18	1.62	.67	1.09	.531
249IFHD-10-8†	5/8	1/2	7/8-18	1.82	.67	1.29	.533

†Light Duty Series

+For these parts the pipe thread through hole is smaller than the through hole on the flare end.

Male Run Tee 251IFHD

REF. SAE 040424

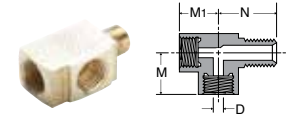

PART NO.	TUBE SIZE	PIPE THREAD	STRAIGHT THREAD	M	M1	N	FLOW DIA. D
251IFHD-3-2	3/16	1/8	3/8-24	.39	.53	.72	.125
251IFHD-5-2	5/16	1/8	1/2-20	.45	.62	.85	.220
251IFHD-6-4	3/8	1/4	5/8-18	.56	.75	1.08	.282

Female Branch Tee 252IFHD

REF. SAE 040427

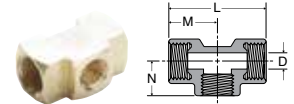

PART NO.	TUBE SIZE	PIPE THREAD	STRAIGHT THREAD	L	M	N	FLOW DIA. D
252IFHD-5-2	5/16	1/8	1/2-20	1.26	.63	.45	.220
252IFHD-6-4	3/8	1/4	5/8-18	1.48	.74	.56	.282

Union Elbow 255IFHD

PART NO.	TUBE SIZE	STRAIGHT THREAD	M	FLOW DIA. D
255IFHD-4*	1/4	7/16-24	.55	.189

*Does not meet SAE or UL.

45° Elbow 259IFHD

REF. SAE 040302

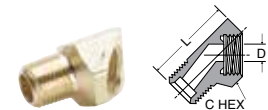

PART NO.	TUBE SIZE	PIPE THREAD	STRAIGHT THREAD	C HEX	L	FLOW DIA. D
259IFHD-3-2	3/16	1/8	3/8-24	17/32	.88	.125
259IFHD-4-2	1/4	1/8	7/16-24	9/16	.94	.189
259IFHD-5-2	5/16	1/8	1/2-20	5/8	1.00	.220
259IFHD-5-4	5/16	1/4	1/2-20	5/8	1.16	.220
259IFHD-6-4*	3/8	1/4	5/8-18	13/16	1.34	.282
259IFHD-8-6	1/2	3/8	3/4-18	7/8	1.44	.407
259IFHD-10-8	5/8	1/2	7/8-18	1-1/16	1.75	.533

*Does not meet SAE or UL.

WARNING These products can expose you to chemicals including LEAD which is known to the state of California to cause cancer.



Access Valves

Parker's Access Valves are designed to offer convenient, low cost access ports for refrigeration service. Access valves may be installed in any position on either high or low side for quick testing, pressure checking, purging or charging.

Product Features:

- All brass construction
- 1/4" SAE male flare access ports
- Finger tight quick seal caps
- Access valves with pipe connections have internal ODS solder cups

Markets:

- Refrigeration
- Air Conditioning

Applications:

- Pressure Testing
- Purging
- Charging Refrigeration Lines

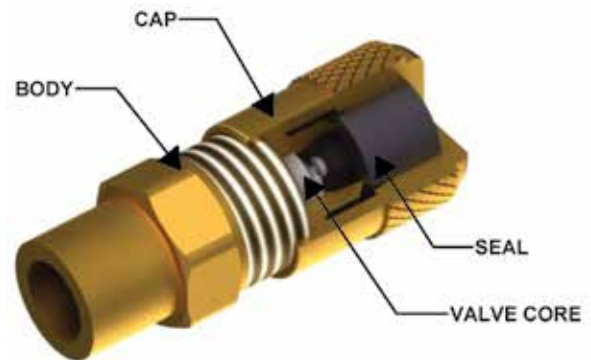

Specifications:

Pressure Range Up to 500 PSI (34.3 bar)

Temperature Range -20° to +220° F (-28.8° to +104.4° C)

Compatible Tubing:

- Copper

WARNING: These products can expose you to chemicals including LEAD which is known to the state of California to cause cancer.

[Click here for CADs, Product Specifications or to Configure Parts Online](#)

Extended Copper Tube AVUSE



PART NO.	CONNECTION SIZE
AVUSE-2	1/8" O.D. TUBE
AVUSE-3	3/16" O.D. TUBE
AVUSE-4	1/4" O.D. TUBE
AVUSE-6	3/8" O.D. TUBE
AVUSE-8	1/2" O.D. TUBE

Product comes with valve core loose and should be torqued after brazing to ARI 720 standard.

Solder Tee AVTS



PART NO.	CONNECTION SIZE
AVTS-4	1/4" O.D. TUBE OR 3/8" SOLDER FITTING/SWAGED TUBE
AVTS-6	3/8" O.D. TUBE OR 1/2" SOLDER FITTING/SWAGED TUBE
AVTS-8	1/2" O.D. TUBE

Product comes with valve core loose and should be torqued after brazing to ARI 720 standard.

Full Union AVU2



PART NO.	CONNECTION SIZE
AVU2-4	1/4" O.D. FLARE TUBE WITH FORGED FLARE NUT

Bulkhead Union AVU2BH



PART NO.	CONNECTION SIZE
AVU2BH-4	1/4" BULKHEAD ACCESS X 1/4" SAE WITH FORGED NUT

Bulkhead Solder Union AVUS3BH



PART NO.	CONNECTION SIZE
AVUS3BH-4	1/4" BULKHEAD ACCESS X 3 WAY ODS

Product comes with valve core loose and should be torqued after brazing to ARI 720 standard.

Male Connector AVU1



PART NO.	CONNECTION SIZE
AVU1-2	1/8" MALE PIPE OR 1/4" O.D. SOLDER
AVU1-4	1/4" MALE PIPE OR 5/16" O.D. SOLDER

Product comes with valve core loose and should be torqued after brazing to ARI 720 standard.

Access Valve Assembly AVUIFI



PART NO.	CONNECTION SIZE
AVUIFI-4	7/16-20 SAE STRAIGHT THREAD O-RING PORT

Note: Standard o-ring is neoprene. Consult Brass Products Division for optional o-rings

Forged Male Elbow AVE1



PART NO.	CONNECTION SIZE
AVE1-2	1/8" MALE PIPE OR 1/4" O.D. SOLDER

Product comes with valve core loose and should be torqued after brazing to ARI 720 standard.

Forged Male Run Tee AVT3



PART NO.	CONNECTION SIZE
AVT3-2	1/8" MALE PIPE OR 1/4" O.D. SOLDER ON RUN X 1/4" ACCESS ON RUN AND BRANCH WITH ONE CORE AND CAP
AVT3-4	1/4" MALE PIPE OR 5/16" O.D. SOLDER ON RUN X 1/4" ACCESS ON RUN AND BRANCH WITH ONE CORE AND CAP

Product comes with valve core loose and should be torqued after brazing to ARI 720 standard.

Forged Male Cross AVC1



PART NO.	CONNECTION SIZE
AVC1-4	1/4" MALE PIPE OR 5/16" O.D. SOLDER X 1/4" ACCESS ON ALL FLARE ENDS WITH ONE CORE AND CAP

Product comes with valve core loose and should be torqued after brazing to ARI 720 standard.

Female Connector AVUR3



PART NO.	CONNECTION SIZE
AVUR3-4	1/4" FEMALE FLARE WITH COPPER GASKET

WARNING These products can expose you to chemicals including LEAD which is known to the state of California to cause cancer.

3 Way Solder Connector AVUS3



PART NO.	CONNECTION SIZE
AVUS3-40	FOR 3/16" O.D. TUBE OR 1/4" AND 3/8" SOLDER FITTING/SWAGED TUBE

Product comes with valve core loose and should be torqued after brazing to ARI 720 standard.

Straight Solder Connector AVUS



PART NO.	CONNECTION SIZE
AVUS-42	1/8" O.D. TUBE OR 1/4" SOLDER FITTING/SWAGED TUBE
AVUS-43	3/16" O.D. TUBE OR 1/4" SOLDER FITTING/SWAGED TUBE
AVUS-44	1/4" O.D. TUBE OR 3/8" SOLDER FITTING/SWAGED TUBE
AVUS-46	3/8" O.D. TUBE OR 1/2" SOLDER FITTING/SWAGED TUBE

Product comes with valve core loose and should be torqued after brazing to ARI 720 standard.

Swivel Connector AVUS4D



PART NO.	CONNECTION SIZE
AVUS4D-4	1/4" FORGED FEMALE FLARE SWIVEL NUT WITH DEPRESSOR

Forged Female Run Swivel Tee AVTS4



PART NO.	CONNECTION SIZE
AVTS4-4	1/4" FEMALE FLARE SWIVEL X 1/4" ACCESS ON BOTH RUN AND BRANCH
AVTS4D-4	1/4" FEMALE FLARE SWIVEL ON RUN WITH DEPRESSOR X 1/4" ACCESS ON BOTH RUN AND BRANCH

Forged Female Branch Tee AVTS6



PART NO.	CONNECTION SIZE
AVTS6-4	1/4" FEMALE FLARE SWIVEL X 1/4" ACCESS ON BOTH ENDS
AVTS6D-4	1/4" FEMALE FLARE SWIVEL ON BRANCH WITH DEPRESSOR X 1/4" ACCESS ON BOTH ENDS

Quick Seal Caps 640QSF



PART NO.	CONNECTION SIZE
640QSF-4	1/4" SAE SEAL CAP WITH SEAL GASKET
640QSF-6	3/8" SAE SEAL CAP WITH SEAL GASKET

Quick Seal Cap with Core Remover 640QSFCR



PART NO.	CONNECTION SIZE
640QSFCR-4	1/4" SAE SEAL CAP CORE REMOVER WITH INTERNAL SEAL GASKET

Core Remover CR



PART NO.	CONNECTION SIZE
CR-001	STANDARD CORE REMOVER

Valve Cores VC



PART NO.	CONNECTION SIZE
VC-001	REPLACEMENT VALVE CORES FOR ALL 1/4" ACCESS VALVES

Refrigerant Adapter 88AC



PART NO.	CONNECTION SIZE
88AC-8-2	1/8" MALE PIPE TO SAE J2197 ACME THREADED MALE CONNECTOR

Refrigerant Adapter 880AC



PART NO.	CONNECTION SIZE
880AC-8-4	1/4" FEMALE SAE FLARE TO SAE J2197 ACME THREADED MALE CONNECTOR

Refrigerant Adapter 881AC



PART NO.	CONNECTION SIZE
881AC-8-4	1/4" SAE MALE FLARE TO SAE J2197 ACME THREADED FEMALE CONNECTOR

WARNING These products can expose you to chemicals including LEAD which is known to the state of California to cause cancer.



Industrial Barbed Fittings

Dubl-Barb[®] Fittings

Hose Barb Fittings



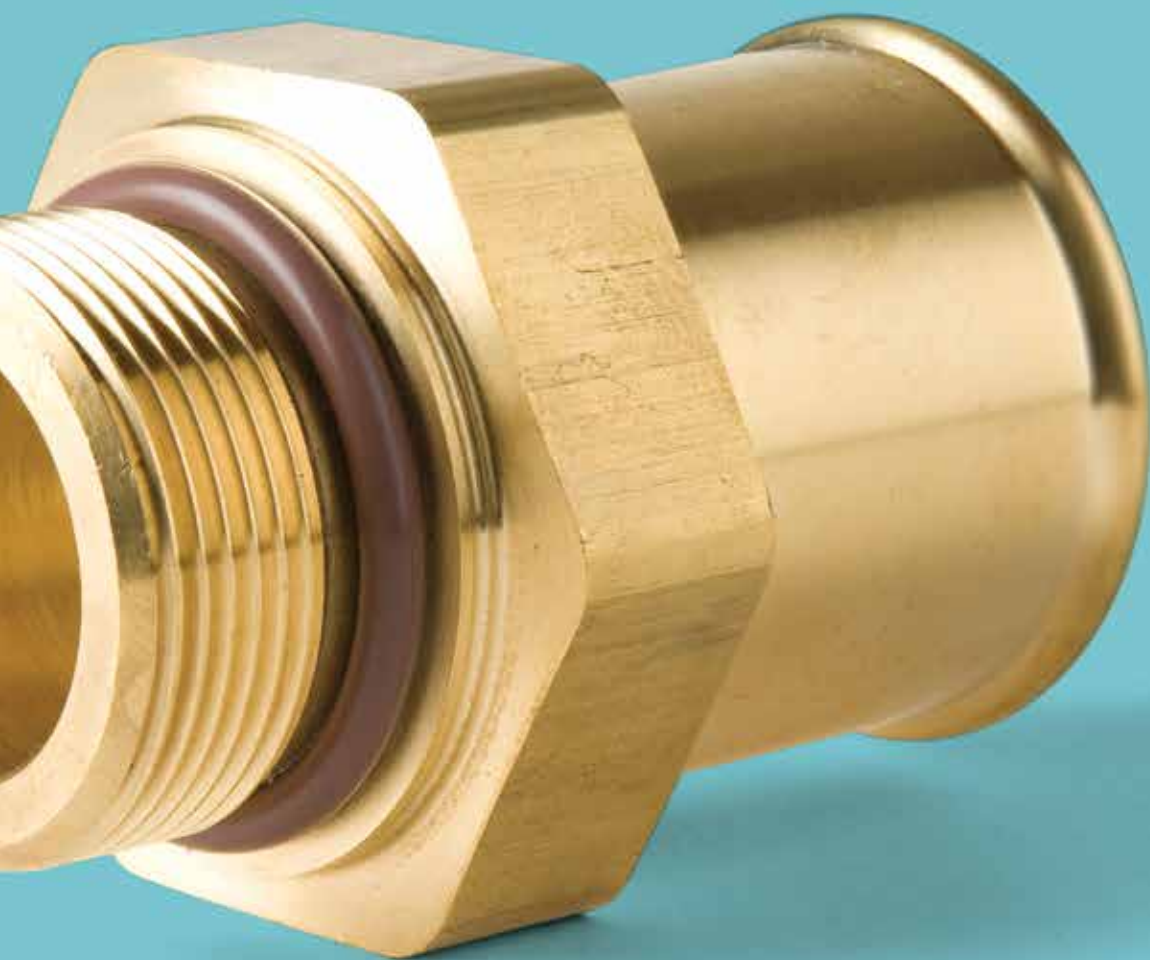

GOODYEAR
RUBBER PRODUCTS, INC.

+1.727.342.5087

También puede enviarnos un correo electrónico a
ventas@goodyearrubberproducts.com

Threaded Fittings

26
Female Connector
NPT
p. 16



27
Male Connector
p. 16



28
Male Connector
NPT
p. 16, 17



228
Gauge Tee
NPT
p. 17



229
Male Elbow
NPT
p. 17



230
Female Elbow
NPT
p. 18



231
Run Tee
NPT
p. 18



232
Branch Tee
NPT
p. 18



237
Female Tee
NPT
p. 18



68HB
Male Connector
NPT
p. 110



685HB
Male Connector
p. 110



68HB-X-MIX
Male Connector
p. 110



125HB
Male Connector
NPT
p. 110



125HBL
Male Connector
NPT
p. 110



125HBSLV
Swivel Connector
NPT
p. 111



126HBL
Female Connector
NPT
p. 111



127HB
Ball-End Adapter
NPT
p. 111



129HB
Male Elbow
NPT
p. 111



1295HB
Male Elbow
p. 111



139HB
45° Male Elbow
NPT
p. 112



1695HB
Male Elbow
p. 112



169HB-X-MIX
Male Elbow
p. 112



1725HB
Tee
p. 112



171HB
Run Tee
NPT
p. 112



179HB
45° Male Elbow
NPT
p. 112



1795HB
45° Male Elbow
p. 112



179HB-X-MIX
45° Male Elbow
p. 113



269HB
Male Elbow
p. 113



279HB
45° Male Elbow
p. 113



0123
Male Connector
BSPT
p. 113



0136
Metric Hose
to BSPT
p. 114



0191
Metric Hose
to BSPP
p. 114



0931
Metric Hose
to BSPP
p. 114



Barb to Barb

22
Union
p. 16



224
Union Tee
p. 17



225
Union Elbow
p. 17



122HBL
Union
p. 110



Bulkhead Unions

22BH
Bulkhead Union
p. 16



22CABH
Bulkhead Union
p. 16



Adapters

22CA
Mixed Union
p. 16



220
Adapter Tee
p. 17



238
Solder Connector
p. 18



Swivel

128HBSLV
Female Ball-End
p. 111



146HBLFSV
45° Female Flare
p. 112



Accessories

20
Plug
p. 16



97HC
Clamp
p. 110



WARNING These products can expose you to chemicals including NICKEL or LEAD, which are known to the state of California to cause cancer and LEAD.

Dubl-Barb® Fittings



Parker's Dubl-Barb Fittings are an economical one piece, push-on brass barbed fitting that does not require any type of clamp. These fittings are a quick way to connect polyethylene tubing.

Product Features:

- Compact
- One piece
- No clamp required
- Good vibration resistance

Markets:

- Pneumatic
- Environmental control

Applications:

- Pneumatic Systems
- Climate Control
- Humidifiers
- Filters

Compatible Tubing:

- Polyethylene



Specifications:

Pressure Range:

TUBE SIZE	PSI	bar	TUBE SIZE	PSI	bar
5/32	150	10.3	3/8	150	10.3
1/4	150	10.3	1/2	100	6.8

Temperature Range:

TUBE SIZE	TEMPERATURE IN FAHRENHEIT	TEMPERATURE IN CELSIUS
5/32	-65° to +90° F	-53.8° to +32.2° C
1/4	-65° to +90° F	-53.8° to +32.2° C
3/8	-65° to +90° F	-53.8° to +32.2° C
1/2	-65° to +75° F	-53.8° to +23.8° C

Assembly Instructions

Cut tube squarely and simply push tube over the two barbs



⚠ WARNING These products can expose you to chemicals including LEAD which is known to the state of California to cause cancer.

Plug 20

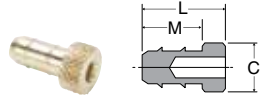

PART NO.	TUBE O.D.	TUBE I.D.	C DIA.	L	M
20-4	1/4	.170	.32	.56	.41
20-6	3/8	.250	.390	.68	.44
20-8	1/2	.377	.577	.81	.56

Plug Adapter 20

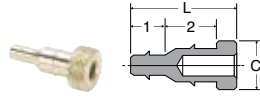

PART NO.	TUBE O.D. 1	TUBE I.D. 1	TUBE O.D. 2	TUBE I.D. 2	C DIA.	L
20-4-5/32	5/32	.096	1/4	.170	.32	.65

Union 22

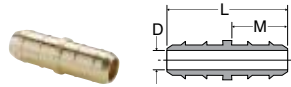

PART NO.	TUBE O.D.	TUBE I.D.	L	M	FLOW DIA. D
22-5/32	5/32X5/32	.096X.096	.59	.28	.062
22-4	1/4X1/4	.170X.170	.84	.41	.120
22-6	3/8X3/8	.250X.250	.94	.44	.187
22-8	1/2X1/2	.375X.375	1.19	.56	.312

Union Reducer 22

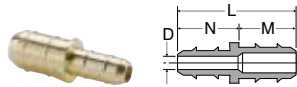

PART NO.	TUBE O.D.	TUBE I.D.	L	M	N	FLOW DIA. D
22-4-5/32	1/4X5/32	.170X.096	.72	.41	.28	.062
22-4-6	1/4X3/8	.170X.250	.88	.44	.41	.120
22-4-8	1/4X1/2	.170X.375	1.06	.56	.41	.120
22-6-8	3/8X1/2	.250X.375	1.06	.56	.44	.187

Bulkhead Union 22BH

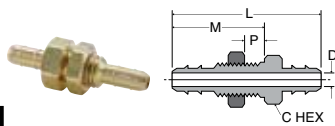

PART NO.	TUBE O.D.	TUBE I.D.	ST. THD.	C HEX	P MAX.	L	M	FLOW DIA. D	BLKHD HOLE DIA.
22BH-4-4	1/4	.170	5/16-24	7/16	.219	1.38	.78	.120	5/16
22BH-6-6	3/8	.250	3/8-24	7/16	.375	1.63	1.00	.187	3/8

Union 22CA

Tube to Compress-Align

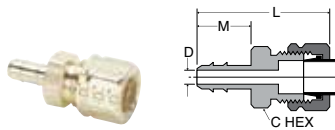

PART NO.	TUBE O.D.	TUBE I.D.	CA TUBE	C HEX	L	M	FLOW DIA. D
22CA-4-4	1/4	.170	1/4	7/16	1.15	.41	.120

Bulkhead Union 22CABH

Tube to Compress-Align

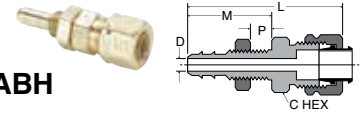

PART NO.	TUBE O.D.	TUBE I.D.	CA TUBE	ST. THD.	C HEX	P MAX	L	M	FLW DIA. D	BKHD HOLE DIA.
22CABH-4-4	1/4	.170	1/4	5/16-24	7/16	.219	1.53	.78	.120	5/16
22CABH-6-6	3/8	.250	3/8	3/8-24	9/16	.375	1.87	1.00	.187	3/8

Female Connector 26

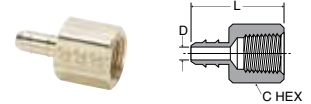

PART NO.	TUBE O.D.	TUBE I.D.	PIPE THREAD	C HEX	L	FLOW DIA. D
26-5/32-2	5/32	.096	1/8	1/2	.79	.062
26-4-2	1/4	.170	1/8	1/2	.91	.120
26-6-2	3/8	.250	1/8	1/2	.93	.187
26-6-4	3/8	.250	1/4	11/16	1.06	.187

Male Connector 27

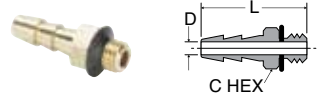

PART NO.	TUBE O.D.	TUBE I.D.	STRAIGHT THREAD	C HEX	L	FLOW DIA. D
27-1*	1/8	.062	10-32	1/4	.61	.052
27-2*	1/4	.125	10-32	1/4	.74	.093

*For vinyl tubing only.

Barb-to-Pipe Adapter 28

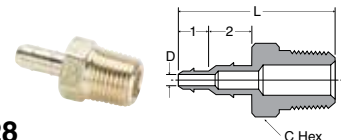

PART NO.	TUBE O.D. 1	TUBE I.D. 1	TUBE O.D. 2	TUBE I.D. 2	PIPE THD.	C HEX	L	FLOW DIA. D
28-4-5/32-2	5/32	.096	1/4	.170	1/8	7/16	1.07	.062

WARNING These products can expose you to chemicals including LEAD which is known to the state of California to cause cancer.

[Click here for CADs, Product Specifications or to Configure Parts Online](#)

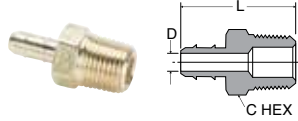

Male Connector 28

PART NO.	TUBE O.D.	TUBE I.D.	PIPE THREAD	C HEX	L	FLOW DIA. D
28-5/32-2	5/32	.096	1/8	7/16	.84	.062
28-4-1	1/4	.170	1/16	3/8	.93	.120
28-4-2	1/4	.170	1/8	7/16	.97	.120
28-4-4	1/4	.170	1/4	9/16	1.09	.120
28-4-10X32*	1/4	.170	10-32	1/4	.71	.093
28-6-2	3/8	.250	1/8	7/16	1.00	.187
28-6-4	3/8	.250	1/4	9/16	1.13	.187
28-8-4	1/2	.375	1/4	9/16	1.25	.312
28-8-6	1/2	.375	3/8	11/16	1.28	.312
28-8-8	1/2	.375	1/2	7/8	1.44	.312

*Straight thread

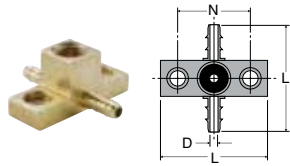

Adapter Tee 220

PART NO.	TUBE O.D.	TUBE I.D.	PIPE THREAD	L	N	FLOW DIA. D
220-4-2	1/4	.170	1/8	1.50	1.00	.120

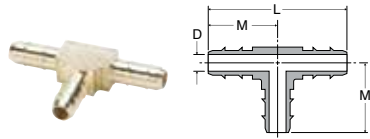

Union Tee 224

PART NO.	TUBE O.D.	TUBE I.D.	L	M	FLOW DIA. D
224-5/32	5/32	.096	1.00	.50	.062
224-4	1/4	.170	1.25	.63	.120
224-6	3/8	.250	1.38	.69	.187
224-8	1/2	.375	1.63	.81	.312

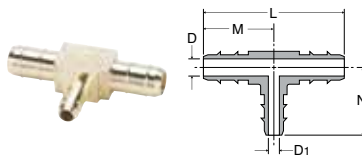

Union Tee 224 Combination Sizes

PART NO.	TUBE O.D.	TUBE I.D.	L	M	N	FLOW DIA. D	FLOW DIA. D1
224-4-4-5/32	1/4X5/32	.170X.096	1.25	.63	.50	.120	.062
224-6-6-5/32	3/8X5/32	.250X.096	1.38	.69	.50	.187	.062
224-6-6-4	3/8X1/4	.250X.170	1.38	.69	.62	.187	.120
224-8-8-4	1/2X1/4	.375X.170	1.62	.81	.65	.312	.120
224-8-8-6	1/2X3/8	.375X.250	1.62	.81	.69	.312	.187

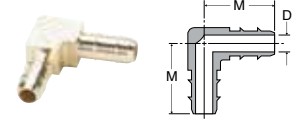

Union Elbow 225

PART NO.	TUBE O.D.	TUBE I.D.	M	FLOW DIA. D
225-5/32	5/32	.096	.50	.062
225-4-4	1/4	.170	.63	.120
225-6-6	3/8	.250	.63	.187
225-8-8	1/2	.375	.81	.312

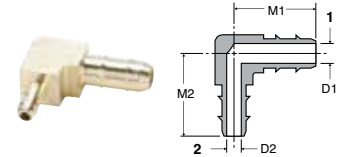

Union Elbow 225 Combination Size

PART NO.	TUBE O.D. 1	TUBE O.D. 2	TUBE I.D. 1	TUBE I.D. 2	M1	M2	FLOW DIA. D1	FLOW DIA. D2
225-4-5/32	1/4	5/32	.170	.096	.63	.50	.120	.062

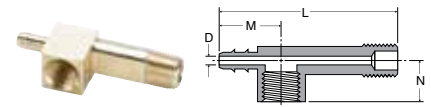

Gauge Tee 228

PART NO.	TUBE O.D.	TUBE I.D.	PIPE THREAD	L	M	N	FLOW DIA. D
228-4-2	1/4	.170	1/8	1.91	.66	.44	.120

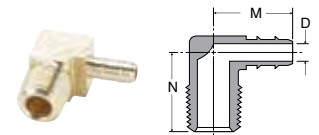

Male Elbow 229

PART NO.	TUBE O.D.	TUBE I.D.	PIPE THREAD	M	N	FLOW DIA. D
229-5/32-2	5/32	.096	1/8	.56	.63	.062
229-4-1	1/4	.170	1/16	.62	.60	.120
229-4-2	1/4	.170	1/8	.69	.63	.120
229-4-4	1/4	.170	1/4	.72	.72	.120
229-6-2	3/8	.250	1/8	.69	.69	.187
229-6-4	3/8	.250	1/4	.75	.75	.187
229-8-4	1/2	.375	1/4	.94	.74	.312
229-8-6	1/2	.375	3/8	.94	.81	.312

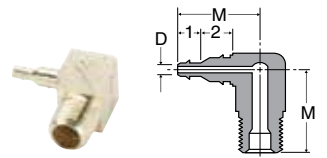

90° Elbow Barb Adapter 229

PART NO.	TUBE O.D. 1	TUBE I.D. 1	TUBE O.D. 2	TUBE I.D. 2	PIPE THREAD	M	FLOW DIA. D
229-4-5/32-2	5/32	.096	1/4	.170	1/8	.78	.062

WARNING These products can expose you to chemicals including LEAD which is known to the state of California to cause cancer.

Click here for CADs, Product Specifications or to Configure Parts Online

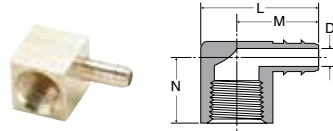

Female Elbow 230

PART NO.	TUBE O.D.	TUBE I.D.	PIPE THREAD	L	M	N	FLOW DIA. D
230-4-2	1/4	.170	1/8	.91	.66	.44	.120
230-6-4	3/8	.250	1/4	1.12	.78	.63	.187

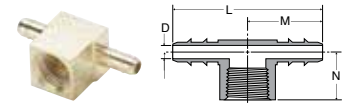

Female Branch Tee 237

PART NO.	TUBE O.D.	TUBE I.D.	PIPE THREAD	L	M	N	FLOW DIA. D
237-5/32-2	5/32	.096	1/8	1.06	.53	.44	.062
237-4-2	1/4	.170	1/8	1.34	.67	.49	.120

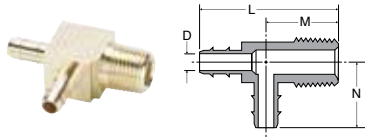

Male Run Tee 231

PART NO.	TUBE O.D.	TUBE I.D.	PIPE THREAD	L	M	N	FLOW DIA. D
231-4-2	1/4	.170	1/8	1.28	.66	.69	.120
231-6-2	3/8	.250	1/8	1.38	.69	.69	.187
231-6-4	3/8	.250	1/4	1.44	.75	.75	.187

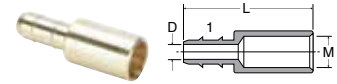

Solder Connector 238

PART NO.	TUBE O.D. 1	TUBE I.D. 1	L	M	FLOW DIA. D
238-4-4	1/4	.170	.91	.25	.120

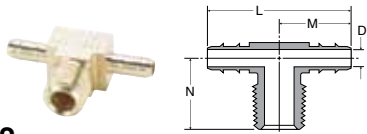

Male Branch Tee 232

PART NO.	TUBE O.D.	TUBE I.D.	PIPE THREAD	L	M	N	FLOW DIA. D
232-4-1	1/4	.170	1/16	1.33	.66	.65	.120
232-4-2	1/4	.170	1/8	1.38	.69	.66	.120
232-6-2	3/8	.250	1/8	1.38	.69	.69	.187
232-6-4	3/8	.250	1/4	1.50	.75	.75	.187

WARNING These products can expose you to chemicals including LEAD which is known to the state of California to cause cancer.

Hose Barb Fittings



Parker's Hose Barb Fittings are an economical choice for general purpose fluid handling and pneumatics. Manufactured in both regular hose barb and beaded hose barb styles. Fittings are intended for use with 97HC hose clamps, similar type clamp or a crimped ferrule.

Product Features:

- All brass construction
- Fluorocarbon O-rings
- NPTF, SAE straight thread, metric thread ends
- Reusable
- Clamp required

Applications:

- Air Lines
- Water Line
- Cooling Lines

Compatible Tubing:

- Rubber Hose
- GPH Hose

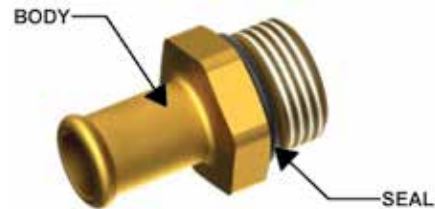

Markets:

- Industrial
- Construction
- Heavy duty truck
- Mobile

Specifications:

Pressure Range Up to 150 PSI (10.3 bar)

Temperature Range -40° to +160° F (-40° to +71.1° C)

Assembly Instructions

1. Cut hose cleanly and squarely to length.
2. Slide clamp on hose.
3. Lubricate hose. Push hose on fitting until bottomed against stop ring or hex.
4. Position hose clamp as shown and secure with a screwdriver or wrench. Maintain "A" dimension for proper clamp positioning.



HOSE SIZE	HOSE CLAMP	A
3/16	97 HC-3	1/4
1/4	97 HC-3	1/4
5/16	97 HC-6	1/4
3/8	97 HC-6	1/8
1/2	97 HC-8	1/8
5/8	97 HC-12	1/8
3/4	97 HC-12	1/8

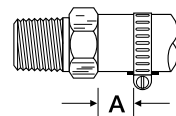

⚠ WARNING These products can expose you to chemicals including NICKEL or LEAD, which are known to the state of California to cause cancer and LEAD.

Beaded Hose Barb to Male Pipe 68HB

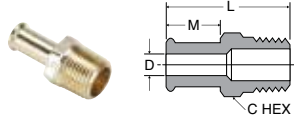

PART NO.	I.D. HOSE SIZE	PIPE THREAD	C HEX	L	M	FLOW DIA. D
68HB-6-6	3/8	3/8	11/16	1.53	.78	.281
68HB-8-4	1/2	1/4	5/8	1.56	.78	.375
68HB-8-6	1/2	3/8	11/16	1.53	.78	.406
68HB-8-8	1/2	1/2	7/8	1.84	.78	.406
68HB-10-6	5/8	3/8	3/4	1.62	.88	.501
68HB-10-8	5/8	1/2	7/8	1.92	.88	.501
68HB-12-8	3/4	1/2	7/8	1.98	.88	.564
68HB-12-12	3/4	3/4	1 1/16	2.04	.97	.625
68HB-16-12	1	3/4	1 1/8	2.12	1.00	.750
68HB-16-16	1	1	1.38	2.31	1.00	.812

Beaded Hose Barb to SAE Straight Thread 685HB

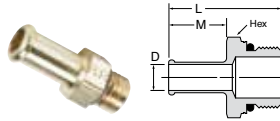

PART NO.	I.D. HOSE SIZE	STRAIGHT THREAD	C HEX	L	M	FLOW DIA. D
685HB-4-4	1/4	7/16-20	9/16	1.40	.78	.18
685HB-6-4	3/8	7/16-20	9/16	1.39	.78	.18
685HB-8-8	1/2	3/4-16	7/8	1.48	.78	.40
685HB-10-8	5/8	3/4-16	7/8	1.56	.78	.40
685HB-12-8	3/4	3/4-16	7/8	1.75	.97	.40
685HB-12-12	3/4	1 1/16-12	1 1/4	1.82	.97	.62
685HB-16-8	1	3/4-16	1 1/8	1.79	.97	.40
685HB-16-12	1	1 1/16-12	1 1/4	1.99	.97	.62

Note: Fluorocarbon o-ring is standard

Hose Barb to Metric Adaptor 68HB-X-MIX

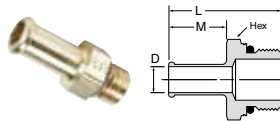

PART NUMBER	I.D. HOSE SIZE	METRIC THREAD	HEX	L	M	D
68HB-6-MI12	3/8	M12 X 1.5	11/16	1.50	.78	.24
68HB-6-MI14	3/8	M14 1.5	3/4	1.51	.78	.29
68HB-8-MI12	1/2	M12 X 1.5	11/16	1.50	.78	.24

Note: Fluorocarbon o-ring is standard

Stainless Steel Worm Drive Clamp 97HC

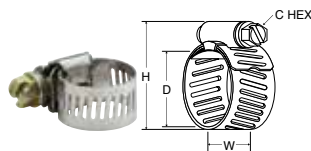

PART NO.	D MAX.	D MIN.	C HEX	H MAX.	W
97HC-3	.62	.25	.25	1.00	.31
97HC-6	.87	.38	.31	1.40	.50
97HC-8	1.00	.44	.31	1.53	.50
97HC-12	1.25	.50	.31	1.80	.50

Hose Mender 122HBL

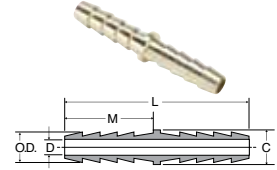

PART NO.	I.D. HOSE SIZE	C DIA.	L	M	O.D.	FLOW DIA. D
122HB-3	3/16	5/16	1.44	.69	.227	.125
122HBL-4	1/4	3/8	2.00	.97	.290	.187
122HBL-5	5/16	7/16	2.00	.97	.353	.250
122HBL-6	3/8	1/2	2.00	.97	.415	.281
122HBL-8	1/2	5/8	2.00	.97	.530	.375
122HBL-12	3/4	7/8	2.00	.97	.790	.562

Hose Barb to Male Pipe 125HB

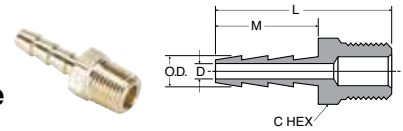

PART NO.	I.D. HOSE SIZE	PIPE THREAD	C HEX	L	M	O.D.	FLOW DIA. D
125HB-2-2	1/8	1/8	7/16	1.07	.50	.185	.093
125HB-3-2	3/16	1/8	7/16	1.25	.69	.227	.125
125HB-3-4	3/16	1/4	9/16	1.44	.69	.227	.125

Hose Barb to Male Pipe 125HBL

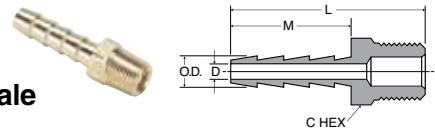

PART NO.	I.D. HOSE SIZE	PIPE THREAD	C HEX	L	M	O.D.	FLOW DIA. D
125HBL-4-2	1/4	1/8	7/16	1.54	.97	.290	.187
125HBL-4-4	1/4	1/4	9/16	1.72	.97	.290	.187
125HBL-4-6	1/4	3/8	11/16	1.77	.97	.290	.187
125HBL-5-2	5/16	1/8	7/16	1.54	.97	.353	.250
125HBL-5-4	5/16	1/4	9/16	1.72	.97	.353	.250
125HBL-5-6	5/16	3/8	11/16	1.77	.97	.353	.250
125HBL-6-2	3/8	1/8	7/16	1.54	.97	.415	.281
125HBL-6-4	3/8	1/4	9/16	1.72	.97	.415	.281
125HBL-6-6	3/8	3/8	11/16	1.77	.97	.415	.281
125HBL-6-8	3/8	1/2	7/8	1.97	.97	.415	.281
125HBL-8-4	1/2	1/4	9/16	1.72	.97	.530	.375
125HBL-8-6	1/2	3/8	11/16	1.77	.97	.530	.375
125HBL-8-8	1/2	1/2	7/8	1.97	.97	.530	.375
125HBL-8-12	1/2	3/4	1-1/16	1.98	.97	.530	.375
125HBL-10-6	5/8	3/8	11/16	1.77	.97	.645	.468
125HBL-10-8	5/8	1/2	7/8	1.97	.97	.645	.468
125HBL-10-12	5/8	3/4	1-1/16	1.98	.97	.645	.468
125HBL-12-8	3/4	1/2	7/8	1.97	.97	.790	.562
125HBL-12-12	3/4	3/4	1-1/16	1.98	.97	.790	.562
125HBL-16-12	1	3/4	1-1/16	2.18	1.17	1.02	.750
125HBL-16-16	1	1	1-3/8	2.36	1.17	1.02	.875

WARNING These products can expose you to chemicals including NICKEL or LEAD, which are known to the state of California to cause cancer and LEAD.

[Click here for CADs, Product Specifications or to Configure Parts Online](#)

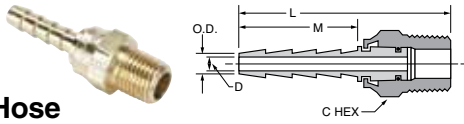

Male Swivel Hose Barb 125HBLSV

PART NO.	I.D. HOSE SIZE	PIPE THREAD	C HEX	L	M	O.D.	FLOW DIA. D
125HBLSV-4-4	1/4	1/4	11/16	2.14	.97	.290	.187
125HBLSV-6-4	3/8	1/4	11/16	2.14	.97	.415	.250
125HBLSV-6-6	3/8	3/8	11/16	2.14	.97	.415	.250
125HBLSV-8-8	1/2	1/2	7/8	2.48	.97	.530	.375

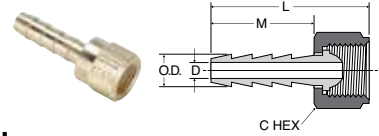

Hose Barb to Swivel Female Ball-End 128HBLSV

PART NO.	I.D. HOSE SIZE	FEMALE N.P.S.M. THREAD	C HEX	L	M	O.D.	FLOW DIA. D
128HBLSV-4-4	1/4	1/4	5/8	1.50	.97	.290	.187
128HBLSV-5-4	5/16	1/4	5/8	1.50	.97	.353	.250
128HBLSV-6-4	3/8	1/4	5/8	1.63	.97	.415	.250
128HBLSV-6-6	3/8	3/8	3/4	1.50	.97	.415	.281
128HBLSV-8-8	1/2	1/2	29/32	1.52	.97	.530	.375

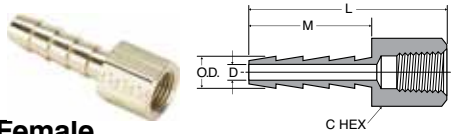

Hose Barb to Female Pipe 126HBL

PART NO.	I.D. HOSE SIZE	PIPE THREAD	C HEX	L	M	O.D.	FLOW DIA. D
126HBL-4-2	1/4	1/8	1/2	1.47	.97	.290	.187
126HBL-4-4	1/4	1/4	11/16	1.66	.97	.290	.187
126HBL-5-4	5/16	1/4	11/16	1.58	.97	.353	.250
126HBL-6-2	3/8	1/8	1/2	1.47	.97	.415	.281
126HBL-6-4	3/8	1/4	11/16	1.66	.97	.415	.281
126HBL-6-6	3/8	3/8	13/16	1.69	.97	.415	.281
126HBL-8-6	1/2	3/8	13/16	1.69	.97	.530	.375
126HBL-8-8	1/2	1/2	1	1.73	.97	.530	.375
126HBL-12-12	3/4	3/4	1-1/4	1.92	.97	.790	.562

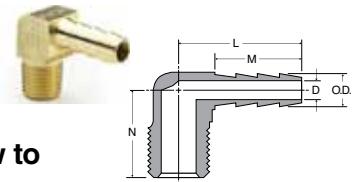

Hose Barb 90° Elbow to Male Pipe 129HB

PART NO.	I.D. HOSE SIZE	PIPE THREAD	L	M	N	O.D.	FLOW DIA. D
129HB-3-2	3/16	1/8	.97	.69	.66	.227	.173
129HB-4-2	1/4	1/8	1.04	.76	.66	.290	.187
129HB-4-4	1/4	1/4	1.06	.76	.82	.290	.187
129HB-4-6	1/4	3/8	1.19	.76	.84	.290	.187
129HB-5-2	5/16	1/8	1.06	.76	.66	.353	.234
129HB-5-4	5/16	1/4	1.12	.76	.84	.353	.234
129HB-5-6	5/16	3/8	1.19	.76	.84	.353	.234
129HB-6-2	3/8	1/8	1.32	.97	.75	.415	.219
129HB-6-4	3/8	1/4	1.32	.97	.94	.415	.281
129HB-6-6	3/8	3/8	1.50	.97	1.06	.415	.281
129HB-6-8	3/8	1/2	1.52	.97	1.25	.415	.281
129HB-8-4	1/2	1/4	1.53	.97	1.06	.530	.375
129HB-8-6	1/2	3/8	1.53	.97	1.06	.530	.375
129HB-8-8	1/2	1/2	1.53	.97	1.25	.530	.375
129HB-12-12	3/4	3/4	1.33	.79	1.27	.790	.562

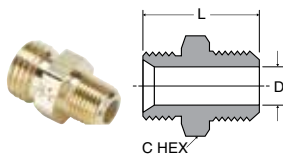

Ball-End Joint Adapter to Male Pipe 127HB

For use with 128HBLSV

PART NO.	MALE N.P.S.M. THREAD	MALE N.P.T. THREAD	C HEX	L	FLOW DIA. D
127HB-4-2	1/4	1/8	9/16	.91	.219
127HB-4-4	1/4	1/4	9/16	1.10	.281
127HB-6-4	3/8	1/4	11/16	1.10	.312
127HB-6-6	3/8	3/8	11/16	1.15	.406
127HB-8-6	1/2	3/8	7/8	1.25	.406
127HB-8-8	1/2	1/2	7/8	1.50	.531

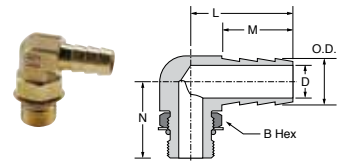

Hose Barb Elbow to SAE Straight Thread 1295HB

PART NO.	I.D. HOSE SIZE	STRAIGHT THREAD	B HEX	L	M	N	O.D.	FLOW DIA. D
1295HB-6-6	3/8	9/16-18	11/16	1.10	.76	1.10	.42	.280

Note: Fluorocarbon o-ring is standard

WARNING: These products can expose you to chemicals including NICKEL or LEAD, which are known to the state of California to cause cancer and LEAD.

Hose Barb 45° Elbow to Male Pipe 139HB

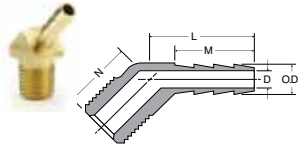

PART NO.	I.D. HOSE SIZE	PIPE THREAD	L	M	N	O.D.	FLOW DIA. D
139HB-4-2	1/4	1/8	.91	.76	.68	.290	.187
139HB-4-4	1/4	1/4	1.00	.76	.68	.290	.187
139HB-6-4	3/8	1/4	1.00	.76	.68	.415	.281

Hose Barb Tee to SAE Straight Thread 1725HB

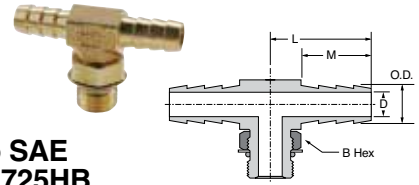

PART NO.	I.D. HOSE SIZE	STRAIGHT THREAD	B HEX	L	M	O.D.	FLOW DIA. D
1725HB-6-6	3/8	9/16-18	11/16	1.10	.76	.420	.280

Note: Fluorocarbon o-ring is standard

Hose Barb to Swivel 45° Female Flare 146HBLFSV

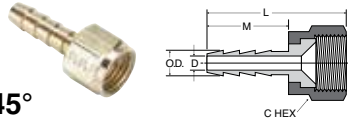

PART NO.	I.D. HOSE SIZE	STRAIGHT THREAD	C HEX	L	M	O.D.	FLOW DIA. D
146HBLFSV-4-4	1/4	7/16-20	9/16	1.55	.97	.290	.187
146HBLFSV-4-6	1/4	5/8-18	3/4	1.72	.97	.290	.187
146HBLFSV-6-6	3/8	5/8-18	3/4	1.72	.97	.415	.281

Hose Barb Tee to Male Pipe 171HB

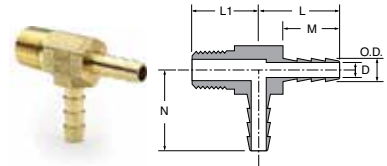

PART NO.	I.D. HOSE SIZE	PIPE THREAD	L	L1	M	N	O.D.	FLOW DIA. D
171HB-4-4	1/4	1/4	1.10	.85	.76	1.10	.290	.187

Beaded Hose Barb Elbow to SAE Straight Thread 1695HB

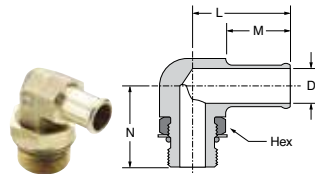

PART NUMBER	HOSE SIZE	STRAIGHT THREAD	HEX	L	M	N	D
1695HB-6-4	3/8	7/16-20	9/16	1.09	.78	1.10	.18
1695HB-8-6	1/2	9/16-18	9/16	1.10	.78	1.11	.30
1695HB-8-8	1/2	3/4-16	7/8	1.28	.78	1.42	.40
1695HB-10-8	5/8	3/4-16	7/8	1.47	.88	1.47	.40
1695HB-10-10	5/8	7/8-14	1	1.41	.88	1.60	.50
1695HB-12-8	3/4	3/4-16	7/8	1.47	.97	1.47	.40
1695HB-12-10	3/4	7/8-14	1	1.60	.97	1.62	.50
1695HB-12-12	3/4	1 1/16-12	1	1.60	.97	1.64	.62
1695HB-16-12	1	1 1/16-12	1 1/4	1.60	.97	1.75	.60

Note: Fluorocarbon o-ring is standard

Beaded Hose Barb 45° Elbow Tube to Male Pipe 179HB

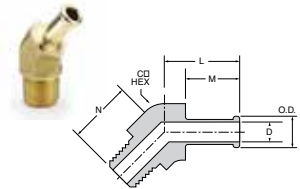

PART NO.	I.D. HOSE SIZE	NPTF THREAD	C HEX	L	M	N	O.D.	FLOW DIA. D
179HB-6-4	3/8	1/4-18	.75	1.09	.78	.93	.45	.28
179HB-6-6	3/8	3/8-18	.75	1.09	.78	.93	.45	.28
179HB-10-8	5/8	1/2-14	.81	1.19	.78	1.13	.70	.50
179HB-12-8	3/4	1/2-14	.81	1.19	.78	1.13	.83	.56

Beaded Hose Barb 45° Elbow Tube to Straight Thread 1795HB

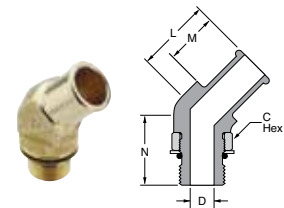

PART NO.	I.D. HOSE SIZE	STRAIGHT THREAD	C HEX	L	M	N	FLOW DIA. D
1795HB-8-8	1/2	3/4-16	7/8	1.12	.78	1.16	.400
1795HB-10-8	5/8	3/4-16	7/8	1.22	.88	1.16	.398
1795HB-12-8	3/4	3/4-16	7/8	1.22	.88	1.16	.398
1795HB-12-12	3/4	1 1/16-12	1 1/4	1.35	.97	1.65	.620
1795HB-16-12	1	1 1/16-12	1 1/4	1.38	.97	1.47	.620

Note: Fluorocarbon o-ring is standard

Beaded Elbow to Metric Adaptor 169HB-X-MIX

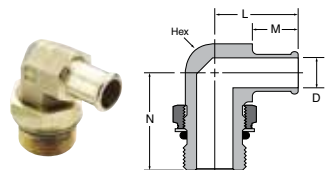

PART NUMBER	HOSE SIZE	METRIC THREAD	HEX	L	M	N	D
169HB-10-MI27	5/8	M27 X 2.0	7/8	1.41	.78	1.63	.50
169HB-16-MI27	1	M27 X 2.0	1	1.67	.97	1.68	.71
169HB-16-MI33	1	M33 X 2.0	1 5/16	1.75	.97	1.90	.84

Note: Fluorocarbon o-ring is standard

⚠️ WARNING These products can expose you to chemicals including NICKEL or LEAD, which are known to the state of California to cause cancer, and LEAD.

[Click here for CADs, Product Specifications or to Configure Parts Online](#)

Beaded Hose Barb 45° Elbow to Metric Thread 179HB-X-MIX

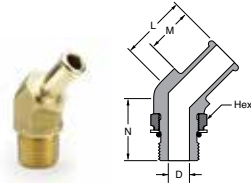

PART NUMBER	HOSE SIZE	METRIC THREAD	HEX	L	M	N	D
179HB-12-MI18	3/4	M18 X 1.5	13/16	1.15	.78	1.16	.44
179HB-16-MI27	1	M27 X 2.0	1 1/16	1.51	.97	1.71	.71

Note: Fluorocarbon o-ring is standard

Beaded Hose Barb 90° Elbow Tube to Male Pipe 269HB

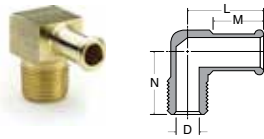

PART NO.	I.D. HOSE SIZE	PIPE THREAD	L	M	N	FLOW DIA. D
269HB-6-6	3/8	3/8	1.19	.78	.88	.281
269HB-8-4	1/2	1/4	1.16	.78	.99	.310
269HB-8-6	1/2	3/8	1.16	.78	1.08	.406
269HB-8-8	1/2	1/2	1.28	.78	1.25	.406
269HB-10-4	5/8	1/4	1.13	.78	.99	.312
269HB-10-6	5/8	3/8	1.16	.78	.99	.406
269HB-10-8	5/8	1/2	1.28	.78	1.25	.501
269HB-12-8	3/4	1/2	1.28	.78	1.25	.563
269HB-12-12	3/4	3/4	1.33	.78	1.27	.625

Beaded Hose Barb 45° Elbow Tube to Male Pipe 279HB

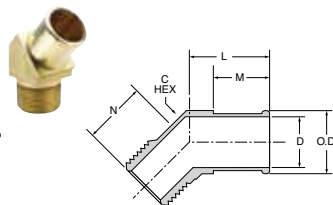

PART NO.	I.D. HOSE SIZE	NPTF THREAD	C HEX	L	M	N	O.D.	FLOW DIA. D
279HB-16-12	1	3/4-14	1.12	1.38	.97	1.13	1.06	.720

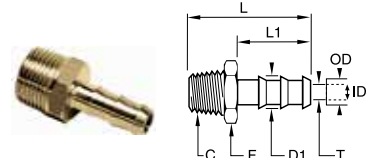

0123 Barbed Adapter for Rubber Hose BSPT

PART NO.	D MM	C BSPT	D1 MM	F MM	L MM	L1 MM	T MIN MM	WT. KG
0123 04 10	4	R1/8	6	10	34	22.5	3.3	.008
0123 06 10	6	R1/8	8	10	34	22.5	5	.009
0123 07 10	7	R1/8	9	10	34	22.5	5	.009
0123 07 13	7	R1/4	9	14	38.5	22.5	6	.018
0123 07 17	7	R3/8	9	17	39	22.5	6	.023
0123 10 10	10	R1/8	12.2	13	34	22.5	5	.014
0123 10 13	10	R1/4	12.2	14	38.5	22.5	7	.021
0123 10 17	10	R3/8	12.2	17	39	22.5	9.5	.023
0123 12 17	12	R3/8	14	17	46	29.5	11	.026
0123 13 13	13	R1/4	15	17	45.5	29.5	7	.027
0123 13 17	13	R3/8	15	17	46	29.5	11	.027
0123 13 21	13	R1/2	15	22	50.5	29.5	12	.047
0123 16 17	16	R3/8	18.5	19	54.5	38	11	.040
0123 16 21	16	R1/2	18.5	22	59	38	14	.056
0123 16 27	16	R3/4	18.5	27	62	38	15	.082
0123 19 17	19	R3/8	21.5	22	54.5	38	11	.046
0123 19 21	19	R1/2	21.5	22	59	38	14	.058
0123 19 27	19	R3/4	21.5	27	62	38	18	.083
0123 25 27	25	R3/4	26.7	27	62	38	18	.083
0123 25 34	25	R1	27	36	65	38	24	.124
0123 32 34	32	R1	34.5	36	70	43	24	.144

WARNING: These products can expose you to chemicals including NICKEL or LEAD, which are known to the state of California to cause cancer and LEAD.

[Click here for CADs, Product Specifications or to Configure Parts Online](#)

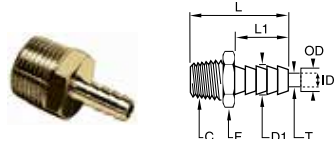

0136 Barbed Adapter for Nylon Tube BSPT

PART NO.	D MM	C BSPT	D1 MM	F MM	L MM	L1 MM	T MIN MM	WT. KG
0136 06 10	6	R1/8	6.4	10	26.5	15	4	.007
0136 06 13	6	R1/4	6.4	14	31	15	4	.015
0136 06 17	6	R3/8	6.4	17	31.5	15	4	.020
0136 08 13	8	R1/4	8.4	14	31	15	6	.016
0136 08 17	8	R3/8	8.4	17	31.5	15	6	.020
0136 08 21	8	R1/2	8.4	22	36	15	6	.039
0136 10 13	10	R1/4	10.7	14	36	20	7	.019
0136 10 17	10	R3/8	10.7	17	36.5	20	8	.023
0136 10 21	10	R1/2	10.7	22	41	20	8	.040
0136 12 13	12	R1/4	12.7	14	36	20	7	.019
0136 12 17	12	R3/8	12.7	17	36.5	20	10	.023
0136 12 21	12	R1/2	12.7	22	41	20	10	.042
0136 12 27	12	R3/4	12.7	27	44	20	10	.072
0136 13 17	13	R3/8	13.7	17	36.5	20	11	.023
0136 13 21	13	R1/2	13.7	22	41	20	11	.041
0136 13 27	13	R3/4	13.7	27	44	20	11	.071

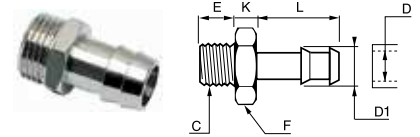

0931 Nickel Plated Hose to Male BSPP

PART NO.	D MM	C BSPP	D1 MM	E MM	F MM	K MM	L MM	WT. KG
0931 06 10	6	G1/8	7	6	12	4	20	0.008
0931 06 13	6	G1/4	7	8	14	5	20	0.013
0931 07 10	7	G1/8	8	6	12	4	20	0.009
0931 07 13	7	G1/4	8	8	14	5	20	0.017
0931 07 17	7	G3/8	8	9	19	5	20	0.022
0931 08 10	8	G1/8	9	6	12	4	20	0.009
0931 08 13	8	G1/4	9	8	14	5	20	0.014
0931 08 17	8	G3/8	9	9	19	5	20	0.022
0931 10 13	10	G1/4	12	8	14	5	20	0.016
0931 10 17	10	G3/8	12	9	19	5	20	0.023
0931 10 21	10	G1/2	12	10	22	6	22	0.032
0931 15 17	15	G3/8	17	9	19	6	24	0.030
0931 15 21	15	G1/2	17	10	22	6	24	0.036
0931 18 21	18	G1/2	20	10	22	6	24	0.043

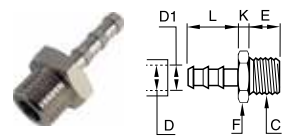

0191 Nickel Plated Hose to Male BSPP

PART NO.	D MM	C BSPP	D1 MM	E MM	F MM	K MM	L MM	WT. KG
0191 04 13	4	G1/4	6	9.5	17	5	22.5	.019
0191 07 13	7	G1/4	9	9.5	17	5	22.5	.021
0191 07 21	7	G1/2	9	11	27	7	29.5	.065
0191 10 13	10	G1/4	12.2	9.5	17	5	22.5	.021
0191 10 21	10	G1/2	12.2	11	27	7	29.5	.060
0191 13 13	13	G1/4	15.2	9.5	17	5	22.5	.023
0191 13 21	13	G1/2	15.2	11	27	7	29.5	.058
0191 16 21	16	G1/2	18.5	11	27	7	36.5	.069

WARNING These products can expose you to chemicals including NICKEL or LEAD, which are known to the state of California to cause cancer and LEAD.



Industrial Adapters

Pipe Fittings

Metric Adapters

Nickel Plated Metric Adapters

ISO Port Adapters

Garden Hose Fittings





GOODYEAR
RUBBER PRODUCTS, INC.

+1.727.342.5087

También puede enviarnos un correo electrónico a ventas@goodyearrubberproducts.com

Male to Male

215PN

Close Nipple
Pipe to Pipe
p. J9



215PNL

Long Nipple
Pipe to Pipe
p. J9



216P

Hex Nipple
Pipe to Pipe
p. J10



1204P

Male Elbow
Pipe to Pipe
p. J11



0152

Union Elbow
BSPT to BSPT
p. J14



0121

Hex Nipple
NPT to BSPT
p. J15



0929

3 Piece Adapter
BSPT to BSPT
p. J15



0914/0922

Union Elbow
BSPT to BSPT
p. J17



0927

Union Tee
BSPT to BSPT
p. J18



0900

Hex Nipple
BSPT to BSPT
p. J19



0901

Hex Nipple
BSPP to BSPP
p. J20



0192

Hex Nipple
BSPT to BSPP
p. J20



Male to Female

209P

Bushing
Pipe to Pipe
p. J8



222P

Adapter
Pipe to Pipe
p. J10



1202P-2202P

Street Elbow
Pipe to Pipe
p. J11



2224P

Male Branch Tee
Pipe to Pipe
p. J11



2225P

Street Tee
Pipe to Pipe
p. J11



2214P

45° Street Elbow
Pipe to Pipe
p. J12



F3HG

Adapter - Male
BSPT to NPT
p. J14



0164

Female BSPP
NPT to BSPP
p. J14



0144

Street Elbow
BSPT to BSPP
p. J14



0158

Male Branch Tee
BSPT to BSPP
p. J15



0163

Bushing
BSPT to BSPP
p. J16



0169

Adapter
BSPP to BSPP
p. J16



0913/0921

Street Elbow
BSPT to BSPP
p. J17



0911

Y Connector
BSPT to BSPP
p. J17



0916/0923

Male Branch Tee
BSPT to BSPP
p. J18



0917/0924

Male Run Tee
BSPT to BSPP
p. J18



0928

Female Branch Tee
BSPT to BSPP
p. J18



0909

Cross
BSPT to BSPP
p. J18



0903

Adapter Reducer
BSPP to BSPP
p. J18



0904

Bushing
BSPT to BSPP
p. J19



0905

Bushing
BSPP to BSPP
p. J19



0906

Adapter
BSPP to BSPP
p. J19



0907

Extended Adapter
BSPP to BSPP
p. J19



WARNING These products can expose you to chemicals including CARBON BLACK or LEAD, which are known to the state of California to cause cancer.

Female to Female

207ACBH

Anchor Coupling
Pipe to Pipe
p. J8



207ACBH-S

Sealed Bulkhead
p. J8



207P

Coupling
Pipe to Pipe
p. J8



208P

Reducer Coupling
Pipe to Pipe
p. J8



212P

Union
Pipe to Pipe
p. J9



1200P-2200P

Union Elbow
Pipe to Pipe
p. J10



1203P-2203P

Union Tee
Pipe to Pipe
p. J11



2200PDE

Drop-Ear Elbow
Pipe to Pipe
p. J12



1201-2201P

45° Female Elbow
Pipe to Pipe
p. J12



2205P

Cross
Pipe to Pipe
p. J12



0143

Union Elbow
BSPP to BSPP
p. J14



0145

Union Tee
BSPP to BSPP
p. J14



0117

Bulkhead
BSPP to BSPP
p. J15



0155

Coupling
BSPP to BSPP
p. J16



0168

Adapter
BSPP to BSPP
p. J16



0912

Union Elbow
BSPP to BSPP
p. J17



0910

Union Y
BSPP to BSPP
p. J17



0915

Union Tee
BSPP to BSPP
p. J17



0908

Cross
BSPP to BSPP
p. J18



0920

Bulkhead
BSPP to BSPP
p. J19



0902

Coupling
BSPP to BSPP
p. J20



Threaded Fittings (ISO Port Adapters)

222P-X-MIX

Adapter
p. J14, J24



48F-X-MIX

Male Connector
p. J24



149F-X-MIX

Male Elbow
p. J24



159F-X-MIX

45° Male Elbow
p. J24



68HB-X-MIX

Male Connector
p. J24



169HB-X-MIX

Male Elbow
p. J24



68NTA-X-MIX

Male Connector
p. J24



179HB-X-MIX

45° Male Elbow
p. J24



Garden Hose Fittings

50GHSV

Swivel Connector
p. J26



54GH-55GH

Hose Barb
p. J26



69GH-70GH-71GH

Male Pipe
p. J26



75GH

Connector
p. J26



78GH-79GH-80GH-81GH

Female Pipe
p. J26



82GH-83GH

Female Hose
p. J26



88GH

Swivel Connector
p. J26



90GH

Swivel Connector
p. J26



98GH-99GH

Hose to Pipe
p. J27



98GHSV-99GHSV

Swivel Connector
p. J27



101GHSV

Swivel Nut
Connector
p. J27



WARNING: These products can expose you to chemicals including CARBON BLACK, or LEAD, which are known to the state of California to cause cancer.

Accessories

207ACBH-WSHR
Sealing Washer Kit
p. J8



210P
Lock Nut
p. J9



211P
Square Head Plug
p. J9



213P
Cap
p. J9



218P
Hex Head Plug
p. J10



219P
Countersunk Plug
p. J10



220P
Slotted Head Plug
p. J10



0200
Hex Head Plug
BSPP, Metric
p. J20



0205
Internal Hex Head
Plug – NPT, BSPT
p. J20



0285
Internal Hex Head
Plug – NPT, BSPT
p. J21



0206
Internal Hex Head
NPT, BSPT
p. J21



0138
Copper Washer
BSPP, Metric
p. J21



0139
Bi-Material
Captive Sealing
Washer BSPP
p. J21



0602
Captive Sealing
Washer – BSPP, M5
p. J21



94GH
Hose Nut
p. J26



95GH
Hose Nut Reducer
p. J27



96GH
Hose Cap
p. J27



901GH
Washer
p. J27



1163-60-BPD
Coupler
p. J27



1163-61-BPD
Nipple
p. J27



WARNING These products can expose you to chemicals including CARBON BLACK, or LEAD, which are known to the state of California to cause cancer.

Pipe Fittings



Parker's Pipe Fittings meet all functional requirements of SAE J530 and SAE J531. All threads on the pipe fittings are made to dryseal standards.

Product Features:

- All brass construction
- Meets functional requirements of SAE J530 and SAE J531
- Threads made to dryseal standards
- Both forgings and extrusions available

Markets:

- Industrial
- Construction
- Heavy duty truck
- Mobile
- Factory/process automation

Applications:

- Air Lines
- Water Line
- Cooling Lines

Specifications:

Pressure Range Up to 1000 PSI (68.9 bar)

Temperature Range -65° to +250° F (-53.9° to +121.1° C)

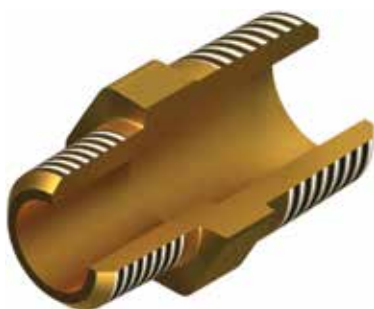

Assembly Instructions

Straight Fittings

1. Hand tighten external thread into internal thread
2. Tighten an additional 2 turns with a wrench up to 1/2" male pipe thread.
3. Above 1/2" 1 1/2 to 2 1/2 turns.



Elbow or Tee Fittings

1. Hand tighten external thread into internal thread
2. Tighten an additional 1 to 1 1/2 turns with a wrench
3. Tighten fitting, clockwise to align with tubing. (Never counter clockwise)

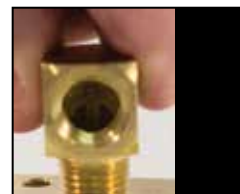

Note: To minimize the possibility of a leaking threaded joint after assembling Male to female pipe threads, neither end should be backed out (loosened) Once the assembly has been made.



⚠ WARNING These products can expose you to chemicals including LEAD which is known to the state of California to cause cancer.

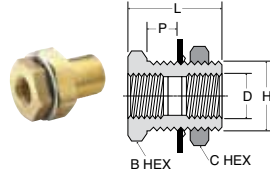

Bulkhead 207ACBH

PART NO.	FEAMLE PIPE THREAD	STRAIGHT THREAD	MAX. BULK HEAD P	B HEX	C HEX	L	BLKHD HOLE DIA. H	FLOW DIA. D
207ACBH-2	1/8	5/8-18	.89	7/8	15/16	1.50	5/8	.339
207ACBHS-2	1/8	5/8-18	.35	7/8	15/16	.96	5/8	.339
207ACBH-4	1/4	3/4-16	.81	1	1-1/8	1.50	3/4	.441
207ACBHS-4	1/4	3/4-16	.26	1	1	.94	3/4	.441
207ACBH-6	3/8	1-14	.62	1-1/8	1-1/4	1.31	1	.571
207ACBH-8	1/2	1-1/8-14	.75	1-1/4	1-3/8	1.50	1-1/8	.703
207ACBH-12	3/4	1-5/16-12	.65	1-1/2	1-1/2	1.50	1-5/16	.906
207ACBH-16*	1	1-5/8-14	1.00	2	2	1.68	1-5/8	1.140

*Lock Washer not Available

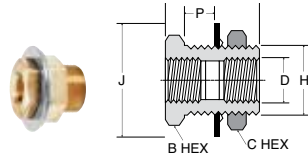

Sealed Bulkhead 207ACBH-S

PART NO.	FEAMLE PIPE THREAD	STRAIGHT THREAD	MAX. BULK HEAD P	B HEX	C HEX	J	L	BLKHD HOLE DIA. H	FLOW DIA. D
207ACBH-2-S	1/8	5/8-18	.84	7/8	15/16	1.19	1.50	.656	.339
207ACBHS-2-S	1/8	5/8-18	.30	7/8	15/16	1.19	.96	.656	.339
207ACBH-4-S	1/4	3/4-16	.75	1	1-1/8	1.31	1.50	.781	.441
207ACBHS-4-S	1/4	3/4-16	.20	1	1	1.31	.94	.781	.441
207ACBH-6-S	3/8	1-14	.56	1-1/8	1-1/4	1.75	1.31	1.031	.571

Sealing Washer Kit (10 pcs)



PART NO.	INNER DIA.	OUTER DIA.
207ACBH-WSHR-2	.625	1.19
207ACBH-WSHR-4	.75	1.31
207ACBH-WSHR-6	1.00	1.75

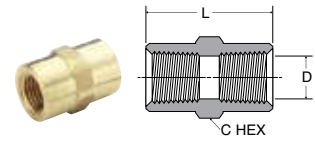

Coupling 207P

PART NO.	PIPE THREAD	C HEX	L	FLOW DIA. D
207P-2	1/8	9/16	.75	.339
207P-4	1/4	3/4	1.12	.441
207P-6	3/8	7/8	1.12	.571
207P-8	1/2	1-1/16	1.50	.703
207P-12	3/4	1-3/8	1.53	.906

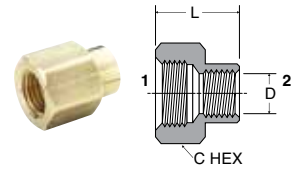

Reducer Coupling 208P

PART NO.	1 PIPE THREAD	2 PIPE THREAD	C HEX	L	FLOW FLOW DIA. D
208P-4-2	1/4	1/8	3/4	.97	.339
208P-6-4	3/8	1/4	7/8	1.16	.441
208P-8-4	1/2	1/4	1-1/16	1.28	.441
208P-8-6	1/2	3/8	1-1/16	1.38	.571
208P-12-6	3/4	3/8	1-3/8	1.32	.571
208P-12-8	3/4	1/2	1-3/8	1.50	.703

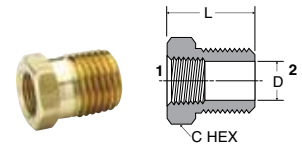

Bushing 209P

PART NO.	1 PIPE THREAD	2 PIPE THREAD	C HEX	L	FLOW FLOW DIA. D
209P-4-2	1/8	1/4	9/16	.75	.339
209P-6-2	1/8	3/8	11/16	.75	.339
209P-6-4	1/4	3/8	3/4	.75	.441
209P-8-2	1/8	1/2	7/8	1.00	.339
209P-8-4	1/4	1/2	7/8	1.00	.441
209P-8-6	3/8	1/2	7/8	1.00	.571
209P-12-2	1/8	3/4	1-1/8	1.00	.339
209P-12-4	1/4	3/4	1-1/8	1.00	.441
209P-12-6	3/8	3/4	1-1/8	1.00	.571
209P-12-8	1/2	3/4	1-1/8	1.00	.703
209P-16-8	1/2	1	1-3/8	1.31	.703
209P-16-12	3/4	1	1-3/8	1.31	.906

WARNING: These products can expose you to chemicals including LEAD which is known to the state of California to cause cancer.

[Click here for CADs, Product Specifications or to Configure Parts Online](#)

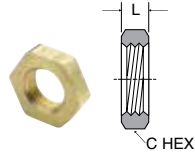

Lock Nut 210P

PART NO.	PIPE THREAD	C HEX	L
210P-2	1/8 NPSL	11/16	.19
210P-4	1/4 NPSL	7/8	.25
210P-6	3/8 NPSL	1	.25
210P-8	1/2 NPSL	1-1/8	.25

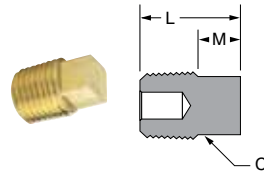

Square-Head Plug 211P

PART NO.	PIPE THREAD	C	L	M
211P-2	1/8	9/32	.59	.25
211P-4	1/4	3/8	.80	.29
211P-6	3/8	7/16	.83	.32
211P-8	1/2	9/16	1.07	.39
211P-12	3/4	5/8	1.14	.45

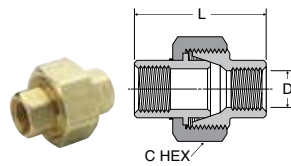

Union 212P

PART NO.	PIPE THREAD	C HEX	L	D
212P-4	1/4	1-3/16	1.54	.441
212P-6	3/8	1-1/4	1.76	.571

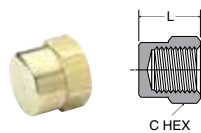

Cap 213P

PART NO.	PIPE THREAD	C HEX	L
213P-2	1/8	9/16	.50
213P-4	1/4	11/16	.63
213P-6	3/8	13/16	.63
213P-8	1/2	1-1/16	.87
213P-12	3/4	1-1/4	.89

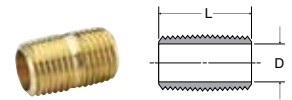

Close Nipple 215PN

PART NO.	PIPE THREAD	L	FLOW DIA. D
215PN-2	1/8	.75	.281
215PN-4	1/4	.88	.375
215PN-6	3/8	1.00	.500
215PN-8	1/2	1.13	.625
215PN-12	3/4	1.31	.750

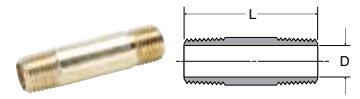

Long Nipple 215PNL

PART NO.	PIPE THREAD	L	FLOW DIA. D
215PNL-2-15	1/8	1-1/2	.250
215PNL-4-15	1/4	1-1/2	.375
215PNL-6-15	3/8	1-1/2	.500
215PNL-8-15	1/2	1-1/2	.625
215PNL-2-20	1/8	2	.250
215PNL-4-20	1/4	2	.375
215PNL-6-20	3/8	2	.500
215PNL-8-20	1/2	2	.625
215PNL-2-25	1/8	2-1/2	.250
215PNL-4-25	1/4	2-1/2	.375
215PNL-6-25	3/8	2-1/2	.500
215PNL-8-25	1/2	2-1/2	.625
215PNL-2-30	1/8	3	.250
215PNL-4-30	1/4	3	.375
215PNL-6-30	3/8	3	.500
215PNL-8-30	1/2	3	.625
215PNL-2-35	1/8	3-1/2	.250
215PNL-4-35	1/4	3-1/2	.375
215PNL-6-35	3/8	3-1/2	.500
215PNL-8-35	1/2	3-1/2	.625

WARNING These products can expose you to chemicals including LEAD which is known to the state of California to cause cancer.

Hex Nipple 216P

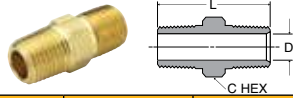

PART NO.	PIPE THREAD	C HEX	L	FLOW DIA. D
216P-2	1/8	7/16	.97	.220
216P-4	1/4	9/16	1.38	.314
216P-6	3/8	11/16	1.41	.440
216P-8	1/2	7/8	1.81	.564
216P-12	3/4	1-1/16	1.81	.752

Slotted-Head Plug 220P

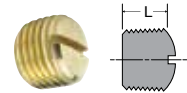

PART NO.	PIPE THREAD	L
220P-2	1/8	.31
220P-4	1/4	.42
220P-6	3/8	.43

Hex Nipple Reducers 216P

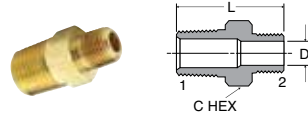

PART NO.	1 PIPE THREAD	2 PIPE THREAD	C HEX	L	FLOW DIA. D
216P-4-2	1/4	1/8	9/16	1.19	.220
216P-6-2	3/8	1/8	11/16	1.22	.220
216P-6-4	3/8	1/4	11/16	1.41	.314
216P-8-4	1/2	1/4	7/8	1.62	.314
216P-8-6	1/2	3/8	7/8	1.62	.440
216P-12-8	3/4	1/2	1-1/16	1.80	.564

Adapter 222P

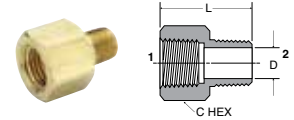

PART NO.	1 PIPE THREAD	2 PIPE THREAD	C HEX	L	FLOW DIA. D
222P-2-2	1/8	1/8	9/16	.88	.220
222P-4-2	1/4	1/8	3/4	1.06	.220
222P-4-4	1/4	1/4	3/4	1.25	.314
222P-6-2	3/8	1/8	7/8	1.10	.220
222P-6-4	3/8	1/4	7/8	1.25	.314
222P-6-6	3/8	3/8	7/8	1.25	.440
222P-8-4	1/2	1/4	1	1.47	.314
222P-8-6	1/2	3/8	1-1/16	1.47	.440
222P-8-8	1/2	1/2	1-1/16	1.66	.564
222P-12-6	3/4	3/8	1-3/8	1.50	.440
222P-12-8	3/4	1/2	1-3/8	1.69	.564
222P-12-12	3/4	3/4	1-3/8	1.69	.752

Hex-Head Plug 218P

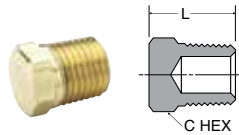

PART NO.	PIPE THREAD	C HEX	L
218P-2	1/8	7/16	.560
218P-4	1/4	9/16	.747
218P-6	3/8	11/16	.780
218P-8	1/2	7/8	.970
218P-12	3/4	1-1/16	1.054

Countersunk Hex-Head Plug 219P

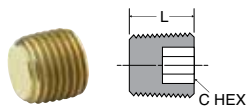

PART NO.	PIPE THREAD	C HEX	L
219P-2	1/8	3/16	.30
219P-4	1/4	1/4	.46
219P-6	3/8	5/16	.46
219P-8	1/2	3/8	.61
219P-12	3/4	9/16	.62

90° Union Elbow 1200P-2200P

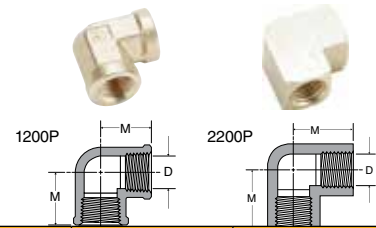

PART NO.	PIPE THREAD	M	FLOW DIA. D
1200P-2-2	1/8	.56	.329
2200P-2-2	1/8	.55	.339
1200P-4-4	1/4	.81	.441
2200P-4-4	1/4	.78	.441
1200P-6-6	3/8	.84	.571
2200P-6-6	3/8	.84	.571
2200P-8-8	1/2	1.07	.703

WARNING: These products can expose you to chemicals including LEAD which is known to the state of California to cause cancer.

[Click here for CADs, Product Specifications or to Configure Parts Online](#)

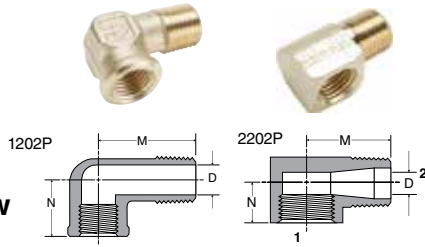

**90° Street Elbow
1202P-2202P**

PART NO.	1 PIPE THREAD	2 PIPE THREAD	M	N	FLOW DIA. D
1202P-2-2	1/8	1/8	.81	.56	.22
2202P-2-2	1/8	1/8	.62	.48	.22
2202PA-2-2*	1/8	1/8	.66	.48	.22
2202P-4-2	1/4	1/8	.72	.45	.23
1202P-4-4	1/4	1/4	1.08	.69	.31
2202P-4-4	1/4	1/4	.91	.45	.34
2202PA-4-4*	1/4	1/4	.91	.72	.31
2202P-4-6	1/4	3/8	.97	.78	.43
1202P-6-4	3/8	1/4	1.25	.78	.31
1202P-6-6	3/8	3/8	1.25	.78	.42
2202P-6-6	3/8	3/8	.98	.54	.41
2202PA-6-6*	3/8	3/8	.97	.78	.43
1202P-6-8	3/8	1/2	1.53	1.01	.56
1202P-8-6	1/2	3/8	1.25	.97	.42
2202P-8-8	1/2	1/2	1.25	1.03	.56
2202P-12-8	3/4	1/2	1.39	1.10	.56
2202P-12-12	3/4	3/4	1.39	1.10	.75

*Meets SAE Dimensions

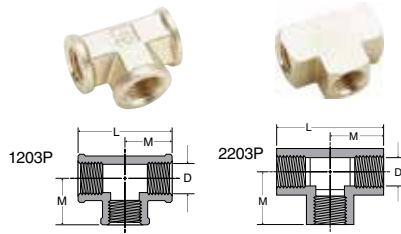

**Union Tee
1203P-2203P**

PART NO.	PIPE THREAD	L	M	FLOW DIA. D
1203P-2	1/8	1.12	.56	.339
2203P-2	1/8	1.06	.53	.339
1203P-4	1/4	1.38	.69	.441
2203P-4	1/4	1.52	.76	.441
2203P-6	3/8	1.68	.84	.571
1203P-8	1/2	2.14	1.07	.703
2203P-8	1/2	2.14	1.07	.703
2203P-12	3/4	2.28	1.14	.906

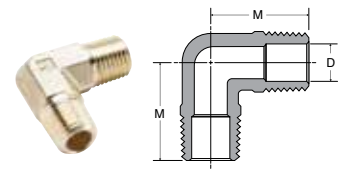

Male Elbow 1204P

PART NO.	PIPE THREAD	M	FLOW DIA. D
1204P-2	1/8	.71	.220
1204P-4	1/4	1.09	.312
1204P-6	3/8	1.09	.408
1204P-8	1/2	1.41	.502

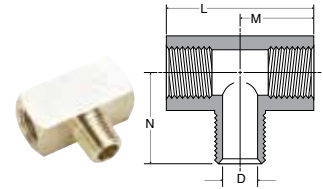

Male Branch Tee 2224P

PART NO.	PIPE THREAD	L	M	N	FLOW DIA. D
2224P-2	1/8	1.06	.53	.66	.220
2224P-4	1/4	1.52	.76	.91	.314
2224P-6	3/8	1.68	.84	.97	.440
2224P-8	1/2	2.18	1.09	1.25	.564
2224P-12	3/4	2.32	1.16	1.38	.752

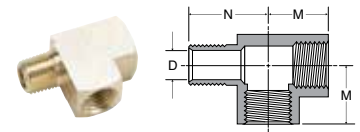

Street Tee 2225P

PART NO.	PIPE THREAD	M	N	DIA. D
2225P-2	1/8	.53	.66	.220
2225P-4	1/4	.76	.91	.314
2225P-6	3/8	.84	.98	.440
2225P-8	1/2	1.07	1.26	.564
2225P-12	3/4	1.14	1.38	.752

WARNING These products can expose you to chemicals including LEAD which is known to the state of California to cause cancer.

[Click here for CADs, Product Specifications or to Configure Parts Online](#)

**Drop-ear 90° Elbow
2200PDE**

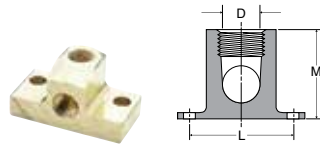

PART NO.	PIPE THREAD	L	M	FLOW DIA. D
2200PDE-2	1/8	1.38	1.00	.339

**45° Female Elbow
1201P-2201P**

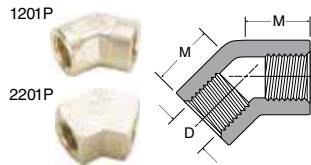

PART NO.	PIPE THREAD	M	FLOW DIA. D
2201P-2-2	1/8	.43	.339
1201P-8-8	1/2	.89	.703

Cross 2205P

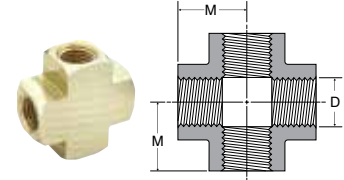

PART NO.	PIPE THREAD	M	FLOW DIA. D
2205P-2	1/8	.53	.339
2205P-4	1/4	.75	.441
2205P-6	3/8	.81	.571
2205P-8	1/2	1.07	.703
2205P-12	3/4	1.14	.906

**45° Street Elbow
2214P**

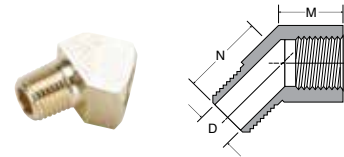

PART NO.	PIPE THREAD	M	N	FLOW DIA. D
2214P-2-2	1/8	.38	.50	.220
2214P-4-4	1/4	.54	.70	.314
2214P-6-6	3/8	.56	.78	.440
2214P-8-8	1/2	.73	1.00	.564
2214P-12-12	3/4	.75	1.35	.750

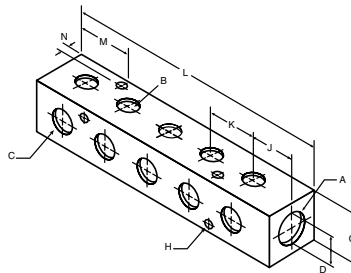

Brass Manifold 255M

PART NO.	PIPE THREAD A	PIPE THREAD B	PIPE THREAD C	G	MOUNTING HOLE DIA. H	J	K	L	M	N	D
X255MP-6-4-2	3/8	1/8	1/4	1.25	.22	.88	1.13	6.25	1.45	.25	.25

WARNING These products can expose you to chemicals including LEAD which is known to the state of California to cause cancer.

Metric Adapters



Parker's Metric Adapters offers a comprehensive range of NPT, BSPT, BSPP and metric pipe threads. Metric adapters are produced in both forgings and extrusions.

Product Features:

- All brass construction
- Nickel plated adapters
- Robust design
- Reusable

Markets:

- Industrial
- Construction
- Heavy duty truck
- Mobile
- Factory/process automation

Applications:

- Air Lines
- Water Line
- Cooling Lines

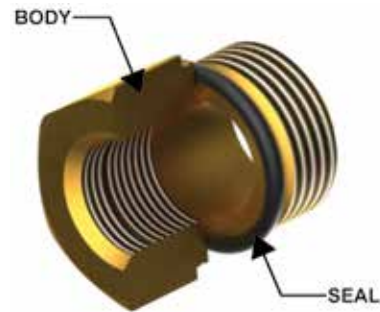

Specifications:

	Pressure Range	Temperature Range
Brass	1/8" to 1/2": 2900 PSI (200 bar)	-76F to +302F (-60°C to +150°C)
	3/4" and 1": 2175 PSI (150 bar) without sealing washer	without sealing washer -4F to +34F (-20°C to +100°C) with sealing washer
Nickel-plated Brass	870 PSI (59.9 bar)	+14F to +176F (-10°C to +80°C)

⚠ WARNING These products can expose you to chemicals including LEAD which is known to the state of California to cause cancer.

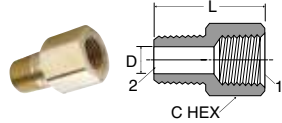

F3HG Adapter NPTF Male BSPT

PART NO.	NPTF 1	BSPT 2	C HEX	L	FLOW D
1/8F3HG-B	1/8	1/8	9/16	.93	.22
1/4F3HG-B	1/4	1/4	3/4	1.35	.31
3/8F3HG-B	3/8	3/8	7/8	1.35	.44
1/2F3HG-B	1/2	1/2	1-1/16	1.76	.56

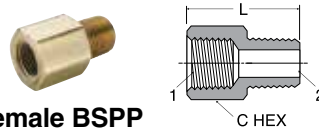

0164 Adapter Male NPT/Female BSPT

PART NO.	BSPP 1	NPTF 2	C HEX	L
0164 11 10	1/8	1/8	14	20
0164 14 13	1/4	1/4	17	27.5
0164 18 17	3/8	3/8	22	28.5
0164 22 21	1/2	1/2	27	36.5
0164 28 27	3/4	3/4	32	38.5

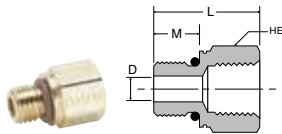

Pipe to Metric Adaptor 222P-X-MIX

PART NO.	NPTF	METRIC THREAD	HEX	L	M	D
222P-2-MI10	1/8-27	M10 X 1.0	9/16	.75	.34	.18
222P-2-MI14	1/8-27	M14 X 1.5	3/4	.91	.43	.30
222P-4-MI12	1/4-18	M12 X 1.5	11/16	1.09	.43	.24
222P-6-MI16	3/8-18	M16 X 1.5	7/8	1.10	.45	.35
222P-6-MI22	3/8-18	M22 X 1.5	1 1/16	1.05	.37	.47
222P-8-MI27	1/2-14	M27 X 2.0	1 1/4	1.32	.63	.60

Note: Fluorocarbon o-ring is standard

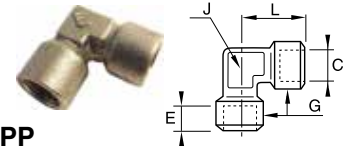

0143 90° Union Elbow BSPP

PART NO.	C BSPP	E MM	G MM	J MM	L MM	WT. KG
0143 10 10	G1/8	7.5	16.5	12	22.5	.042
0143 13 13	G1/4	11	18.5	15	26.5	.055
0143 17 17	G3/8	11.5	23.5	19	31.5	.098
0143 21 21	G1/2	15	28	23	35.5	.158
0143 27 27	G3/4	16.5	34	27	43.5	.256

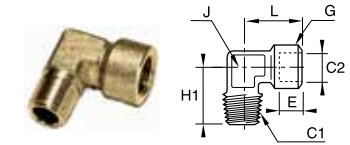

0144 Street Elbow Female BSPP to Male BSPT

PART NO.	C1 BSPT	C2 BSPP	E MM	G MM	H1 MM	J MM	L MM	WT. KG
0144 10 10	R1/8	G1/8	7.5	16.5	23	12	22.5	.033
0144 13 13	R1/4	G1/4	11	18.5	26	15	26.5	.050
0144 17 17	R3/8	G3/8	11.5	23.5	30	19	31.5	.085
0144 21 21	R1/2	G1/2	15	28	35	23	34.5	.138
0144 27 27	R3/4	G3/4	16.5	34	40	27	43.5	.229

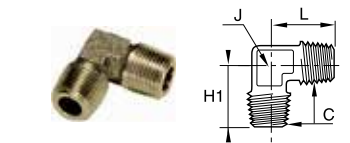

0152 Union Elbow Male BSPT

PART NO.	C BSPT	H1 MM	J MM	L MM	WT. KG
0152 10 10	R1/8	19.5	10	19.5	.018
0152 13 13	R1/4	25	15	25	.045
0152 17 17	R3/8	26.5	15	26.5	.056
0152 21 21	R1/2	31.5	19	31.5	.087
0152 27 27	R3/4	35.5	23	35.5	.153

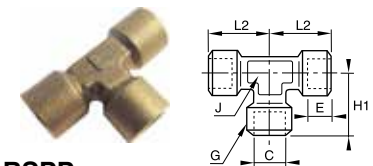

0145 Female Union Tee BSPP

PART NO.	C BSPP	E MM	G MM	H1 MM	J MM	L2 MM	WT. KG
0145 10 10	G1/8	7.5	16.5	22.5	12	22.5	.051
0145 13 13	G1/4	11	18.5	26.5	15	26.5	.074
0145 17 17	G3/8	11.5	23.5	31	19	31	.147
0145 21 21	G1/2	15	28	38	23	38	.231
0145 27 27	G3/4	16.5	34	47.5	27	47.5	.381

WARNING: These products can expose you to chemicals including LEAD which is known to the state of California to cause cancer.

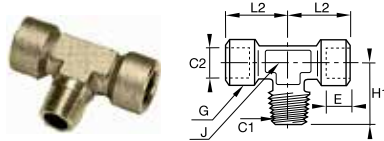

0158 Branch Tee Female BSPP to Male BSPT

PART NO.	C1 BSPT	C2 BSPP	E MM	G MM	H1 MM	J MM	L2 MM	WT. KG
0158 10 10	R1/8	G1/8	7.5	16.5	21.5	12	21.5	.045
0158 13 13	R1/4	G1/4	11	18.5	26	15	26	.071
0158 17 17	R3/8	G3/8	11.5	23.5	30	19	30	.118
0158 21 21	R1/2	G1/2	15	28	36	23	36	.203
0158 27 27	R3/4	G3/4	16.5	34	44	27	44	.320

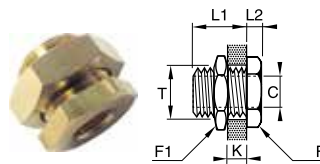

0117 Bulkhead BSPP and M5

PART NO.	C BSPP/M5	F MM	F1 MM	K MAX MM	L1 MM	L2 MM	T MAX MM	WT. KG
0117 00 19	M5X0.8	14	14	7	10.5	3.5	10.5	.013
0117 00 10	G1/8	19	22	9	14	4	16.5	.033
0117 00 13	G1/4	24	27	15	21	4	20.5	.057
0117 00 17	G3/8	30	32	14	21	5	26.5	.096
0117 00 21	G1/2	32	36	20	27	6	28.5	.117
0117 00 27	G3/4	41	41	22.5	30	6	34.5	.162
0117 00 34	G1	46	50	24.5	34	8	42.5	.270
0117 00 42	G1-1/4	55	55	29.5	39	8	49.5	.300
0117 00 49	G1-1/2	60	60	29.5	39	8	54.5	.306

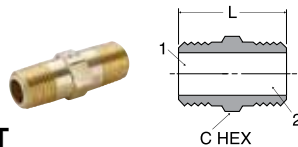

0121 Hex Nipple NPT/BSPT

PART NO.	NPT 1	BSPT 2	C HEX	L
0121 11 10	1/8	1/8	11	19
0121 14 13	1/4	1/4	14	27
0121 18 17	3/8	3/8	17	28
0121 22 21	1/2	1/2	22	36
0121 28 27	3/4	3/4	27	40

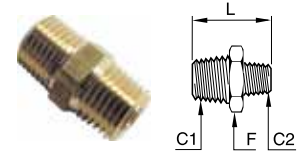

0121 Hex Nipple Male BSPT

PART NO.	C1 BSPT	C2 BSPT	F MM	L MM	WT. KG
0121 10 10	R1/8	R1/8	11	19	.009
0121 13 13	R1/4	R1/4	14	27	.021
0121 13 10	R1/4	R1/8	14	23.5	.021
0121 17 17	R3/8	R3/8	17	28	.025
0121 17 13	R3/8	R1/4	17	27.5	.024
0121 17 10	R3/8	R1/8	17	24	.022
0121 21 21	R1/2	R1/2	22	36	.053
0121 21 17	R1/2	R3/8	22	32.5	.045
0121 21 13	R1/2	R1/4	22	32	.045
0121 21 10	R1/2	R1/8	22	28.5	.041
0121 27 27	R3/4	R3/4	27	40	.092
0121 27 21	R3/4	R1/2	27	39	.084
0121 27 17	R3/4	R3/8	27	35.5	.076
0121 27 13	R3/4	R1/4	27	35	.079
0121 34 34	R1	R1	36	46	.156
0121 34 27	R1	R3/4	36	43	.143
0121 34 21	R1	R1/2	36	42	.133
0121 34 17	R1	R3/8	36	38.5	.126
0121 42 42	R1-1/4	R1-1/4	46	53	.233
0121 42 34	R1-1/4	R1	46	50.5	.237
0121 42 27	R1-1/4	R3/4	46	47.5	.229
0121 42 21	R1-1/4	R1/2	46	46.5	.219

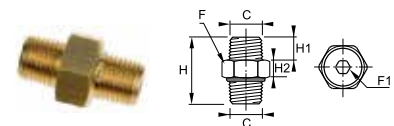

0929 3 Piece Adapter Double Male BSPT

PART NO.	C BSPT	F MM	F1 MM	H MM	H1 MM	H2 MM	WT. KG
0929 00 10	R1/8	15	5	27	9	8.5	0.181
0929 00 13	R1/4	19	6	33.5	11.5	9.5	0.100
0929 00 17	R3/8	22	8	36.5	13	10	0.010
0929 00 21	R1/2	27	12	45	15.5	12	0.088

Note: This connection accessory makes assembly easier thanks to its 3-piece design. To join the 2 threaded components, simply push together and tighten the nut.

WARNING: These products can expose you to chemicals including LEAD which is known to the state of California to cause cancer.

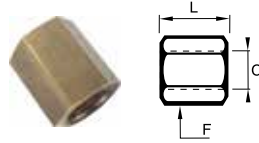

0155 Coupling BSPP

PART NO.	C BSPP	F MM	L MM	WT. KG
0155 10 10	G1/8	14	17	.015
0155 13 13	G1/4	17	24	.025
0155 17 17	G3/8	22	25	.045
0155 21 21	G1/2	27	32	.084
0155 27 27	G3/4	32	35	.109

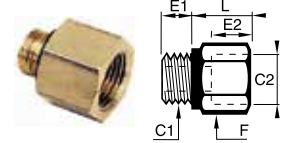

0169 Expander Female BSPP to Male BSPP

PART NO.	C1 BSPP	C2 BSPP	E1 MM	E2 MM	F MM	L MM	WT. KG
0169 10 13	G1/8	G1/4	5	11	17	16	.020
0169 10 17	G1/8	G3/8	5	14	22	19.5	.038
0169 13 17	G1/4	G3/8	7	14	22	19.5	.042
0169 13 21	G1/4	G1/2	7	14.5	27	20.5	.061
0169 17 21	G3/8	G1/2	8	14.5	27	20.5	.062
0169 17 27	G3/8	G3/4	8	15.5	32	22	.082
0169 21 27	G1/2	G3/4	9.5	15.5	32	22.5	.088

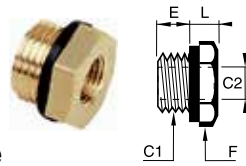

0168 Adapter Reducer Female BSPP to Male BSPP

PART NO.	C1 BSPP	C2 BSPP	E MM	F MM	L MM	WT. KG
0168 10 19	G1/8	M5X0.8	7	14	6	.008
0168 13 19	G1/4	M5X0.8	7	17	7	.010
0168 13 10	G1/4	G1/8	7	17	7	.010
0168 17 10	G3/8	G1/8	9	19	6	.020
0168 17 13	G3/8	G1/4	9	19	6	.013
0168 21 10	G1/2	G1/8	11	24	10	.046
0168 21 13	G1/2	G1/4	11	24	10	.038
0168 21 17	G1/2	G3/8	11	24	10	.026
0168 27 13	G3/4	G1/4	11	32	12	.090
0168 27 17	G3/4	G3/8	11	32	12	.078
0168 27 21	G3/4	G1/2	11	32	12	.058

* With captive polymer seal

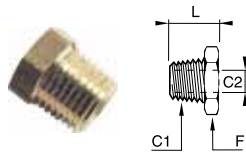

0163 Adapter Reducer Female BSPP to Male BSPT

PART NO.	C1 BSPT	C2 BSPP	F MM	L MM	WT. KG
0163 13 10	R1/4	G1/8	14	16	.009
0163 17 10	R3/8	G1/8	17	16.5	.020
0163 17 13	R3/8	G1/4	17	16.5	.012
0163 21 10	R1/2	G1/8	22	21	.047
0163 21 13	R1/2	G1/4	22	21	.038
0163 21 17	R1/2	G3/8	22	21	.025
0163 27 13	R3/4	G1/4	27	24	.086
0163 27 17	R3/4	G3/8	27	24	.069
0163 27 21	R3/4	G1/2	27	24	.048

WARNING These products can expose you to chemicals including LEAD which is known to the state of California to cause cancer.

Nickel Plated Metric Adapters

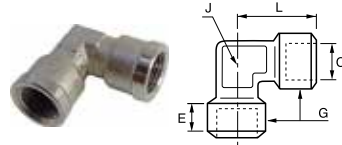

0912 Female Elbow BSPP and M5

PART NO.	C BSPP/M5	E MM	G MM	J MM	L MM	WT. KG
0912 00 19	M5	4	8	9	11	.037
0912 00 10	G1/8	8	13	10	21	.042
0912 00 13	G1/4	11	17	13	25.5	.055
0912 00 17	G3/8	11.5	21	17	28	.098
0912 00 21	G1/2	14	26	21	33.5	.158
0912 00 27	G3/4	15	31	27	36.5	.256

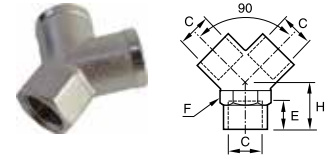

0910 "Y" Connector Female BSPP

PART NO.	C BSPP	E MM	F MM	H MM	WT. KG
0910 00 10	1/8	8	13	12	.055
0910 00 13	1/4	11	17	14	.081
0910 00 17	3/8	11.5	20	16	.128
0910 00 21	1/2	14	25	19	.213

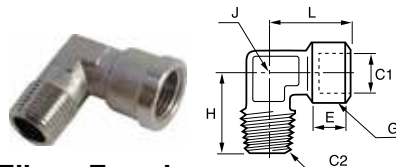

0913 / 0921 Street Elbow Female BSPP to Male BSPT and M5

PART NO.	C1 BSPP/ M5	C2 BSPT	E MM	G MM	H MM	J MM	L MM	WT. KG
0921 00 19	M5		4	8	11	9	11	.037
0913 00 10	G1/8	R1/8	8	13	18.5	10	21	.033
0913 00 13	G1/4	R1/4	11	17	23.5	13	25.5	.050
0913 00 17	G3/8	R3/8	11.5	21	26	17	28	.085
0913 00 21	G1/2	R1/2	14	26	31	21	33.5	.138
0913 00 27	G3/4	R3/4	15	31	35	27	36.5	.229

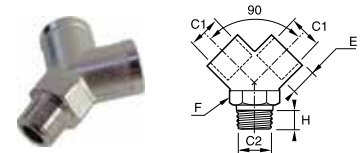

0911 "Y" Connector Female BSPP to Male BSPT

PART NO.	C1 BSPP	C2 BSPT	E	F	H	WT.
0911 00 10	G1/8	R1/8	8	13	12	.055
0911 00 13	G1/4	R1/4	11	17	14	.081
0911 00 17	G3/8	R3/8	11.5	20	16	.128
0911 00 21	G1/2	R1/2	14	25	19	.213

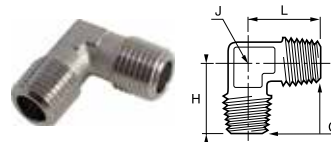

0914 / 0922 Equal Elbow Male BSPT or M5

PART NO.	C BSPT/M5	H MM	J MM	L MM	WT. KG
0922 00 19	M5	11	9	11	.037
0914 00 10	R1/8	18.5	10	18.5	.018
0914 00 13	R1/4	23.5	13	23.5	.045
0914 00 17	R3/8	26	17	26	.056
0914 00 21	R1/2	31	21	31	.087
0914 00 27	R3/4	35	27	35	.153

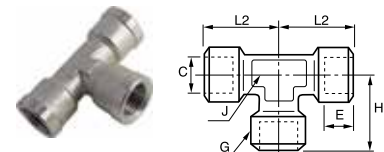

0915 Female Tee BSPP or M5

PART NO.	C BSPP/ M5	E MM	G MM	H MM	J MM	L2 MM	WT. KG
0915 00 19	M5	4	8	11	9	11	.047
0915 00 10	G1/8	8	13	21	10	21	.051
0915 00 13	G1/4	11	17	25.5	13	25.5	.074
0915 00 17	G3/8	11.5	21	28	17	28	.147
0915 00 21	G1/2	14	26	33.5	21	33.5	.231
0915 00 27	G3/4	15	31	36.5	27	36.5	.381

WARNING These products can expose you to chemicals including LEAD which is known to the state of California to cause cancer.

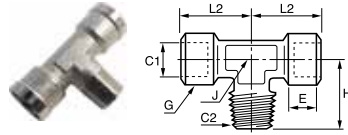

0916 / 0923 Branch Tee Female BSPP to Male BSPT

PART NO.	C1 BSPP/M5	C2 BSPT	E MM	G MM	H MM	J MM	L2 MM	WT. KG
0923 00 19	M5		4	8	11	9	11	.040
0916 00 10	G1/8	R1/8	8	13	18.5	10	21	.045
0916 00 13	G1/4	R1/4	11	17	23.5	13	25.5	.071
0916 00 17	G3/8	R3/8	11.5	21	26	17	28	.118
0916 00 21	G1/2	R1/2	14	26	31	21	33.5	.203
0916 00 27	G3/4	R3/4	15	31	36.5	27	36.5	.320

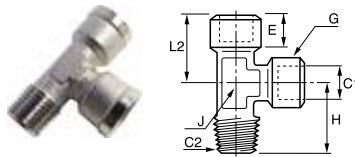

0917 / 0924 Run Tee Female BSPP to Male BSPT or M5

PART NO.	C1 BSPP/M5	C2 BSPT	E MM	G MM	H MM	J MM	L2 MM	WT. KG
0924 00 19	M5		4	8	11	9	11	.040
0917 00 10	G1/8	R1/8	8	13	18.5	10	21	.045
0917 00 13	G1/4	R1/4	11	17	23.5	13	25.5	.071
0917 00 17	G3/8	R3/8	11.5	21	26	17	28	.118
0917 00 21	G1/2	R1/2	14	26	31	21	33.5	.203
0917 00 27	G3/4	R3/4	15	31	36.5	27	36.5	.320

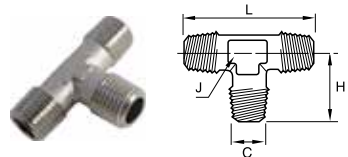

0927 Equal Male Tee BSPT

PART NO.	C BSPT	H MM	J MM	L MM	WT. KG
0927 00 10	R1/8	18.5	10	37	.017
0927 00 13	R1/4	23.5	13	47	.038
0927 00 17	R3/8	26	17	52	.057
0927 00 21	R1/2	31	21	62	.093

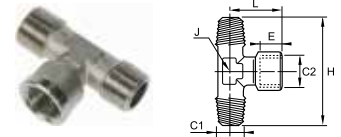

0928 Male Stud Branch Tee BSPT Female BSPP

PART NO.	C1 BSPT	C2 BSPP	E MM	H MM	J MM	L MM	WT. KG
0928 00 10	R1/8	G1/8	8	37	10	21	0.021
0928 00 13	R1/4	G1/4	11	47	13	25.5	0.044
0928 00 17	R3/8	G3/8	11.5	52	17	28	0.066
0928 00 21	R1/2	G1/2	14	62	21	33.5	0.109

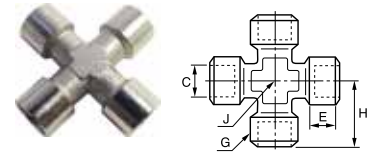

0908 Cross Female BSPP

PART NO.	C BSPP	E MM	G MM	H MM	J MM	WT. KG
0908 00 10	G1/8	8	13	21	10	.055
0908 00 13	G1/4	11	17	25.5	13	.081
0908 00 17	G3/8	11.5	21	28	17	.128
0908 00 21	G1/2	14	26	33.5	21	.213

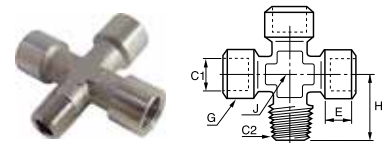

0909 Cross Female BSPP to Male BSPT

PART NO.	C1 BSPP	C2 BSPT	E MM	G MM	H MM	J MM	WT. KG
0909 00 10	G1/8	R1/8	8	13	18.5	10	.055
0909 00 13	G1/4	R1/4	11	17	23.5	13	.081
0909 00 17	G3/8	R3/8	11.5	21	26	17	.128
0909 00 21	G1/2	R1/2	14	26	31	21	.213

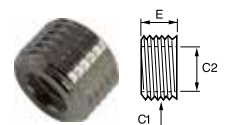

0903 Adapter Reducer BSPP

PART NO.	C1 BSPP	C2 BSPP	E MM	WT. KG
0903 10 13	G1/4	G1/8	8	.009
0903 13 17	G3/8	G1/4	9	.020
0903 17 21	G1/2	G3/8	10	.025
0903 21 27	G3/4	G1/2	14	.048
0903 27 34	G1"	G3/4	20	.060

WARNING These products can expose you to chemicals including LEAD which is known to the state of California to cause cancer.

0904 Adapter Reducer Female BSPP to Male BSPT

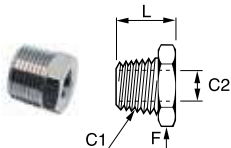

PART NO.	C1 BSPT	C2 BSPP	F MM	L MM	WT. KG
0904 10 13	R1/4	G1/8	14	16	.009
0904 10 17	R3/8	G1/8	17	16.5	.020
0904 13 17	R3/8	G1/4	17	16.5	.012
0904 13 21	R1/2	G1/4	22	19.5	.038
0904 17 21	R1/2	G3/8	22	19.5	.025
0904 17 27	R3/4	G3/8	27	23.5	.069
0904 21 27	R3/4	G1/2	27	23.5	.048

0907 Extended Adapter BSPP

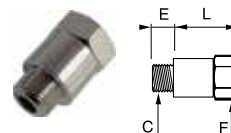

PART	C BSPP	E MM	F MM	L MM	WT. KG
0907 00 10	G1/8	6	14	16	.009
0907 00 10 01	G1/8	6	14	36	.009
0907 00 13	G1/4	8	17	23	.020
0907 00 13 01	G1/4	8	17	43	.020

0905 Adapter Reducer Male BSPP to Female BSPP or M5

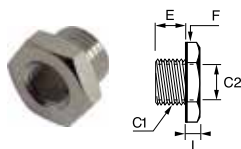

PART NO.	C1 BSPP	C2 BSPP M5	E MM	F MM	L MM	WT. KG
0905 19 10	G1/8	M5	6	14	4.5	.009
0905 10 13	G1/4	G1/8	8	17	5	.009
0905 10 17	G3/8	G1/8	9	19	5	.020
0905 13 17	G3/8	G1/4	9	19	5	.012
0905 13 21	G1/2	G1/4	10	24	5.5	.038
0905 17 21	G1/2	G3/8	10	24	5.5	.025
0905 17 27	G3/4	G3/8	12	30	5.5	.069
0905 21 27	G3/4	G1/2	12	30	5.5	.048

0920 Bulkhead BSPP and M5

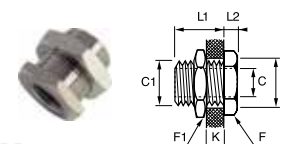

PART NO.	C1 METRIC	C BSPP M5	F MM	F1 MM	K MAX MM	L1 MM	L2 MM	T MIN MM	WT. KG
0920 00 19	M10X1	M5	14	14	7	10.5	3.5	10.5	.013
0920 00 10	M16X1.5	G1/8	19	22	9	14	4	16.5	.033
0920 00 13	M20X1.5	G1/4	24	27	15	21	4	20.5	.057
0920 00 17	M26X1.5	G3/8	30	32	14	21	5	26.5	.096
0920 00 21	M28X1.5	G1/2	32	36	20	27	6	28.5	.117

0906 Expander Female BSPP to Male BSPP

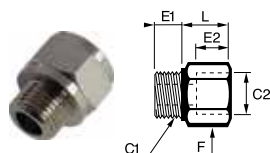

PART NO.	C1 BSPP/M5	C2 BSPP	E1 MM	E2 MM	F MM	L MM	WT. KG
0906 10 19	M5	G1/8	4	8	14	10	.009
0906 00 10	G1/8	G1/8	6	8.5	14	10	.009
0906 10 13	G1/8	G1/4	6	11.5	17	14	.020
0906 10 17	G1/8	G3/8	6	11.5	22	14.5	.038
0906 00 13	G1/4	G1/4	8	11.5	17	14	.040
0906 13 17	G1/4	G3/8	8	11.5	22	14.5	.042
0906 13 21	G1/4	G1/2	8	15	27	18	.061
0906 00 17	G3/8	G3/8	9	11.5	22	14.5	.061
0906 17 21	G3/8	G1/2	9	15	27	18	.062
0906 00 21	G1/2	G1/2	10	15	27	18	.070

0900 Male Straight Adapter BSPT

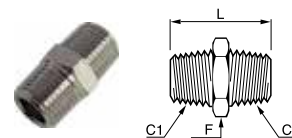

PART NO.	C1 BSPT	C2 BSPT	F MM	L MM	WT. KG
0900 00 10	R1/8	R1/8	12	19.5	.009
0900 10 13	R1/8	R1/4	14	23.5	.021
0900 00 13	R1/4	R1/4	14	27	.021
0900 10 17	R1/8	R3/8	17	24	.022
0900 13 17	R1/4	R3/8	17	27.5	.024
0900 00 17	R3/8	R3/8	17	28	.025
0900 13 21	R1/4	R1/2	22	30.5	.045
0900 17 21	R3/8	R1/2	22	31	.045
0900 00 21	R1/2	R1/2	22	33.5	.055
0900 21 27	R1/2	R3/4	27	37.5	.084
0900 00 27	R3/4	R3/4	27	40	.092
0900 27 34	R3/4	R1	34	43	.143
0900 00 34	R1	R1	34	45.5	.156

WARNING: These products can expose you to chemicals including LEAD which is known to the state of California to cause cancer.

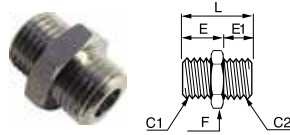

0901 Male Straight Adapter M5 or BSPP

PART NO.	C1 BSPP M5	C2 BSPP M5	E MM	E1 MM	F MM	L MM	WT. KG
0901 00 19	M5	M5	4	4	8	11.5	.002
0901 19 10	M5	G1/8	4	6	14	14.5	.008
0901 00 10	G1/8	G1/8	6	6	14	16.5	.008
0901 10 13	G1/8	G1/4	6	8	17	19	.014
0901 00 13	G1/4	G1/4	8	8	17	21	.016
0901 13 17	G1/4	G3/8	8	9	19	22	.021
0901 00 17	G3/8	G3/8	9	9	19	23	.024

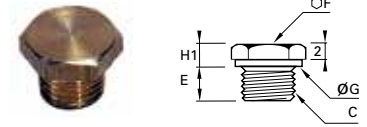

0200 Hex Head Plug BSPP and Metric

PART NO.	C BSPP	E MM	F MM	G MM	H1 MM	H2 MM	WT. KG
0200 10 00	G1/8	7	14	13.7	5.5	4	.012
0200 13 00	G1/4	8.5	17	16.7	5.5	4	.019

PART NO.	C METRIC	E MM	F MM	G MM	H1 MM	H2 MM	WT. KG
0200 52 00	M6X1	6	10	10	4	3.5	.004
0200 57 00	M8X1.25	7	13	13	4	3.5	.007
0200 60 00	M10X1	8	14	14	5	4.5	.012
0200 65 00	M12X1	9	17	17	5	4.5	.018
0200 66 00	M10X1.25	9	17	17	5	4.5	.018

Parallel metric threads ISO – standards NFE 03-054 and BNA 541. Parallel metric threads – standards NFE 03-005 and BNA 541.

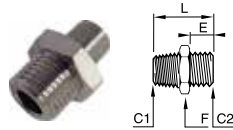

0192 Male Straight Adapter BSPT to BSPP

PART NO.	C1 BSPT	C2 BSPP	E MM	F MM	L MM	WT. KG
0192 10 13	R1/8	G1/4	9.5	17	23.5	.019
0192 13 13	R1/4	G1/4	9.5	17	27.5	.024
0192 13 21	R1/4	G1/2	27	27	31.5	.067
0192 17 13	R3/8	G1/4	9.5	17	45	.025
0192 17 21	R3/8	G1/2	27	27	31.5	.061
0192 21 21	R1/2	G1/2	27	27	34	.060

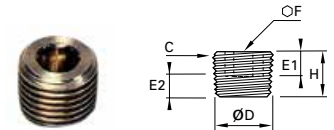

0205 Internal Hex Head Plug NPT and BSPT

PART NO.	C NPT	OD IN	E1 IN	E2 MIN IN	E2 MAX IN	F IN	H IN	WT. OZ
0205 11 00	1/8	.40	.24	.12	.20	.79	.31	.141
0205 14 00	1/4	.54	.31	.17	.28	.94	.39	.282
0205 18 00	3/8	.67	.31	.18	.29	1.22	.43	.494
0205 22 00	1/2	.93	.31	.25	.39	1.53	.51	.917
0205 28 00	3/4	1.04	.43	.27	.41	2.16	.67	1.834
0205 35 00	1	1.31	.51	.31	.49	2.95	.75	3.245

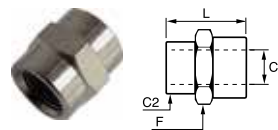

0902 Female Sleeve BSPP and M5

PART NO.	C1 BSPP/M5	C2 BSPP/M5	F MM	L MM	WT. KG
0902 00 19	M5	M5	8	11	.009
0902 19 10	M5	G1/8	14	13	.009
0902 00 10	G1/8	G1/8	14	15	.015
0902 10 13	G1/8	G1/4	17	19.5	.020
0902 00 13	G1/4	G1/4	17	22	.025
0902 10 17	G1/8	G3/8	22	20	.030
0902 13 17	G1/4	G3/8	22	23	.040
0902 00 17	G3/8	G3/8	22	24	.045
0902 13 21	G1/4	G1/2	27	27	.050
0902 17 21	G3/8	G1/2	27	27.5	.060
0902 00 21	G1/2	G1/2	27	30	.084
0902 21 27	G1/2	G3/4	30	30	.090
0902 00 27	G3/4	G3/4	30	32	.109

PART NO.	C BSPT	OD MM	E1 MM	E2 MIN MM	E2 MAX MM	F MM	H MM	WT. KG
0205 10 00	R1/8	9.728	6	3.1	4.9	5	8	.004
0205 13 00	R1/4	13.157	8	4.7	7.3	6	10	.008
0205 17 00	R3/8	16.662	8	5.1	7.7	8	11	.014
0205 21 00	R1/2	20.955	8	6.4	10	10	13	.027
0205 27 00	R3/4	26.441	11	7.7	11.3	14	17	.053
0205 34 00	R1	33.249	13	8.1	12.7	17	19	.092
0205 42 00	R1-1/4	41.910	14	10.4	15	22	22	.183
0205 49 00	R1-1/2	47.803	14	10.4	15	24	22	.250
0205 48 00	R2	59.614	16	13.6	18.2	30	25	.440

For BSP taper plus 1/2" - 1 1/2" inclusive - thread standard NFE 03-004 - DIN906

WARNING These products can expose you to chemicals including LEAD which is known to the state of California to cause cancer.

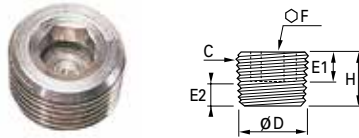

0285 Internal Hex Head Plug NPT or BSPT

PART NO.	C NPT	OD IN	E1 IN	E2 MIN IN	E2 MAX IN	F MM	H IN	WT. OZ
0285 11 00	1/8	.40	.24	.13	.20	5	.31	.14
0285 14 00	1/4	.54	.31	.17	.28	6	.39	.25
0285 18 00	3/8	.67	.31	.19	.30	8	.43	.49
0285 22 00	1/2	.84	.31	.25	.39	10	.51	.88

PART NO.	C BSPT	OD MM	E1 MM	E2 MIN MM	E2 MAX MM	F MM	H MM	WT. KG
0285 10 00	R1/8	9.72	6	3.1	4.9	5	8	.003
0285 13 00	R1/4	13.15	8	4.7	7.3	6	10	.007
0285 17 00	R3/8	16.66	8	5.1	7.7	8	11	.013
0285 21 00	R1/2	20.95	8	6.4	10	10	13	.025
0285 27 00	R3/4	26.44	11	7.7	11.3	14	17	.057
0285 34 00	R1	33.25	13	8.1	12.7	17	19	.098

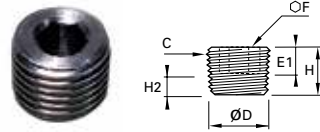

0206 Internal Hex Head NPT and BSPT

PART NO.	C NPT	OD IN	E1 IN	E2 MIN IN	E2 MAX IN	F MM	H IN	WT. OZ
0206 08 00	1/16	.31	.24	.15	.25	.16	.26	.070
0206 11 00	1/8	.40	.24	.12	.20	.20	.31	.106
0206 14 00	1/4	.54	.31	.17	.28	.24	.39	.247
0206 18 00	3/8	.67	.31	.18	.29	.31	.43	.423
0206 22 00	1/2	.83	.31	.25	.39	.39	.51	.847
0206 28 00	3/4	1.04	.43	.27	.41	.55	.67	1.658
0206 25 00	1	1.31	.51	.31	.49	.67	.75	2.928

PART NO.	C BSPT	OD MM	E1 MM	E2 MIN MM	E2 MAX MM	F MM	H MM	WT. KG
0285 10 00	R1/8	9.728	6	3.1	4.9	5	8	.003
0285 13 00	R1/4	13.157	8	4.7	7.3	6	10	.007
0285 17 00	R3/8	16.662	8	5.1	7.7	8	11	.013
0285 21 00	R1/2	20.955	8	6.4	10	10	13	.024
0285 27 00	R3/4	26.441	11	7.7	11.3	14	17	.048
0285 34 00	R1	33.249	13	8.1	12.7	17	19	.086
0285 34 00	R1-1/4	41.910	14	10.4	15	22	22	.162
0285 34 00	R1-1/2	47.803	14	10.4	15	24	22	.222

For BSP taper plugs 1/2" - 1 1/2" inclusive - conform to standard BNA 247 - thread - DIN 906 standard NFE 03-004

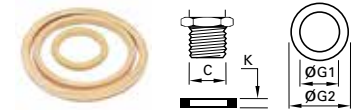

0138 Copper Washer BSPP and Metric

PART NO.	C BSPP/M5	G1 MM	G2 MM	K MM	WT. OZ
	M6	6.3	9	1	.033
	M8	8.3	11	1	.001
	M12	12.3	15.5	1.5	.072
	M14	14.3	18	1.5	.001
	M16	16.3	20	1.5	.001
	M18	18.3	22	1.5	.001
	M20	20.3	24	1.5	.001
	M22	22.3	27	1.5	.002
	M24	24.3	29	2	.003
	M26	26.3	31	2	.003
	M30	30.3	36	2	.004
	M36	36.3	42	2	.005
	M39	39.3	44	2	.007
	M45	45.3	52	2	.007
	M52	52.3	60	2	.009
	G1/8	10.3	13.5	1	.001
	G1/4	13.5	18	1.3	.001
	G3/8	17.3	21	1.5	.001
	G1/2	21.3	26	1.5	.002
	G3/4	27.3	32	2	.003
	G1	33.5	39	2	.005
	G1-1/4	42.5	49	2	.007
	G1-1/2	48.3	55	2	.008
	G2	60	68	2.5	.014

WARNING These products can expose you to chemicals including LEAD which is known to the state of California to cause cancer.



0139 Bi-Material Captive Sealing Washer BSPP

PART NO.	C BSPP	G MM	G2 MM	K MM	WT. OZ
0139 10 00	G1/8	14	1	1.8	.001
0139 13 00	G1/4	17	1	1.8	.001
0139 17 00	G3/8	22	1.3	2.1	.001
0139 21 00	G1/2	26	1.6	2.4	.002
0139 27 00	G3/4	32	1.6	2.4	.002
0139 34 00	G1	43	3.5	2.5	.002

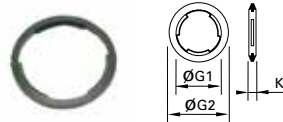

0602 Captive Sealing Washer BSPP and M5

PART NO.	C BSPP/M5	G1 MM	G2 MM	K MM	WT. OZ
0602 29 93 15	M5X0.8	5.2	7.8	1.5	.001
0602 23 10 20	G1/8	10.3	14	2	.001
0602 23 11 20	G1/4	13.7	17.5	2	.001
0602 23 12 20	G3/8	17.2	21	2	.001
0602 23 13 20	G1/2	21.5	25.5	2.5	.001
0602 27 32 20	G3/4	27	32	2.5	.001
0602 30 60 20	G1	33.8	39	3	.001

WARNING These products can expose you to chemicals including LEAD which is known to the state of California to cause cancer.



ISO Port Adapters

Parker's ISO Port Adapters meet dimensional requirements of ISO 6149-3.

Product Features:

- All brass construction
- Fluorocarbon O-ring
- NPTF, flare, hose barb, NTA end configurations

Markets:

- Industrial
- Construction
- Mobile
- Factory/process automation

Applications:

- Air Lines
- Water Line
- Cooling Lines

Specifications:

Pressure Range Dependent on tubing or hose end connection

Temperature Range Dependent on tubing or hose end connection

⚠ WARNING These products can expose you to chemicals including LEAD which is known to the state of California to cause cancer.

Pipe to Metric Adaptor 222P-X-MIX

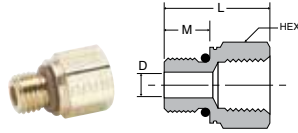

PART NUMBER	NPTF	METRIC THREAD	HEX	L	M	D
222P-2-MI10	1/8-27	M10 X 1.0	9/16	.75	.34	.18
222P-2-MI14	1/8-27	M14 X 1.5	3/4	.91	.43	.30
222P-4-MI12	1/4-18	M12 X 1.5	11/16	1.09	.43	.24
222P-4-MI14	1/4-18	M14 X 1.5	3/4	1.09	.43	.30
222P-6-MI16	3/8-18	M16 X 1.5	7/8	1.16	.45	.35
222P-6-MI22	3/8-18	M22 X 1.5	1 1/16	1.05	.51	.47
222P-8-MI27	1/2-14	M27 X 2.0	1 1/4	1.32	.63	.60

Note: Fluorocarbon o-ring is standard
For working pressure and Temperature see Metric Adapters Section

Hose Barb to Metric Adaptor 68HB-X-MIX

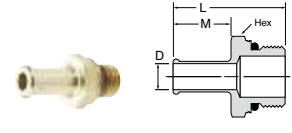

PART NUMBER	TUBE SIZE	METRIC THREAD	HEX	L	M	D
68HB-6-MI12	3/8	M12 X 1.5	11/16	1.50	.78	.24
68HB-6-MI14	3/8	M14 1.5	3/4	1.51	.78	.30
68HB-8-MI12	1/2	M12 X 1.5	11/16	1.50	.78	.24
68HB-10-MI27	5/8	M27 X 2.0	1 1/4	1.77	.78	.50

Note: Fluorocarbon o-ring is standard
For working pressure and Temperature see Hose Barb Section

Flare to Metric Adaptor 48F-X-MIX

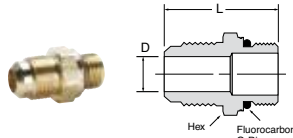

PART NUMBER	TUBE SIZE	METRIC THREAD	HEX	L	D
48F-8-MI16	1/2	M16 X 1.5	7/8	1.60	.35
48F-10-MI27	5/8	M27 X 2.0	1 1/4	1.87	.50
48F-12-MI27	3/4	M27 X 2.0	1 1/4	1.99	.63

Note: Fluorocarbon o-ring is standard
For working pressure and Temperature see SAE Flare Section

Beaded Elbow to Metric Adaptor 169HB-X-MIX

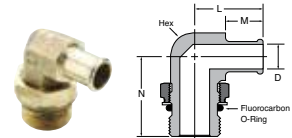

PART NUMBER	HOSE SIZE	METRIC THREAD	HEX	L	M	N	D
169HB-10-MI27	5/8	M27 X 2.0	7/8	1.41	.78	1.63	.50
169HB-16-MI27	1	M27 X 2.0	1	1.67	.97	1.68	.71

Note: Fluorocarbon o-ring is standard
For working pressure and Temperature see Hose Barb Section

Flare Elbow to Metric Adaptor 149F-X-MIX

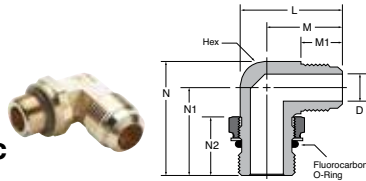

PART NUMBER	TUBE SIZE	METRIC THREAD	HEX	L	M	M1	N	N1	N2	D
149F-10-MI27	5/8	M27 X 2.0	7/8	1.95	1.46	.88	2.12	1.63	1.09	.50

Note: Fluorocarbon o-ring is standard
For working pressure and Temperature see SAE Flare Section

NTA to Metric Adaptor 68NTA-X-MIX

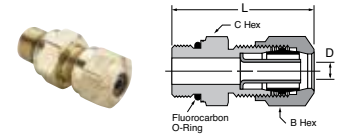

PART NUMBER	TUBE SIZE	METRIC THREAD	B HEX	C HEX	L	D
68NTA-4-MI10	1/4	M10 X 1.0	9/16	9/16	1.33	.140

Note: Fluorocarbon o-ring is standard
For working pressure and Temperature see Air Brake-NTA Section

45° Flare Elbow to Metric Adaptor 159F-X-MIX

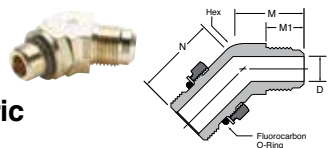

PART NUMBER	TUBE SIZE	METRIC THREAD	HEX	M	M1	N	D
159F-8-MI16	1/2	M16 X 1.5	13/16	1.10	.75	1.16	.36
159F-10-MI27	5/8	M27 X 2.0	1 1/8	1.21	.88	1.50	.50

Note: Fluorocarbon o-ring is standard
For working pressure and Temperature see SAE Flare Section

Beaded Hose Barb 45° Elbow to Metric Thread 179HB-X-MIX

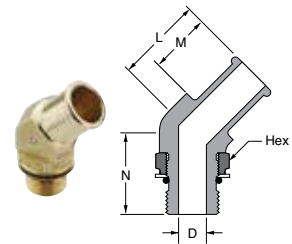

PART NUMBER	HOSE SIZE	METRIC THREAD	HEX	L	M	N	D
179HB-12-MI18	3/4	M18 X 1.5	13/16	1.15	.78	1.16	.44
179HB-16-MI27	1	M27 X 2.0	1 1/16	1.51	.97	1.71	.71

Note: Fluorocarbon o-ring is standard

WARNING: These products can expose you to chemicals including LEAD which is known to the state of California to cause cancer.

Garden Hose Fittings



Parker's Garden Hose Fittings connect garden hose to other garden hose, to pipe or to tubing. Swivel connections allow hose to twist without kinking.

Product Features:

- All brass construction
- 3/4" garden hose thread
- Rubber washer
- Flare, hose barb and pipe end configurations
- High Flow couplings

Markets:

- Industrial
- Mobile
- Factory/process automation

Applications:

- Water Line

Specifications:

Pressure Range Up to 150 PSI (10.3 bar)

Temperature Range +35° to +100° F at 75 PSI
(+1.6° to +37.7° C at 5.1 bar)

Compatible Tubing:

- Garden Hose

Note: 90Gh is intended for use with the 97HC hose clamp or crimped ferrule. All female connector ends should have a rubber washer(901GH-12) inserted prior to use.

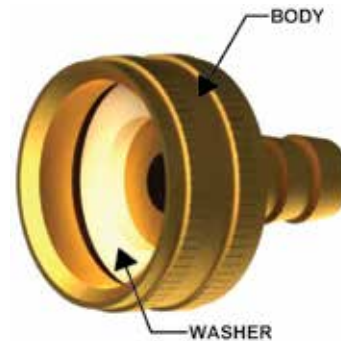

⚠ WARNING These products can expose you to chemicals including CARBON BLACK or LEAD, which are known to the state of California to cause cancer.

Swivel Connector SAE Flare to Female Hose Thread 50GHSV

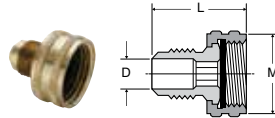

PART NO.	TUBE SIZE	HOSE THREAD	L	M	FLOW DIA. D
50GHSV-6-12	3/8	3/4	1.25	1.15	.297
50GHSV-8-12	1/2	3/4	1.34	1.15	.406

Female Hose to Male Pipe 82GH & 83GH

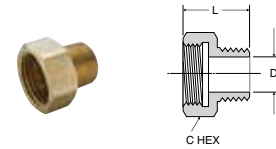

PART NO.	HOSE THREAD	PIPE THREAD	C HEX	L	FLOW DIA. D
82GH-12-8	3/4	1/2	1-3/16	1.20	.562
83GH-12-12	3/4	3/4	1-3/16	1.22	.750

Hose Barb to Male Hose Thread 53GH, 54GH & 55GH

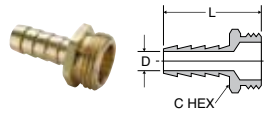

PART NO.	I.D. HOSE SIZE	HOSE THREAD	C HEX	L	FLOW DIA. D
53GH-8-12	1/2	3/4	1-1/16	1.88	.375
54GH-10-12	5/8	3/4	1-1/16	1.88	.500
55GH-12-12	3/4	3/4	1-1/16	1.88	.625

Swivel Connector Female Garden Hose to Male Pipe 88GH

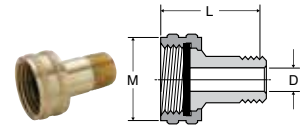

PART NO.	HOSE THREAD	PIPE THREAD	L	M	FLOW DIA. D
88GH-12-4	3/4	1/4	1.69	1.15	.312
88GH-12-6	3/4	3/8	1.69	1.15	.406

Male Hose to Male Pipe 69GH, 70GH, 71GH

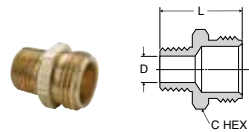

PART NO.	HOSE THREAD	PIPE THREAD	C HEX	L	FLOW DIA. D
69GH-12-4	3/4	1/4	1-1/16	1.25	.410
69GH-12-6	3/4	3/8	1-1/16	1.25	.406
70GH-12-8	3/4	1/2	1-1/16	1.39	.531
71GH-12-12	3/4	3/4	1-1/16	1.41	.750

Swivel Connector Female Garden Hose to Hose Barb 90GH

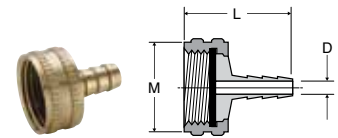

PART NO.	HOSE THREAD	I.D. HOSE SIZE	L	M	FLOW DIA. D
90GH-12-3	3/4	3/16	1.29	1.15	.125
90GH-12-4	3/4	1/4	1.21	1.15	.187
90GH-12-6	3/4	3/8	1.21	1.15	.281
90GH-12-8	3/4	1/2	1.21	1.15	.375
90GH-12-10*	3/4	5/8	1.93	1.19	.500
90GH-12-12*	3/4	3/4	1.93	1.19	.625

*Denotes hex body

Male Hose to Male Hose 75GH

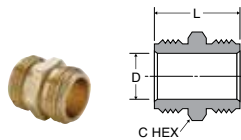

PART NO.	HOSE THREAD	C HEX	L	FLOW DIA. D
75GH-12	3/4	1-1/16	1.25	.750

Male Hose to Female Pipe 78GH, 79GH, 80GH & 81GH

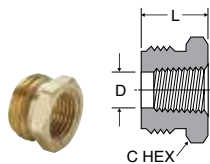

PART NO.	HOSE THREAD	PIPE THREAD	C HEX	L	FLOW DIA. D
78GH-12-4	3/4	1/4	1-1/16	.75	.422
79GH-12-6	3/4	3/8	1-1/16	.75	.562
80GH-12-8	3/4	1/2	1-1/16	.75	.687
81GH-12-12	3/4	3/4	1-3/16	1.28	.719

Knurled Hose Nut 94GH

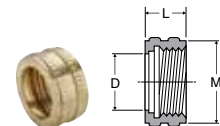

PART NO.	HOSE THREAD	L	M	FLOW DIA. D
94GH-12	3/4	.57	1.15	.808

WARNING These products can expose you to chemicals including CARBON BLACK, or LEAD, which are known to the state of California to cause cancer.

[Click here for CADs, Product Specifications or to Configure Parts Online](#)

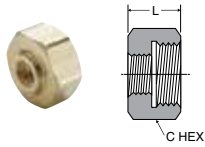

Hose Nut Reducer 95GH

PART NO.	HOSE THREAD	PIPE THREAD	C HEX	L
95GH-12-2	3/4	1/8	1-1/8	.63

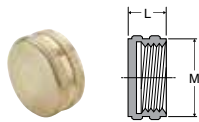

Hose Cap Nut 96GH

PART NO.	HOSE THREAD	L	M
96GH-12	3/4	.50	1.15

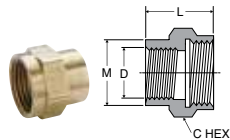

Female Hose to Female Pipe 98GH & 99GH

PART NO.	HOSE THREAD	PIPE THREAD	C HEX	L	M	FLOW DIA. D
98GH-12-8	3/4	1/2	1-3/16	1.14	1.01	.687
99GH-12-12	3/4	3/4	1-3/16	1.25	1.17	.750

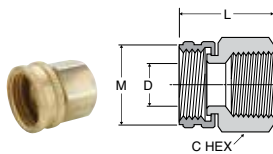

Swivel Connector Female Hose to Female Pipe 98GHSV & 99GHSV

PART NO.	HOSE THREAD	PIPE THREAD	C HEX	L	M	FLOW DIA. D
98GHSV-12-8	3/4	1/2	1	1.27	1.21	.687
99GHSV-12-12	3/4	3/4	1-3/16	1.34	1.21	.687

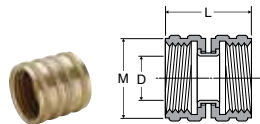

Swivel Nut Connector 101GHSV

PART NO.	HOSE THREAD	L	M	FLOW DIA. D
101GHSV-12	3/4	1.25	1.15	.625



Rubber Garden Hose Coupling Washer 901GH

PART NO.	HOSE THREAD
901GH-12	3/4

NOTE: All female connector ends should have this rubber washer

Hydraulic Quick Couplings/ High Flow Couplings

Applications

Parker Water Service Couplings are used anywhere water hoses are connected and disconnected frequently. They are used on a wide variety of applications including garden hoses, wash down systems, and mobile water tank lines. The unvalved design permits maximum flow with minimum pressure drop.

Features

- Brass and stainless steel construction for heavy duty service.
- Durable 4-ball locking mechanism for secure connections.
- Quality, temperature-resistant nitrile seals for a leak-free service life.

Specifications

- Body Size 3/4"
- Rated Pressure PSI 200 (13.7 bar)
- Rated Flow GPM 28
- Temperature Range (std seals) -40° to +250° F (-40° to 121.1° C)

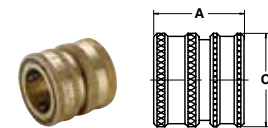

High Flow Coupler 1163-60-BPD

PART NO.	BODY SIZE	THREAD SIZE NH	A	C
1163-60-BPD	3/4	3/4-11 1/2	1.12	1.21

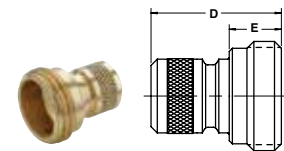

High Flow Nipple 1163-61-BPD

PART NO.	BODY SIZE	THREAD SIZE NH	D	E
1163-61-BPD	3/4	3/4-11 1/2	1.25	.5

WARNING These products can expose you to chemicals including CARBON BLACK or LEAD, which are known to the state of California to cause cancer.



Industrial Valves

Standard Ball Valves

Carbon Steel Ball Valves

Mini Ball Valves

Polypropylene Ball Valves:
LIQUIfit, TrueSeal, and
Par-Barb

Axial Valves

Replacement Componentry

Ball Valve Stem Extensions
Series STX

Needle Valves

Drain Cocks/
Ground Plug Shutoff





GOODYEAR
RUBBER PRODUCTS, INC.

+1.727.342.5087

También puede enviarnos un correo electrónico a ventas@goodyearrubberproducts.com

Female Ports

V500P

Female-Female
p. K8



V502P

Panel Mount
p. K14



V520P

Economy Series
p. K21



V525P

Female-Female
p. K22



V533P

3 Way Diversion
p. K24



V540P

4 Way
p. K24



V600P

6 Port Diversion
p. K29



V633P

6 Port Diversion
p. K29



V500CS

Carbon Steel
p. K31



V502CS

Panel Mount
Carbon Steel
p. K31



V502SS

Panel Mount
Stainless
p. K39



MV709

Micro Valve
p. K40



MV200

Mini Valve
p. K42



MV609

Mini Valve
p. K42



PV609

Plug Valve
p. K50



4203

Axial Valve-NPT
p. K60



4202

Axial Valve-BSPP
p. K60



Male - Male Ports

V591P

90° Valve
p. K26



V591P-X-04

90° Valve
p. K26



PV607

Plug Valve
p. K50



Male - Female Compact High Pressure

XV501PCHP

p. K12



Male-Female Ports

V501P

Male-Female
p. K11



V590P

90° Valve
p. K26



V590P-X-04

90° Valve
p. K26



V501SS

Stainless Steel
p. K37



MV708

Micro Valve
p. K40



MV608

Mini Valve
p. K42



PV608

Plug Valve
p. K50



Barb to Female Port

V500P-HB

Barb to Female Port
p. K27



Solder Ports

V509P

Solder - Solder
p. K17



Straight Thread Ports

V506P

Female - Female
p. K16



V510P

Male - Female
p. K19



V506CS

Carbon Steel
p. K33



Female Ports - High Pressure

V500HP

Female Ports
p. K35



VP500HP

Female Ports-
Padlocking
p. K35



Straight Thread Ports - High Pressure

V506HP

Female Ports
p. K36



VP506HP

Female Ports-
Padlocking
p. K36



WARNING These products can expose you to chemicals including NICKEL, CARBON BLACK, or LEAD, which are known to the state of California to cause cancer.

■ Padlocking

VP500P

Female Ports
p. K8



VP501P

Male - Female
p. K12



VP502P

Panel Mount
p. K14



VP510P

Straight Thread
p. K19



VP520P

p. K21



VP500CS

Carbon Steel
p. K31



VP502CS

Panel Mount
p. K31



VP502SS

Stainless Steel
p. K39



■ Tee Handle

V500P-X-04

Female Ports
p. K9



V501P-X-04

Male - Female
p. K12



V502P-X-04

Panel Mount
p. K14



V510P-X-04

Straight Thread
p. K19



V500CS-X-04

Carbon Steel
p. K31



■ Oval Handle

V500P-X-21

Female Ports
p. K9



V501P-X-21

Male - Female
p. K12



V502P-X-21

Panel Mount
p. K14



V510P-X-21

Straight Thread
p. K19



V500CS-X-21

Carbon Steel
p. K32



V502CS-X-21

Panel Mount -
Carbon Steel
p. K32



V502SS-X-21

Oval Handle
p. K39



■ Short Handle

V502SS-X-20

Panel Mount
p. K39



■ Metric Female Ports

BVGL

Female Ports Long
p. K55



BVGTL

Female Ports Long
p. K55



■ Metric Padlocking

BVG4PLOCK

Female Ports
p. K57



■ Vented

VV500P

Female Ports
p. K8



VV501P

Male-Female
p. K12



VV502P

Panel Mount
p. K14



■ Vented – Padlocking

VVP500P

Female Ports
p. K8



VVP501P

Male-Female
p. K12



VVP502P

Panel Mount
p. K14



⚠ WARNING These products can expose you to chemicals including NICKEL, CARBON BLACK, or LEAD, which are known to the state of California to cause cancer.

■ Polypropylene Ball Valves

VME
Male Elbow
p. K44



VFE
Female Elbow
p. K44



VUC
Union Connector
p. K44



VEU
Elbow Union
p. K44



VMC
Male Connector
p. K45



VFC
Female Connector
p. K45



VUCPB
Union Connector
p. K45



VAS
Angle Stop
p. K45



VME
Male Elbow
p. K45



VFE
Female Elbow
p. K45



VUC
Union Connector
p. K46



VEU
Elbow Union
p. K46



VMC
Male Connector
p. K46



VFC
Female Connector
p. K46



VTEU
Tube Elbow Union
p. K46



VFC
Barbed Female Connector
p. K46



VFE
Barbed Female Elbow
p. K47



VMC
Barbed Male Connector
p. K47



VME
Barbed Male Elbow
p. K47



VUC
Barbed Union Connector
p. K47



VUCPB
Union Connector Barbed x Tube
p. K47



BVC
Ball Valve Clip
p. K47



VUC
Valve Union Connector
p. K48



VMC
Valve Male Connector
p. K48



VFC
Valve Female Connector
p. K48



VFE
Valve Female Elbow
p. K48



VME
Valve Male Elbow
p. K48



VEU
Valve Elbow Union
p. K48



■ Needle Valves

NV101F
Female - Male
p. K65



NV102F
Flare
p. K65



NV103F
Flare - Male Pipe
p. K65



HV104C
Humidifier Valve
p. K65



NV107P
Pipe
p. K66



NV108P
Female - Male
p. K66



NV109P
Female
p. K66



NV311P
Poly-Tite
p. K66



NV312P
Poly-Tite
p. K66



NV104C-NV104CA
Compression - Pipe
p. K65



NV105C-NV105CA
Compression
p. K65



NV106C-NV106CA
Compression - Pipe
p. K66



■ Shutoff Valves

V203F
Flare
p. K68



V204F
Flare - Pipe
p. K68



V401P
Pipe
p. K68



V402P
Female - Pipe
p. K68



V403P
Female
p. K68



V406P
3 Way
p. K68



V407P
4 Way
p. K68



V303C-V303CA
Compression
p. K68



V304C-V304CA
Compression - Pipe
p. K68



DC601
Pipe
p. K68



⚠ WARNING These products can expose you to chemicals including NICKEL, CARBON BLACK, or LEAD, which are known to the state of California to cause cancer.

■ Drain Cocks

DCR601

Internal Seal
p. K69



DC602

Internal Seal
p. K69



DC603

Internal Seal
p. K69



DC604

External Seal
p. K69



DC606

External Seal
p. K69



DC607

Bib Drain
p. K69



■ Auxiliary

PVMB-001

Mounting Bracket
p. K50



V502P-X-ACT

Actuator
p. K52



V502SS-X-ACT

Actuator
p. K52



V502P-X-SUB

Sub-Assembly
p. K53



V502SS-X-SUB

Sub-Assembly
p. K53



ACT-P-X-KIT

Brass Actuator Kit
p. K53



ACT-SS-X-KIT

Stainless
Actuator Kit
p. K53



STX-P

Stem Extension
p. K63



HV104C-KIT

Humidifier Valve Kit
p. K65



SPV104C-KIT

Self Piercing Kit
p. K65



WARNING These products can expose you to chemicals including NICKEL, CARBON BLACK, or LEAD, which are known to the state of California to cause cancer.

Ball Valves

Brass Series 500



Parker's industrial ball valves are intended for general purpose use. Ball valves are intended for use in the fully open or closed positions. Throttling of the valve may result in premature seal failure and/or inability to turn the valve handle.

Product Features:

- Forged brass body
- Chrome plated brass ball
- PTFE seats/seals
- Steel handle

Style:

- V-Valve
- VP-Valve, padlocking handle
- VV-Valve, vented
- VVP-Valve, vented, padlocking handle

Type:

- 500-Female/Female PTF ports

Material:

- P-Brass
- PN-Nickel plated

Options:

- 01-Stainless Steel Ball & Stem
- 02-Stainless Steel Handle & Nut
- 03-Stainless Steel Ball, Stem, Handle & Nut
- 04-Tee Handle
- 08-Unmarked yellow vinyl handle cover
- 21-Oval Handle

Specifications:

Pressure Range:

- 600 WOG , Cold Non-shock
- Saturated Steam up to 150 PSI (10.3 bar)
- Vacuum Service to 29 Inches Hg
- Vented up to 250 PSI (17.2 bar)

Temperature Range

- 0° to +350° F (-17.7° to +176.6° C)

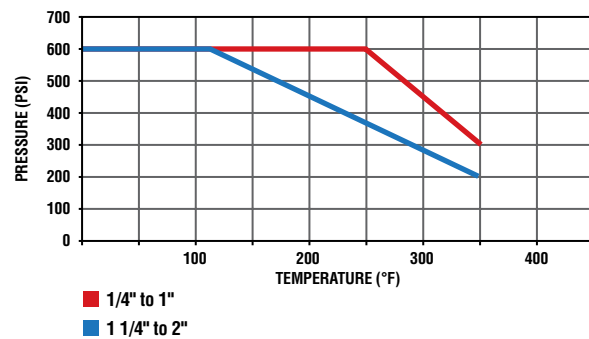

FLOW DATA	
VALVE SIZE	CV
1/4	4.0
3/8	5.8
1/2	12.0
3/4	25.0
1	35.0
1-1/4*	57.0
1-1/2*	92.0
2*	224.0

*For these part numbers only the * options are available.

WARNING These products can expose you to chemicals including NICKEL or LEAD, which are known to the state of California to cause cancer and LEAD.

[Click here for CADs, Product Specifications or to Configure Parts Online](#)

Female-Female Pipe Ends V500P

PART NO.	PIPE THREAD [PTF]	B HEX	C HEX	H	L	M	N	FLOW DIA. D
V500P-4	1/4	15/16	15/16	3.96	4.90	2.03	2.47	.375
V500P-6	3/8	15/16	15/16	3.96	4.90	2.03	2.47	.375
V500P-8	1/2*	1-1/16	1-1/16	3.96	5.00	2.20	2.58	.500
V500P-12	3/4**	1-1/4	1-5/16	3.96	5.25	2.42	2.81	.685
V500P-16	1**	1-1/2	1-9/16	3.96	5.34	2.75	3.08	.875

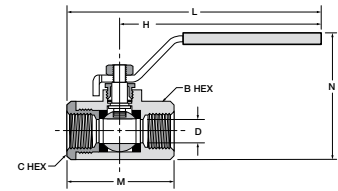

Female-Female Pipe Ends V500P-20, V500P-24, V500P-32

PART NO.	PIPE THREAD [NPT]	OCTAGON	H	L	M	N	FLOW DIA. D
V500P-20	1-1/4	1.93	6.22	8.05	3.66	3.01	1.18
V500P-24	1-1/2	2.13	6.22	8.23	4.02	3.25	1.50
V500P-32	2	2.69	6.22	8.58	4.76	3.52	1.89

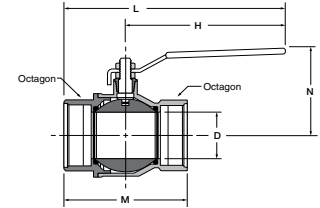

Vented, Female Pipe Ends VV500P

PART NO.	PIPE THREAD [PTF]	B HEX	C HEX	K	H	L	M	N	D FLOW Ø
VV500P-4	1/4	15/16	15/16	1.11	3.96	4.90	2.03	2.47	.375
VV500P-6	3/8	15/16	15/16	1.11	3.96	4.90	2.03	2.47	.375
VV500P-8	1/2*	1-1/16	1-1/16	1.23	3.96	5.00	2.20	2.58	.500
VV500P-12	3/4**	1-1/4	1-5/16	1.45	3.96	5.25	2.42	2.81	.685
VV500P-16	1**	1-1/2	1-9/16	1.58	3.96	5.34	2.75	3.08	.875

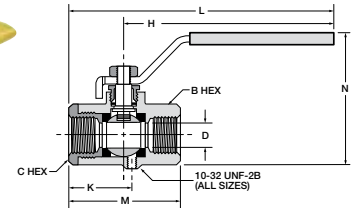

Locking Handle, Female Pipe Ends VP500P

PART NO.	PIPE THREAD [PTF]	B HEX	C HEX	H	L	M	N	D FLOW Ø
VP500P-4	1/4	15/16	15/16	3.96	4.90	2.03	2.47	.375
VP500P-6	3/8	15/16	15/16	3.96	4.90	2.03	2.47	.375
VP500P-8	1/2*	1-1/16	1-1/16	3.96	5.00	2.20	2.58	.500
VP500P-12	3/4**	1-1/4	1-5/16	3.96	5.25	2.42	2.81	.685
VP500P-16	1**	1-1/2	1-9/16	3.96	5.34	2.75	3.08	.875
FOR USE WITH 5/16" Ø SHANK LOCK; .33Ø								
VP500P-20	1-1/4	1-15/16	1-15/16	6.22	8.05	3.66	4.04	1.180
VP500P-24	1-1/2	2-1/8	2-1/8	6.22	8.23	4.02	4.52	1.500
VP500P-32	2	2-11/16	2-11/16	6.22	8.60	4.76	5.07	1.890
FOR USE WITH 9/32" Ø SHANK LOCK; .31Ø								

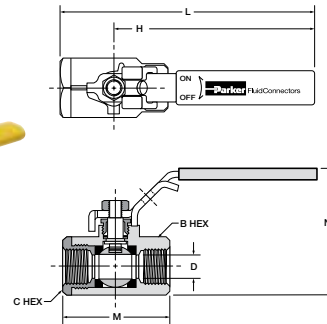

OSHA 29 CFR Part 1910 Vented, Locking Handle, Female Pipe Ends VVP500P

PART NO.	PIPE THD [PTF]	B HEX	C HEX	K	H	L	M	N	D FLOW Ø
VVP500P-4	1/4	15/16	15/16	1.11	3.96	4.90	2.03	2.47	.375
VVP500P-6	3/8	15/16	15/16	1.11	3.96	4.90	2.03	2.47	.375
VVP500P-8	1/2*	1-1/16	1-1/16	1.23	3.96	5.00	2.20	2.58	.500
VVP500P-12	3/4**	1-1/4	1-5/16	1.45	3.96	5.25	2.42	2.81	.685
VVP500P-16	1**	1-1/2	1-9/16	1.58	3.96	5.34	2.75	3.08	.875
FOR USE WITH 5/16" Ø SHANK LOCK									

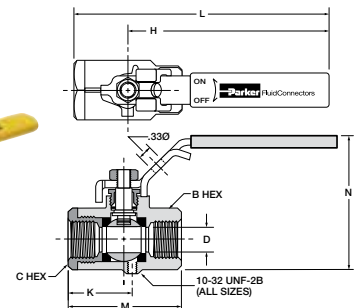

*PTF Special Short. **PTF SPL Extra Short

WARNING These products can expose you to chemicals including NICKEL or LEAD, which are known to the state of California to cause cancer and LEAD.

[Click here for CADs, Product Specifications or to Configure Parts Online](#)

Tee Handle, Female Pipe Ends V500P-X-04

PART NO.	PIPE THREAD (PTF)	B HEX	C HEX	H	L	M	N	D FLOW Ø
V500P-4-04	1/4	15/16	15/16	1.25	2.50	2.03	1.87	.375
V500P-6-04	3/8	15/16	15/16	1.25	2.50	2.03	1.87	.375
V500P-8-04	1/2*	1-1/16	1-1/16	1.25	2.50	2.20	1.98	.500
V500P-12-04	3/4**	1-1/4	1-5/16	1.25	2.50	2.42	2.20	.685
V500P-16-04	1**	1-1/2	1-9/16	1.25	2.50	2.75	2.48	.875

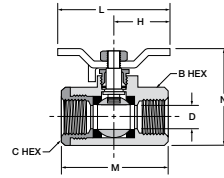

Oval Handle, Female Pipe Ends V500P-X-21

PART NO.	PIPE THREAD (PTF)	B HEX	C HEX	H	L	M	N	D FLOW Ø
V500P-4-21	1/4	15/16	15/16	1.74	3.49	2.03	2.38	.375
V500P-6-21	3/8	15/16	15/16	1.74	3.49	2.03	2.38	.375
V500P-8-21	1/2*	1-1/16	1-1/16	1.74	3.49	2.20	2.49	.500
V500P-12-21	3/4**	1-1/4	1-5/16	1.74	3.48	2.42	2.71	.685
V500P-16-21	1**	1-1/2	1-9/16	1.74	3.48	2.75	2.99	.875

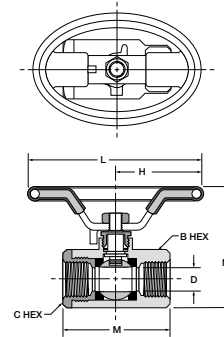

*PTF Special Short. **PTF SPL Extra Short

WARNING These products can expose you to chemicals including NICKEL or LEAD, which are known to the state of California to cause cancer and LEAD.

Ball Valves Brass Series 501



Product Features:

- Forged brass body
- Chrome plated brass ball
- PTFE seats/seals
- Steel handle

Style:

- V-Valve
- VP-Valve, padlocking handle
- VV-Valve, vented
- VVP-Valve, vented, padlocking handle

Type:

- 501-Male/Female PTF ports

Material:

- P-Brass
- PN-Nickel plated

Options:

- 01-Stainless Steel Ball & Stem
- 02-Stainless Steel Handle & Nut
- 03-Stainless Steel Ball, Stem, Handle & Nut
- 04-Tee Handle
- 08-Unmarked yellow vinyl handle cover
- 21-Oval Handle

Pressure Range:

- 600 WOG , Cold Non-shock
- Saturated Steam up to 150 PSI (10.3 bar)
- Vacuum Service to 29 Inches Hg
- Vented up to 250 PSI (17.2 bar)
- XV501PCHP up to 2000PSI (137.8 bar)

Temperature Range

- 0° to +350° F (-17.7° to +176.6° C)

Flow Data

VALVE SIZE	CV	VALVE SIZE	CV
1/4	6.3	3/4	25.0
3/8	5.7	1	35.0
1/2	10.0		

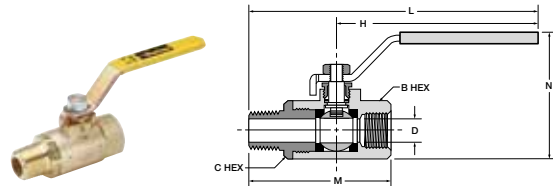
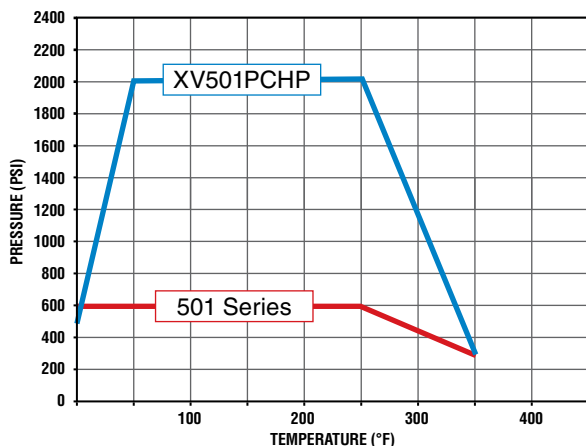

Male-Female Pipe Ends V501P

PART NO.	FEMALE PIPE THRD [PTF]	MALE PIPE THRD [NPTF]	B HEX	C HEX	H	L	M	N	D FLOW Ø
V501P-4	1/4	1/4	15/16	15/16	3.96	5.46	2.59	2.47	.344
V501P-6	3/8	3/8	15/16	15/16	3.96	5.46	2.59	2.47	.375
V501P-8	1/2*	1/2	1-1/16	1-1/16	3.96	5.75	2.94	2.58	.500
V501P-12	3/4**	3/4*	1-1/4	1-5/16	3.96	5.83	3.00	2.81	.685
V501P-16	1**	1*	1-1/2	1-9/16	3.96	6.19	3.60	3.08	.875

*PTF Special Short. **PTF SPL Extra Short

⚠ WARNING These products can expose you to chemicals including NICKEL or LEAD, which are known to the state of California to cause cancer and LEAD.

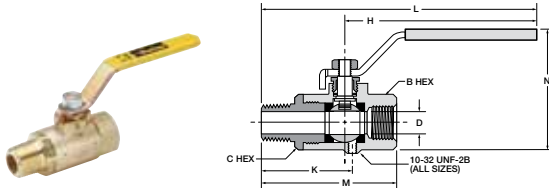

Vented, Male-Female Pipe Ends VV501P

PART NO.	FEMALE PIPE THRD [PTF]	MALE PIPE THRD [NPTF]	B HEX	C HEX	K	H	L	M	N	D FLOW Ø
VV501P-4	1/4	1/4	15/16	15/16	1.67	3.96	5.46	2.59	2.47	.344
VV501P-6	3/8	3/8	15/16	15/16	1.67	3.96	5.46	2.59	2.47	.375
VV501P-8	1/2*	1/2	1-1/16	1-1/16	1.98	3.96	5.75	2.95	2.58	.500
VV501P-12	3/4**	3/4*	1-1/4	1-5/16	2.03	3.96	5.83	3.00	2.81	.685
VV501P-16	1**	1*	1-1/2	1-9/16	2.43	3.96	6.19	3.60	3.08	.875

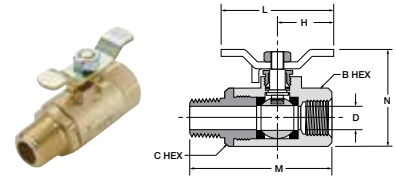

Tee Handle, Male-Female Pipe Ends V501P-X-04

PART NO.	FEMALE PIPE THRD [PTF]	MALE PIPE THRD [NPTF]	B HEX	C HEX	H	L	M	N	D FLOW Ø
V501P-4-04	1/4	1/4	15/16	15/16	1.25	2.50	2.59	1.87	.344
V501P-6-04	3/8	3/8	15/16	15/16	1.25	2.50	2.59	1.87	.375
V501P-8-04	1/2*	1/2	1-1/16	1-1/16	1.25	2.50	2.95	1.98	.500
V501P-12-04	3/4**	3/4	1-1/4	1-5/16	1.25	2.50	3.00	2.20	.685
V501P-16-04	1**	1	1-1/2	1-9/16	1.25	2.50	3.60	2.48	.875

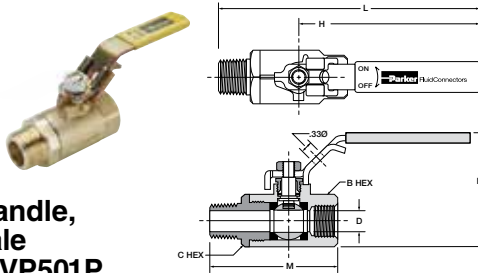

Locking Handle, Male-Female Pipe Ends VP501P

PART NO.	FEMALE PIPE THRD [PTF]	MALE PIPE THRD [NPTF]	B HEX	C HEX	H	L	M	N	D FLOW Ø
VP501P-4	1/4	1/4	15/16	15/16	3.96	5.46	2.59	2.47	.344
VP501P-6	3/8	3/8	15/16	15/16	3.96	5.46	2.59	2.47	.375
VP501P-8	1/2*	1/2	1-1/16	1-1/16	3.96	5.75	2.95	2.58	.500
VP501P-12	3/4**	3/4*	1-1/4	1-5/16	3.96	5.83	3.00	2.81	.685
VP501P-16	1**	1*	1-1/2	1-9/16	3.96	6.19	3.60	3.08	.875

For use with 5/16" Ø shank lock

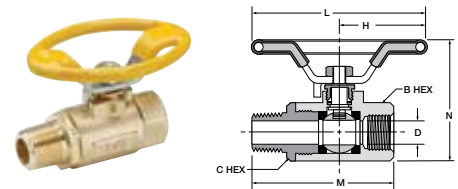

Oval Handle, Male-Female Pipe Ends V501P-X-21

PART NO.	FEMALE PIPE THRD [PTF]	MALE PIPE THRD [NPTF]	B HEX	C HEX	H	L	M	N	D FLOW Ø
V501P-4-21	1/4	1/4	15/16	15/16	1.74	3.49	2.59	2.38	.344
V501P-6-21	3/8	3/8	15/16	15/16	1.74	3.49	2.59	2.38	.375
V501P-8-21	1/2*	1/2	1-1/16	1-1/16	1.74	3.49	2.95	2.49	.500
V501P-12-21	3/4**	3/4	1-1/4	1-5/16	1.74	3.48	3.00	2.71	.685
V501P-16-21	1**	1	1-1/2	1-9/16	1.74	3.48	3.60	2.99	.875

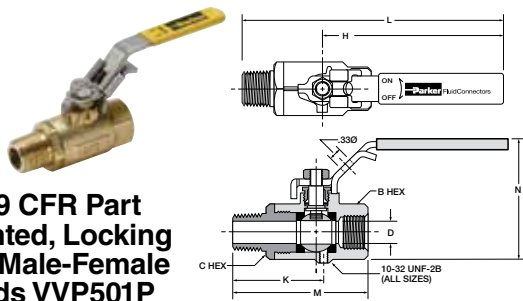

OSHA 29 CFR Part 1910 Vented, Locking Handle, Male-Female Pipe Ends VVP501P

PART NO.	FEMALE PIPE THRD [PTF]	MALE PIPE THRD [NPTF]	B HEX	C HEX	K	H	L	M	N	D FLOW Ø
VVP501P-4	1/4	1/4	15/16	15/16	1.67	3.96	5.46	2.59	2.47	.344
VVP501P-6	3/8	3/8	15/16	15/16	1.67	3.96	5.46	2.59	2.47	.375
VVP501P-8	1/2*	1/2	1-1/16	1-1/16	1.98	3.96	5.75	2.95	2.58	.500
VVP501P-12	3/4**	3/4	1-1/4	1-5/16	2.03	3.96	5.83	3.00	2.81	.685
VVP501P-16	1**	1	1-1/2	1-9/16	2.43	3.96	6.19	3.60	3.08	.875

For use with 5/16" Ø shank lock

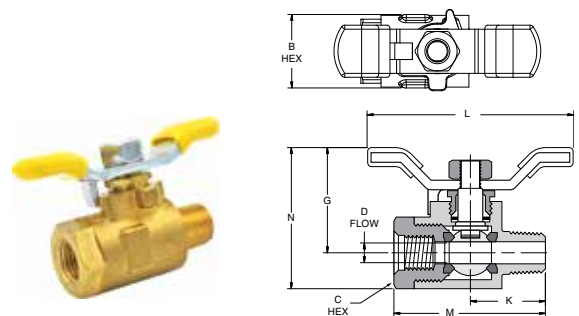

Compact High Pressure XV501PCHP

PART NO.	FEMALE PIPE THRD [PTF]	MALE PIPE THRD [NPTF]	B HEX	C HEX	G	K	L	M	N	D FLOW Ø
XV501PCHP-4	1/4	1/4	15/16	13/16	1.33	.95	2.62	1.92	1.79	.25

*PTF Special Short. **PTF SPL Extra Short

WARNING These products can expose you to chemicals including NICKEL or LEAD, which are known to the state of California to cause cancer and LEAD.

Ball Valves Brass Series 502



Product Features:

- Forged brass body
- Chrome plated brass ball
- PTFE seats/seals
- Steel handle

Style:

- V-Valve
- VP-Valve, padlocking handle
- VV-Valve, vented
- VVP-Valve, vented, padlocking handle

Type:

- 502-Female/Female PTF ports

Material:

- P-Brass
- PN-Nickel plated

Options:

- 01-Stainless Steel Ball & Stem
- 02-Stainless Steel Handle & Nut
- 03-Stainless Steel Ball, Stem, Handle & Nut
- 04-Tee Handle
- 08-Unmarked yellow vinyl handle cover
- 21-Oval Handle

Specifications:

Pressure Range:

- 600 WOG , Cold Non-shock
- Saturated Steam up to 150 PSI (10.3 bar)
- Vacuum Service to 29 Inches Hg
- Vented up to 250 PSI (17.2 bar)

Temperature Range

- 0° to +350° F (-17.7° to +176.6° C)

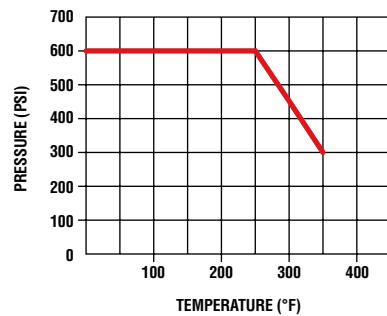

FLOW DATA	
VALVE SIZE	CV
1/4	4.0
3/8	5.8
1/2	12.0
3/4	25.0
1	35.0

Mounting detail for all sizes

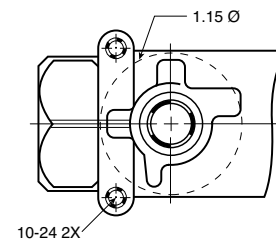

⚠ WARNING These products can expose you to chemicals including NICKEL or LEAD, which are known to the state of California to cause cancer, and LEAD.

Click here for CADs, Product Specifications or to Configure Parts Online

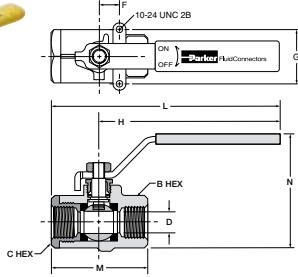

Female-Female Pipe Ends, Panel Mount V502P

PART NO.	PIPE THD. (PTF)	B HEX	C HEX	F	G	H	L	M	N	FLOW DIA. D
V502P-4	1/4	15/16	15/16	.50	1.12	3.96	4.90	2.03	2.47	.375
V502P-6	3/8	15/16	15/16	.50	1.12	3.96	4.90	2.03	2.47	.375
V502P-8	1/2"	1-1/16	1-1/16	.50	1.12	3.96	5.06	2.20	2.58	.500
V502P-12	3/4**	1-1/4	1-5/16	.87	1.37	3.96	5.25	2.42	2.81	.685
V502P-16	1**	1-1/2	1-9/16	.87	1.37	3.96	5.34	2.75	3.08	.875

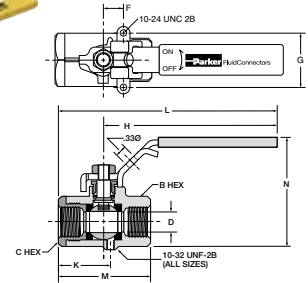

OSHA 29 CFR Part 1910 Vented, Locking Handle, Female Pipe Ends, Panel Mount VVP502P

PART NO.	PIPE THD. (PTF)	B HEX	C HEX	F	G	K	H	L	M	N	D FLOW Ø
VVP502P-4	1/4	15/16	15/16	.50	1.12	1.11	3.96	4.90	2.03	2.47	.375
VVP502P-6	3/8	15/16	15/16	.50	1.12	1.11	3.96	4.90	2.03	2.47	.375
VVP502P-8	1/2"	1-1/16	1-1/16	.50	1.12	1.23	3.96	5.06	2.20	2.58	.500
VVP502P-12	3/4**	1-1/4	1-5/16	.87	1.37	1.45	3.96	5.25	2.42	2.81	.685
VVP502P-16	1**	1-1/2	1-9/16	.87	1.37	1.58	3.96	5.34	2.75	3.08	.875

For use with 5/16" Ø shank lock

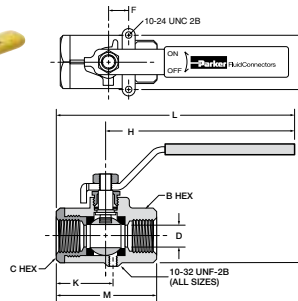

Vented, Female-Female Pipe Ends, Panel Mount VV502P

PART NO.	PIPE THD. (PTF)	B HEX	C HEX	F	G	K	H	L	M	N	D FLOW Ø
VV502P-4	1/4	15/16	15/16	.50	1.12	1.11	3.96	4.90	2.03	2.47	.375
VV502P-6	3/8	15/16	15/16	.50	1.12	1.11	3.96	4.90	2.03	2.47	.375
VV502P-8	1/2"	1-1/16	1-1/16	.50	1.12	1.23	3.96	5.06	2.20	2.58	.500
VV502P-12	3/4**	1-1/4	1-5/16	.87	1.37	1.45	3.96	5.25	2.42	2.81	.685
VV502P-16	1**	1-1/2	1-9/16	.87	1.37	1.58	3.96	5.34	2.75	3.08	.875

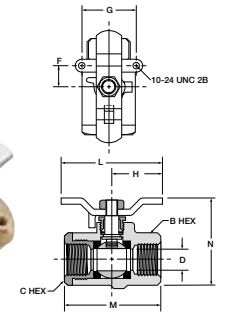

Tee Handle, Female Pipe Ends, Panel Mount V502P-X-04

PART NO.	PIPE THD. (PTF)	B HEX	C HEX	F	G	H	L	M	N	D FLOW Ø
V502P-4-04	1/4	15/16	15/16	.50	1.12	1.25	2.50	2.03	1.87	.375
V502P-6-04	3/8	15/16	15/16	.50	1.12	1.25	2.50	2.03	1.87	.375
V502P-8-04	1/2"	1-1/16	1-1/16	.50	1.12	1.25	2.50	2.20	1.98	.500
V502P-12-04	3/4**	1-1/4	1-5/16	.87	1.37	1.25	2.50	2.42	2.20	.685
V502P-16-04	1**	1-1/2	1-9/16	.87	1.37	1.25	2.50	2.75	2.48	.875

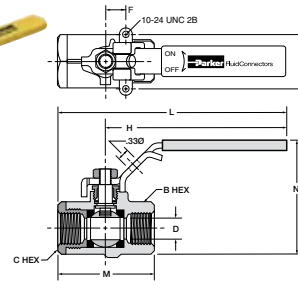

Locking Handle, Female Pipe Ends, Panel Mount VP502P

PART NO.	PIPE THD. (PTF)	B HEX	C HEX	F	G	H	L	M	N	D FLOW Ø
VP502P-4	1/4	15/16	15/16	.50	1.12	3.96	4.90	2.03	2.47	.375
VP502P-6	3/8	15/16	15/16	.50	1.12	3.96	4.90	2.03	2.47	.375
VP502P-8	1/2"	1-1/16	1-1/16	.50	1.12	3.96	5.06	2.20	2.58	.500
VP502P-12	3/4**	1-1/4	1-5/16	.87	1.37	3.96	5.25	2.42	2.81	.685
VP502P-16	1**	1-1/2	1-9/16	.87	1.37	3.96	5.34	2.75	3.08	.875

For use with 5/16" Ø shank lock

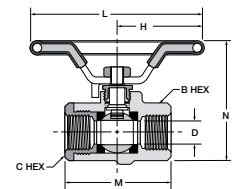

Oval Handle, Female Pipe Ends, Panel Mount V502P-X-21

PART NO.	PIPE THD. (PTF)	B HEX	C HEX	H	L	M	N	D FLOW Ø
V502P-4-21	1/4	15/16	15/16	1.74	3.49	2.03	2.38	.375
V502P-6-21	3/8	15/16	15/16	1.74	3.49	2.03	2.38	.375
V502P-8-21	1/2"	1-1/16	1-1/16	1.74	3.49	2.20	2.49	.500
V502P-12-21	3/4**	1-1/4	1-5/16	1.74	3.48	2.42	2.71	.685
V502P-16-21	1**	1-1/2	1-9/16	1.74	3.48	2.75	2.99	.875

*PTF Special Short. **PTF SPL Extra Short

WARNING These products can expose you to chemicals including NICKEL or LEAD, which are known to the state of California to cause cancer and LEAD.

Ball Valve Brass Series 506



Product Features:

- Forged brass body
- Chrome plated brass ball
- PTFE seats/seals
- Steel handle

Style:

- V-Valve
- VP-Valve, padlocking handle

Type:

- 506-Female/Female SAE J1926-1 Ports

Material:

- P-Brass
- PN-Nickel plated

Options:

- 01-Stainless Steel Ball & Stem
- 02-Stainless Steel Handle & Nut
- 03-Stainless Steel Ball, Stem, Handle & Nut
- 04-Tee Handle
- 08-Unmarked yellow vinyl handle cover
- 21-Oval Handle

Specifications:

Pressure Range:

- 600 WOG , Cold Non-shock
- Saturated Steam up to 150 PSI (10.3 bar)
- Vacuum Service to 29 Inches Hg

Temperature Range

- 0° to +350° F (-17.7° to +176.6° C)

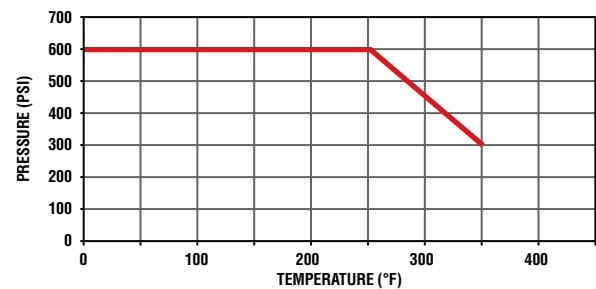

WARNING These products can expose you to chemicals including NICKEL or LEAD, which are known to the state of California to cause cancer and LEAD.

[Click here for CADs, Product Specifications or to Configure Parts Online](#)

Female/Female, Straight Thread O-Ring Port V506P

PART NO.	STRT. THREAD	B HEX	C HEX	H	L	M	N	D FLOW Ø
V506P-4	7/16-20	15/16	15/16	3.96	5.01	2.20	2.47	.375
V506P-6	9/16-18	15/16	15/16	3.96	5.07	2.26	2.47	.375
V506P-8	3/4-16	1-1/16	1-1/16	3.96	5.18	2.42	2.60	.500
V506P-12	1-1/16-12	1-1/4	1-5/16	3.96	5.87	3.46	2.81	.685
V506P-16	1-5/16-12	1-1/2	1-9/16	3.96	5.96	3.68	3.08	.875

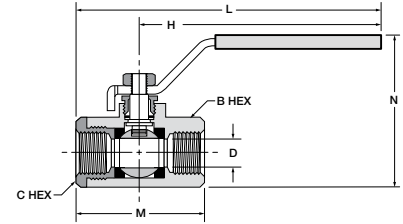

Female/Female, Straight Thread O-Ring Port V506P-20, V506P-24, V506P-32

PART NO.	STRT. THREAD	B OCT	C OCT	H	L	M	N	D FLOW Ø
V506P-20	1 5/8-12	1.93	1.93	6.22	8.05	3.66	3.01	1.18
V506P-24	1 7/8-12	2.13	2.13	6.22	8.23	4.02	3.25	1.50
V506P-32	2 1/2-12	2.85	2.85	6.22	8.60	4.76	3.52	1.89

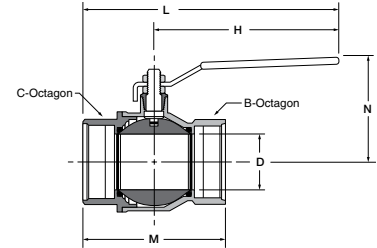

WARNING These products can expose you to chemicals including NICKEL or LEAD, which are known to the state of California to cause cancer and LEAD.

Ball Valves Brass Series 509



Product Features:

- Forged brass body
- Chrome plated brass ball
- PTFE seats/seals
- Steel handle

Style:

- V-Valve

Type:

- 509-Solder Ends

Material:

- P-Brass

Specifications:

Pressure Range:

- 600 WOG , Cold Non-shock
- Saturated Steam up to 150 PSI (10.3 bar)

Temperature Range

- Nylon: 0° to +350° F (-17.7° to +176.6° C)
- Solder temperature not to exceed 470° F (243.3° C)

Solder Cup Ends V509P

PART NO.	TUBE SIZE	E	G	H	L	M	N	FLOW DIA. D
V509P-8	1/2	.630	.49	3.94	5.00	2.24	1.69	.55
V509P-12	3/4	.877	.75	4.72	6.10	2.85	1.97	.75
V509P-16	1	1.128	.90	4.72	6.40	3.35	2.13	.94
V509P-20	1 1/4	1.378	.96	6.22	8.13	3.82	3.01	1.18
V509P-24	1 1/2	1.628	1.10	6.22	8.46	4.49	3.25	1.50
V509P-32	2	2.128	1.34	6.22	8.94	5.43	3.52	1.89

FLOW DATA	
VALVE SIZE	CV
1/2"	26
3/4"	69
1"	91
1 1/4"	127
1 1/2"	299
2"	425

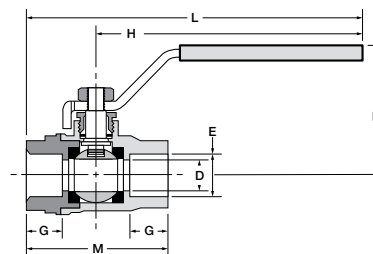

*For these part numbers only the * options are available.

Ball Valves Brass Series 510



Product Features:

- Forged brass body
- Chrome plated brass ball
- PTFE seats/seals
- Steel handle

Style:

- V-Valve
- VP-Valve, padlocking handle

Type:

- 510-Male/Female Straight Thread O-ring SAE J1926

Material:

- P-Brass

Options:

- 01-Stainless Steel Ball & Stem
- 02-Stainless Steel Handle & Nut
- 03-Stainless Steel Ball, Stem, Handle & Nut
- 04-Tee Handle
- 08-Unmarked yellow vinyl handle cover
- 21-Oval Handle

Specifications:

Pressure Range:

- 600 WOG , Cold Non-shock
- Saturated Steam up to 150 PSI (10.3 bar)
- Vacuum Service to 29 Inches Hg
- Vented up to 250 PSI (17.2 bar)

Temperature Range

- 0° to +350° F (-17.7° to +176.6° C)

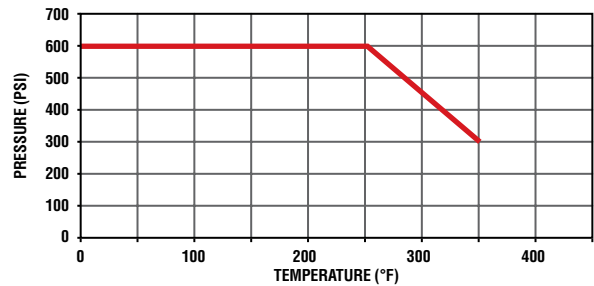

FLOW DATA	
VALVE SIZE	CV
1/4	.8
3/8	2.1
1/2	5.3
5/8	7.6
3/4	13.0
1	33.0

WARNING These products can expose you to chemicals including NICKEL or LEAD, which are known to the state of California to cause cancer and LEAD.

[Click here for CADs, Product Specifications or to Configure Parts Online](#)

Male-Female, Straight Thread O-Ring Port V510P

PART NO.	STRT. THREAD	B HEX	C HEX	H	L	M	N	D FLOW Ø
V510P-4	7/16-20	15/16	15/16	3.96	5.61	2.85	2.47	.188
V510P-6	9/16-18	15/16	15/16	3.96	5.68	2.92	2.47	.281
V510P-8	3/4-16	1-1/16	1-1/16	3.96	5.88	3.17	2.58	.422
V510P-10	7/8-14	1-1/4	1-5/16	3.96	6.31	3.90	2.81	.500
V510P-12	1-1/16-12	1-1/4	1-5/16	3.96	6.44	4.03	2.81	.656
V510P-16	1-5/16-12	1-1/2	1-9/16	3.96	6.56	4.28	3.08	.875

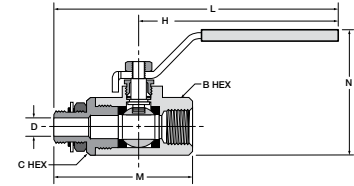

Locking Handle, Straight Thread O-Ring Port VP510P

PART NO.	STRT. THREAD	B HEX	C HEX	H	L	M	N	D FLOW Ø
VP510P-4	7/16-20	15/16	15/16	3.96	5.61	2.85	2.47	.188
VP510P-6	9/16-18	15/16	15/16	3.96	5.68	2.92	2.47	.281
VP510P-8	3/4-16	1-1/16	1-1/16	3.96	5.88	3.17	2.58	.422
VP510P-10	7/8-14	1-1/4	1-5/16	3.96	6.31	3.90	2.81	.500
VP510P-12	1-1/16-12	1-1/4	1-5/16	3.96	6.44	4.03	2.81	.656

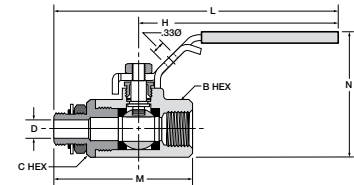

For use with 5/16" Ø shank lock

Tee Handle, Straight Thread O-Ring Port V510P-X-04

PART NO.	STRT. THREAD	B HEX	C HEX	H	L	M	N	D FLOW Ø
V510P-4-04	7/16-20	15/16	15/16	1.25	2.50	2.85	1.87	.188
V510P-6-04	9/16-18	15/16	15/16	1.25	2.50	2.92	1.87	.281
V510P-8-04	3/4-16	1-1/16	1-1/16	1.25	2.50	3.17	1.98	.422
V510P-10-04	7/8-14	1-1/4	1-5/16	1.25	2.50	3.90	2.20	.500
V510P-12-04	1-1/16-12	1-1/4	1-5/16	1.25	2.50	4.03	2.20	.656
V510P-16-04	1-5/16-12	1-1/2	1-9/16	1.25	2.50	4.28	2.48	.875

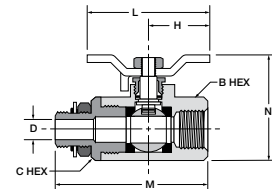

Oval Handle, Straight Thread O-Ring Port V510P-X-21

PART NO.	STRT. THREAD	B & C HEX	H	L	M	N	D FLOW Ø
V510P-4-21	7/16-20	15/16	1.74	3.49	2.85	2.38	.188
V510P-6-21	9/16-18	15/16	1.74	3.49	2.92	2.38	.281
V510P-8-21	3/4-16	1 1/16	1.74	3.49	3.17	2.49	.422
V510P-12-21	1-1/16-12	1-1/4 (B)	1.75	3.49	4.03	2.71	.656
		1-5/16 (C)					

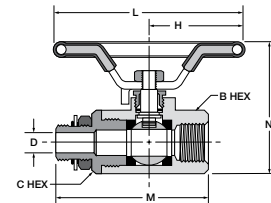

WARNING These products can expose you to chemicals including NICKEL or LEAD, which are known to the state of California to cause cancer and LEAD.

[Click here for CADs, Product Specifications or to Configure Parts Online](#)

Ball Valves Brass Series 520



Product Features:

- Forged brass body
- Chrome plated brass ball
- PTFE seats/seals
- Fluorocarbon Stem O-rings
- Steel handle

Style:

- V-Valve
- VP-Valve, padlocking handle

Type:

- 520-Female/Female NPT Ports

Material:

- P-Brass

Options:

- 04-Tee Handle

Specifications:

Pressure Range:

- 600 WOG Cold Non-shock 1/4" – 2"
- 450 WOG, Cold Non-shock 2 1/2" – 3"
- Saturated Steam up to 150 PSI (10.3 bar)
- Vacuum Service to 29 Inches Hg

Temperature Range

- -40° to +350° F (-40° to +176.6° C)

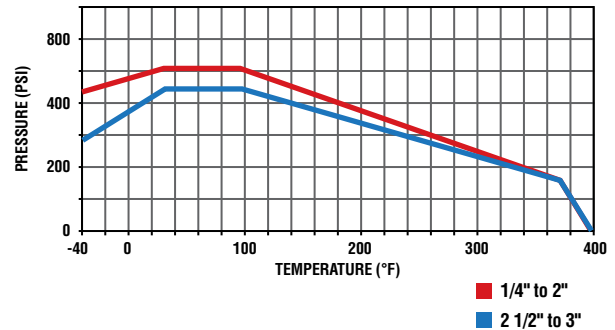

U.L. LISTED	
CATEGORY	
YSDT	LP-GAS SHUT-OFF VALVES
YRBX	FLAMMABLE LIQUID SHUT-OFF VALVES
YRPV	GAS SHUT-OFF VALVES
YQNZ	COMPRESSED GAS SHUT-OFF VALVES

WARNING These products can expose you to chemicals including NICKEL or LEAD, which are known to the state of California to cause cancer and LEAD.

Female Pipe Ends V520P

PART NO.	PIPE THREAD [NPT]	B OCTAGON	C OCTAGON	H	L	M	N	D FLOW Ø
V520P-4	1/4-18	.67	.67	3.94	4.83	1.77	1.50	.310
V520P-6	3/8-18	.79	.79	3.94	4.83	1.77	1.50	.400
V520P-8	1/2-14	.98	.98	3.94	5.10	2.32	1.69	.600
V520P-12	3/4-14	1.22	1.22	4.72	5.98	2.52	1.97	.790
V520P-16	1-11.5	1.57	1.57	4.72	6.32	3.19	2.13	1.000
V520P-20	1-1/4	1.93	1.93	6.22	8.05	3.66	2.82	1.180
V520P-24	1-1/2	2.13	2.13	6.22	8.23	4.02	3.06	1.570
V520P-32	2	2.69	2.69	6.22	8.58	4.76	3.33	2.000
V520P-40	2-1/2	3.35	3.35	10.04	13.11	6.14	5.20	2.520
V520P-48	3	3.89	3.89	10.04	13.52	6.97	5.51	3.000

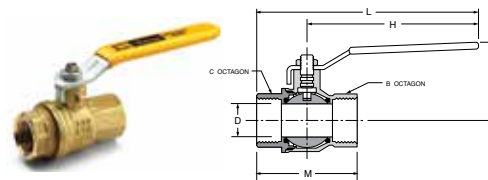

Locking Handle, Female Pipe Ends VP520P

PART NO.	PIPE THREAD [NPT]	B OCTAGON	C OCTAGON	H	L	M	N	D FLOW Ø
VP520P-4	1/4-18	.67	.67	3.94	4.83	1.77	1.50	.310
VP520P-6	3/8-18	.79	.79	3.94	4.83	1.77	1.50	.400
VP520P-8	1/2-14	.98	.98	3.94	5.10	2.32	1.69	.600
VP520P-12	3/4-14	1.22	1.22	4.72	5.98	2.52	1.97	.790
VP520P-16	1-11.5	1.57	1.57	4.72	6.32	3.19	2.13	1.000
VP520P-20	1-1/4	1.93	1.93	6.22	8.05	3.66	2.82	1.180
VP520P-24	1-1/2	2.13	2.13	6.22	8.23	4.02	3.06	1.570
VP520P-32	2	2.69	2.69	6.22	8.58	4.76	3.33	2.000
VP520P-40	2-1/2	3.35	3.35	10.04	13.11	6.14	5.20	2.520
VP520P-48	3	3.89	3.89	10.04	13.52	6.97	5.51	3.000

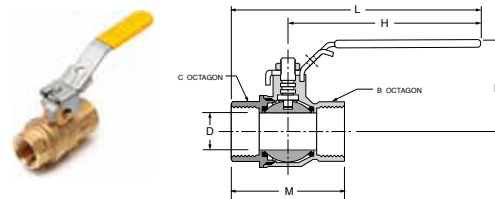

⚠️ WARNING: These products can expose you to chemicals including NICKEL or LEAD, which are known to the state of California to cause cancer and LEAD.

Ball Valves Brass Series 525



Parker's industrial ball valves are intended for general purpose use. Ball valves are intended for use in the fully open or closed positions. Throttling of the valve may result in premature seal failure and/or inability to turn the valve handle.

Product Features:

- Forged brass body
- Chrome plated brass ball
- PTFE seats/seals
- Steel handle
- Standard Port
- Female/Female NPT Ports

Specifications: Pressure Range:

- 600 WOG Cold Non-shock 1/2" – 2"
- Vacuum Service to 29 Inches Hg

Temperature Range

- -40° to +350° F (-40° to +176.6° C)

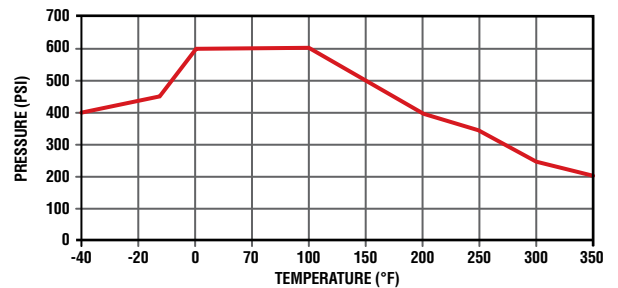

Flow Coefficient

VALUE SIZE	1/2"	3/4"	1"	1-1/4"	1-1/2"	2"
CV	8.4	16	22	38	52	78

Female Pipe Ends, V525P

PART NO.	D	DN	I	L	G	A	H	CH
V525P-8	1/2"	.453	.610	2.126	1.043	3.89	1.62	.984
V525P-12	3/4"	.590	.669	2.441	1.220	3.89	1.69	1.220
V525P-16	1"	.748	.827	2.835	1.417	4.72	1.98	1.496
V525P-20	1 1/4"	.945	.905	3.464	1.732	4.72	2.15	1.929
V525P-24	1 1/2"	1.181	.905	3.779	1.890	6.23	2.97	2.126
V525P-32	2"	1.496	1.043	4.409	2.205	6.23	3.24	2.677

Note: For larger sizes, please contact the division. Packing nut may need to be tightened depending on application temperature. Periodically check the packing nut and tighten as required

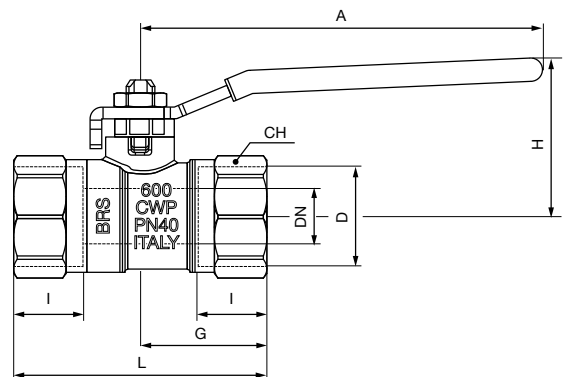

⚠ WARNING These products can expose you to chemicals including NICKEL or LEAD, which are known to the state of California to cause cancer and LEAD.



Ball Valves Brass Series 533 3-Way Diversion / Series 540 4-Way

Product Features:

- Forged brass body
- Chrome plated brass ball
- PTFE seats/seals
- Steel handle

Style:

- V-Valve
- VP-Valve, padlocking handle

Type:

- 533 3-Way Diversion
- 540 4-Way

Material:

- P-Brass

Options:

- 02-Stainless Steel Handle & Nut
- 08-Unmarked yellow vinyl handle cover

Specifications:

Pressure Range:

- 400 PSI (27.5 bar)
- Vacuum Service to 29 Inches Hg

Temperature Range

- -20° to +350° F (-6.6° to +176.6° C)

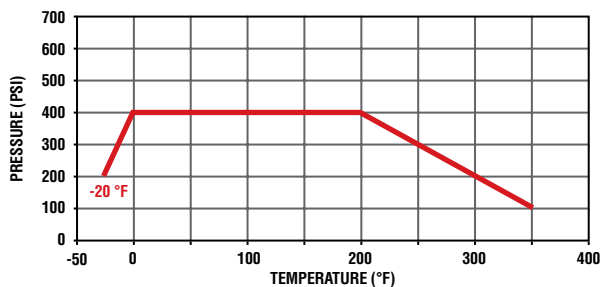

V540P FLOW INFORMATION	
POINTER OVER	FLOW PATH
A	A TO E
OFF	CLOSED
C	C TO E
D	D TO E

V540P Handle Positions

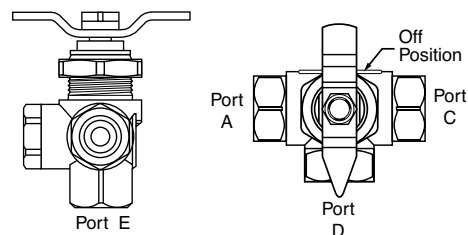

V533P Handle Positions

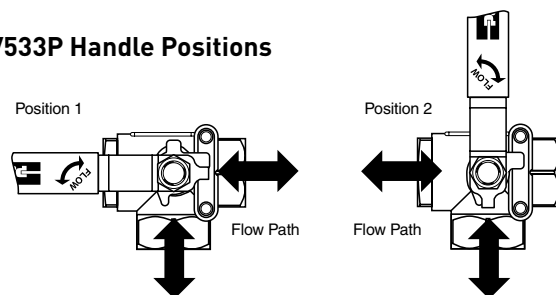

WARNING These products can expose you to chemicals including NICKEL or LEAD, which are known to the state of California to cause cancer and LEAD.

[Click here for CADs, Product Specifications or to Configure Parts Online](#)

Female-Female-Female Pipe Ends V533P

PART NO.	PIPE THD (PTF)	B HEX	E	F	G	H	K	L	M	N	FLOW DIA. D
V533P-4	1/4	15/16	.50	1.08	1.12	3.96	1.03	2.47	2.03	1.94	.375
V533P-6	3/8	15/16	.50	1.08	1.12	3.96	1.03	2.47	2.03	1.94	.375
V533P-8	1/2	1-1/16	.50	1.18	1.12	3.96	1.11	2.58	2.20	1.98	.500
V533P-12	3/4	1-1/4	.87	1.43	1.37	3.96	1.42	2.90	2.83	2.17	.685
V533P-16	1	1-9/16	.87	1.62	1.37	3.96	1.58	3.21	3.16	2.32	.875

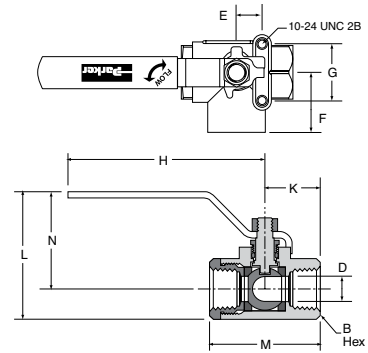

Female-Female-Female-Female Pipe Ends V540P

PART NO.	PIPE THD (PTF)	B HEX	E	F	G	H	K	L	M	N	FLOW DIA. D
V540P-4	1/4	7/8	.32	1.00	1.76	1.25	1.98	2.49	.52	1.07	.250

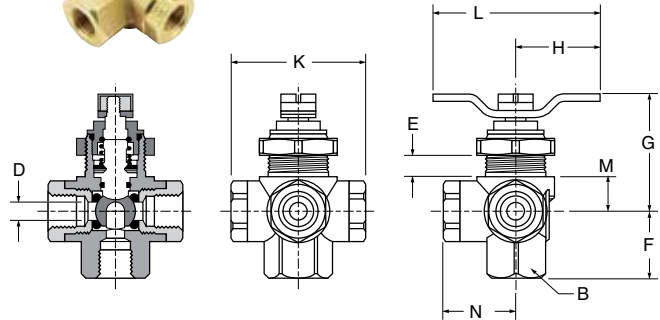

WARNING These products can expose you to chemicals including NICKEL or LEAD, which are known to the state of California to cause cancer and LEAD.

Ball Valves Brass Series 590/591



Product Features:

- Forged brass body
- Chrome plated brass ball
- PTFE seats/seals
- Steel handle

Style:

- V-Valve

Type:

- 590-Male/Female
- 591-Male/Female

Material:

- P-Brass

Options:

- 04-Lever Handle
- 08-Unmarked yellow vinyl handle cover

Specifications:

Pressure Range:

- 250 PSI (17.2 bar)
- Saturated Steam up to 150 PSI (10.3 bar)
- Vacuum Service to 29 Inches Hg

Temperature Range

- -50° to +350° F (-45.5° to +176.6° C)

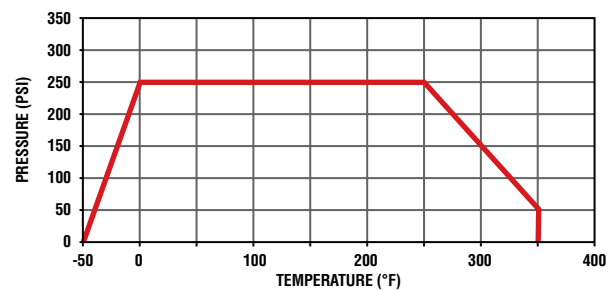

WARNING These products can expose you to chemicals including NICKEL or LEAD, which are known to the state of California to cause cancer and LEAD.

[Click here for CADs, Product Specifications or to Configure Parts Online](#)

90° Flow, Male-Female Pipe Ends V590P

PART NO.	PIPE PTF THREAD	HEX	H	K	L	M	N	D FLOW Ø
V590P-4	1/4	15/16	1.25	1.08	2.50	1.00	2.42	.375
V590P-6	3/8	15/16	1.25	1.09	2.50	1.00	2.43	.375
V590P-8	1/2*	1-1/16	1.25	1.30	2.50	1.08	2.67	.500
V590P-16	1**	1-9/16"	1.30	1.90	2.60	1.38	3.62	.750

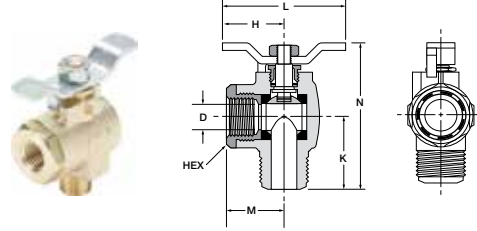

Lever Handle, 90° Flow, Male-Female Pipe Ends V590P-X-04

PART NO.	PIPE PTF THREAD	HEX	H	K	L	M	N	D FLOW Ø
V590P-4-04	1/4	15/16	3.96	1.08	4.96	1.00	3.02	.375
V590P-6-04	3/8	15/16	3.96	1.09	4.96	1.00	3.03	.375
V590P-8-04	1/2*	1-1/16	3.80	1.30	4.88	1.08	2.95	.500
V590P-16-04	1**	1-9/16"	3.96	1.90	5.34	1.38	4.17	.750

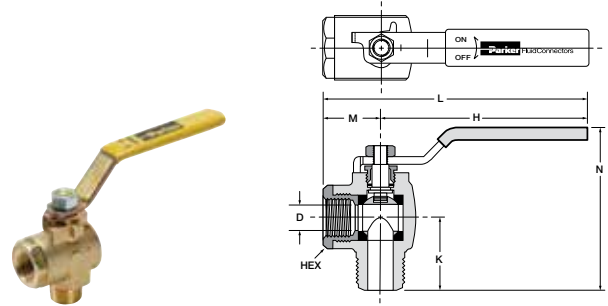

90° Flow, Male-Male Pipe Ends V591P

PART NO.	PIPE THREAD	HEX	H	K	L	M	N	D FLOW Ø
V591P-4	1/4	15/16	1.25	1.08	2.50	1.56	2.42	.375
V591P-6	3/8	15/16	1.25	1.09	2.50	1.56	2.43	.375
V591P-8	1/2	1-1/16	1.25	1.30	2.50	1.84	2.67	.500

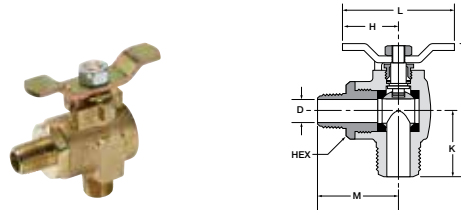

Lever Handle, 90° Flow, Male-Male Pipe Ends V591P-X-04

PART NO.	PIPE THREAD	HEX	H	K	L	M	N	D FLOW Ø
V591P-4-04	1/4	15/16	3.96	1.08	5.52	1.56	3.02	.375
V591P-6-04	3/8	15/16	3.96	1.09	5.52	1.56	3.03	.375
V591P-8-04	1/2	1-1/16	3.80	1.30	5.64	1.84	2.95	.500

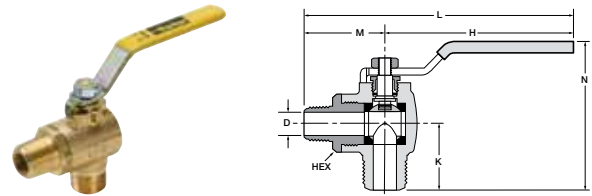

*PTF Special Short. **PTF SPL Extra Short

WARNING These products can expose you to chemicals including NICKEL or LEAD, which are known to the state of California to cause cancer and LEAD.

[Click here for CADs, Product Specifications or to Configure Parts Online](#)

Ball Valves Brass Series 500HB



Product Features:

- Forged brass body
- Chrome plated brass ball
- PTFE seats/seals
- Steel handle

Style:

- V-Valve

Type:

- 500HB-Female/Beaded Hose Barb

Material:

- P-Brass

Specifications:

Pressure Range:

- 150 PSI (10.3 bar) WOG, Cold Non-Shock
- Saturated Steam up to 150 PSI (10.3 bar)
- Vacuum Service to 29 Inches Hg

Temperature Range

- 0° to +350° F (-17.7° to +176.6° C)

Brass Hose Barb Ball Valve V500P-HB

PART NO.	PORT 1	PORT 2 PTF	B HEX	C HEX	H	L	M	N	FLOW DIA. D
V500P-12-16HB	1	3/4*	1-1/4	1-5/16	3.96	6.25	3.41	2.81	.685

*PTF special extra short

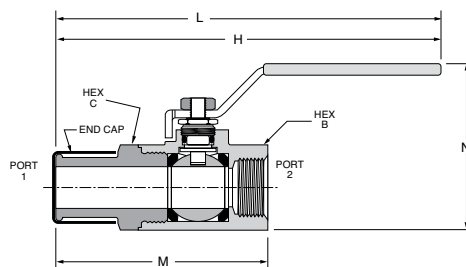

WARNING These products can expose you to chemicals including NICKEL or LEAD, which are known to the state of California to cause cancer, and LEAD.

Ball Valves

Brass Series 600



Product Features:

- Forged brass body
- Chrome plated brass ball
- PTFE seats/seals
- Fluorocarbon O-rings
- Steel handle

Style:

- V-Valve

Type:

- 600-Three Position
- 633-Two Position

Material:

- P-Brass

Specifications:

Pressure Range:

- 150 PSI (10.3 bar)
- Vacuum Service to 29 Inches Hg

Temperature Range

- 0° to +250° F (-17.7° to +121.1° C)

Series 600 Handle Positions

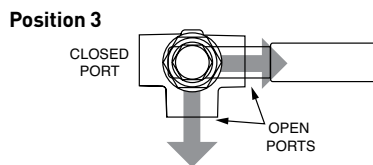
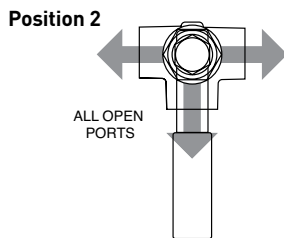
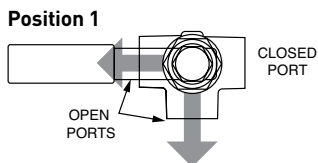

Series 633 Handle Positions

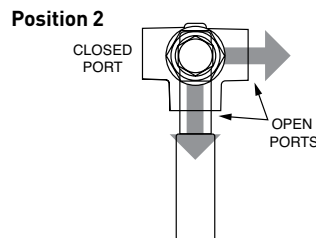
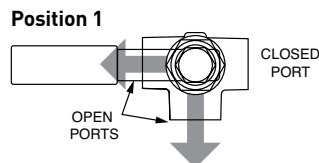

This valve can be used on applications where a fluid return or spillback is required. For use on construction equipment, chemical processing, diesel engines, filter banks, pumps and specialized industrial machinery.

NOTE: Diversion valves do not have off positions, therefore, the center ports can not be used for shut-off purposes.

WARNING: These products can expose you to chemicals including NICKEL or LEAD, which are known to the state of California to cause cancer and LEAD.

[Click here for CADs, Product Specifications or to Configure Parts Online](#)

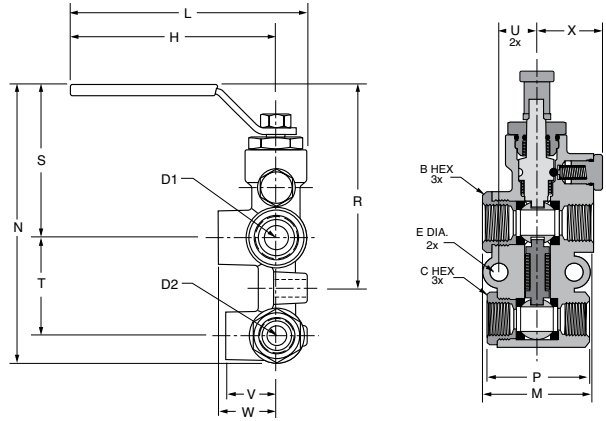

Six Port Diversion Brass Valve V600P

PIPE THD. PART NO.	PIPE THD. TOP PORT SPL SHORT	BOTTOM PORT PTF	B HEX	C HEX	D1 FLOW	D2 FLOW	E	H	L	M	N	P	R	S	T	U	V	W	X
V600P-8-6	1/2	3/8	1 1/16	15/16	.500	.375	.34	3.96	4.56	2.20	5.43	2.03	3.98	2.99	1.91	.73	.98	1.12	1.31

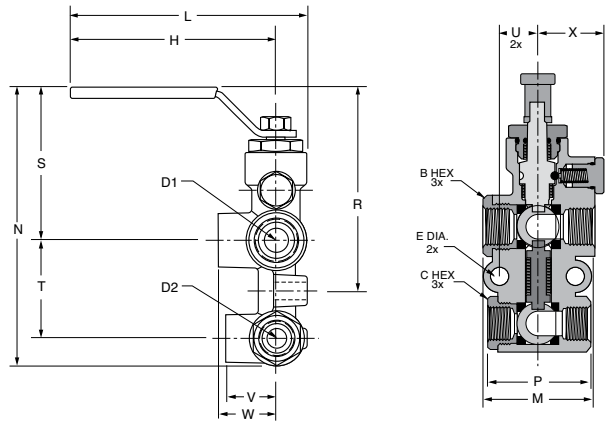

Six Port Diversion Brass Valve V633P

PIPE THD. PART NO.	PIPE THD. TOP PORT SPL SHORT	BOTTOM PORT PTF	B HEX	C HEX	D1 FLOW	D2 FLOW	E	H	L	M	N	P	R	S	T	U	V	W	X
V633P-8-6	1/2	3/8	1 1/16	15/16	.500	.375	.34	3.96	4.56	2.20	5.43	2.03	3.98	2.99	1.91	.73	.98	1.12	1.31

WARNING These products can expose you to chemicals including NICKEL or LEAD, which are known to the state of California to cause cancer and LEAD.



Ball Valves

Carbon Steel Series 500CS/502CS

Product Features:

- Carbon Steel Phosphate Coated body
- Steel ball
- PTFE seats/seals
- Steel handle

Style:

- V-Valve
- VP-Valve, padlocking handle

Type:

- 500-Female/Female
- 502-Female/Female

Material:

- CS-Carbon Steel

Options:

- 04-Tee Handle
- 21-Oval Handle

Specifications:

Pressure Range:

- 1/4" – 1": 2000 PSI (137.8 bar)
- 1 1/4" – 2": 1500 PSI (103.4 bar)
- Saturated Steam up to 150 PSI (10.3 bar)

Temperature Range

- -20° to +425° F (-28.8° to +218.3° C)

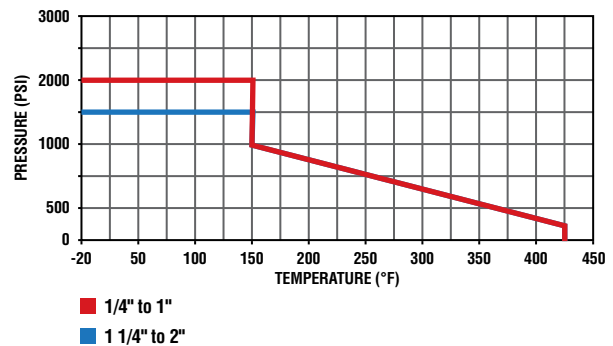

FLOW DATA	
VALVE SIZE	CV
1/4	6.0
3/8	12.8
1/2	15.0
3/4	23.0
1	36.0
1-1/4	44.0
1-1/2	64.0
2	114.0

[Click here for CADs, Product Specifications or to Configure Parts Online](#)

Female-Female Pipe Ends V500CS

PART NO.	PIPE THREAD	B HEX	C HEX	H	L	M	N	D FLOW Ø
V500CS-4	1/4	1-1/16	15/16	3.78	1.00	2.00	1.63	.400
V500CS-6	3/8	1-1/16	15/16	3.78	1.00	2.00	1.63	.400
V500CS-8	1/2	1-1/4	1-1/16	3.78	1.25	2.37	1.73	.540
V500CS-12	3/4	1-5/8	1-3/8	5.10	1.50	2.90	2.08	.680
V500CS-16	1	2	1-5/8	5.10	1.76	3.41	2.30	.880

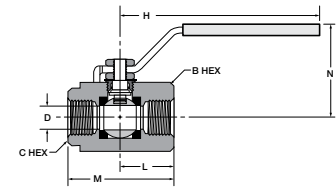

Female-Female Pipe Ends, Panel Mount V502CS

PART NO.	PIPE THD	B HEX	C HEX	F	G	H	L	M	N	FLOW DIA. D
V502CS-20	1-1/4	2	2-1/4	.94	1.50	6.10	1.87	3.80	2.76	1.000
V502CS-24	1-1/2	2-5/16	2-1/2	.94	1.50	6.10	2.27	4.55	2.98	1.250
V502CS-32	2	2-3/4	3	1.03	2.00	8.60	2.42	4.83	3.54	1.500

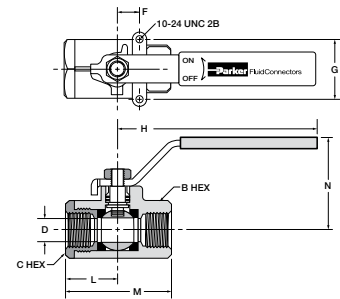

Locking Handle, Female Pipe Ends VP500CS

PART NO.	PIPE THD	B HEX	C HEX	H	L	M	N	D FLOW Ø
VP500CS-4	1/4	1-1/16	15/16	4.13	1.00	2.00	2.23	.400
VP500CS-6	3/8	1-1/16	15/16	4.13	1.00	2.00	2.23	.400
VP500CS-8	1/2	1-1/4	1-1/16	4.13	1.25	2.37	2.33	.540
VP500CS-12	3/4	1-5/8	1-3/8	5.00	1.50	2.90	2.80	.680
VP500CS-16	1	2	1-5/8	5.00	1.76	3.41	2.97	.880

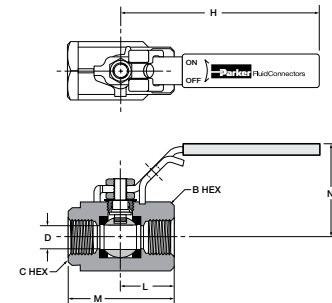

Locking Handle, Female Pipe Ends, Panel Mount VP502CS

PART NO.	PIPE THD	B HEX	C HEX	F	G	H	L	M	N	FLOW DIA. D
VP502CS-20	1-1/4	2	2-1/4	.94	1.50	7.50	1.87	3.80	3.15	1.000
VP502CS-24	1-1/2	2-5/16	2-1/2	.94	1.50	7.50	2.27	4.55	3.37	1.250
VP502CS-32	2	2-3/4	3	1.03	2.00	8.75	2.42	4.83	3.46	1.500

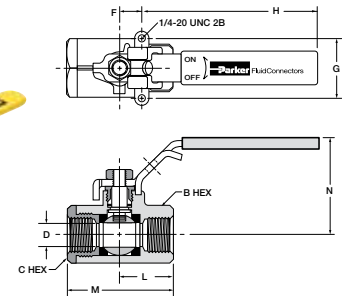

Tee Handle, Female Pipe Ends V500CS-X-04

PART NO.	PIPE THD	B HEX	C HEX	H	L	M	N	D FLOW Ø
V500CS-4-04	1/4	1-1/16	15/16	2.16	1.08	2.00	1.41	.400
V500CS-6-04	3/8	1-1/16	15/16	2.16	1.08	2.00	1.41	.400
V500CS-8-04	1/2	1-1/4	1-1/16	2.90	1.45	2.37	1.66	.540
V500CS-12-04	3/4	1-5/8	1-3/8	3.63	1.81	2.90	2.06	.680
V500CS-16-04	1	2	1-5/8	3.63	1.81	3.41	2.23	.880

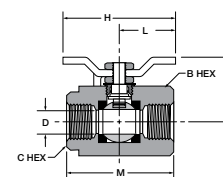

Oval Handle, Female Pipe Ends V500CS-X-21

PART NO.	PIPE THD	B HEX	C HEX	H	L	M	N	D FLOW Ø
V500CS-4-21	1/4	1-1/16	15/16	3.50	1.00	2.00	1.66	.400
V500CS-6-21	3/8	1-1/16	15/16	3.50	1.00	2.00	1.66	.400
V500CS-8-21	1/2	1-1/4	1-1/16	3.50	1.13	2.37	1.76	.540
V500CS-12-21	3/4	1-5/8	1-3/8	5.00	1.46	2.90	2.13	.680
V500CS-16-21	1	2	1-5/8	5.00	1.58	3.41	2.29	.880

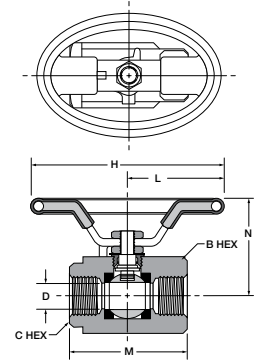

Oval Handle, Female Pipe Ends, Panel Mount V502CS-X-21

PART NO.	PIPE THD	B HEX	C HEX	F	G	H	L	M	N	FLOW DIA. D
V502CS-20-21	1-1/4	2	2-1/4	.94	1.50	5.07	2.53	3.80	3.04	1.000
V502CS-24-21	1-1/2	2-5/16	2-1/2	.94	1.50	5.07	2.53	4.55	3.26	1.250
V502CS-32-21	2	2-3/4	3	1.03	2.00	6.50	3.25	4.83	3.57	1.500

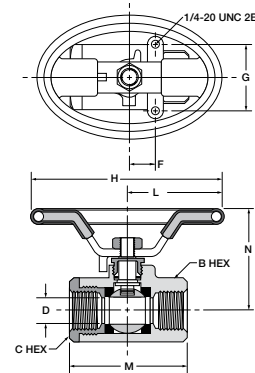



Ball Valves

Carbon Steel Series 506CS

Product Features:

- Carbon Steel Phosphate Coated body
- Steel ball
- PTFE seats/seals
- Steel handle

Style:

- V-Valve
- VP-Valve, padlocking handle

Type:

- 506-Female/Female SAE Straight Thread Ports

Material:

- CS-Carbon Steel

Options:

- 04-Tee Handle
- 21-Oval Handle

Specifications:

Pressure Range:

- 3000 PSI (206.8 bar)
- Saturated Steam up to 150 PSI (10.3 bar)

Temperature Range

- -20° to +425° F (-28.8° to +218.3° C)

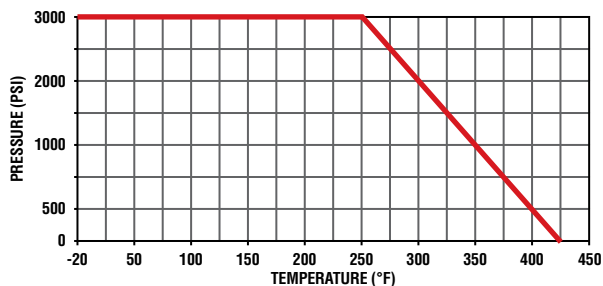

FLOW DATA	
VALVE SIZE	CV
1/4	6.0
3/8	12.0
1/2	15.0
3/4	34.0
1	54.0

Female-Female SAE Straight Thread Ports V506CS

PART NO.	STRAIGHT THREAD	B HEX	C HEX	H	L	M	N	D FLOW Ø
V506CS-4	7/16-20	1-1/16	15/16	3.78	1.00	2.00	1.63	.400
V506CS-6	9/16-18	1-1/16	15/16	3.78	1.00	2.00	1.63	.400
V506CS-8	3/4-16	1-5/8	1-1/4	4.78	1.32	2.84	2.16	.500
V506CS-12	1-1/16-12	1-7/8	1-5/8	4.78	1.66	3.71	2.35	.750
V506CS-16	1-5/16-12	2-1/2	2-1/8	6.10	1.88	4.15	2.85	1.000

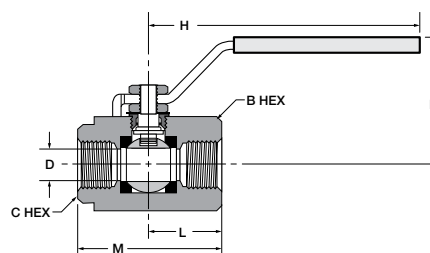



Ball Valves

Carbon Steel Series 500HP, 506HP

Product Features:

- Carbon Steel Phosphate Coated body
- Steel ball
- Delrin with Molybdenum Disulphide Seats
- Nitrile O-rings Stem Seals
- Steel handle

Style:

- V-Valve
- VP-Valve, padlocking handle

Type:

- 500-Female/Female NPT Ports
- 506-Female/Female SAE Straight Thread Ports

Material:

- HP-High Pressure Carbon Steel

Specifications:

Pressure Range:

- 6000 PSI (413.6 bar)

Temperature Range

- -10° to +210° F (-23.3° to 98.8° C)

Pressure Drop (PSI)

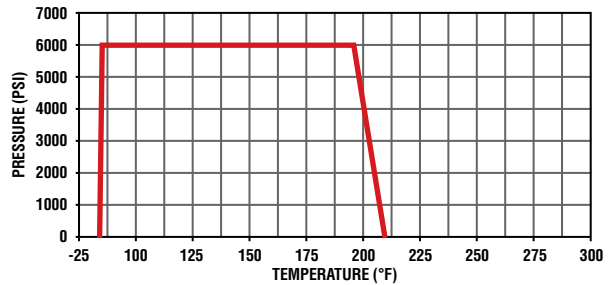
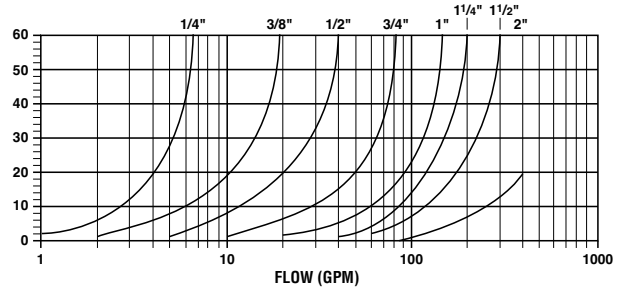

6000 PSI Female-Female Pipe Ends V500HP-X

PART NO.	PIPE THREAD (NPT)	B	C	H	L	M	N	FLOW DIA. D
V500HP-4	1/4-18	.69	1.38	4.50	1.44	2.75	2.94	.240
V500HP-6	3/8-18	.56	1.50	4.50	1.69	2.88	3.06	.390
V500HP-8	1/2-14	.75	1.63	4.50	1.88	3.38	3.19	.510
V500HP-12	3/4-14	.69	2.25	7.00	2.41	3.81	4.69	.790
V500HP-16	1-11.5	.94	2.50	7.00	2.56	4.50	4.94	.950

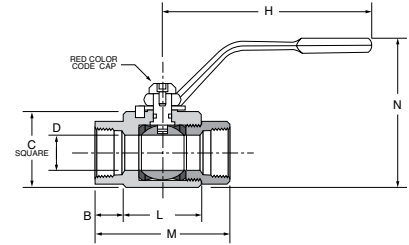

6000 PSI Female-Female Pipe Ends V500HP-X (LARGE)

PART NO.	PIPE THREAD (NPT)	B	C	H	L	M	N	FLOW DIA. D
V500HP-20	1 1/4-11.5	.85	3.25	10.00	3.15	4.84	6.31	1.26
V500HP-24	1 1/2-11.5	.99	3.75	10.00	3.35	5.33	6.76	1.50
V500HP-32	2-11.5	1.30	4.50	10.00	3.94	6.54	7.42	1.89

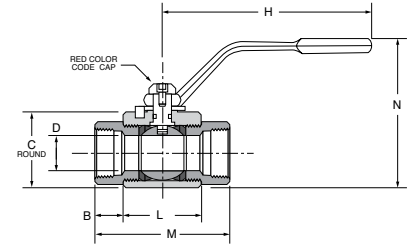

6000 PSI Locking-Female-Female Pipe Ends VP500HP-X

PART NO.	PIPE THREAD (NPT)	B	C	H	L	M	N	FLOW DIA. D
VP500HP-4	1/4-18	.69	1.38	4.50	1.44	2.75	2.94	.240
VP500HP-6	3/8-18	.56	1.50	4.50	1.69	2.88	3.06	.390
VP500HP-8	1/2-14	.75	1.63	4.50	1.88	3.38	3.19	.510
VP500HP-12	3/4-14	.69	2.25	7.00	2.41	3.81	4.69	.790
VP500HP-16	1-11.5	.94	2.50	7.00	2.56	4.50	4.94	.950

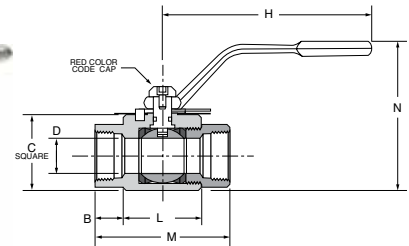

6000 PSI Locking-Female-Female Pipe Ends VP500HP-X (LARGE)

PART NO.	PIPE THREAD (NPT)	B	C	H	L	M	N	FLOW DIA. D
VP500HP-20	1 1/4-11.5	.85	3.25	10.00	3.15	4.84	6.31	1.26
VP500HP-24	1 1/2-11.5	.99	3.75	10.00	3.35	5.33	6.76	1.50
VP500HP-32	2-11.5	1.30	4.50	10.00	3.94	6.54	7.42	1.89

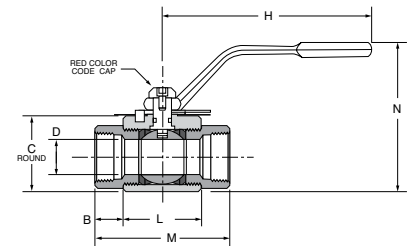

6000 PSI Female-Female Straight Thread Ends V506HP-X

PART NO.	SAE J1926-1 THREAD	B	C	H	L	M	N	FLOW DIA. D
V506HP-4	7/16-20 UNF	.69	1.38	4.50	1.44	2.75	2.94	.240
V506HP-6	9/16-18 UNF	.56	1.50	4.50	1.69	2.88	3.06	.390
V506HP-8	3/4-16 UNF	.75	1.63	4.50	1.88	3.38	3.19	.510
V506HP-12	1 1/16-12 UNF	.69	2.25	7.00	2.41	3.81	4.69	.790
V506HP-16	1 5/16-12 UNF	.94	2.50	7.00	2.56	4.50	4.94	.950

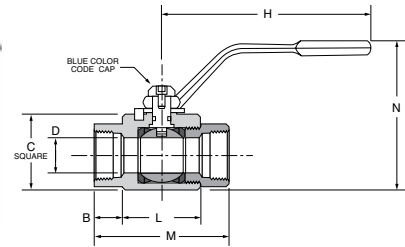

6000 PSI Female-Female Straight Thread Ends V506HP-X (LARGE)

PART NO.	SAE J1926-1 THREAD	B	C	H	L	M	N	FLOW DIA. D
V506HP-20	1 5/8-12 UNF	.85	3.25	10.00	3.15	4.84	6.31	1.26
V506HP-24	1 7/8-12 UNF	.99	3.75	10.00	3.35	5.33	6.76	1.50
V506HP-32	2 1/2-12 UNF	1.30	4.50	10.00	3.94	6.54	7.42	1.89

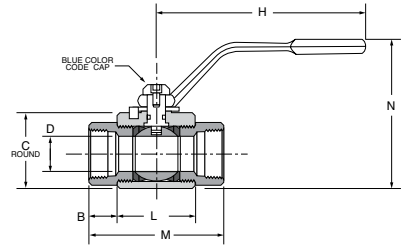

6000 PSI Locking-Female-Female Straight Thread Ends VP506HP-X

PART NO.	SAE J1926-1 THREAD	B	C	H	L	M	N	FLOW DIA. D
VP506HP-4	7/16-20 UNF	.69	1.38	4.50	1.44	2.75	2.94	.240
VP506HP-6	9/16-18 UNF	.56	1.50	4.50	1.69	2.88	3.06	.390
VP506HP-8	3/4-16 UNF	.75	1.63	4.50	1.88	3.38	3.19	.510
VP506HP-12	1 1/16-12 UNF	.69	2.25	7.00	2.41	3.81	4.69	.790
VP506HP-16	1 5/16-12 UNF	.94	2.50	7.00	2.56	4.50	4.94	.950

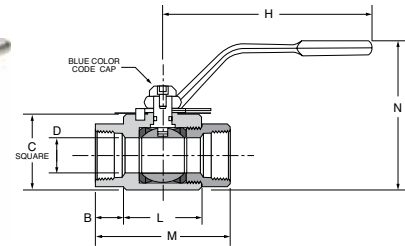

6000 PSI Locking-Female-Female Straight Thread Ends VP506HP-X (LARGE)

PART NO.	SAE J1926-1 THREAD	B	C	H	L	M	N	FLOW DIA. D
VP506HP-20	1 5/8-12 UNF	.85	3.25	10.00	3.15	4.84	6.31	1.26
VP506HP-24	1 7/8-12 UNF	.99	3.75	10.00	3.35	5.33	6.76	1.50
VP506HP-32	2 1/2-12 UNF	1.30	4.50	10.00	3.94	6.54	7.42	1.89

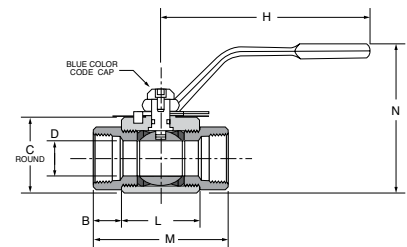

[Click here for CADs, Product Specifications or to Configure Parts Online](#)



Ball Valves

Stainless Steel Series 501SS

Product Features:

- CF-8M Stainless Steel body
- Stainless Steel ball
- PTFE Seats/Seals
- Stainless Steel handle
- Silicone Free

Material:

- SS – Stainless Steel

Options

- 20-Short Handle
- 21-Oval Handle
- 35-Welded Retainer Nut

Specifications:

Pressure Range:

- 2000 PSI (137.8 bar)
- Vacuum service 28 inches Hg

Temperature Range

- 0° to +400° F (-17.7° to +204.4° C)

Style:

- V-Valve

Type:

- 501-Male/Female NPT Ports

Approvals

- Meets material requirements of NACE MR-01-75

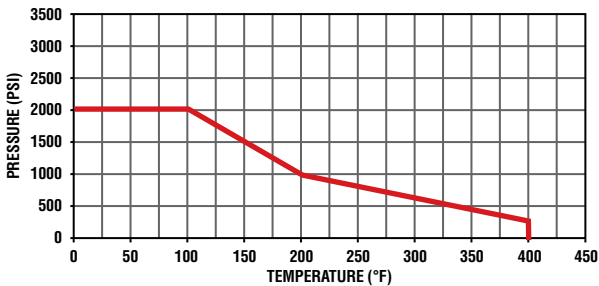

FLOW DATA	
VALVE SIZE	CV
1/4	4.0
3/8	6.0
1/2	14.0
3/4	35.0
1	54.0

Mounting Detail

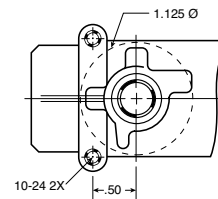

Male-Female Pipe Ends V501SS

PART NO.	PIPE THREAD [NPT]	HEX	F	G	L	M	N	D FLOW Ø
V501SS-4	1/4	15/16	.50	1.12	5.60	2.65	1.97	.280
V501SS-6	3/8	15/16	.50	1.12	5.60	2.65	1.97	.375
V501SS-8	1/2	1-1/16	.50	1.12	5.85	3.05	2.00	.500
V501SS-12	3/4	1-3/8	.88	1.37	7.27	3.85	2.55	.720
V501SS-16	1	1-5/8	.88	1.37	7.48	4.25	2.68	.940

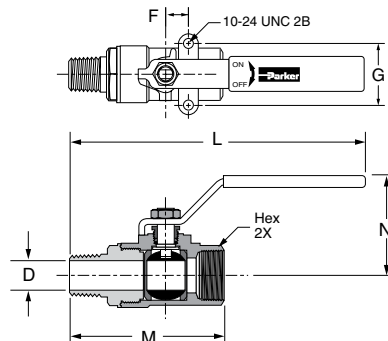



Ball Valves

Stainless Steel Series 502SS

Product Features:

- CF-8M Stainless Steel body
- Stainless Steel ball
- PTFE Seats/Seals
- Stainless Steel handle
- Silicone Free

Style:

- V-Valve
- VP-Valve, Padlocking

Type:

- 502-Panel Mount Female/ Female NPT Ports

Material:

- SS – Stainless Steel

Options

- 20-Short Handle
- 21-Oval Handle
- 35-Welded Retainer Nut

Specifications:

Pressure Range:

- 1/4" – 1": 2000 PSI (137.8 bar)
- 1 1/4" – 2": 1500 PSI (103.4 bar)
- Vacuum service 28 inches Hg

Temperature Range

- 0° to +400° F (-17.7° to +204.4° C)

Approvals

- Meets material requirements of NACE MR-01-75

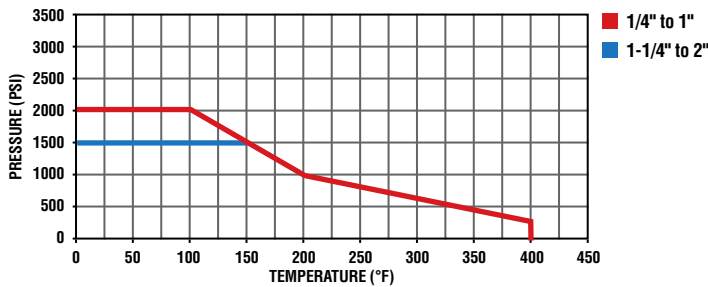

FLOW DATA		MOUNTING HOLE DIAMETER	
VALVE SIZE	CV	VALVE SIZE	DIA. IN.
1/4	4.0	1/4	1.125
3/8	6.0	3/8	1.125
1/2	14.0	1/2	1.125
3/4	35.0	3/4	1.500
1	54.0	1	1.500
1 1/4	74.0	1 1/4	1.875
1 1/2	120.0	1 1/2	1.875
2	226.0	2	1.875

Mounting Detail

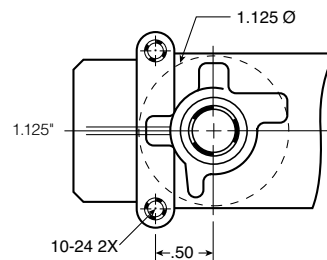

Note: Periodically check the adjustable packing nut and tighten as required.

[Click here for CADs, Product Specifications or to Configure Parts Online](#)

Female Pipe Ends, Panel Mount V502SS

PART NO.	PIPE THD (NPT)	B/C HEX	F	G	H	I THREAD	L	M	N	PANEL FLOW DIA. D	HOLE DIA.
V502SS-4	1/4	15/16	.500	1.125	4.00	10-24 UNC	5.03	2.07	2.52	.380	1.125
V502SS-6	3/8	15/16	.500	1.125	4.00	10-24 UNC	5.03	2.07	2.52	.380	1.125
V502SS-8	1/2	1-1/16	.500	1.125	4.00	10-24 UNC	5.13	2.27	2.65	.500	1.125
V502SS-12	3/4	1-3/8	.875	1.375	5.00	10-24 UNC	6.67	3.35	3.46	.790	1.500
V502SS-16	1	1-5/8	.875	1.375	5.00	10-24 UNC	6.77	3.54	3.74	1.000	1.500
V502SS-20	1-1/4	2	1.000	1.500	7.00	1/4-20 UNC	9.00	4.00	4.55	1.250	2.000
V502SS-24	1-1/2	2-3/8	1.000	1.500	7.00	1/4-20 UNC	7.19	4.38	5.42	1.500	2.000
V502SS-32	2	3	1.000	1.500	7.00	1/4-20 UNC	9.75	5.50	5.68	2.000	2.000

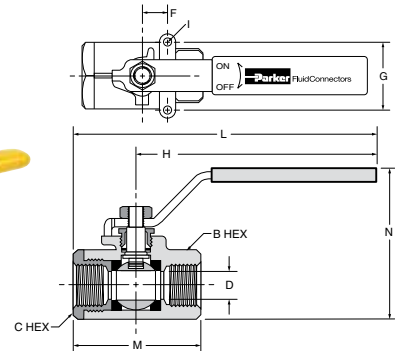

Short Handle, Female Pipe Ends, Panel Mount V502SS-X-20

PART NO.	PIPE THREAD (NPT)	B/C HEX	G	H	L	M	N	FLOW DIA. D
V502SS-4-20	1/4	15/16	1.12	2.28	3.32	2.07	2.53	.375
V502SS-6-20	3/8	15/16	1.12	2.28	3.32	2.07	2.53	.375
V502SS-8-20	1/2	1-1/16	1.12	2.22	3.37	2.25	2.63	.500

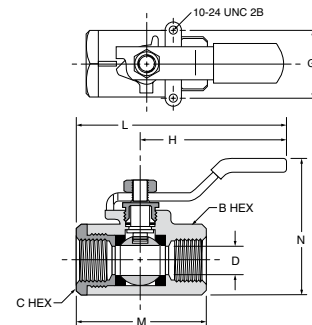

Locking Handle, Female Pipe Ends, Panel Mount VP502SS

PART NO.	PIPE THD (NPT)	B/C HEX	F	G	H	I THREAD	L	M	N	PANEL FLOW DIA. D	HOLE DIA.
VP502SS-4	1/4	15/16	.500	1.125	4.00	10-24 UNC	5.03	2.07	2.52	.380	1.125
VP502SS-6	3/8	15/16	.500	1.125	4.00	10-24 UNC	5.03	2.07	2.52	.380	1.125
VP502SS-8	1/2	1-1/16	.500	1.125	4.00	10-24 UNC	5.13	2.27	2.65	.500	1.125
VP502SS-12	3/4	1-3/8	.875	1.375	5.00	10-24 UNC	6.67	3.35	3.46	.790	1.500
VP502SS-16	1	1-5/8	.875	1.375	5.00	10-24 UNC	6.77	3.54	3.74	1.000	1.500
VP502SS-20	1-1/4	2	1.000	1.500	7.00	1/4-20 UNC	9.00	4.00	4.55	1.250	2.000
VP502SS-24	1-1/2	2-3/8	1.000	1.500	7.00	1/4-20 UNC	7.19	4.38	5.42	1.500	2.000
VP502SS-32	2	3	1.000	1.500	7.00	1/4-20 UNC	9.75	5.50	5.68	2.000	2.000

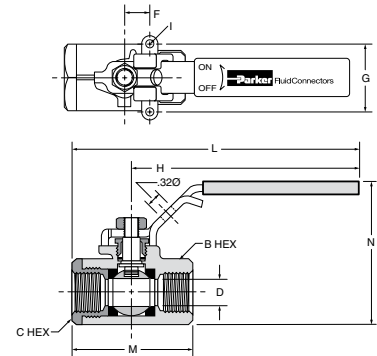

Oval Handle, Female Pipe Ends, Panel Mount V502SS-X-21

PART NO.	PIPE THD (NPT)	B/C HEX	G	H	L	I THREAD	M	N	PANEL FLOW DIA. D	HOLE DIA.
V502SS-4-21	1/4	15/16	1.125	1.74	3.48	10-24 UNC	2.07	2.43	.380	1.125
V502SS-6-21	3/8	15/16	1.125	1.74	3.48	10-24 UNC	2.07	2.43	.380	1.125
V502SS-8-21	1/2	1-1/16	1.125	1.74	3.48	10-24 UNC	2.27	2.54	.500	1.125
V502SS-12-21	3/4	1-3/8	1.375	2.68	5.36	10-24 UNC	3.35	3.45	.790	1.500
V502SS-16-21	1	1-5/8	1.375	2.68	5.36	10-24 UNC	3.54	3.74	1.000	1.500

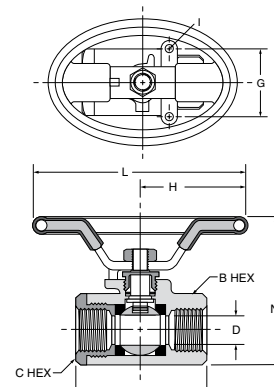

Ball Valves Micro Series 708/709



Product Features:

- Brass Body
- Chrome Plated Brass Ball
- PTFE Seats/Seals
- Nitrile Stem Seal
- Chrome Plated Steel Handle

Style:

- MV-Micro Valve

Type:

- 708-Male/Female
- 709-Female/Female

Specifications:

Pressure Range:

- Up to 500 PSI (34.4 bar)
- Vacuum service 29 inches Hg

Temperature Range

- -35° to +300° F (-37.2 to +148.8° C)



FLOW DATA		
VALVE SIZE	MV708 CV	MV709 CV
1/4	.95	.95

Male-Female Pipe Ends, Mini Ball Valve MV708

PART NO.	PIPE THREAD	B HEX	H	L	M	N	P	FLOW DIA. D
MV708-2	1/8	9/16	1.18	.63	1.62	.93	.38	.180
MV708-4	1/4	11/16	1.52	.70	1.57	.79	.50	.210

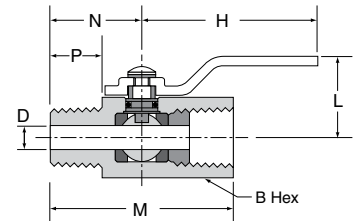

Female Pipe Ends, Mini Ball Valve MV709

PART NO.	PIPE THREAD	B HEX	H	L	M	N	FLOW DIA. D
MV709-2	1/8	9/16	1.18	.63	1.52	.68	.180
MV709-4	1/4	11/16	1.52	.70	1.57	.76	.210

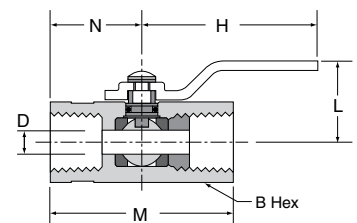

WARNING These products can expose you to chemicals including NICKEL or LEAD, which are known to the state of California to cause cancer, and LEAD.

Ball Valves

Mini Series 200/608/609



Product Features:

- Chrome Plated Brass Body
- Chrome Plated Brass Ball
- PTFE Seats/Seals
- Fluorocarbon Stem Seal
- 608/609 Polyamide Wedge Handle
- 200 Polyamide Lever Handle

Style:

- MV-Mini Valve

Type:

- 608-Male/Female
- 609-Female/Female
- 200-Female/Female
- 21-Oval Handle

Specifications:

Pressure Range:

- MV200: 200 PSI (13.7 bar)
- MV608/609: Vacuum Service 28 Inches Hg
- MV608/609: 450 PSI (31.0 bar)

Temperature Range

- 0° to +200° F (-17.7° to +93.3° C)

MV200 Pressure and Temperature

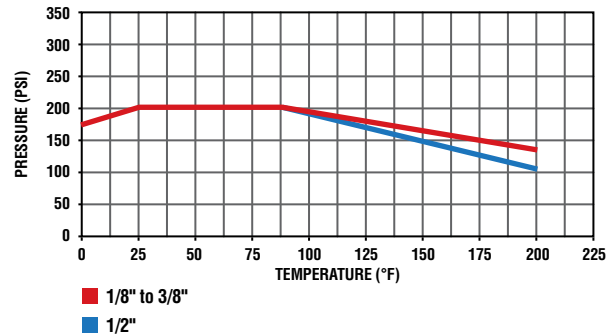

MV608/609 Pressure and Temperature

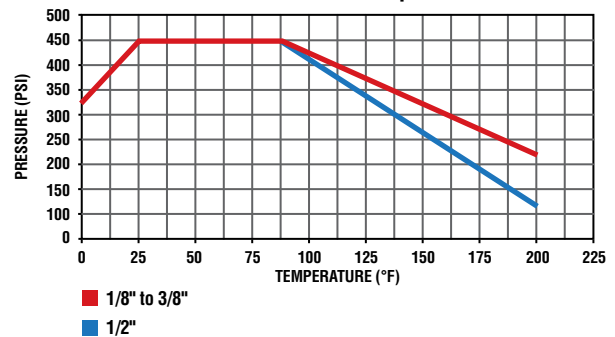

FLOW DATA			
VALVE SIZE	MV200 CV	MV608 CV	MV609 CV
1/8	1.3	1.2	1.4
1/4	4.0	5.8	4.3
3/8	3.7	3.9	3.6
1/2	5.8	5.6	6.0

WARNING These products can expose you to chemicals including NICKEL or LEAD, which are known to the state of California to cause cancer, and LEAD.

[Click here for CADs, Product Specifications or to Configure Parts Online](#)

Female Pipe Ends, Lever Handle, Mini Ball Valve MV200

PART NO.	PIPE THREAD	HEX	B	C	H	L	FLOW DIA. D
MV200-2	1/8	.83	1.71	1.20	.91	2.83	.31
MV200-4	1/4	.83	1.71	1.20	.91	2.83	.31
MV200-6	3/8	.83	1.71	1.20	.91	2.83	.31
MV200-8	1/2	.98	2.11	1.28	1.10	2.83	.39

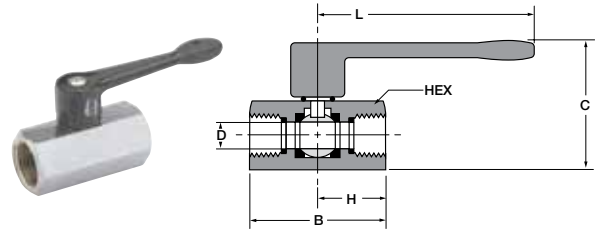

Male-Female Pipe Ends, Compact Handle, Mini Ball Valve MV608

PART NO.	PIPE THREAD	A HEX	B	C	FLOW DIA. D
MV608-2	1/8	.83	1.72	1.22	.20
MV608-4	1/4	.83	1.72	1.22	.31
MV608-6	3/8	.83	1.72	1.22	.31
MV608-8	1/2	.98	2.11	1.30	.39

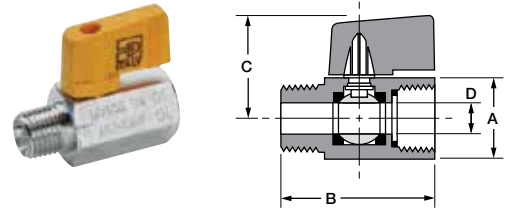

Female Pipe Ends, Compact Handle, Mini Ball Valve MV609

PART NO.	PIPE THREAD	A HEX	B	C	FLOW DIA. D
MV609-2	1/8	.83	1.71	1.22	.24
MV609-4	1/4	.83	1.71	1.22	.31
MV609-6	3/8	.83	1.71	1.22	.31
MV609-8	1/2	.98	2.11	1.30	.39
MV609-6-4	3/8X1/4	.83	1.71	1.22	.31

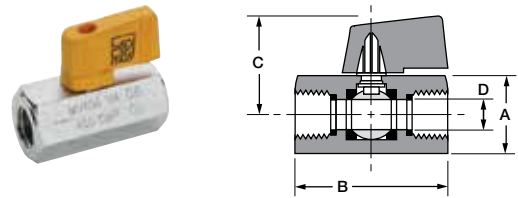

WARNING These products can expose you to chemicals including NICKEL or LEAD, which are known to the state of California to cause cancer and LEAD.

Ball Valves Polypropylene



Parker's Polypropylene Ball Valves offers a corrosion-resistant, all plastic design making them ideal for water filtration units, coffee and beverage machines and a wide variety of other fluid applications.

Product Features:

- Wide chemical acceptance range
- Bi-directional flow maximizes productivity
- Full flow reduces pressure drop across valve
- EPDM Seals – LIQUIfit, TrueSeal, and Par-barb
- Nitrile Seals – Fast and Tite
- Push-in and barbed connections
- Meets FDA and NSF/ANSI 51 requirements for food contact
- LIQUIfit, Par-Barb, and TrueSeal meet NSF/ANSI 61 requirements

Advantages:

- Reduce costs – Built in LIQUIfit, TrueSeal and Par-Barb connections eliminates the need for a secondary fitting.
- Save Space – Low-profile design allows for easy assembly and access where space is a concern.

Type:

- LFPP – LIQUIfit
- PP – TrueSeal
- PBPP – Par-Barb
- FTTPB - Fast and Tite

Specifications:

Pressure Range Up to 150 PSI (10.3 bar)

Temperature Range 35° to +200° F (+1.7° to +93.3° C)

⚠ WARNING These products can expose you to chemicals including CARBON BLACK, or LEAD, which are known to the state of California to cause cancer.

[Click here for CADs, Product Specifications or to Configure Parts Online](#)

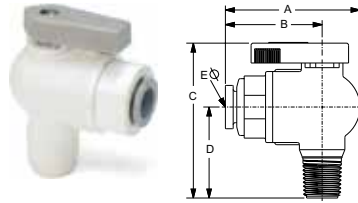

VME - Valve Male Elbow

PART NO.	NOM. TUBE O.D.	NPTF THREAD SIZE	A	B	C	D	ØE THRU HOLE MIN.
LFPP4VME2	1/4	1/8	1.74	1.21	2.00	1.10	.19
LFPP4VME4	1/4	1/4	1.74	1.21	2.18	1.28	.19
LFPP4VME6	1/4	3/8	1.74	1.21	2.18	1.28	.19
LFPP4VME8	1/4	1/2	1.74	1.21	2.37	1.47	.19
LFPP6VME2	3/8	1/8	1.85	1.32	2.00	1.10	.25
LFPP6VME4	3/8	1/4	1.85	1.32	2.18	1.28	.25
LFPP6VME6	3/8	3/8	1.85	1.32	2.18	1.28	.25
LFPP6VME8	3/8	1/2	1.85	1.32	2.37	1.47	.25

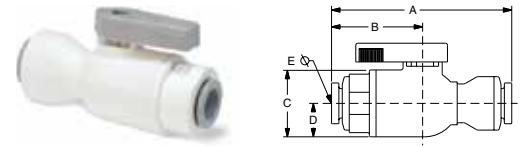

VUC - Valve Union Connector Metric

PART NO.	1 TUBE SIZE MM	2 TUBE SIZE MM	A MM	B MM	C MM	D MM	ØE THRU HOLE MIN. MM
LFPP6MVUC6M	6	6	.57	.27	.36	.13	.19
LFPP8MVUC8M	8	8	.60	.27	.36	.13	.25
LFPP10MVUC10M	10	10	.70	.33	.36	.13	.33
LFPP12MVUC12M	12	12	.88	.43	.36	.13	.37

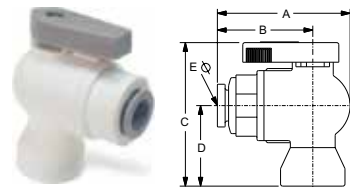

VFE - Valve Female Elbow

PART NO.	NOM. TUBE O.D.	NPTF THREAD SIZE	A	B	C	D	ØE THRU HOLE MIN.
LFPP4VFE2	1/4	1/8	1.74	1.21	1.82	.92	.19
LFPP4VFE4	1/4	1/4	1.74	1.21	2.05	1.15	.19
LFPP4VFE6	1/4	3/8	1.74	1.21	2.18	1.28	.19
LFPP6VFE2	3/8	1/8	1.85	1.32	1.82	.92	.25
LFPP6VFE4	3/8	1/4	1.85	1.32	2.05	1.15	.25
LFPP6VFE6	3/8	3/8	1.85	1.32	2.18	1.28	.25

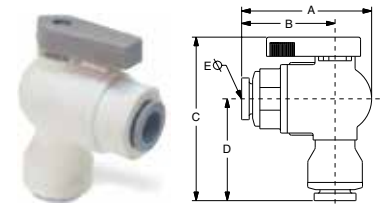

VEU - Valve Elbow Union

PART NO.	1 TUBE SIZE	2 TUBE SIZE	A	B	C	D	ØE THRU HOLE MIN.
LFPP4VEU4	1/4	1/4	1.75	1.22	2.33	1.42	.19
LFPP4VEU6	1/4	3/8	1.75	1.22	2.33	1.42	.11
LFPP6VEU4	3/8	1/4	1.83	1.30	2.32	1.40	.19
LFPP6VEU6	3/8	3/8	1.85	1.32	2.34	1.44	.25

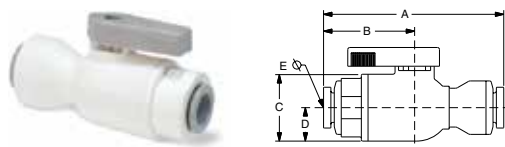

VUC - Valve Union Connector

PART NO.	1 TUBE SIZE	2 TUBE SIZE	A	B	C	D	ØE THRU HOLE MIN.
LFPP4VUC4	1/4	1/4	2.55	1.22	1.0	.5	.19
LFPP4VUC6	1/4	3/8	2.57	1.30	1.0	.5	.19
LFPP6VUC6	3/8	3/8	2.67	1.32	1.4	.5	.25

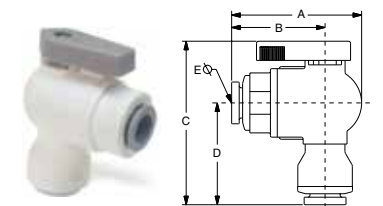

VEU - Valve Elbow Union Metric

PART NO.	1 TUBE SIZE MM	2 TUBE SIZE MM	A MM	B MM	C MM	D MM	ØE THRU HOLE MIN. MM
LFPP6MVEU6M	6	6	.41	.27	.55	.31	.19
LFPP8MVEU8M	8	8	.41	.28	.56	.33	.25
LFPP10MVEU10M	10	10	.48	.33	.61	.38	.33

NOTE: PPL refers to Polypropylene. FCB refers to Fluorocarbon.

WARNING These products can expose you to chemicals including CARBON BLACK or I FAD, which are known to the state of California to cause cancer.

[Click here for CADs, Product Specifications or to Configure Parts Online](#)

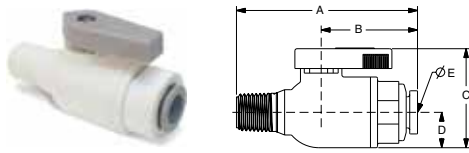

VMC - Valve Male Connector

PART NO.	NOM. TUBE O.D.	NPTF THREAD SIZE	A	B	C	D	ØE THRU HOLE MIN.
LFPP4VMC2	1/4	1/8	2.22	1.21	1.4	.5	.19
LFPP4VMC4	1/4	1/4	2.40	1.21	1.4	.5	.19
LFPP4VMC6	1/4	3/8	2.40	1.21	1.4	.5	.19
LFPP4VMC8	1/4	1/2	2.59	1.21	1.4	.5	.19
LFPP6VMC2	3/8	1/8	2.33	1.32	1.4	.5	.25
LFPP6VMC4	3/8	1/4	2.51	1.32	1.4	.5	.25
LFPP6VMC6	3/8	3/8	2.51	1.32	1.4	.5	.25
LFPP6VMC8	3/8	1/2	2.70	1.32	1.4	.5	.25

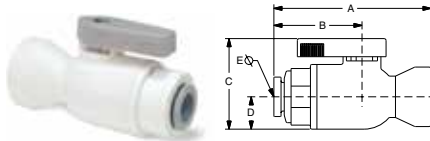

VFC - Valve Female Connector

PART NO.	NOM. TUBE O.D.	NPTF THREAD SIZE	A	B	C	D	ØE THRU HOLE MIN.
LFPP4VFC2	1/4	1/8	2.04	1.21	1.4	.5	.19
LFPP4VFC4	1/4	1/4	2.27	1.21	1.4	.5	.19
LFPP4VFC6	1/4	3/8	2.40	1.21	1.4	.5	.19
LFPP6VFC2	3/8	1/8	2.15	1.32	1.4	.5	.25
LFPP6VFC4	3/8	1/4	2.38	1.32	1.4	.5	.25
LFPP6VFC6	3/8	3/8	2.51	1.32	1.4	.5	.25

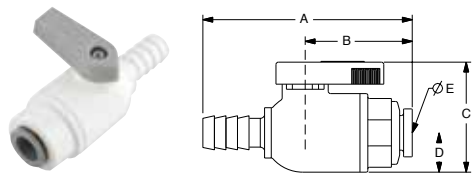

VUCPB - Valve Union Connector Barbed x Tube

PART NO.	HOSE ID	TUBE OD	OD	A	B	C	D	ØE THRU HOLE MIN.
LFPP4VUCPB4	1/4	1/4	.31	2.40	1.08	1.42	.50	.15
LFPP6VUCPB6	3/8	3/8	.43	2.63	1.32	1.42	.50	.19

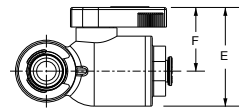

VAS - Valve Angle Stop

PART NO.	TUBE O.D.	MALE THD.	FEMALE THD.	A	B	C	D	E	F
LFPP4VAS6	1/4	3/8	3/8	1.95	1.24	2.17	1.11	1.41	.91
LFPP4VAS8	1/4	3/8	1/2	1.95	1.24	2.40	1.11	1.41	.91
LFPP6VAS6	3/8	3/8	3/8	2.06	1.35	2.17	1.11	1.41	.91
LFPP6VAS8	3/8	3/8	1/2	2.06	1.35	2.40	1.11	1.41	.91

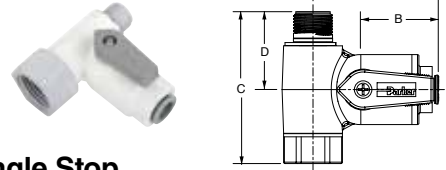

VME - Valve Male Elbow

PART NUMBER	NOM. TUBE O.D.	NPTF THREAD SIZE	A	B	C	D	ØE THRU HOLE MIN.
PP4VME2-MG (+)	1/4	1/8	1.74	1.21	2.00	1.10	.19
PP4VME4-MG	1/4	1/4	1.74	1.21	2.18	1.28	.19
PP4VME6-MG	1/4	3/8	1.74	1.21	2.18	1.28	.19
PP4VME8-MG (+)	1/4	1/2	1.74	1.21	2.37	1.47	.19
PP6VME2-MG (+)	3/8	1/8	1.85	1.32	2.00	1.10	.25
PP6VME4-MG	3/8	1/4	1.85	1.32	2.18	1.28	.25
PP6VME6-MG	3/8	3/8	1.85	1.32	2.18	1.28	.25
PP6VME8-MG	3/8	1/2	1.85	1.32	2.37	1.47	.25

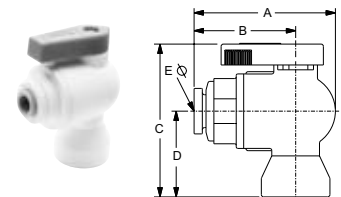

VFE - Valve Female Elbow

PART NUMBER	NOM. TUBE O.D.	NPTF THREAD SIZE	A	B	C	D	ØE THRU HOLE MIN.
PP4VFE2-MG (+)	1/4	1/8	1.74	1.21	1.82	.92	.19
PP4VFE4-MG	1/4	1/4	1.74	1.21	2.05	1.15	.19
PP4VFE6-MG	1/4	3/8	1.74	1.21	2.18	1.28	.19
PP6VFE2-MG (+)	3/8	1/8	1.85	1.32	1.82	.92	.25
PP6VFE4-MG	3/8	1/4	1.85	1.32	2.05	1.15	.25
PP6VFE6-MG	3/8	3/8	1.85	1.32	2.18	1.28	.25

[+] Non Standard.

WARNING These products can expose you to chemicals including CARBON BLACK, or L.F.A.D. which are known to the state of California to cause cancer.

[Click here for CADs, Product Specifications or to Configure Parts Online](#)

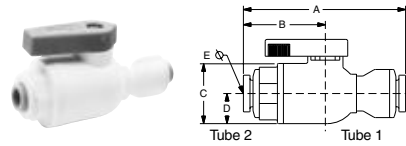

VUC - Valve Union Connector

PART NUMBER	1 TUBE SIZE	2 TUBE SIZE	A	B	C	D	ØE THRU HOLE MIN.
PP4VUC4-MG	1/4	1/4	2.55	1.22	1.0	.5	.19
PP4VUC6-MG	1/4	3/8	2.55	1.22	1.0	.5	.19
PP6VUC4-MG	3/8	1/4	2.57	1.30	1.0	.5	.19
PP6VUC6-MG	3/8	3/8	2.67	1.32	1.4	.5	.25

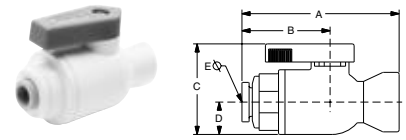

VFC - Valve Female Connector

PART NUMBER	NOM. TUBE O.D.	NPTF THREAD SIZE	A	B	C	D	ØE THRU HOLE MIN.
PP4VFC2-MG	1/4	1/8	2.04	1.21	1.4	.5	.19
PP4VFC4-MG	1/4	1/4	2.27	1.21	1.4	.5	.19
PP4VFC6-MG	1/4	3/8	2.40	1.21	1.4	.5	.19
PP6VFC2-MG	3/8	1/8	2.15	1.32	1.4	.5	.25
PP6VFC4-MG	3/8	1/4	2.38	1.32	1.4	.5	.25
PP6VFC6-MG	3/8	3/8	2.51	1.32	1.4	.5	.25

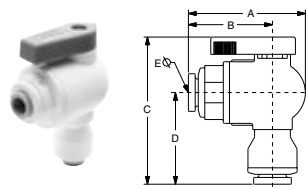

VEU - Valve Elbow Union

PART NUMBER	1 TUBE SIZE	2 TUBE SIZE	A	B	C	D	ØE THRU HOLE MIN.
PP4VEU4-MG	1/4	1/4	1.75	1.22	2.33	1.42	.19
PP4VEU6-MG	1/4	3/8	1.75	1.22	2.33	1.42	.11
PP6VEU4-MG	3/8	1/4	1.83	1.30	2.32	1.40	.19
PP6VEU6-MG	3/8	3/8	1.85	1.32	2.34	1.44	.25

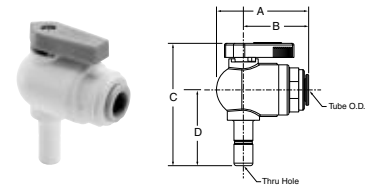

VTEU - Valve Tube Elbow Union

PART NUMBER	NOM. TUBE O.D.	STEM	A	B	C	D	ØE THRU HOLE MIN.
PP4VTEU6-MG	1/4	3/8	1.75	1.22	2.43	1.50	.17
PP6VTEU6-MG	3/8	3/8	1.83	1.30	2.43	1.50	.25

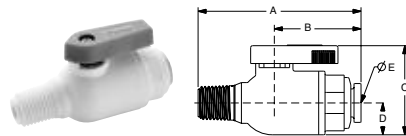

VMC - Valve Male Connector

PART NUMBER	NOM. TUBE O.D.	NPTF THREAD SIZE	A	B	C	D	ØE THRU HOLE MIN.
PP4VMC2-MG (+)	1/4	1/8	2.22	1.21	1.4	.5	.19
PP4VMC4-MG	1/4	1/4	2.40	1.21	1.4	.5	.19
PP4VMC6-MG	1/4	3/8	2.40	1.21	1.4	.5	.19
PP4VMC8-MG (+)	1/4	1/2	2.59	1.21	1.4	.5	.19
PP6VMC2-MG (+)	3/8	1/8	2.33	1.32	1.4	.5	.25
PP6VMC4-MG	3/8	1/4	2.51	1.32	1.4	.5	.25
PP6VMC6-MG	3/8	3/8	2.51	1.32	1.4	.5	.25
PP6VMC8-MG (+)	3/8	1/2	2.70	1.32	1.4	.5	.25

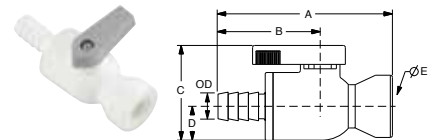

VFC - Valve Barbed Female Connector

PART NO.	HOSE I.D.	NPTF THD.	O.D.	A	B	C	D	ØE THRU HOLE MIN.
PBPP4VFC4	1/4	1/4	.31	2.76	1.60	1.41	.50	.15
PBPP6VFC6	3/8	3/8	.43	2.79	1.60	1.41	.50	.19

WARNING: These products can expose you to chemicals including CARBON BLACK, or LEAD, which are known to the state of California to cause cancer.

[Click here for CADs, Product Specifications or to Configure Parts Online](#)

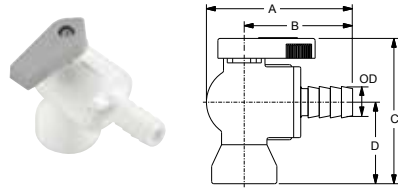

VFE - Valve Barbed Female Elbow

PART NO.	HOSE I.D.	NPTF THD.	O.D.	A	B	C	D	ØE THRU HOLE MIN.
PBPP4VFE4	1/4	1/4	.31	2.13	1.60	2.05	1.15	.15
PBPP6VFE4	3/8	1/4	.43	2.13	1.60	2.05	1.15	.15
PBPP6VFE6	3/8	3/8	.43	2.13	1.60	2.18	1.28	.19

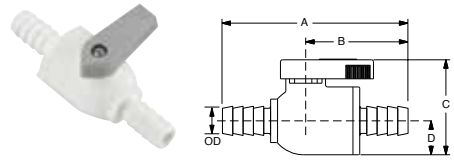

VUC - Valve Barbed Union Connector

PART NO.	HOSE I.D.	O.D.	A	B	C	D	ØE THRU HOLE MIN.
PBPP4VUC4	1/4	.31	2.91	1.60	1.42	.50	.15
PBPP6VUC6	3/8	.43	2.91	1.60	1.42	.50	.19
PBPP8VUC8	1/2	.55	2.91	1.60	1.42	.50	.25

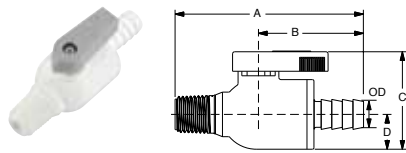

VMC - Valve Barbed Male Connector

PART NO.	HOSE I.D.	NPTF THD.	O.D.	A	B	C	D	ØE THRU HOLE MIN.
PBPP4VMC4	1/4	1/4	.31	2.79	1.60	1.42	.50	.15
PBPP6VMC6	3/8	3/8	.43	2.79	1.60	1.42	.50	.19

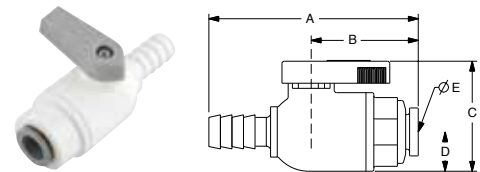

VUCPB - Valve Union Connector Barbed x Tube

PART NO.	HOSE ID	TUBE OD	OD	A	B	C	D	ØE THRU HOLE MIN.
LFPP4VUCPB4	1/4	1/4	.31	2.40	1.08	1.42	.50	.15
LFPP6VUCPB6	3/8	3/8	.43	2.63	1.32	1.42	.50	.19

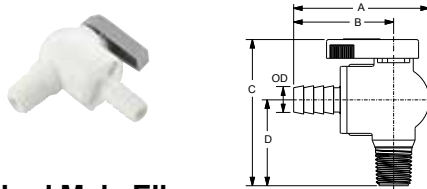

VME - Valve Barbed Male Elbow

PART NO.	HOSE I.D.	NPTF THD.	O.D.	A	B	C	D	ØE THRU HOLE MIN.
PBPP4VME4	1/4	1/4	.31	2.13	1.60	2.18	1.28	.15
PBPP6VME6	3/8	3/8	.43	2.13	1.60	2.18	1.28	.19

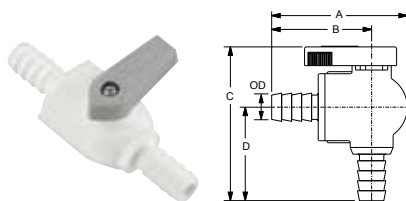

VEU - Parbarb Elbow Ball Valve

PART NO.	HOSE I.D.	O.D.	A	B	C	D	ØE THRU HOLE MIN.
PBPP4VEU4	1/4	.31	2.13	1.57	2.32	1.40	.15
PBPP6VEU6	3/8	.43	2.13	1.60	2.32	1.40	.25
PBPP8VEU8	1/2	.55	2.13	1.60	2.32	1.40	.25

BVC Ball Valve Clip

BV-Clip Shown below holding VUCPB and VME

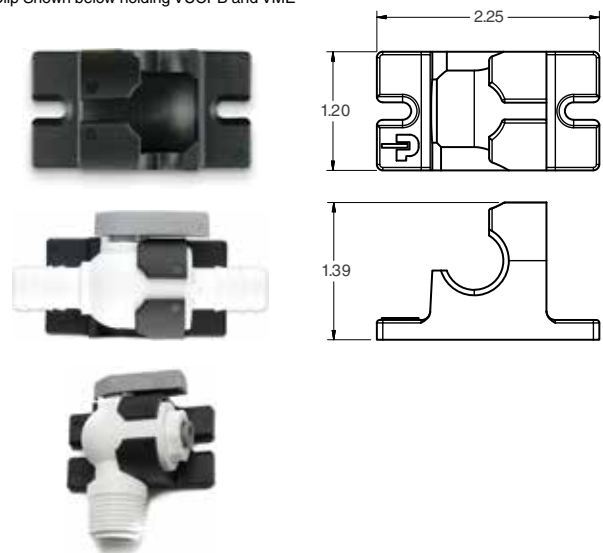

WARNING These products can expose you to chemicals including CARBON BLACK, or LEAD, which are known to the state of California to cause cancer.

[Click here for CADs, Product Specifications or to Configure Parts Online](#)

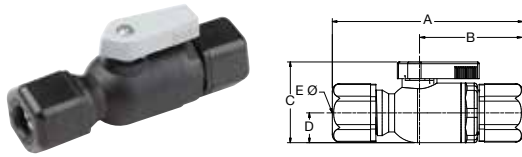

VUC - Valve Union Connector

PART NO.	1 TUBE SIZE	2 TUBE SIZE	A	B	C	D	ØE THRU HOLE MIN.
FTPPB4VUC4	1/4	1/4	2.94	1.61	1.4	.5	.19
FTPPB4VUC6	1/4	3/8	3.07	1.61	1.4	.5	.19
FTPPB6VUC6	3/8	3/8	3.19	1.73	1.4	.5	.25
FTPPB8VUC8	1/2	1/2	3.27	1.80	1.4	.5	.38

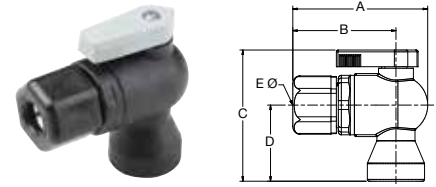

VFE - Valve Female Elbow

PART NO.	1 TUBE SIZE	NPTF THD SIZE	A	B	C	D	ØE THRU HOLE MIN.
FTPPB4VFE4	1/4	1/4	2.14	1.61	2.18	1.25	.19
FTPPB6VFE4	3/8	1/4	2.26	1.73	2.18	1.25	.19
FTPPB6VFE6	3/8	3/8	2.26	1.73	2.21	1.28	.25
FTPPB8VFE6	1/2	3/8	2.34	1.8	2.21	1.28	.25

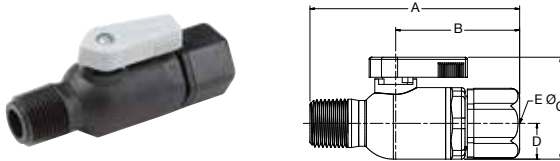

VMC - Valve Male Connector

PART NO.	1 TUBE SIZE	NPTF THD SIZE	A	B	C	D	ØE THRU HOLE MIN.
FTPPB4VMC4	1/4	1/4	2.81	1.61	1.4	.5	.19
FTPPB4VMC6	1/4	3/8	2.81	1.61	1.4	.5	.19
FTPPB6VMC4	3/8	1/4	2.93	1.73	1.4	.5	.19
FTPPB6VMC6	3/8	3/8	2.93	1.73	1.4	.5	.25
FTPPB8VMC6	1/2	3/8	3.00	1.79	1.4	.5	.25

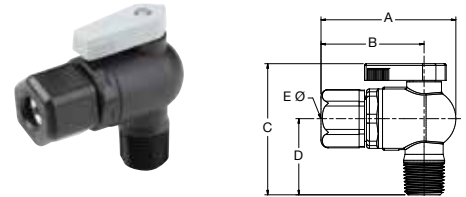

VME - Valve Male Elbow

PART NO.	1 TUBE SIZE	NPTF THD SIZE	A	B	C	D	ØE THRU HOLE MIN.
FTPPB4VME4	1/4	1/4	2.14	1.61	2.21	1.28	.19
FTPPB6VME4	3/8	1/4	2.26	1.73	2.21	1.28	.19
FTPPB6VME6	3/8	3/8	2.26	1.73	2.21	1.28	.25
FTPPB8VME8	1/2	1/2	2.34	1.8	2.4	1.47	.38

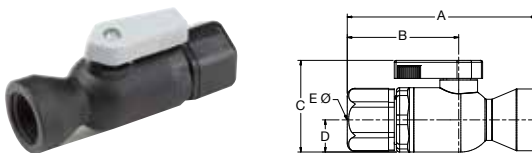

VFC - Valve Female Connector

PART NO.	1 TUBE SIZE	NPTF THD SIZE	A	B	C	D	ØE THRU HOLE MIN.
FTPPB4VFC4	1/4	1/4	2.78	1.61	1.4	.5	.19
FTPPB6VFC6	3/8	3/8	2.93	1.73	1.4	.5	.25
FTPPB8VFC6	1/2	3/8	3.00	1.8	1.4	.5	.25

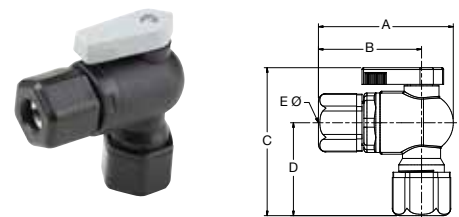

VEU - Valve Elbow Union

PART NO.	1 TUBE SIZE	2 TUBE SIZE	A	B	C	D	ØE THRU HOLE MIN.
FTPPB4VEU4	1/4	1/4	2.14	1.61	2.35	1.42	.19
FTPPB6VEU4	3/8	1/4	2.26	1.73	2.37	1.44	.19
FTPPB6VEU6	3/8	3/8	2.26	1.73	2.49	1.56	.25
FTPPB8VEU8	1/2	1/2	2.34	1.8	2.47	1.54	.38

WARNING These products can expose you to chemicals including CARBON BLACK, or LEAD, which are known to the state of California to cause cancer.



Plug Valves Series PV

Product Features:

- Extruded Brass Body
- One Piece Stem/Handle
- Acetal Stem/Handle
- 100% Leak Tested

Style:

- PV-Plug Valve

Type:

- 607-Male/Male
- 608-Male/Female
- 609-Female/Female

Specifications:

Pressure Range:

- Up to 250 PSI (17.2 bar)

Temperature Range

- -40° to +175° F (-40° to +79.4° C)

Assembly Instructions

To assure sealability and reliable performance, the valve must be installed so that the flow media travels in the direction of the arrow on the valve handle.



Valve Components

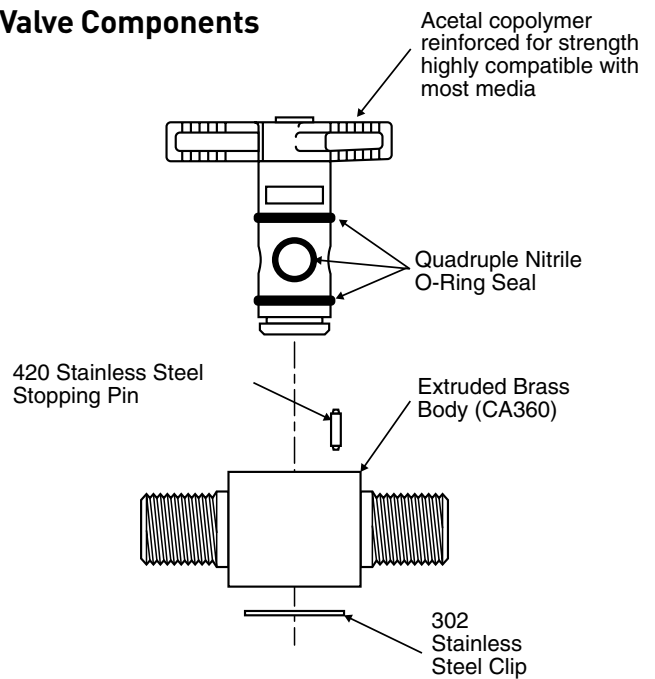

WARNING These products can expose you to chemicals including NICKEL or LEAD, which are known to the state of California to cause cancer, and LEAD.

[Click here for CADs, Product Specifications or to Configure Parts Online](#)

Male Pipe to Male Pipe Plug Valve PV607

PART NO.	PIPE THREAD	H	L	M	N	N1	FLOW DIA. D
PV607-2	1/8	.67	1.34	1.66	1.38	.51	.200
PV607-4	1/4	.67	1.34	2.02	1.38	.51	.200

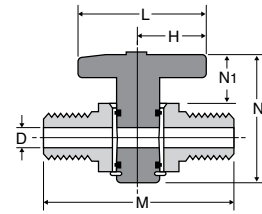

Female Pipe to Male Pipe Plug Valve PV608

PART NO.	PIPE THREAD	H	L	M	N	N1	FLOW DIA. D
PV608-2	1/8	.67	1.34	1.67	1.38	.51	.200
PV608-4	1/4	.67	1.34	2.06	1.38	.51	.200

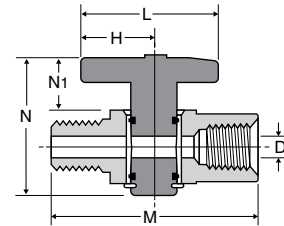

Female Pipe to Female Pipe Plug Valve PV609

PART NO.	PIPE THREAD	H	L	M	N	N1	FLOW DIA. D
PV609-2	1/8	.67	1.34	1.68	1.38	.51	.200
PV609-4	1/4	.67	1.34	2.10	1.38	.51	.200

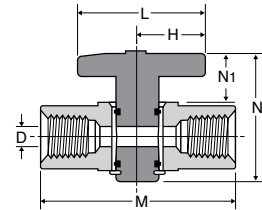

Mounting Bracket PVMB-001

PART NO.	H	M	N	N1	D
PVMB-001	.68	1.86	.90	.45	.135

Note: 1" diameter hole required in panel when using mounting bracket

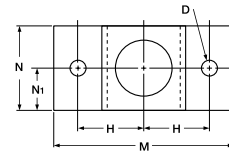

WARNING: These products can expose you to chemicals including NICKEL or LEAD, which are known to the state of California to cause cancer and LEAD.

Ball Valves Rotary Actuator Series ACT



Product Features:

- One Piece Aluminum Extrusion Body
- PTFE Seals
- Stainless Steel Shaft
- Self Lubricated Vane Seal
- Anodized Aluminum Extrusion Vane

Specifications:

Pressure Range:

- 150 PSI (10.3 bar)
Maximum Air Pressure to Actuator
- Vacuum service 28 inches Hg

Temperature Range

- -40° to +180° F (-40° to +82.2° C)

How Do Vane Actuators Work?

Parker vane actuators provide the maximum amount of output torque from the smallest possible envelope size. They convert fluid power pressure into rotary motion for a wide variety of industrial applications. Double vane units produce twice the torque output of single vane actuators from identical envelope dimensions and have a maximum rotation of 95°.

A short cylindrical chamber encloses a vane attached to a central shaft. Fluid pressure differential is applied through a stationary barrier (stator) within the cylinder to one side of the vane. The opposite side of the vane is connected to exhaust through the stator. This pressure differential produces rotation of the vane and central shaft. Due to vane actuator design there will always be some internal bypass in these units.

Rotary Actuator Series ACT Features

(See figure 1, next page)

1. **Heads**-are precision machined from aluminum, then hard-coat anodized and PTFE impregnated to ensure long seal life and low breakaway pressure.
2. **Body** - is machined from a one-piece aluminum extrusion that incorporates the stator for superior rigidity. The extrusion is hard-coat anodized and PTFE impregnated, resulting in a smooth, slick seal surface which guarantees long seal life and low breakaway pressure.
3. **Shoulder Seal** - a nitrile-energized, PTFE seal is used to reduce bypass flow and friction, providing superior performance and long life.
4. **Shaft Seal** - the high-quality, self-lubricated, abrasion-resistant nitrile seal is a multiple lobe construction for leakfree operation and greater reliability.
5. **Shaft** - stainless steel provides high strength and corrosion resistance for the most demanding applications.
6. **Bearings** - hard-coat anodized aluminum-bearing surface with permanent solid film lubricant provides substantial shaft support and wear resistance, ensuring continuous lubrication, high performance, and long life.
7. **Mounting** - combination face and base mounting offer flexibility in application and design.
8. **Vane Seal** - a special self-lubricated, abrasion-resistant nitrile compound is molded into a one-piece vane seal, providing low breakaway pressure and long life, even with no lubrication. The vane seal is also removable so that field repairs can be made, if necessary.
9. **Vane** - a hard-coat anodized aluminum extrusion permanently affixed to shaft, forming a structurally sound assembly. The light weight also reduces inertia allowing faster operating speeds.

⚠ WARNING These products can expose you to chemicals including NICKEL or LEAD, which are known to the state of California to cause cancer and LEAD.

Rotary Actuator Series ACT Features Figure 1

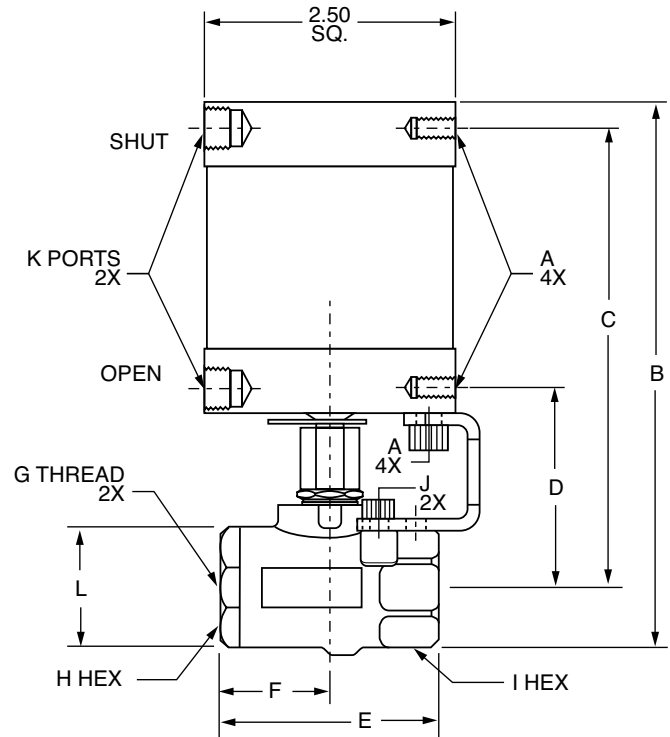
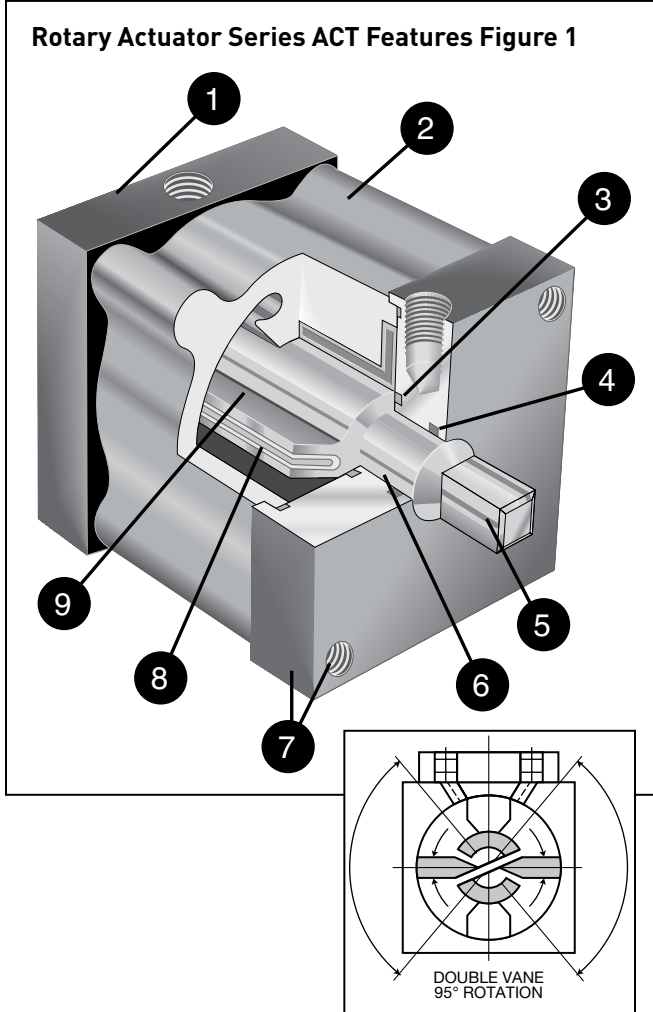

Rotary Actuator, Female Pipe Ends V502P-X-ACT

PART NO.	SIZE	A MTG. HOLES	B	C	D	E	F	G	H HEX	I HEX	J UNC	K NPTF	L	FLOW DIA.	FLOW CV	MIN. ACT PRESSURE (PSI)
V502P-4-ACT	1/4	1/4-20 UNC	5.25	4.47	1.91	2.03	1.00	1/4-18PTF	15/16	15/16	10-24	1/8-27	1.06	.375	4.0	50
V502P-6-ACT	3/8	1/4-20 UNC	5.25	4.47	1.91	2.03	1.00	3/8-18PTF	15/16	15/16	10-24	1/8-27	1.06	.375	5.8	50
V502P-8-ACT	1/2	1/4-20 UNC	5.38	4.54	1.98	2.20	1.09	1/2-14PTF*	1-1/16	1-1/16	10-24	1/8-27	1.19	.500	12.0	50
V502P-12-ACT	3/4	1/4-20 UNC	5.57	4.63	2.07	2.42	1.29	3/4-14PTF**	1-5/16	1-1/4	10-24	1/8-27	1.38	.685	25.0	75
V502P-16-ACT	1	1/4-20 UNC	5.85	4.76	2.20	2.75	1.38	1-11.5PTF**	1-9/16	1-1/2	10-24	1/8-27	1.67	.875	35.0	75

Stainless Steel Rotary Actuator, Female Pipe Ends V502SS-X-ACT

PART NO.	SIZE	A MTG. HOLES	B	C	D	E	F	G	H/I HEX	J	K NPTF	L	FLOW DIA.	FLOW CV
V502SS-4-ACT	1/4	1/4-20 UNC	5.41	4.61	2.05	2.07	1.04	1/4-18 NPT	15/16	10-24	1/8-27	1.10	.375	4.0
V502SS-6-ACT	3/8	1/4-20 UNC	5.41	4.61	2.05	2.07	1.04	3/8-18 NPT	15/16	10-24	1/8-27	1.10	.375	6.0
V502SS-8-ACT	1/2	1/4-20 UNC	5.53	4.64	2.08	2.27	1.17	1/2-14 NPT	1 1/16	10-24	1/8-27	1.28	.500	14.0

*Ptf Special Short. **Ptf Special Extra Short

WARNING These products can expose you to chemicals including NICKEL or LEAD, which are known to the state of California to cause cancer and LEAD.

[Click here for CADs, Product Specifications or to Configure Parts Online](#)

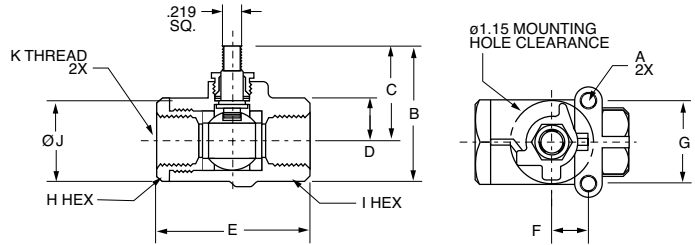

Actuator Sub-Assembly V502P-X-SUB

PART NO	SIZE	A UNC	B	C	D	E	F	G	H HEX	I HEX	J	K
V502P-4-SUB	1/4	10-24	1.68	1.15	.495	2.03	.50	1.12	15/16	15/16	1.06	1/4-18 PTF
V502P-6-SUB	3/8	10-24	1.68	1.15	.495	2.03	.50	1.12	15/16	15/16	1.06	3/8-18 PTF
V502P-8-SUB	1/2	10-24	1.78	1.19	.565	2.20	.50	1.12	1-1/16	1-1/16	1.19	1/2-14 PTF*
V502P-12-SUB	3/4	10-24	2.09	1.40	.655	2.42	.87	1.37	1-5/16	1-1/4	1.38	3/4-14 PTF**
V502P-16-SUB	1	10-24	2.38	1.54	.785	2.75	.87	1.37	1-9/16	1-1/2	1.67	1-11.5 PTF**

* PTF Special Short
 ** PTF Special Extra Short

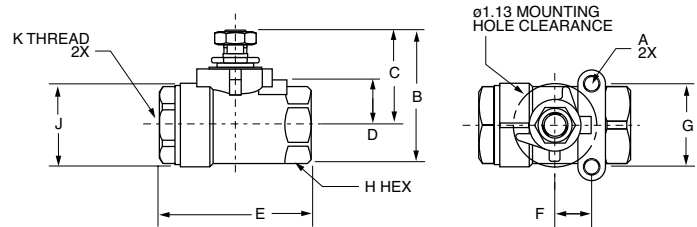

Actuator Sub-Assembly V502SS-X-SUB

PART NO	SIZE	A UNC	B	C	D	E	F	G	H HEX	J	K
V502SS-4-SUB	1/4	10-24	1.88	1.32	.63	2.07	.50	1.12	15/16	1.10	1/4-18 NPT
V502SS-6-SUB	3/8	10-24	1.88	1.32	.63	2.07	.50	1.12	15/16	1.10	3/8-18 NPT
V502SS-8-SUB	1/2	10-24	2.00	1.35	.66	2.27	.50	1.12	1-1/16	1.28	1/2-14 NPT

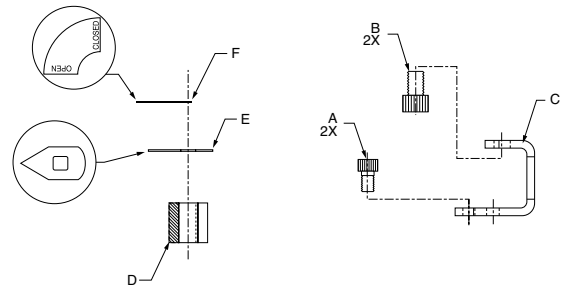

ACT-P-X-KIT

PART NO.	FOR USE WITH	A	B	C	D	E	F
ACT-P-1-KIT	V502P-4, 6, 8-ACT	10-24 UNC	1/4-20 UNC	BRACKET	.60 LONG COUPLING	POSITION INDICATOR	POSITION LABEL
ACT-P-2-KIT	V502P-12, 16-ACT	10-24 UNC	1/4-20 UNC	BRACKET	.55 LONG COUPLING	POSITION INDICATOR	POSITION LABEL

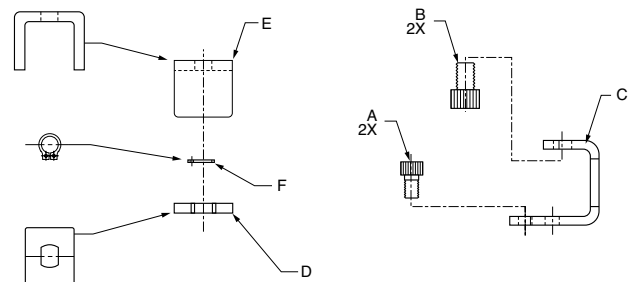

ACT-SS-X-KIT

PART NO.	FOR USE WITH	A	B	C	D	E	F
ACT-SS-1-KIT	V502SS-4, 6, 8-ACT	10-24 UNC	1/4-20 UNC	BRACKET	CLIP	HANDLE YOKE	SNAP RING

WARNING These products can expose you to chemicals including NICKEL or LEAD, which are known to the state of California to cause cancer and LEAD.

Ball Valve Series BVGL



Product Features:

- Nickel plated brass body
- Chrome plated brass ball
- PTFE seats/seals
- Fluorocarbon stem seal

Specifications:

- Female threads manufactured in accordance to DIN 2999/ISO 228

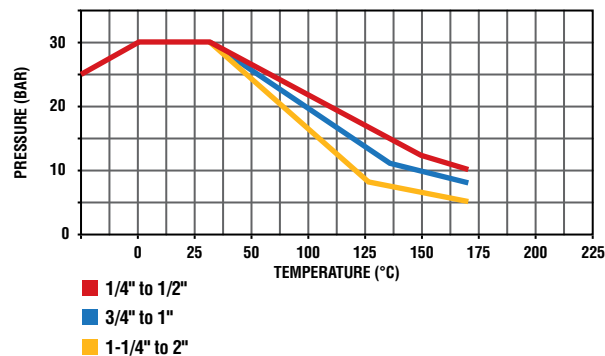

Advantages

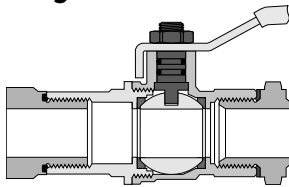

Long female threads

BVGL series valves are manufactured with long female threads in accordance to DIN 2999/ISO 228. This enables the valves to be used with Prestolok and brass adaptors but also Parker's range of steel hydraulic fittings, e.g. Triple-Lok, O-Lok, EO, and BSPP coned adaptors.

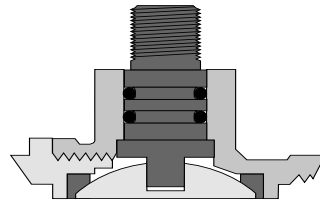

Anti extrusion stem

The BVGL series ball valves are fitted with an anti extrusion stem to prevent blow out in the case of pressure peaks. The stem is sealed with two Fluorocarbon O-rings for maximum safety and performance.

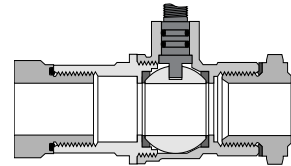

Full flow

All BVGL series valves are full-flow. This limits the turbulence created by the passage of fluid across the valve, minimizing pressure drop.

WARNING These products can expose you to chemicals including NICKEL or LEAD, which are known to the state of California to cause cancer and LEAD.

BVGL BSPP Female/Female Valve with Lever Handle

PART NO.	DN MM	THREAD BSPP	C	H	L	L1	O
BVG4-1/4L	8	1/4	20	38	50	82	25.0
BVG4-3/8L	10	3/8	20	38	60	82	25.0
BVG4-1/2L	15	1/2	25	43	75	100	32.5
BVG4-3/4L	20	3/4	32	50	80	120	39.0
BVG4-1L	25	1	41	54	90	120	47.5
BVG4-1.1/4L	32	1 1/4	50	73	110	158	59.0
BVG4-1.1/2L	40	1 1/2	55	79	120	158	71.5
BVG4-2L	50	2	70	86	140	158	86.0

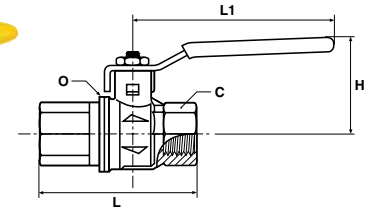

BVGT4 BSPP Female/Female Valve with Compact Handle

PART NO.	DN MM	THREAD BSPP	C	H	L	L1	O
BVGT4-1/4L	8	1/4	20	39	50	50	25.0
BVGT4-3/8L	10	3/8	20	39	60	50	25.0
BVGT4-1/2L	15	1/2	25	43	75	50	32.5
BVGT4-3/4L	20	3/4	32	47	80	60	39.0
BVGT4-1L	25	1	41	51	90	60	47.5

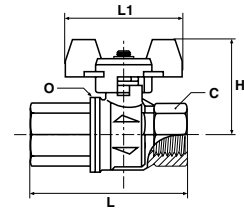

WARNING These products can expose you to chemicals including NICKEL or LEAD, which are known to the state of California to cause cancer and LEAD.

Ball Valve Series BVGLOCK



Product Features:

- Nickel plated brass body
- Chrome plated brass ball
- PTFE seats /seals
- PTFE packing gland
- Carbon steel handle

Specifications:

- Meets the requirements of European directive DI 89/392/ CEE relating to the isolation of power supply and to meet the health and safety requirements for machines and materials in paragraphs L233-5 of the code DU Travail.

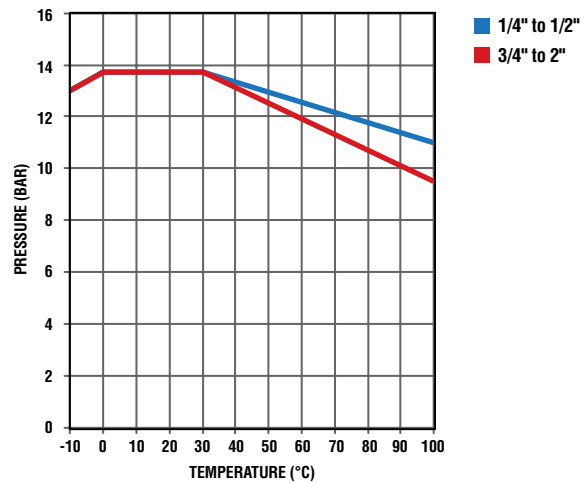

WARNING These products can expose you to chemicals including NICKEL or LEAD, which are known to the state of California to cause cancer and LEAD.

Advantages

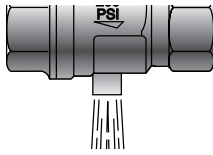

Threaded Exhaust

BVGLOCK series ball valves are manufactured with an exhaust port, this safety feature enables the downstream air pressure to be vented when the valve is closed. 1/4-1" have M5 thread. 1.1/4 and larger are not threaded.

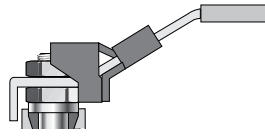

Lockable Handle

The BVGLOCK series ball valves are fitted with a handle that can be locked in the closed position with a padlock. This safety feature ensures the valve cannot be accidentally opened, and only authorized personnel can operate the valve.

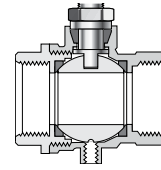

DIN 2999 / ISO 228 Female Threads

BVGLOCK series valves are manufactured with long female threads in accordance to DIN2999/ISO228. This enables the valves to be used with Prestolok and brass adaptors but also Parker's range of steel hydraulic fittings and EO-fittings form "A" or "C" to DIN 3852.

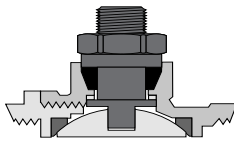

Anti Extrusion Stem

The BVGLOCK series ball valves are fitted with an anti-extrusion stem to prevent blow out in the case of pressure peaks.

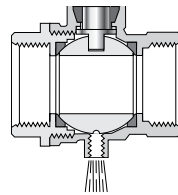

Full Flow

All BVGLOCK series valves are full-flow. This limits the turbulence created by the passage of fluid across the valve, minimizing pressure drop.

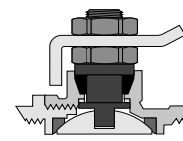

Adjustable Packing

The PTFE packing gland and adjustable washer are designed to give longer service life and lower operating torques.

BVG4PLOCK BSPP Female/Female, Vented, Locking Handle

PART NO.	D FLOW Ø	THREAD BSPP	C	G	H	I	L	L1	N
BVG4P-1/4 LOCK	8.0	1/4	20	22.5	47.5	12.0	45	96	M5
BVG4P-3/8 LOCK	9.5	3/8	20	22.5	47.5	12.0	45	96	
BVG4P-1/2 LOCK	15.0	1/2	25	29.5	52.0	15.5	59	96	
BVG4P-3/4 LOCK	19.0	3/4	31	32.0	59.5	17.0	64	117	
BVG4P-1 LOCK	24.0	1	40	40.5	63.5	21.0	81	117	
BVG4P-1.1/4LOCK	32.0	1-1/4	49	46.5	76.5	23.0	93	158	G1/4
BVG4P-1.1/2LOCK	40.0	1-1/2	54	51.0	82.5	23.0	102	158	
BVG4P-2LOCK	50.0	2	69	60.5	89.5	26.5	121	158	

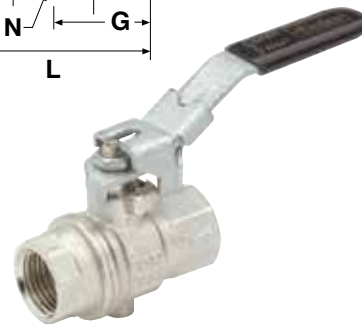
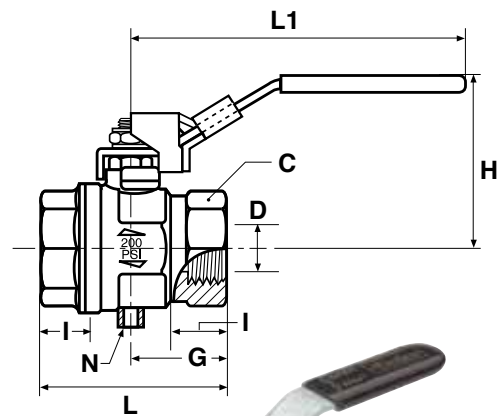

WARNING These products can expose you to chemicals including NICKEL or LEAD, which are known to the state of California to cause cancer and LEAD.

Axial Valves



Parker's Axial Valve incorporates both the valve and actuation function. With pneumatic or electro-pneumatic control, it avoids many of the restrictions associated with traditional actuators.

Product Features:

- Compact, up to 50% smaller than valves with separate actuators
- Simple to install
- Common sub-base for solenoid control
- Automation of the open/close function
- Operation independent of the upstream and downstream pressure in the circuit

Specifications:

Pressure Range:

- Up to 150 PSI (10.3 bar)

Vacuum Service:

- 29 in Hg

Pilot Pressure:

- NC: 60 to 115 PSI (4.1 to 7.9 bar)

Temperature Range:

- -4° to +275° F (-20° to +135° C)

Water at ambient temperature under a 1 bar differential pressure.

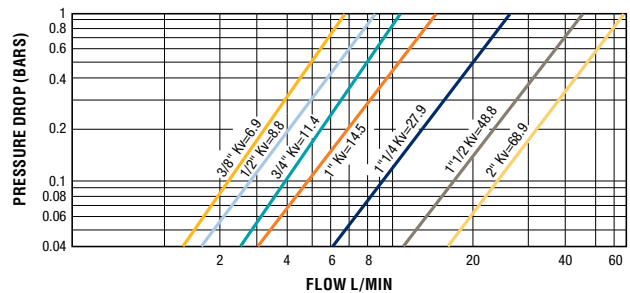

Applications:

- Injection Molding
- Pneumatics
- Packaging
- Textile
- Printing
- Robotics

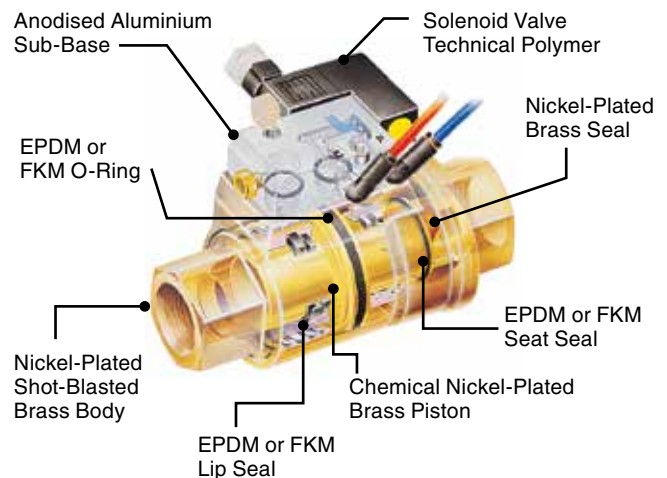

WARNING These products can expose you to chemicals including NICKEL or LEAD, which are known to the state of California to cause cancer and LEAD.

Operation

Depending on operational requirement, air is passed into the actuation chamber to open or close the valve.

Normally Closed Axial Valve (NC)

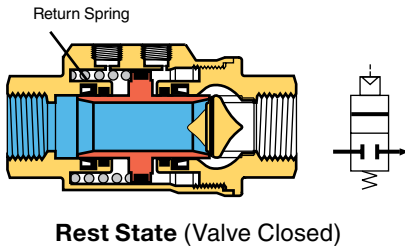

Normally Open Axial Valve (NO)

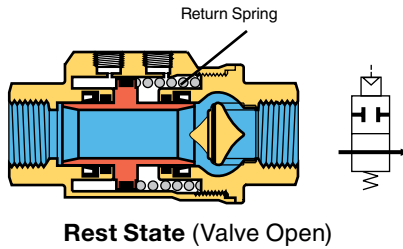

Double-Acting Axial Valve (DE)

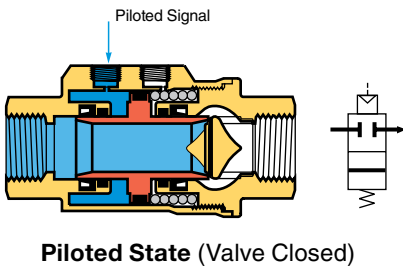
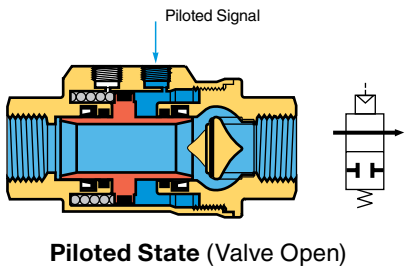
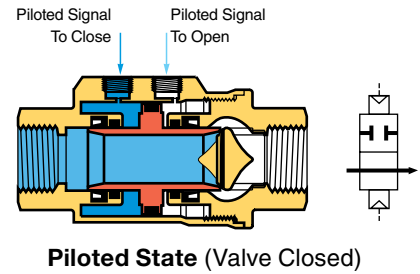

Installation Options

The Parker axial valve offers 3 different control methods dependant on the requirements of the installation:

Pneumatic Control

Example: Double-acting axial valve 4222

- Local compressed air control
- For repetitive on/off cycles
- Remote control where access to the machine is difficult
- For explosive or explosion prevention areas

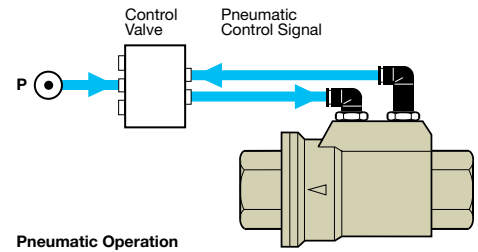

Electro-Pneumatic Control

Example: Normally closed axial valve 4202

- Sub-base and mini-solenoid valve 4298
- For automated industrial systems requiring remote control
- Namur seating plane solenoid valve

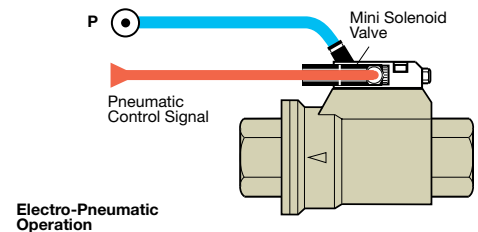

Dual Pneumatic and Electro-Pneumatic Control

Example: Normally open axial valve 4212

- Sub-base and mini-solenoid valve 4298
- Pneumatic push-button 4299
- Dual control structure
- For increased safety: prevents localised operating errors
- Namur seating plane solenoid valve

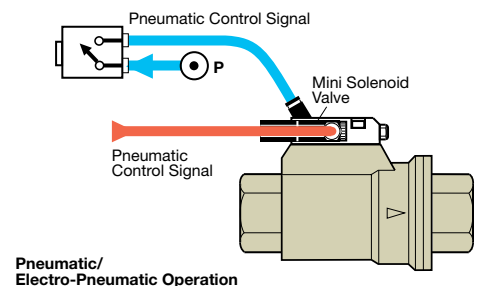

WARNING These products can expose you to chemicals including NICKEL or LEAD, which are known to the state of California to cause cancer and LEAD.

4203 Normally Closed, Double Female – NPT

PART NO.	C NPT	DN	F MM	G IN	H IN	H1 IN	L IN	LB.
4203 10 18 20	3/8	10	22	1.81	2.12	1.21	3.60	1.79
4203 15 22 20	1/2	15	27	2.03	2.33	1.31	4.13	2.39
4203 20 28 20	3/4	20	33	2.50	2.76	1.51	4.92	3.60
4203 40 50 20	1 1/2	40	60	3.78	4.01	2.12	6.67	9.22
4203 50 44 20	2	50	75	4.29	4.50	2.35	7.39	14.02

Pilot port: 1/8 - 27 NPT Complete with 1/8 NPT silencer

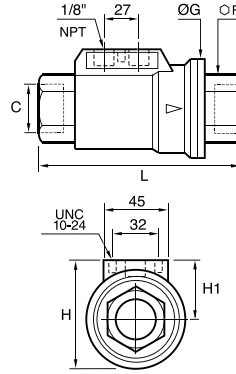
**4202 Normally Closed, Double Female – BSPP**

PART NO.	C BSPP	DN	F MM	G IN	H IN	H1 IN	L IN	KG.
4202 10 17 20	G3/8	10	22	46	54	31	98	.814
4202 15 21 20	G1/2	15	27	52	60	35	112	1.085
4202 20 27 20	G3/4	20	33	64	70	38	135	1.634
4202 25 34 20	G1	25	41	69	76	41.5	143	2.024
4202 32 42 20	G1 1/4	32	50	86	91	48	165	3.301
4202 40 49 20	G1 1/2	40	60	96	102	54	180	4.180
4202 50 48 20	G2	50	75	109	115	60.5	207	6.360

Pilot port: 1/8 BSPP Complete with 1/8 BSPT silencer

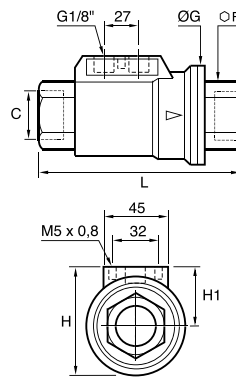

WARNING These products can expose you to chemicals including NICKEL or LEAD, which are known to the state of California to cause cancer and LEAD.

Replacement Handles

	VALVE	PLATED STEEL LEVER W/COVER	S.S. LEVER (NO COVER)	S.S. LEVER W/COVER	TEE (NO COVER)	OVAL (W/COVER)	SHORT LEVER (NO COVER)	PLATED STEEL LKG. LEVER W/COVER	S.S. LOCKING LEVER W/COVER
V500P (501, 502, 506, 510, 590, 591)	-4	2560-10082	2566-00105		2566-00147	2566-00215	2566-00231	2560-10080	2560-10081
	-6	2560-10082	2566-00105		2566-00147	2566-00215	2566-00231	2560-10080	2560-10081
	-8	2560-10082	2566-00105		2566-00147	2566-00215	2566-00231	2560-10080	2560-10081
	-10	2560-10097	2566-00178		2566-00179			2566-10100	
	-12	2560-10097	2566-00178		2566-00179	2566-00180	—	2560-10100	2560-10101
	-16	2560-10097	2566-00178		2566-00179	2566-00180	—	2560-10100	2560-10101
	-20	2566-00143	2566-00153			—	2566-00142	2566-00135	—
	-24	2566-00143	2566-00153			—	2566-00142	2566-00135	—
V501SS & V502SS	-4	—		2566-00132	—	2566-00108	2566-00146	—	2566-00138
	-6	—		2566-00132	—	2566-00108	2566-00146	—	2566-00138
	-8	—		2566-00132	—	2566-00108	2566-00146	—	2566-00138
	-12	—		2566-00133	—	2566-00109	—	—	2566-00184
	-16	—		2566-00133	—	2566-00109	—	—	2566-00184
V502SS	-20	—		2566-00134	—	—	—	—	2566-00185
	-24	—		2566-00134	—	—	—	—	2566-00185
	-32	—		2566-00134	—	—	—	—	2566-00185
V500CS & V502CS	-4	2566-00158			2566-00170	2566-00166		2566-00162	
	-6	2566-00158			2566-00170	2566-00166		2566-00162	
	-8	2566-00158			2566-00171	2566-00166		2566-00162	
	-12	2566-00159			2566-00172	2566-00167		2566-00163	
	-16	2566-00159			2566-00172	2566-00167		2566-00163	
	-20	2566-00160				2566-00168		2566-00164	
	-24	2566-00160				2566-00168		2566-00164	
V506CS	-4	2566-00158			2566-00170	2566-00166		2566-00162	
	-6	2566-00158			2566-00170	2566-00166		2566-00162	
	-8							2566-00234	
	-12	—						2566-00235	
	-16	—						2566-00236	
V533P	-4	2560-10152	2566-00105		2566-00147	2566-00215	2566-00231	2560-10160	
	-6	2560-10152	2566-00105		2566-00147	2566-00215	2566-00231	2560-10160	
	-8	2560-10152	2566-00105		2566-00147	2566-00215	2566-00231	2560-10160	
	-12	2560-10153	2566-00178		2566-00179	2566-00180		2560-10168	
	-16	2560-10153	2566-00178		2566-00179	2566-00180		2560-10168	
V520P	-4				2566-00277			2566-00262	
	-6				2566-00277			2566-00262	
	-8				2566-00277			2566-00262	
	-12				2566-00280			2566-00261	
	-16				2566-00280			2566-00261	
	-20	2566-00143	2566-00153					2566-00135	
	-24	2566-00143	2566-00153					2566-00135	
	-32	2566-00143	2566-00153					2566-00135	
	40	2566-00253							
V500HR, V506HP, V507HP	-4							BVHPLK-1 ^A	
	-6							BVHPLK-1 ^A	
	-8							BVHPLK-1 ^A	
	-12							BVHPLK-2 ^A	
	-16							BVHPLK-2 ^A	
	-20							BVHPLK-3 ^A	
	-24							BVHPLK-3 ^A	
	-32							BVHPLK-3 ^A	

^A Locking kit for use with standard handles

Replacement Handle Nuts

VALVE	PLATED STEEL	STAINLESS STEEL
V500P-4	2567-00020	2567-00023
V500P-6	2567-00020	2567-00023
V500P-8	2567-00020	2567-00023
V500P-12	2567-00055	2567-00057
V500P-16	2567-00055	2567-00057
V500P-20	2567-00051	2567-00052
V500P-24	2567-00051	2567-00052
V500P-32	2567-00051	2567-00052
V500CS-4	2567-00020	2567-00023
V500CS-6	2567-00020	2567-00023
V500CS-8	2564-00020	2567-00023

Replacement Handle Covers

VALVE	LEVER	SHORT LEVER	TEE
V500P-4	2569-00108	2569-00342	2569-00155
V500P-6	2569-00108	2569-00342	2569-00155
V500P-8	2569-00108	2569-00342	2569-00155
V500P-12	2569-00296		2569-00155
V500P-16	2569-00296		2569-00155
V500P-20	2569-00229	2569-00234	
V500P-24	2569-00229	2569-00234	
V500P-32	2569-00229	2569-00234	
V502SS-4		2569-00203	
V502SS-6		2569-00203	
V502SS-8		2569-00203	

STX	Stem Extension Kit
P	For use on Brass Ball Valves
1	1: 1/4" thru 1/2" valves 2: 3/4" thru 1" valves
125	125: 1-1/4" extension length 225: 2-1/4" extension length

STX	Stem Extension Kit
SS	For use on Stainless Steel Ball Valves
1	1: 1/4" thru 1/2" valves 2: 3/4" thru 1" valves 3: 1-1/4"-2" valves
125	125: 1-1/4" extension length 225: 2-1/4" extension length

All stem extension kit componentry is made from high quality, corrosion resistant stainless steel

Note: Stem extensions cannot be used with series 509 and series 520.

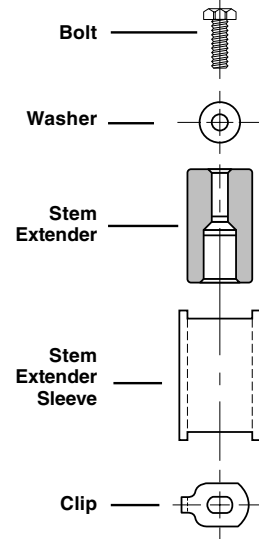

Brass Valve Extension Dimensions STX-P-1-125

PART NO.	VALVE SIZE	B HEX	C HEX	H	L	M	N	D FLOW Ø
STX-P-1-125	1/4	15/16	15/16	3.96	4.96	2.03	3.73	.375
STX-P-1-125	3/8	15/16	15/16	3.96	4.96	2.03	3.73	.375
STX-P-1-125	1/2	1-1/16	1-1/16	3.96	5.05	2.20	3.84	.500
STX-P-2-125	3/4	1-1/4	1-5/16	3.96	5.25	2.42	4.06	.685
STX-P-2-125	1	1-1/2	1-9/16	3.96	5.89	2.75	4.33	.875

Note: Drawing shows STX-P assembled to XV500P series-not included

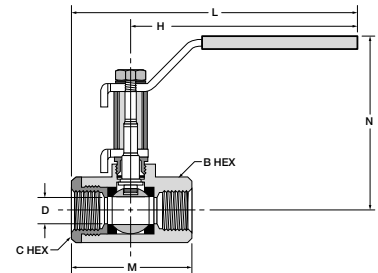

Brass Valve Extension Dimensions STX-P-1-225

PART NO.	VALVE SIZE	B HEX	C HEX	H	L	M	N	D FLOW Ø
STX-P-1-225	1/4	15/16	15/16	3.96	4.96	2.03	4.73	.375
STX-P-1-225	3/8	15/16	15/16	3.96	4.96	2.03	4.73	.375
STX-P-1-225	1/2	1-1/16	1-1/16	3.96	5.05	2.20	4.84	.500
STX-P-2-225	3/4	1-1/4	1-5/16	3.96	5.25	2.42	5.06	.685
STX-P-2-225	1	1-1/2	1-9/16	3.96	5.89	2.75	5.33	.875

Note: Drawing shows STX-P assembled to XV500P series-not included

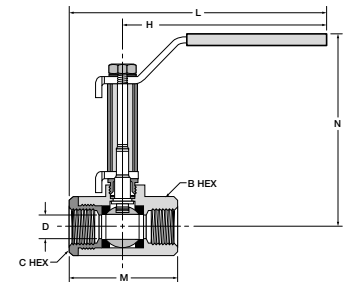

WARNING These products can expose you to chemicals including NICKEL or LEAD, which are known to the state of California to cause cancer, and LEAD.

Needle Valves



Parker's all brass needle valves have metal-to-metal seats with fine thread screwdown. The specially formulated low temperature seal remains elastic to temperatures as low as -40° F (-40° C).

Product Features:

- Extruded Brass Body & Stem
- Low Temperature Seal
- Metal-to-Metal Seal
- Pin Handle

Specifications:

Pressure Range:

- Up to 150 PSI (10.3 bar)

Temperature Range

- -40° to +175° F (-40° to +79.4° C)
- Humidifier Valve Kit & Self Piercing Humidifier Kit:
-30° to +250° F (-34.4° to +121.1° C)
- NV311P/NV312P: 0° to +150° F (-17.7° to +65.5° C)

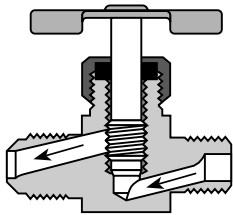
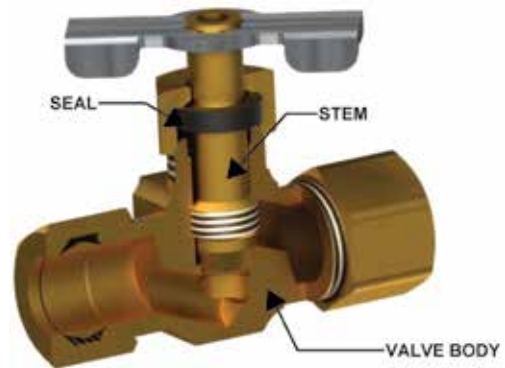

Needle Valves Installation Instructions

Series NV valves should always be installed with the pressure against the seat. Refer to drawing to determine correct direction of flow.

WARNING These products can expose you to chemicals including NICKEL or LEAD, which are known to the state of California to cause cancer and LEAD.

[Click here for CADs, Product Specifications or to Configure Parts Online](#)

Angle Needle Valve NV101F

Flare to Male Pipe * Provided with Pin Handle
 Temperature Range: -45° to +250° F (-42.7° to +121.1° C)

PART NO.	TUBE SIZE	PIPE THREAD	H	L	M	N
NV101F-4-2*	1/4	1/8	1.50	1.58	.75	.66
NV101F-6-4	3/8	1/4	1.38	1.86	.95	.90

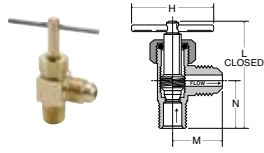

Self-Piercing Humidifier Valve Clamp Kit SPV104C-KIT

Temperature Range: -30° to +250° F (-34.4° to +121.1° C) Clamp fits 3/8" O.D. through 1.315" O.D. tube or pipe. Kit includes 60PT-4 and 63PT-4 for assembly with plastic or nylon tubing. For complete kit, specify entire part number as shown below:

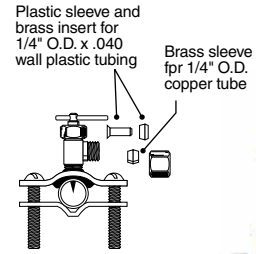

PART NO.	TUBE SIZE	PIPE THREAD
SPV104C KIT	1/4	1/8

Needle Valve NV102F

Flare to Flare *Provided with Pin Handle
 Temperature Range: -45° to +250° F (-42.7° to +121.1° C)

PART NO.	TUBE SIZE	H	L	M
NV102F-4*	1/4	1.50	1.34	1.50

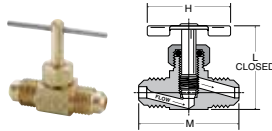

Needle Valve NV103F

Flare to Male Pipe *Provided with Pin Handle
 Temperature Range: -45° to +250° F (-42.7° to +121.1° C)

PART NO.	TUBE SIZE	PIPE THREAD	H	L	M
NV103F-4-2*	1/4	1/8	1.50	1.33	1.35

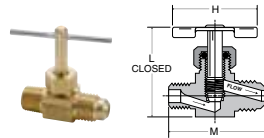

Humidifier Valve HV104C

Temperature Range: -45° to +250° F (-42.7° to +121.1° C)

PART NO.	TUBE SIZE	PIPE THREAD	H	L	M
HV104C-4-2	1/4	1/8	1.50	1.89	.53

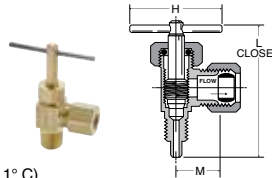

Humidifier Valve Clamp Kit HV104C-KIT

Temperature Range: -30° to +250° F (-34.4° to +121.1° C) Clamp fits 3/8" O.D. through 1.315" O.D. tube or pipe. Kit includes 60PT-4 and 63PT-4 for assembly with plastic or nylon tubing. For complete kit, specify entire part number as shown below:

PART NO.	TUBE SIZE	PIPE THREAD
HV104C-4-2 KIT	1/4	1/8

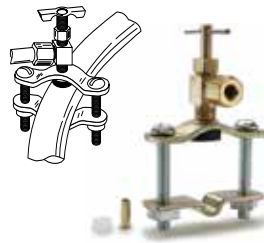

Angle Needle Valve NV104C-NV104CA

Compression to Male Pipe *Provided with Pin Handle
 Temperature Range: -45° to +250° F (-42.7° to +121.1° C)

PART NO.	TUBE SIZE	PIPE THREAD	H	L	M	N
NV104C-4-2*	1/4	1/8	1.50	1.54	.88	.67
NV104CA-4-2*	1/4	1/8	1.50	1.49	.77	.66
NV104C-4-4	1/4	1/4	1.38	1.80	.93	.75
NV104C-5-2*	5/16	1/8	1.50	1.63	.88	.68
NV104C-6-4	3/8	1/4	1.38	1.76	.94	.81

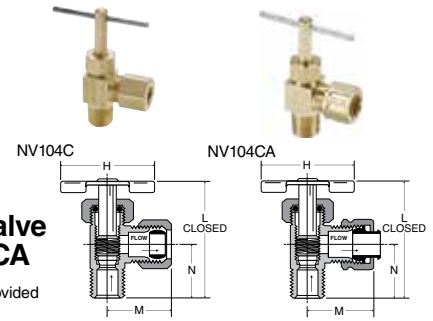

Needle Valve NV105C-NV105CA

Compression to Compression
 *Provided with Pin Handle
 Temperature Range: -45° to +250° F (-42.7° to +121.1° C)

PART NO.	TUBE SIZE	H	L	M
NV105C-4*	1/4	1.50	1.41	1.75
NV105C-5*	5/16	1.50	1.35	1.73
NV105C-6	3/8	1.38	1.55	1.93
NV105CA-4*	1/4	1.50	1.41	1.64
NV105CA-6	3/8	1.38	1.55	1.78

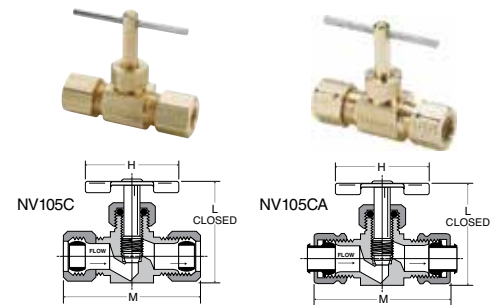

⚠ WARNING These products can expose you to chemicals including NICKEL or LEAD, which are known to the state of California to cause cancer, and LEAD.

Click here for CADs, Product Specifications or to Configure Parts Online

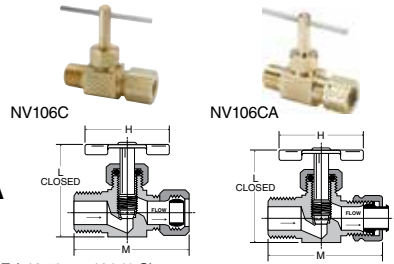

Needle Valve NV106C-NV106CA

Compression to Male Pipe
*Provided with Pin Handle
Temperature Range: -45° to +250° F (-42.7° to +121.1° C)

PART NO.	TUBE SIZE	PIPE THREAD	H	L	M
NV106C-4-2*	1/4	1/8	1.50	1.41	1.53
NV106C-4-4*	1/4	1/4	1.50	1.40	1.55
NV106C-5-2*	5/16	1/8	1.50	1.35	1.50
NV106C-6-4	3/8	1/4	1.38	1.56	1.75
NV106CA-4-2	1/4	1/8	1.50	1.41	1.47
NV106CA-4-4*	1/4	1/4	1.50	1.33	1.52
NV106CA-6-4	3/8	1/4	1.38	1.53	1.78

Needle Valve NV311P

Poly-Tite to Male Pipe
Temperature Range: 0° to +150° F (0° to +65.5° C)

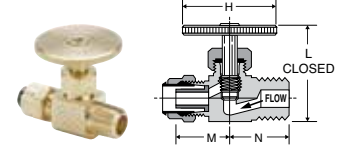

PART NO.	TUBE SIZE	PIPE THREAD	H	L	M	N
NV311P-4-2	1/4	1/8	1.07	1.17	.50	.63
NV311P-4-4	1/4	1/4	1.07	1.18	.50	.72
NV311P-6-4	3/8	1/4	1.07	1.19	.56	.72

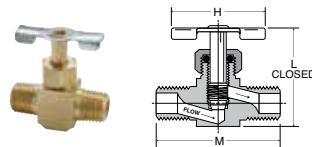

Needle Valve NV107P

Male Pipe to Male Pipe
*Provided with Pin Handle
Temperature Range: -45° to +250° F (-42.7° to +121.1° C)

PART NO.	PIPE THREAD	H	L	M
NV107P-2*	1/8	1.50	1.35	1.25
NV107P-4	1/4	1.38	1.54	1.65

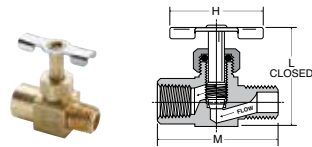

Needle Valve NV108P

Female Pipe to Male Pipe
*Provided with Pin Handle
Temperature Range: -45° to +250° F (-42.7° to +121.1° C)

PART NO.	PIPE THREAD	H	L	M
NV108P-2*	1/8	1.50	1.36	1.24
NV108P-4	1/4	1.38	1.56	1.61

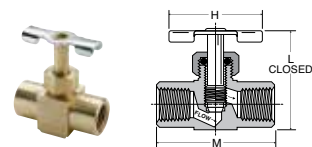

Needle Valve NV109P

Female Pipe to Female Pipe
*Provided with Pin Handle
Temperature Range: -45° to +250° F (-42.7° to +121.1° C)

PART NO.	PIPE THREAD	H	L	M
NV109P-2*	1/8	1.50	1.35	1.25
NV109P-4	1/4	1.38	1.53	1.60

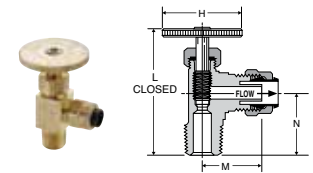

Angle Needle Valve NV312P

Poly-Tite to Male Pipe
Temperature Range: 0° to +150° F (0° to +65.5° C)

PART NO.	TUBE SIZE	PIPE THREAD	H	L	M	N
NV312P-4-2	1/4	1/8	1.07	1.53	.48	.68
NV312P-4-4	1/4	1/4	1.07	1.72	.56	.86
NV312P-6-4	3/8	1/4	1.07	1.68	.64	.86

WARNING These products can expose you to chemicals including NICKEL or LEAD, which are known to the state of California to cause cancer and LEAD.

Drain Cocks/ Ground Plug Shutoff



Parker's ground plug shutoffs are manufactured from castings or forged bodies for extra strength. Hand tightening provides a metal-to-metal seal. Drain cocks are manufactured in both external and internal seats.

Specifications:

Pressure Range:

- Ground Plug Shutoff: 30 PSI (2.0 bar)
- Drain Cocks: Up to 150 PSI (10.3 bar)

Temperature Range

- Ground Plug Shutoff: 32° to +125° F (0° to +51.6° C)
- V406P/V407P: -40° to +180° F (-40° to +82.2° C)
- Drain Cocks: -65° to +250° F (-53.8° to +121.1° C)
- DCR601: -30° to +250° F (-34.4° to +121.1° C)



WARNING These products can expose you to chemicals including NICKEL or LEAD, which are known to the state of California to cause cancer and LEAD.

Ground Plug Shutoff V203F

Flare to Flare
Temperature Range: +32° to +125° F (0° to +51.6° C)

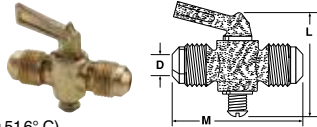

PART NO.	TUBE SIZE	L	M	FLOW DIA. D
V203F-6-6	3/8	2.26	2.13	.220
V203F-8-8	1/2	2.26	2.50	.281

Ground Plug Shutoff V204F

Flare to Male Pipe
Temperature Range: +32° to +125° F (0° to +51.6° C)

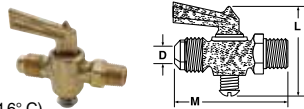

PART NO.	TUBE SIZE	PIPE THREAD	L	M	FLOW DIA. D
V204F-4-2	1/4	1/8	1.85	2.00	.188
V204F-6-4	3/8	1/4	1.85	2.18	.218

Ground Plug Shutoff V303C / V303CA

Compression to Compression
Temperature Range: +32° to +125° F (0° to +51.6° C)

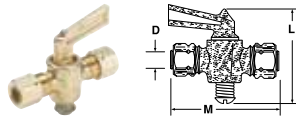

PART NO.	TUBE SIZE	L	M	FLOW DIA. D
V303C-4-4	1/4	1.88	2.33	.188
V303CA-4-4	1/4	1.90	1.75	.188
V303C-6-6	3/8	2.26	2.45	.218
V303CA-6-6	3/8	1.76	1.60	.218

Ground Plug Shutoff V304C / V304CA

Compression to Male Pipe
Temperature Range: +32° to +125° F (0° to +51.6° C)

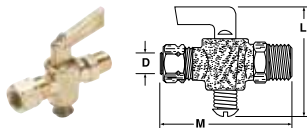

PART NO.	TUBE SIZE	PIPE THREAD	L	M	FLOW DIA. D
V304C-4-2	1/4	1/8	1.90	2.29	.188
V304CA-4-2	1/4	1/8	1.88	2.00	.188
V304C-4-4	1/4	1/4	1.90	2.15	.188
V304C-6-4	3/8	1/4	1.83	2.24	.218
V304CA-6-4	3/8	1/4	1.83	2.11	.218

Ground Plug Shutoff V401P

Male Pipe to Male Pipe
Temperature Range: +32° to +125° F (0° to +51.6° C)

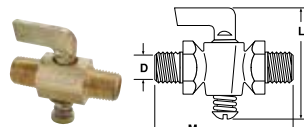

PART NO.	PIPE THREAD	L	M	FLOW DIA. D
V401P-2-2	1/8	1.90	2.25	.188
V401P-4-4	1/4	1.90	1.98	.188

Ground Plug Shutoff V402P

Female Pipe to Male Pipe
Temperature Range: +32° to +125° F (0° to +51.6° C)

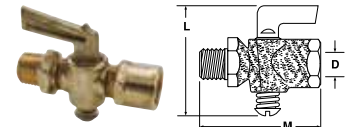

PART NO.	FEMALE PIPE THREAD	PIPE THREAD	L	M	FLOW DIA. D
V402P-2-2	1/8	1/8	1.85	1.78	.218
V402P-4-4	1/4	1/4	1.86	2.26	.218
V402P-6-6	3/8	3/8	2.34	2.21	.245

Ground Plug Shutoff V403P

Female Pipe to Female Pipe
Temperature Range: +32° to +125° F (0° to +51.6° C)

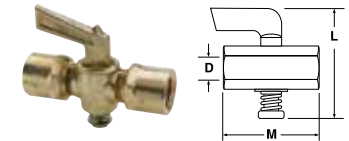

PART NO.	FEMALE PIPE THREAD	L	M	FLOW DIA. D
V403P-2-2	1/8	1.90	1.51	.218
V403P-4-4	1/4	1.90	1.65	.188
V403P-6-6*	3/8	2.25	2.00	.250

*Made from extruded bar stock

Three-Way Valve V406P

Female Pipe three ends
Temperature Range: -40° to +180° F (-40° to +82.2° C)

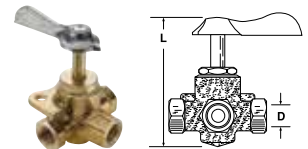

PART NO.	PIPE THREAD	L	FLOW DIA. D
V406P-4	1/4	3.10	.281

Four-Way Valve V407P

Female Pipe four ends
Temperature Range: -40° to +180° F (-40° to +82.2° C)

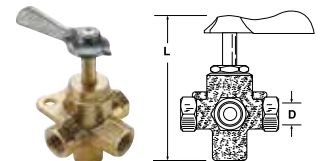

PART NO.	PIPE THREAD	L	FLOW DIA. D
V407P-4	1/4	3.30	.281

Ground Plug Shutoff DC601

Temperature Range: +32° to +125° F (0° to +51.6° C)

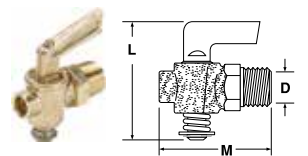

PART NO.	PIPE THREAD	L	M	FLOW DIA. D
DC601-2	1/8	1.90	1.40	.170
DC601-4	1/4	1.90	1.52	.170
DC601-6	3/8	2.26	1.74	.281
DC601-8	1/2	2.29	1.82	.281

WARNING: These products can expose you to chemicals including NICKEL or LEAD, which are known to the state of California to cause cancer and LEAD.

[Click here for CADs, Product Specifications or to Configure Parts Online](#)

Drain Cock DCR601

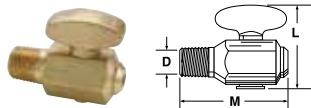

Temperature Range: -30° to +250° F (-34.4° to +121.1° C)

PART NO.	PIPE THREAD	L	M	FLOW DIA. D
DCR601-4	1/4	1.41	1.73	.156

Bib Drain Valve DC607

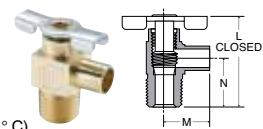

Temperature Range: -65° to +250° F (-53.8° to +121.1° C)

PART NO.	HOSE SIZE	PIPE THREAD	FLOW	L	M	N
DC607-4	3/8	1/4	.28	1.32	.67	.71

Internal Seal Drain Cock DC602

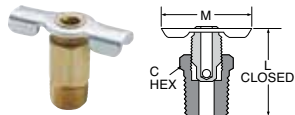

Temperature Range: -65° to +250° F (-53.8° to +121.1° C)

PART NO.	PIPE THREAD	C HEX	L	M
DC602-2	1/8	13/32	.92	1.25
DC602-4	1/4	9/16	.94	1.25

Drain Cock DC603

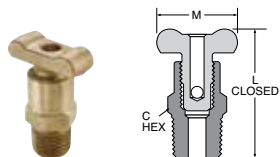

Temperature Range: -65° to +250° F (-53.8° to +121.1° C)

PART NO.	PIPE THREAD	C HEX	L	M
DC603-2	1/8	5/8	1.41	1.00
DC603-4	1/4	5/8	1.54	1.16
DC603-6	3/8	11/16	1.63	1.16

External Seal Drain Cock DC604

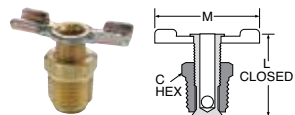

Temperature Range: -65° to +250° F (-53.8° to +121.1° C)

PART NO.	PIPE THREAD	C HEX	L	M
DC604-2*	1/8	7/16	.85	1.25
DC604-4	1/4	9/16	1.00	1.38
DC604-6*	3/8	11/16	1.22	1.68

*When assembled handle wings are down facing

External Seal Drain Cock DC606

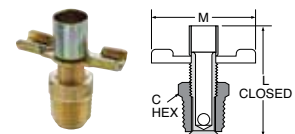

Temperature Range: -65° to +250° F (-53.8° to +121.1° C)

PART NO.	PIPE THREAD	C HEX	L	M
DC606-4	1/4-18	9/16	1.50	1.38

WARNING These products can expose you to chemicals including NICKEL or LEAD, which are known to the state of California to cause cancer and LEAD.



Accessories

Blow Guns

Silencers

Bins, Bags
& Copper Tubing



For Bins information visit:
www.parker.com/bins



GOODYEAR
RUBBER PRODUCTS, INC.

+1.727.342.5087

También puede enviarnos un correo electrónico a ventas@goodyearrubberproducts.com

Blow Guns

410-S

Controlled Pressure
p. L6



410-SV

Controlled Pressure
p. L6



415-S

Controlled Pressure
p. L6



400-S-TIP

Replacement Tip
p. L6



410

Full Pressure
p. L6



410-N

Full Pressure
p. L6



415-N

Full Pressure
p. L6



BG441-NBL

BG Series
p. L7



BG442-SBL

BG Series
p. L7



BG443-NBL

BG Series
p. L7



BG444-SBL

BG Series
p. L7



0653

NPT/BSPP
p. L8



0652-0655

BSPP
p. L8



0656-0657

Angled Nozzle
p. L8



Nozzles

0690 03

Straight Tube
Nozzle Long
p. L9



0690 04

Straight Tube
Nozzle Short
p. L9



0690 05

Angled Tube
Nozzle Long
p. L9



0690 06

Angled Tube
Nozzle Short
p. L9



0690 08

Coanda Effect
Nozzle
p. L10



0690 09

Air Screen Nozzle
p. L10



0690 10

Booster Nozzle
p. L10



0690 11

Booster Nozzle
with Air Screen
p. L10



Silencers

0673 0610 0670

Threaded Silencer
UNF, NPT or BSPP
p. L11



0671

Plug-In Silencer
p. L11



0673

Compact Threaded
Silencer Male
BSPP, M5
p. L11



0677

Miniature
Silencer BSPP
p. L11



0614 0672

Flow Control
Silencer Male
NPT, BSPP
p. L12



0611 0674

Threaded Silencer
NPT, BSPP, M5
p. L12



0676

Flow Control
Silencer BSPP
p. L12



0682

Stainless Steel
Threaded Silencer
Male BSPP
p. L12



0683

Stainless Steel
Threaded Silencer
Male NPT
p. L12



WARNING These products can expose you to chemicals including NICKEL or LEAD, which are known to the state of California to cause cancer and LEAD.

Bins

16-CB

16 Compartment
p. L13



24-CB

24 Compartment
p. L13



ADJ-CB

Adjustable
Compartments
p. L13



4CB-SR

Slide Rack
p. L13



LSR-STAND

Stand
p. L14



9-DC

9 Drawer
p. L14



18-DC

18 Drawer
p. L14



24B-CABINET

24 Opening
p. L14



40B-STAND

Stand
p. L14



40B-CABINET

40 Opening
p. L15



PNEU-CAB

Mobile Cabinet
p. L15



Bags

4X6PSB

Clear Plastic Bag
p. L15



6X8PSB

Clear Plastic Bag
p. L15



Copper Tubing

X50CT

Coiled Copper Tubing
p. L15



WARNING These products can expose you to chemicals including NICKEL or LEAD, which are known to the state of California to cause cancer and LEAD.

Blow Guns

Controlled Pressure Blow Guns

Parker Controlled Pressure Blow Guns meet OSHA requirements (section 29 CFR 1910.242 paragraph b), and directive #100-1. "Compressed air shall not be used for cleaning purposes except where reduced to less than 30 psi, and then only with effective chip guarding and personal protective equipment."

Parker Controlled Pressure Blow Guns have a black epoxy coated zinc body and vented nozzles to prevent pressure build-up when dead ending occurs up to 150 PSI (10.3 bar).

SPECIFICATIONS		
PART NO.	MAXIMUM PRESSURE PSI (BAR)	WT. (LB) P/PIECE
410-S	150 (10.3)	.50
410-SV	150 (10.3)	.53
415-S	150 (10.3)	.48



410-S

Parker Controlled Pressure Blow Guns features thumb lever valve actuator and brass nozzle. Inlet port is 1/4" NPT.



410-SV

Parker Venturi Nozzle Controlled Pressure Blow Gun with thumb lever valve and large venturi side ports for high volume flow. Inlet port is 1/4" NPT.



415-S

Parker Controlled Pressure Blow Guns features push button valve actuator and brass nozzle. Inlet port is 1/4" NPT.



400-S-TIP

Blow Gun Replacement Tip

Full Pressure Blow Guns

The following Parker Blow Guns must have a pressure regulator setting below 30 psi to conform to OSHA safety requirements 29 CFR 1910.242 Paragraph b.

SPECIFICATIONS		
PART NO.	MAXIMUM PRESSURE PSI (BAR)	WT. (LB) P/PIECE
410	150 (10.3)	.48
410-N	150 (10.3)	.51
415-N	150 (10.3)	.49



410

Parker two way thumb lever valve has a zinc body with 1/4" NPT inlet and 1/8" NPSF outlet.

Note: Standard Gun without nozzle.



410-N

Parker thumb lever style Blow Gun features a zinc body, brass nozzle, and 1/4" NPT female inlet.



415-N

Parker Blow Gun features a push button style actuator, zinc body with a brass nozzle and 1/4" NPT female inlet.

WARNING These products can expose you to chemicals including NICKEL or LEAD, which are known to the state of California to cause cancer and LEAD.

[Click here for CADs, Product Specifications or to Configure Parts Online](#)

BG Series Blow Guns

Made from impact resistant plastic, BG Series blow guns are durable and versatile. Extended nozzles allow air to be directed where it is required. The pistol grip trigger allows greater control over the amount of air delivered. Combined, these two features provide superior performance in a light weight, ergonomically designed package.

Nozzles are available in short and extended versions and most models meet OSHA directives on the use of compressed air for cleaning purposes. OSHA directive #100-1 states that “when dead ending occurs a static pressure at the main orifice shall not exceed 30 psi.” For those blow guns that do not meet this requirement, OSHA requires that “compressed air shall not be used for cleaning purposes except where reduced to less than 30 psi, and then only with effective

chip guarding and personal protective equipment” (section 29 CFR 1910.242 paragraph b). Please refer to the blow gun descriptions below for compatibility with OSHA directive #100-1.

Nozzle configurations are designed for maximum flexibility. Applications with special requirements may find the BG443-NBL with a 1/8” NPT fitting convenient for adapting existing nozzles or extra-long extensions. For information on specials or made-to-order blow gun nozzles, please contact the Quick Coupling Division.

- Easy to control variable flow pistol grip trigger.
- Nozzles available that meet OSHA requirements.
- Lightweight ergonomical design.
- Bodies are constructed of impact resistant plastic.

SPECIFICATIONS	
RATED PRESSURE PSI	175 (12.0 bar)
TEMPERATURE RANGE	TO +120° F (+48.8° C)
INLET PORT	1/4” NPTF

NOMENCLATURE	
EXAMPLE: BG442-SBL	ATTRIBUTE:
BG	BG SERIES BLOW GUN
4	INLET PORT IN 16THS
42	NOZZLE STYLE 41 - EXTENDED 42 - EXTENDED (OSHA) 43 - 1/8" FNPT 44 - SHORT (OSHA)
S	MEETS OSHA REQUIREMENTS S - YES N - NO
BL	COLOR BL - BLACK

BG441-NBL BG Series Blow Gun

PART NO.	NOZZLE	MEETS OSHA REQUIREMENTS
BG441-NBL	EXTENDED	NO



BG443-NBL BG Series Blow Gun

PART NO.	NOZZLE	MEETS OSHA REQUIREMENTS
BG443-NBL	1/8" FEMALE NPT	NO



BG442-SBL BG Series Blow Gun

PART NO.	NOZZLE	MEETS OSHA REQUIREMENTS
BG442-SBL	EXTENDED	YES



BG444-SBL BG Series Blow Gun

PART NO.	NOZZLE	MEETS OSHA REQUIREMENTS
BG444-SBL	VORTEC	YES



WARNING These products can expose you to chemicals including NICKEL or LEAD, which are known to the state of California to cause cancer and LEAD.



New “Energy Saving” Flow Reducer System

- The flow reducer system allows for 40% savings in air consumption and guarantees stable flow, max 120 NI/min
- Can be adapted to all available interchangeable nozzles
- Available in a lower connection, threaded 1/4 NPT or 1/4 BSPP
- When combined with a specific interchangeable nozzle, the “energy saving” blow gun complies to OSHA 1910.242(b) nozzle and or OSHA 1910.95(b), addressing reduced pressure when in close proximity to an obstacle, chip guarding and noise level.

0653 Flow Reducer Blowgun NPT/BSPP

PART NO.	C NPT	C1	F IN	H1 IN	H2 IN	L1 IN	L2 IN	WT OZ
0653 66 14	1/4	M12X1.25	.79	4.60	1.34	5.78	.060	6.35

PART NO.	C BSPP	C1	F IN	H1 IN	H2 IN	L1 IN	L2 IN	WT KG
0653 66 13	G1/4	M12X1.25	20	117	34	147	1.5	.180

Combined with the osha 1910.242(B) nozzle, when in close proximity to an obstacle, the flow is deviated to reduce pressure to 0.5 Bar at the end of the nozzle.

The flow reducer system allows for 40% savings in air consumption and guarantees stable flow max 120 nl/m

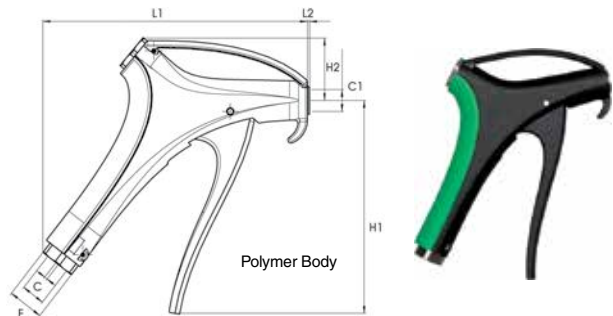

0652-0655 Progressive Control Blowgun BSPP

PART NO.	C BSPP	C1	F MM	H1 MM	H2 MM	L1 MM	L2 MM	WT KG
0652 66 13	G1/4	M12X1.25	17	128	14	120	1.5	.161
0655 66 13	G1/4	M12X1.25	20	117	37	145	2	.014

Choose from the wide range of interchangeable nozzles to have the right tool for the job - please refer to pages L8 and L9

0652 66 13 - lower connection
0655 66 13 - upper connection

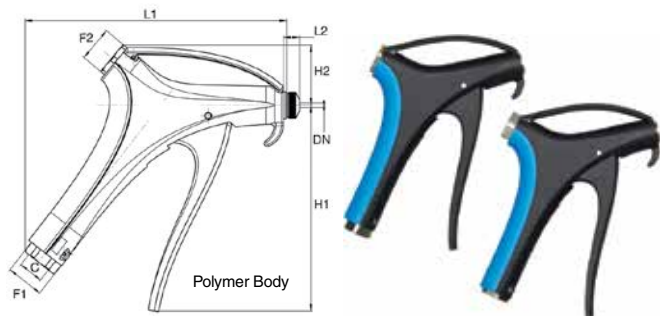

0656-0657 Progressive Control Blowgun Short Angled Nozzle NPT/BSPP

PART NO.	C NPT	C1	F IN	H1 IN	H2 IN	L1 IN	L2 IN	WT OZ
0656 66 13	1/4	M12X1.25	17	4.99	.55	4.68	.06	5.97

PART NO.	C BSPP	C1	F IN	H1 IN	H2 IN	L1 IN	L2 IN	WT KG
0657 66 13	G1/4	M12X1.25	17	128	14	120	1.5	.169

0656 66 13 - lower connection
0657 66 13 - upper connection

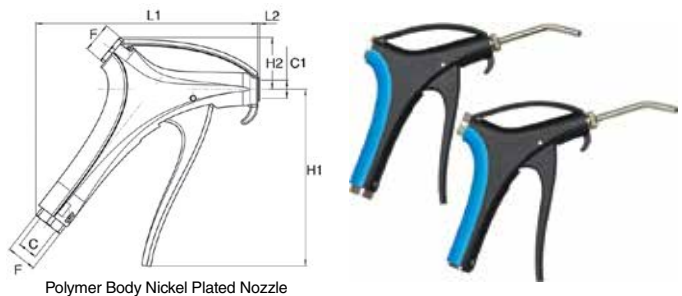

WARNING These products can expose you to chemicals including NICKEL or LEAD, which are known to the state of California to cause cancer, and LEAD.

[Click here for CADs, Product Specifications or to Configure Parts Online](#)

0690 03 Straight Tube Nozzle Long

PART NO.	C METRIC	DN	G IN	L IN	L1 IN	WT OZ
0690 03 00	M12X1.25	2.5	.59	13	12	2.09
SPREAD OF CONE	MAX FLOW TOLLERANCE ± 10%	NOISE LEVEL ISO15744				
21°	365 NI/MIN	83 dBA				

- OSHA 1910.95 (b) conforming
- Directive 2003/10/EC*

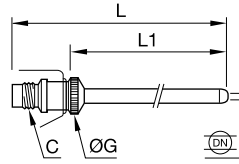

0690 04 Straight Tube Nozzle Short

PART NO.	C METRIC	DN	G IN	L IN	L1 IN	WT OZ
0690 04 00	M12X1.25	2.5	.59	4	3	1.13
SPREAD OF CONE	MAX FLOW TOLLERANCE ± 10%	NOISE LEVEL ISO15744				
21°	385 NI/MIN	82 dBA				

- OSHA 1910.242 (b) conforming
- OSHA 1910.95 (b) conforming
- Directive 2003/10/EC*

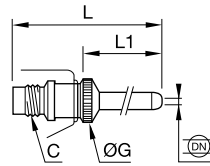

0690 05 Angled Tube Nozzle Long

PART NO.	C METRIC	DN	G IN	L IN	L1 IN	WT OZ
0690 05 00	M12X1.25	2.5	.59	12.4	11.5	2.09
SPREAD OF CONE	MAX FLOW TOLLERANCE ± 10%	NOISE LEVEL ISO15744				
21°	330 NI/MIN	82 dBA				

- OSHA 1910.95 (b) conforming
- Directive 2003/10/EC*

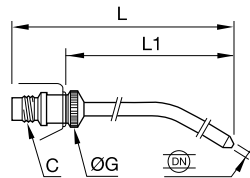

0690 06 Angled Tube Nozzle Short

PART NO.	C METRIC	DN	G IN	L IN	L1 IN	WT OZ
0690 06 00	M12X1.25	2.5	.59	3.7	2.75	1.13
SPREAD OF CONE	MAX FLOW TOLLERANCE ± 10%	NOISE LEVEL ISO15744				
21°	565 NI/MIN	86 dBA				

- OSHA 1910.242 (b) conforming
- OSHA 1910.95 (b) conforming
- Directive 2003/10/EC*

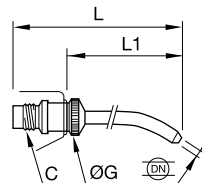

* Hearing protectors should always be worn when exposure to noise lasts longer than 8 hours.

⚠ **WARNING** These products can expose you to chemicals including NICKEL or LEAD, which are known to the state of California to cause cancer and LEAD.

Click here for CADs, Product Specifications or to Configure Parts Online

0690 08 Coanda Effect Nozzle

PART NO.	C METRIC	L IN	L1 IN	WT OZ
0690 08 00	M12X1.25	1.87	1.02	1.06
SPREAD OF CONE	MAX FLOW TOLLERANCE ± 10%	NOISE LEVEL ISO15744		
20°	240 NI/MIN	73 dBA		

- OSHA 1910.242 (b) conforming
- OSHA 1910.95 (b) conforming
- Directive 2003/10/EC*

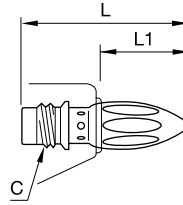

0690 09 Air Screen Nozzle

PART NO.	C METRIC	DN	G IN	L IN	L1 IN	WT OZ
0690 09 00	M12X1.25	2	1.18	1.59	.73	.68
SPREAD OF CONE	MAX FLOW TOLLERANCE ± 10%	NOISE LEVEL ISO15744				
JET 24° SCREEN 140°	650 NI/MIN	86 dBA				

- OSHA 1910.242 (b) conforming
- OSHA 1910.95 (b) conforming
- Directive 2003/10/EC*

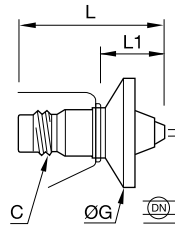

0690 10 Booster Nozzle

PART NO.	C METRIC	DN	G IN	L IN	L1 IN	WT OZ
0690 10 00	M12X1.25	2.5	.59	2.52	1.65	1.22
SPREAD OF CONE	MAX FLOW TOLLERANCE ± 10%	NOISE LEVEL ISO15744				
28°	335 NI/MIN	99 dBA				

- OSHA 1910.95 (b) conforming
- Directive 2003/10/EC*

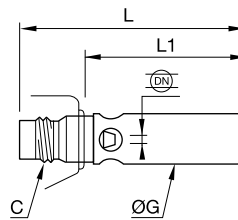

0690 11 Booster Nozzle with Air Screen

PART NO.	C METRIC	DN	G IN	G1 IN	L IN	L1 IN	WT OZ
0690 11 00	M12X1.25	2.5	1.18	.59	2.99	2.13	1.48
SPREAD OF CONE	MAX FLOW TOLLERANCE ± 10%	NOISE LEVEL ISO15744					
JET 26° SCREEN 140°	625 NI/MIN	86 dBA					

- OSHA 1910.242 (b) conforming
- OSHA 1910.95 (b) conforming
- Directive 2003/10/EC*

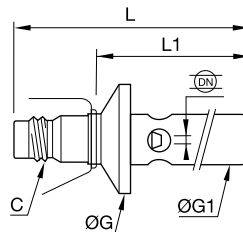

* Hearing protectors should always be worn when exposure to noise lasts longer than 8 hours.

⚠ WARNING These products can expose you to chemicals including NICKEL or LEAD, which are known to the state of California to cause cancer and LEAD.

Silencers

Technical Specification of Silencers:

MATERIAL	WORKING PRESSURE	WORKING TEMPERATURE
SINTERED BRONZE	175 PSI (12.0 bar)	-4° to +300° F (-20° to +148.8° C)
POLYETHYLENE	145 PSI (9.9 bar)	-14° to +175° F (-25.5° to +79.4° C)
STAINLESS STEEL	175 PSI (12.0 bar)	-4° to +355° F (-20° to +179.4° C)

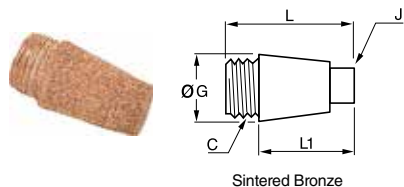

0673 0610 0670 Threaded Silencer UNF, NPT or BSPP

PART NO.	C UNF/NPT	J IN	G IN	L IN	L1 IN	WT OZ
0673 00 20*	10-32	.27	.31	.34	.18	.07
0610 00 11	1/8	.31	.42	.89	.71	.21
0610 00 14	1/4	.39	.59	1.10	.87	.46
0610 00 18	3/8	.51	.75	1.42	1.14	.85
0610 00 22	1/2	.59	.91	1.73	1.42	1.48

PART NO.	C BSPP	J MM	G MM	L MM	L1 MM	WT KG
0670 00 10	G1/8	7	12	20.5	15	.007
0670 00 13	G1/4	8	15	24.5	18.5	.013
0670 00 17	G3/8	10	19	37	29	.033
0670 00 21	G1/2	14	23	40	31	.049
0670 00 27	G3/4	16.5	29.5	51	40.5	.092
0670 00 34	G1	20	36	60	49.5	.140

* Brass Body

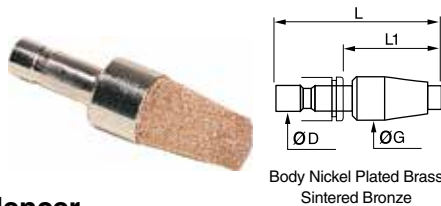

0671 Plug-In Silencer

PART NO.	C	G MM	L MM	L1 MM	WT OZ
0671 04 00	4	13	41.5	24.5	.015
0671 06 00	6	15	48	29	.023
0671 08 00	8	15	49.5	29.5	.024
0671 10 00	10	19.5	68	43.5	.054
0671 12 00	12	20	68.5	43	.055

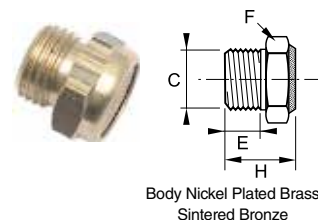

0673 Compact Threaded Silencer Male BSPP, M5

PART NO.	C	E MM	F MM	H MM	WT OZ
0673 00 10	G1/8	4	13	12	.006
0673 00 13	G1/4	6	16	16	.012
0673 00 17	G3/8	8	19	17	.022
0673 00 19	M5X0.8	8	8	8.5	.001
0673 00 20	UNF 10-32	4	6	11	.006
0673 00 21	G1/2	9	24	18	.037

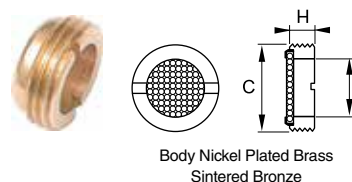

0677 Miniature Silencer BSPP

PART NO.	C	G MM	H MM	WT OZ
0677 00 10	G1/8	5.5	4	.002
0677 00 13	G1/4	6	4.5	.003
0677 00 17	G3/8	9.5	5	.006
0677 00 21	G1/2	12.5	5.5	.012
0677 00 27	G3/4	19	6	.014
0677 00 34	G1	24	7	.025

WARNING These products can expose you to chemicals including NICKEL or LEAD, which are known to the state of California to cause cancer, and LEAD.

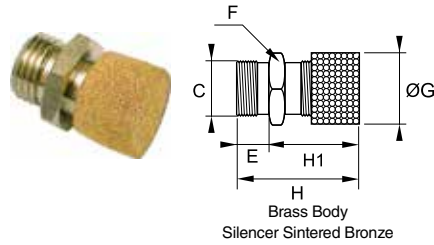

0614 0672 Flow Control Silencer Male NPT, BSPP

PART NO.	C NPT	E	F MM	G	H MIN	H MAX	H1	WT OZ
0614 00 22	1/2	.47	27	1.06	1.54	1.65	1.30	1.55

PART NO.	C BSPP	E MM	F MM	G MM	H MIN	H MAX	H1 MM	WT KG
0672 00 10	1/8	8	14	14	24	27	18	.012
0672 00 13	1/4	8	17	17	25	28	19	.023
0672 00 17	3/8	10	22	22	30	33	24	.033
0672 00 21	1/2	12	27	27	39	42	33	.044

Consult us for flow characteristics

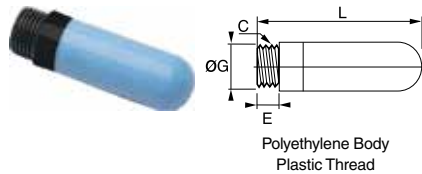

0611 0674 Threaded Silencer NPT, BSPP, M5

PART NO.	C NPT	E IN	G IN	L IN	WT OZ
0611 00 11	1/8	.24	.49	1.34	.07
0611 00 14	1/4	.28	.61	1.67	.11
0611 00 22	1/2	.43	.93	3.07	.35

PART NO.	C BSPP	E MM	G MM	L MM	WT OZ
0674 00 19	M5X0.8	4	6.5	23	.001
0674 00 10	G1/8	6	12.5	34	.002
0674 00 13	G1/4	7	15.5	42.5	.003
0674 00 17	G3/8	11.5	18.5	67.5	.006
0674 00 21	G1/2	11	23.5	78	.010
0674 00 27	G3/4	15.5	38.5	131	.040
0674 00 34	G1	19.5	49	160	.050

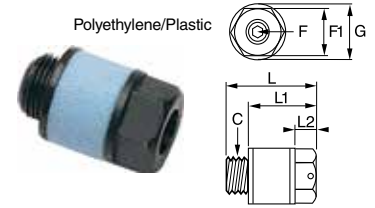

0676 Flow Control Silencer BSPP

PART NO.	C BSPP	F MM	F1 MM	G MM	L MM	L1 MM	L2 MM	WT OZ
0676 00 10	G1/8	2.5	13	15	20.5	14.5	5	.002
0676 00 13	G1/4	4	15	18	29	22	7	.007

FLOW SCFM AT 87 PSI											
NO. OF TURNS	0	1	2	3	4	5	6	7	8	9	NOISE LEVEL dBA*
0676 00 10	0	1.06	3.2	7.4	11.8	13	13.8	13.8	13.9	13.9	82
0676 00 13	0	.78	.88	1.77	12	26.5	33	34.6	35.3	36	84

* dBA at 87 PSI and 12 SCFM

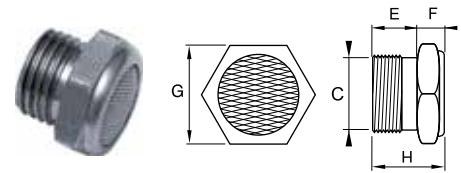

0682 Stainless Steel Threaded Silencer Male BSPP

PART NO.	C BSPP	E MM	F MM	G MM	H MM	WT KG
0682 00 10	G1/8	8	7	14	15	.009
0682 00 13	G1/4	8	7	17	15	.013
0682 00 17	G3/8	10	8	22	18	.020
0682 00 21	G1/2	12	10	27	22	.038
0682 00 27	G3/4	15	12	32	27	.066
0682 00 34	G1	18	14	38	32	.118

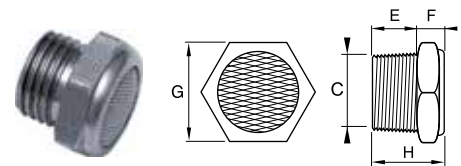

0683 Stainless Steel Threaded Silencer Male NPT

PART NO.	C NPT	E IN	F IN	G MM	H IN	WT KG
0683 00 11	1/8	.28	.28	14	.55	.35
0683 00 14	1/4	.43	.28	17	.71	.53
0683 00 18	3/8	.43	.31	22	.75	.81
0683 00 22	1/2	.59	.39	27	.98	1.55

WARNING These products can expose you to chemicals including NICKEL or LEAD, which are known to the state of California to cause cancer and LEAD.

Bins, Bags & Copper Tubing

16 Compartment Large Scoop Box

- Prime cold rolled steel outer shell
- High impact styrene insert with 16 compartments
- Scooped bottom compartments for easy part removal
- Full piano hinge on cover provides rigidity
- Positive pull-down catch keeps cover tightly closed to prevent part migration
- Handle allows for easy transport
- Durable gray powder coat finish

PART NO.	DIMENSIONS (IN.)		
	WIDTH	DEPTH	HEIGHT
16-CB	18	12	3



24 Compartment Large Scoop Box

- Prime cold rolled steel outer shell
- High impact styrene insert with 24 compartments
- Scooped bottom compartments for easy part removal
- Full piano hinge on cover provides rigidity
- Positive pull-down catch keeps cover tightly closed to prevent part migration
- Handle allows for easy transport
- Durable gray powder coat finish

PART NO.	DIMENSIONS (IN.)		
	WIDTH	DEPTH	HEIGHT
24-CB	18	12	3



ADJ-CB

- Prime cold rolled steel outer shell
- High impact styrene insert with 4 fixed vertical compartments and 9 moveable dividers adjustable on 1" centers
- Full piano hinge on cover provides rigidity
- Positive pull-down catch keeps cover tightly closed to prevent part migration
- Durable gray powder coat finish

PART NO.	DIMENSIONS (IN.)			COMPARTMENTS
	WIDTH	DEPTH	HEIGHT	
ADJ-CB	18	12	3	ADJUSTABLE



Easy Glide Slide Rack (Holds 4 16-CB or 24-CB per rack)

- Sturdy construction using prime cold-rolled steel
- Each cradle holds up to 40 lbs
- Easy glide slides allow boxes to move in and out smoothly
- Center braces on cradles provide extra rigidity
- Reinforced rack keeps boxes level
- Boxes can be easily removed for transport to work areas
- Base and locking hinge are available as accessories
- Durable gray powder coat finish

PART NO.	DIMENSIONS (IN.)		
	WIDTH	DEPTH	HEIGHT
4CB-SR	20	15.75	15



WARNING These products can expose you to chemicals including NICKEL or LEAD, which are known to the state of California to cause cancer and LEAD.

Click here for CADs, Product Specifications or to Configure Parts Online

LSR-Stand

- Sturdy all steel construction
- Raises units 15 inches off the floor
- Legs attach easily using fasteners provided
- Durable gray powder finish

PART NO.	DIMENSIONS (IN.)		
	WIDTH	DEPTH	HEIGHT
LSR-STAND	20 5/8	16 1/4	15 5/8



9 Drawer Cabinet

- Prime cold rolled steel construction
- High density drawer cabinet, easy to store large quantities of small parts
- Drawers feature interlocking design for superior strength
- Drawers have full width handles and easy glide runners
- Each drawer includes 2 easy label dividers, which are adjustable on 1" centers
- Cabinets can be stacked using mounting holes
- Durable gray powder coat finish
- Ships fully assembled

PART NO.	DIMENSIONS (IN.)			DRAWER DIMENSIONS (IN.)		
	WIDTH	DEPTH	HEIGHT	WIDTH	DEPTH	HEIGHT
9-DC	17.25	11.625	10.875	5.375	11.25	2.75



18 Drawer Cabinet

- Prime cold rolled steel construction
- High density drawer cabinet, easy to store large quantities of small parts
- Drawers feature interlocking design for superior strength
- Drawers have full width handles and easy glide runners
- Each drawer includes 2 easy label dividers, which are adjustable on 1" centers
- Cabinets can be stacked using mounting holes
- Durable gray powder coat finish
- Ships fully assembled

PART NO.	DIMENSIONS (IN.)			DRAWER DIMENSIONS (IN.)		
	WIDTH	DEPTH	HEIGHT	WIDTH	DEPTH	HEIGHT
18-DC	17.25	11.625	21.25	5.375	11.25	2.75



24 Opening Bin

- All welded, prime cold rolled steel
- Fully hemmed 1 1/8" bin fronts to hold labels and retain parts
- Roll-formed sides for increased strength and stability
- Ribbed and hemmed dividers provide added strength
- Modular with most 12" deep bins and drawer cabinets; mounting holes are located at both the top and bottom
- Durable gray powder coat finish
- Ships fully assembled

PART NO.	DIMENSIONS (IN.)			BIN DIMENSIONS (IN.)		
	WIDTH	DEPTH	HEIGHT	WIDTH	DEPTH	HEIGHT
24B-CABINET	33.75	12	23.875	5.375	11.875	5.5



Parker Brass Products Base Stand for 40B Cabinets

- Stands are 12" high
- Designed for use with 40B Cabinets
- Each stand includes a 15 piece bolt and nut set package for assembly

PART NO.	DIMENSIONS (IN.)		
	WIDTH	DEPTH	HEIGHT
40B-STAND	33.75	12	23.875



WARNING These products can expose you to chemicals including NICKEL or LEAD, which are known to the state of California to cause cancer and LEAD.

[Click here for CADs, Product Specifications or to Configure Parts Online](#)

40 Opening Bin

- All welded, prime cold rolled steel
- Fully hemmed 1 1/8" bin fronts to hold labels and retain parts
- Roll-formed sides for increased strength and stability
- Ribbed and hemmed dividers provide added strength
- Modular with most 12" deep bins and drawer cabinets; mounting holes are located at both the top and bottom
- Durable gray powder coat finish
- Ships fully assembled



PART NO.	DIMENSIONS (IN.)			BIN DIMENSIONS (IN.)		
	WIDTH	DEPTH	HEIGHT	WIDTH	DEPTH	HEIGHT
40B-CABINET	33.75	12	23.875	3.8125	11.875	3.8125

Pneumatic Cabinet

- High quality all-steel construction
- Partitioning slots provide flexibility for customization
- Drawer locks limit access to prevent loss and improve safety when moved
- Drawer interlock prevent opening multiple drawers that could cause accidental tip over
- Available fitting and connector labels with photos make easy selection and restock easy
- Locking 4" heavy-duty casters
- Retainer top with a non-skid mat work surface



PART NO.	DIMENSIONS (IN.)			DRAWERS
	WIDTH	DEPTH	HEIGHT	
PNEU-CAB	22.1875	28.5	39.5	5-3" AND 1-9"

Clear Plastic Shipping Bags PSB

Reusable, clear polyethylene, zip-lock style bags with panels for marking Part No., quantity, and availability information. Features easy visual part identification. Ideal for custom packaging of less than box quantities.

PART NO.	SIZE
4X6PSB	4" X 6"
6X8PSB	6" X 8"



Copper Tubing

Copper tubing meets A.S.T.M. specification B-280 (copper tube for refrigeration field service)

PART NO.	TUBE O.D.	TUBE I.D.	WALL THICKNESS	FEET PER COIL
50CT-2-30	1/8	.065	.030	50
50CT-3-30	3/16	.128	.030	50
50CT-4-30	1/4	.190	.030	50
50CT-5-32	5/16	.249	.032	50
50CT-6-32	3/8	.311	.032	50
50CT-8-32	1/2	.436	.032	50



WARNING These products can expose you to chemicals including NICKEL or LEAD, which are known to the state of California to cause cancer and LEAD.



Tube Fabricating Equipment

Tube Cutters

Tube Benders

Flaring Tools

In-Ex[®] Tube Deburring Tool





■ Tube Cutter

TC-1000-BPD
1/8" - 1 1/8"
p. M5



TC-1050-BPD
1/8" - 5/8"
p. M5



174-F-BPD
3/8" - 1 1/8"
p. M5



218B-BPD
1/8" - 1 1/8"
p. M6



PTC-001
Plastic Tube cutter
p. M6



3000 71 11
For tubing &
push-on hose
p. M6



■ Tube Benders

367-FH-BPD
Lever Type
p. M7



368-FH-BPD
Lever Type
p. M7



102-F-XX-BPD
Spring Type
p. M7



■ Flaring Tools

525-F-BPD
Flaring Kit
p. M8



93-FB-BPD
Flaring Tool
p. M8



945TH-BPD
Flaring Tool
p. M8



■ Tube Deburring Tool

226-BPD
Deburring Tool
p. M8



■ Replacement Parts

S75015-BPD
Cutting Wheel
p. M5



S75046-BPD
Cutting Wheel
for Stainless
p. M5



S32633-BPD
Cutting Wheel
p. M5



PTC-001RB
Replacement
Blades
p. M6



⚠ WARNING These products can expose you to chemicals including NICKEL or LEAD, which are known to the state of California to cause cancer and LEAD.

Tube Cutters

For hard or soft copper, aluminum, brass, thin wall steel, stainless steel, monel, titanium and other metal tubing. Rollers have flare cut-off groove, fold away reamer and spare cutting wheel.



PART NO.	DESCRIPTION
TC-1000-BPD	For 1/8" to 1 1/8" (4 to 28 mm) O.D. tubing, (1/8" to 1" nom.). Length: 4 15/16" Weight: 6 1/2 oz.
REPLACEMENT PARTS:	
S75015-BPD	Standard cutting wheel
S75046-BPD	Cutting wheel for stainless steel and hard temper tubing



PART NO.	DESCRIPTION
TC-1050-BPD	Requires only 1 1/4" swing radius. (Requires only 1 3/8" swing radius with 5/8" tube.) Repositioned rollers to bottom of tool allows for easier cutter engagement on tubing. Enclosed feed-screw minimized contamination, assuring continued free operation. Redesigned feed mechanism improves overall cutting action. Size: 1 3/4" x 1 1/4" x 1/2" Weight: 2 1/2 oz.
S32633-BPD	Cutting wheel for TC-1050-BPD



PART NO.	DESCRIPTION
174-F-BPD	Requires only 1 15/16" swing radius. (Requires only 2 1/4" swing radius with 1 1/8" tube.) Size: 2 11/16" x 2 1/32" x 1 1/8" Weight: 5 oz.
REPLACEMENT PARTS:	
S75015-BPD	Cutting wheel
S75046-BPD	Cutting wheel for stainless steel and hard temper tubing

WARNING These products can expose you to chemicals including NICKEL or LEAD, which are known to the state of California to cause cancer and LEAD.

Kloskut Tube Cutters

Adjustable tube cutters to produce square cut ends with no external burr and minimum internal burring when used on fully annealed copper, brass, aluminum, and steel tubing. Features a hardened and burnished tool-steel cutting wheel, flare cut-off grooves in rollers for removal of old flares, swing-away reamer for removing internal burrs. Handle feeds and adjusts cutting wheel to uniformly cut tubing as the cutter is rotated.

NOTE: Tube cutters are not recommended for use with stainless steel tubing because of the work hardening effect. The use of a hacksaw with a "Tru-Kut" Sawing Vise or a rotary teeth saw is best recommended for stainless steel.



PART NO.	DESCRIPTION
218B-BPD	Medium Kloskut For tubing sizes -2 (1/8" O.D.) to -18(1 1/8" O.D.) Weighth: 11 oz.



PART NO.	DESCRIPTION
PTC-001	Plastic Tube Cutter May be used with polyethylene, Polypropylene, nylon and other thermoplastic tubing. For tube O.D. sizes 1/8" to 1/2"
PTC-001RB	Replacement blades



PART NO.	DESCRIPTION
3000 71 11	Tube cutter for tubing & push-on hose For hoses up to 1" (25mm) Weighth: 1.09 oz.
3000 71 11 05	Replacement blades

WARNING These products can expose you to chemicals including NICKEL or LEAD, which are known to the state of California to cause cancer and LEAD.

Tube Benders, Lever Type

For soft copper, aluminum, brass, steel and other metal tubing. Triple Header Benders Calibrated markings for making accurate left-hand, right-hand and offset bends. Ninety degree start requires less effort - making bending fast and easy.



PART NO.	DESCRIPTION
367-FH-BPD	For 1/8", 3/16" and 1/4" O.D. tubing, 9/16" radius to center of tube.
368-FH-BPD	For 1/4", 5/16" and 3/8" O.D. tubing, 15/16" radius to center of tube.

Metric Tube Benders

Triple Header Benders For annealed copper, aluminum, steel, stainless steel and hard copper tubing of bending temper. Lever type, multiple size benders. Calibrated markings for making accurate left-hand, right-hand, and offset bends. Ninety degree start requires less effort; makes bending fast and easy.



PART NO.	DESCRIPTION
367-FH-BPD	For 3, 4, 6 mm O.D. tubing, 14.2 mm radius to center of tube.
368-FH-BPD	For 6 and 8 mm O.D. tubing, 17.5 mm radius to center of tube.

Tube Benders, Spring Type

For soft copper and aluminum tubing. For 1/4" to 5/8" O.D. tubing. Tools allow hand bending of soft tubing to any shape without collapsing walls. Special spring steel, nickel finished. End belled for quick tube removal.



PART NO.	TUBE O. D. IN	LENGTH IN	WEIGHT OZ
102-F-04-BPD	1/4	10	3
102-F-06-BPD	3/8	10	4
102-F-08-BPD	1/2	12	6 1/2

WARNING These products can expose you to chemicals including NICKEL or LEAD, which are known to the state of California to cause cancer and LEAD.

Flaring Tools



PART NO.	DESCRIPTION
525-F-BPD	Flares and burnishes 3/16" to 5/8" (5 to 16 mm) O.D. tubing. Unique, self-adjusting, tube holding mechanism permits use in tight quarters. Faceted, hard chrome finished cone rolls out and burnishes perfect 45° flare above the tube holding mechanism.
	Weight: 1 3/4 lbs.

PART NO.	DESCRIPTION
93-FB-BPD	For 3/16", 1/4", 5/16", 3/8" and 1/2" O.D. tubing.
	Recommended for Bundy, GM and other brazed or welded soft steel tubing (wall thickness to .035"). Also makes single or double flares in soft copper or aluminum tubing. Forged steel yoke; swivel-type hard chrome-finished flaring cone.
	Weight: 3 lbs.

PART NO.	DESCRIPTION
945TH-BPD	Rolo-flair® Manual Rotary Flaring Tool
	For soft metal tubing. Precision burnished 45° flares in tube sizes from 2 (1/8" O.D.) to 12 (3/4" O.D.) with an easy turn of the handle. For copper and aluminum alloy.
	Weight: 2 1/2 lbs.

In-Ex® Tube Deburring Tool



PART NO.	DESCRIPTION
226-BPD	Insert tube into the convexed end of the In-Ex for inside deburring and the opposite end for outside deburring. Rotate in either direction. Replacement blades can be ordered.
	Weight: 10 oz.

WARNING These products can expose you to chemicals including NICKEL or LEAD, which are known to the state of California to cause cancer and LEAD.



General Technical

Tubing Compatibility Chart

Manufacturing Techniques

Tube Line Fabrication Guide
for Leak Free Systems

Thread Specifications

Flaring Instructions

Thread Designations and Standards for
Threads Used in Fluid Connectors

Straight Thread Size Comparison Chart

S.A.E. Part Index

SAE Standards

U.L. Listed Fittings

Flow Curves

Flare and Thread Profiles

Pressure Conversions

English/Metric Conversions

Assembly Guides

Fluid Compatibility Guide



GOODYEAR
RUBBER PRODUCTS, INC.

+1.727.342.5087

También puede enviarnos un correo electrónico a ventas@goodyearrubberproducts.com

Tubing Compatibility Chart

Nomenclature

- PS Plastic Sleeve & Tube Support Recommended
- TS Tube Support Is Recommended
- BS Brass Sleeve Recommended
- CL Clamp Required
- MG Metal Gripper Collet Recommended
- Tube/Fitting Combination Compatible
- Tube/Fitting Combination Not Compatible

Product Sizes (inch)		Soft Metal Tubing			Parflex Thermoplastic Tubing											
		Copper	Aluminum	Steel	Industrial Tubing Series (Outside Diameter Shown)											
					Polyethylene E & EB Inch (4,5,6,8,10) Metric (6,8,10,12)	Polyethylene PEFR Inch (2,5,4,6,8)	Polyethylene HDPE Inch (4,6)	Nylon N Inch (2,2.5,3,4,5,6,8) Metric (4mm - 20mm)	Nylon PAT Inch (2,4,6,8,10,12)	Nylon NR Inch (2,3,4,5,6,8)	Nylon NTNA Inch (2,2.5,3,4,5,6,8)	Polypropylene PP & PPB Inch (2,3,4,5,6,8,10)	95U/95UM Series Inch (2,2.5,4,6,8,12) Metric (4,6,8,10,12)	Polyurethane HUFR (Weld Tubing) Inch (4,6,8)	Clear Vinyl Inch (1/8" - 2 1/2")	
Compression & Flare	Compression Inch (2,3,4,5,6,7,8,10,12)	BS	BS		PS TS	PS TS	PS TS	PS TS	PS TS	PS TS		PS TS				
	Compress-Align Inch (2,3,4,5,6,8,10,12,14,16)				TS	TS	TS	TS	TS	TS		TS				
	Metric Compression Metric (4,5,6,8,10,12,14,16,18,20,22,25,28)				TS			TS		TS		TS	TS			
	Poly-Tite Inch (4,5,6,8)	BS						BS				BS				
	Hi-Duty Inch (2,3,4,5,6,8,10)				TS	TS	TS	TS	TS	TS		TS				
	45 degree flare Inch (2,3,4,5,6,8,10,12,14)															
	Inverted Flare Inch (2,3,4,5,6,8,10,12)															
	Fast & Tite Inch (4,5,6,8,10)													TS		TS
Push-to-Connect	Flow Controls Inch (2,2.5,4,5,6,8) Metric (4,6,8,10,12)												TS			
	Prestolok PLP Metal Inch (2,2.5,3,4,5,6,8)															
	Prestolok PLP Composite Inch (2,2.5,3,4,5,6,8,10) Metric (3,4,6,8,10,12,14,16)												TS			
	Prestolok PLM Metal Inch (2,5,4,5,6,8) Metric (4,6,8,10,12,14)															
	Prestolok PLS Stainless Steel Inch (2,5,3,4,5,6,8) Metric (4,6,8,10,12)															
	Liquifit Inch (2,5,4,6,8) Metric (4,6,8,10,12)															
	TrueSeal Inch (4,5,6,8)	MG									MG		MG	TS		TS
Barb	Par-Barb Inch (2,3,4,5,6,8,10,12,16,20,24) Inside Diameter														CL	
	Dubl-Barb Inch (2,5,4,6,8)															
	Hose Barb Inch (2,3,4,5,6,8,10,12,16) Inside Diameter														CL	
	Garden Hose														CL	
DOT Transportation	NTA Inch (3,4,6,8,10,12)															
	Transmission Fittings Inch (2,2,5)															
	Air Brake Inch (4,6,8,10,12,16)															
	Air Brake Hose Inch (6,8)															
	Vibra-Lok Inch (2,3,4,5,6,8,10,12)															
	Prestomatic Inch (4,6,8,10) Metric (6,8,10,12,16)															
	PTC Inch (2,5,3,4,6,8,10,12)															

Tubing Compatibility Chart

Parflex Thermoplastic Tubing								IHP/HPD Hose		Nomenclature	Product Sizes (inch)	
Transportation Tubing				Fluoropolymer Tubing				GPH General Purpose Inch (3,4,6,8,12) Inside Diameter	Parker 271 hose (SAE J1402) Inch (6,8) Inside Diameter			
PFT Air Brake (SAE J844) Inch (2,2.5,3,4,5,6,8,10,12)	Air Brake DIN 74324 (Nylon 12) Metric (4,6,8,10,12,15,16,18)	PFT Diesel Fuel Sizes 4,6,8,10,12	HTFL Diesel Fuel Sizes 4,6,8,10,12	PFA Inch (3/32" - 1") Metric (4mm - 12mm)	FEP Inch (1/8" - 1") Metric (3mm - 12mm)	PTFE Inch (3/32" - 1.1") Metric (3mm - 16mm)	PVDF Inch (2,3,4,5,6,8,10,12,16)					
				PS	PS	PS	PS			Compression	Compression & Flare	
				TS	TS	TS	TS			Inch (2,3,4,5,6,7,8,10,12)		
				TS	TS	TS	TS			Compress-Align		
				TS	TS	TS	TS			Inch (2,3,4,5,6,8,10,12,14,16)		
										Metric Compression		
										Metric (4,5,6,8,10,12,14,16,18,20,22,25,28)		
										Poly-Tite		
										Inch (4,5,6,8)		
										Hi-Duty		
										Inch (2,3,4,5,6,8,10)		
										45 degree flare		
										Inch (2,3,4,5,6,8,10,12,14)		
										Inverted Flare		
										Inch (2,3,4,5,6,8,10,12)		
										Fast & Tite		
										Inch (4,5,6,8,10)		
										Flow Controls		
										Inch (2,2.5,3,4,5,6,8) Metric (4,6,8,10,12)		
										Prestolok PLP Metal		
										Inch (2,2.5,3,4,5,6,8)		
										Prestolok PLP Composite		
										Inch (2,2.5,3,4,5,6,8,10) Metric (3,4,6,8,10,12,14,16)		
										Prestolok PLM Metal		
										Inch (2.5,4,5,6,8) Metric (4,6,8,10,12,14)		
										Prestolok PLS Stainless Steel		
										Inch (2.5,3,4,5,6,8) Metric (4,6,8,10,12)		
										Liquifit		
										Inch (2.5,4,6,8) Metric (4,6,8,10,12)		
				MG	MG	MG	MG			TrueSeal		
										Inch (4,5,6,8)		
								CL		Par-Barb		
										Inch (2,3,4,5,6,8,10,12,16,20,24) Inside Diameter		
										Dubl-Barb		
										Inch (2.5,4,6,8)		
								CL		Hose Barb		
										Inch (2,3,4,5,6,8,10,12,16) Inside Diameter		
								CL		Garden Hose		
										NTA		
										Inch (3,4,6,8,10,12)		
										Transmission Fittings		
										Inch (2,2.5)		
										Air Brake		
										Inch (4,6,8,10,12,16)		
										Air Brake Hose		
										Inch (6,8)		
										Vibra-Lok		
										Inch (2,3,4,5,6,8,10,12)		
										Prestomatic		
										Inch (4,6,8,10) Metric (6,8,10,12,16)		
										PTC		
										Inch (2.5,3,4,6,8,10,12)		
										SAE Cartridge		

- Nomenclature**
- PS Plastic Sleeve & Tube Support Recommended
 - TS Tube Support Is Recommended
 - BS Brass Sleeve Recommended
 - CL Clamp Required
 - MG Metal Gripper Collet Recommended
 - Tube/Fitting Combination Compatible
 - Tube/Fitting Combination Not Compatible

Manufacturing Techniques

Parker Extruded fittings

Hexagon, round and shaped bars are extruded in the configuration required, drawn to size, cut to length and straightened. First a solid round billet (8 to 12 inches in diameter) is heated to the pliable state and forced by pressure of approximately 80,000 pounds per square inch through a die. The resulting continuous length of bar is cooled and then drawn through dies to the desired external size. (The drawing process also controls the temper.) After straightening, the bar is ready for machining.

The process produces a dense, nonporous material somewhat stronger in the longitudinal direction due to an orientated flow of the grain.

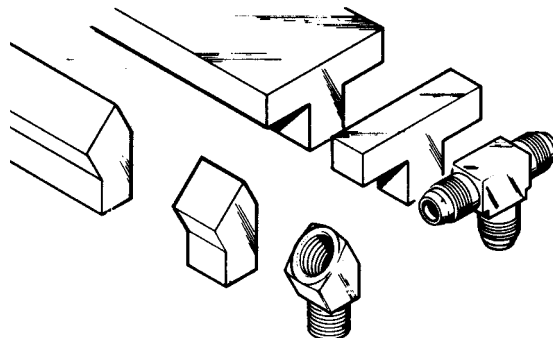

Material used for Parker Brass Fittings

(Reference SAE J461)

Straight bodies:	barstock CA 360 or CA 345
Shape bodies:	extruded barstock CA 360
Shape bodies:	forged CA 377
Nuts:	barstock CA 360
Nuts:	forged CA 377

Parker Forged Fittings

Material for forgings is extruded in round bars, cut to length and straightened. (At this point in the process, forging rod differs from round extruded machinable bars only in temper and chemical properties.) After straightening, the bars are cut again into slugs (short lengths), reheated to the pliable state and pressed under a pressure of approximately 25,000 pounds per square inch between upper and lower die cavities. After cooling the flash is trimmed away and the forging blank is ready for machining.

This process of forming under extreme pressure produces a uniformly dense material of exceptional strength. Because grain flow follows the contour, the fitting has high impact strength and is more resistant to mechanical shock and vibration.

Of the major brass fittings producers, only Parker offers elbows and tees machined from both extruded and forged shapes.

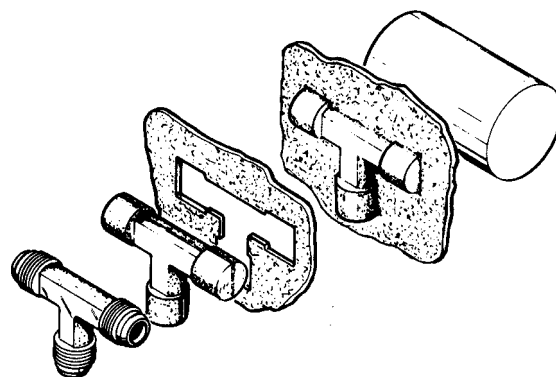

Tube Line Fabrication Guide for Leak Free Systems

Every hydraulic, pneumatic and lubrication system requires some form of tube line fabrication and fitting installation for completion. Proper fabrication and installation are essential for the overall efficiency, leak free performance, and general appearance of any system.

Start by planning ahead. After sizing the tube lines and selecting the appropriate style of fitting, consider the following in the design of your system:

1. Accessibility of joints
2. Proper routing of lines
3. Adequate tube line supports
4. Available fabricating tools

Routing of Lines

Routing of lines is probably the most difficult yet most significant of these system design considerations. Proper routing involves getting a connecting line from one point to another through the most logical path.

Always try to leave fitting joints as accessible as possible. Hard to reach joints are hard to assemble and tighten properly. Inaccessible joints are also more difficult and time consuming to service.

The most logical path should have the following characteristics:

- **Avoid excessive strain on joint** — A strained joint will eventually leak. (See Figures A14 through A21.)
- **Allow for expansion and contraction** — Use a “U” bend or a hose in long lines to allow for expansion and contraction. (See Figure A22.)
- **Allow for motion under load** — Even some apparently rigid systems do move under load. (See Figure A23.)
- **Get around obstructions without using excessive amount of 90° bends** — Pressure drop due to one 90° bend is greater than that due to two 45° bends. (See Figures A24 and A25.)
- Keep tube lines away from components that require regular maintenance. (See Figures A26 and A27.)
- Have a neat appearance and allow for easy troubleshooting, maintenance and repair. (See Figures A28 and A29.)

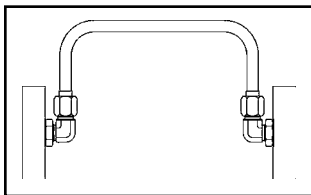

Fig. A14 — Correct Routing

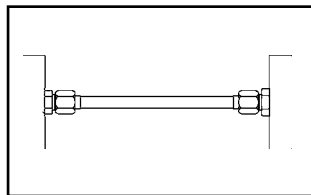

Fig. A15 — Incorrect Routing

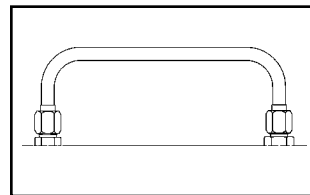

Fig. A18 — Correct Routing

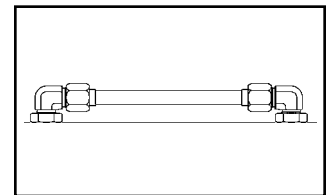

Fig. A19 — Incorrect Routing

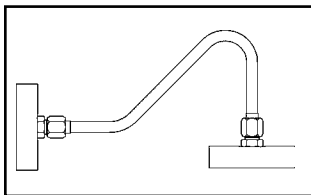

Fig. A16 — Correct Routing

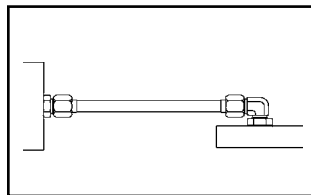

Fig. A17 — Incorrect Routing

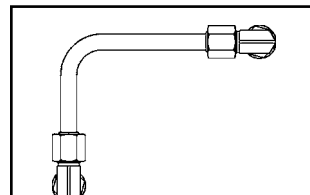

Fig. A20 — Correct Routing

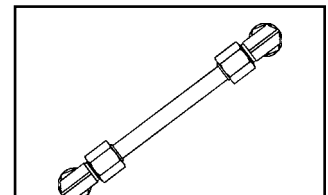

Fig. A21 — Incorrect Routing

(continued next page)

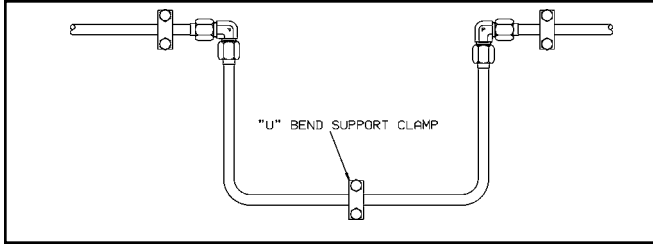

Fig. A22 — U-Bend Allowing Expansion and Contraction

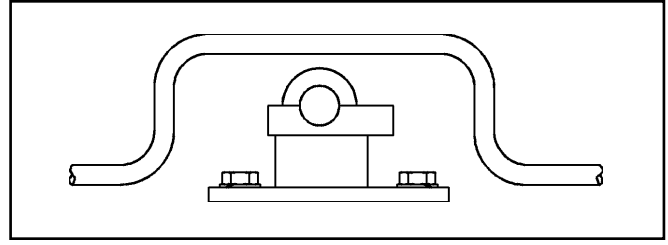

Fig. A25 — Incorrect

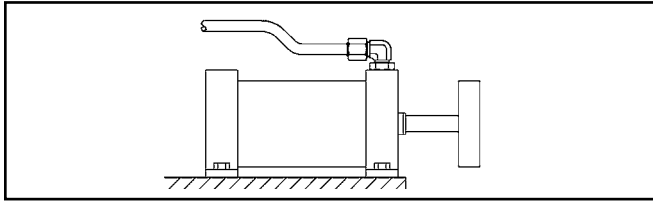

Fig. A23 — Bent Tube Allowing for Motion Under Load

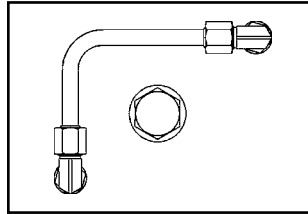

Fig. A26 — Correct

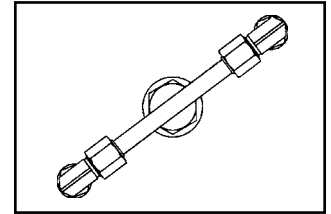

Fig. A27 — Incorrect

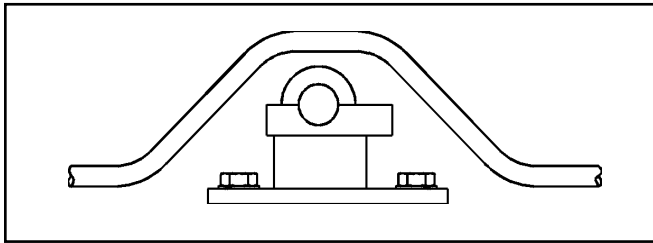

Fig. 24 — Correct

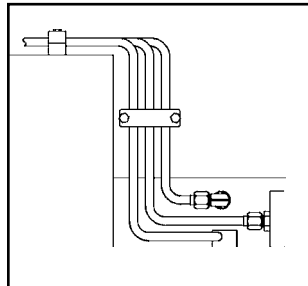

Fig. A28 — Correct

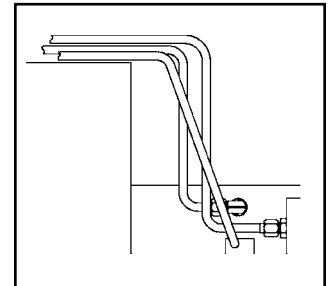

Fig. A29 — Incorrect

Thread Specifications

Dryseal Pipe Threads

All dryseal pipe threads are manufactured in accordance with the American National Standards Institute (ANSI) B1.20.3 specification and designed to seal pressure tight joints. The threads may incorporate the NPTF (National Standard Pipe Taper Fuel and Oil), PTF-SAE Short, PTF-SPL Short or PTF-SPL Extra Short form. Dryseal threads are used on brass products found within this catalog. Use of a thread sealant is recommended.

Non-Dryseal Pipe Threads

All non-dryseal pipe threads are manufactured in accordance with the American National Standards Institute (ANSI) B1.20.1 specification. These tapered pipe threads are used on our carbon and stainless steel products. Use of a thread sealant is recommended.

Nickel Plating

Nickel Plating is optional on standard product. Specifications for plating are not considered when standard product is manufactured. Since plating will alter thread pitch diameters, all plated threads should be qualified by functional fit with mating parts and not by standard thread gauging. Consult factory on plated product that will be qualified by standard thread gauging. These should be ordered as non-standards so product can be machined to pre-plated specifications.

Nickel plating provides a corrosion resistant coating which is desirable in many applications. Electrolytic nickel plating is the standard plating supplied unless otherwise specified. This will provide a uniform coverage of external surfaces; however, internal surfaces may be uncoated.

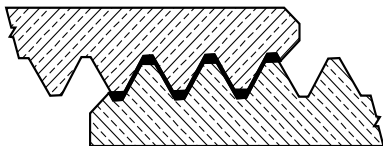

Dryseal Pipe Thread

Metal to metal contact. Crests of thread are crushed by the roots when wrench-tightened to form seal.

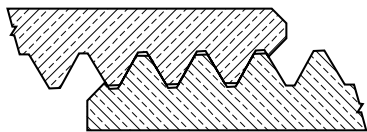

Non-Dryseal Pipe Thread

Flanks are in contact with possible clearance between the roots and crests. Will not prevent spiral leakage

Unified Threads

All threads in the columns headed "Straight Thread" found within this catalog are manufactured in accordance with the American National Standards Institute (ANSI) B1.1 specification.

British Standard Pipe Threads BSPT and BSPP

Pressure Tight

The British pipe threaded products found within this catalog intended for use where pressure tight joints are made on the threads are manufactured in accordance with British Standard (BS) 21 and International Standards Organization (ISO) 7-1. The threads are designated as follows:

- Rp: Internal parallel
- Rc: Internal taper
- Rs: Special external parallel
- R: External taper

Use of a thread sealant is recommended with the R series thread. An elastomeric peripheral seal should be used with the Rs thread.

Non-Pressure Tight

All British Standard parallel pipe threads manufactured in this catalog according to BS2779 and ISO 228-1 are intended for use where pressure tight joints are not made on the threads. An elastomeric peripheral seal should be used. These threads are designated as follows:

- G: Internal Thread
- GA, External thread, tight tolerance classification
- GB, External thread, general purpose and assumed if no classification designation is given

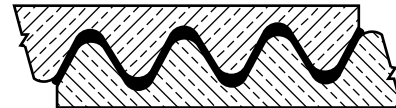

BS21 British Standard Pipe Thread for Pressure Tight Joints

Metal to metal contact provides seal as tapered thread is wrench-tightened.

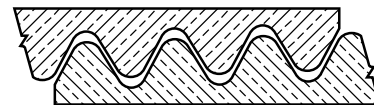

BS2779 British Standard Pipe Thread for Non-Pressure Tight Joints

Thread tolerances allow for possible clearance between threads. Will not prevent leakage paths.

Pipe Thread Assembly

The two British Standard pipe thread forms used for Parker's standard product are manufactured in a tighter tolerance range than required by the standards in order to facilitate the assembly and mating of fittings produced by the two different standards. In general, BS21 threads do not necessarily mate with BS2779 threads at tolerance overlap conditions, but fittings located within this catalog can be assembled as follows:

External Thread	Mating Internal Thread
G-BS2779 (parallel)	G-BS2779 (parallel) Rp-BS21* (parallel)
Rs-BS21 (parallel)	Rp-BS21 (parallel) G-BS2779 (parallel)
R-BS21 (taper)	Rp-BS21 (parallel) Rc-BS21 (taper) G-BS2779 (parallel)

*This thread must be manufactured within a reduced tolerance range to always assemble with the G series external thread.

British Standard ISO Metric Screw Threads

They are commonly used in miniature pneumatic applications because of the availability of small thread diameters and are also used extensively in the automotive industry. There are two forms of sealing on metric screw threads.

- O-ring sealing into a profiled port in accordance with ISO 6149.
- Peripheral sealing with a copper or bonded washer in accordance with ISO 261 and 262.

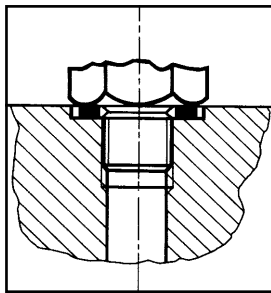

Peripheral sealing of parallel threads

Pressure-tight joints of screwed connections with parallel threads are achieved by placing a seal between the two machined faces

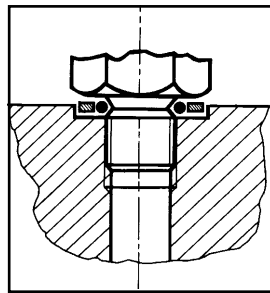

Flat seals

Washers and rings are manufactured in many different materials including copper, aluminium, fiber, plastics, etc.

The tightening torque at assembly must be carefully selected so as to avoid compressing the seal to the point of extrusion. As a general rule, the fitting should be tightened with an additional 1/4 wrench turn from the fingertight position.

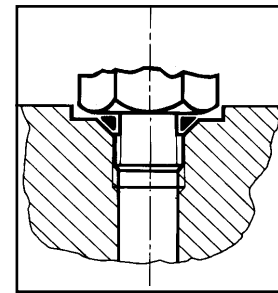

O-rings

Depending upon the configuration of the female port or male thread, O-Ring seals are fitted with or without back-up washers, and can be fully retained in a captive seal.

Flaring Instructions

In order to properly flare copping tubing for use with Parker 45° Flared Fittings and Inverted Flared Fittings, the following procedures and specifications should be met in preparation and make-up of flares.

1. Cut tube with tube cutter:

To minimize the burr and workhardening, use a light feed on the cutting wheel and make several revolutions.

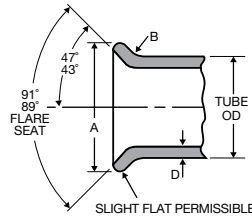

2. Ream the tubing:

Cutting with a tube cutter will always create a burr. The burr must be removed to obtain maximum sealing surface. Remove only the burr, do not remove material from the original wall thickness. Also clean the tube end thoroughly to remove burrs.

3. Flare tubing: Flare with a compression or generating type flaring tool. Follow tool manufacturer's instructions for: (a) positioning the tube in tool and (b) for the correct number of turns on the feed handle.

4. Inspect tubing: The flare cone should be checked for a smooth surface on the i.D. Of the cone and measure with micrometer over largest o.D. For proper size. (See dimensions below for flare size for each tubing size.)

NOMINAL TUBE	A SINGLE FLARE DIAMETER		B SINGLE FLARE RADIUS	D SINGLE FLARE WALL THICKNESS
	MAX. IN	MIN. IN	+/- 0.01 IN	MAX. IN
1/8	.181	.171	.02	.035
3/16	.249	.239	.02	.035
1/4	.325	.315	.02	.049
5/16	.404	.388	.02	.049
3/8	.487	.471	.02	.065
7/16	.561	.545	.02	.065
1/2	.623	.607	.02	.083
9/16	.676	.660	.02	.083
5/8	.748	.732	.02	.095
3/4	.916	.900	.02	.109
7/8	1.041	1.025	.02	.109
1	1.157	1.141	.02	.120

Thread Designations and Standards for Threads Used in Fluid Connectors

	ABBREVIATION	DESCRIPTION	APPLICABLE STD.
STRAIGHT PIPE	NPSC	AMERICAN STANDARD STRAIGHT PIPE THREADS IN PIPE COUPLINGS	ANSI B1.20.1 FED-STD-H28/7
	NPSF	DRYSEAL AMERICAN STANDARD FUEL INTERNAL STRAIGHT PIPE THREADS (GENERALLY SED IN SOFT OR DUCTILE MATERIALS TO MATE WITH NPTF EXTERNAL TAPER THREADS)	SAE J476 ANSI B1.20.3 FED-STD-H28/8
	NPSI	DRYSEAL AMERICAN INTERMEDIATE INTERNAL STRAIGHT PIPE THREADS (FOR BRITTLE OR HARD MATERIALS; INTENDED TO MATE WITH PTF-SAE SHORT EXTERNAL TAPER THREADS)	SAE J476 ANSI B1.20.3 FED-STD-H28/8
	NPSM	AMERICAN STANDARD STRAIGHT PIPE THREADS FOR FREE-FITTING MECHANICAL JOINTS FOR FIXTURES (THESE THREADS FIT FREELY OVER NPTF THREADS. THEY ARE USED IN SWIVEL NUTS OF 07 ADAPTERS)	ANSI B1.20.1 FED-STD-H28/7
TAPER PIPE	ANPT	AERONAUTICAL NATIONAL TAPER PIPE THREADS (SIMILAR TO NPT WITH VARIOUS ADDITIONAL REQUIREMENTS IN GAGING)	MIL-P-7105
	NPT	AMERICAN STANDARD TAPER PIPE THREADS FOR GENERAL USE	ANSI B1.20.1 FED-STD-H28/7
	NPTF	DRYSEAL AMERICAN STANDARD TAPER PIPE THREADS (USED IN ALL OF OUR STEEL AND BRASS FITTINGS)	SAE J476 ANSI B1.20.3 FED-STD-H28/8
	PTF - SAE SHORT	DRYSEAL SAE SHORT TAPER PIPE THREADS (MAINLY USED IN LOW PRESSURE PNEUMATIC AND FUEL APPLICATIONS)	SAE J476 ANSI B1.20.3 FED-STD-H28/8
	PTF - SPL SHORT ¹	DRYSEAL SPECIAL SHORT TAPER PIPE THREADS	ANSI B1.20.3
	PTF - SPL EXTRA SHORT ¹	DRYSEAL SPECIAL EXTRA SHORT TAPER PIPE THREADS	ANSI B1.20.3

Continued next page

	ABBREVIATION	DESCRIPTION	APPLICABLE STD.
UNIFIED THREADS	UN	UNIFIED CONSTANT PITCH THREADS (STANDARD SERIES: 4, 6, 8, 12, 16, 20, 28, 32)	ANSI B1.1 ED-STD-H28/2
	UNC	UNIFIED COARSE THREADS	ANSI B1.1 FED-STD-H28/2
	UNEF	UNIFIED EXTRA FINE THREADS	ANSI B1.1 FED-STD-H28/2
	UNF	UNIFIED FINE THREADS	ANSI B1.1 FED-STD-H28/2
	UNS	UNIFIED SPECIAL PITCH THREADS	ANSI B1.1 FED-STD-H28/3
	UNJ	UNIFIED CONTROLLED ROOT RADIUS THREADS	ANSI B1.15 FED-STD-H28/4
METRIC THREADS	M	METRIC SCREW THREADS — M PROFILE	ISO 261 ANSI B1.13M FED-STD-H28/21
	M — KEG	METRIC TAPER THREADS (MAINLY USED IN GERMANY)	DIN 158
BRITISH STANDARD	R (BSPT)	BRITISH STANDARD TAPER PIPE THREADS, EXTERNAL	BS 21 ISO 7/1
	RC (BSPT)	BRITISH STANDARD TAPER PIPE THREADS, INTERNAL	BS 21 ISO 7/1
	RP OR G (BSPP)	BRITISH STANDARD PIPE (PARALLEL) THREADS	BS 2779 ISO 228/1
JAPANESE STANDARD	PF ²	JIS PARALLEL PIPE THREADS	JIS B202 ISO 228/1
	PT ²	JIS TAPER PIPE THREADS	JIS B203 ISO 7/1
	PS	JIS PARALLEL INTERNAL PIPE THREADS (TO MATE WITH PT THREADS)	JIS B203

Table A48 — Thread Designations and Standards for Threads Used in Fluid Connectors

- Used in some pneumatic components where shortened thread depth is required because of lack of enough material due to component size limitations.
- PF and PT threads are functionally interchangeable with BSPP and BSPT threads, respectively.
These are old designations. They are being replaced with G (for PF) and R and Rc (for PT) as documents are revised.

Straight Thread Size Comparison Chart

	TUBE O.D.										
	1/8	3/16	1/4	5/16	3/8	7/16	1/2	5/8	3/4	7/8	1
SAE 45° FLARED	5/16 -24	3/8 -24	7/16 -20	1/2 -20	5/8 -18	11/16 -16	3/4 -16	7/8 -14	1-1/16 -14	1-1/4 -12	-
INVERTED FLARED	5/16 -28	3/8 -24	7/16 -24	1/2 -20	5/8 -18	11/16 -18	3/4 -18	7/8 -18	1-1/16 -16	1-3/16 -16	-
AIR BRAKE/NTA	-	-	7/16 -24	-	17/32 -24	-	11/16 -20	13/16 -18	1 -18	-	1-1/4 -16
STANDARD, COMPRESSION / COMPRESS-ALIGN	5/16 -24	3/8 -24	7/16 -24	1/2 -24	9/16 -24	5/8 -24	11/16 -20	13/16 -18	1 -18	1-1/8 -18	1-1/4 -18
POLY-TITE			3/8 -24	7/16 -24	1/2 -24	-	11/16 -20	-	-	-	-
VIBRA-LOK	3/8 -24	-	1/2 -24	9/16 -24	5/8 -24	-	13/16 -18	1 -18	1-1/8 -18	-	-
V510 BALL VALVES	-	-	7/16 -20	-	9/16 -18	-	3/4 -16	7/8 -14	1-1/16 -12	-	1-5/16 -12
HI-DUTY FLARELESS TUBE FITTINGS	5/16 -24	3/8 -24	7/16 -20	1/2 -20	9/16 -20	-	11/16 -16	7/8 -18	-	-	-

S.A.E. Part Index

<u>PART NO.</u>	<u>PAGE</u>	<u>PART NO.</u>	<u>PAGE</u>	<u>PART NO.</u>	<u>PAGE</u>	<u>PART NO.</u>	<u>PAGE</u>
SAE 010101	H8	SAE 010202.....	H10	SAE 060102 BA.....	G9	SAE 100203 BA.....	F9
SAE 010102.....	H9	SAE 010203.....	H11	SAE 060103 BA.....	G9	SAE 100302 BA.....	F9
SAE 010103.....	H9	SAE 010302	H11	SAE 060110.....	G8	SAE 100401 BA.....	F8
SAE 010104.....	H8	SAE 010401.....	H10	SAE 060111	G8	SAE 100424 BA.....	F9
SAE 010105.....	H12	SAE 010424.....	H11	SAE 060115.....	G8	SAE 100425 BA.....	F9
SAE 010106.....	H12	SAE 010425.....	H10	SAE 060201 BA.....	G10	SAE 120101 BA	F13
SAE 010107.....	H12	SAE 040101.....	H14	SAE 060202 BA	G10	SAE 120102 BA.....	F13
SAE 010108.....	H7	SAE 040102	H14	SAE 060203 BA	G11	SAE 120103 BA.....	F13
SAE 010109.....	H12	SAE 040103	H14	SAE 060401 BA	G10	SAE 120111	F13
SAE 010110	H8	SAE 040110.....	H14	SAE 060424 BA.....	G11	SAE 120115	F13
SAE 010111	H8	SAE 040202	H15	SAE 060425 BA	G11	SAE 120201 BA.....	F13
SAE 010112	H12	SAE 040203	H15	SAE 100101 BA	F7	SAE 120202 BA.....	F14
SAE 010113	H7	SAE 040302	H15	SAE 100102 BA	F8	SAE 120203 BA.....	F14
SAE 010114	H7	SAE 040401	H14	SAE 100103 BA.....	F8	SAE 120302 BA.....	F14
SAE 010165.....	H7	SAE 040424	H15	SAE 100110	F7	SAE 120401 BA.....	F13
SAE 010166.....	H7	SAE 040425	H15	SAE 100115	F7	SAE 120424 BA.....	F14
SAE 010167.....	H7	SAE 040427	H15	SAE 100201 BA.....	F8	SAE 120425 BA.....	F14
SAE 010201.....	H11	SAE 060101 BA.....	G8	SAE 100202 BA.....	F9		

SAE Standards

(Current)

- J246:** Spherical and Flanged Sleeve (Compression) Tube Fittings
Tubing: Copper and J844 Nylon
Fittings: NTA and Air Brake
- J476:** Dryseal Pipe Threads
- J512:** Automotive Tube Fittings
Tubing: Copper and Nylon
Fittings: 45° Flare, Inverted Flare, Compression
- J513:** Refrigeration Tube Fittings
Tubing: Annealed Copper
Fittings: 45° Flare
- J530:** Automotive Pipe Fittings
Fittings: Pipe
- J531:** Automotive Pipe, Filler and Drain Plugs
Fittings: Pipe Plugs
- J844:** Nonmetallic Air Brake System Tubing
Tubing: Non-reinforced Type A, reinforced Type B
- J1131:** Performance Requirements for SAE J844 Nonmetallic Tubing and Fitting Assemblies Used in Automotive Air Brake Systems
Tubing: J844 Nylon
Fittings: NTA and Prestomatic
- J1615:** Thread Sealants
- J2494:** Brass Body Push-to-Connect Fittings
Tubing: J844 Nylon
Fittings: Prestomatic

U.L. Listed Fittings

Many of the Fluid System Connectors Division's fittings have been listed by the Underwriter's Laboratory. The listings fall under 1 of 3 categories, depending upon application. Underwriter's requires that the smallest unit package carry the U.L. symbol and each carton be printed in accordance with the specification of each category.

List of U.L. Fittings

FITTINGS, FLAMMABLE LIQUID

1F	62C	168CA	252IFHD
2GF	62CA	169C	256IF
3GF	62CABH	169CA	259IFHD
14FL	62CBH	170C	264C
14FSV	66C	170CA	264CA
14FSX	66CA	171C	265C
41FL	68C	171CA	265CA
41FS	68CA	172C	269C
41FX	144F	172CA	269CA
41IF	145F	176C	270C
41IFS	147F	176CA	270CA
42F	149F	177C	639C
42IFHD	150F	177CA	639CA
46F	151F	244F	639F
46IFHD	155F	244IFHD	640F
48F	159F	245IFHD	660FHD
48IFHD	164C	249F	661FHD
60C	164CA	249IF	664FHD
61C	165C	249IFHD	
61CA	165CA	250IFHD	
61CL	168C	251IFHD	

FITTINGS, FUEL EQUIPMENT, MARINE

2GF	144F	155F	664FHD
3GF	145F	159F	
14FL	147F	639F	
42F	149F	640F	
46F	150F	660FHD	
48F	151F	661FHD	

SHUT-OFF VALVES, FLAMMABLE LIQUIDS, LP GAS AND COMPRESS GAS

XV520P-4	XV520P-20	XV500P-20
XV520P-6	XV520P-24	XV500P-24
XV520P-8	XV520P-32	XV500P-32
XV520P-12	XV520P-40	
XV520P-16	XV520P-48	

Flow Curves

87 PSI (5.9 bar) ■ Return Direction ■ Controlled Direction N = Number of Turns F = Flow in SCFM

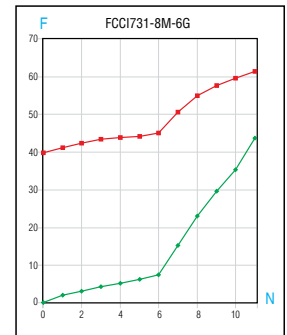
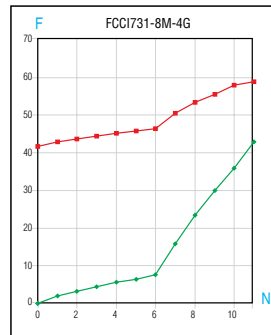
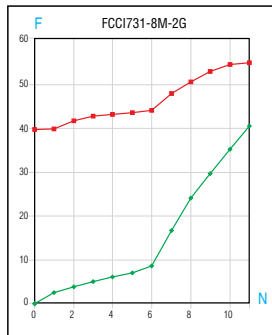
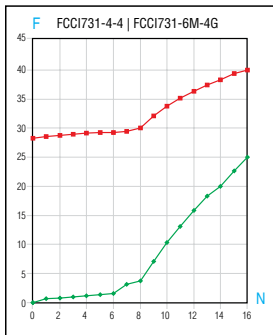
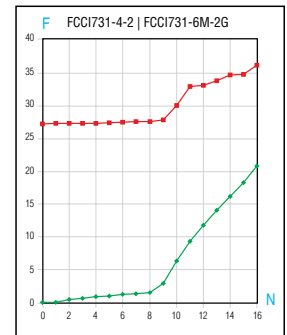
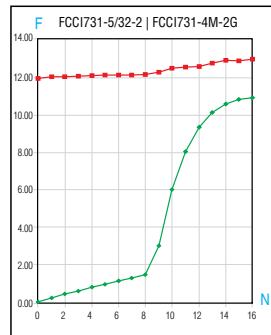
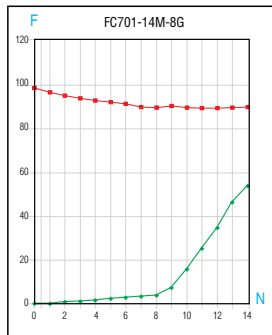
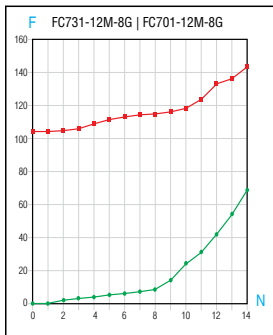
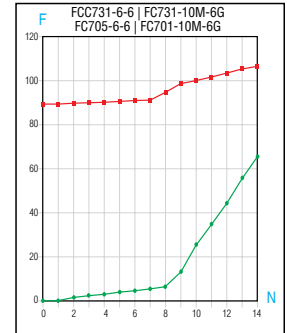
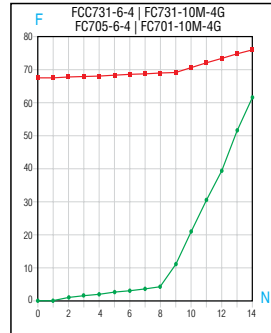
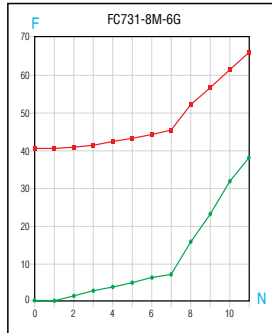
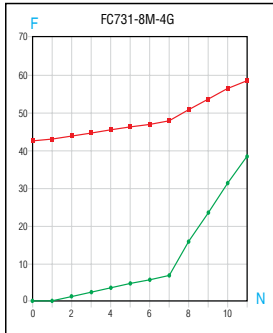
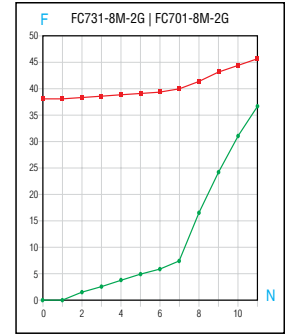
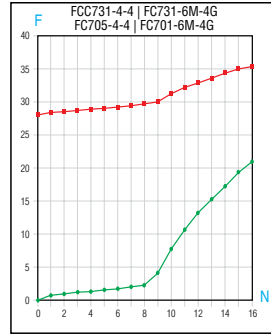
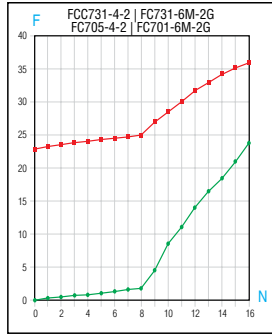
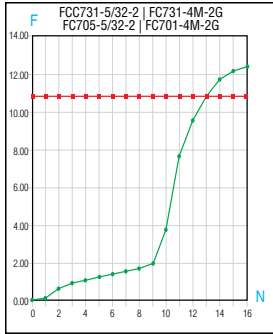

87 PSI (5.9 bar) ■ Return Direction ■ Controlled Direction N = Number of Turns F = Flow in SCFM

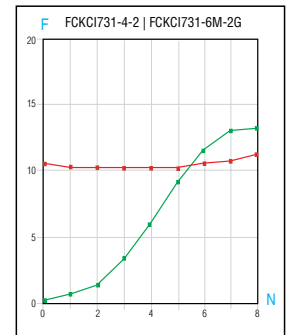
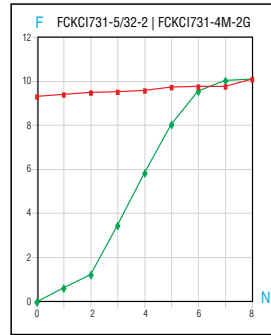
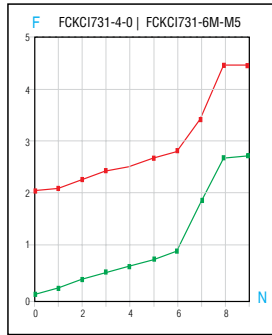
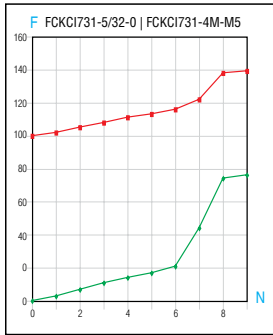
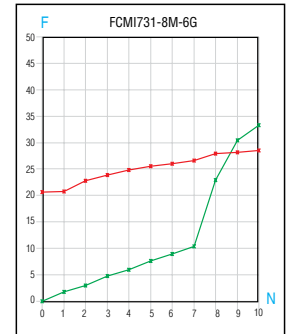
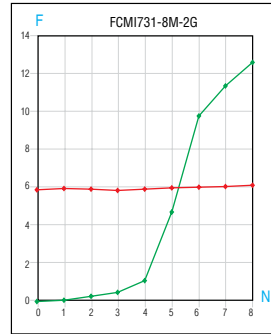
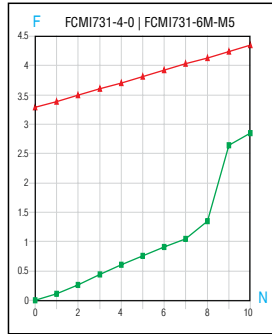
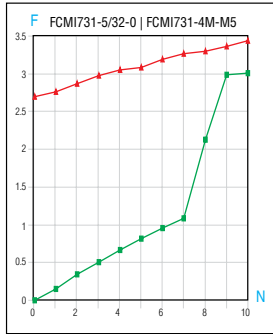
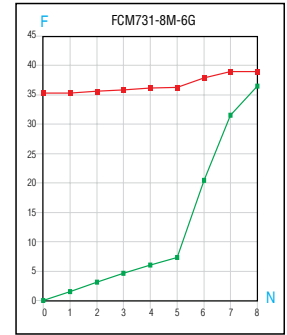
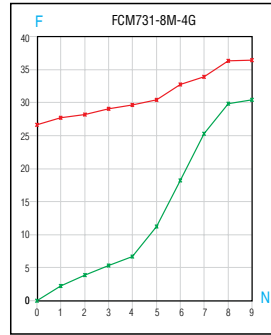
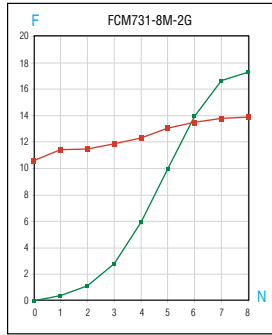
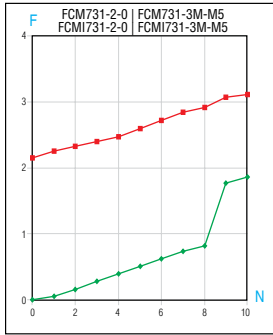
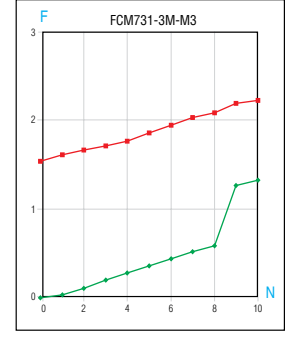
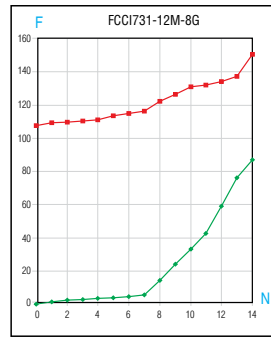
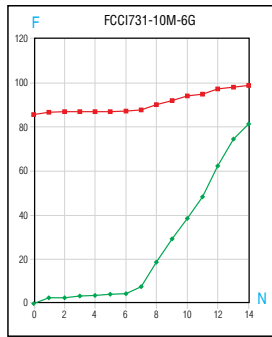
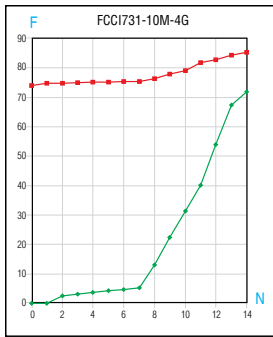

87 PSI (5.9 bar) ■ Return Direction ■ Controlled Direction **N** = Number of Turns **F** = Flow in SCFM

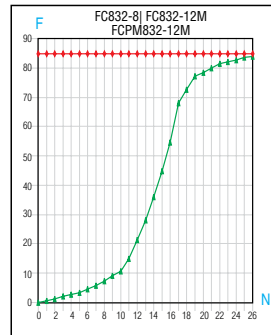
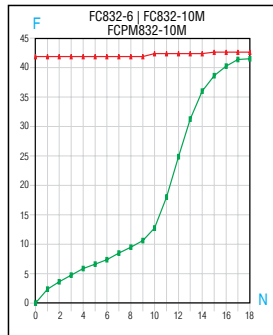
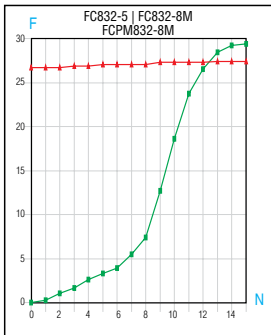
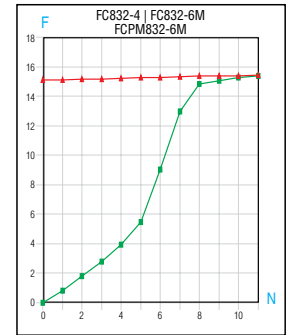
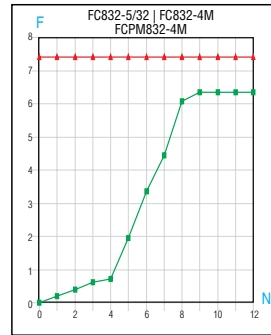
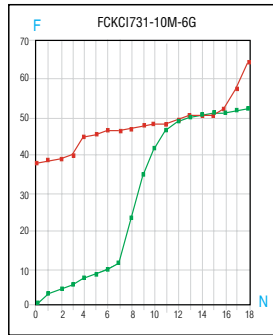
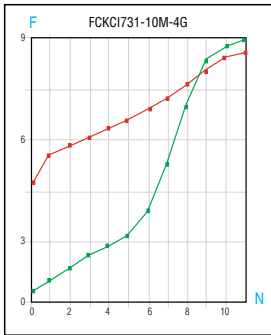
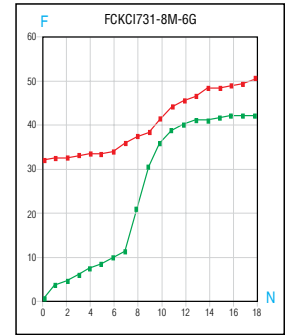
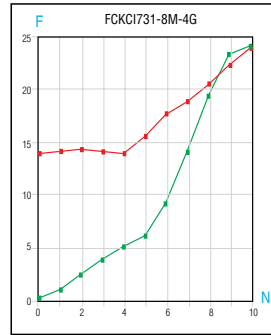
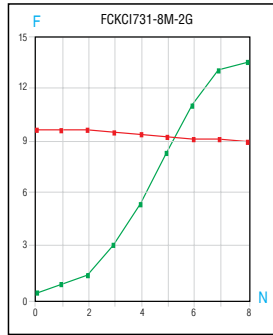
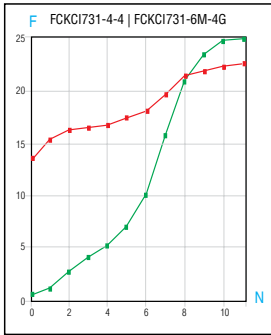

87 PSI (5.9 bar) ■ Return Direction ■ Controlled Direction N = Number of Turns F = Flow in SCFM

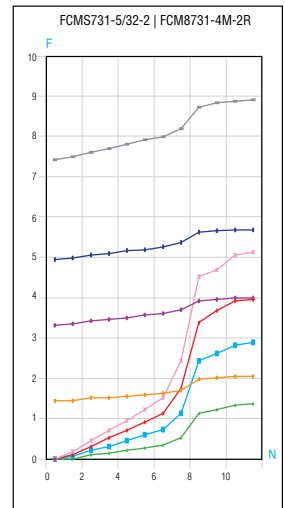
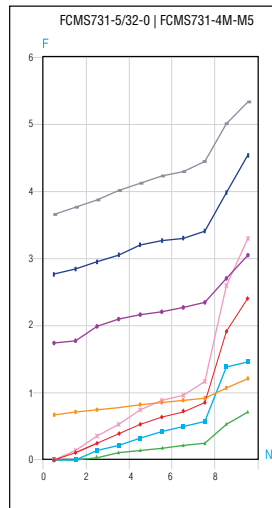
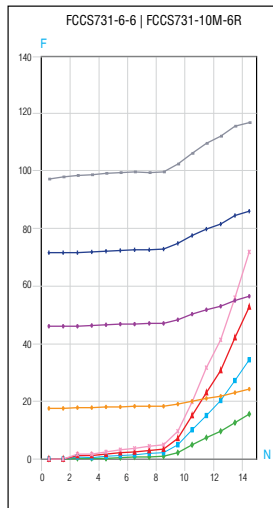
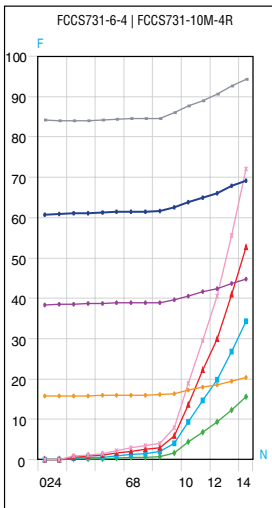
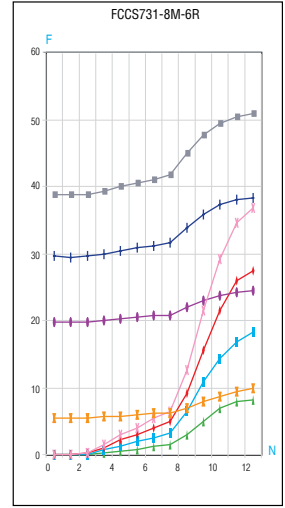
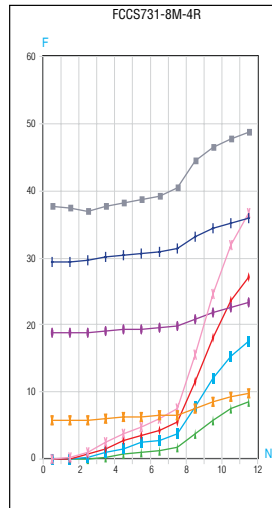
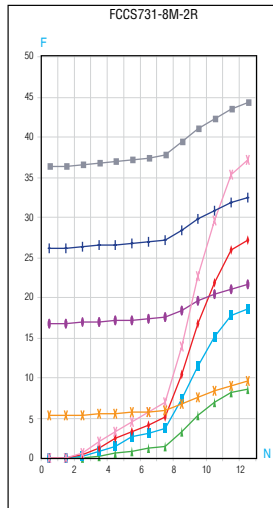
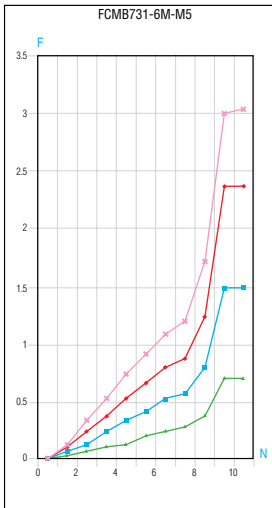
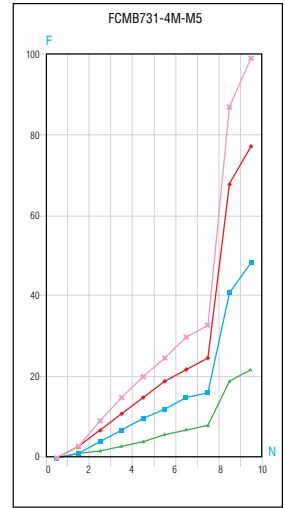
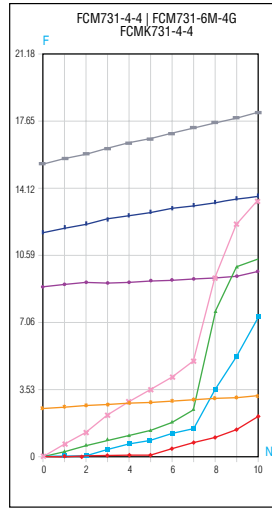
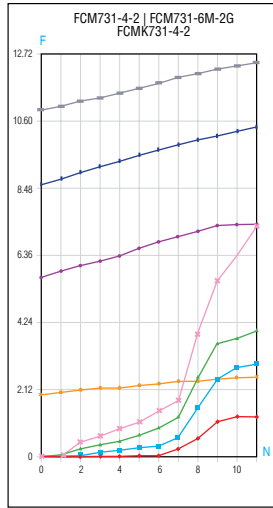
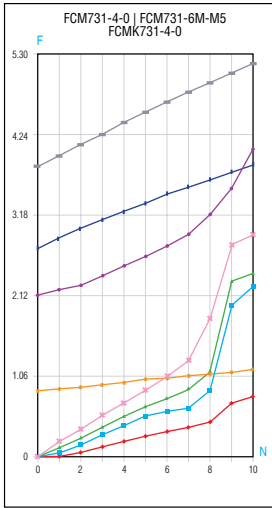

— Controlled Direction – 14.5 PSI (0.9 bar) — Controlled Direction – 43.5 PSI (2.9 bar)
— Controlled Direction – 72.5 PSI (4.9 bar) — Controlled Direction – 101.5 PSI (6.9 bar)
— Return Direction – 14.5 PSI (0.9 bar) — Return Direction – 43.5 PSI (2.9 bar)
— Return Direction – 72.5 PSI (4.9 bar) — Return Direction – 101.5 PSI (6.9 bar)

87 PSI (5.9 bar) ■ Return Direction ■ Controlled Direction N = Number of Turns F = Flow in SCFM

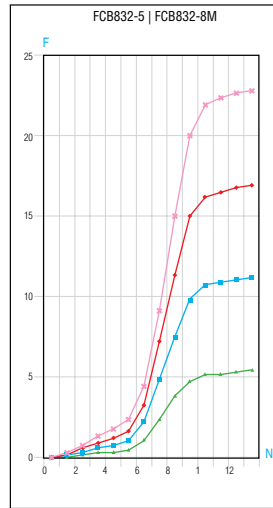
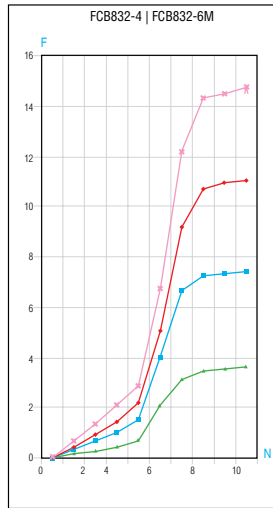
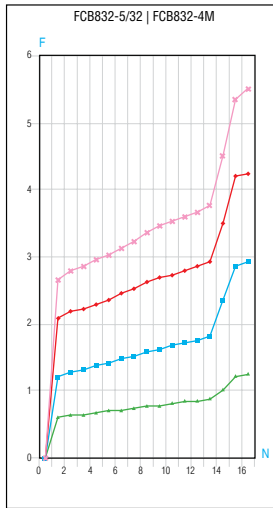
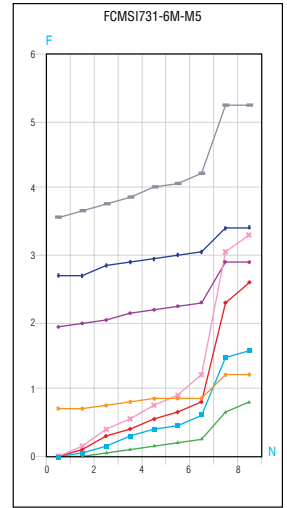
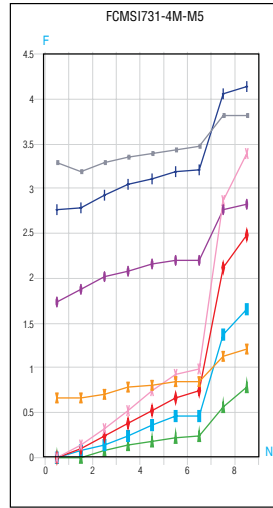
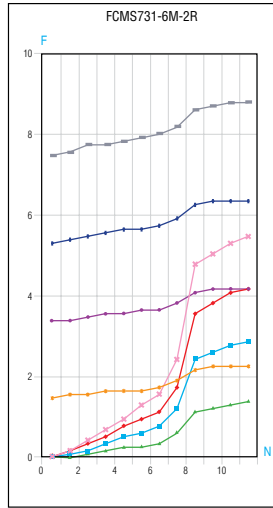
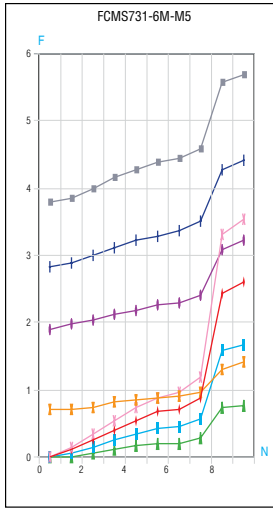

- Controlled Direction – 14.5 PSI (0.9 bar)
- Controlled Direction – 43.5 PSI (2.9 bar)
- Controlled Direction – 72.5 PSI (4.9 bar)
- Controlled Direction – 101.5 PSI (6.9 bar)
- Return Direction – 14.5 PSI (0.9 bar)
- Return Direction – 43.5 PSI (2.9 bar)
- Return Direction – 72.5 PSI (4.9 bar)
- Return Direction – 101.5 PSI (6.9 bar)

Flare and Thread Profiles

SAE (JIC) 37° Flare Nose Sizes

Actual Size

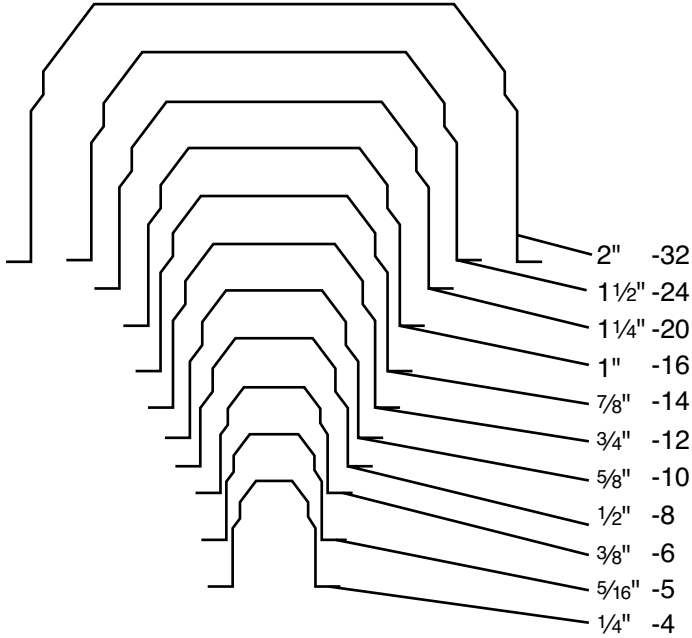

SAE 45° Flare Nose Sizes

Actual Size

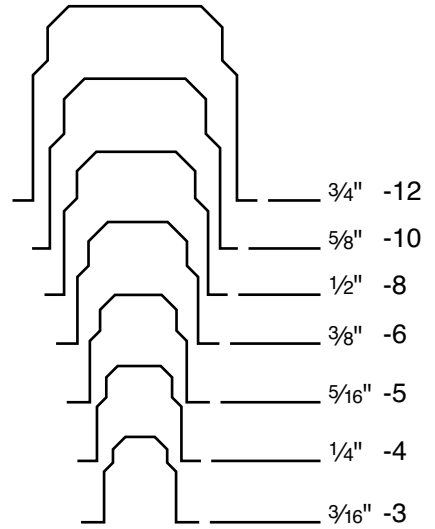

Male Pipe Thread Sizes

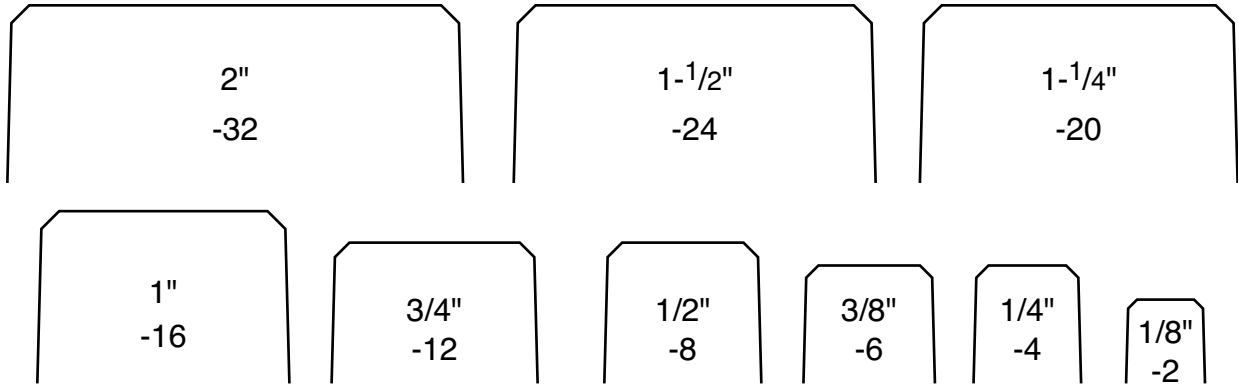

Actual Outside Diameters of Tubing

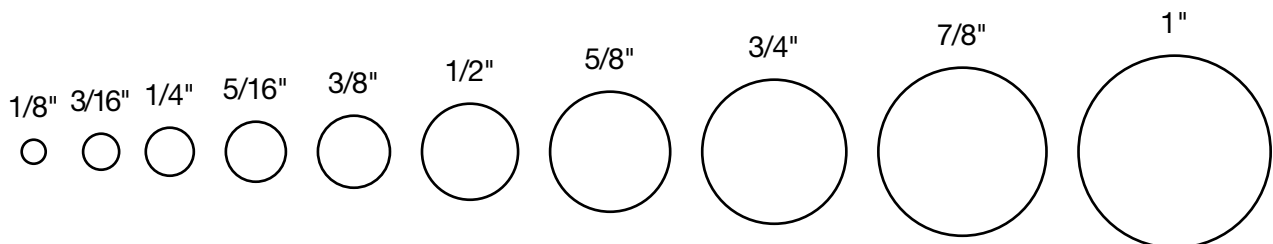

Pressure Conversions

KILOPASCALS (KPA)	MEGAPASCALS (MPA)	BAR (bar)	KILOGRAMS PER SQUARE CENTIMETER (KGF/CM2)	POUNDS PER SQUARE INCH (PSI)
100	1.0	1	1.02	14.50
200	.2	2	2.04	29.00
300	.3	3	3.06	43.50
400	.4	4	4.08	58.00
500	.5	5	5.10	72.50
600	.6	6	6.12	87.00
700	.7	7	7.14	101.50
800	.8	8	8.16	116.00
900	.9	9	9.18	130.50
1000	1.0	10	10.20	145.00
2000	2.0	20	20.40	290.10
3000	3.0	30	30.60	435.10
4000	4.0	40	40.80	580.20
5000	5.0	50	51.00	725.20
6000	6.0	60	61.20	870.20
7000	7.0	70	71.40	1015.30
8000	8.0	80	81.60	1160.30
9000	9.0	90	91.80	1305.30
10000	10.0	100	102.00	1450.00
20000	20.0	200	204.00	2901.00
30000	30.0	300	306.00	4351.00
40000	40.0	400	408.00	5802.00
50000	50.0	500	510.00	7252.00
60000	60.0	600	612.00	8702.00
70000	70.0	700	714.00	10153.00
80000	80.0	800	816.00	11603.00
90000	90.0	900	918.00	13053.00
100000	100.0	1000	1020.00	14504.00
200000	100.0	2000	2040.00	29008.00
300000	300.0	3000	3060.00	43511.00

POUNDS PER SQUARE INCH (PSI)	KILOPASCALS (KPA)	MEGAPASCALS (MPA)	BAR (bar)	KILOGRAMS PER SQUARE CENTIMETER (KGF/CM2)
10	68.90	.07	.70	.70
20	137.90	.14	1.41	1.41
30	206.80	.21	2.10	2.11
40	275.80	.28	2.80	2.81
50	344.70	.34	3.40	3.52
60	413.70	.41	4.10	4.22
70	482.60	.48	4.80	4.92
80	551.60	.55	5.50	5.63
90	620.50	.62	6.20	6.33
100	689.00	.70	6.90	7.00
200	1379.00	1.40	13.80	14.10
300	2068.00	2.10	20.70	21.10
400	2758.00	2.80	27.60	28.10
500	3447.00	3.40	34.50	35.20
600	4137.00	4.10	41.40	42.20
700	4826.00	4.80	48.30	49.20
800	5516.00	5.50	55.20	56.30
900	6205.00	6.20	62.10	63.30
1000	6895.00	6.90	68.90	70.30
2000	13790.00	13.80	137.90	140.70
3000	20684.00	20.70	206.80	211.00
4000	27579.00	27.60	275.80	281.30
5000	34474.00	34.50	344.70	351.60
6000	41369.00	41.40	413.70	421.90
7000	48263.00	48.30	482.60	492.30
8000	55158.00	55.20	551.60	562.60
9000	62053.00	62.10	620.50	632.90
10000	68948.00	68.90	689.00	703.00
20000	137895.00	137.90	1379.00	1406.00
30000	206843.00	206.80	2068.00	2110.00
40000	275790.00	275.80	2758.00	2813.00

Tube Insertion Depths

This engineering standard covers the tube insertion depths and minimum depths to pass thru the o-ring. The depths are used for conveying information to customers and are meant to be used only as a guideline.

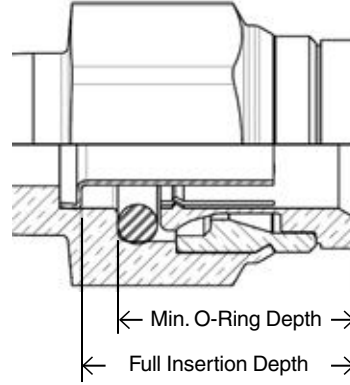
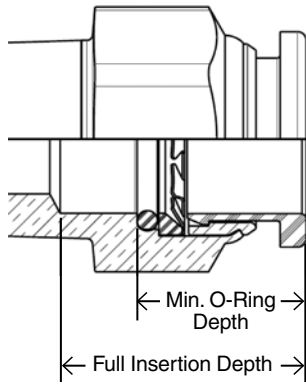

Brass Prestolok Plus (PLP Metal)

TUBE SIZE	FULL INSERTION DEPTH (IN.)	MINIMUM O-RING DEPTH (IN.)
1/8"	.64	.48
5/32"	.64	.48
3/16"	.67	.48
1/4"	.67	.49
5/16"	.77	.51
3/8"	.78	.51
1/2"	.85	.58

LF3000 (PLP Composite) & LIQUIfit

TUBE SIZE	FULL INSERTION DEPTH (IN.)	MINIMUM O-RING DEPTH (IN.)
1/8"	.46	.38
3/16"	.65	.56
1/4"	.58	.44
3/8"	.81	.62
1/2"	1.09	.84
4MM	.51	.39
6MM	.58	.45
8MM	.73	.55
10MM	.81	.62
12MM	.97	.73
14MM	1.08	.83
16MM	1.15	.89

LF3600 (PLM) & LF3800 (PLS)

TUBE SIZE	FULL INSERTION DEPTH (IN.)	MINIMUM O-RING DEPTH (IN.)
1/4"	.66	.55
3/8"	.88	.73
1/2"	.89	.74
4MM	.57	.49
6MM	.68	.57
8MM	.71	.62
10MM	.90	.75
12MM	.96	.78
14MM	1.00	.82

Carstick

TUBE SIZE	FULL INSERTION DEPTH (IN.)	MINIMUM O-RING DEPTH (IN.)
1/8"	.46	.38
1/4"	.75	.55
3/8"	.86	.68
1/2"	1.16	.92
4MM	.49	.41
6MM	.58	.49
8MM	.71	.60
10MM	.85	.67
12MM	1.00	.79

Composite PTC

TUBE SIZE	FULL INSERTION DEPTH (IN.)	MINIMUM O-RING DEPTH (IN.)
1/4"	.58	.47
3/8"	.70	.53
1/2"	.80	.61
5/8"	.99	.72
3/4"	1.04	.83

Metric Prestomatic

TUBE SIZE	FULL INSERTION DEPTH (IN.)	MINIMUM O-RING DEPTH (IN.)
6MM	.78	
8MM	.80	
10MM	.91	
12MM	.91	
16MM	.89	

PMTCE

TUBE SIZE	FULL INSERTION DEPTH (IN.)	MINIMUM O-RING DEPTH (IN.)
1/4"	.65	.54
3/8"	.81	.72
1/2"	.94	.72
5/8"	1.00	.75
3/4"	1.00	.75

LF3800 (PLS)

TUBE SIZE	FULL INSERTION DEPTH (IN.)	MINIMUM O-RING DEPTH (IN.)
1/4"	.69	.58
3/16"	.57	.49
3/8"	.90	.75
1/2"	.93	.78
4MM	.57	.49
6MM	.67	.56
8MM	.74	.65
10MM	.91	.76
12MM	.96	.79

Brass PTC

TUBE SIZE	FULL INSERTION DEPTH (IN.)	MINIMUM O-RING DEPTH (IN.)
5/32"	.64	.44
3/16"	.62	.44
1/4"	.59	.49
3/8"	.78	.56
1/2"	.85	.63
5/8"	1.02	.80
3/4"	1.03	.82

Prestomatic

TUBE SIZE	FULL INSERTION DEPTH (IN.)	MINIMUM O-RING DEPTH (IN.)
1/4"	.63	.54
3/8"	.81	.72
1/2"	.94	.72
5/8"	1.12	.75
3/4"	1.12	.92

TrueSeal – Acetal & Kynar

TUBE SIZE	FULL INSERTION DEPTH (IN.)	MINIMUM O-RING DEPTH (IN.)
1/4"	.71	.52
5/16"	.80	.55
3/8"	.80	.55
1/2"	.90	.63

TrueSeal - PolyPropylene

TUBE SIZE	FULL INSERTION DEPTH (IN.)	MINIMUM O-RING DEPTH (IN.)
1/4"	.74	.55
3/8"	.83	.59
1/2"	.93	.66

English/Metric Conversions

Inches x 25.4 = Millimeters (mm)
 Inches x 2.54 = Centimeters (cm)
 Inches x .254 = Decimeters (dm)
 Feet x .3048 = Meters (m)
 Yards x .9144 = Meters (m)
 PSI x .0689 = Bars (bar)
 Bars x 100 = Kilopascals (kPa)
 PSI x .0069 = Megapascals (MPa)
 Pound Inches x .113 = Newton Meters (N•m)

Pound Feet x 1.356 = Newton Meters (N•m)
 Millimeters x .0394 = Inches
 Centimeters x .3937 = Inches
 Meters x 3.281 = Feet
 Meters x 1.0936 = Yards
 Bars x 14.5 = PSI Megapascals x 145 = PSI
 Newton Meters x 8.85 = Pound Inches
 Newton Meters x .737 = Pound Feet

Millimeters to Fractions to Decimals

MM	INCHES	
	FRACTION	DECIMAL
.3969	1/64	.0156
.7938	1/32	.0312
1.1906	3/64	.0468
1.5875	1/16	.0625
1.9844	5/64	.0781
2.3812	3/32	.0937
2.7781	7/64	.1093
3.1750	1/8	.1250
3.5719	9/64	.1406
3.9688	5/32	.1562
4.3656	11/64	.1718
4.7625	3/16	.1875
5.1594	13/64	.2031
5.5562	7/32	.2187
5.9531	15/64	.2343
6.3500	1/4	.2500

MM	INCHES	
	FRACTION	DECIMAL
6.7469	17/64	.2656
7.1438	9/32	.2812
7.5406	19/64	.2968
7.9375	5/16	.3125
8.3344	21/64	.3281
8.7312	11/32	.3437
9.1281	23/64	.3593
9.5250	3/8	.3750
9.9219	25/64	.3906
10.3188	13/32	.4062
10.7156	27/64	.4218
11.1125	7/16	.4375
11.5094	29/64	.4531
11.9062	15/32	.4687
12.3031	31/64	.4843
12.7000	1/2	.5000

MM	INCH	
	FRACTION	DECIMAL
13.0969	33/64	.5156
13.4938	17/32	.5312
13.8906	35/61	.5468
14.2875	9/16	.5625
14.6844	37/64	.5781
15.0812	19/32	.5937
14.4781	39/64	.6093
15.8750	5/8	.6250
16.2719	41/64	.6406
16.6688	21/32	.6562
17.0656	43/64	.6718
17.4625	11/16	.6875
17.8594	45/64	.7031
18.2562	23/32	.7187
18.6531	47/64	.7343
19.0500	3/4	.7500

MM	INCH	
	FRACTION	DECIMAL
19.4469	49/64	.7656
19.8438	25/32	.7812
20.2406	51/64	.7968
20.2375	13/16	.8125
21.0344	53/64	.8281
21.4312	27/32	.8437
21.8281	55/64	.8593
22.2250	7/8	.8750
22.6219	57/64	.8906
23.0188	29/32	.9062
23.4156	59/64	.9218
23.8125	15/16	.9375
24.2094	61/64	.9531
24.6062	31/32	.9687
25.0031	63/64	.9843
25.4000	1	1.0000

Assembly Guides

Push-to-Connect Fittings

- Prestolok PLP Metal
- Prestolok PLP Composite
- Prestolok PLM
- Prestolok PLS
- Oscillating Elbows
- LIQUIFit
- TrueSeal
- Flow Controls
- Prestomatic
- PTC
- Metric Prestomatic
- PMH
- Polypropylene Ball Valves

1. Cut tubing squarely – maximum of 15° angle allowable.
2. Check that port or mating part is clean and free of debris.
3. Mark tubing to appropriate tube insertion length. (see Tube Insertion Chart on page N22)
4. Insert tubing until it bottoms
5. Pull on tubing to verify it is fully inserted
6. To disassemble, simply press release button, hold against body and pull tubing out of fitting.



Transportation Compression Style NTA

1. Cut tubing squarely – maximum of 15° angle allowable.
2. Check that port or mating part is clean and free of debris.
3. Insert tubing until it bottoms on seat.
4. Tighten nut with wrench until one thread remains visible on the fitting body; (this will allow for a number of remakes) or, the nut should be screwed down finger tight, then wrench-tightened as indicated in the following table.

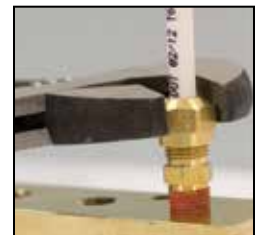

TUBE SIZE	ADDITIONAL NUMBER OF TURNS FROM HAND-TIGHT
3/16	2-1/2
1/4	3
3/8 & 1/2	4
5/8 & 3/4	3-1/2

Air Brake – AB Fittings

1. Cut tubing squarely and remove burrs
2. Slide nut and sleeve onto tubing.
3. Insert tubing into fitting until bottomed on seat. The nut should be screwed down finger tight, then wrench tightened as indicated in the chart



TUBE SIZE	TURNS REQUIRED TO SEAL FROM HAND-TIGHT
1/4, 3/8, 1/2	2
5/8, 3/4	3

Transmission Fittings

1. Cut tubing squarely and remove burrs
2. Insert tubing into fitting until bottomed
3. Tighten nut 1 1/2 turns from finger tight



Air Brake Hose Ends

1. Slide nut onto hose
2. Slide sleeve onto hose with tapered edge toward fitting body
3. Bottom hose into fitting
4. Tighten nut until it contacts body hex



Note: When reassembling fitting, body and nut should be inspected. Only reuse if parts are in proper condition. Sleeves should never be Reused.

Vibra-Lok

1. Cut the tubing squarely removing burrs
2. Slip nut and sleeve over tube
3. Bottom tubing into fitting and tighten nut until stop is reached. The elastic sleeve ordinarily will extrude slightly around the tube at the end of the nut. This extrusion further aids in isolating the tube from the nut.



For Higher Pressure applications

4. Consult pressure chart to determine if tubing should be belled
5. Slip nut and sleeve over tube. The sleeve should be positioned near end of tubing just behind the surface to be belled
6. Bell tubing with standard 45° flaring tool or 90° punch. The size of bell should be approximately that shown.



Recommended Size of Bell

TUBE O.D.	BELL DIA. C
1/8	.190-.160
3/16	.255-.225
1/4	.318-.288
5/16	.381-.351
3/8	.444-.414
1/2	.569-.539
5/8	.694-.664
3/4	.819-.789
7/8	.944-.914

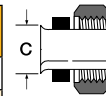

Tube Length Calculator

This table shows distance tube extends beyond face of Vibra-Lok fitting body on installation with bell on tubing and without bell on tubing.

O.D. OF TUBE	A WITH BELL	B WITHOUT BELL
1/8	3/16	3/16
3/16	3/16	7/32
1/4	3/16	1/4
5/16	3/16	1/4
3/8	3/16	1/4
1/2	3/16	11/32
5/8	3/16	TUBING SHOULD BE BELLED
3/4	3/16	
7/8	1/4	

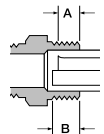

Compression

1. Slide nut then sleeve onto tubing. The thread end of the nut must face out.
2. Insert tube and bottom on the fitting shoulder
3. Assemble nut to body and tighten "hand tight". Then wrench tighten the number of turns indicated in the table.



FITTING SIZE	TUBE SIZE	TURNS REQUIRED TO SEAL FROM HAND-TIGHT	
		60C WITH SOFT METAL TUBING	60PT WITH THERMOPLASTIC TUBING
2	1/8	1-1/4	—
3	3/16	1-1/4	—
4	1/4	1-1/4	2
5	5/16	1-1/4	2
6	3/8	2-1/4	2
8	1/2	2-1/4	2
10	5/8	2-1/4	2
12	3/4	2-1/4	2
14	7/8	2-1/4	—

Compress-Align

With nut finger tight on fitting body, insert tubing until it bottoms in the Fitting. Complete the seal with one wrench turn for all sizes.



Poly-Tite

1. Cut tubing squarely – maximum of 15° angle allowable.
2. Check that port or mating part is clean and free of debris.
3. Insert tube end until it bottoms in the Poly-Tite fitting and tighten knurl/hex nut finger-tight, plus one wrench turn.



Hi-Duty

1. Cut tube squarely and cleanly removing all burrs.
2. Grasp fitting. Do not remove nut.
3. Insert tube in fitting through nut until tube seats firmly against tube shoulder in body.
4. Grip tube firmly to prevent turning and tighten nut to finger-tight. Continue to tighten for one and three-quarter additional turns (one and one-half turns for 1/2" size fittings) for a positive, leak proof seal. During tightening a slight "give" will be felt. This "give" indicates the sleeve has been sheared from the nut. It is not necessary to tighten the nut all the way down.



45° Flare Fittings

1. Cut tubing squarely and clean tube end thoroughly to remove burrs.
2. Place nut onto tube. Place threaded end of nut toward end of tube.
3. Flare tube end with flaring tool to provide 45° flare.
4. Clamp tube flare between nut and nose of fitting body by screwing nut on finger-tight. Tighten with a wrench an additional 1/4 to 1/2 turn past finger-tight for a metal-to-metal seal.



Inverted Flare

1. Cut tubing squarely and clean to remove burrs
2. Place nut onto tube. Place threaded end of nut toward end of tube.
3. Flare tube end with flaring tool to provide 45° flare
4. On thin wall copper, welded or brazed tubing, use double flare to prevent pinch-off or cracked flares
5. Clamp tube flare between nut and nose of fitting body by screwing nut on finger tight. Tighten nut with a wrench an additional 1/4 to 1/2 turn past finger tight for a metal-to-metal seal.



Dubl-Barb

Cut tube squarely and simply push tube over the two barbs



Hose Barbs

1. Cut hose cleanly and squarely to length.
2. Slide clamp on hose.
3. Lubricate hose. Push hose on fitting until bottomed against stop ring or hex.
4. Position hose clamp as shown and secure with a screwdriver or wrench. Maintain "A" dimension for proper clamp positioning.



HOSE SIZE	HOSE CLAMP	A
3/16	97 HC-3	1/4
1/4	97 HC-3	1/4
5/16	97 HC-6	1/4
3/8	97 HC-6	1/8
1/2	97 HC-8	1/8
5/8	97 HC-12	1/8
3/4	97 HC-12	1/8

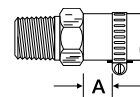

Pipe Fittings

Straight Fittings

1. Hand tighten external thread into internal thread
2. Tighten an additional 2 turns with a wrench up to 1/2" male pipe thread.
3. Above 1/2" 1 1/2 to 2 1/2 turns.

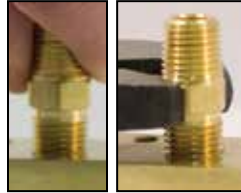

Elbow or Tee Fittings

1. Hand tighten external thread into internal thread
2. Tighten an additional 1 to 1 1/2 turns with a wrench
3. Tighten fitting, clockwise to align with tubing. (Never counter clockwise)

Note: To minimize the possibility of a leaking threaded joint after assembling Male to female pipe threads, neither end should be backed out (loosened) Once the assembly has been made.

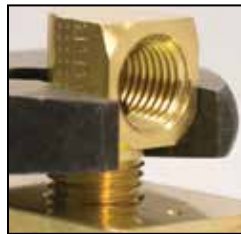
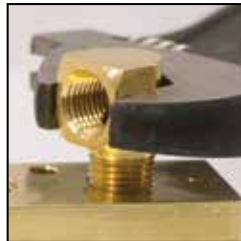

Plug Valves

To assure sealability and reliable performance, the valve must be installed so that the flow media travels in the direction of the arrow on the valve handle.



Needle Valves

Needle valves should always be installed with the pressure against the seat.

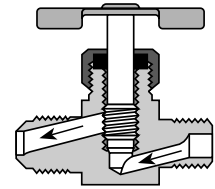

NEMA Rated Bulkhead

1. Drill panel to required diameter
2. Install sealing washer onto brass body.
3. Install fitting body through panel and secure with lock washer and jam nut.
4. Using a wrench to hold the fitting body torque the jam nut to spec per below table.

Note: For sealing bulkheads the sealing washer must be installed between the body hex and panel. To ensure a leak tight connection the panel surface must be kept flat and deburred after the drilling operation. It must be free from dirt, debris, and other contamination.

THREAD SIZE	MIN. TORQUE FT-LBS	MAX. TORQUE FT-LBS
5/8-18	15	20
3/4-16	15	25
1-14	40	50

Fluid Compatibility Guide

The following pages list general recommendations for the selection of valve materials. For specific cases, and for those not included in the Fluid Compatibility Chart, it is advisable to check with your Parker representative.

There are many specific environmental factors which might affect corrosion rate such as temperature, solution,

concentration and presence of impurities. Therefore, we suggest that the information be used as a rough guide to material selection. If any questions exist regarding the expected performance of a material in a given application, actual tests should be performed to determine the suitability of the materials in question.

FLUID	BRASS	CARBON STEEL	316 S.S.	BUNA N (NITRILE)	NEOPRENE	EPR	FLUORO-CARBON	PTFE	ACETAL	NYLON
ACETALDEHYDE	P	G	E	P	G	G	P	E	U	
ACETAMINE	G	G	G	E	G			E		
ACETATE SOLVENTS	E	E	E	P			U	E	U	
ACETIC ACID VAPORS	U		U	U				E		
ACETIC ACID (10%)	P	P	E	U	P	G	U	E	U	U
ACETIC ACID (80%)	P	P	E	U	U	P	U	E	U	U
ACETIC ACID (AERATED)	P	P	E	G	G		P	E	U	
ACETIC ACID (AIR FREE)	P	P	E	G	G		U	E	U	
ACETIC ACID (CRUDE)	P	P	E	U	U		U	E	U	
ACETIC ACID (GLACIAL)			U	U	P	G	P	E		U
ACETIC ACID (PURE)	P	U	E	U	U		U	E	U	
ACETIC ANHYDRIDE	U	U	G	U	P	P	U	E	U	U
ACETONE	E	E	E	U	U	E	U	E	E	E
ACETOPHENONE	G	G	G	U	U	E	U			
ACETYL CHLORIDE	E	G	P	U	U	U	U	E		
ACETYLENE	G	E	E	G	P	E	E	E	E	
ACID FUMES	U	U	G	P	G			E		
ACRYLONITE	E	E	E	U	U	U	P	E		
AIR	E	E	E	E	E	E	E	E	E	
ALCOHOL, AMYL	G	G	E	P	P	E	G	E	E	
ALCOHOL, BUTYL	G	G	E	G	G	P	E	E	E	
ALCOHOL, DIACETONE	E	E	E	U	P	G	U	E		
ALCOHOL, ETHYL	G	G	G	E	G	E	E	E	E	
ALCOHOL, ISOPROPYL	G	G	G	P	G	E	E	E	E	
ALCOHOL, METHYL	E	G	E	G	E	E	P	E		E
ALCOHOL, PROPYL	E	G	E	G	G	E	E	E		
ALCOHOLS, FATTY	G	G	E	G	G			E		
ALUM	U		G	G	G		G	E		
ALUMINA	U		E	E	E	E		E		
ALUMINUM ACETATE	G		E	U	U	E	U	E		
ALUMINUM BROMIDE				E	E	E	E			
ALUMINUM CHLORIDE DRY	U	P	P	G	G	E	E	E	E	
ALUMINUM CHLORIDE SOLUTION			U	G	G		E	E		U
ALUMINUM FLUORIDE	U	U	P	E	E	E	E	E		U
ALUMINUM HYDROXIDE	E	U	E	E	E	E	E	E		
ALUMINUM NITRATE	U	U	P	G	G	G	U	E		
ALUMINUM OXALATE			U					E		
ALUMINUM SALTS				E	E	E	E			
ALUMINUM SULFATE	P	U	G	E	E	E	E	E	E	P
AMINES	G	G	E	U	U	P	U	E	E	
AMLY CHLORIDE	G		E	U	P	U	U	E		
AMMONIUM BICARBONATE	G	P	G	G	E	E	E	E	E	
AMMONIA, ALUM			E	G	G			E		
AMMONIA, ANHYDROUS LIQUID	U	E	E	G	P	G	U	E		
AMMONIA, AQUEOUS	U	E	E	G	G		E	E		
AMMONIA, GAS, HOT	U	G	E	P	E	E	U	E		
AMMONIA LIQUOR			E					E		
AMMONIA SOLUTIONS	U	G	E	G	G	G	U	E		
AMMONIUM ACETATE	U		G	G	G	E	U	E		
AMMONIUM BROMIDE 5%			G					E		

E-EXCELLENT

G-GOOD

P-POOR

U-UNSATISFACTORY

FLUID	BRASS	CARBON STEEL	316 S.S.	BUNA N (NITRILE)	NEOPRENE	EPR	FLUORO-CARBON	PTFE	ACETAL	NYLON
AMMONIUM CARBONATE	G	G	G	P	E	E	G	E	E	
AMMONIUM CHLORIDE	U	U	P	G	E	E	E	E	E	U
AMMONIUM HYDROXIDE 28%	U	P	G	G	E	G	E	E	E	
AMMONIUM HYDROXIDE CONC.	U	P	G	P	E	E	E	E	E	
AMMONIUM MONOSULFATE			E				E	E		
AMMONIUM NITRATE	U	U	E	E	E	E	E	E	E	U
AMMONIUM OXALATE 5%			E				E	E		
AMMONIUM PERSULFATE	P	U	E	U	P	G	G	E		U
AMMONIUM PHOSPHATE	U	U	G	E	E	E	E	E	G	P
AMMONIUM PHOSPHATE DI-BASIC	P	U	G	E	E		E	E	E	
AMMONIUM PHOSPHATE TRI-BASIC	P	U	G	E	E		E	E	E	
AMMONIUM SULFATE	P	P	G	E	E	E	G	E	E	U
AMMONIUM SULFIDE	U	U	G	E	G	E	U	E		
AMMONIUM SULFITE	P	P	E	G	E	G	E	E	E	
AMYL ACETATE	G	P	G	U	U	G	U	E	G	P
AMYL BORATE				E	E	U	E			
AMYL CHLORONAPHTHALENE				U	U	U	E			
AMYL NAPHTHALENE				U	U	U	E			
ANILINE	U	P	G	U	U	P	P	E	E	P
ANILINE DYES	P	P	E	P	P	P	G	E	E	
ANIMAL OIL	G	G	G	E	G	G	E			
ANTIMONY TRICHLORIDE	U	U	U	P			G	E		
APPLE JUICE	P	U	G	E	E	G	E	E		
AQUA REGIA (STRONG ACID)	U	U	G	U	U	U	U	E		U
AROCLOR 1248	G	U	U	U	U	G	E			
AROCLOR 1254	G	U	U	U	U	G	E			
AROCLOR 1260	G	U	U	E	E		E			
AROMATIC SOLVENTS	E	P	E	U	U	U		E		
ARSENIC ACID	U	U	G	E	E	G	E	E	E	U
ASPHALT EMULSION	E	G	E	U	P	U	E	E	E	
ASPHALT LIQUID	E	G	E	P	P	U	E	E	E	
ASTM OIL, NO. 1	E	E	E	E	E	U	E			
ASTM OIL, NO. 2	E	E	E	E	G	U	E			
ASTM OIL, NO. 3	E	E	E	E	U	U	E			
ASTM OIL, NO. 4	E	E	E	E	U	U	E			
ASTM REFERENCE FUEL A	U	G	E	E	G	U	E			
ASTM REFERENCE FUEL B	U	G	E	E	U	U	E			
ASTM REFERENCE FUEL C	U	G	E	G	U	U	E			
BARIUM CARBONATE	G	G	G	G	E	E	E	E	E	
BARIUM CHLORIDE	G	P	G	E	E	E	E	E	E	E
BARIUM CYANIDE	P		G	G	G	G	G	E		
BARIUM HYDRATE	U		E					E		
BARIUM HYDROXIDE	P	P	G	E	E	G	E	E	E	
BARIUM NITRARE			E		G			E		
BARIUM SALTS				E	E	E	E			
BARIUM SULFATE	P	P	E	E	E	G	E	E	E	E
BARIUM SULFIDE	U	P	G	E	G	E	E	E	E	
BEER	G	U	E	G	G	G	E	E	E	U
BEET SUGAR LIQUORS	E	G	E	E	E	G	E	E	E	
BENZALDEHYDE	E	E	E	U	U	E	U	E	E	E
BENZENE	G	G	G	U	U	U	G	E		E
BENZENESULFONIC ACID, 10%	U	U	U	U	G	U	E			
BENZLY CHLORIDE	U	U	G	U	U	U	E			
BENZOIC ACID	G	U	G	P	P	U	G	E		P
BENZYL ALCOHOL		U	E	U	G	G	E			
BERRYLLIUM	G		G	G	G	G	G	E		
BLEACH LIQUOR				U	G	E	E			
BLEACHING POWDER WET	G		P	U	E	G	G	E	E	
BLOOD	G		E	G	G	G	G	E		
BORAX	U	P	E	G	U	E	E	E	E	E
BORAX LIQUORS	E	P	G		P	E	E	E	E	
BORDEAUX MIXTURE			E				E	E	E	
BORIC ACID	P	U	G	G	G	G	E	E	E	G
BRAKE FLUID	G		G	U	P	G	U	E		
BRINES, SATURATED	G	U	G	E	G	E	E	E	E	
BROMINE, DRY	G	U	U	U	U	U	G	E		
BROMINE, WET	U	U	U	U	U	U	G	E		

E-EXCELLENT

G-GOOD

P-POOR

U-UNSATISFACTORY

FLUID	BRASS	CARBON STEEL	316 S.S.	BUNA N (NITRILE)	NEOPRENE	EPR	FLUORO-CARBON	PTFE	ACETAL	NYLON
BUNKER OILS (FUEL)	G	G	E	G	G		E	E	E	
BUTADIENE	P	G	E	P	P	P	G	U		
BUTANE	E	G	E	G	G	U	E	E	E	
BUTTER	G	U	E	G	G			E		
BUTTERMILK	U	U	E	E	E	G	E	E	E	
BUTYL ACETATE	G	U	G	U	U	U	U	E		E
BUTYL ALCOHOL	E	P	E	G	G		G	E		
BUTYL AMINE	G	G	E	U	U		U	E		
BUTYL BUTYRATE				U	U	E	E			
BUTYL CARBITOL	E	P	E	U	U		U	E		
BUTYL CELLOSOLVE	E	P	E	U	U		G	E		
BUTYL STEARATE				G	U	U	E			
BUTYLENE	E	E	E	U	U	U	U	E		
BUTYRIC ACID	P	U	G	P	P	P	P	E	E	U
CALCINE LIQUORS				E		E	E			
CALCIUM ACETATE				G	G	E	U			
CALCIUM BISULFITE	P	U	G	E	E	U	E	E	E	
CALCIUM CARBONATE	P	U	G	E	E	G	E	E	E	
CALCIUM CHLORATE	U		G	G	G	G	G	E		
CALCIUM CHLORIDE	G	P	G	E	E	G	E	E	E	U
CALCIUM HYDROXIDE	P	P	G	E	G	E	E	E	E	
CALCIUM HYPOCHLORITE	U	U	P	P	P		E	E	E	U
CALCIUM NITRATE			G	G	G	G	G	E		
CALCIUM PHOSPHATE	P		G	G	G	G	G	E		
CALCIUM SALTS				E	E	E	E			
CALCIUM SILICATE	P		G	G	G	G	G	E		
CALCIUM SULFATE	P	P	G	E	E	G	E	E	E	U
CALCIUM SULFIDE	U	U	G	E	E	E	E			
CALICHE LIQUOR		G		G	G			E		
CAMPHOR	P		E	G	G	G	G	E		
CANE SUGAR LIQUORS	G	G	E	G	G	G	G	E		
CARBOLIC ACID	U	U	G	G	G	G	E	E	U	
CARBON BISULFIDE	P	G	G	U	U	U	E	E	E	
CARBON DIOXIDE, DRY	E	E	E	P	G	G	G	E	E	
CARBON DISULFIDE	U	P	E	U	U		E	E	E	
CARBON MONOXIDE	E	E	E	G	U	G	G	E		
CARBON TETRACHLORIDE, DRY	P	G	E	U	U	U	G	E	E	
CARBON TETRACHLORIDE, WET	U	U	G	U	U	U	G	E	E	
CARBONATED BEVERAGE	G	U	G	U	G	G	G	G		E
CARBONATED WATER	G	G	E	E	E	E	E	E	E	
CASEIN	P			G	G	G	G	G	E	
CASTER OIL	E	G	E	E	G	G	E	E	E	
CAUSTIC POTASH			E	G	G			E		
CAUSTIC SODA		G	E	P		G	G	E		
CELLULOSE ACETATE	G		G	U	U	G	U	E		
CELLULUBE	E	P	E	U	U		U	E		
CHINA WOOD OIL	P	P	E	E	G	U	E	E	E	
CHLORACETIC ACID	P	U	U	U	P		P	E		U
CHLORINATED SOLVENTS	P	P	E	U	U	U	P	E	E	
CHLORINATED WATER	U	P	G	E		E	E	E	U	U
CHLORINE, WET	U	U	U	U	U			E		
CHLORINE GAS	P	G	G	P	U	U	G	E	E	
CHLORO BROMO METHANE	G	U	G	U	U		G	E		
CHLOROBENZENE, DRY	G	G	E	U	U	U	E	E	E	E
CHLOROBUTADIENE				U	U	U	E			
CHLOROFORM, DRY	G	G	E	U	U	U	G	E	E	U
CHLOROPHYLL, DRY	G		G	G	G	G	G	E		
CHLOROSULFONIC ACID, DRY	P	G	G	U	U	U	U	E		U
CHLOROSULFONIC ACID, WET	U	U	U	U	U		P	E		
CHLORPHENOL				U	U	U	E			
CHROME ALUM	P	G	E	G	G	G	G	E		
CHROMIC ACID <50%	U	U	P	U	U	P	P	E	U	U
CHROMIC ACID >50%	U	U	P	U	U	P	P	E		
CHROMIUM SULFATE	P		G	G	G	G	G	E		
CIDER			E					E		
CITRIC ACID	P	U	G	G	E	G	E	E		P
CITRUS JUICES	G	U	G	E	E		E	E	E	

E-EXCELLENT

G-GOOD

P-POOR

U-UNSATISFACTORY

FLUID	BRASS	CARBON STEEL	316 S.S.	BUNA N (NITRILE)	NEOPRENE	EPR	FLUORO-CARBON	PTFE	ACETAL	NYLON
COCA-COLA SYRUP			E	G	G		G	E		
COCONUT OIL	G	P	E	E	P	E	E	E	E	
COFFEE	E		G	E	E	E	E	G		
COFFEE EXTRACTS, HOT	G	P	E					E		
COKE OVEN GAS	P	G	E	P	U	U	G	E		
COOKING OIL	G	G	E	E	G	U	E	E	E	
COPPER ACETATE	U	U	E	P	P	G	U	E		
COPPER CARBONATE			E					E		
COPPER CHLORIDE	U	U	P	G	G		E	E		U
COPPER CYANIDE	U		E	E	E	G	G	E		E
COPPER NITRATE	U	U	G	E	E	G	E	E	E	U
COPPER SALTS					E	E	E	E		
COPPER SULFATE	U	U	G	E	E	E	E	E	E	P
CORN OIL	G	P	G	E	P	P	E	E	E	
COTTONSEED OIL	G	P	G	E	G	P	G	E	E	
CREOSOTE OIL	G	G	G	P	U	U	E	E		U
CREOSOLS	U	G	G	U	U	U	U	E		
CRESYLIC ACID	P	P	G	U	U	U	G	E	U	U
CRUDE OIL, SOUR	P	G	E	E	G	U	E	E		
CRUDE OIL, SWEET	G	G	E	E	G		E	E		
CUPRIC NITRATE			E					E		
CUTTING OILS, WATER EMULSIONS	E	G	E	E	G		E	E		E
CYANIDE PLATING SOLUTION	U		G	G	G	G	G	E		
CYCLOHEXANE	E	E	E	P	U	U	E	E	E	
CYCLOHEXANONE	G		E	U	U			E		
DECANE				E	U	U	E			
DENATURED ALCOHOL				E	E	E	E			
DETERGENTS, SYNTHETIC	G	U	G	G	G	G	E	E		
DEXTRIN	G		G	G	G	G	G	E		
DIACETONE ALCOHOL	E	E	E	U	P			E		
DICHLOROETHANE			P	U	U	U		E		
DICHLOROETHYL ETHER	G		G	U	U	U	U	E		
DIESEL OIL FUELS	E	E	E	E	P	U	E	E		
DIETHYL BENZENE			G	U	U	U		E		
DIETHYL SULFATE	G		G	P	P	P	G	E		
DIETHYLAMINE	G	E	E	G	P	P	U	E		
DIETHYLENE GLYCOL	G	E	E	E	E	E	G	E		
DIMETHYL FORMAMIDE	G		E	G	U	U	U	E		
DIMETHYL PHTHALATE			U	G	G		U	E		
DIOCTYL PHTHALATE	E		E	P	U	U	P	E		
DIOXANE	G		G	U	U	P	U	E		
DIPENTANE	E		E	G	U	U	G	E		
DISODIUM PHOSPHATE			G	G	G		G	E		
DOW CHEMICAL HD50-4					G	E	U			
DOW CORNING 200, 510, 550				G	E	E	E			
DOWTHERM	E	G	E	U	U	U	E	E	E	
DRILLING MUD	G	G	E	E	P	E	E	E	E	
DRY CLEANING FLUIDS	P	G	E	U	U		G	E	E	
DRYING OIL	P	P	G	E	G			E	E	
ENAMEL	E		E	G	G	U		E		
EPSOM SALTS	G	P	G	E	E		E	E	E	
ETHANE	G	P	G	E	G	U	E	E	E	
ETHANOL	E	U	U	U	E	E	U			
ETHANOLAMINE	U	G	E	G	P		U	E		
ETHERS	G	E	E	U	U	P	P	E	P	
ETHYL ACETATE	P	G	G	U	U	P	U	E	E	E
ETHYL ACRYLATE	G	P	E	U	U	P	U	E		
ETHYL ALCOHOL	G	G	G	E	E		E	E		
ETHYL BENZENE			G	P	U	U		E	E	
ETHYL BROMIDE	E		G	G	G	G	G	E		
ETHYL CHLORIDE, DRY	G	G	E	P	P	P	G	G	E	E
ETHYL CHLORIDE, WET	P	U	E	P	P	G	G	E		
ETHYL ETHER	G		E	U	U	U	U	E		
ETHYL HEXANOL				E	E	E	E			
ETHYL SILICATE	G		G	G	P	G	G	E		
ETHYL SULFATE			G	G	G	P	E	E	E	

E-EXCELLENT

G-GOOD

P-POOR

U-UNSATISFACTORY

FLUID	BRASS	CARBON STEEL	316 S.S.	BUNA N (NITRILE)	NEOPRENE	EPR	FLUORO-CARBON	PTFE	ACETAL	NYLON
ETHYLENE CHLORIDE			E	U	E		U	E		
ETHYLENE DICHLORIDE	U	U	G	U	U		U	E		
ETHYLENE GLYCOL	G	G	G	E	G		E	E		
ETHYLENE OXIDE	P	G	G	U	U		U	E		
FATTY ACIDS	P	U	E	G	G		U	E	E	U
FERRIC CHLORIDE	U	U	U	E	U		E	E		U
FERRIC HYDROXIDE			E	G				E		
FERRIC NITRATE	U	U	P	E	E	E	E	E	E	U
FERRIC SULFATE	U	U	G	E	E	E	E	E	E	U
FERROUS AMMONIUM CITRATE			G					E		
FERROUS CHLORIDE	G	U	U	E	E	E	E	E	E	U
FERROUS SULFATE	G	U	G	E	E	E	E	E	E	U
FERROUS SULFATE, SATURATED	P	P	E	P	P	G	G	E		
FERTILIZER SOLUTIONS	P	G	G	G	G			E	G	
FISH OILS	G	G	E	E	G	U	E	E	G	
FLUE GASES	G		E	P	P	U	P	E	P	
FLUOBORIC ACID			G	E	G			E		U
FLUORINE, DRY	U		U	U					E	
FLUOROSILICIC ACID	G	U	G	P	P	P	P	E		U
FOOD FLUIDS & PASTES	G	P	E	G	E			E		
FORMALDEHYDE, COLD	E	E	E	G	P	G	U	E	E	U
FORMALDEHYDE, HOT	G	U	P	G	G			E	E	U
FORMIC ACID, COLD	G	U	G	U	G		G	E	U	E
FORMIC ACID, HOT	G	U	G	U	E		E	E	U	
FRUIT JUICES	G	U	E	E	E	E	E	E	E	
FUEL OIL	G	G	E	E	P	U	E	E	E	
FUMARIC ACID			G	G	G			E		
FURFURAL	E	E	E	U	P	P	U	E	E	E
GALIC ACID 5%	P	U	G	G	G	P	E	E	E	
GAS, NATURAL	G	G	E	E	E	U		E	E	
GAS, ODORIZERS	E	G	G	G	G			E	E	
GAS MFG.	G	G	G	E				E	E	
GASOLINE, AVIATION	E	E	E	P	U			E	E	E
GASOLINE, LEADED	E	E	E	P	U			E	E	
GASOLINE, MOTOR	E	E	E	P	U	U		E	E	
GASOLINE, REFINED	G	G	E	P	P	U		E	E	
GASOLINE, SOUR	G	G	E	P	U	U		E	E	
GASOLINE, UNLEADED	E	E	E	P	U			E	E	E
GELATIN	E	U	E	E	E	E		E	E	
GLUCOSE	E	G	E	E	E	E		E	E	
GLUG	E	G	E	E	G	E		E	E	
GLYCERINE	G	P	E	P	U	E	G	E	P	E
GLYCOL	G	P	G	G	E	E	E	E	P	
GLYCOL AMINE	U		G	E		U	U			
GRAPHITE	G		G	G	G	G	G	E		
GREASE	P	E	E	E	G	U	E	E		
GULF-FR FLUID, EMULSION			E	E	G	U	E			
GULF-FR FLUID G			E	E	E	E	E			
GULF-FR FLUID P			U	U	U	G	G			
HELIUM GAS	G	E	E	G	G	G	G	E		
HEPTANE	E	G	E	E	G	U	E	E	E	
HEXANE	G	G	E	E	P	U	E	E	E	E
HEXANOL, TERTIARY	E	E	E	E	P	U	G	E	E	
HEXYL ALCOHOL	E	P	E	U	P		E	E		
HYDRAULIC OIL, PETROLEUM BASE	G	E	E	E	G	U	E	E	E	
HYDRAZINE	U	U	G	P	P	G	U	E		
HYDRIGEN SULFIDE, DRY	P	G	E	P	E	E	E	E		
HYDROCHLORIC ACID, AIR FREE	U	U	U	G	P		E	E		U
HYDROCYANIC ACID	U	U	E	G	G	G	E	E	U	
HYDROFLUORIC ACID	U	U	U		G					U
HYDROFLUOSILICIC ACID	E	U	P	G	G	G	E	E		U
HYDROGEN GAS, COLD	G	G	E	G	G	G	E	E		
HYDROGEN GAS, HOT	G	G	G	G	G		E	E		
HYDROGEN PEROXIDE, CONCENTRATED	U	U	G	U	U	G	G	E		U
HYDROGEN PEROXIDE, DILUTE	P	U	G	E	G	G	E	E	G	U
HYDROGEN SULFIDE, WET	U	P	G	P	G	G	E	E	E	

E-EXCELLENT

G-GOOD

P-POOR

U-UNSATISFACTORY

FLUID	BRASS	CARBON STEEL	316 S.S.	BUNA N (NITRILE)	NEOPRENE	EPR	FLUORO-CARBON	PTFE	ACETAL	NYLON
HYDROLUBE				E	G	E	E			
HYPO (SODIUM THIOSULFATE)	P	U	G	E	E	E	E	E	E	
HYPOCHLORITES, SODIUM	U	U	P	P			E	E		
ILLUMINATING GAS	E	E	E	P	P	U	E	E		
INK, NEWSPRINT	P	U	E	E	G	G	E	E	E	
IODINE, WET	U	U	U	G			E	E		
IODIFORM	P	G	E				E	E	E	
ISOPROPYL ACETATE			G	U	U	U		E		
ISOPROPYL ALCOHOL	G	G	G	P	G		E	E		
ISOPROPYL ETHER	E	E	E	P	P	U	U	E		
ISO-BUTANE			G	G	U	U		E		
ISO-OCTANE	E	E	E	E	P	U	E	E		E
J P-4 FUEL	E	E	E	E	P		E	E	E	
J P-5 FUEL	E	E	E	E	P		E	E	E	
J P-6 FUEL	E	E	E	E	P		E	E	E	
KEROSENE	E	G	E	E	P	U	E	E	E	
KETCHUP	U	U	E	E	E		E	E	E	
KETONES	E	E	E	U	U	U	U	E	E	
LACTIC ACID, CONC. COLD	U	U	E	G	E	G	E	E	U	U
LACTIC ACID, CONC. HOT	U	U	G	P	P	G	G	E	U	U
LACTIC ACID, DILUTE COLD	U	U	E	G	E	G	E	E	U	U
LACTIC ACID, DILUTE HOT	U	U	E	P	U		U	E	U	U
LACTOSE	G		G	G	P	G	G	E		
LAQUER	E	P	E	U	U	U	U	E	E	E
LARD	G	E	E	G	P	P		E		
LARD OIL	G	P	G	E	G	G	E	E	E	
LEAD ACETATE	P	U	G	E	G	G	G	E	E	E
LEAD SULFATE	P		G	G	G	G	G	E		
LECITHIN	P		G	U	U	U	G	E		
LINOLEIC ACID	G	G	E	G	G	U	G	E	E	
LINSEED OIL	G	E	E	E	P	U	E	E	E	
LITHIUM CHLORIDE	G		G	G	G	G	G	E		
LPG	E	G	G	E	G	U	E	E	E	
LUBRICATING OIL	G	E	E	E	G	U	E	E	E	
LUDOX	U		G	G	G	G	G	E		
MAGNESIUM BISULFATE	G	G	E	G	G	G	G	E		
MAGNESIUM BISULFIDE	U		G	G	G	G	G	E		
MAGNESIUM CARBONATE	G		G	E	G	G	G	E		
MAGNESIUM CHLORIDE	G	P	E	E	E	E	E	E	E	E
MAGNESIUM HYDROXIDE	G	G	E	E	E	E	E	E	E	
MAGNESIUM HYDROXIDE HOT	U	G	E	G	G		E	E	E	
MAGNESIUM NITRATE			E	G	E		G	E		E
MAGNESIUM SALTS				E	E	E	E			
MAGNESIUM SULFATE	G	G	E	E	E	E	E	E	E	E
MALEIC ACID	G	G	G	G	G	U	E	E	E	
MALEIC ANHYDRIDE	G		G	U	U	U	G	E		
MALIC ACID	G	U	G	E	G		E	E	E	
MALT BEVERAGES			E	E	E	G	E	E		
MANGANESE CARBONATE			G	G				E		
MANGANESE SULFATE	G		E	G	G	G	G	E		
MAYONNAISE	U	U	E	E	E		E	E	E	
MEAT JUICES	U		E	G	G			E		
MELAMINE RESINS			P	G	G			E		
MERCURIC CHLORIDE	U	U	G	E	G	E	E	E		
MERCURIC CYANIDE	U	U	E	E	G	E	E	E		
MERCUROUS NITRATE	U		E				G	E		
MERCURY	U	E	E	E	E	E	E	E		E
METHANE	E	G	E	E	G		E	E		
METHANOL	E	E		E	E	E	U		E	
METHANOL	G		E	G	G	U	G	E		
METHYL ACETATE	E	G	E	U	U	G	U	E		
METHYL ACETONE	E	E	E	E	U	E	U	E		
METHYL ALCOHOL	G	G	G	E	U		P	E		E
METHYL BROMIDE 100%	P	G	G	G	U	U	G	E		
METHYL CELLOSOLVE	E	G	E	P	U	G	U	E		
METHYL CELLULOSE			E	U	U			E		
METHYL CHLORIDE	G	G	E	U	U	U	G	E	E	

E-EXCELLENT

G-GOOD

P-POOR

U-UNSATISFACTORY

FLUID	BRASS	CARBON STEEL	316 S.S.	BUNA N (NITRILE)	NEOPRENE	EPR	FLUORO-CARBON	PTFE	ACETAL	NYLON
METHYL ETHER				E	U	U	E			
METHYL ETHYL KETONE	E	E	E	U	U	G	U	E	E	E
METHYL FORMATE	E	P	G	U	G	G	U	E		
METHYL ISOBUTYLE KETONE			E	U	U			E		
METHYLAMINE	U	G	E	U	U	G	U	E		
METHYLENE CHLORIDE	E	G	E	U	U	U	P	E		U
MILK & MILK PRODUCTS	G	U	E	E	E	E	E	E	E	
MIL-F-81912, JP-9	E	E	E	U	U	U	E			
MIL-H-5606	E	E	E	E	G	U	E			
MIL-H-6083	E	E	E	E	E	U	E			
MIL-H-7083	E	E	E	E	G	E	G			
MIL-H-8446	G	E	E	G	E	U	E			
MIL-L-2104 & 2104B	E	E	E	E	G	U	E			
MIL-L-7808	U	G	E	G	U	U	E			
MINE WATERS, ACID	P	U	P	E			E	E		
MINERAL OILS	G	G	E	E	G	U	E	E	E	
MINERAL SPIRITS	G	G	G	E	P		E	E	E	
MIXED ACIDS, COLD	U	P	G	U	U	U	G	E	U	
MLO-7277 & MLO-7557	G	E	E	U	U	U	E			
MOBILE HF	E	E	E	E	G	U	E			
MOLASSES, CRUDE	E	E	E	E	E		E	E	E	
MOLASSES, EDIBLE	E	P	E	E	E		E	E	E	
MOLYBDIC ACID			E				E	E	E	
MONOCHLORO BENZENE DRY			G	U	U			E		
MONOMETHYL HYDRAZINE				G	G	E				
MORPHOLINE	G		E	U	U	G	U	E		
MURIATIC ACID	U	U	U	G			E	E		
MUSTARD	E	G	E	E	E		E	E	E	
NAPHTHENIC ACID	G	E	G	G	U	U	E			
NAPTHA	G	G	G	G	P		E	E	E	
NAPTHALENE	G	G	G	U	U	U	E	E	E	
NATURAL GAS, SOUR	G	G	E	E	E	U	E	E		
NEATSFOOT OIL				E	U	G	E			
NICKEL ACETATE	U	G	E	G	G	E	U			
NICKEL AMMONIUM SULFATE	U	U	E	E	G	G	U	E		
NICKEL CHLORIDE	U	U	G	E	E	G	E	E	E	E
NICKEL NITRATE	U	U	G	E	E	E	E	E	E	
NICKEL SALTS				E	G	E	E			
NICKEL SULFATE	U	U	G	E	E	G	E	E	E	E
NITRIC ACID 100%	U	U	E	U	U	U	G	E	U	U
NITRIC ACID 10%	U	U	E	P	G		E	E	U	U
NITRIC ACID 30%	U	U	E	P	P	G	E	E	U	U
NITRIC ACID 80%	U	U	P	U	U	U	G	E	U	U
NITRIC ACID ANHYDROUS	U	U	E	U	U	U	E	E		
NITROBENZENE	U	G	E	U	U	P	P	E		E
NITROGEN	E	E	E	E	E	G	E	E	E	
NITROUS ACID 10%	U	U	G	P	E		E	E	E	
NITROUS GASES	U	G	E					E		
NITROUS OXIDE	G	G	G	G	G		E	E		
NOCOTINIC ACID	E	G	E	U	U	U	G	E		
OCTYL ALCOHOL	E	E	E	G	G		E			
OILS, ANIMAL	E	E	E	E	G	G	G	E		
OILS, PETROLEUM REFINED	G	E	E	E	G	U	E	E	E	
OILS, PETROLEUM SOUR	P	G	E	E	G	U	E	E		
OILS, WATER MIXTURE	E	G	E	E	G		E	E	E	
OILS & FATS			E	G		U		E		
OLAIC ACID			G	U	U		P	E		
OLEIC ACID	G	P	G	G	P	U	E	E	E	
OLEUM	P	G	G	U	U	U	P	E	E	U
OLEUM SPIRITS	U		G	P	U	U	E	E		
OLIVE OIL	P	G	E	E	G	G	E	E	E	
ORTHO-DICHLOROBENZENE	G	G	E	U	U	U	E	E	E	
OTHER KETONES	E	E	E	U	U	U	U	E		
OXALIC ACID	G	U	G	P	G	G	E	E	P	U
OXYGEN	E	G	E	G	G	E	E	E	U	
OZONE, DRY	E	E	E	U	U	E	G	E		
OZONE, WET	G	P	E	U	U	G	G	E		

E-EXCELLENT

G-GOOD

P-POOR

U-UNSATISFACTORY

FLUID	BRASS	CARBON STEEL	316 S.S.	BUNA N (NITRILE)	NEOPRENE	EPR	FLUORO-CARBON	PTFE	ACETAL	NYLON
PAINTS & SOLVENTS	E	E	E	U	U	U	G	E		
PALM OIL	G	P	G	G	G	U	E	E	E	
PALMITIC ACID	G	P	G	G	G	G	E	E	E	
PAPER PULP	G		E	G	G	G	G	E		
PARAFFIN	E	G	E	E	P	U	E	E	E	
PARAFORMALDEHYDE	G	G	G	G	G	U		E	E	
PARALDEHYDE			G	G	G	U		E		
PARA-DICHLOROBENZENE	G	E	E	U	U	U			E	
PARKER O LUBE	E	E	E	E	E	U	E			
PEANUT OIL	G	E	E	E	U	U	E			
PENTANE	E	G	E	E	G	U	E	E	E	
PERCHLORETHYLENE, DRY	P	G	E	U	U	U	E	E		
PERCHLORIC ACID-2N	U	U	G	U	G	G			E	
PETROLATUM (PETROLEUM JELLY)	G	P	G	E	G		E	E	E	
PHENOL	G	U	E	U	U	U	G	E	U	E
PHOSPHATE ESTER	U	E	E	U		E		E		
PHOSPHORIC ACID 10%	U	U	U	G	E	G	E	E	U	U
PHOSPHORIC ACID 50% COLD	U	U	G	G	G	G	E	E	U	U
PHOSPHORIC ACID 50% HOT	U	U	U	G	G	G	E	E	U	U
PHOSPHORIC ACID 85% COLD	G	G	E	P	P		G	E	U	U
PHOSPHORIC ACID 85% HOT	P	P	G	P	P			E	U	U
PHOSPHORIC ANHYDRIDE			E	U	U		G	E	G	
PHOSPHOROUS TRICHLORIDE	U	G	E	U	U	G	G	E		
PHTHALIC ACID	G	P	G	P	P		E	E	E	
PHTHALIC ANHYDRIDE	G	P	G	P	P		E	E	E	
PICRIC ACID	P	U	G	P	E	G	G	E		
PINE OIL	G	G	E	E	U	U	E	E	E	
PINEAPPLE JUICE	P	P	E	E	E		E	E	E	
PITCH			E	P	P	U		E		
PLATING SOLUTIONS, CHROME	E	U	E		U	E	E			
PLATING SOLUTIONS, OTHER		E	E	E	U	E	E			
PNEUMATIC SERVICE	E	E	E	E	E	E	E	E		
POLYSULFIDE LIQUOR	U		G	G	G	G	G	E		
POLYVINYL ACETATE	G		G	G	P	G		E		
POLYVINYL CHLORIDE	G		G		P	G		E		
POTASSIUM ACETATE	G	E	G	G	G	E	U			
POTASSIUM BICARBONATE			E	G				E		E
POTASSIUM BICHROMATE			E	G	G		G	E	G	
POTASSIUM BISULFATE			E	G	G		E	E		
POTASSIUM BISULFITE	P	U	G	E	E	G	E	E	E	
POTASSIUM BROMIDE	P	U	E	E	E	G	E	E	E	P
POTASSIUM CARBONATE	G	G	G	E	E	G	E	E	E	E
POTASSIUM CHLORATE	G	G	G	E	E	G	E	E	E	P
POTASSIUM CHLORIDE	P	P	G	E	E	E	E	E	E	P
POTASSIUM CHROMATE	G		G	G	E	G	G	E		
POTASSIUM CYANIDE	U	G	G	E	E	E	E	E	E	E
POTASSIUM DICHROMATE	U	P	G	E	E	G	E	E	E	U
POTASSIUM DIPHOSPHATE	G	E	E	E			E	E		
POTASSIUM FERRICYANIDE	U	P	E	E	E	G	E	E	E	
POTASSIUM FERROCYANIDE	G	P	G	E	E		E	E	E	
POTASSIUM HYDROXIDEDILUTE COLD	U	E	G	E	G		U	E		E
POTASSIUM HYDROXIDE DILUTE HOT	U	G	G	G	G			E		
POTASSIUM HYDROXIDE TO 70% COLD										
POTASSIUM HYDROXIDE TO 70% HOT	U	E	G	P	G	E			E	
POTASSIUM HYDROXIDE TO 70% HOT	U	E	G	P	G	E		E		
POTASSIUM IODIDE	U	P	G	E	E	G	E	E	E	
POTASSIUM NITRATE	G	G	G	E	E	G	E	E	E	P
POTASSIUM OXALATE			E					E		
POTASSIUM PERMANGANATE	G	G	E	E	E	G	E	E	E	U
POTASSIUM PHOSOHATE	P		G	E	E	E	E	E		
POTASSIUM PHOSPHATE DI-BASIC	G	E	E	E	E	G	E	E	E	
POTASSIUM PHOSPHATE TRI-BASIC		E	G	E	E	G		E		
POTASSIUM SALTS			E	G	G	E	E			
POTASSIUM SULFATE	G	G	E	E	E	E	E	E	E	P
POTASSIUM SULFIDE	G	G	E	E	G	G	G	E		
POTASSIUM SULFITE	G	G	E	E	G	E	G	E		
PRODUCER GAS	G	G	G	E	G	U	E	E	E	

E-EXCELLENT

G-GOOD

P-POOR

U-UNSATISFACTORY

FLUID	BRASS	CARBON STEEL	316 S.S.	BUNA N (NITRILE)	NEOPRENE	EPR	FLUORO-CARBON	PTFE	ACETAL	NYLON
PROPANE GAS	E	G	G	E	G	U	E	E	E	
PROPYL ACETATE	U	E	E	U	U	G	U			
PROPYL ALCOHOL	E	G	G	E	E		E	E		
PROPYL BROMIDE	G		G	G	G	G	G	E		
PROPYLENE	E	E	E	U	U	U	E			
PROPYLENE GLYCOL	G	G	G	E	E	G	E	E	P	
PYDRAUL	E	P	E	U	U		G	E		
PYRIDINE			G	U	U		U	E		
PYROGARD 42, 43, 53, 55				U	U	E	E			
PYROGARD D				E	G	E	E			
PYROLGALIC ACID	G	G	G	E	E		E	E	E	
QUENCH OIL	G	G	E	E	G		E	E	E	
QUININE, SULFATE, DRY			E					E		
R P-1 FUEL	E	E	E	G	P		E	E	E	
RESINS & ROSINS	E	P	E	P	P		E	E		
RESORCINOL			G					E		
ROAD TAR	E	E	E	G	P	U	E	E	E	
ROOF PITCH	E	E	E	G	P		E	E	E	
ROSIN EMULSION	G	P	E	U	P		G	E		
RUBBER LATEX EMULSIONS	E	G	E				E	E	E	
RUBBER SOLVENTS	E	E	E	U	P		U	E	P	
SALAD OIL	G	P	G	E	E	G	E	E	E	
SALICYLIC ACID	P	U	E	E	E	G	E	E	E	
SALT	G	P	G	E	E		E	E	E	
SALT BRINE	G		G	E	U	G	G	E		
SAUERKRAUT ARINE			G					E		
SEA WATER	P	U	G	E	E	E	E	E	E	
SEWAGE	P	P	G	E	P	G	G	E		
SHELL IRUS 905				E	G	U	E			
SHELLAC	E	E	E	E	E			E		
SILICONE FLUIDS	G		G	G	G		G	E		
SILVER BROMIDE										
SILVER CYANIDE	U		E	G	G		G	E		
SILVER NITRATE	U	U	E	P	P	E	E	E	E	
SILVER PLATING SOL.			E		G			E		
SKYDROL 500	E	G	E	U	U		U	E		
SKYDROL 7000, TYPE 2	U	E	E	U	U	E	G			
SOAP SOLUTIONS	E	E	E	E	G	E	E	E		
SODIUM ACETATE	G	P	G	E	G	G	E	E	E	E
SODIUM ALUMINATE	G	P	E	E	E	G	E	E	E	
SODIUM BENZOATE			G					E		
SODIUM BICARBONATE	G	P	G	E	E	E	E	E	E	E
SODIUM BICHROMATE			G	U				E		
SODIUM BISULFATE 10%	G	U	E	E	E	G	E	E	E	P
SODIUM BISULFITE 10%	G	U	E	E	E	G	E	E	E	P
SODIUM BORATE	G	P	G	E	E	G	E	E	E	
SODIUM BROMIDE 10%	G	P	G	E	E	G	E	E	E	
SODIUM CARBONATE	G	G	E	E	E	G	E	E	E	E
SODIUM CHLORATE	G	P	G	E	E	G	E	E	E	P
SODIUM CHLORIDE	G	P	G	E	E	G	E	E	E	E
SODIUM CHROMATE	P	G	E	E	E	G	E	E	E	
SODIUM CITRATE			G					E		
SODIUM CYANIDE	U	G	E	E	E	G	E	E	E	E
SODIUM FERRICYANIDE			E					E		
SODIUM FLUORIDE	P	U	G	E	E	G	E	E	E	
SODIUM HYDROXIDE 20% COLD	E	E	E	E	E	G	G	E		E
SODIUM HYDROXIDE 20% HOT	E	G	E	G	G	G	P	E		
SODIUM HYDROXIDE 50% COLD	E	E	E	E	E	G	P	E		E
SODIUM HYDROXIDE 50% HOT	E	G	E	E	G	G	P	E		
SODIUM HYDROXIDE 70% COLD	E	E	E	G	P	G	P	E		
SODIUM HYDROXIDE 70% HOT	G	G	E	U	U	G	P	E		
SODIUM HYPOCHLORITE (BLEACH)	U	U	U				E	E		U
SODIUM HYPOSULFITE			G					E		
SODIUM LACTATE			E					E		
SODIUM METAPHOSPHATE	P	G	G	E	E	G		E		
SODIUM METASILICATE COLD	G	P	E	G	E		G	E		
SODIUM METASILICATE HOT	G	U	E					E		

E-EXCELLENT

G-GOOD

P-POOR

U-UNSATISFACTORY

FLUID	BRASS	CARBON STEEL	316 S.S.	BUNA N (NITRILE)	NEOPRENE	EPR	FLUORO-CARBON	PTFE	ACETAL	NYLON
SODIUM NITRATE	G	G	E	P	G	G	E	E	E	E
SODIUM NITRITE			G	P	U	E	G	E	G	
SODIUM PERBORATE	G	G	G	P	G	E	E	E	E	
SODIUM PEROXIDE	U	P	G	P	G	E	E	E	E	
SODIUM PHOSPHATE	P	P	G	G	P	E	E	E	G	
SODIUM PHOSPHATE DI-BASIC	P	P	G	E	E	E	E	E	E	
SODIUM PHOSPHATE TRI-BASIC	P	P	G	G	G	E	E	E	E	
SODIUM POLYPHOSPHATE			G	G	G	E	E	E		
SODIUM SALICYLATE			E				E	E		
SODIUM SALTS										
SODIUM SILICATE	G	G	G	E	E	G	E	E	E	E
SODIUM SILICATE, HOT	P	P	G			G	E	E		
SODIUM SULFATE	G	G	E	E	E	E	E	E		E
SODIUM SULFIDE	U	G	E	E	E	G	E	E	E	E
SODIUM SULFITE	P		G	E	E	G	G	E		
SODIUM TETRABORATE			E	E	E	G		E		
SODIUM THIOSULFATE	P	G	E	E	E	E	E	E	E	
SOYBEAN	G	P	G	E	G	G	E	E	E	
STANNIC CHLORIDE	P	U	U	E	E		E	E		
STARCH	G	P	G	E	E	P	E	E	E	
STEAM (212 F)	E	E	E	U	U	G	P	E	U	
STEARIC ACID	P	P	E	E	P	G	E	E	E	
STODDARD SOLVENT	G	E	G	E	G	U	E			
STYRENE	E	E	E	U	U	U	G	E		
SUCROSE SOLUTIONS	E	E	E	E	G	E	E			
SUGAR, SYRUPS & JAM	G		E		G			E		
SUGAR LIQUIDS	E	G	E	E	E	G	E	E	E	
SULFATE, BLACK LIQUOR	P	P	G	P	G	G	P	E	E	
SULFATE, GREEN LIQUOR	P	P	G	P	G		P	E	E	
SULFATE, WHITE LIQUOR	P	P	G	P	G		P	E	E	
SULFUR	U	P	G	U	P	G	G	E	E	
SULFUR, MOLTEN	U	P	G	U	P	G	G	E		
SULFUR CHLORIDES	G	U	U	U	U	P	E	E	E	
SULFUR DIOXIDE, DRY	G	G	E	U	U	E	E	E	E	
SULFUR DIOXIDE, WET	U		E	U	U	G		E		
SULFUR HEXAFLUORIDE	G		E		G			E		
SULFUR TRIOXIDE	G	G	G	U	U		G	E		
SULFUR TRIOXIDE, DRY	G	G	G	U	U	G	E	E		
SULFURIC ACID 0 TO 77%	P	U	P	G	G		E	E	P	U
SULFURIC ACID 100%	P	P	E	U	U	P	G	E	U	U
SULFUROUS ACID	U	U	G	P	P	P	E	E	P	
SUNSAFE	U	E	E	E	G	U	E			
TALL OIL	G	G	G	G	G	U	E	E		
TANNIC ACID	G	P	G	G	G	G	E	E	E	U
TANNING LIQUORS			G	G	U			E		
TAR & TAR OILS	E	E	E	P	U	U	E	E		
TARTARIC ACID	G	U	E	P	G	G	E	E	E	
TERPINEOL				G	U	U	E			
TERTIARY BUTYL ALCOHOL	E	E	E	G	G	G	E			
TETRACHLOROETHANE		G	E	U	U	U	E			
TETRACHLOROETHYLENE	U	G	U	U	U	E				
TETRAETHYL LEAD	G	P	G					E	E	
TITANIUM TETRACHLORIDE	G	E	G	G	U	U	E			
TOLUOL (TOLUENE)	E	E	E	U	U	U	G	E	E	E
TOMATO JUICE	P	P	E	E	E		E	E		E
TRANSFORMER OIL	G	E	E	E	G		E	E	E	
TRANSMISSION FLUID, TYPE A	E	E	E	E	G	U	E			
TRIBUTYL PHOSPHATE	E	E	E	U	U	G	U	E		
TRICHLOROETHYLENE	G	G	G	U	U	U	G	E	E	U
TRICHLOROACETIC ACID	G		U	P	U		U	E		
TRICHLOROETHANE		G	E	U	U	U	E			
TRICRESYL PHOSPHATE		E	G	U	U	E	G			
TRITHANOLAMINE			G	P	G	G		E		
TRIETHYLAMINE	G		G	G	G			E		
TRISODIUM PHOSPHATE			G	E	E	G	G	E		
TUNG OIL	G	G	E	E	G	U	E	E	E	
TURBINE OIL #15		G	E	G	U	U	E		E	

E-EXCELLENT

G-GOOD

P-POOR

U-UNSATISFACTORY

1F	H7	48IFHD	H14	62PLM	A43
2GF	H7	50CT	L15	62PLMBH	A43
3GF	H7	50GHSV	J26	62PLMSP	A45
4CB-SR	L13	53GH	J26	62PLP	A6
9-DC	L14	54GH	J26	62PLPBH	A6
14FL	H7	55GH	J26	62PLS	A51
14FS	H7	56PSG	G29	62PLSBH	A52
14FSV	H7	56RBSG	F16	62PTBH	G30
14FSX	H7	59CA	G13	62PTC	E12
16-CB	L13	59HD	G38	62RB	F16
18-DC	L14	59P	G29	62TF	F11
20	I6	60AB	F13	62VL	F18
22	I6	60C	G8	63NTA	F7
22BH	I6	60NTA	F7	63PLM	A45
22CA	I6	60P	G29	63PLP	A31
22CABH	I6	60PB	G29	63PT	G9, G13
24B-Cabinet	L14	60PT	G8	66AB	F13
24-CB	L13	60RB	F16	66BJB	A25
24M	E9	60TF	F11	66C	G9
24PLP	A28	60VL	F18	66CA	G14
24PLPD	A29	60VLV	F18	66HD	G36
26	I6	61AB	F13	66LF	A13
27	I6	61C	G8	66NBH	F7
28	I6, I7	61CA	G13	66NTA	F8
30GH	C43	61CL	G8	66P	G30
31GH	C43	61HD	G36	66PLM	A39
31HB	C43	61NTA	F7	66PLMBH	A43
32PLCK	B27	61P	G29	66PLP	A6
32PLP	A26	61PB	G29	66PLPBH	A6
32PLPBH	A28	61PN	G29	66PTC	E12
32PLPBHP	A34	61PSGN	G29	66RBSV	F16
32PLPDJ	A25	61RB	F16	66VL	F19
32PLPDJB	A24	61RBSG	F16	67PLM	A44
32PLPDRC	A33	61TF	F11	67PLS	A53
32PLPRC	A33	61VL	F18	67RBSG	F16
32PLPSP	A32	62AB	F13	68ALS	E21
32PTC	E7	62ABH	F13	68BJB	A24
37PTCSP	E8	62ANBH	F7	68BJBD	A25
40B-Cabinet	L15	62C	G8	68BJBT	A25
41FL	H8	62CA	G13	68C	G9
41FS	H8	62CABH	G13	68CA	G14
41FX	H8	62CBH	G9	68HB	I10
41IF	H14	62HD	G36	68HB-X-MI	J24
42F	H8	62HDBH	G36	68HB-X-MIX	I10
42IFHD	H14	62NBH	F7	68HD	G37
43F	H8	62NFBH	F7	68LF	A15
46F	H9	62NTA	F7	68LFR	A14
46IFHD	H14	62P	G29, G30	68NTA-X-MI	J24
48F	H9	62PBH	G30	68NTA-X-MIX	F8
48F-X-MI	J24	62PCA	G13, G30	68P	G31
48F-X-MIX	H9	62PCABH	G13, G30	68PLCK	B28

68PLCKI.....	B28	0116.....	G23	165CA.....	G14
68PLM.....	A39	0117.....	J15	165HD.....	G36
68PLMSP.....	A40	0118.....	G22	165PLM.....	A44
68PLPR.....	A7	0119.....	G22, G23	165PLMBH.....	A44
68PLPSP.....	A22	0121.....	J15	165PLP.....	A8
68PLP-X-0.....	A7	122HBL.....	I10	165PLS.....	A52
68PLS.....	A48	122PLMSP.....	A45	165PMT.....	E13
68PLSSP.....	A49	0123.....	I13	165PMTBH.....	E16
68PTC.....	E12	0124.....	G25	166FSV.....	H12
68RB.....	F16	0125.....	G27	0168.....	G27, J16
68RBSG.....	F16	125HB.....	I10	0169.....	J16
68TF.....	F11	125HBL.....	I10	169C.....	G10
68VL.....	F19	125HBLSV.....	I11	169CA.....	G15
69GH.....	J26	126HBL.....	I11	169HB-X-MI.....	J24
70GH.....	J26	0127.....	G27	169HB-X-MIX.....	I12
71GH.....	J26	127HB.....	I11	169HD.....	G37
75GH.....	J26	128HBLSV.....	I11	169LP.....	G33
76RB.....	F16	129HB.....	I11	169P.....	G33
78GH.....	J26	0136.....	I14	169PLM.....	A40, A41
79GH.....	J26	139HB.....	I12	169PLMBJ.....	A45
80GH.....	J26	0142.....	G24	169PLMX.....	A41
81GH.....	J26	0143.....	J14	169PLS.....	A50, A51
82GH.....	J26	0144.....	J14	169PLSX.....	A51
83GH.....	J26	144F.....	H10	169PMT.....	E13
88AC.....	H18	0145.....	J14	169PMTBH.....	E16
88GH.....	J26	145F.....	H10	169PMTL.....	E13
90GH.....	J26	146HBLFSV.....	I12	169PMTNS.....	E13
93-FB-BPD.....	M8	149F.....	H10	169PMTNS-X-M.....	E4, E14
94GH.....	J26	149F-X-MI.....	J24	169PS.....	G33
95GH.....	J27	149F-X-MIX.....	H11	169VL.....	F19
96GH.....	J27	150F.....	H11	170C.....	G11
97HC.....	I10	151F.....	H11	170CA.....	G15
97P.....	G31	0152.....	J14	170HD.....	G37
98GH.....	J27	0155.....	J16	170P.....	G34
98GHSV.....	J27	155F.....	H11	170PMT.....	E14
99GH.....	J27	0158.....	J15	170PMTNS.....	E14
99GHSV.....	J27	159F.....	H11	170VL.....	F20
0101.....	G18, G19	159F-X-MI.....	J24	171C.....	G11
101GHSV.....	J27	159F-X-MIX.....	H12	171CA.....	G15
0102.....	G24	0163.....	J16	171HB.....	I12
102-F-XX-BPD.....	M7	0164.....	J14	171HD.....	G37
0103.....	G22	164C.....	G10	171P.....	G34
0104.....	G24	164CA.....	G14	171PLM.....	A41, A42
0105.....	G18	164HD.....	G36	171PMT.....	E14
0106.....	G23	164P.....	G33	171PMTNS.....	E14
0107.....	G24	164PLM.....	A44	171VL.....	F20
0108.....	G21	164PLP.....	A7	172C.....	G11
0109.....	G20, G21	164PLS.....	A52	172CA.....	G15
0110.....	G25, G27	164PMT.....	E13	172HD.....	G37
0111.....	G25	164VL.....	F19	172P.....	G34
0114.....	G20	165C.....	G10	172PLM.....	A42, A43

172PMT.....	E15	244F.....	H10	364PLP.....	A27
172PMTNS.....	E15	244IFHD.....	H14	364PTC.....	E7
172VL.....	F20	245IFHD.....	H15	365HB.....	C40
174-F-BPD.....	M5	249F.....	H10	365PLP.....	A26, A27
176C.....	G11	249IF.....	H15	365PLPBH.....	A28
176CA.....	G16	250IFHD.....	H15	365PTC.....	E8
177C.....	G11	251IFHD.....	H15	367-FH-BPD.....	M7
177CA.....	G16	252IFHD.....	H15	368-FH-BPD.....	M7
177HD.....	G38	255IFHD.....	H15	368PLP.....	A22
177P.....	G34	255M.....	J12	368PLPD.....	A23
179C.....	G11	256F.....	H12	369PLP.....	A16
179CA.....	G16	259F.....	H11	369PLPBJ.....	A24
179HB.....	I12	259IFHD.....	H15	369PLPBJB.....	A24
179HB-X-MI.....	I13, J24	264AB.....	F13	369PLPO.....	A36
179HD.....	G37	264C.....	G10	369PLPSP.....	A29
179PMT.....	E15	264CA.....	G14	369PLPSPX.....	A30
179PMTNS.....	E15	264NTA.....	F8	369PLPTJ.....	A25
179VL.....	F20	265AB.....	F13	369PLPTJB.....	A24
189PMTR.....	E15	265C.....	G10	369PLPX.....	A17
0191.....	I14	265CA.....	G14	369PTCSP.....	E9
0192.....	J20	265NTA.....	F8	370HB.....	C42
0199.....	G21	269C.....	G10	370PLP.....	A23
207ACBH.....	F14	269CA.....	G15	370PTCR.....	E7
207P.....	J8	269HB.....	I13	371PLP.....	A21
208P.....	J8	269TF.....	F11	371PLPSP.....	A30, A31
209P.....	J8	270AB.....	F14	371PTCSP.....	E9
210P.....	J9	270C.....	G11	372HB.....	C42
211P.....	J9	270CA.....	G15	372PLP.....	A20
212P.....	J9	270NTA.....	F9	372PLPSP.....	A30
213P.....	J9	279HB.....	I13	372PTCSP.....	E9
215PN.....	J9	309P.....	C40	376PLPBJ.....	A25
215PNL.....	J9	313GH.....	C43	377PLP.....	A20
216P.....	J10	316GH.....	C43	377PTC.....	E8
218B-BPD.....	M6	316P.....	C41	379PLP.....	A18
218P.....	J10	318P.....	C40	379PLPSP.....	A30
219P.....	J10	322HB.....	C40	391P.....	G31
0220.....	G27, I7	322PLPSP.....	A32, A33	391PSS.....	G31
220P.....	J10	325GH.....	C43	392P.....	G31
222P.....	J10	325GHSV.....	C43	392PSS.....	G31
222P-X-MI.....	J24	325HB.....	C41	393P.....	G31
222P-X-MIX.....	J14	326HB.....	C41	393PD.....	G32
224.....	I7	328HB.....	C43	393PDSS.....	G32
225.....	I7	329HB.....	C42	393PSS.....	G31
226-BPD.....	M8	347PLP.....	A29	394P.....	G32
228.....	I7	362HB.....	C42	394PD.....	G32
229.....	I7	362PLP.....	A27	394PDSS.....	G32
230.....	I8	362PLPD.....	A28	394PSS.....	G32
231.....	I8	362PLPDSP.....	A31	398P.....	G32
232.....	I8	362PLPSP.....	A31	398PD.....	G33
237.....	I8	362PTC.....	E7	398PDSS.....	G33
238.....	I8	364HB.....	C40	398PSS.....	G32

400-S-TIP.....L6	0690 08.....L10	2202P.....J11
410.....L6	0690 09.....L10	2203P.....J11
410-N.....L6	0690 10.....L10	2205P.....J12
410-S.....L6	0690 11.....L10	2214P.....J12
410-SV.....L6	880AC.....H18	2224P.....J11
411FF.....H14	881AC.....H18	2225P.....J11
411FS.....H14	0900.....J19	2491FHD.....H15
415-N.....L6	901GH.....J27	3000 71 11.....M6
415-S.....L6	0902.....J20	3000 71 11 05.....M6
485F.....H9	0903.....J18	3100.....D6
525-F-BPD.....M8	0904.....J19	3110.....A34
0610.....L11	0905.....J19	3151.....A33
0611.....L12	0906.....J19	3330.....A34
0614.....L12	0907.....J19	4202.....K60
639C.....G11	0908.....J18	4203.....K60
639CA.....G16	0909.....J18	4890.....B30
639F.....H12	0910.....J17	4891.....B30
639PLM.....A45	0911.....J17	4892.....B30
639PLP.....A32, E17	0912.....J17	4895.....B30
639PLS.....A53	0913.....J17	6300.....D8
640F.....H12	0914.....J17	6302.....C11
640QSF.....H18	0915.....J17	6304.....C10
640QSFCR.....H18	0916.....J18	6306.....C10
0652.....L8	0917.....J18	6307.....C13
0653.....L8	0920.....J19	6315.....C7
0655.....L8	0921.....J17	6316.....C7
0656.....L8	0922.....J17	6322.....C13
0657.....L8	0923.....J18	6325.....C8
0660.....B34	0924.....J18	6326.....C13
660FHD.....H12	0927.....J18	6340.....C11
0661.....B34	0928.....J18	6351.....C12
661FHD.....H12	0929.....J15	6366.....C11
664FHD.....H12	0931.....I14	6380.....C13
0670.....L11	945TH-BPD.....M8	6382.....C12
0671.....L11	1163-60-BPD.....J27	6383.....C12, C13
0672.....L12	1163-61-BPD.....J27	6388.....C12
0673.....L11	1200P.....J10	6503.....C9, C10
0674.....L12	1201P.....J12	6505.....C7
0676.....L12	1202P.....J11	6508.....C9
0677.....L11	1203P.....J11	6509.....C8, C9
0682.....L12	1204P.....J11	6521.....C8
682C.....G11	1295HB.....I11	6548.....C13
682CA.....G16	1495F.....H11	6579.....C8
682VL.....F19	1595F.....H12	7800/7801.....B39
0683.....L12	1695HB.....I12	7805/7806.....B39
685HB.....I10	1695VLV.....F20	7810.....B25
685VLV.....F19	1725HB.....I12	7812.....B25
0690 03.....L9	1795HB.....I12	7815.....B25
0690 04.....L9	2200P.....J10	7817.....B25
0690 05.....L9	2200PDE.....J12	7835.....B25
0690 06.....L9	2201P.....J12	7892.....B32

7894.....	B32	EU.....	C19	MR.....	C34
7970.....	B35	F2PMTB.....	E19	MRS.....	C20
7982.....	B35	F3HG.....	J14	MT.....	C34
A613.....	E21	F8UPMTB.....	E19	MTS.....	C21
A614.....	E21	FA.....	C20	MV200.....	K42
A623.....	E21	FC.....	C22	MV308.....	B43
A624.....	E21	FC601.....	B37	MV309.....	B43
ACT-P-X-KIT.....	K53	FC602.....	B37	MV608.....	K42
ACT-SS-X-KIT.....	K53	FC608.....	B37	MV609.....	K42
ADJ-CB.....	L13	FC701.....	B23	MV708.....	K40
AQRT.....	A34, C30, E10, E17	FC702.....	B23	MV709.....	K40
AVC1.....	H17	FC705.....	B23	MVV308.....	B43
AVE1.....	H17	FC708.....	B23	MVV309.....	B43
AVT3.....	H17	FC731.....	B8	NS.....	C35
AVTS.....	H17	FC832.....	B20	NV101F.....	K65
AVTS4.....	H18	FC836.....	B21	NV102F.....	K65
AVTS6.....	H18	FCB832.....	B20	NV103F.....	K65
AVU1.....	H17	FCC731.....	B8	NV104C.....	K65
AVU2.....	H17	FCCB731.....	B9	NV104CA.....	K65
AVU2BH.....	H17	FCCI731.....	B8	NV105C.....	K65
AVUIFI.....	H17	FCCS731.....	B15, B16	NV105CA.....	K65
AVUR3.....	H17	FCCSP731.....	B18	NV106C.....	K66
AVUS.....	H18	FCCSPI731.....	B18	NV106CA.....	K66
AVUS3.....	H18	FCI701.....	B23	NV107P.....	K66
AVUS3BH.....	H17	FCI702.....	B23	NV108P.....	K66
AVUS4D.....	H18	FCK701C.....	B10	NV109P.....	K66
Avuse.....	H17	FCKC731.....	B9	NV311P.....	G34, K66
BG441-NBL.....	L7	FCKCB731.....	B10	NV312P.....	G34, K66
BG442-SBL.....	L7	FCKCI731.....	B10	OR.....	C35
BG443-NBL.....	L7	FCM731.....	B12	PLMC.....	A45, D11
BG444-SBL.....	L7	FCMB731.....	B13	PLPHBF4.....	A7
BU.....	C22	FCMI731.....	B12	PLSC.....	A53, D11
BVC.....	C16, K47	FCMK731.....	B13	Pneu-Cab.....	L15
BVG4PLOCK.....	K57	FCMS731.....	B15	PSB.....	L15
BVGL.....	K55	FCMSI731.....	B16	PSBJ708.....	B41
BVGTL.....	K55	FCMSP731.....	B18	PSBJ731.....	B41
C8UPMTB.....	E19	FCMSPI731.....	B4, B18	PSPE731.....	B41
CAP.....	C24	FCPM832.....	B21	PSPJ731.....	B41
Clip.....	A33	FE.....	C25	PTC-001RB.....	M6
Copper Tubing.....	L15	FF.....	C24	PV607.....	K50
CR-001.....	H18	GR.....	C35	PV608.....	K50
CU.....	C24	HPMTB.....	E19	PV609.....	K50
DC601.....	K68	HV104C.....	K65	PVMB-001.....	K50
DC602.....	K69	HV104C-kit.....	K65	RD.....	C23
DC603.....	K69	JPMTB.....	E19	S8UPMTB.....	E19
DC604.....	K69	LSR-Stand.....	L14	S32633-BPD.....	M5
DC606.....	K69	LV91.....	F22	S75015-BPD.....	M5
DC607.....	K69	MC.....	C19	S75046-BPD.....	M5
DCR601.....	K69	MCVC.....	C27	SAE 010101.....	H8
ERHD.....	E16	ME.....	C23	SAE 010102.....	H9
ES.....	E16	MES.....	C20	SAE 010103.....	H9

SAE 010104.....	H8	SAE 100203 BA.....	F9	V408NTA.....	F22
SAE 010105.....	H12	SAE 100302 BA.....	F9	V409F.....	F22
SAE 010106.....	H12	SAE 100401 BA.....	F8	V410NTA.....	F22
SAE 010107.....	H12	SAE 100424 BA.....	F9	V412F.....	F22
SAE 010108.....	H7	SAE 100425 BA.....	F9	V500CS.....	K31
SAE 010109.....	H12	SAE 120101 BA.....	F13	V500CS-X-04.....	K31
SAE 010110.....	H8	SAE 120102 BA.....	F13	V500CS-X-21.....	K32
SAE 010111.....	H8	SAE 120103 BA.....	F13	V500HP.....	K35
SAE 010112.....	H12	SAE 120111.....	F13	V500P.....	K9
SAE 010113.....	H7	SAE 120115.....	F13	V500P-HB.....	K27
SAE 010114.....	H7	SAE 120201 BA.....	F13	V500P-X-04.....	K10
SAE 010165.....	H7	SAE 120202 BA.....	F14	V500P-X-21.....	K10
SAE 010166.....	H7	SAE 120203 BA.....	F14	V501P.....	K11
SAE 010167.....	H7	SAE 120302 BA.....	F14	V501P-X-04.....	K12
SAE 010201.....	H11	SAE 120401 BA.....	F13	V501P-X-21.....	K12
SAE 010202.....	H10	SAE 120424 BA.....	F14	V501SS.....	K37
SAE 010203.....	H11	SAE 120425 BA.....	F14	V502CS.....	K31
SAE 010302.....	H11	SC.....	C30	V502CS-X-21.....	K32
SAE 010401.....	H10	SPV104C-kit.....	K65	V502P.....	K14
SAE 010424.....	H11	ST.....	C24	V502P-X-04.....	K14
SAE 010425.....	H10	STX-P-1-125.....	K63	V502P-X-ACT.....	K52
SAE 040101.....	H14	STX-P-1-225.....	K63	V502P-X-SUB.....	K53
SAE 040102.....	H14	SV404P.....	F22	V502SS.....	K39
SAE 040103.....	H14	TAF.....	C24	V502SS-X-20.....	K39
SAE 040110.....	H14	TC-1000-BPD.....	M5	V502SS-X-21.....	K39
SAE 040202.....	H15	TC-1050-BPD.....	M5	V502SS-X-ACT.....	K52
SAE 040203.....	H15	TCB.....	C24	V502SS-X-SUB.....	K53
SAE 040302.....	H15	TEB.....	C25	V506CS.....	K33
SAE 040401.....	H14	TEU.....	C23	V506HP.....	K36
SAE 040424.....	H15	TFA.....	C24	V506P.....	K16
SAE 040425.....	H15	TMC.....	C22	V509P.....	K17
SAE 040427.....	H15	TPL.....	C25	V510P.....	K19
SAE 060101 BA.....	G8	TS.....	C30	V510P-X-04.....	K19
SAE 060102 BA.....	G9	TSC.....	C26, D10	V510P-X-21.....	K19
SAE 060103 BA.....	G9	TU.....	C19	V533P.....	K24
SAE 060110.....	G8	UC.....	C21	V540P.....	K24
SAE 060111.....	G8	US5.....	H7	V590P.....	K26
SAE 060115.....	G8	V203F.....	K68	V590P-X-04.....	K26
SAE 060201 BA.....	G10	V204F.....	K68	V591P.....	K26
SAE 060202 BA.....	G10	V303C.....	K68	V591P-X-04.....	K26
SAE 060203 BA.....	G11	V303CA.....	K68	V600P.....	K29
SAE 060401 BA.....	G10	V304C.....	K68	V633P.....	K29
SAE 060424 BA.....	G11	V304CA.....	K68	VAS.....	C16, K6, K45
SAE 060425 BA.....	G11	V401P.....	K68	VC.....	B28, C27
SAE 100101 BA.....	F7	V402P.....	K68	VC-001.....	H18
SAE 100102 BA.....	F8	V403P.....	K68	VEUC15, C29, C15, C15, K6, K44, K46, K48	
SAE 100103 BA.....	F8	V404P.....	F22	VFC.....	C29, C27, , C36, C15, K6, K45, K46, K48
SAE 100110.....	F7	V404PH.....	F22	VFEC28, C26, C37, C15, K6, K44, K45, K47, K48	
SAE 100115.....	F7	V405P.....	F22	V406P.....	K68
SAE 100201 BA.....	F8	V406P.....	K68	V407P.....	K68
SAE 100202 BA.....	F9	V407P.....	K68	VMC.....	C29, C27, C36, C15, K6, K45, K46,

K47, K48	W369PLPTJ.....A25
VME.....C14, C28, C37, C44, K6, K44, K45,	W369PLPXA17
K47, K48	W371PLP..... A20, A21
VP500CSK31	W372PLP..... A18, A19
VP500HPK35	W379PLP..... A17, A18
VP500P.....K9	WY.....C21
VP501P.....K12	
VP502CSK31	
VP502P.....K14	
VP502SSK39	
VP506HPK36	
VP510P.....K19	
VS68AB F13	
VS68NTA F8	
VS68PTCR..... E4	
VS176NTA F8	
VS269AB F14	
VS269NTA F9	
VS271AB F14	
VS271NTA F9	
VS272AB F14	
VS272NTA F9	
VS279AB F14	
VS279NTA F9	
VS368PTCR.....E8	
VS369PTCR.....E7	
VS371PTCR.....E8	
VS372PTCR.....E8	
VTEU C30, K6, K46	
VUC.....C29, C14, C14, K6, K44, K46,	
K47, K48	
VUCPBC16, C44, K6, K45, K47	
VV500P.....K9	
VV501P.....K12	
VV502P.....K14	
VVP500PK9	
VVP501PK12	
VVP502PK14	
W68LF A13, A14	
W68PLCK.....B27	
W68PLCKI.....B27	
W68PLP.....A6	
W68PLPSP.....A21	
W169PLP.....A8	
W169PLPNS.....A8	
W171PLP.....A8	
W172PLP.....A9	
W368PLP.....A22	
W369PLP..... A15, A16	
W369PLPBJA23	
W369PLPO..... , A36, A11	

Parker Safety Guide for Selecting and Using Hose, Tubing, Fittings, Connectors, Conductors, Valves and Related Accessories

Parker Publication No. 4400-B.1

WARNING: Failure or improper selection or improper use of hose, tubing, fittings, assemblies, valves, connectors, conductors or related accessories ("Products") can cause death, personal injury and property damage. Possible consequences of failure or improper selection or improper use of these Products include but are not limited to:

- Fittings thrown off at high speed.
- High velocity fluid discharge.
- Explosion or burning of the conveyed fluid.
- Electrocutation from high voltage electric powerlines.
- Contact with suddenly moving or falling objects that are controlled by the conveyed fluid.
- Injections by high-pressure fluid discharge.
- Dangerously whipping Hose.
- Tube or pipe burst.
- Weld joint fracture.
- Contact with conveyed fluids that may be hot, cold, toxic or otherwise injurious.
- Sparking or explosion caused by static electricity buildup or other sources of electricity.
- Sparking or explosion while spraying paint or flammable liquids.
- Injuries resulting from inhalation, ingestion or exposure to fluids.

Before selecting or using any of these Products, it is important that you read and follow the instructions below. No product from any division in Fluid Connector Group is approved for in-flight aerospace applications. For hoses and fittings used in in-flight aerospace applications, please contact Parker Aerospace Group

GENERAL INSTRUCTIONS

- 1.0 Scope:** This safety guide provides instructions for selecting and using (including assembling, installing, and maintaining) these Products. For convenience, all rubber and/or thermoplastic products commonly called "hose" or "tubing" are called "Hose" in this safety guide. Metallic tube or pipe are called "tube". All assemblies made with Hose are called "Hose Assemblies". All assemblies made with Tube are called "Tube Assemblies". All products commonly called "fittings", "couplings" or "adapters" are called "Fittings". Valves are fluid system components that control the passage of fluid. Related accessories are ancillary devices that enhance or monitor performance including crimping, flaring, flanging, presetting, bending, cutting, deburring, swaging machines, sensors, tags, lockout handles, spring guards and associated tooling. This safety guide is a supplement to and is to be used with the specific Parker publications for the specific Hose, Fittings and Related Accessories that are being considered for use. Parker publications are available at www.parker.com. SAE J1273 (www.sae.org) and ISO 17165-2 (www.ansi.org) also provide recommended practices for hydraulic Hose Assemblies, and should be followed.
- 1.1 Fail-Safe:** Hose, Hose Assemblies, Tube, Tube Assemblies and Fittings can and do fail without warning for many reasons. Design all systems and equipment in a fail-safe mode, so that failure of the Hose, Hose Assembly, Tube, Tube Assembly or Fitting will not endanger persons or property.
- 1.2 Distribution:** Provide a copy of this safety guide to each person responsible for selecting or using Hose, Tube and Fitting products. Do not select or use Parker Hose, Tube or Fittings without thoroughly reading and understanding this safety guide as well as the specific Parker publications for the Products.
- 1.3 User Responsibility:** Due to the wide variety of operating conditions and applications for Hose, Tube and Fittings. Parker does not represent or warrant that any particular Hose, Tube or Fitting is suitable for any specific end use system. This safety guide does not analyze all technical parameters that must be considered in selecting a product. The user, through its own analysis and testing, is solely responsible for:
- Making the final selection of the Products.
 - Assuring that the user's requirements are met and that the application presents no health or safety hazards.
 - Following the safety guide for Related Accessories and being trained to operate Related Accessories.
 - Providing all appropriate health and safety warnings on the equipment on which the Products are used.
 - Assuring compliance with all applicable government and industry standards.
- 1.4 Additional Questions:** Call the appropriate Parker technical service department if you have any questions or require any additional information. See the Parker publication for the Products being considered or used, or call 1-800-CPARKER, or go to www.parker.com, for telephone numbers of the appropriate technical service department.

2.0 HOSE, TUBE AND FITTINGS SELECTION INSTRUCTIONS

- 2.1 Electrical Conductivity:** Certain applications require that the Hose be nonconductive to prevent electrical current flow. Other applications require the Hose and the Fittings and the Hose/Fitting interface to be sufficiently conductive to drain off static electricity. Extreme care must be exercised when selecting Hose, Tube and Fittings for these or any other applications in which electrical conductivity or nonconductivity is a factor.
- The electrical conductivity or nonconductivity of Hose, Tube and Fittings is dependent upon many factors and may be susceptible to change. These factors include but are not limited to the various materials used to make the Hose and the Fittings, Fitting finish (some Fitting finishes are electrically conductive while others are nonconductive), manufacturing methods (including moisture control), how the Fittings contact the Hose, age and amount of deterioration or damage or other changes, moisture content of the Hose at any particular time, and other factors.
- The following are considerations for electrically nonconductive and conductive Hose. For other applications consult the individual catalog pages and the appropriate industry or regulatory standards for proper selection.
- 2.1.1 Electrically Nonconductive Hose:** Certain applications require that the Hose be nonconductive to prevent electrical current flow or to maintain

electrical isolation. For applications that require Hose to be electrically nonconductive, including but not limited to applications near high voltage electric lines, only special nonconductive Hose can be used. The manufacturer of the equipment in which the nonconductive Hose is to be used must be consulted to be certain that the Hose, Tube and Fittings that are selected are proper for the application. Do not use any Parker Hose or Fittings for any such application requiring nonconductive Hose, including but not limited to applications near high voltage electric lines or dense magnetic fields, unless (i) the application is expressly approved in the Parker technical publication for the product, (ii) the Hose is marked "nonconductive", and (iii) the manufacturer of the equipment on which the Hose is to be used specifically approves the particular Parker Hose, Tube and Fittings for such use.

- 2.1.2 Electrically Conductive Hose:** Parker manufactures special Hose for certain applications that require electrically conductive Hose. Parker manufactures special Hose for conveying paint in airless paint spraying applications. This Hose is labeled "Electrically Conductive Airless Paint Spray Hose" on its layline and packaging. This Hose must be properly connected to the appropriate Parker Fittings and properly grounded in order to dissipate dangerous static charge buildup, which occurs in all airless paint spraying applications. Do not use any other Hose for airless paint spraying, even if electrically conductive. Use of any other Hose or failure to properly connect the Hose can cause a fire or an explosion resulting in death, personal injury, and property damage. All hoses that convey fuels must be grounded. Parker manufactures a special Hose for certain compressed natural gas ("CNG") applications where static electricity buildup may occur. Parker CNG Hose assemblies comply with the requirements of ANSI/IAS NGV 4.2; CSA 12.52, "Hoses for Natural Gas Vehicles and Dispensing Systems" (www.ansi.org). This Hose is labeled "Electrically Conductive for CNG Use" on its layline and packaging. This Hose must be properly connected to the appropriate Parker Fittings and properly grounded in order to dissipate dangerous static charge buildup, which occurs in, for example, high velocity CNG dispensing or transfer. Do not use any other Hose for CNG applications where static charge buildup may occur, even if electrically conductive. Use of other Hoses in CNG applications or failure to properly connect or ground this Hose can cause a fire or an explosion resulting in death, personal injury, and property damage. Care must also be taken to protect against CNG permeation through the Hose wall. See section 2.6, Permeation, for more information. Parker CNG Hose is intended for dispenser and vehicle use within the specified temperature range. Parker CNG Hose should not be used in confined spaces or unventilated areas or areas exceeding the specified temperature range. Final assemblies must be tested for leaks. CNG Hose Assemblies should be tested on a monthly basis for conductivity per ANSI/IAS NGV 4.2; CSA 12.52. Parker manufactures special Hose for aerospace in-flight applications. Aerospace in-flight applications employing Hose to transmit fuel, lubricating fluids and hydraulic fluids require a special Hose with a conductive inner tube. This Hose for in-flight applications is available only from Parker's Stratoflex Products Division. Do not use any other Parker Hose for in-flight applications, even if electrically conductive. Use of other Hoses for in-flight applications or failure to properly connect or ground this Hose can cause a fire or an explosion resulting in death, personal injury and property damage. These Hose assemblies for in-flight applications must meet all applicable aerospace industry, aircraft engine and aircraft requirements.
- 2.2 Pressure:** Hose, Tube and Fitting selection must be made so that the published maximum working pressure of the Hose, Tube and Fittings are equal to or greater than the maximum system pressure. The maximum working pressure of a Hose, or Tube Assembly is the lower of the respective published maximum working pressures of the Hose, Tube and the Fittings used. Surge pressures or peak transient pressures in the system must be below the published maximum working pressure for the Hose, Tube and Fitting. Surge pressures and peak pressures can usually only be determined by sensitive electrical instrumentation that measures and indicates pressures at millisecond intervals. Mechanical pressure gauges indicate only average pressures and cannot be used to determine surge pressures or peak transient pressures. Published burst pressure ratings for Hose is for manufacturing test purposes only and is no indication that the Product can be used in applications at the burst pressure or otherwise above the published maximum recommended working pressure.

- 2.3 Suction:** Hoses used for suction applications must be selected to insure that the Hose will withstand the vacuum and pressure of the system. Improperly selected Hose may collapse in suction application.
- 2.4 Temperature:** Be certain that fluid and ambient temperatures, both steady and transient, do not exceed the limitations of the Hose, Tube, Fitting and Seals. Temperatures below and above the recommended limit can degrade Hose, Tube, Fittings and Seals to a point where a failure may occur and release fluid. Tube and Fittings performances are normally degraded at elevated temperature. Material compatibility can also change at temperatures outside of the rated range. Properly insulate and protect the Hose Assembly when routing near hot objects (e.g. manifolds). Do not use any Hose in any application where failure of the Hose could result in the conveyed fluids (or vapors or mist from the conveyed fluids) contacting any open flame, molten metal, or other potential fire ignition source that could cause burning or explosion of the conveyed fluids or vapors.
- 2.5 Fluid Compatibility:** Hose, and Tube Assembly selection must assure compatibility of the Hose tube, cover, reinforcement, Tube, Plating and Seals with the fluid media used. See the fluid compatibility chart in the Parker publication for the product being considered or used. This information is offered only as a guide. Actual service life can only be determined by the end user by testing under all extreme conditions and other analysis. Hose, and Tube that is chemically compatible with a particular fluid must be assembled using Fittings and adapters containing likewise compatible seals. Flange or flare processes can change Tube material properties that may not be compatible with certain requirements such as NACE
- 2.6 Permeation:** Permeation (that is, seepage through the Hose or Seal) will occur from inside the Hose or Fitting to outside when Hose or Fitting is used with gases, liquid and gas fuels, and refrigerants (including but not limited to such materials as helium, diesel fuel, gasoline, natural gas, or LPG). This permeation may result in high concentrations of vapors which are potentially flammable, explosive, or toxic, and in loss of fluid. Dangerous explosions, fires, and other hazards can result when using the wrong Hose for such applications. The system designer must take into account the fact that this permeation will take place and must not use Hose or Fitting if this permeation could be hazardous. The system designer must take into account all legal, government, insurance, or any other special regulations which govern the use of fuels and refrigerants. Never use a Hose or Fitting even though the fluid compatibility is acceptable without considering the potential hazardous effects that can result from permeation through the Hose or Tube Assembly. Permeation of moisture from outside the Hose or Fitting to inside the Hose or Fitting will also occur in Hose or Tube assemblies, regardless of internal pressure. If this moisture permeation would have detrimental effects (particularly, but not limited to refrigeration and air conditioning systems), incorporation of sufficient drying capacity in the system or other appropriate system safeguards should be selected and used. The sudden pressure release of highly pressurized gas could also result in Explosive Decompression failure of permeated Seals and Hoses.
- 2.7 Size:** Transmission of power by means of pressurized fluid varies with pressure and rate of flow. The size of the components must be adequate to keep pressure losses to a minimum and avoid damage due to heat generation or excessive fluid velocity.
- 2.8 Routing:** Attention must be given to optimum routing to minimize inherent problems (kinking or flow restriction due to Hose collapse, twisting of the Hose, proximity to hot objects or heat sources). For additional routing recommendations see SAE J1273 and ISO 17165-2. Hose Assemblies have a finite life and should be installed in a manner that allows for ease of inspection and future replacement. Hose because of its relative short life, should not be used in residential and commercial buildings inside of inaccessible walls or floors, unless specifically allowed in the product literature. Always review all product literature for proper installation and routing instructions.
- 2.9 Environment:** Care must be taken to insure that the Hose, Tube and Fittings are either compatible with or protected from the environment (that is, surrounding conditions) to which they are exposed. Environmental conditions including but not limited to ultraviolet radiation, sunlight, heat, ozone, moisture, water, salt water, chemicals and air pollutants can cause degradation and premature failure.
- 2.10 Mechanical Loads:** External forces can significantly reduce Hose, Tube and Fitting life or cause failure. Mechanical loads which must be considered include excessive flexing, twist, kinking, tensile or side loads, bend radius, and vibration. Use of swivel type Fittings or adapters may be required to insure no twist is put into the Hose. Use of proper Hose or Tube clamps may also be required to reduce external mechanical loads. Unusual applications may require special testing prior to Hose selection.
- 2.11 Physical Damage:** Care must be taken to protect Hose from wear, snagging, kinking, bending smaller than minimum bend radius and cutting, any of which can cause premature Hose failure. Any Hose that has been kinked or bent to a radius smaller than the minimum bend radius, and any Hose that has been cut or is cracked or is otherwise damaged should be removed and discarded. Fittings with damages such as scratches on sealing surfaces and deformation should be replaced.
- 2.12 Proper End Fitting:** See instructions 3.2 through 3.5. These recommendations may be substantiated by testing to industry standards such as SAE J517 for hydraulic applications, or MIL-A-5070, AS1339, or AS3517 for Hoses from Parker's Stratoflex Products Division for aerospace applications.
- 2.13 Length:** When determining the proper Hose or Tube length of an assembly, be aware of Hose length change due to pressure, Tube length change due to thermal expansion or contraction, and Hose or Tube and machine tolerances and movement must be considered. When routing short hose assemblies, it is recommended that the minimum free hose length is always used. Consult the hose manufacturer for their minimum free hose length recommendations. Hose assemblies should be installed in such a way that any motion or flexing occurs within the same plane.
- 2.14 Specifications and Standards:** When selecting Hose, Tube and Fittings, government, industry, and Parker specifications and recommendations must be reviewed and followed as applicable.
- 2.15 Hose Cleanliness:** Hose and Tube components may vary in cleanliness levels. Care must be taken to insure that the Hose and Tube Assembly selected has an adequate level of cleanliness for the application.
- 2.16 Fire Resistant Fluids:** Some fire resistant fluids that are to be conveyed by Hose or Tube require use of the same type of Hose or Tube as used with petroleum base fluids. Some such fluids require a special Hose, Tube, Fitting and Seal, while a few fluids will not work with any Hose at all. See instructions 2.5 and 1.5. The wrong Hose, Tube, Fitting or Seal may fail after a very short service. In addition, all liquids but pure water may burn fiercely under certain conditions, and even pure water leakage may be hazardous.
- 2.17 Radiant Heat:** Hose and Seals can be heated to destruction without contact by such nearby items as hot manifolds or molten metal. The same heat source may then initiate a fire. This can occur despite the presence of cool air around the Hose or Seal. Performance of Tube and Fitting subjected to the heat could be degraded.
- 2.18 Welding or Brazing:** When using a torch or arc welder in close proximity to hydraulic lines, the hydraulic lines should be removed or shielded with appropriate fire resistant materials. Flame or weld spatter could burn through the Hose or Seal and possibly ignite escaping fluid resulting in a catastrophic failure. Heating of plated parts, including Hose Fittings and adapters, above 450°F (232°C) such as during welding, brazing or soldering may emit deadly gases. Any elastomer seal on fittings shall be removed prior to welding or brazing, any metallic surfaces shall be protected after brazing or welding when necessary. Welding and brazing filler material shall be compatible with the Tube and Fitting that are joined.
- 2.19 Atomic Radiation:** Atomic radiation affects all materials used in Hose and Tube assemblies. Since the long-term effects may be unknown, do not expose Hose or Tube assemblies to atomic radiation. Nuclear applications may require special Tube and Fittings.
- 2.20 Aerospace Applications:** The only Hose, Tube and Fittings that may be used for in-flight aerospace applications are those available from Parker's Stratoflex Products Division. Do not use any other Hose or Fittings for in-flight applications. Do not use any Hose or Fittings from Parker's Stratoflex Products Division with any other Hose or Fittings, unless expressly approved in writing by the engineering manager or chief engineer of Stratoflex Products Division and verified by the user's own testing and inspection to aerospace industry standards.
- 2.21 Unlocking Couplings:** Ball locking couplings or other Fittings with quick disconnect ability can unintentionally disconnect if they are dragged over obstructions, or if the sleeve or other disconnect member, is bumped or moved enough to cause disconnect. Threaded Fittings should be considered where there is a potential for accidental uncoupling.
- 3.0 HOSE AND FITTINGS ASSEMBLY AND INSTALLATION INSTRUCTIONS**
- 3.1 Component Inspection:** Prior to assembly, a careful examination of the Hose and Fittings must be performed. All components must be checked for correct style, size, catalog number, and length. The Hose must be examined for cleanliness, obstructions, blisters, cover looseness, kinks, cracks, cuts or any other visible defects. Inspect the Fitting and sealing surfaces for burrs, nicks, corrosion or other imperfections. Do NOT use any component that displays any signs of nonconformance.
- 3.2 Hose and Fitting Assembly:** Do not assemble a Parker Fitting on a Parker Hose that is not specifically listed by Parker for that Fitting, unless authorized in writing by the engineering manager or chief engineer of the appropriate Parker division. Do not assemble a Parker Fitting on another manufacturer's Hose or a Parker Hose on another manufacturer's Fitting unless (i) the engineering manager or chief engineer of the appropriate Parker division approves the Assembly in writing or that combination is expressly approved in the appropriate Parker literature for the specific Parker product, and (ii) the user verifies the Assembly and the application through analysis and testing. For Parker Hose that does not specify a Parker Fitting, the user is solely responsible for the selection of the proper Fitting and Hose Assembly procedures. See instruction 1.4. To prevent the possibility of problems such as leakage at the Fitting or system contamination, it is important to completely remove all debris from the cutting operation before installation of the Fittings. The Parker published instructions must be followed for assembling the Fittings on the Hose. These instructions are provided in the Parker Fitting catalog for the specific Parker Fitting being used, or by calling 1-800-CPARKER, or at www.parker.com.
- 3.3 Related Accessories:** Do not crimp or swage any Parker Hose or Fitting with anything but the listed swage or crimp machine and dies in accordance with Parker published instructions. Do not crimp or swage another manufacturer's Fitting with a Parker crimp or swage die unless authorized in writing by the engineering manager or chief engineer of the appropriate Parker division.
- 3.4 Parts:** Do not use any Parker Fitting part (including but not limited to socket, shell, nipple, or insert) except with the correct Parker mating parts, in accordance with Parker published instructions, unless authorized in writing by the engineering manager or chief engineer of the appropriate Parker division.
- 3.5 Field Attachable/Permanent:** Do not reuse any field attachable Hose Fitting that has blown or pulled off a Hose. Do not reuse a Parker permanent Hose Fitting (crimped or swaged) or any part thereof. Complete Hose Assemblies may only be reused after proper inspection under section 4.0. Do not assemble Fittings to any previously used hydraulic Hose that was in service, for use in a fluid power application.
- 3.6 Pre-Installation Inspection:** Prior to installation, a careful examination of the Hose Assembly must be performed. Inspect the Hose Assembly for any damage or defects. DO NOT use any Hose Assembly that displays any signs of nonconformance.
- 3.7 Minimum Bend Radius:** Installation of a Hose at less than the minimum listed bend radius may significantly reduce the Hose life. Particular attention must be given to preclude sharp bending at the Hose to Fitting juncture. Any bending during installation at less than the minimum bend radius must be avoided. If any Hose is kinked during installation, the Hose must be discarded.
- 3.8 Twist Angle and Orientation:** Hose Assembly installation must be such that relative motion of machine components does not produce twisting.
- 3.9 Securement:** In many applications, it may be necessary to restrain, protect, or guide the Hose to protect it from damage by unnecessary flexing, pressure surges, and contact with other mechanical components. Care must be taken to insure such restraints do not introduce additional stress or wear points.
- 3.10 Proper Connection of Ports:** Proper physical installation of the Hose Assembly

requires a correctly installed port connection insuring that no twist or torque is transferred to the Hose when the Fittings are being tightened or otherwise during use.

- 3.11 **External Damage:** Proper installation is not complete without insuring that tensile loads, side loads, kinking, flattening, potential abrasion, thread damage or damage to sealing surfaces are corrected or eliminated. See instruction 2.10.
- 3.12 **System Checkout:** All air entrapment must be eliminated and the system pressurized to the maximum system pressure (at or below the Hose maximum working pressure) and checked for proper function and freedom from leaks. Personnel must stay out of potential hazardous areas while testing and using.
- 3.13 **Routing:** The Hose Assembly should be routed in such a manner so if a failure does occur, the escaping media will not cause personal injury or property damage. In addition, if fluid media comes in contact with hot surfaces, open flame or sparks, a fire or explosion may occur. See section 2.4.
- 3.14 **Ground Fault Equipment Protection Devices (GFEPDs):** **WARNING!** Fire and Shock Hazard. To minimize the danger of fire if the heating cable of a Multitube bundle is damaged or improperly installed, use a Ground Fault Equipment Protection Device. Electrical fault currents may be insufficient to trip a conventional circuit breaker. For ground fault protection, the IEEE 515: (www.ansi.org) standard for heating cables recommends the use of GFEPDs with a nominal 30 milliampere trip level for "piping systems in classified areas, those areas requiring a high degree of maintenance, or which may be exposed to physical abuse or corrosive atmospheres".

4.0 TUBE AND FITTINGS ASSEMBLY AND INSTALLATION INSTRUCTIONS

- 4.1 **Component Inspection:** Prior to assembly, a careful examination of the Tube and Fittings must be performed. All components must be checked for correct style, size, material, seal, and length. Inspect the Fitting and sealing surfaces for burrs, nicks, corrosion, missing seal or other imperfections. Do NOT use any component that displays any signs of nonconformance.
- 4.2 **Tube and Fitting Assembly:** Do not assemble a Parker Fitting with a Tube that is not specifically listed by Parker for that Fitting, unless authorized in writing by the engineering manager or chief engineer of the appropriate Parker division. The Tube must meet the requirements specified to the Fitting. The Parker published instructions must be followed for assembling the Fittings to a Tube. These instructions are provided in the Parker Fitting catalog for the specific Parker Fitting being used, or by calling 1-800-CPARKER, or at www.parker.com.
- 4.3 **Related Accessories:** Do not preset or flange Parker Fitting components using another manufacturer's equipment or procedures unless authorized in writing by the engineering manager or chief engineer of the appropriate Parker division. Tube, Fitting component and tooling must be checked for correct style, size and material. Operation and maintenance of Related Accessories must be in accordance with the operation manual for the designated Accessory.
- 4.4 **Securement:** In many applications, it may be necessary to restrain, protect, or guide the Tube to protect it from damage by unnecessary flexing, pressure surges, vibration, and contact with other mechanical components. Care must be taken to insure such restraints do not introduce additional stress or wear points.
- 4.5 **Proper Connection of Ports:** Proper physical installation of the Tube Assembly requires a correctly installed port connection insuring that no torque is transferred to the Tube when the Fittings are being tightened or otherwise during use.
- 4.6 **External Damage:** Proper installation is not complete without insuring that tensile loads, side loads, flattening, potential abrasion, thread damage or damage to sealing surfaces are corrected or eliminated. See instruction 2.10.
- 4.7 **System Checkout:** All air entrapment must be eliminated and the system pressurized to the maximum system pressure (at or below the Tube Assembly maximum working pressure) and checked for proper function and freedom from leaks. Personnel must stay out of potential hazardous areas while testing and using.
- 4.8 **Routing:** The Tube Assembly should be routed in such a manner so if a failure does occur, the escaping media will not cause personal injury or property damage. In addition, if fluid media comes in contact with hot surfaces, open flame or sparks, a fire or explosion may occur. See section 2.4.

5.0 HOSE AND FITTING MAINTENANCE AND REPLACEMENT INSTRUCTIONS

- 5.1 Even with proper selection and installation, Hose life may be significantly reduced without a continuing maintenance program. The severity of the application, risk potential from a possible Hose failure, and experience with any Hose failures in the application or in similar applications should determine the frequency of the inspection and the replacement for the Products so that Products are replaced before any failure occurs. Certain products require maintenance and inspection per industry requirements. Failure to adhere to these requirements may lead to premature failure. A maintenance program must be established and followed by the user and, at minimum, must include instructions 5.2 through 5.7
- 5.2 **Visual Inspection Hose/Fitting:** Any of the following conditions require immediate shut down and replacement of the Hose Assembly:
- Fitting slippage on Hose;
 - Damaged, cracked, cut or abraded cover (any reinforcement exposed);
 - Hard, stiff, heat cracked, or charred Hose;
 - Cracked, damaged, or badly corroded Fittings;
 - Leaks at Fitting or in Hose;
 - Kinked, crushed, flattened or twisted Hose; and
 - Blistered, soft, degraded, or loose cover.
- 5.3 **Visual Inspection All Other:** The following items must be tightened, repaired, corrected or replaced as required:
- Leaking port conditions;
 - Excess dirt buildup;
 - Worn clamps, guards or shields; and
 - System fluid level, fluid type, and any air entrapment.
- 5.4 **Functional Test:** Operate the system at maximum operating pressure and check for possible malfunctions and leaks. Personnel must avoid potential hazardous areas while testing and using the system. See section 2.2.
- 5.5 **Replacement Intervals:** Hose assemblies and elastomeric seals used on Hose Fittings and adapters will eventually age, harden, wear and deteriorate under thermal cycling and compression set. Hose Assemblies and elastomeric seals

- should be inspected and replaced at specific replacement intervals, based on previous service life, government or industry recommendations, or when failures could result in unacceptable downtime, damage, or injury risk. See section 1.2. Hose and Fittings may be subjected to internal mechanical and/or chemical wear from the conveying fluid and may fail without warning. The user must determine the product life under such circumstances by testing. Also see section 2.5.
- 5.6 **Hose Inspection and Failure:** Hydraulic power is accomplished by utilizing high pressure fluids to transfer energy and do work. Hoses, Fittings and Hose Assemblies all contribute to this by transmitting fluids at high pressures. Fluids under pressure can be dangerous and potentially lethal and, therefore, extreme caution must be exercised when working with fluids under pressure and handling the Hoses transporting the fluids. From time to time, Hose Assemblies will fail if they are not replaced at proper time intervals. Usually these failures are the result of some form of misapplication, abuse, wear or failure to perform proper maintenance. When Hoses fail, generally the high pressure fluids inside escape in a stream which may or may not be visible to the user. Under no circumstances should the user attempt to locate the leak by "feeling" with their hands or any other part of their body. High pressure fluids can and will penetrate the skin and cause severe tissue damage and possibly loss of limb. Even seemingly minor hydraulic fluid injection injuries must be treated immediately by a physician with knowledge of the tissue damaging properties of hydraulic fluid. If a Hose failure occurs, immediately shut down the equipment and leave the area until pressure has been completely released from the Hose Assembly. Simply shutting down the hydraulic pump may or may not eliminate the pressure in the Hose Assembly. Many times check valves, etc., are employed in a system and can cause pressure to remain in a Hose Assembly even when pumps or equipment are not operating. Tiny holes in the Hose, commonly known as pinholes, can eject small, dangerously powerful but hard to see streams of hydraulic fluid. It may take several minutes or even hours for the pressure to be relieved so that the Hose Assembly may be examined safely. Once the pressure has been reduced to zero, the Hose Assembly may be taken off the equipment and examined. It must always be replaced if a failure has occurred. Never attempt to patch or repair a Hose Assembly that has failed. Consult the nearest Parker distributor or the appropriate Parker division for Hose Assembly replacement information. Never touch or examine a failed Hose Assembly unless it is obvious that the Hose no longer contains fluid under pressure. The high pressure fluid is extremely dangerous and can cause serious and potentially fatal injury.
- 5.7 **Elastomeric seals:** Elastomeric seals will eventually age, harden, wear and deteriorate under thermal cycling and compression set. Elastomeric seals should be inspected and replaced.
- 5.8 **Refrigerant gases:** Special care should be taken when working with refrigeration systems. Sudden escape of refrigerant gases can cause blindness if the escaping gases contact the eye and can cause freezing or other severe injuries if it contacts any other portion of the body.
- 5.9 **Compressed natural gas (CNG):** Parker CNG Hose Assemblies should be tested after installation and before use, and at least on a monthly basis per instructions provided on the Hose Assembly tag. The recommended procedure is to pressurize the Hose and check for leaks and to visually inspect the Hose for damage and to perform an electrical resistance test. Caution: Matches, candles, open flame or other sources of ignition shall not be used for Hose inspection. Leak check solutions should be rinsed off after use.
- #### 6.0 HOSE STORAGE
- 6.1 **Age Control:** Hose and Hose Assemblies must be stored in a manner that facilitates age control and first-in and first-out usage based on manufacturing date of the Hose and Hose Assemblies. Unless otherwise specified by the manufacturer or defined by local laws and regulations:
- 6.1.1 The shelf life of rubber hose in bulk form or hose made from two or more materials is 28 quarters (7 years) from the date of manufacture, with an extension of 12 quarters (3 years), if stored in accordance with ISO 22303;
- 6.1.2 The shelf life of thermoplastic and polytetrafluoroethylene hose is considered to be unlimited;
- 6.1.3 Hose assemblies that pass visual inspection and proof test shall not be stored for longer than 2 years.
- 6.1.4 **Storage:** Stored Hose and Hose Assemblies must not be subjected to damage that could reduce their expected service life and must be placed in a cool, dark and dry area with the ends capped. Stored Hose and Hose Assemblies must not be exposed to temperature extremes, ozone, oils, corrosive liquids or fumes, solvents, high humidity, rodents, insects, ultraviolet light, electromagnetic fields or radioactive materials.

PARKER-HANNIFIN CORPORATION OFFER OF SALE

1. **Definitions.** As used herein, the following terms have the meanings indicated.

- Buyer: means any customer receiving a Quote for Products.
- Goods: means any tangible part, system or component to be supplied by Seller.
- Products: means the Goods, Services and/or Software as described in a Quote.
- Quote: means the offer or proposal made by Seller to Buyer for the supply of Products.
- Seller: means Parker-Hannifin Corporation, including all divisions and businesses thereof.
- Services: means any services to be provided by Seller.
- Software: means any software related to the Goods, whether embedded or separately downloaded.
- Terms: means the terms and conditions of this Offer of Sale.

2. **Terms.** All sales of Products by Seller are expressly conditioned upon, and will be governed by the acceptance of, these Terms. These Terms are incorporated into any Quote provided by Seller to Buyer. Buyer's order for any Products whether communicated to Seller verbally, in writing, by electronic data interface or other electronic commerce, shall constitute acceptance of these Terms. Seller objects to any contrary or additional terms or conditions of Buyer. Reference in Seller's order acknowledgement to Buyer's purchase order or purchase order number shall in no way constitute an acceptance of any of Buyer's terms or conditions of purchase. No modification to these Terms will be binding on Seller unless agreed to in writing and signed by an authorized representative of Seller.

3. **Price; Payment.** The Products set forth in the Quote are offered for sale at the prices indicated in the Quote. Unless otherwise specifically stated in the Quote, prices are valid for thirty (30) days and do not include any sales, use, or other taxes or duties. Seller reserves the right to modify prices at any time to adjust for any raw material price fluctuations. Unless otherwise specified by Seller, all prices are F.C.A. Seller's facility (INCOTERMS 2020). All sales are contingent upon credit approval and full payment for all purchases is due thirty (30) days from the date of invoice (or such date as may be specified in the Quote). Unpaid invoices beyond the specified payment date incur interest at the rate of 1.5% per month or the maximum allowable rate under applicable law.

4. **Shipment; Delivery; Title and Risk of Loss.** All delivery dates are approximate, and Seller is not responsible for damages resulting from any delay. Regardless of the manner of shipment, delivery occurs and title and risk of loss or damage pass to Buyer, upon placement of the Products with the carrier at Seller's facility. Unless otherwise agreed prior to shipment and for domestic delivery locations only, Seller will select and arrange, at Buyer's sole expense, the carrier and means of delivery. When Seller selects and arranges the carrier and means of delivery, freight and insurance costs for shipment to the designated delivery location will be prepaid by Seller and added as a separate line item to the invoice. Buyer shall be responsible for any additional shipping charges incurred by Seller due to Buyer's acts or omissions. Buyer shall not return or repackage any Products without the prior written authorization from Seller, and any return shall be at the sole cost and expense of Buyer.

5. **Warranty.** The warranty for the Products is as follows: (i) Goods are warranted against defects in material or workmanship for a period of twelve (12) months from the date of delivery or 2,000 hours of use, whichever occurs first; (ii) Services shall be performed in accordance with generally accepted practices and using the degree of care and skill that is ordinarily exercised and customary in the field to which the Services pertain and are warranted for a period of six (6) months from the date of completion of the Services; and (iii) Software is only warranted to perform in accordance with applicable specifications provided by Seller to Buyer for ninety (90) days from the date of delivery or, when downloaded by a Buyer or end-user, from the date of the initial download. All prices are based upon the exclusive limited warranty stated above, and upon the following disclaimer: **EXEMPTION CLAUSE; DISCLAIMER OF WARRANTY, CONDITIONS, REPRESENTATIONS; THIS WARRANTY IS THE SOLE AND ENTIRE WARRANTY, CONDITION, AND REPRESENTATION, PERTAINING TO PRODUCTS. SELLER DISCLAIMS ALL OTHER WARRANTIES, CONDITIONS, AND REPRESENTATIONS, WHETHER STATUTORY, EXPRESS OR IMPLIED, INCLUDING BUT NOT LIMITED TO THOSE RELATING TO DESIGN, NONINFRINGEMENT, MERCHANTABILITY, AND FITNESS FOR A PARTICULAR PURPOSE. SELLER DOES NOT WARRANT THAT THE SOFTWARE IS ERROR-FREE OR FAULT-TOLERANT, OR THAT BUYER'S USE THEREOF WILL BE SECURE OR UNINTERRUPTED. UNLESS OTHERWISE AUTHORIZED IN WRITING BY SELLER, THE SOFTWARE SHALL NOT BE USED IN CONNECTION WITH HAZARDOUS OR HIGH RISK ACTIVITIES OR ENVIRONMENTS. EXCEPT AS EXPRESSLY STATED HEREIN, ALL PRODUCTS ARE PROVIDED "AS IS".**

6. **Claims; Commencement of Actions.** Buyer shall promptly inspect all Products upon receipt. No claims for shortages will be allowed unless reported to Seller within ten (10) days of delivery. Buyer shall notify Seller of any alleged breach of warranty within thirty (30) days after the date the non-conformance is or should have been discovered by Buyer. Any claim or action against Seller based upon breach of contract or any other theory, including tort, negligence, or otherwise must be commenced within twelve (12) months from the date of the alleged breach or other alleged event, without regard to the date of discovery.

7. **LIMITATION OF LIABILITY.** IN THE EVENT OF A BREACH OF WARRANTY, SELLER WILL, AT ITS OPTION, REPAIR OR REPLACE THE NON-CONFORMING PRODUCT, RE-PERFORM THE SERVICES, OR REFUND THE PURCHASE PRICE PAID WITHIN A REASONABLE PERIOD OF TIME. **IN NO EVENT IS SELLER LIABLE FOR ANY SPECIAL, INDIRECT, INCIDENTAL OR CONSEQUENTIAL DAMAGES INCLUDING ANY LOSS OF REVENUE OR PROFITS, WHETHER BASED IN CONTRACT, TORT OR OTHER LEGAL THEORY. IN NO EVENT SHALL SELLER'S LIABILITY UNDER ANY CLAIM MADE BY BUYER EXCEED THE PURCHASE PRICE PAID FOR THE PRODUCTS.**

8. **Confidential Information.** Buyer acknowledges and agrees that any technical, commercial, or other confidential information of Seller, including, without limitation, pricing, technical drawings or prints and/or part lists, which has been or will be disclosed, delivered or made available, whether directly or indirectly, to Buyer ("Confidential Information"), has been and will be received in confidence and will remain the property of Seller. Buyer further agrees that it will not use Seller's Confidential Information for any purpose other than for the benefit of Seller.

9. **Loss to Buyer's Property.** Any tools, patterns, materials, equipment or information furnished by Buyer or which are or become Buyer's property ("Buyer's Property"), will be considered obsolete and may be destroyed by Seller after two (2) consecutive years have elapsed without Buyer ordering the Products manufactured using Buyer's Property. Furthermore, Seller shall not be responsible for any loss or damage to Buyer's Property while it is in Seller's possession or control.

10. **Special Tooling.** "Special Tooling" includes but is not limited to tools, jigs, fixtures and associated manufacturing equipment acquired or necessary to manufacture Goods. Seller may impose a tooling charge for any Special Tooling. Such Special Tooling shall be and remain Seller's property notwithstanding payment of any charges by Buyer. In no event will Buyer acquire any interest in the Special Tooling, even if such Special Tooling has been specially converted or adapted for manufacture of Goods for Buyer and notwithstanding any charges paid by Buyer. Unless otherwise agreed, Seller has the right to alter, discard or otherwise dispose of any Special Tooling or other property owned by Seller in its sole discretion at any time.

11. **Security Interest.** To secure payment of all sums due from Buyer, Seller retains a security interest in all Products delivered to Buyer and, Buyer's acceptance of these Terms is deemed to be a Security Agreement under the Uniform Commercial Code. Buyer authorizes Seller as its attorney to execute and file on Buyer's behalf all documents Seller deems necessary to perfect Seller's security interest.

12. **User Responsibility.** Buyer, through its own analysis and testing, is solely responsible for making the final selection of the Products and assuring that all performance, endurance, maintenance, safety and warning requirements of the application of the Products are met. Buyer must analyze all aspects of the application and follow applicable industry standards, specifications, and any technical information provided with the Quote or the Products, such as Seller's instructions, guides and specifications. If Seller provides options of or for Products based upon data or specifications provided by Buyer, Buyer is responsible for determining that such data and specifications are suitable and sufficient for all applications and reasonably foreseeable uses of the Products. In the event Buyer is not the end-user of the Products, Buyer will ensure such end-user complies with this paragraph.

13. **Use of Products, Indemnity by Buyer.** Buyer shall comply with all instructions, guides and specifications provided by Seller with the Quote or the Products. **Unauthorized Uses.** If Buyer uses or resells the Products in any way prohibited by Seller's instructions, guides or specifications, or Buyer otherwise fails to comply with Seller's instructions, guides and specifications, Buyer acknowledges that any such use, resale, or non-compliance is at Buyer's sole risk. Further, Buyer shall indemnify, defend, and hold Seller harmless from any losses, claims, liabilities, damages, lawsuits, judgments and costs (including attorney fees and defense costs), whether for personal injury, property damage, intellectual property infringement or any other claim, arising out of or in connection with: (a) improper selection, design, specification, application, or any misuse of Products; (b) any act or omission, negligent or otherwise, of Buyer; (c) Seller's use of patterns, tools, equipment, plans, drawings, designs, specifications or other information or things furnished by Buyer; (d) damage to the Products from an external cause, repair or attempted repair by anyone other than Seller, failure to follow instructions, guides and specifications provided by Seller, use with goods not provided by Seller, or opening, modifying, deconstructing, tampering with or repackaging the Products; or (e) Buyer's failure to comply with these Terms. Seller shall not indemnify Buyer under any circumstance except as otherwise provided in these Terms.

14. **Cancellations and Changes.** Buyer may not cancel or modify, including but not limited to movement of delivery dates for the Products, any order for any reason except with Seller's written consent and upon terms that will indemnify, defend and hold Seller harmless against all direct, incidental and consequential loss or damage and any additional expense. Seller, at any time, may change features, specifications, designs and availability of Products.

15. **Limitation on Assignment.** Buyer may not assign its rights or obligations without the prior written consent of Seller.

16. **Force Majeure.** Seller is not liable for delay or failure to perform any of its obligations by reason of events or circumstances beyond its reasonable control. Such circumstances include without limitation: accidents, labor disputes or stoppages, government acts or orders, acts of nature, pandemics, epidemics, other widespread illness, or public health emergency, delays or failures in delivery from carriers or suppliers, shortages of materials, war (whether declared or not) or the serious threat of same, riots, rebellions, acts of terrorism, fire or any reason whether similar to the foregoing or otherwise. Seller will resume performance as soon as practicable after the event of force majeure has been removed. All delivery dates affected by force majeure shall be tolled for the duration of such force majeure and rescheduled for mutually agreed dates as soon as practicable after the force majeure condition ceases to exist. Force majeure shall not include financial distress, insolvency, bankruptcy, or other similar conditions affecting one of the parties, affiliates and/or sub-contractors.

17. **Waiver and Severability.** Failure to enforce any provision of these Terms will not invalidate that provision; nor will any such failure prejudice either party's right to enforce that provision in the future. Invalidation of any provision of these Terms shall not invalidate any other provision herein and, the remaining provisions will remain in full force and effect.

18. **Termination.** Seller may terminate any agreement governed by or arising from these Terms for any reason and at any time by giving Buyer thirty (30) days prior written notice. Seller may immediately terminate, in writing, if Buyer: (a) breaches any provision of these Terms, (b) becomes or is deemed insolvent, (c) appoints or has appointed a trustee, receiver or custodian for all or any part of Buyer's property, (d) files a petition for relief in bankruptcy on its own behalf, or one is filed against Buyer by a third party, (e) makes an assignment for the benefit of creditors; or (f) dissolves its business or liquidates all or a majority of its assets.

19. **Ownership of Software.** Seller retains ownership of all Software supplied to Buyer hereunder. In no event shall Buyer obtain any greater right in and to the Software than a right in the nature of a license limited to the use thereof and subject to compliance with any other terms provided with the Software.

20. **Indemnity for Infringement of Intellectual Property Rights.** Seller is not liable for infringement of any patents, trademarks, copyrights, trade dress, trade secrets or similar rights ("Intellectual Property Rights") except as provided in this Section. Seller will defend at its expense and will pay the cost of any settlement or damages awarded in an action brought against Buyer based on a third party claim that one or more of the Products sold hereunder infringes the Intellectual Property Rights of a third party in the country of delivery of the Products by Seller to Buyer. Seller's obligation to defend and indemnify Buyer is contingent on Buyer notifying Seller within ten (10) days after Buyer becomes aware of any such claim, and Seller having sole control over the defense of the claim including all negotiations for settlement or compromise. If one or more Products sold hereunder is subject to such a claim, Seller may, at its sole expense and option, procure for Buyer the right to continue using the Products, replace or modify the Products so as to render them non-infringing, or offer to accept return of the Products and refund the purchase price less

a reasonable allowance for depreciation. Seller has no obligation or liability for any claim of infringement: (i) arising from information provided by Buyer; or (ii) directed to any Products provided hereunder for which the designs are specified in whole or part by Buyer; or (iii) resulting from the modification, combination or use in a system of any Products provided hereunder. The foregoing provisions of this Section constitute Seller's sole and exclusive liability and Buyer's sole and exclusive remedy for claims of infringement of Intellectual Property Rights.

21. **Governing Law.** These Terms and the sale and delivery of all Products are deemed to have taken place in, and shall be governed and construed in accordance with, the laws of the State of Ohio, as applicable to contracts executed and wholly performed therein and without regard to conflicts of laws principles. Buyer irrevocably agrees and consents to the exclusive jurisdiction and venue of the courts of Cuyahoga County, Ohio with respect to any dispute, controversy or claim arising out of or relating to the sale and delivery of the Products.

22. **Entire Agreement.** These Terms, along with the terms set forth in the main body of any Quote, forms the entire agreement between the Buyer and Seller and constitutes the final, complete and exclusive expression of the terms of sale and purchase. In the event of a conflict between any term set forth in the main body of a Quote and these Terms, the terms set forth in the main body of the Quote shall prevail. All prior or contemporaneous written or oral agreements or negotiations with respect to the subject matter shall have no effect. These Terms may not be modified unless in writing and signed by an authorized representative of Seller.

23. **Compliance with Laws.** Buyer agrees to comply with all applicable laws, regulations, and industry and professional standards, including those of the United States of America, and the country or countries in which Buyer may operate, including without limitation the U.S. Foreign Corrupt Practices Act ("FCPA"), the U.S. Anti-Kickback Act ("Anti-Kickback Act"), U.S. and E.U. export control and sanctions laws ("Export Laws"), the U.S. Food Drug and Cosmetic Act ("FDCA"), and the rules and regulations promulgated by the U.S. Food and Drug Administration ("FDA"), each as currently amended. Buyer agrees to indemnify, defend, and hold harmless Seller from the consequences of any violation of such laws, regulations and standards by Buyer, its employees or agents. Buyer acknowledges that it is familiar with all applicable provisions of the FCPA, the Anti-Kickback Act, Export Laws, the FDCA and the FDA and certifies that Buyer will adhere to the requirements thereof and not take any action that would make Seller violate such requirements. Buyer represents and agrees that Buyer will not make any payment or give anything of value, directly or indirectly, to any governmental official, foreign political party or official thereof, candidate for foreign political office, or commercial entity or person, for any improper purpose, including the purpose of influencing such person to purchase Products or otherwise benefit the business of Seller. Buyer further represents and agrees that it will not receive, use, service, transfer or ship any Products from Seller in a manner or for a purpose that violates Export Laws or would cause Seller to be in violation of Export Laws. Buyer agrees to promptly and reliably provide Seller all requested information or documents, including end-user statements and other written assurances, concerning Buyer's ongoing compliance with Export Laws.

Parker's Motion & Control Product Groups

At Parker, we're guided by a relentless drive to help our customers become more productive and achieve higher levels of profitability by engineering the best systems for their requirements. It means looking at customer applications from many angles to find new ways to create value. Whatever the motion and control technology need, Parker has the experience, breadth of product and global reach to consistently deliver. No company knows more about motion and control technology than Parker. For further info call 1 800 G-Parker (1 800 272 7537).



Aerospace

Key Markets

Aftermarket services
Commercial transports
Engines
General & business aviation
Helicopters
Launch vehicles
Military aircraft
Missiles
Power generation
Regional transports
Unmanned aerial vehicles

Key Products

Control systems & actuation products
Engine systems & components
Fluid conveyance systems & components
Fluid metering, delivery & atomization devices
Fuel systems & components
Fuel tank inerting systems
Hydraulic systems & components
Thermal management
Wheels & brakes



Automation

Key Markets

Alternative energy
Conveyor & material handling
Factory automation
Food & beverage
Life sciences & medical
Machine tools
Packaging machinery
Paper machinery
Plastics machinery
Primary metals
Safety & security
Semiconductor & electronics
Transportation & automotive

Key Products

AC/DC drives & systems
Air preparation
Electric actuators, gantry robots & slides
Human machine interfaces
Inverters
Manifolds
Miniature fluidics
Pneumatic actuators & grippers
Pneumatic valves & controls
Rotary actuators
Stepper motors, servo motors, drives & controls
Structural extrusions
Vacuum generators, cups & sensors



Climate & Industrial Controls

Key Markets

Agriculture
Air conditioning
Construction Machinery
Food & beverage
Industrial machinery
Life sciences
Oil & gas
Precision cooling
Process
Refrigeration
Transportation

Key Products

Accumulators
Advanced actuators
CO₂ controls
Electronic controllers
Filter driers
Hand shut-off valves
Heat exchangers
Hose & fittings
Pressure regulating valves
Refrigerant distributors
Safety relief valves
Smart pumps
Solenoid valves
Thermostatic expansion valves



Filtration

Key Markets

Aerospace
Food & beverage
Industrial plant & equipment
Life sciences
Marine
Mobile equipment
Oil & gas
Power generation & renewable energy
Process
Transportation
Water Purification

Key Products

Analytical gas generators
Compressed air filters & dryers
Engine air, coolant, fuel & oil filtration systems
Fluid condition monitoring systems
Hydraulic & lubrication filters
Hydrogen, nitrogen & zero air generators
Instrumentation filters
Membrane & fiber filters
Microfiltration
Sterile air filtration
Water desalination & purification filters & systems



Fluid Connectors

Key Markets

Aerial lift
Agriculture
Bulk chemical handling
Construction machinery
Food & beverage
Fuel & gas delivery
Industrial machinery
Life sciences
Marine
Mining
Mobile
Oil & gas
Renewable energy
Transportation

Key Products

Check valves
Connectors for low pressure fluid conveyance
Deep sea umbilicals
Diagnostic equipment
Hose couplings
Industrial hose
Mooring systems & power cables
PTFE hose & tubing
Quick couplings
Rubber & thermoplastic hose
Tube fittings & adapters
Tubing & plastic fittings



Hydraulics

Key Markets

Aerial lift
Agriculture
Alternative energy
Construction machinery
Forestry
Industrial machinery
Machine tools
Marine
Material handling
Mining
Oil & gas
Power generation
Refuse vehicles
Renewable energy
Truck hydraulics
Turf equipment

Key Products

Accumulators
Cartridge valves
Electrohydraulic actuators
Human machine interfaces
Hybrid drives
Hydraulic cylinders
Hydraulic motors & pumps
Hydraulic systems
Hydraulic valves & controls
Hydrostatic steering
Integrated hydraulic circuits
Power take-offs
Power units
Rotary actuators
Sensors



Instrumentation

Key Markets

Alternative fuels
Biopharmaceuticals
Chemical & refining
Food & beverage
Marine & shipbuilding
Medical & dental
Microelectronics
Nuclear Power
Offshore oil exploration
Oil & gas
Pharmaceuticals
Power generation
Pulp & paper
Steel
Water/wastewater

Key Products

Analytical Instruments
Analytical sample conditioning products & systems
Chemical injection fittings & valves
Fluoropolymer chemical delivery fittings, valves & pumps
High purity gas delivery fittings, valves, regulators & digital flow controllers
Industrial mass flow meters/controllers
Permanent no-weld tube fittings
Precision industrial regulators & flow controllers
Process control double block & bleeds
Process control fittings, valves, regulators & manifold valves



Seal

Key Markets

Aerospace
Chemical processing
Consumer
Fluid power
General industrial
Information technology
Life sciences
Microelectronics
Military
Oil & gas
Power generation
Renewable energy
Telecommunications
Transportation

Key Products

Dynamic seals
Elastomeric o-rings
Electro-medical instrument design & assembly
EMI shielding
Extruded & precision-cut, fabricated elastomeric seals
High temperature metal seals
Homogeneous & inserted elastomeric shapes
Medical device fabrication & assembly
Metal & plastic retained composite seals
Shielded optical windows
Silicone tubing & extrusions
Thermal management
Vibration dampening



GOODYEAR
RUBBER PRODUCTS, INC.

+1.727.342.5087

También puede enviarnos un correo electrónico a ventas@goodyearrubberproducts.com

Parker Fluid Connectors Group

North American Divisions & Distribution Service Centers

Your complete source for quality tube fittings, hose & hose fittings, brass & composite fittings, quick-disconnect couplings, valves and assembly tools, locally available from a worldwide network of authorized distributors.

Fittings:

Available in inch and metric sizes covering SAE, BSP, DIN, GAZ, JIS and ISO thread configurations, manufactured from steel, stainless steel, brass, aluminum, nylon and thermoplastic.

Hose, Tubing and Bundles:

Available in a wide variety of sizes and materials including rubber, wire-reinforced, thermoplastic, hybrid and custom compounds.

Worldwide Availability:

Parker operates Fluid Connectors manufacturing locations and sales offices throughout North America, South America, Europe and Asia-Pacific.

For information, call toll free...

1-800-C-PARKER
(1-800-272-7537)

North American Divisions

Fluid System Connectors Division

Otsego, MI
phone 269 692 6555
fax 269 694 4614

Engineering Support:

FSC.Apps@support.parker.com

Customer Support:

FSC.Support@support.parker.com

Quote Support:

FSC.Quotes@support.parker.com

Hose Products Division

Wickliffe, OH
phone 440 943 5700
fax 440 943 3129

Parflex Division

Ravenna, OH
phone 330 296 2871
fax 330 296 8433

Quick Coupling Division

Minneapolis, MN
phone 763 544 7781
fax 763 544 3418

Tube Fittings Division

Columbus, OH
phone 614 279 7070
fax 614 279 7685

Distribution Service Centers

Buena Park, CA

phone 714 522 8840
fax 714 994 1183

Conyers, GA

phone 770 929 0330
fax 770 929 0230

Louisville, KY

phone 502 937 1322
fax 502 937 4180

Portland, OR

phone 503 283 1020
fax 503 283 2201

Toledo, OH

phone 419 878 7000
fax 419 878 7001
fax 419 878 7420
(FCG Kit Operations)

Canada

Milton, ONT

phone 905 693 3000
fax 905 876 1958

Mexico

Toluca, MEX

phone (52) 722 2754 200
fax (52) 722 2722 168

Parker Hannifin Corporation
Fluid System Connectors Division
300 Parker Drive
Otsego, MI 49078
Phone: 269 692 6555
Fax: 269 694 4614

